

MAT=9867 ACE FILE PRODUCED AT NEA WITH NDEC
Principal cross sections

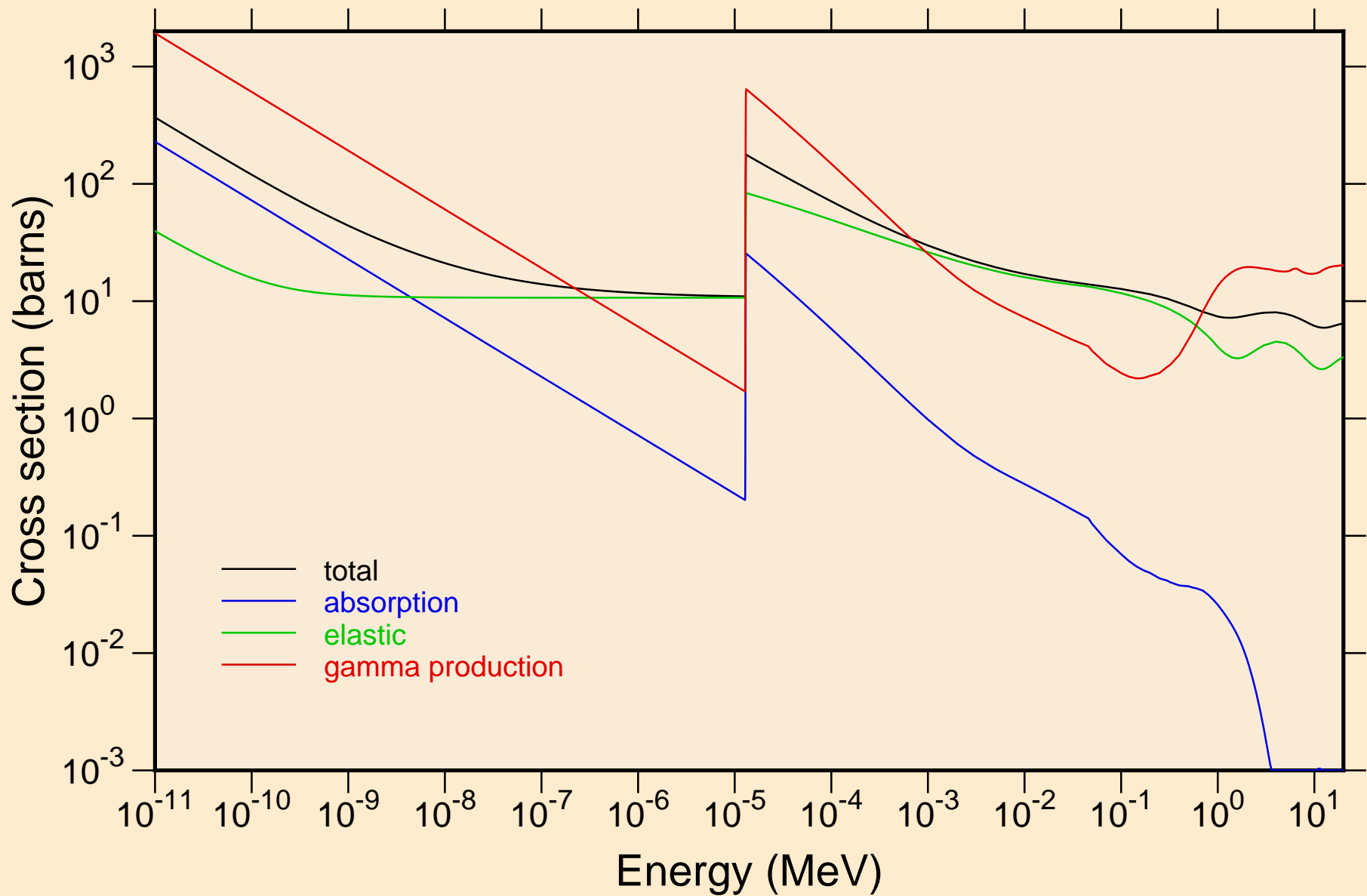

MAT=9867 ACE FILE PRODUCED AT NEA WITH NDEC
Heating

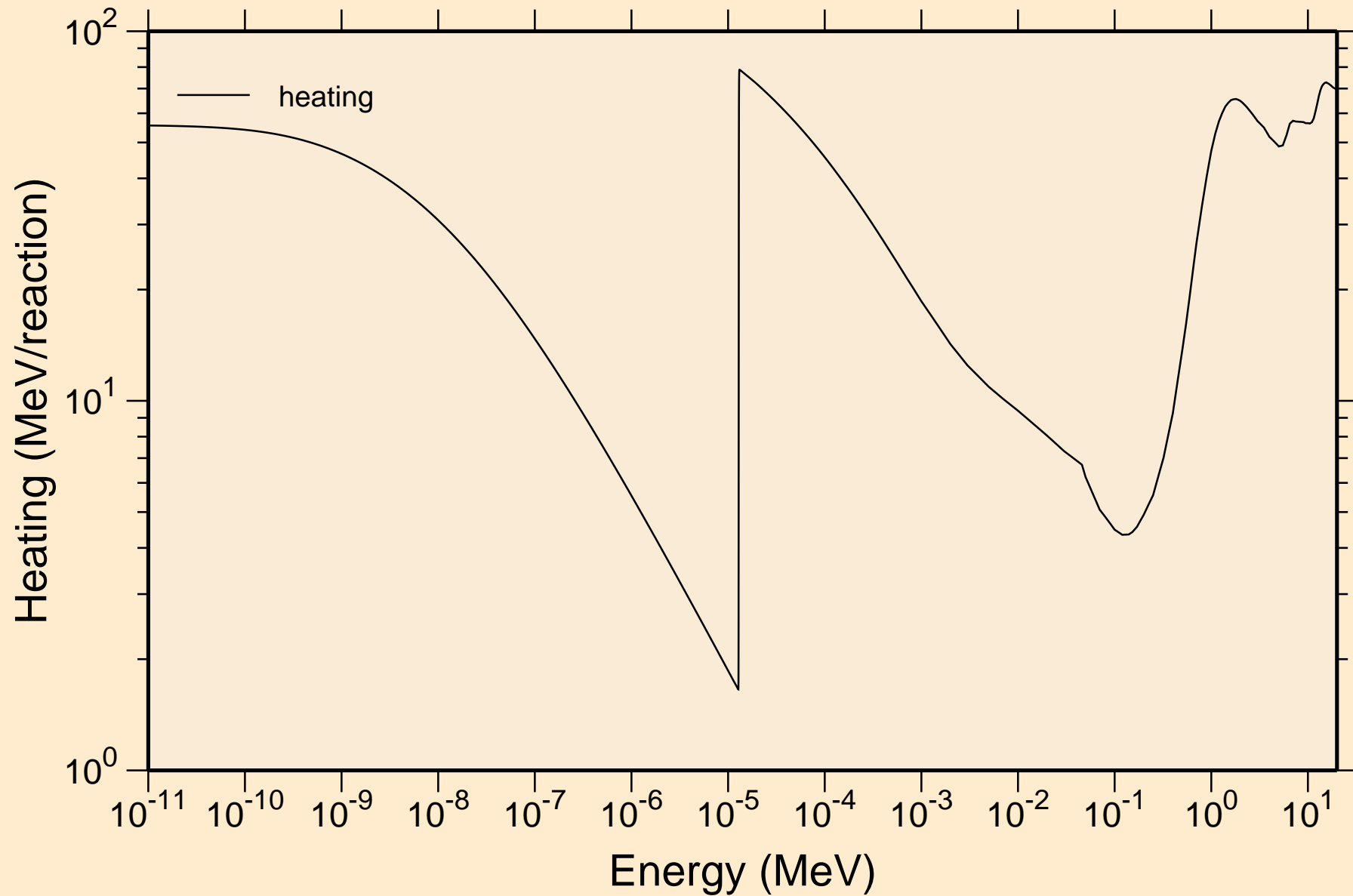

MAT=9867 ACE FILE PRODUCED AT NEA WITH NDEC
Damage

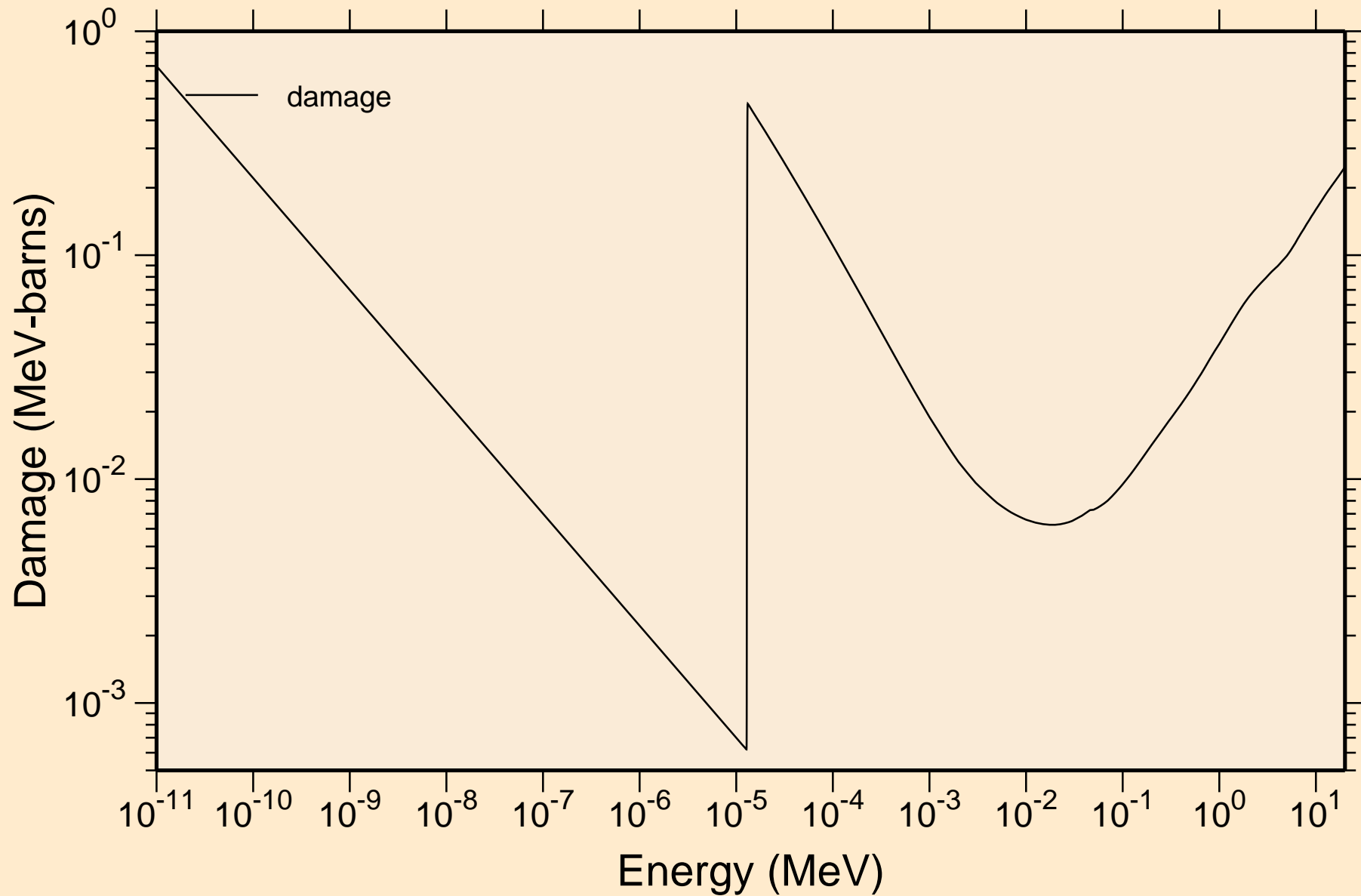

MAT=9867 ACE FILE PRODUCED AT NEA WITH NDEC
Non-threshold reactions

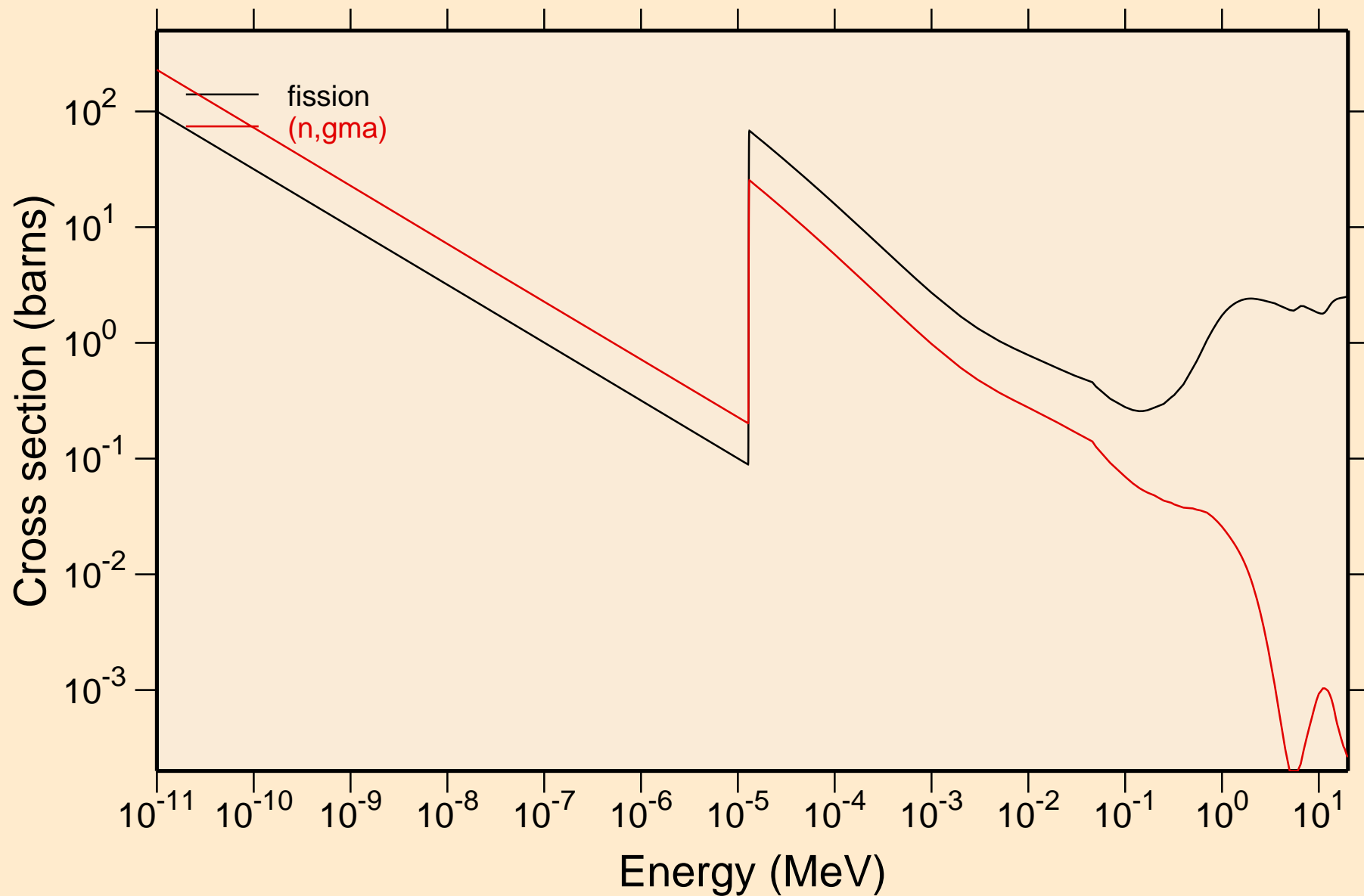

MAT=9867 ACE FILE PRODUCED AT NEA WITH NDEC

Principal cross sections

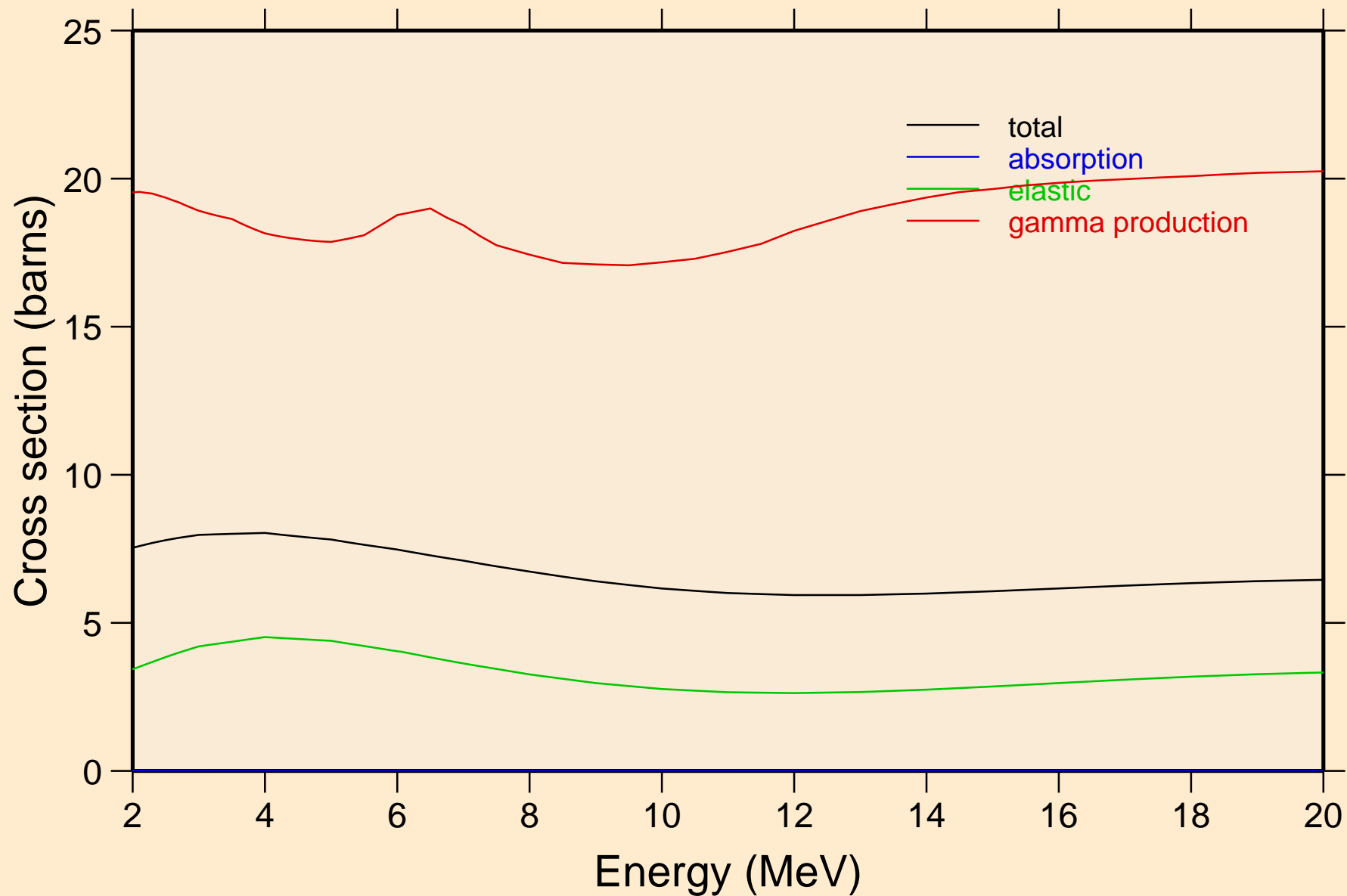

MAT=9867 ACE FILE PRODUCED AT NEA WITH NDEC
Heating

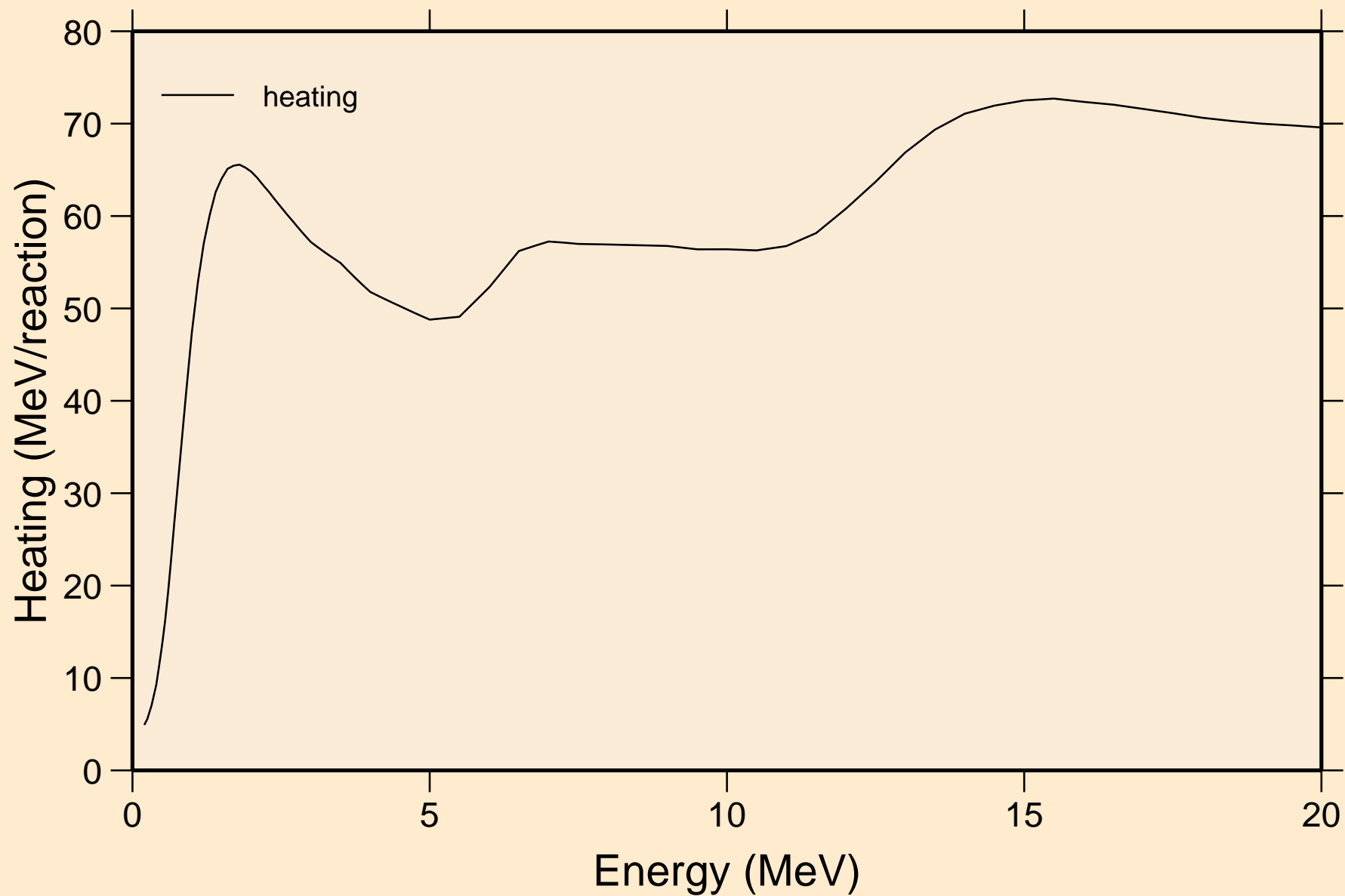

MAT=9867 ACE FILE PRODUCED AT NEA WITH NDEC
Damage

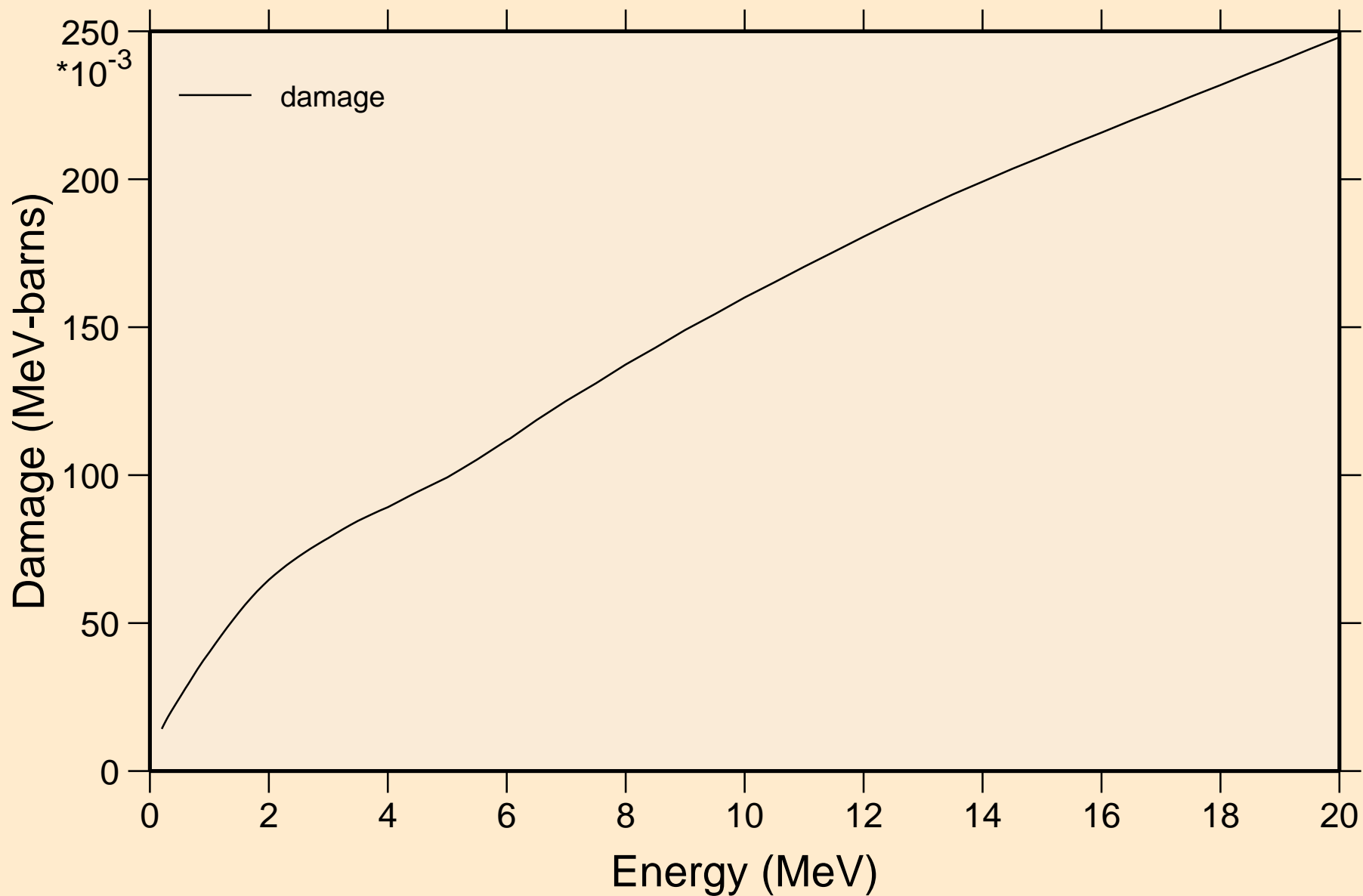

MAT=9867 ACE FILE PRODUCED AT NEA WITH NDEC
Non-threshold reactions

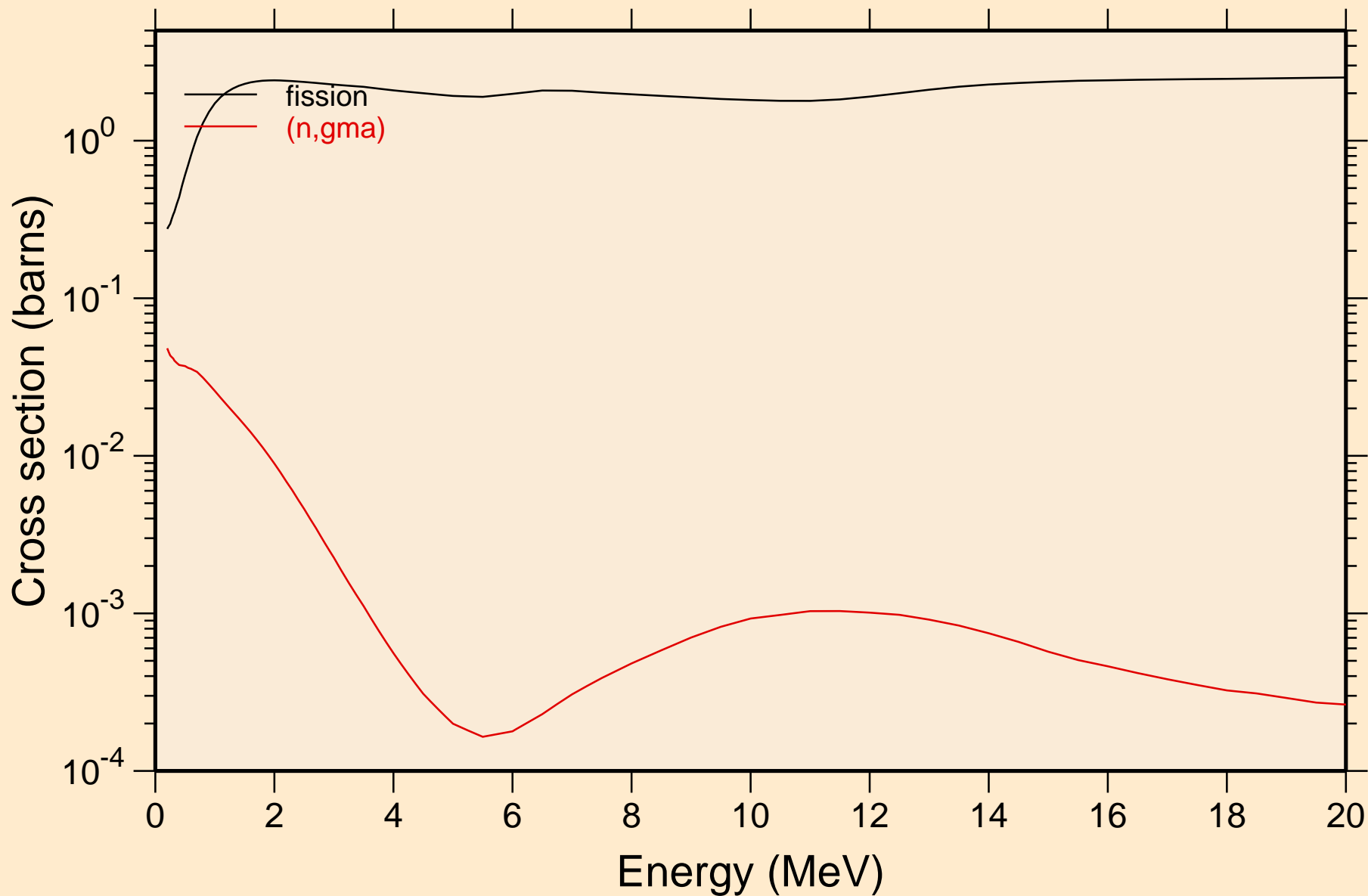

MAT=9867 ACE FILE PRODUCED AT NEA WITH NDEC
Inelastic levels

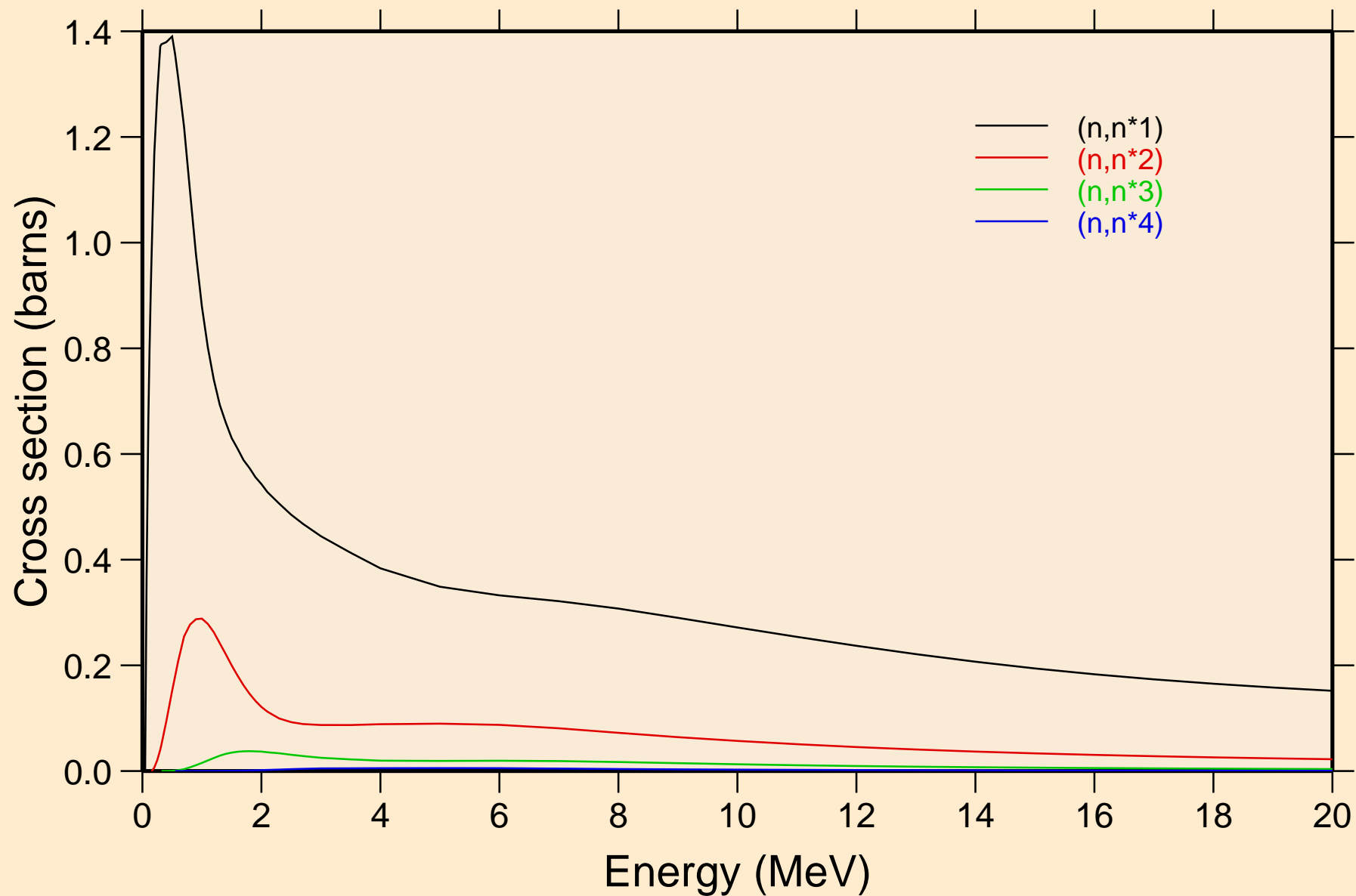

MAT=9867 ACE FILE PRODUCED AT NEA WITH NDEC
Threshold reactions

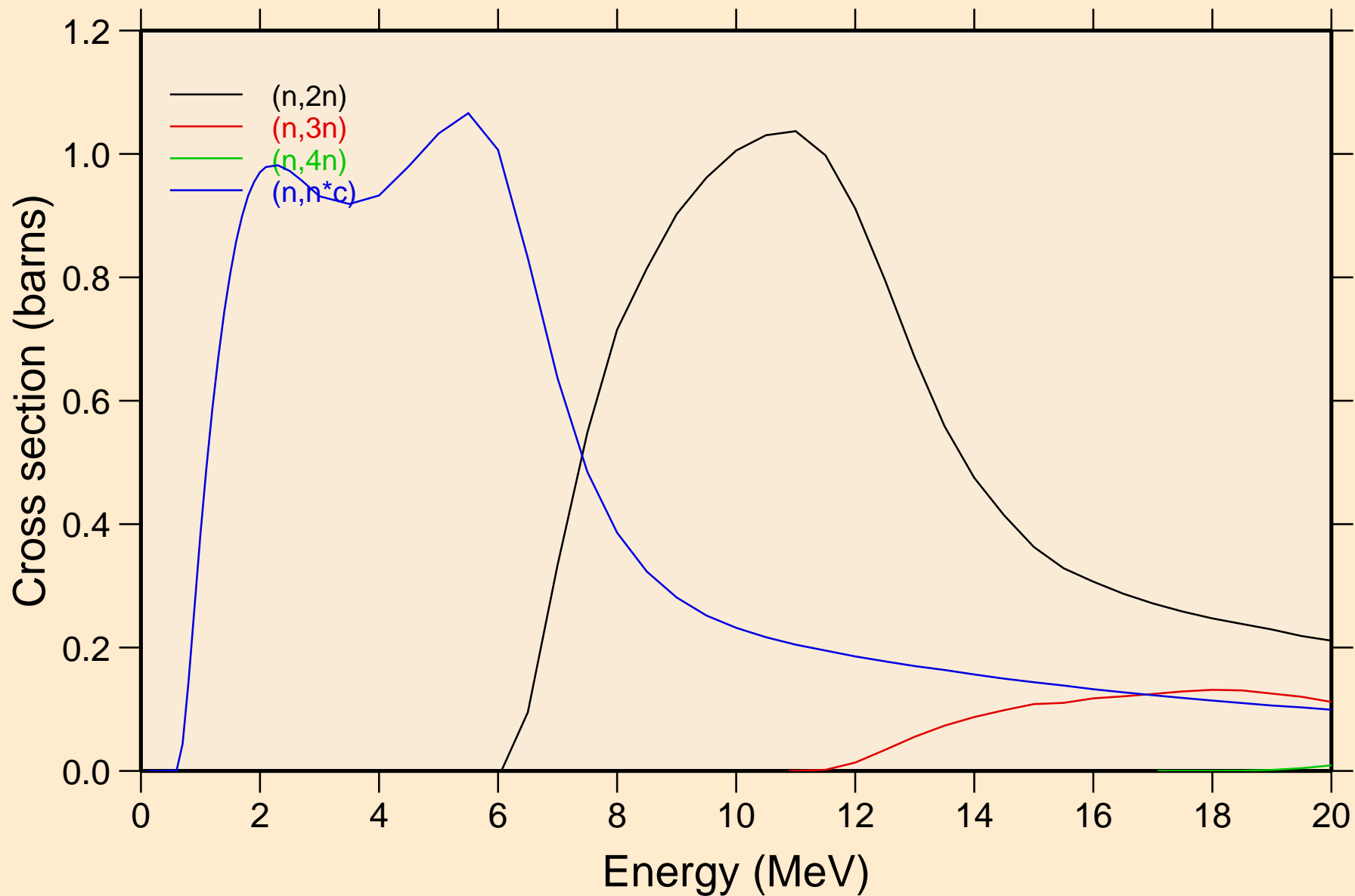

MAT=9867 ACE FILE PRODUCED AT NEA WITH NDEC
angular distribution for elastic

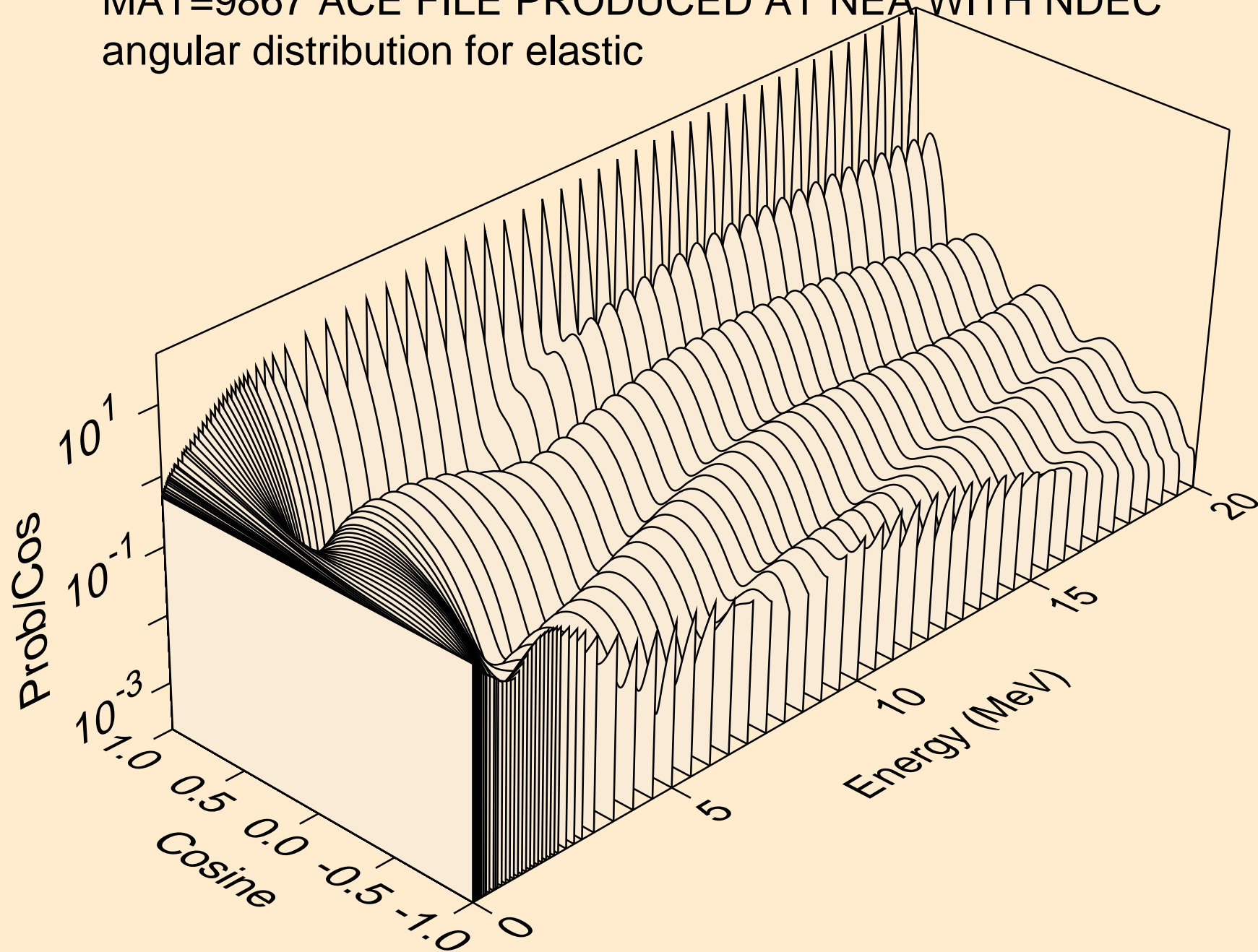

MAT=9867 ACE FILE PRODUCED AT NEA WITH NDEC
angular distribution for (n,n*1)

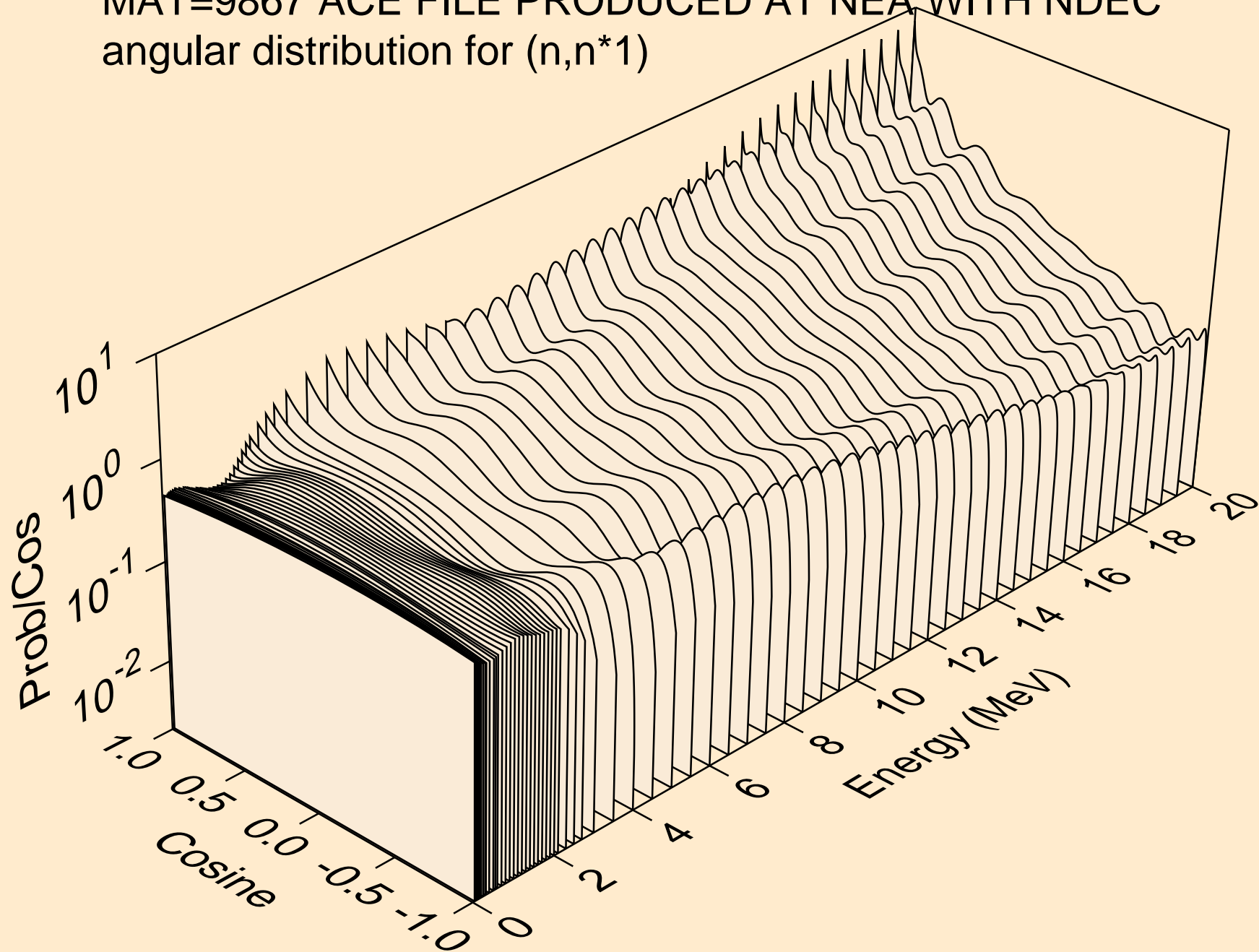

MAT=9867 ACE FILE PRODUCED AT NEA WITH NDEC
angular distribution for (n,n*2)

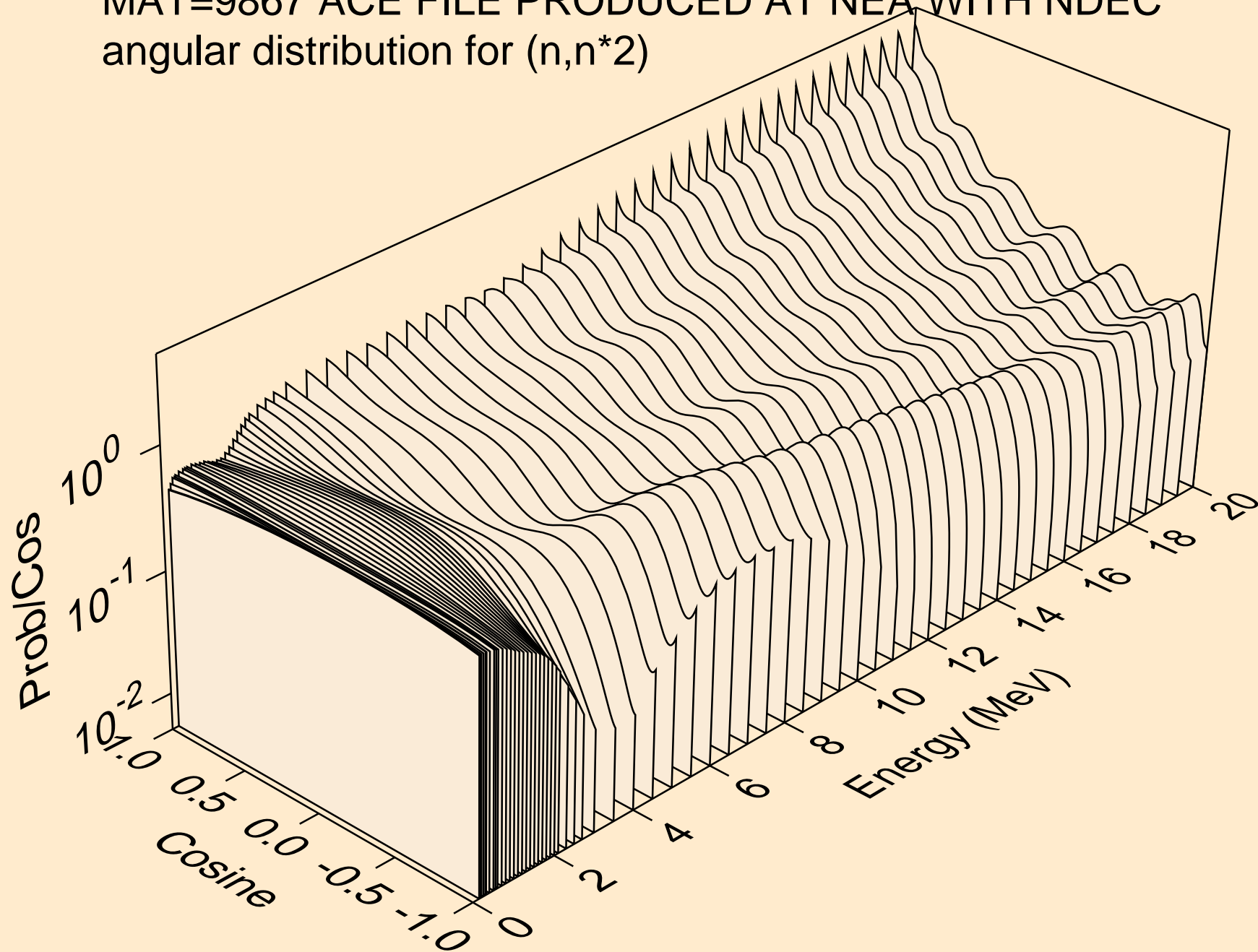

MAT=9867 ACE FILE PRODUCED AT NEA WITH NDEC
angular distribution for (n,n*3)

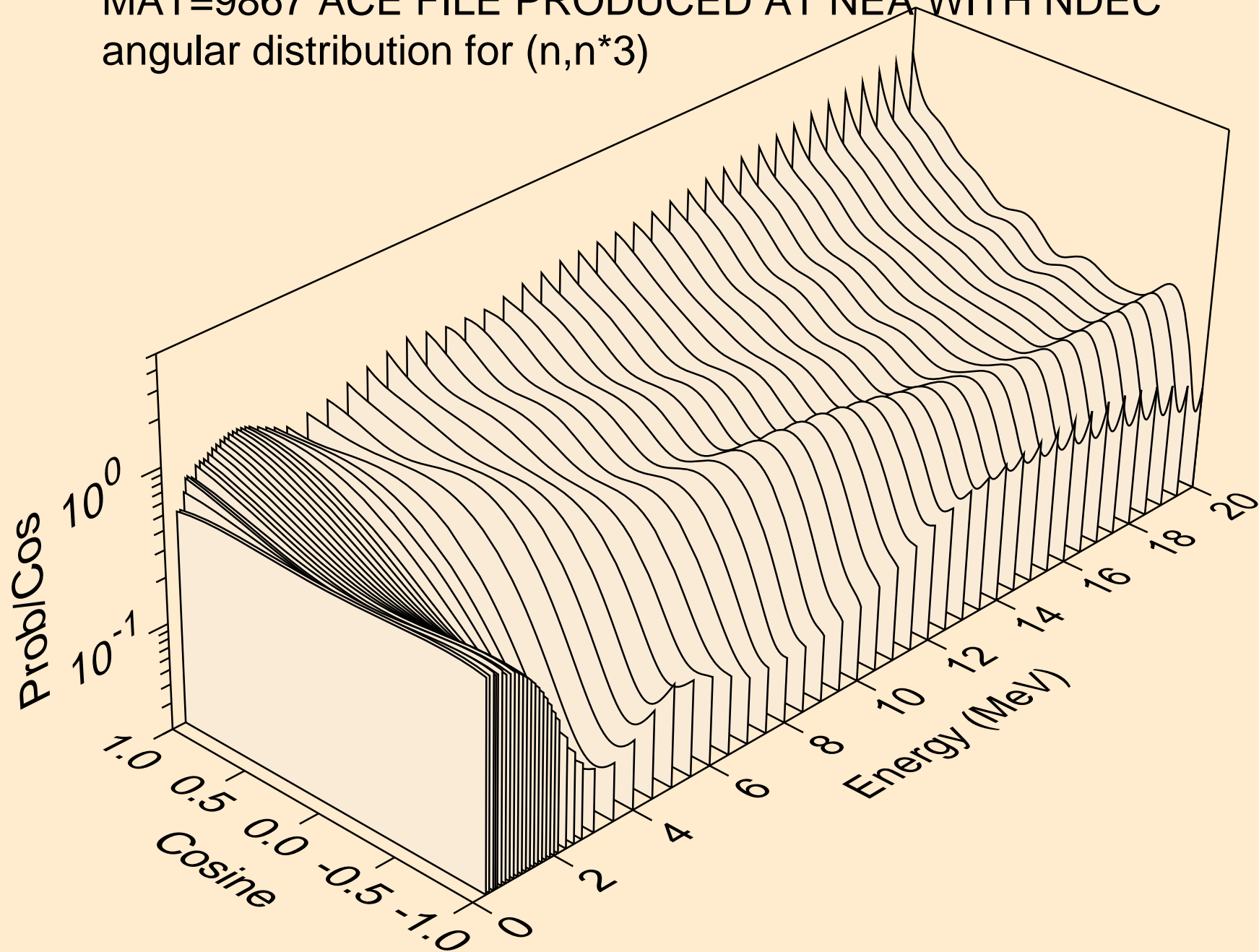

MAT=9867 ACE FILE PRODUCED AT NEA WITH NDEC
angular distribution for (n,n*4)

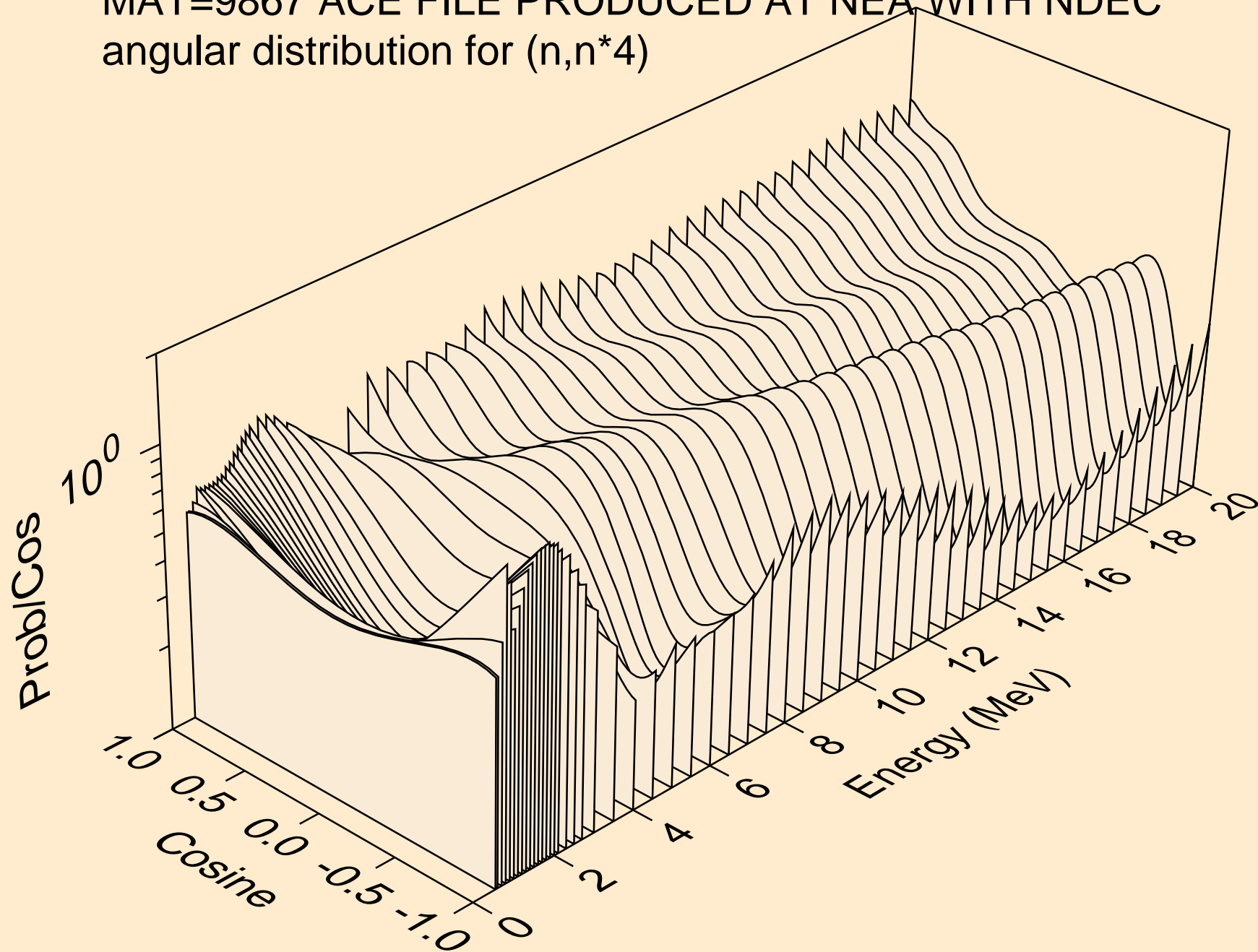

MAT=9867 ACE FILE PRODUCED AT NEA WITH NDEC

Total fission nubar

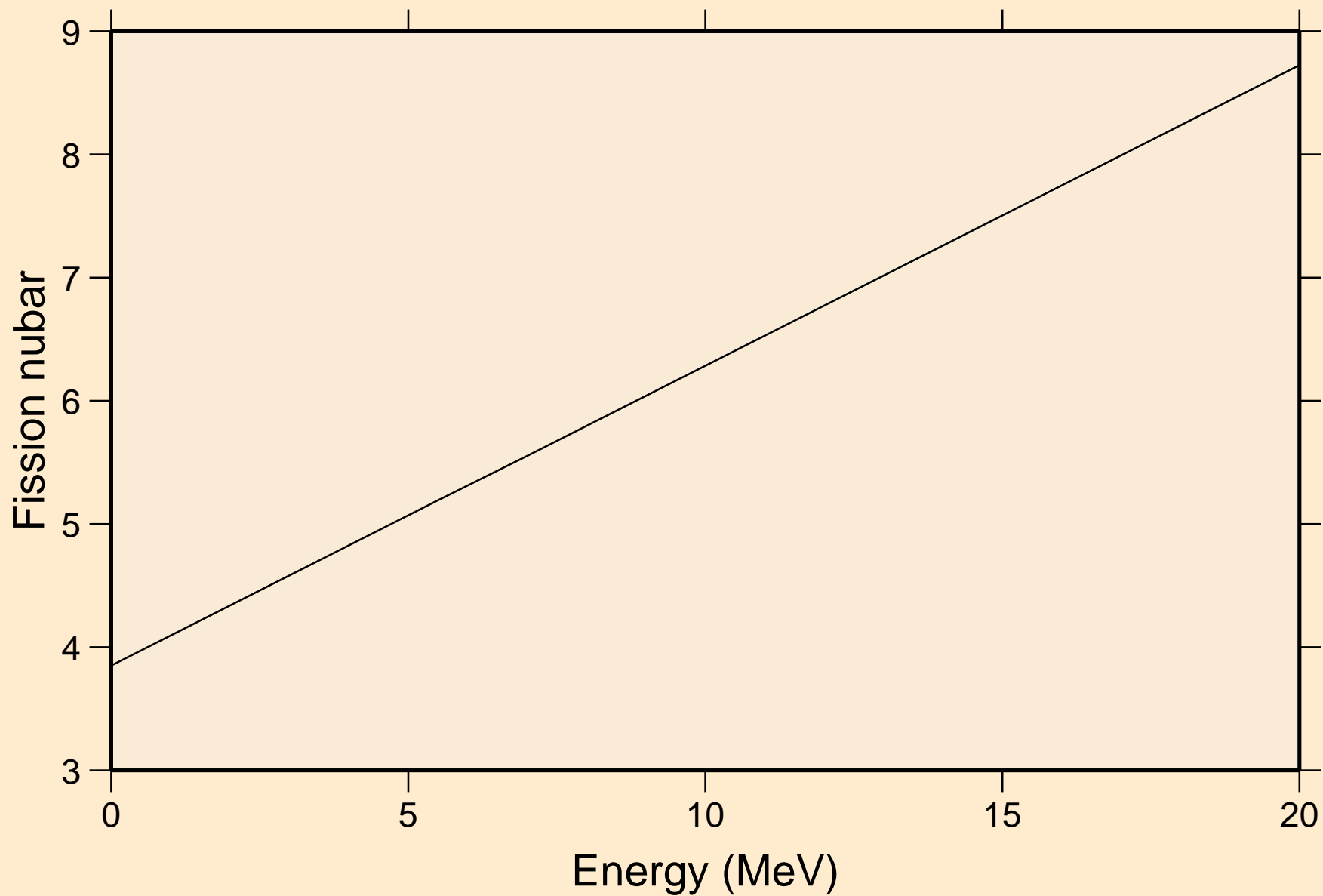

MAT=9867 ACE FILE PRODUCED AT NEA WITH NDEC
Neutron emission for (n,2n)

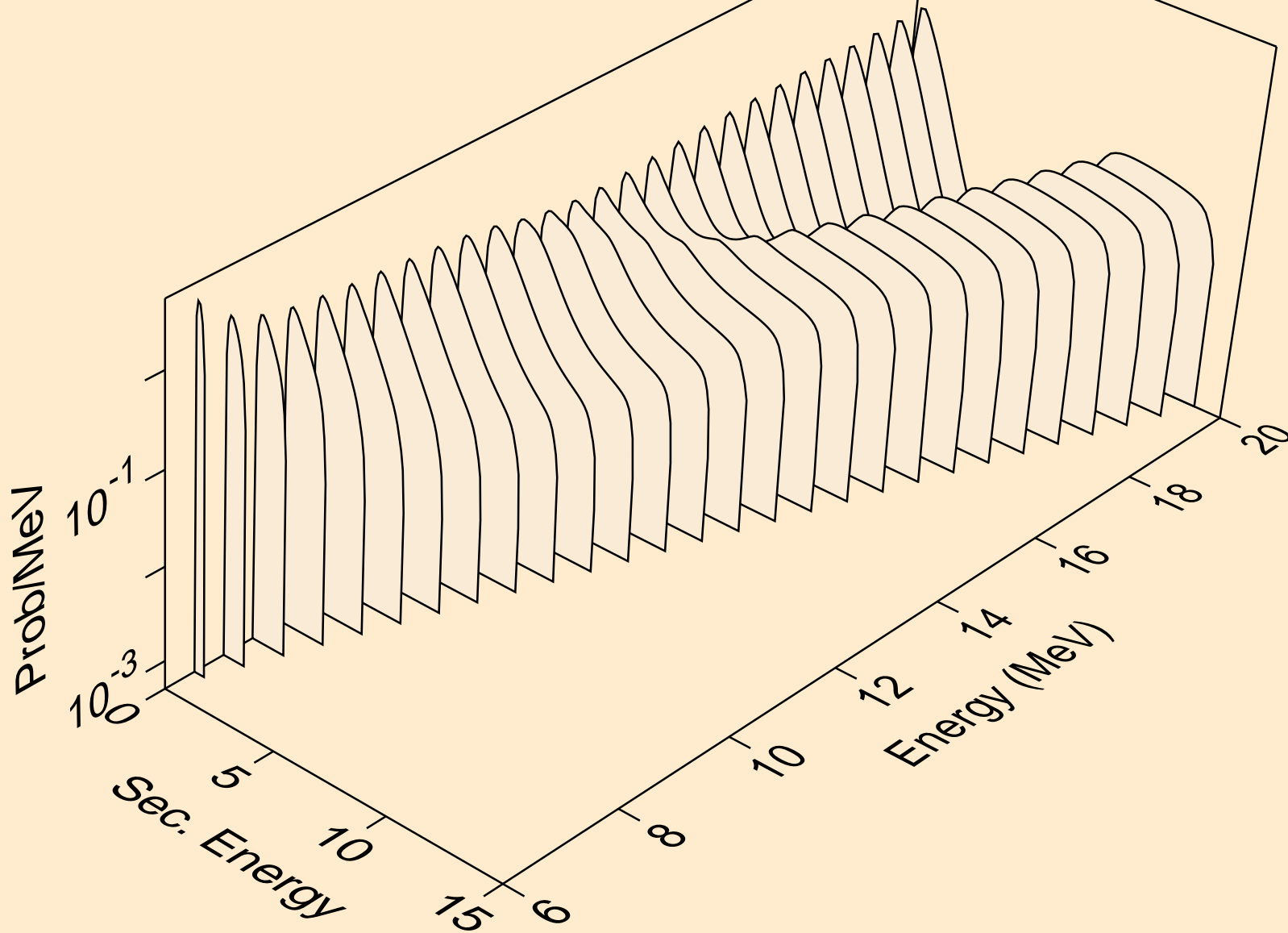

MAT=9867 ACE FILE PRODUCED AT NEA WITH NDEC
Neutron emission for (n,3n)

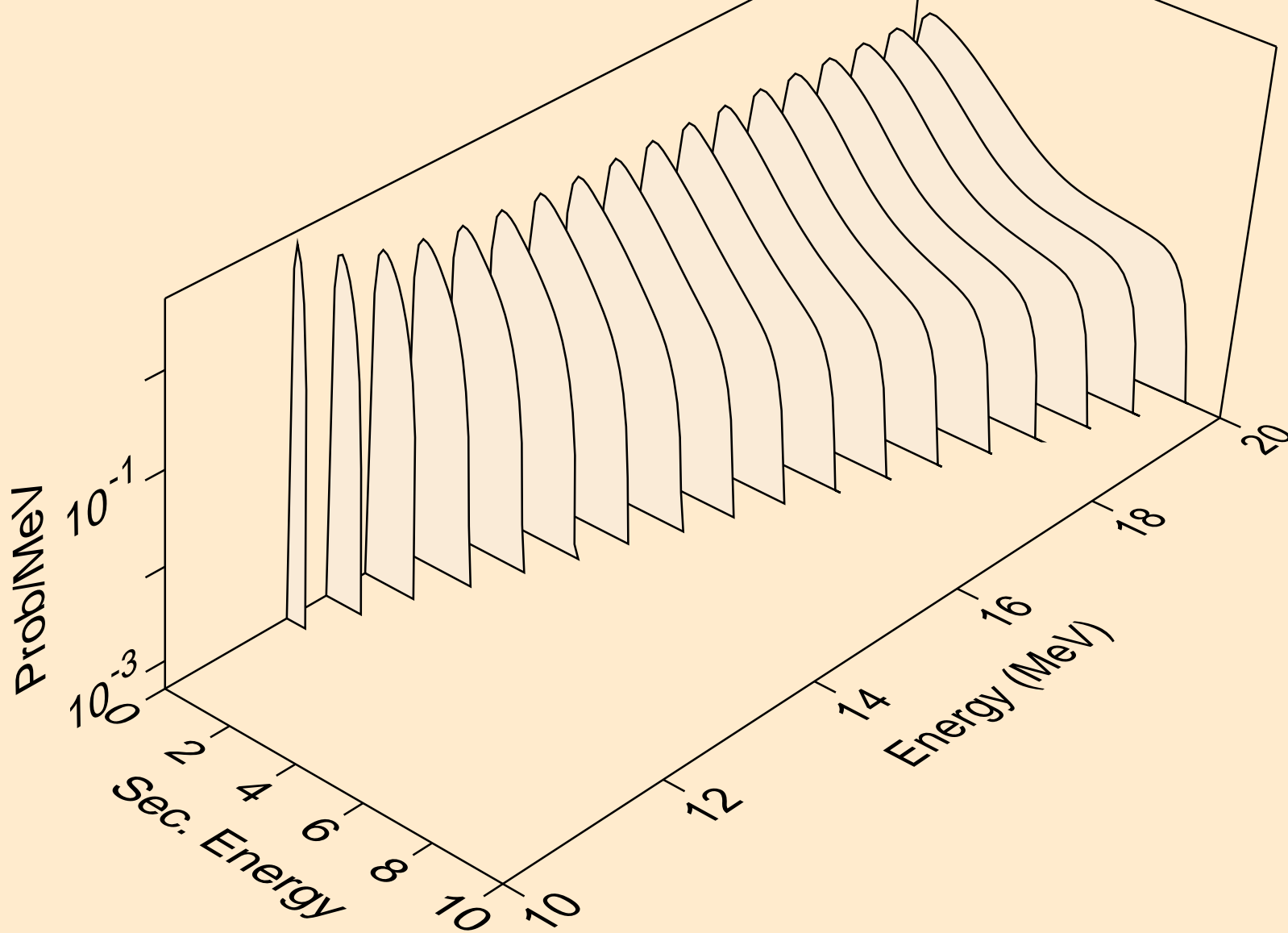

MAT=9867 ACE FILE PRODUCED AT NEA WITH NDEC
Neutron emission for fission

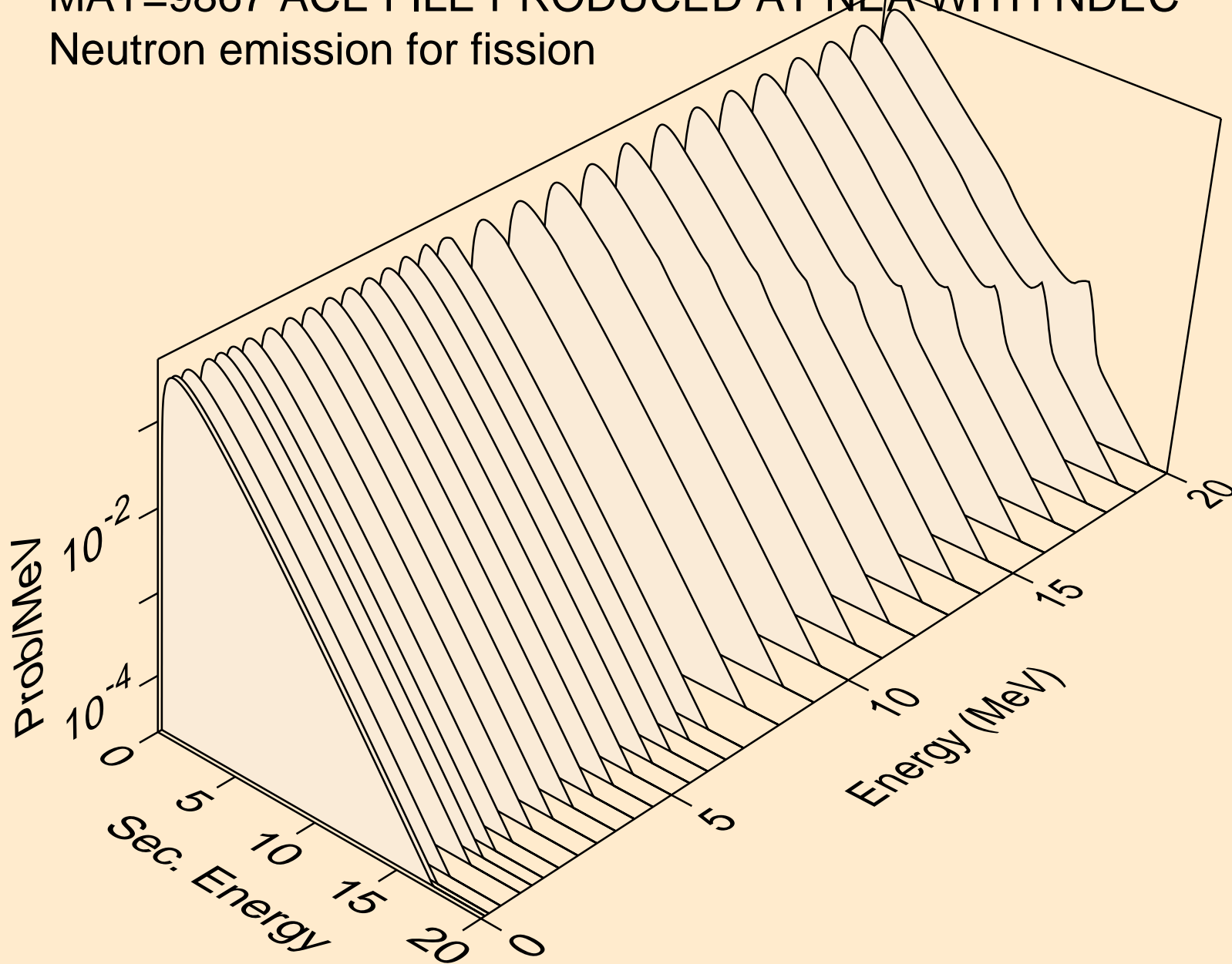

MAT=9867 ACE FILE PRODUCED AT NEA WITH NDEC
Neutron emission for (n,4n)

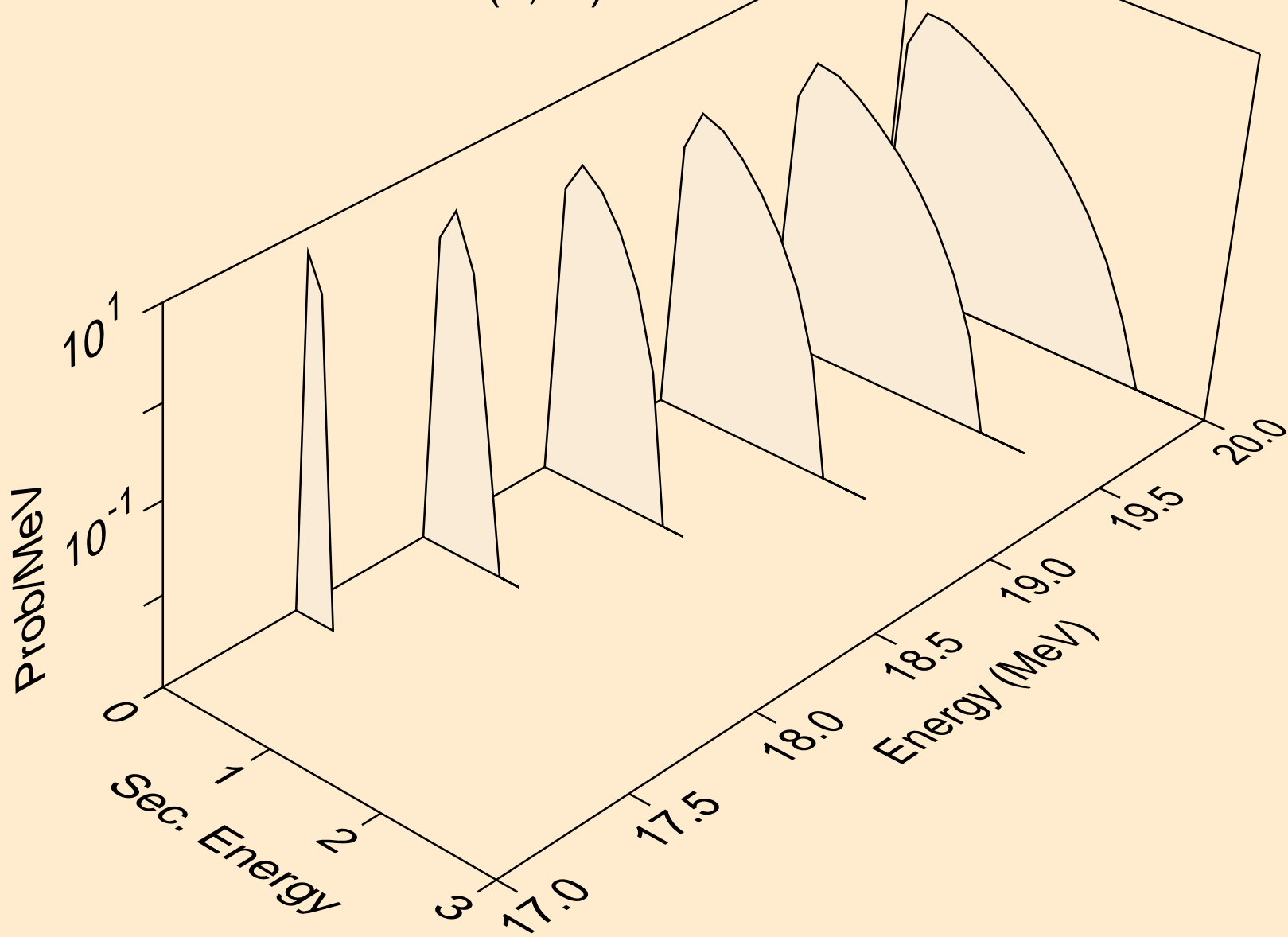

MAT=9867 ACE FILE PRODUCED AT NEA WITH NDEC
Neutron emission for (n,n*c)

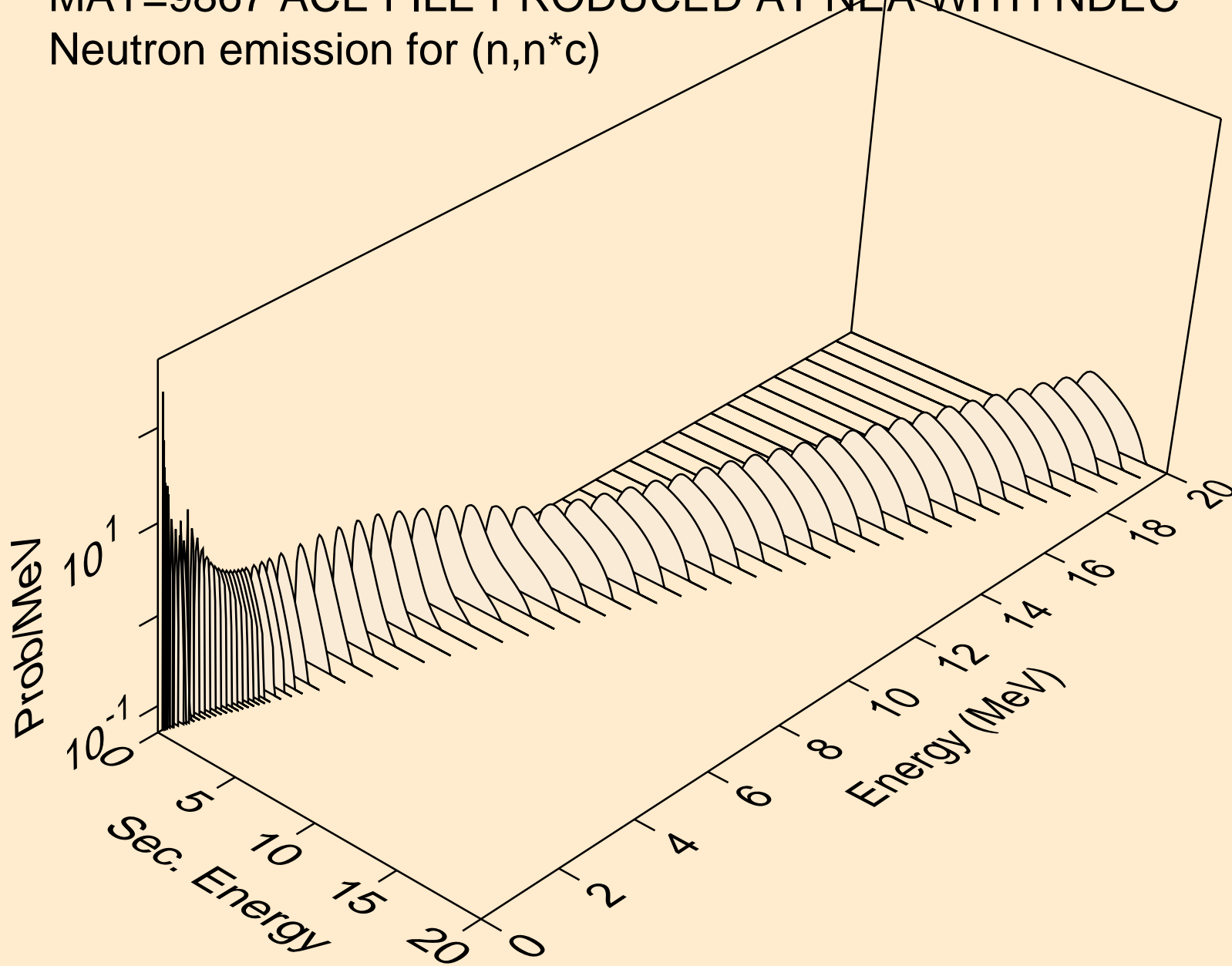

MAT=9867 ACE FILE PRODUCED AT NEA WITH NDEC
Photon emission for fission

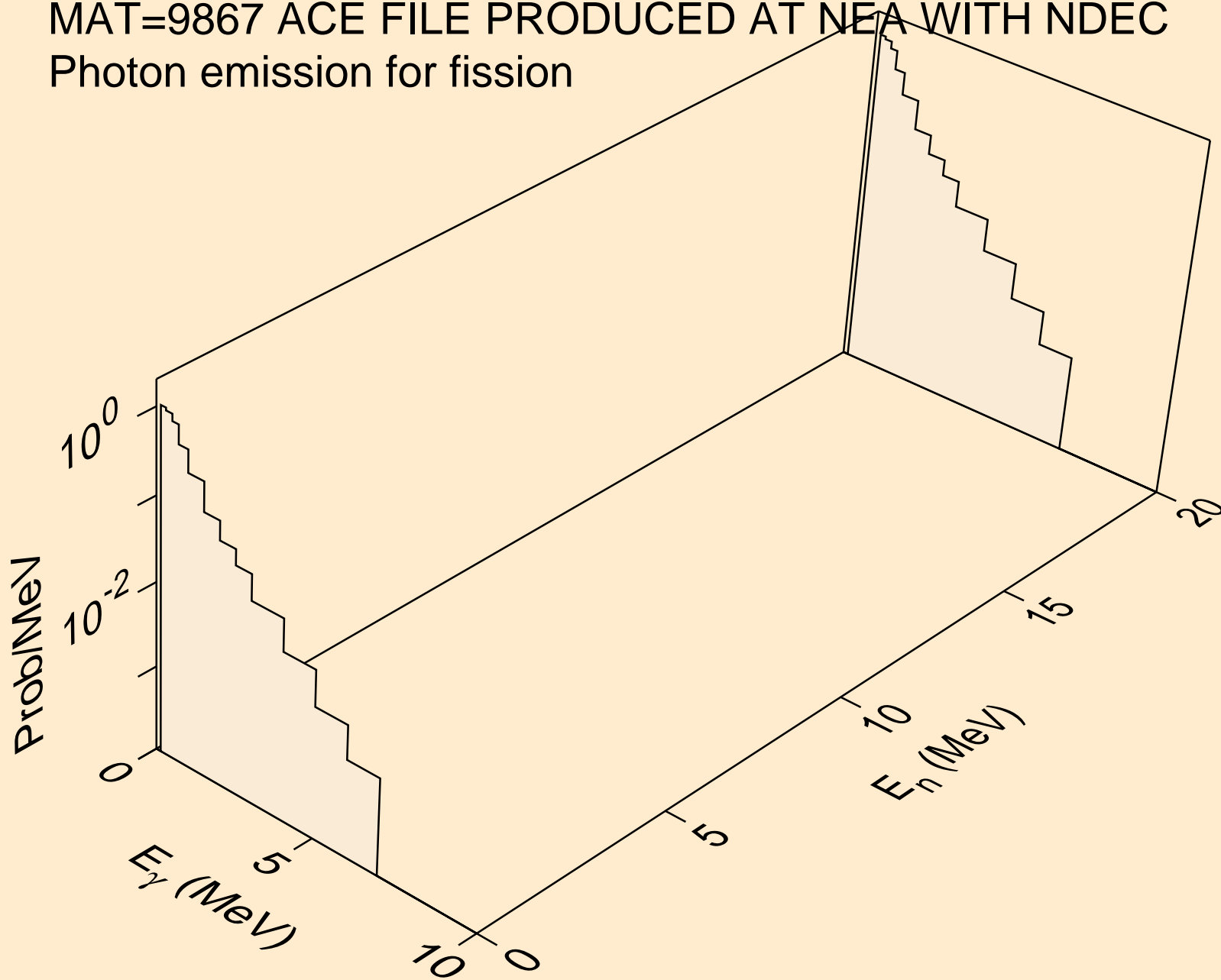

MAT=9867 ACE FILE PRODUCED AT NEA WITH NDEC
Photon emission for (n,2n)

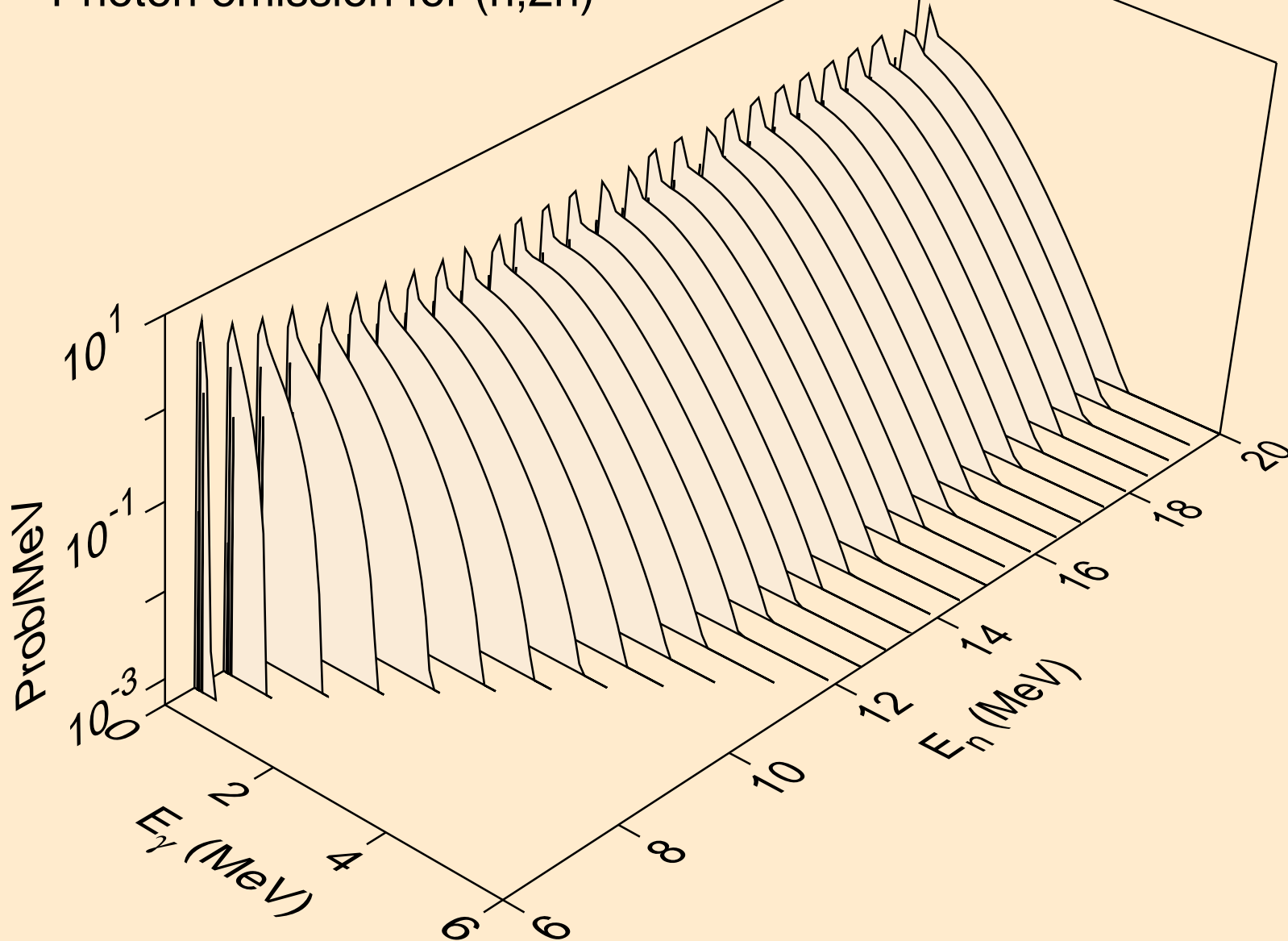

MAT=9867 ACE FILE PRODUCED AT NEA WITH NDEC
Photon emission for (n,3n)

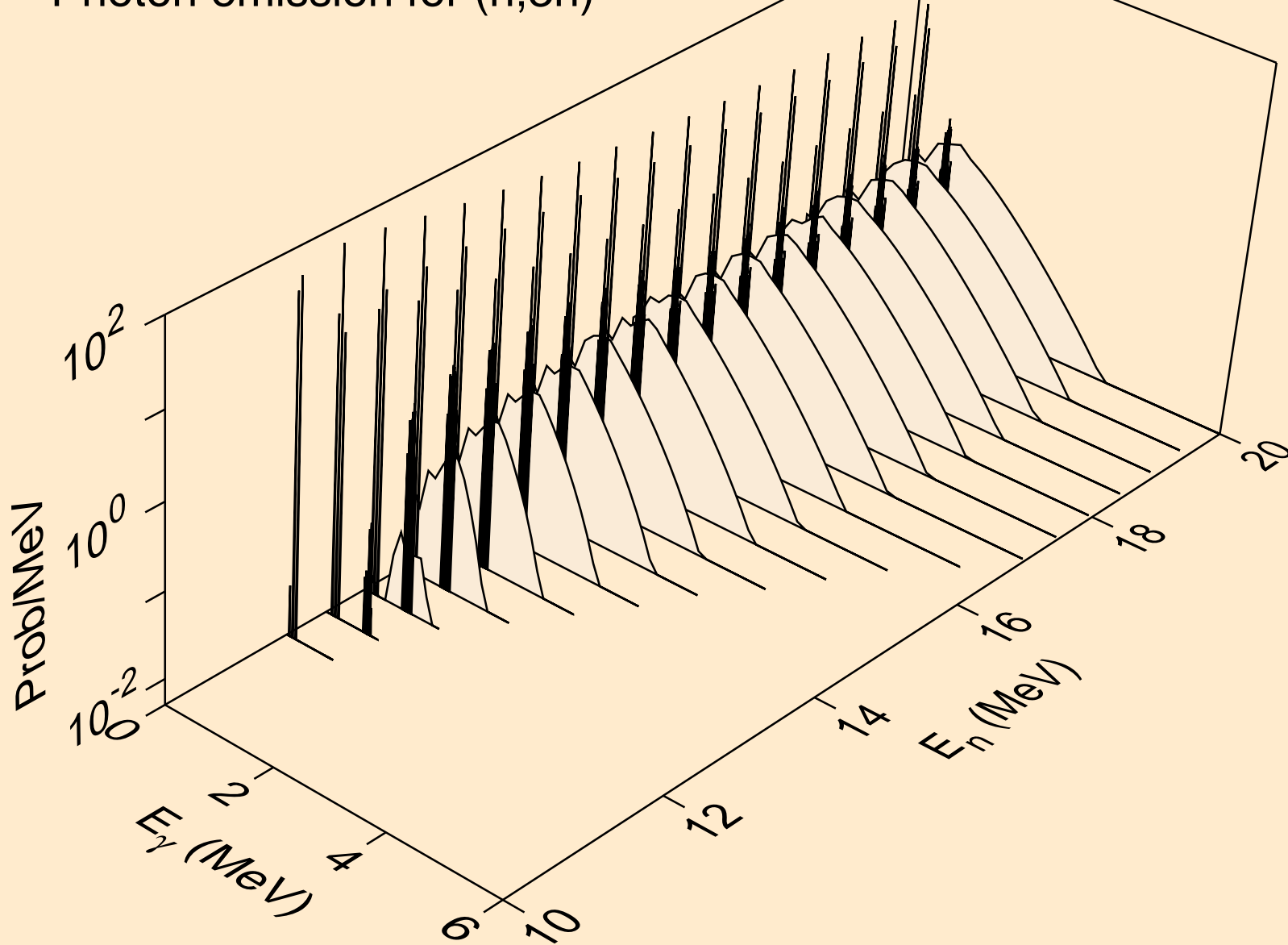

MAT=9867 ACE FILE PRODUCED AT NEA WITH NDEC
Photon emission for (n,4n)

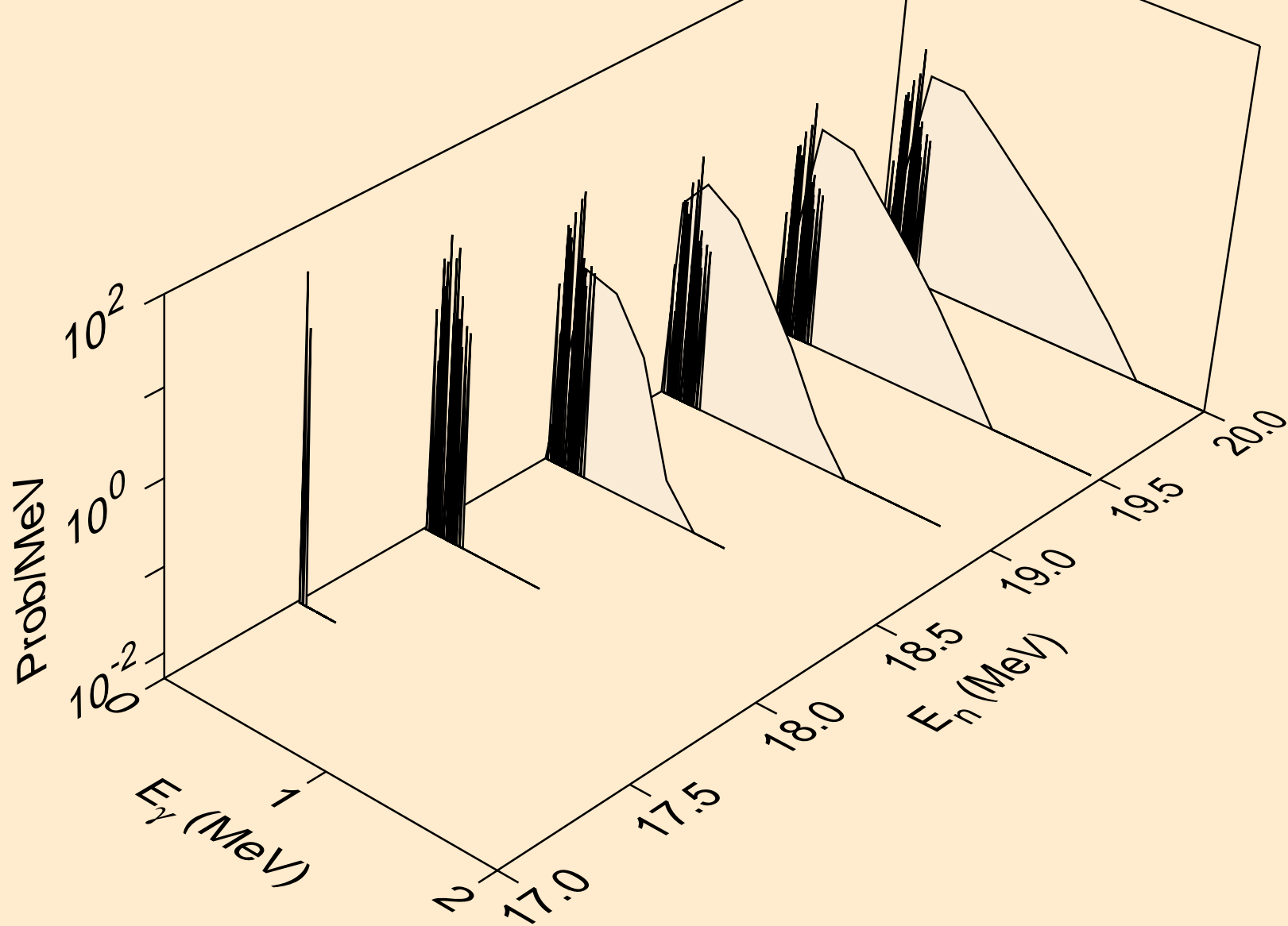

MAT=9867 ACE FILE PRODUCED AT NEA WITH NDEC
Photon emission for (n,n*1)

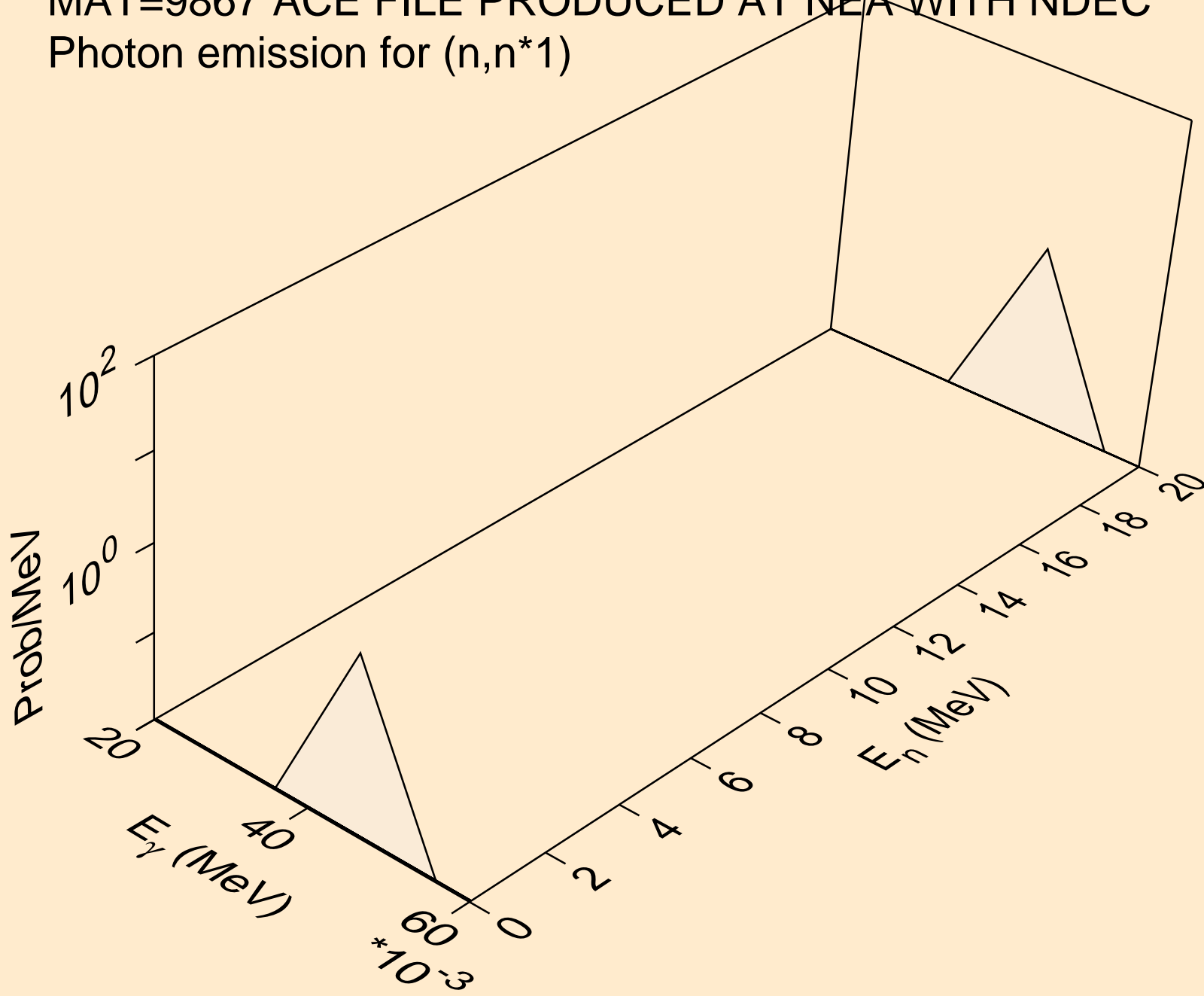

MAT=9867 ACE FILE PRODUCED AT NEA WITH NDEC
Photon emission for (n,n*2)

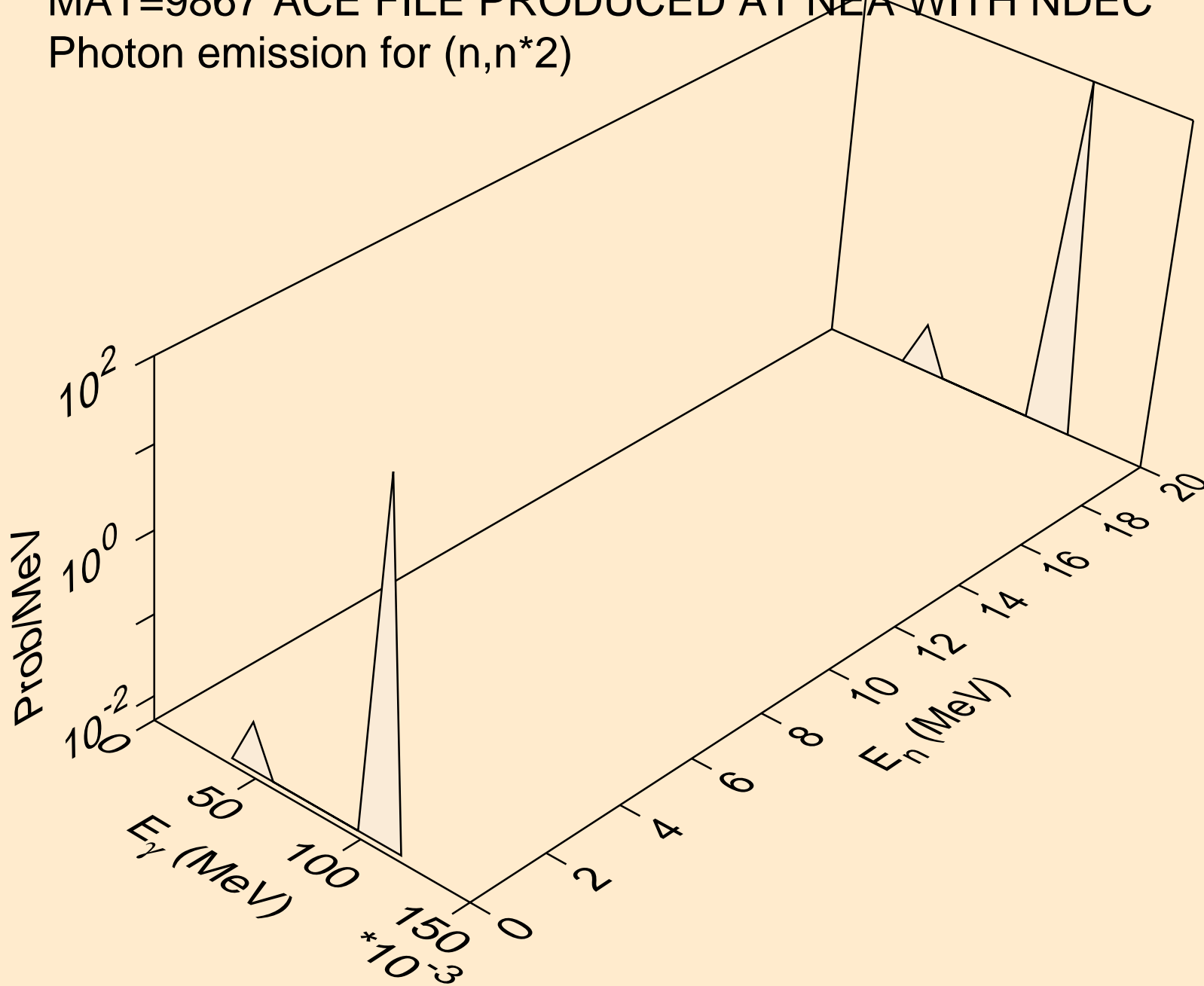

MAT=9867 ACE FILE PRODUCED AT NEA WITH NDEC
Photon emission for (n,n*3)

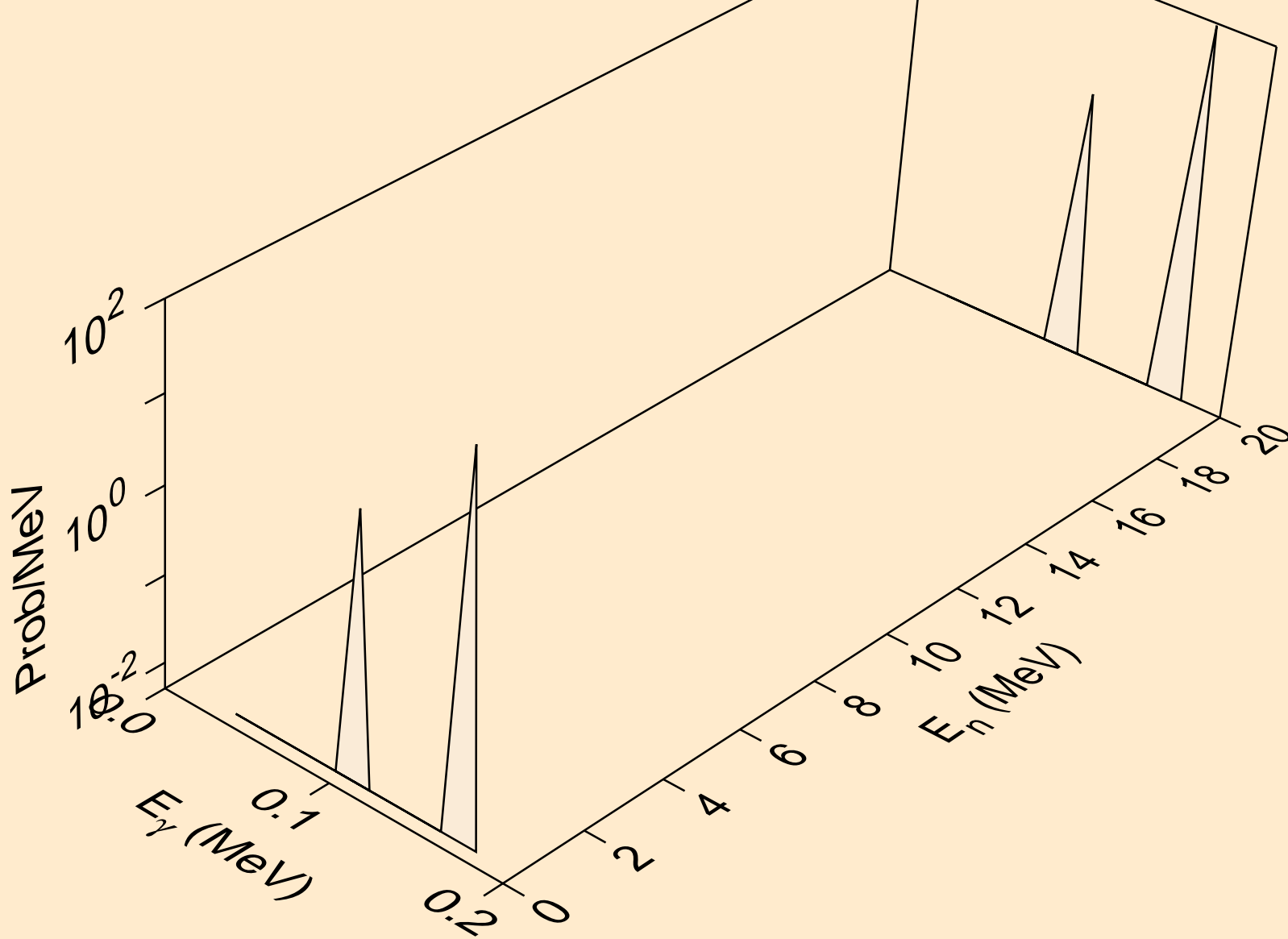

MAT=9867 ACE FILE PRODUCED AT NEA WITH NDEC
Photon emission for (n,n*4)

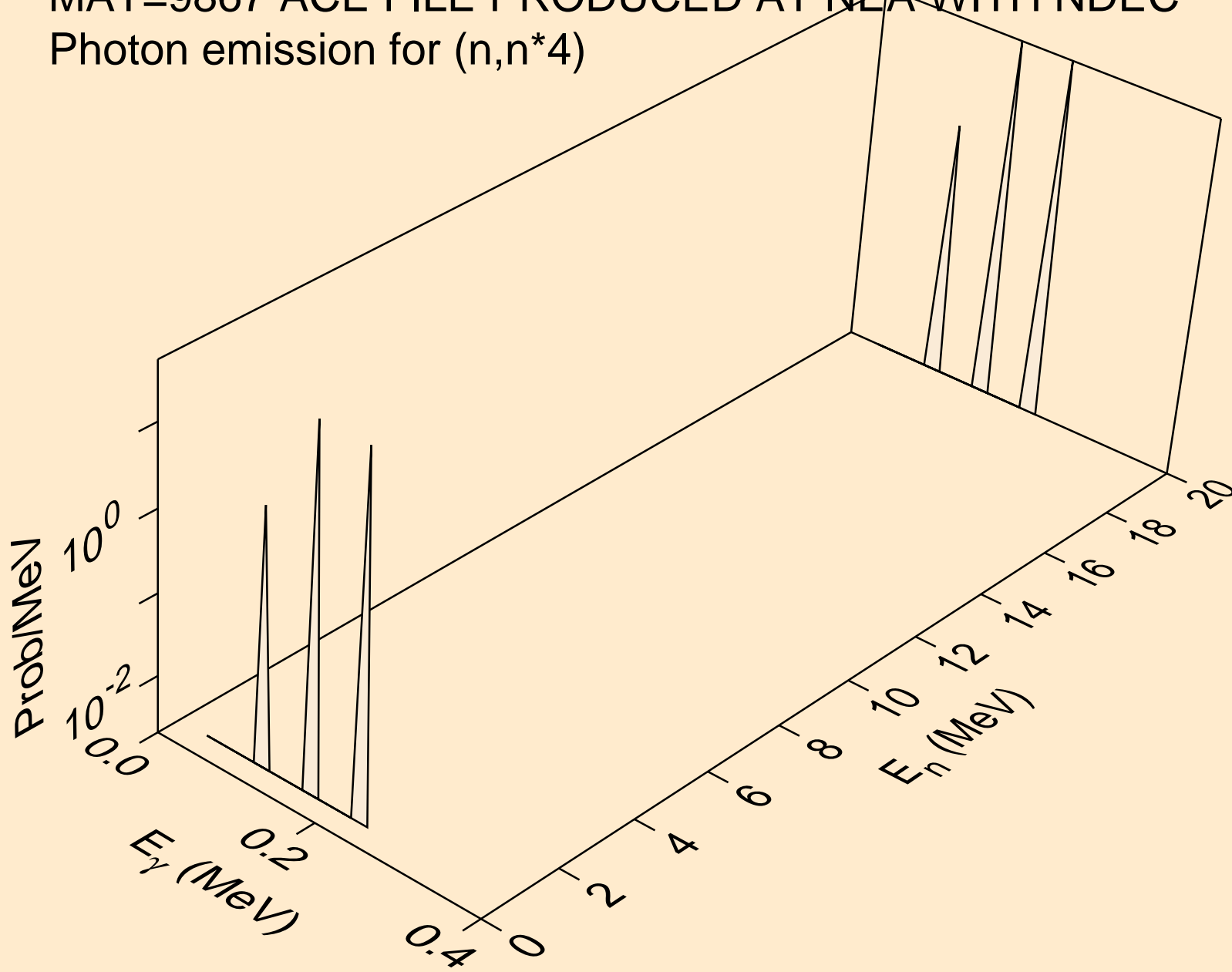

MAT=9867 ACE FILE PRODUCED AT NEA WITH NDEC
Photon emission for (n,n*c)

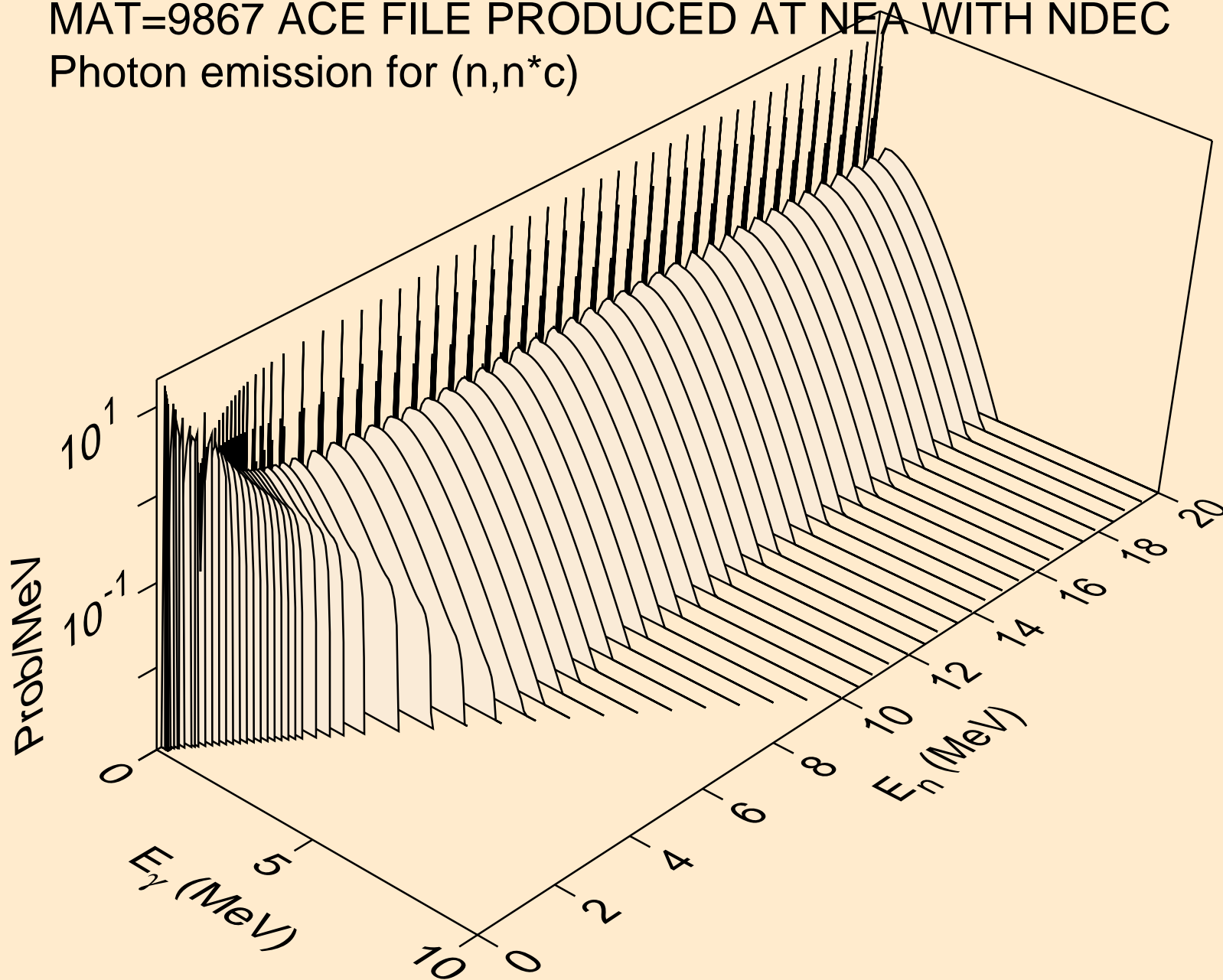

MAT=9867 ACE FILE PRODUCED AT NEA WITH NDEC
Photon emission for (n,gma)

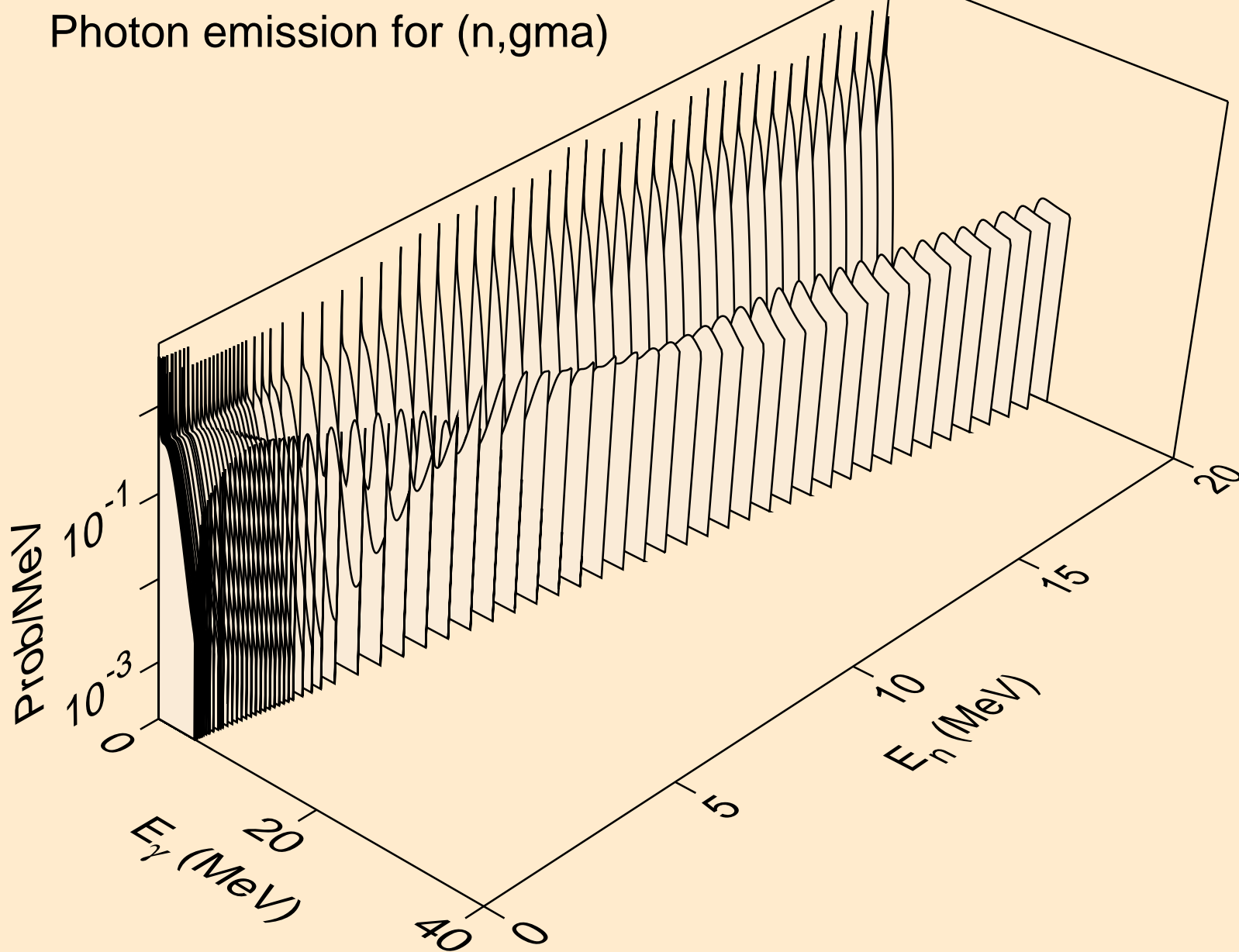

MAT=9867 ACE FILE PRODUCED AT NEA WITH NDEC
thermal capture photon spectrum

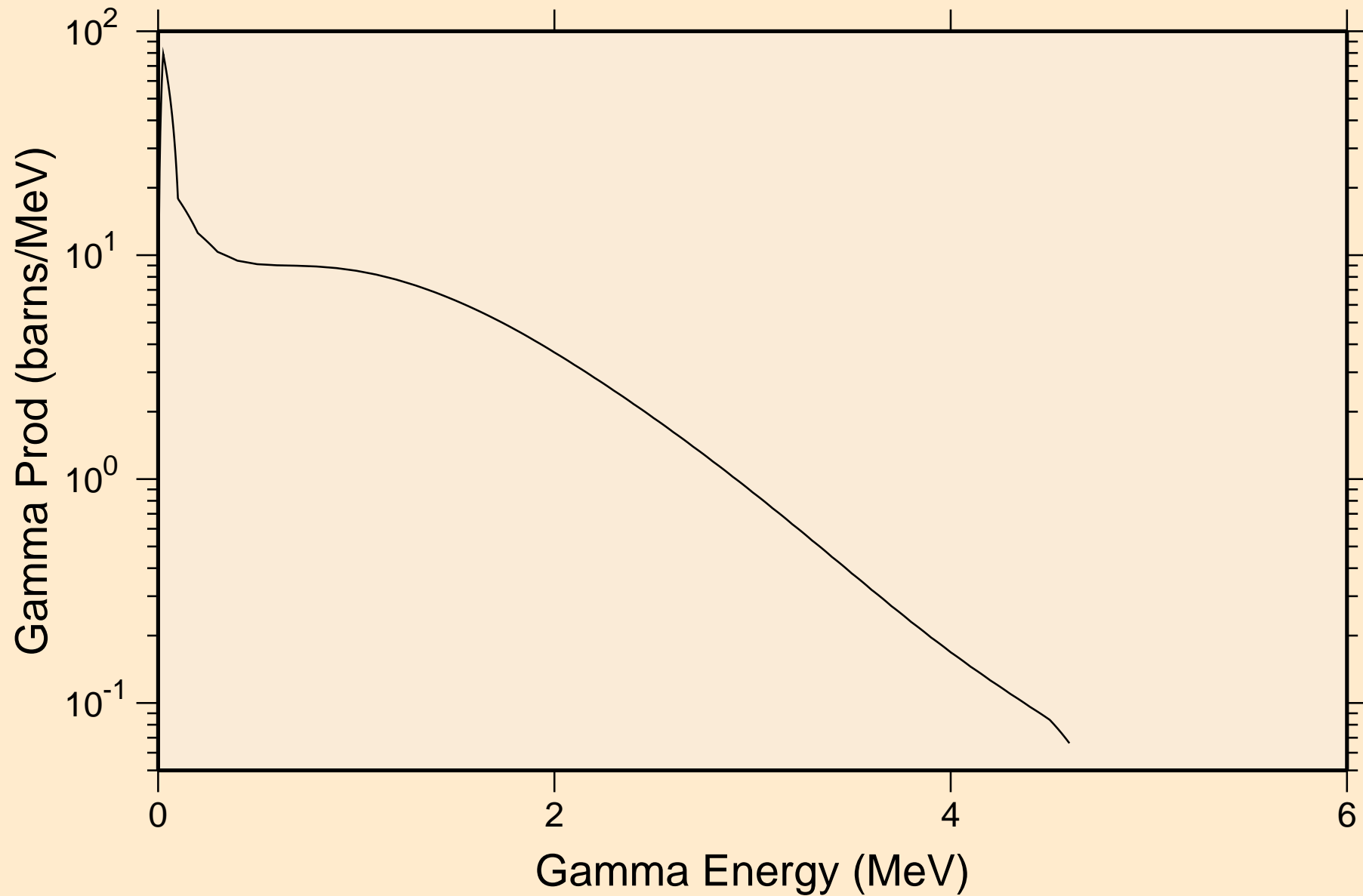

MAT=9867 ACE FILE PRODUCED AT NEA WITH NDEC
14 MeV photon spectrum

