

MAT=7722 ACE FILE PRODUCED AT NEA WITH NDEC

Principal cross sections

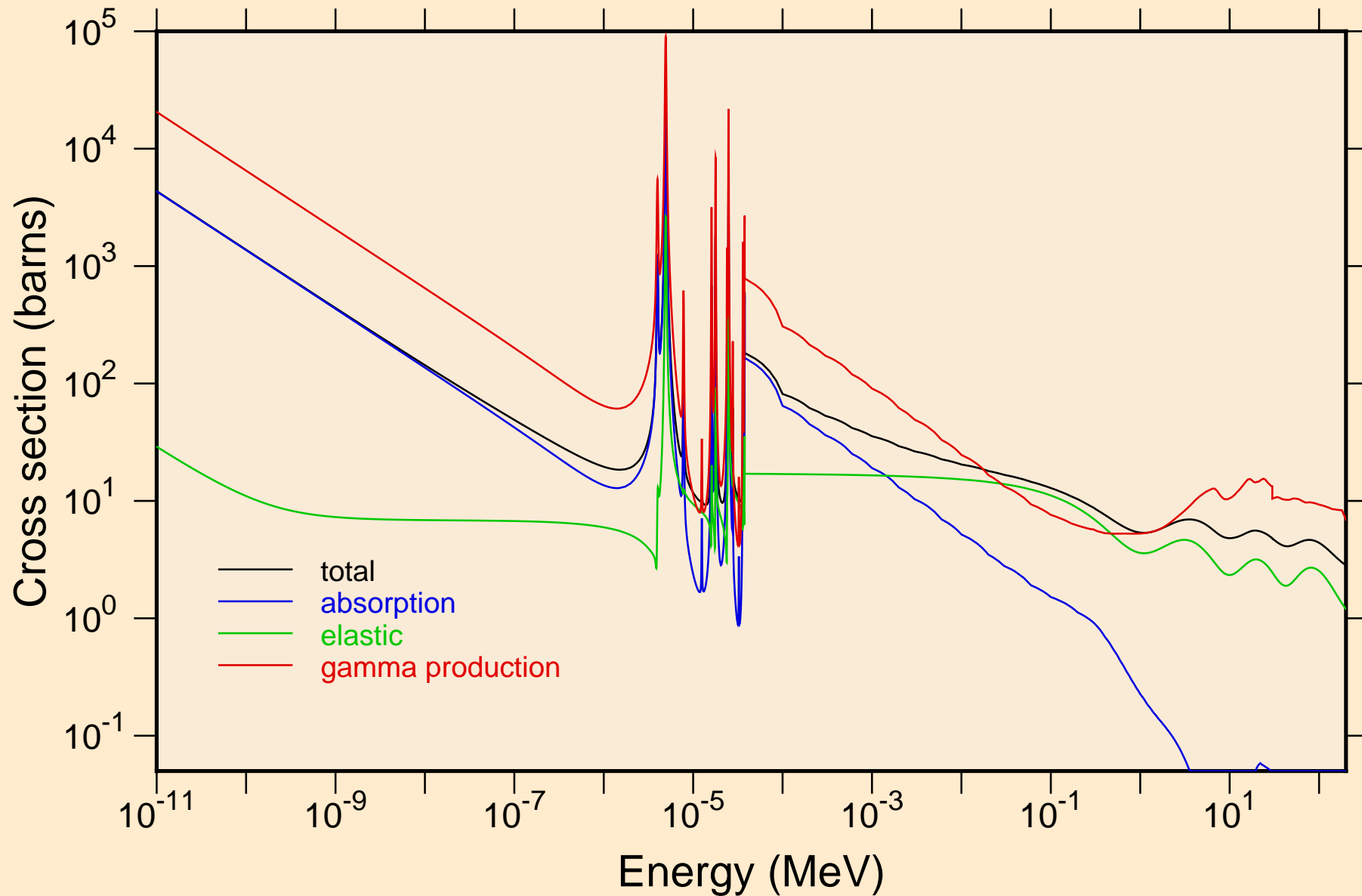

MAT=7722 ACE FILE PRODUCED AT NEA WITH NDEC
resonance total cross section

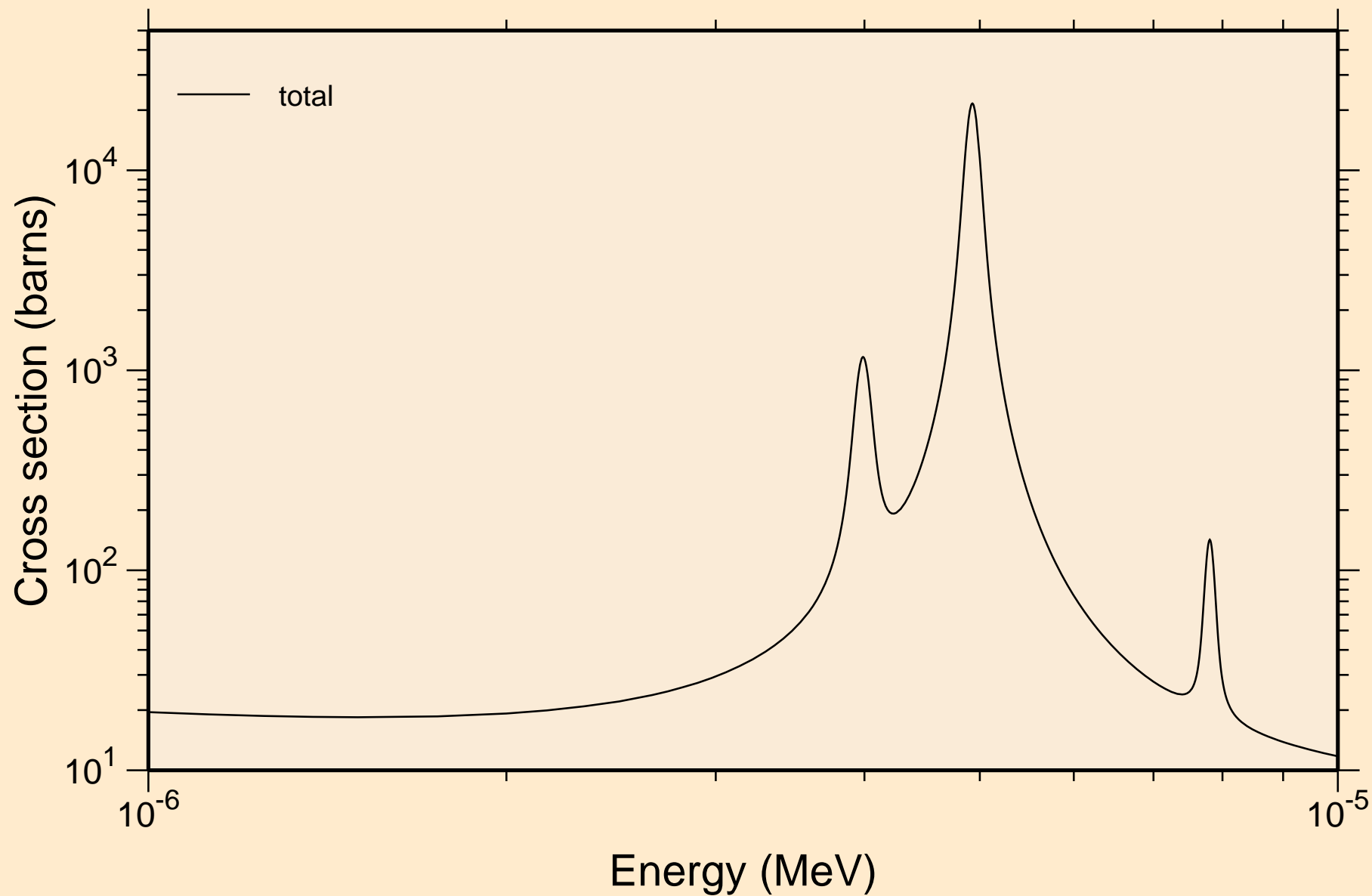

MAT=7722 ACE FILE PRODUCED AT NEA WITH NDEC
resonance total cross section

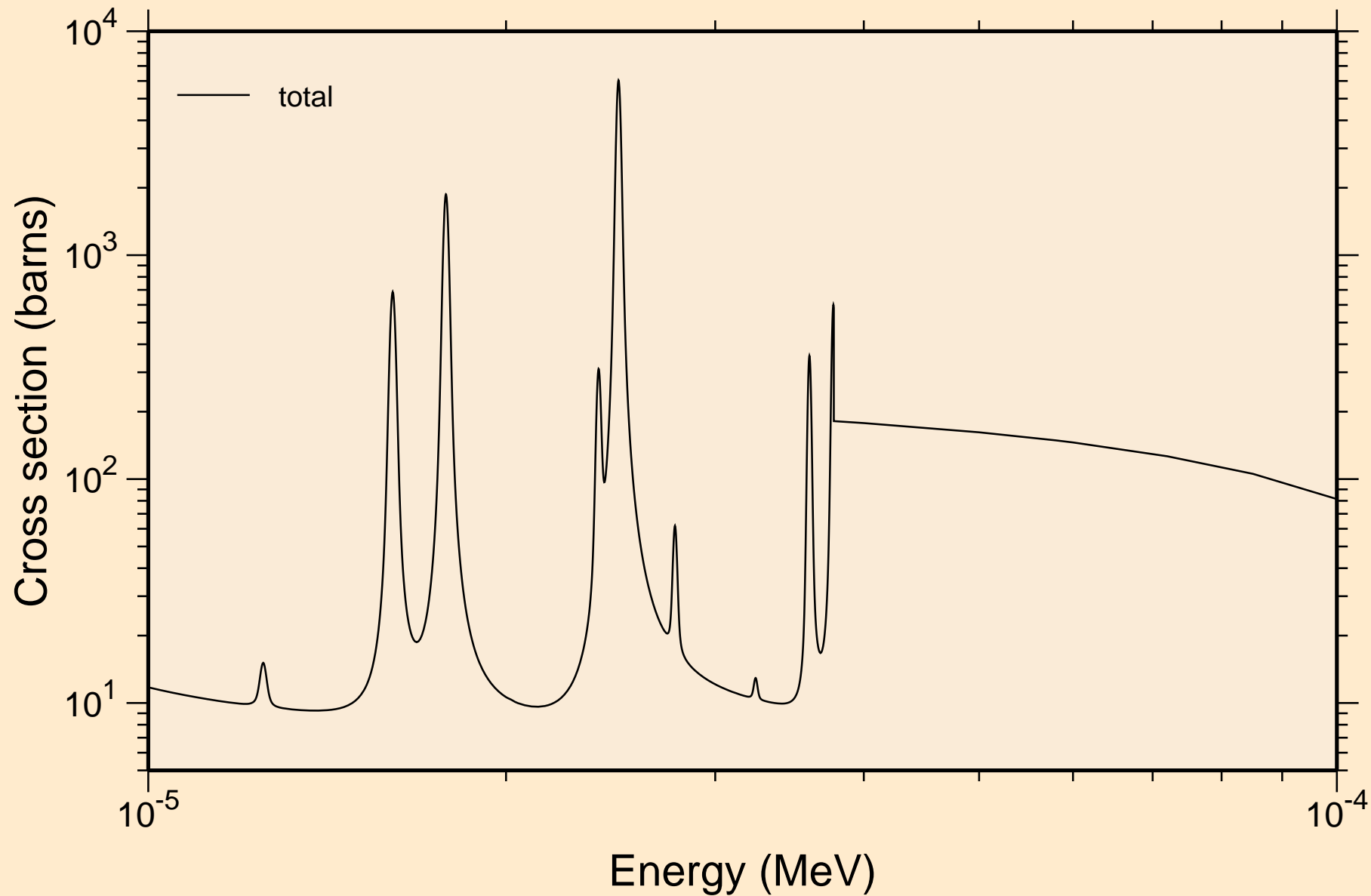

MAT=7722 ACE FILE PRODUCED AT NEA WITH NDEC
resonance total cross section

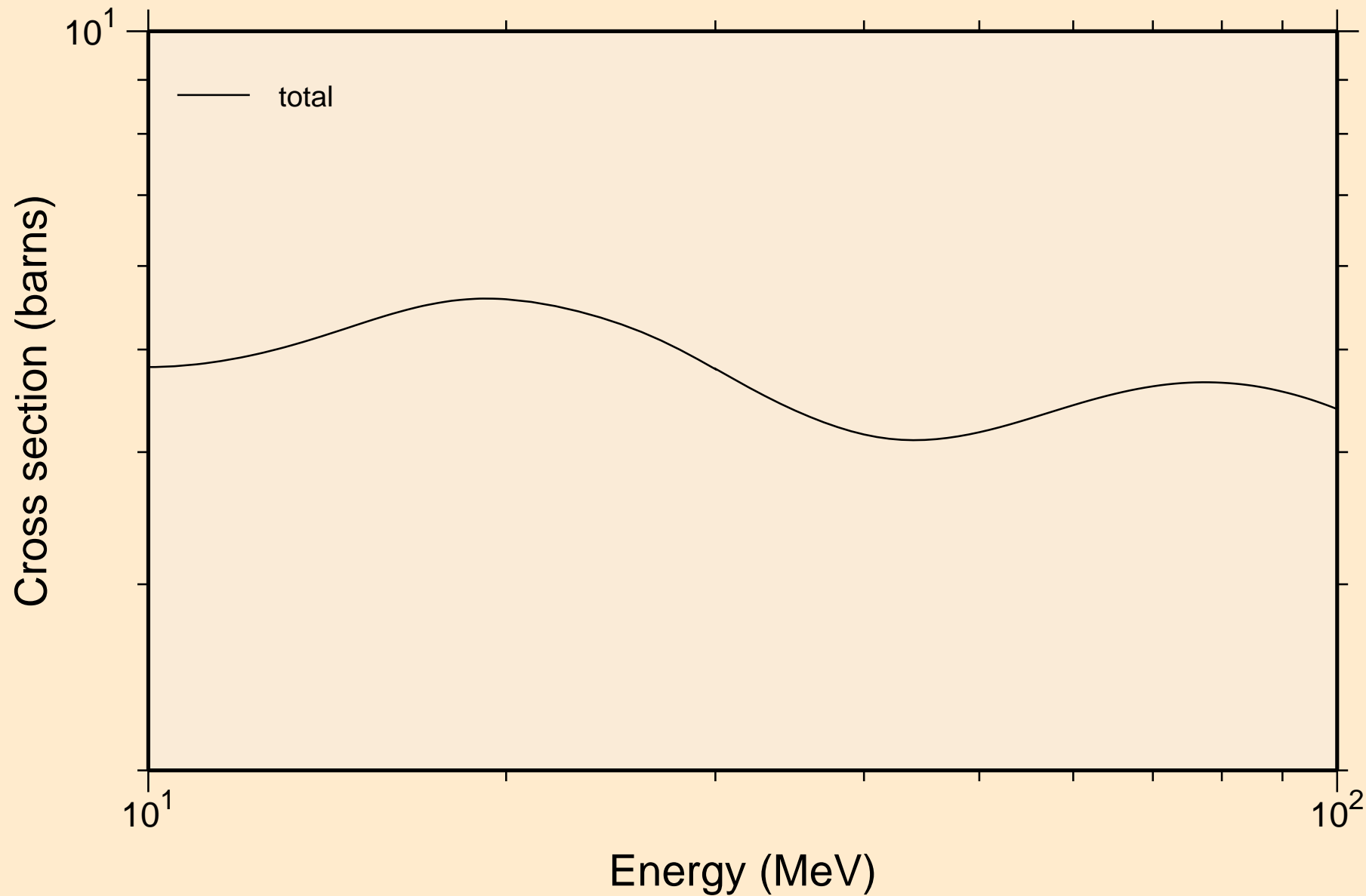

MAT=7722 ACE FILE PRODUCED AT NEA WITH NDEC
resonance absorption cross sections

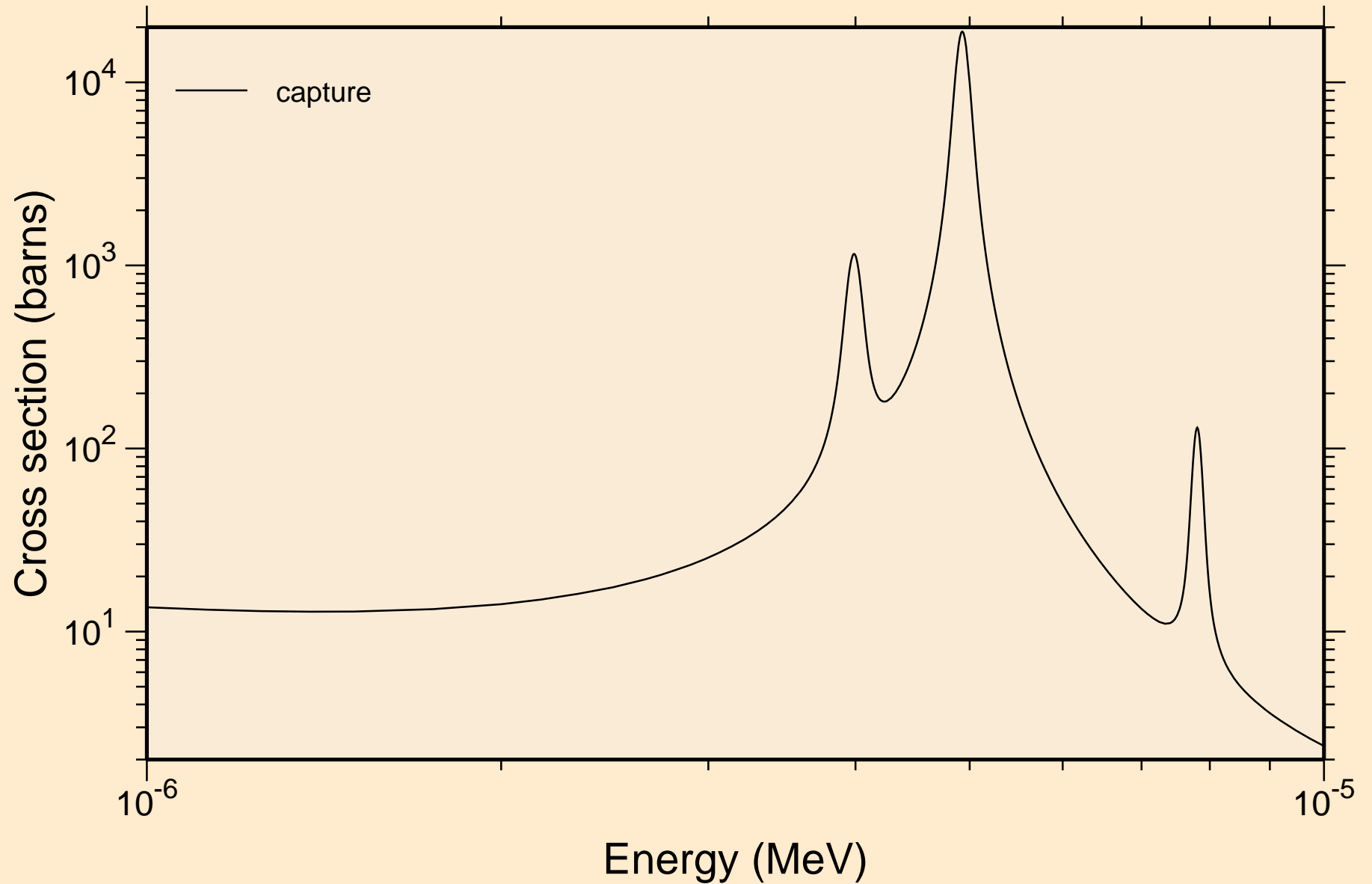

MAT=7722 ACE FILE PRODUCED AT NEA WITH NDEC
resonance absorption cross sections

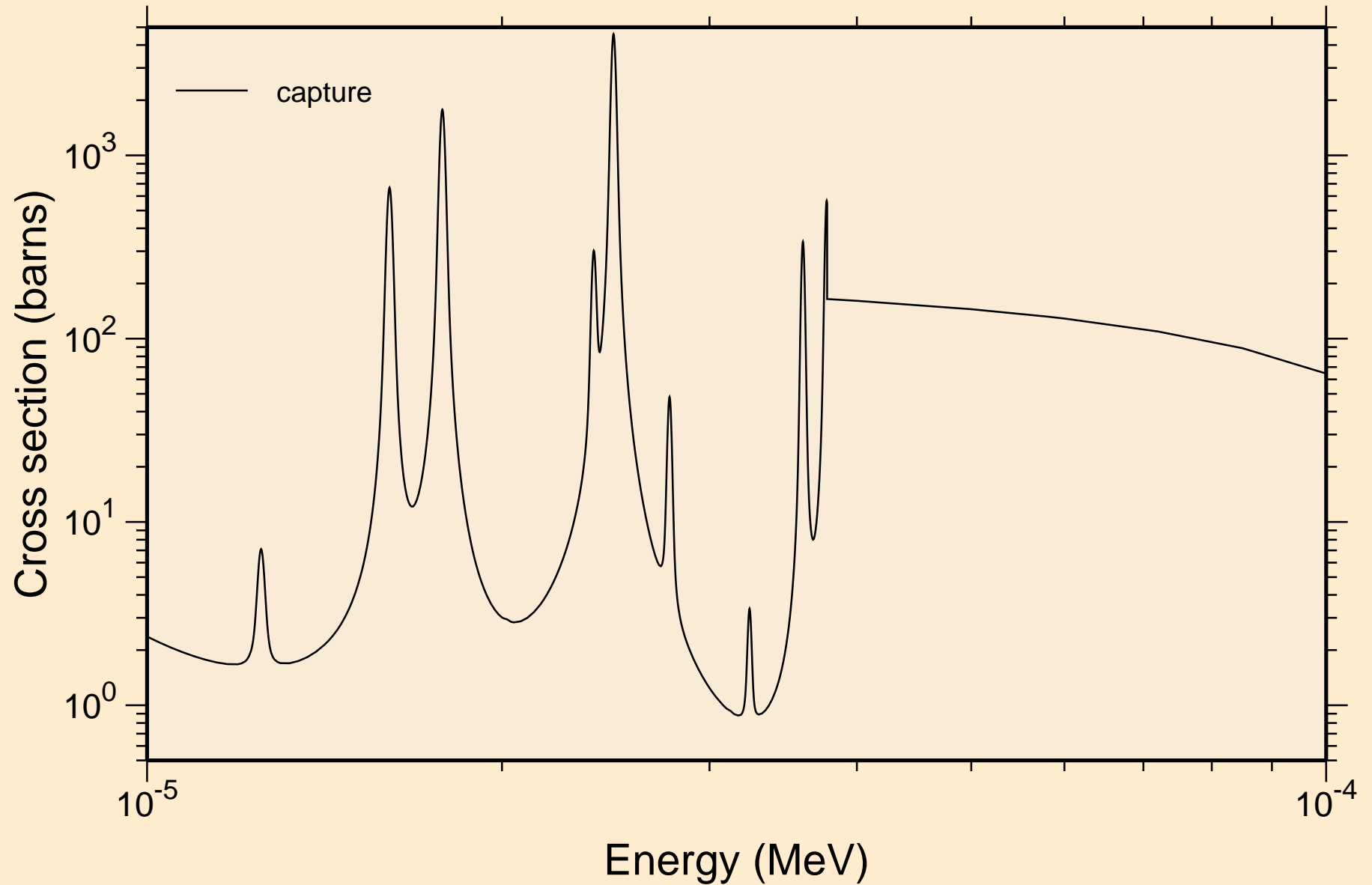

MAT=7722 ACE FILE PRODUCED AT NEA WITH NDEC
resonance absorption cross sections

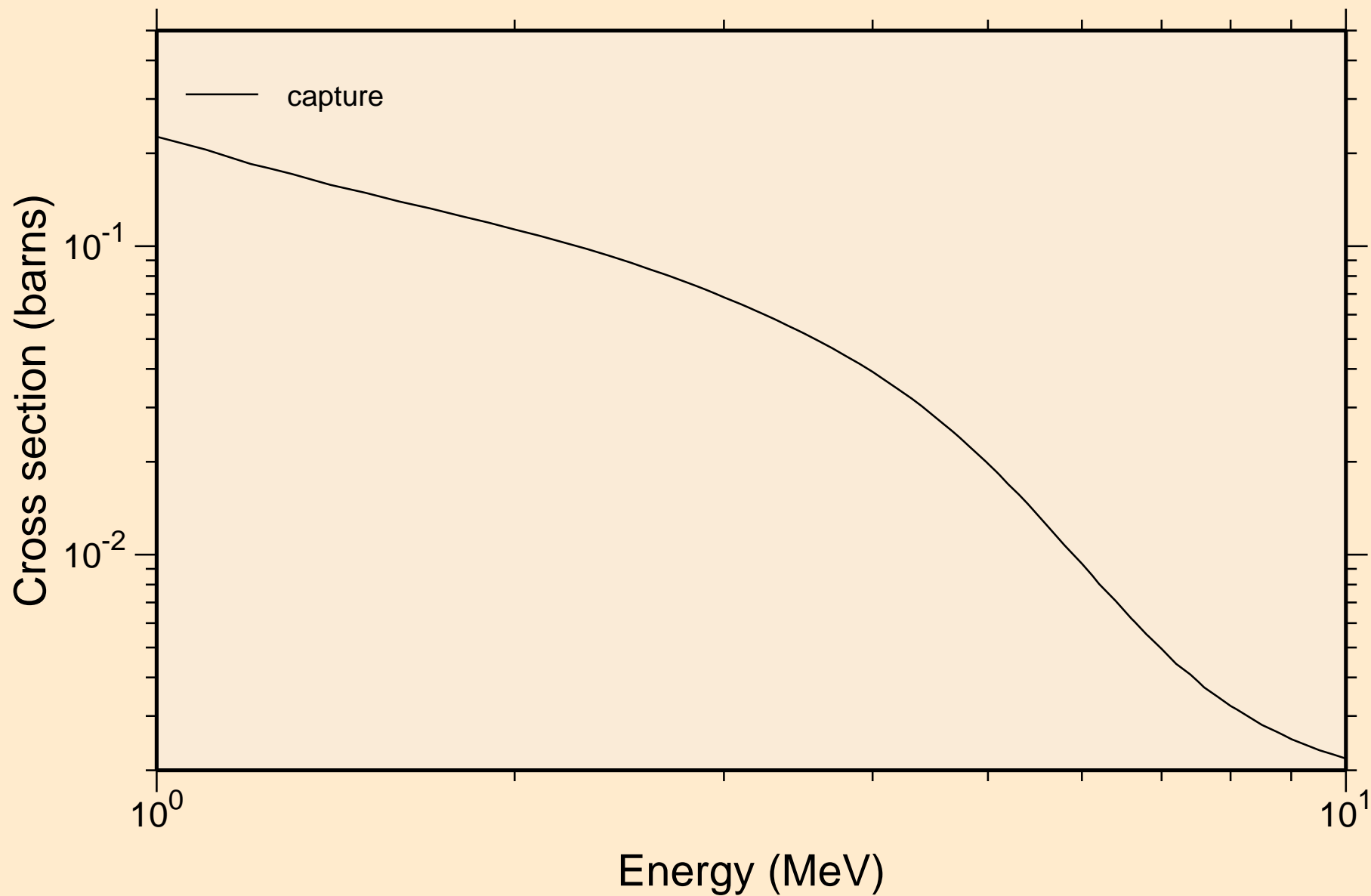

MAT=7722 ACE FILE PRODUCED AT NEA WITH NDEC
UR total cross section

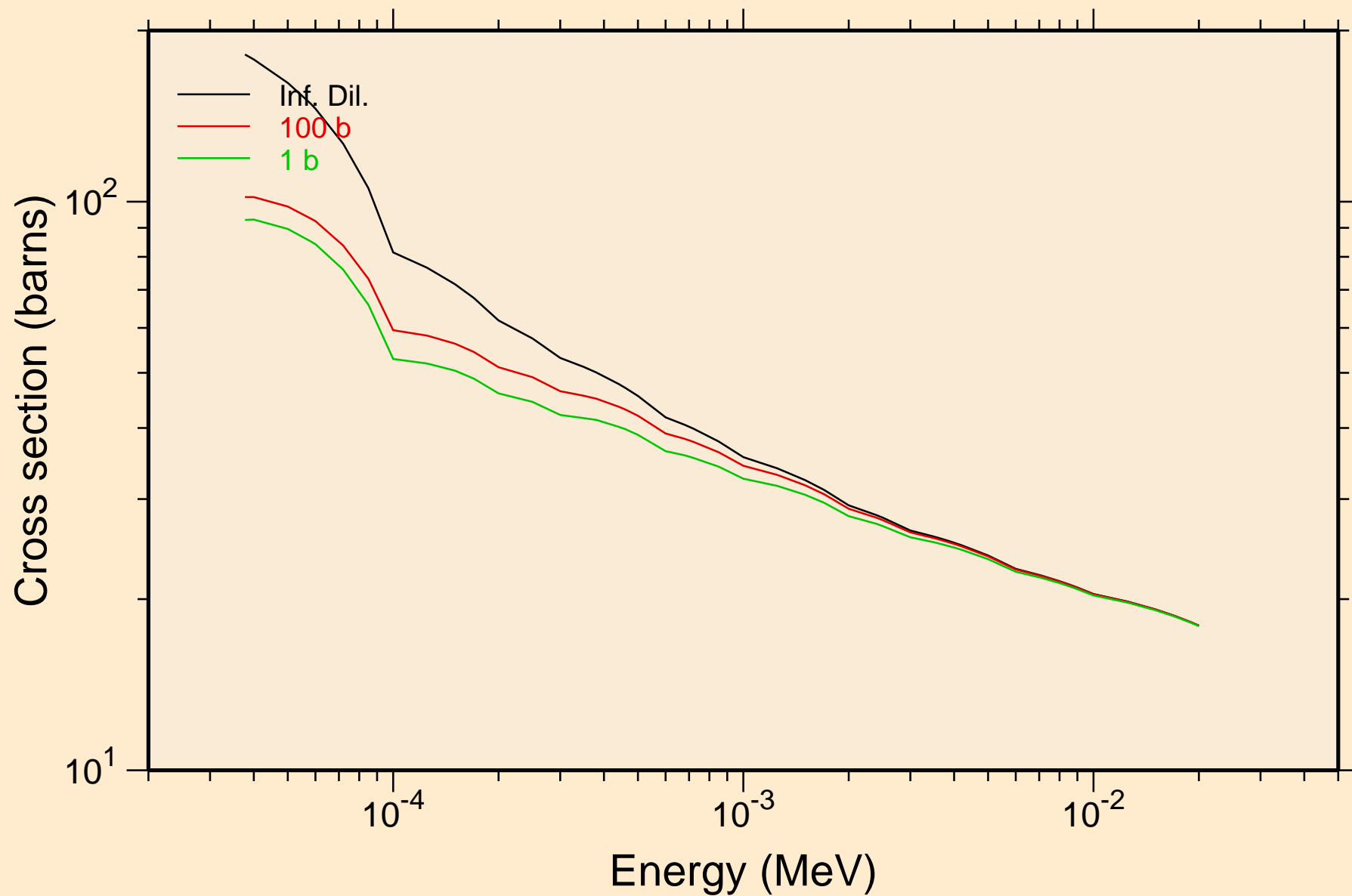

MAT=7722 ACE FILE PRODUCED AT NEA WITH NDEC
UR elastic cross section

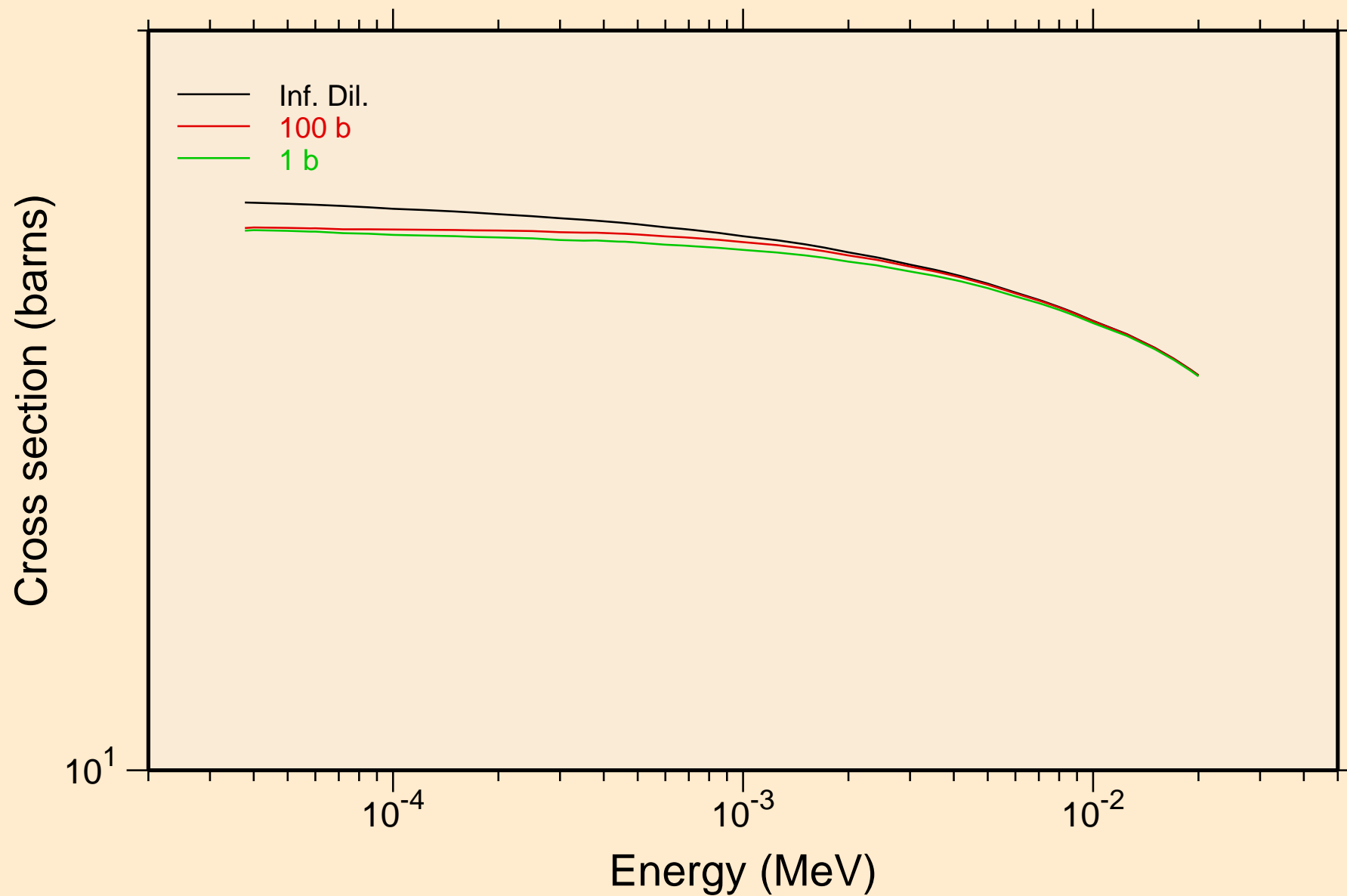

MAT=7722 ACE FILE PRODUCED AT NEA WITH NDEC
UR capture cross section

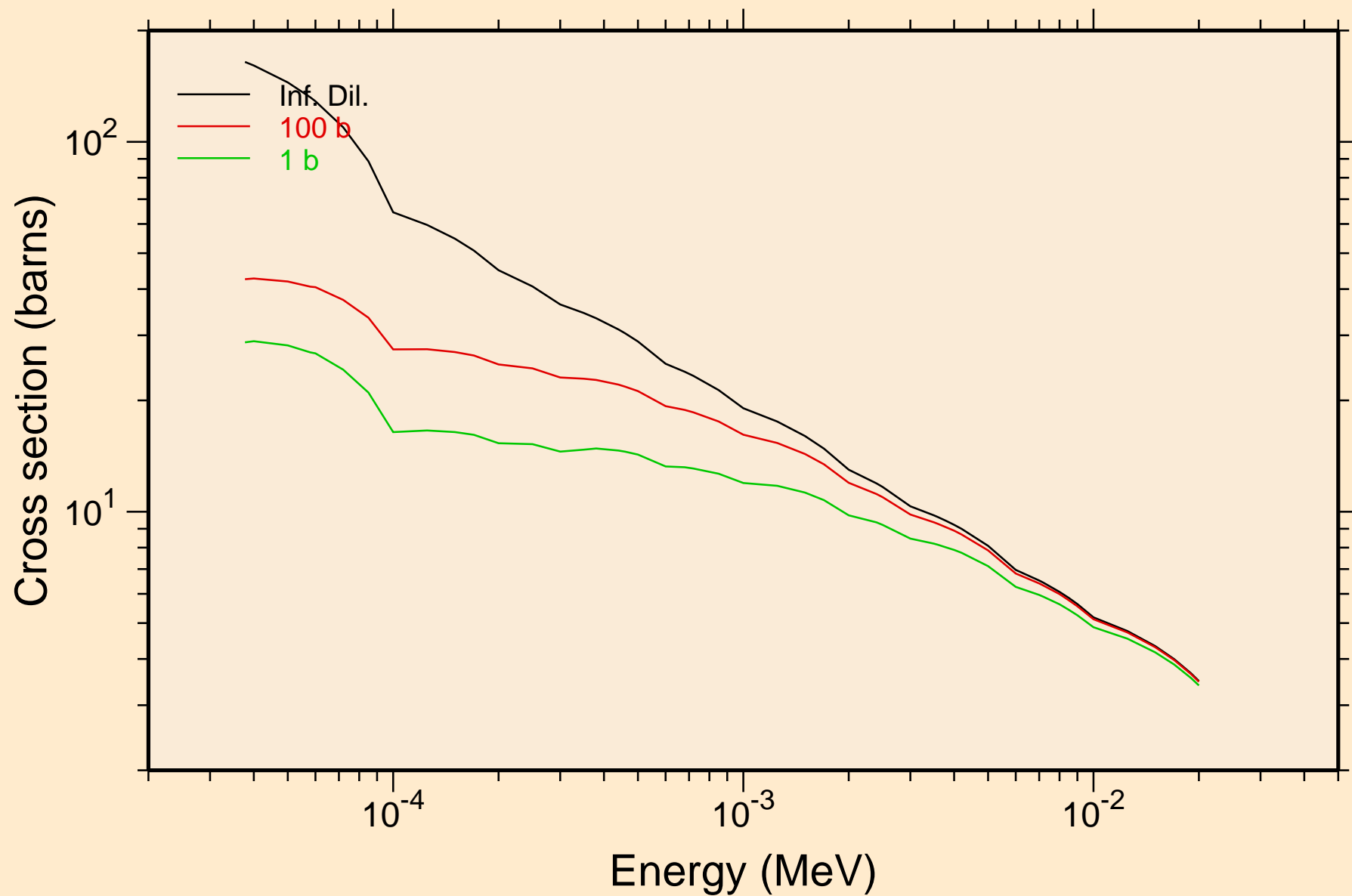

MAT=7722 ACE FILE PRODUCED AT NEA WITH NDEC
Heating

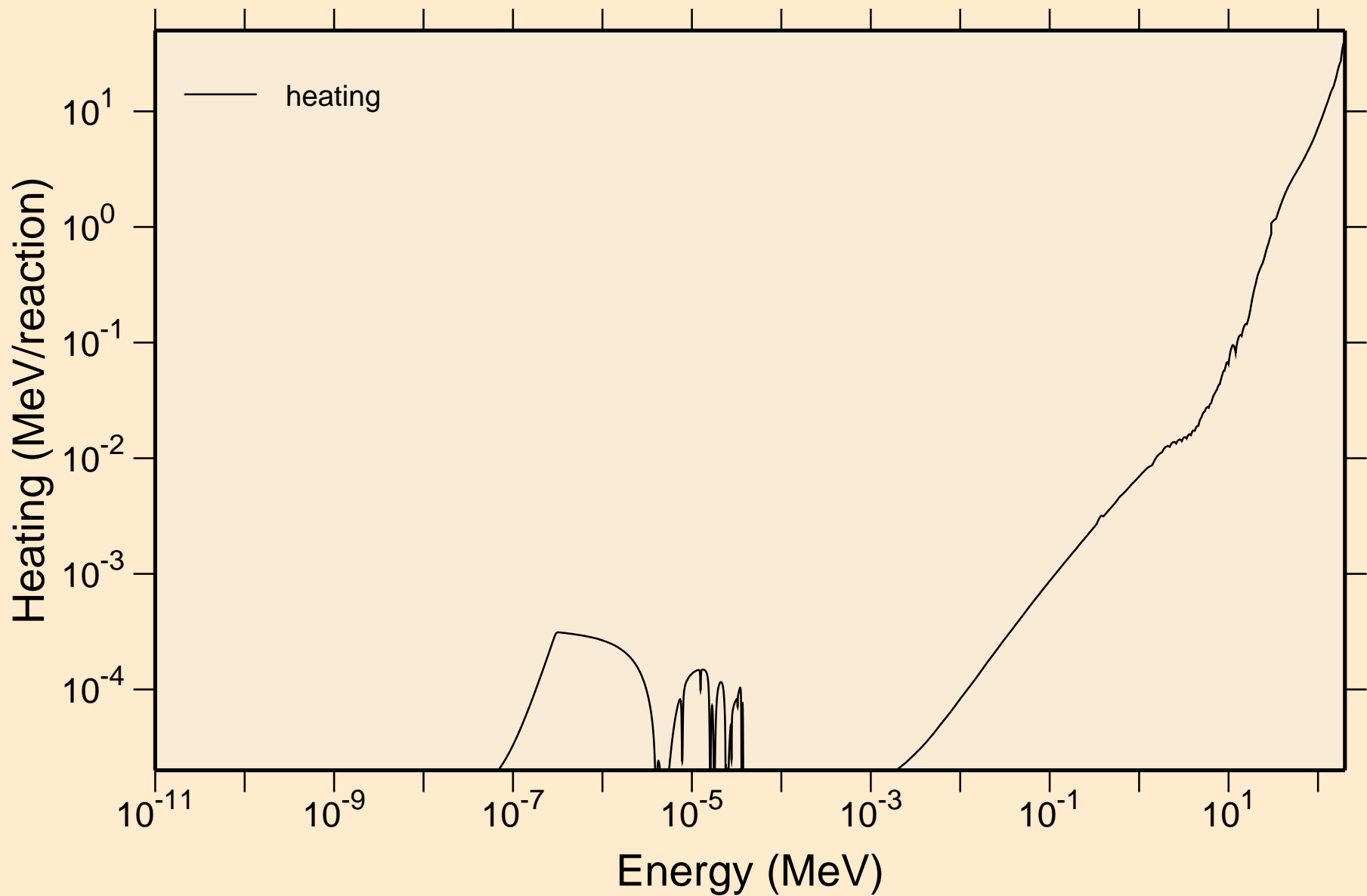

MAT=7722 ACE FILE PRODUCED AT NEA WITH NDEC
Damage

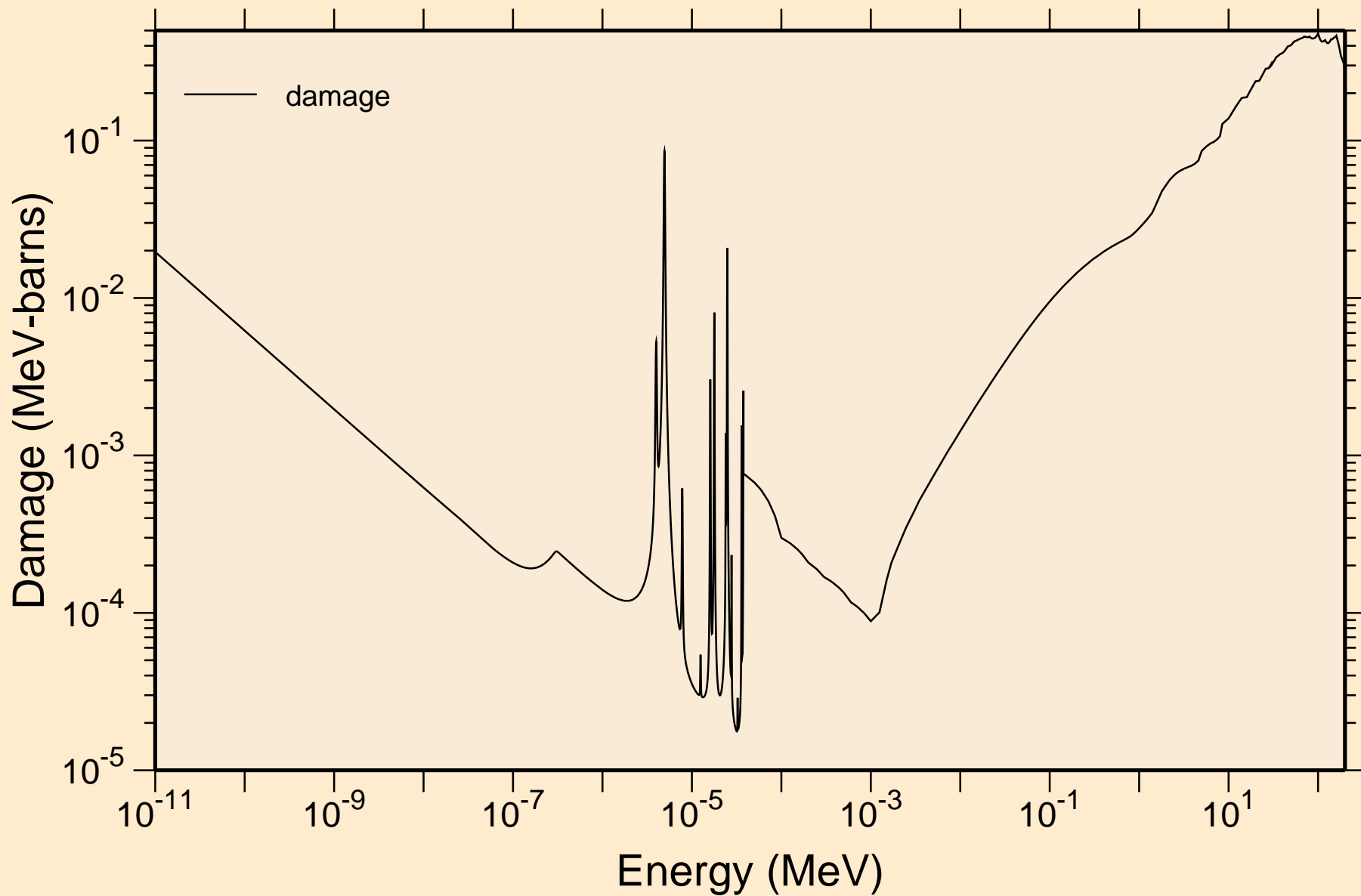

MAT=7722 ACE FILE PRODUCED AT NEA WITH NDEC
Non-threshold reactions

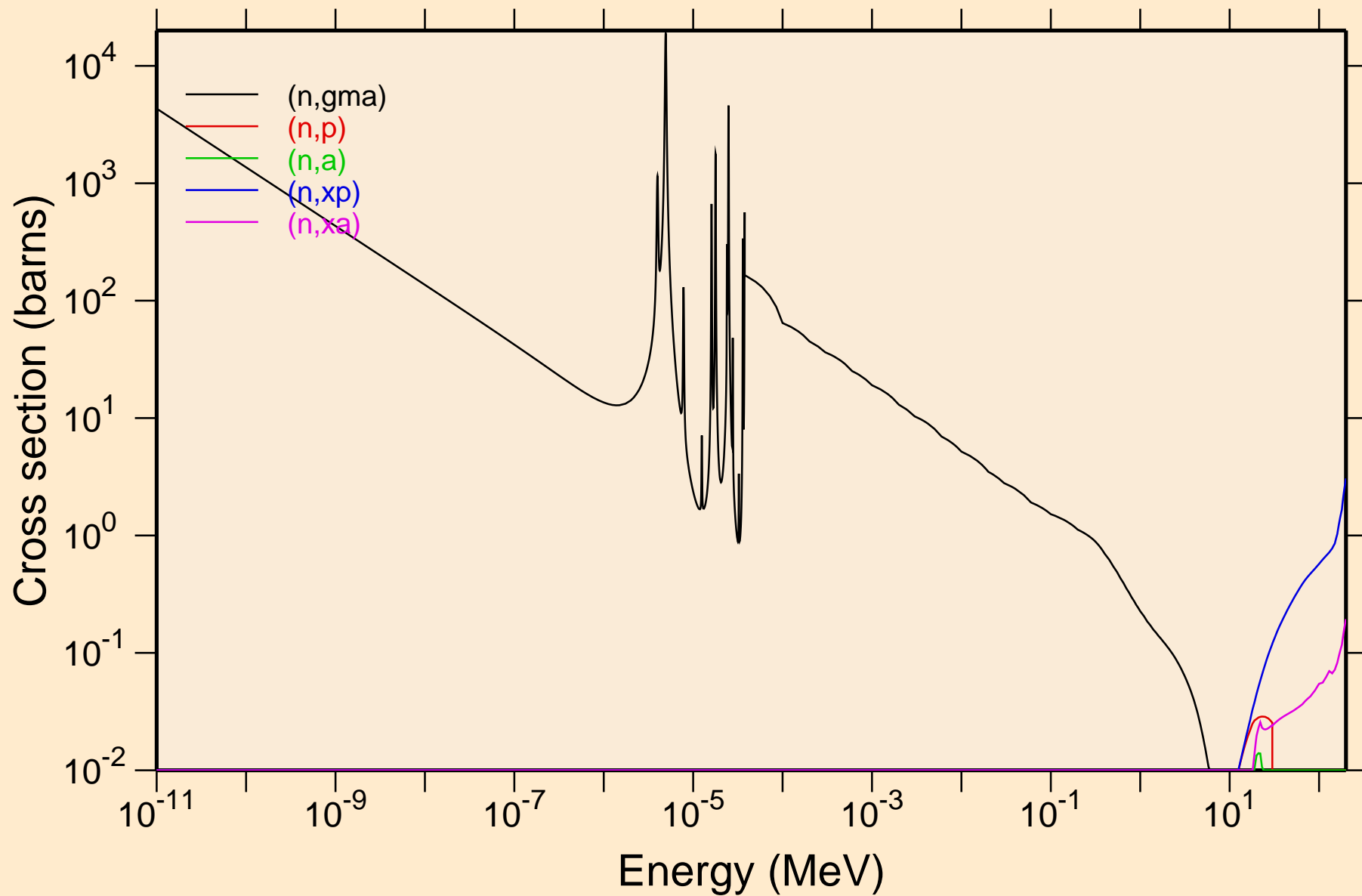

MAT=7722 ACE FILE PRODUCED AT NEA WITH NDEC

Principal cross sections

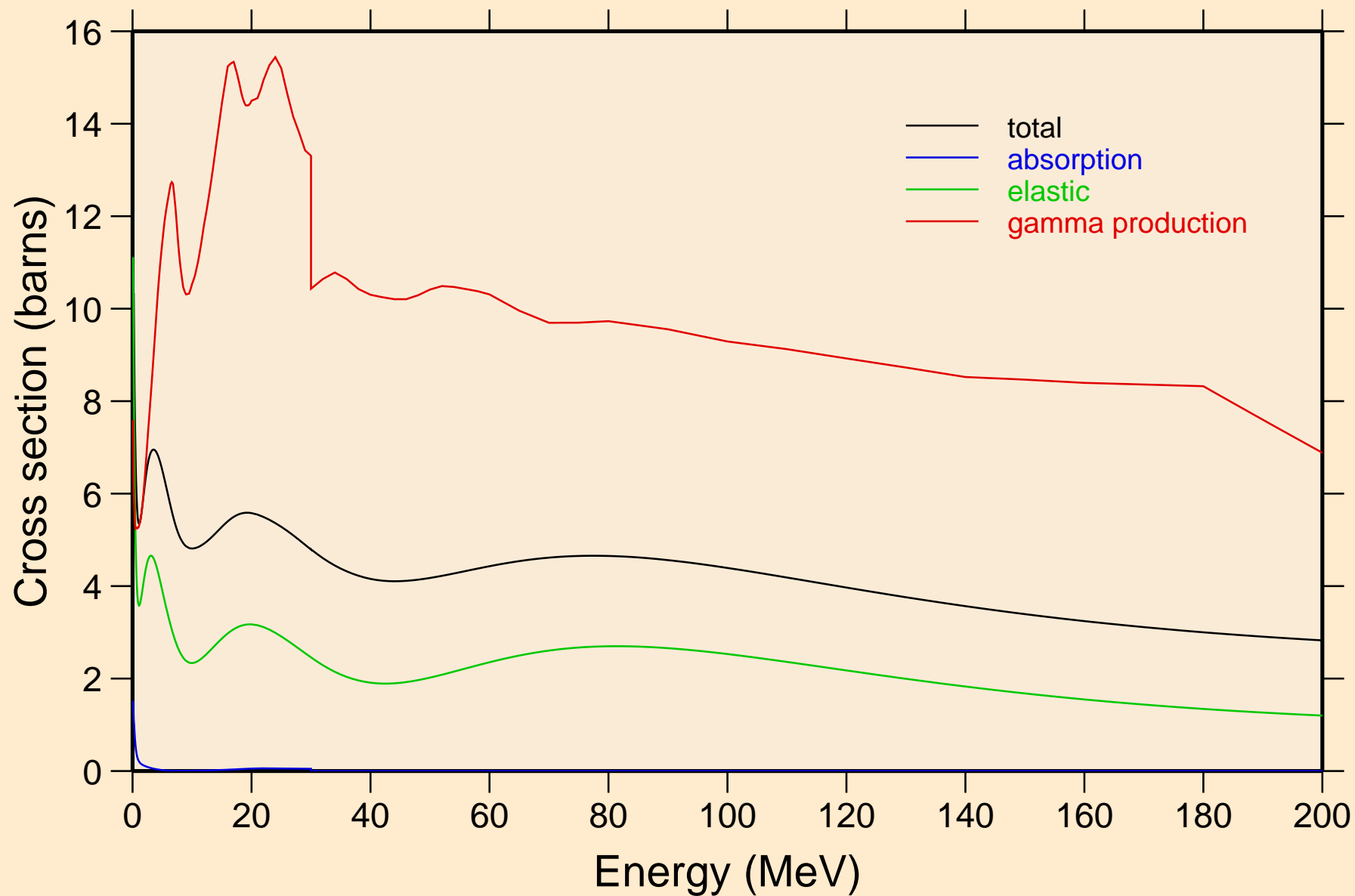

MAT=7722 ACE FILE PRODUCED AT NEA WITH NDEC
Heating

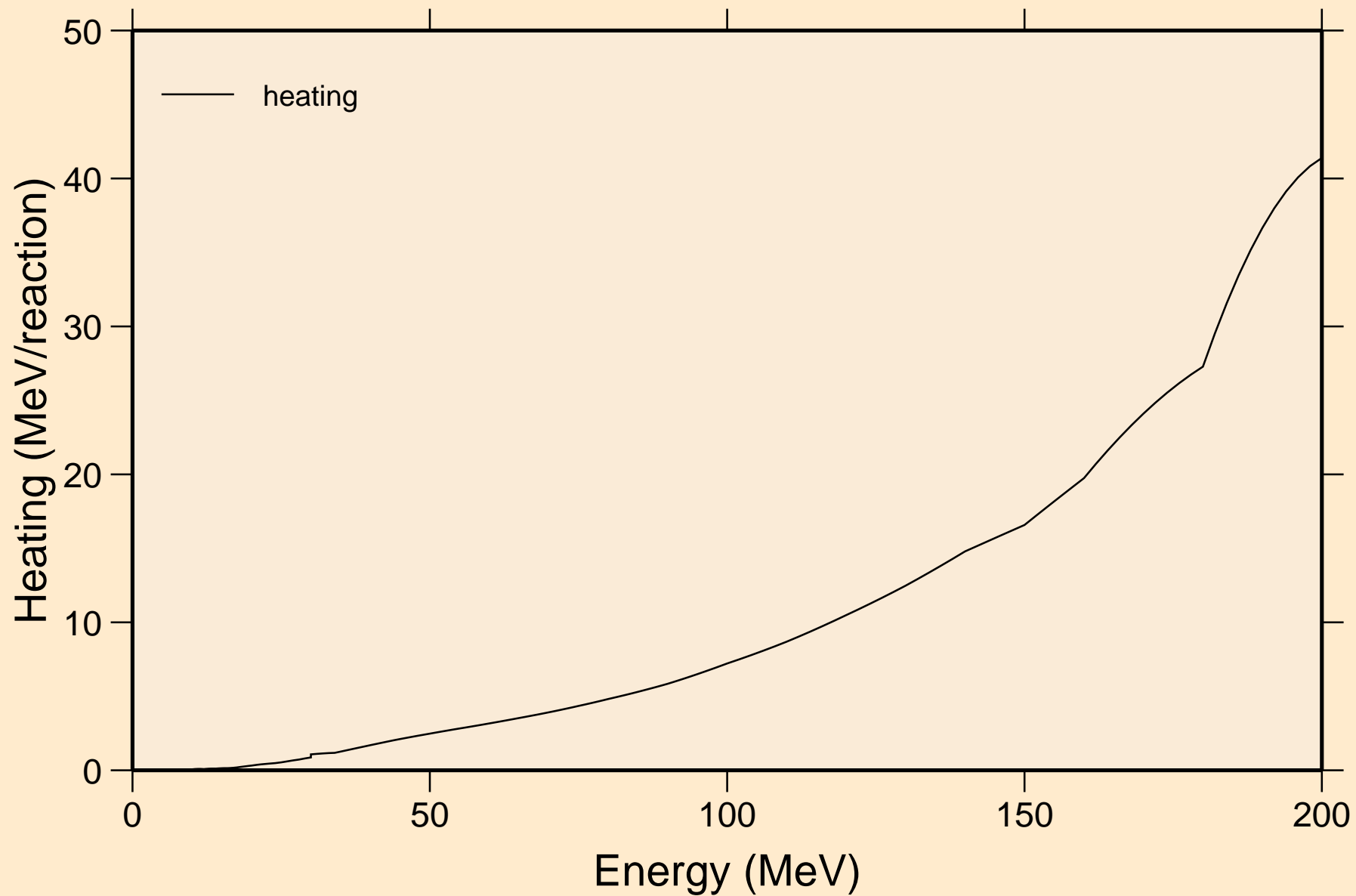

MAT=7722 ACE FILE PRODUCED AT NEA WITH NDEC
Damage

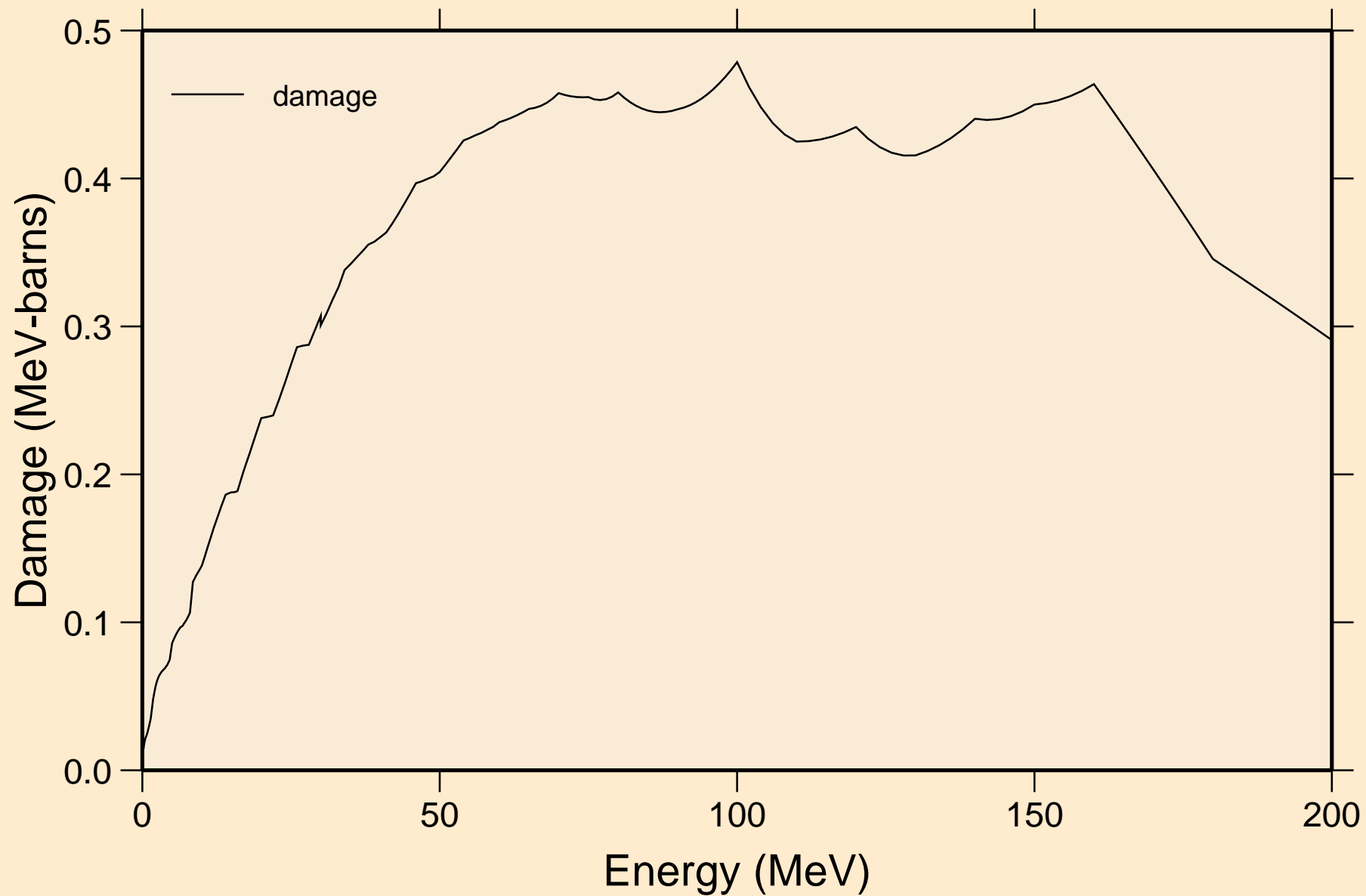

MAT=7722 ACE FILE PRODUCED AT NEA WITH NDEC
Non-threshold reactions

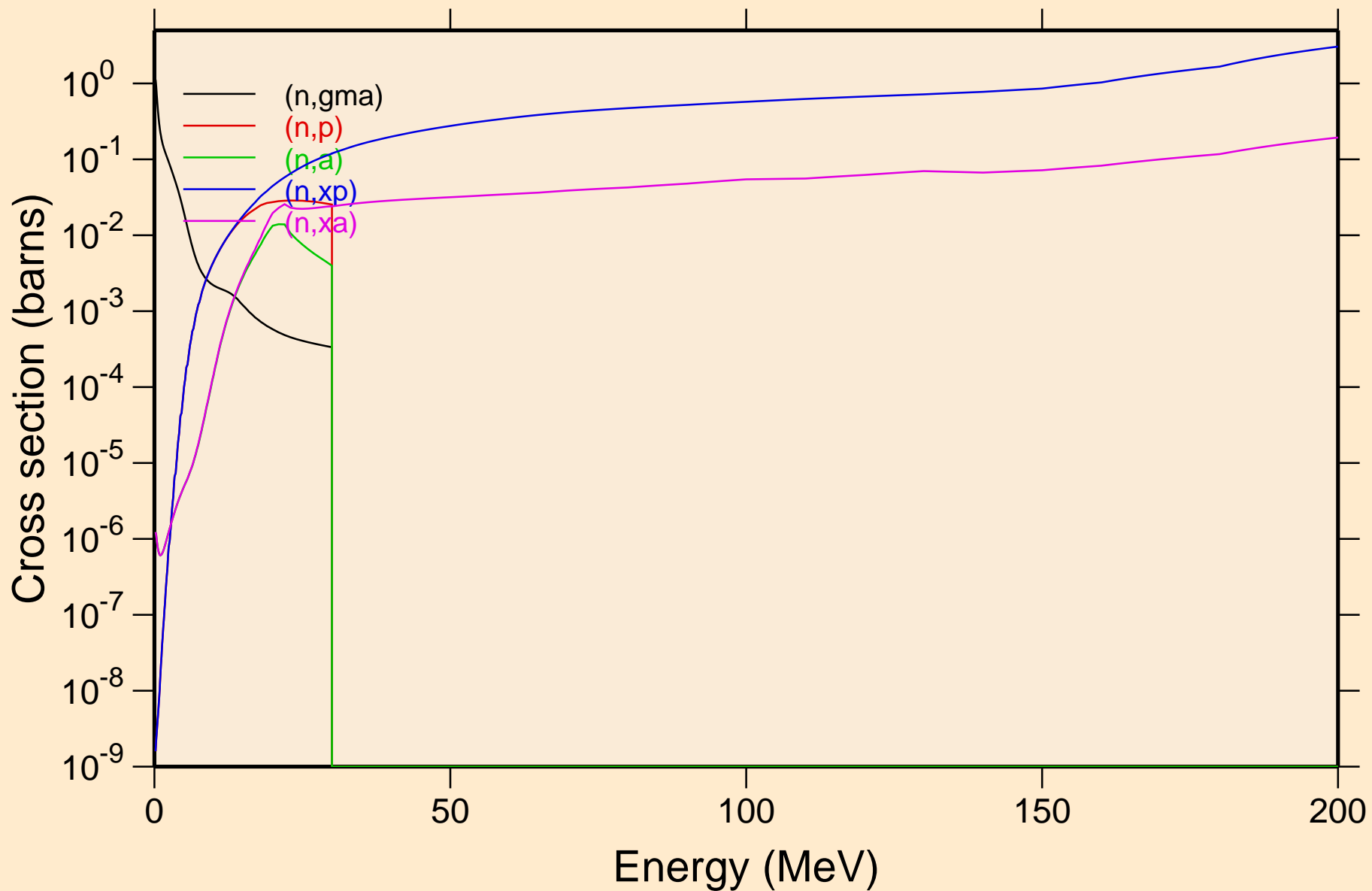

MAT=7722 ACE FILE PRODUCED AT NEA WITH NDEC
Inelastic levels

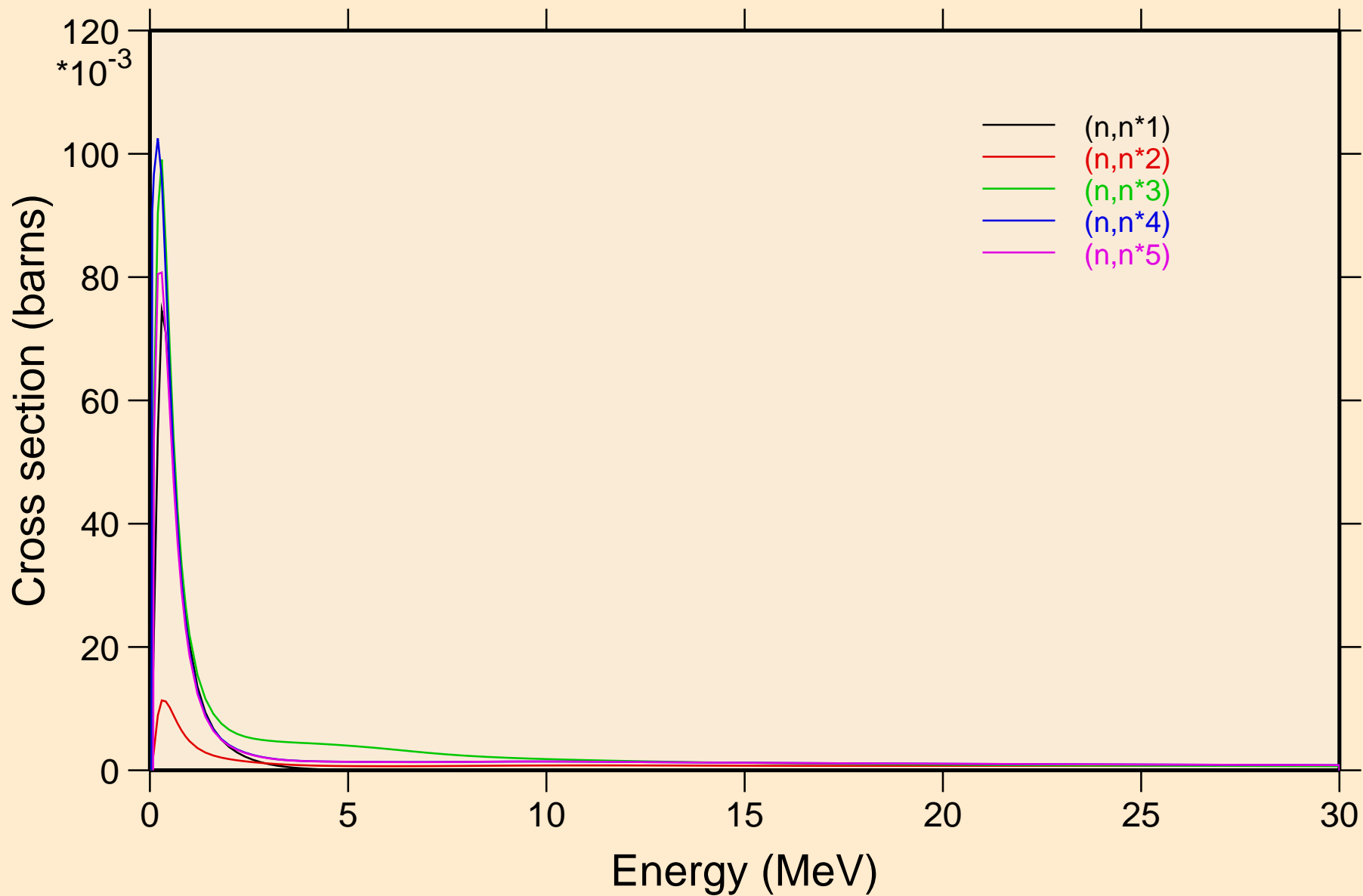

MAT=7722 ACE FILE PRODUCED AT NEA WITH NDEC
Inelastic levels

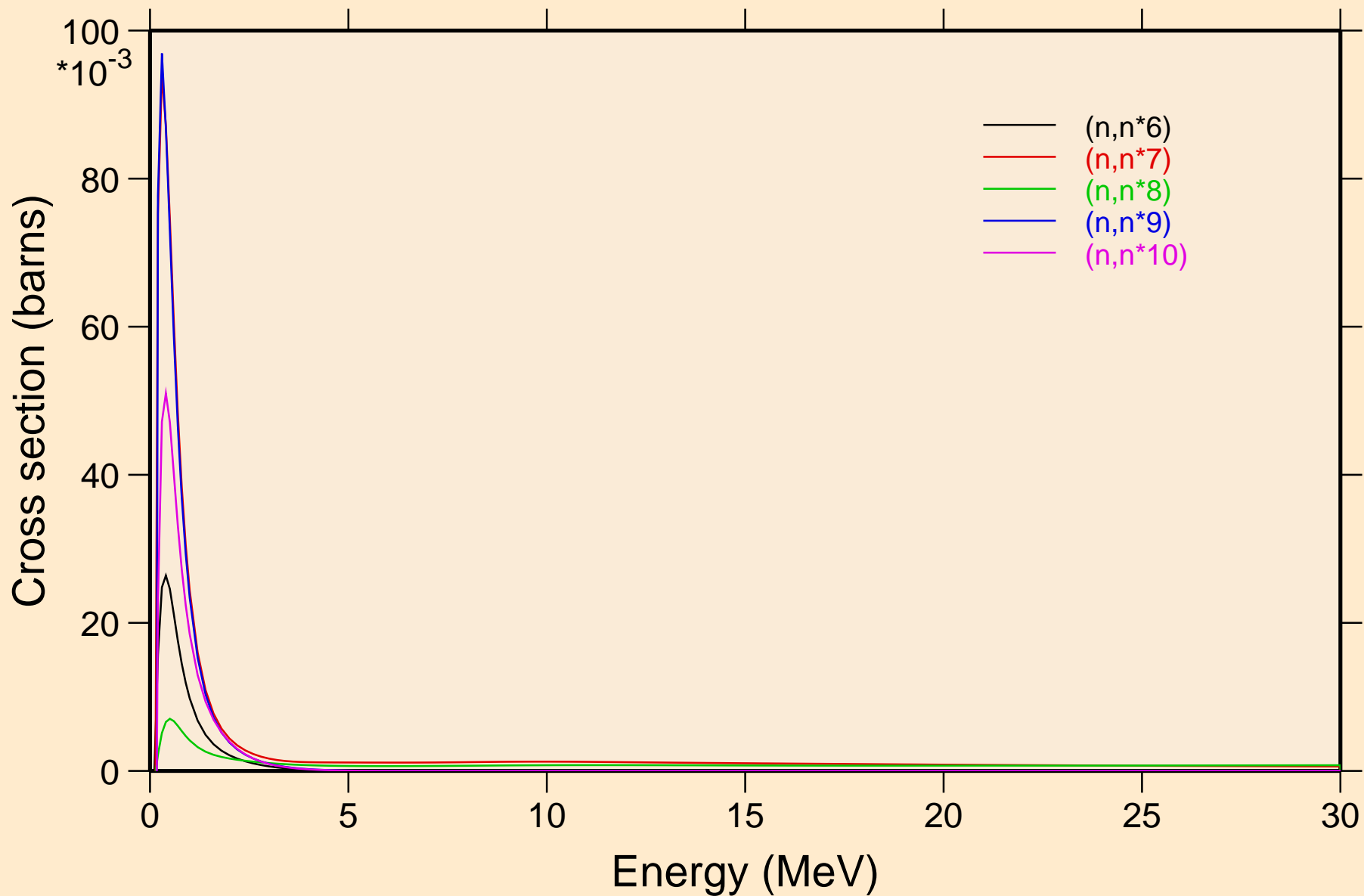

MAT=7722 ACE FILE PRODUCED AT NEA WITH NDEC
Inelastic levels

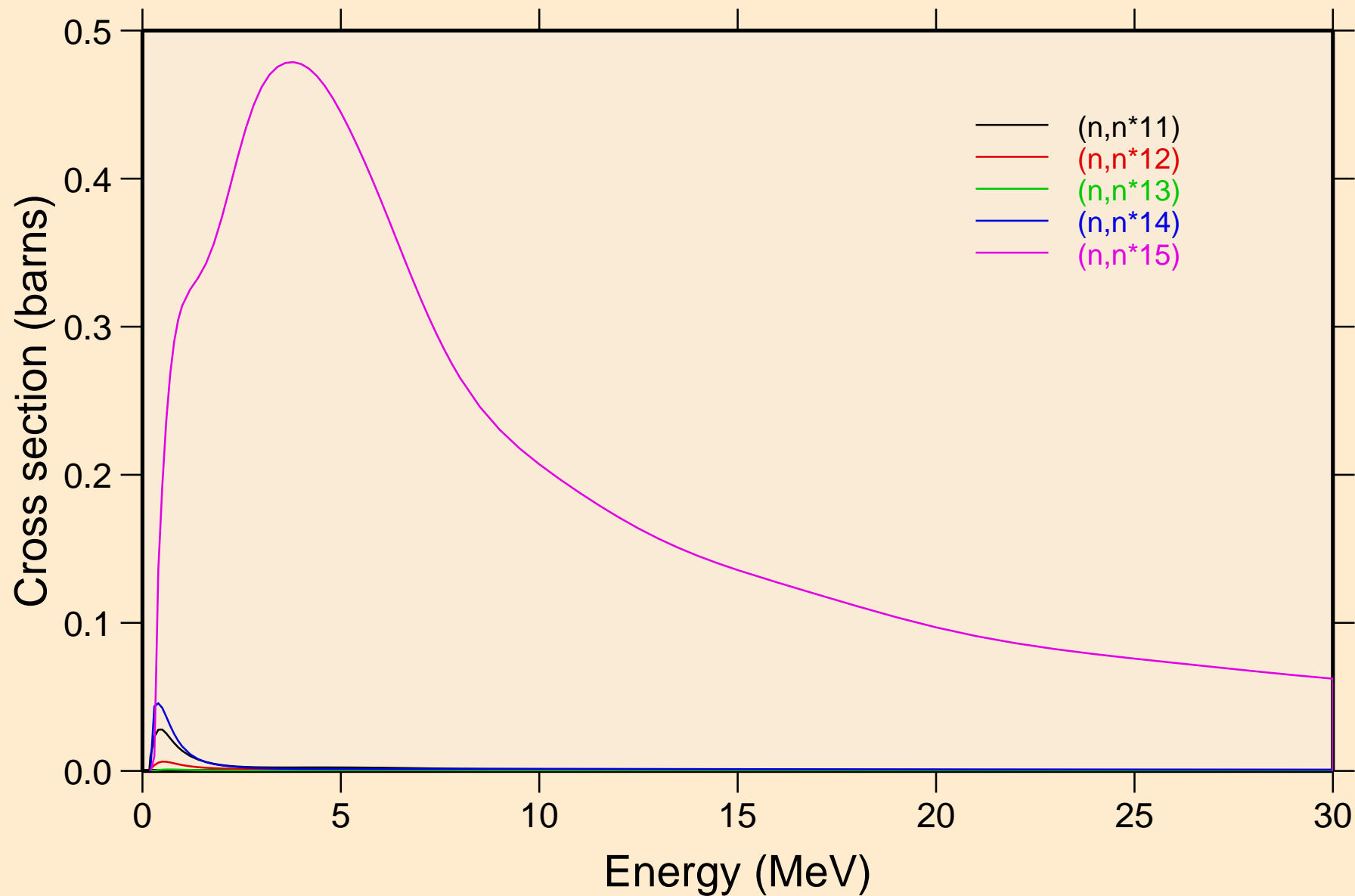

MAT=7722 ACE FILE PRODUCED AT NEA WITH NDEC
Inelastic levels

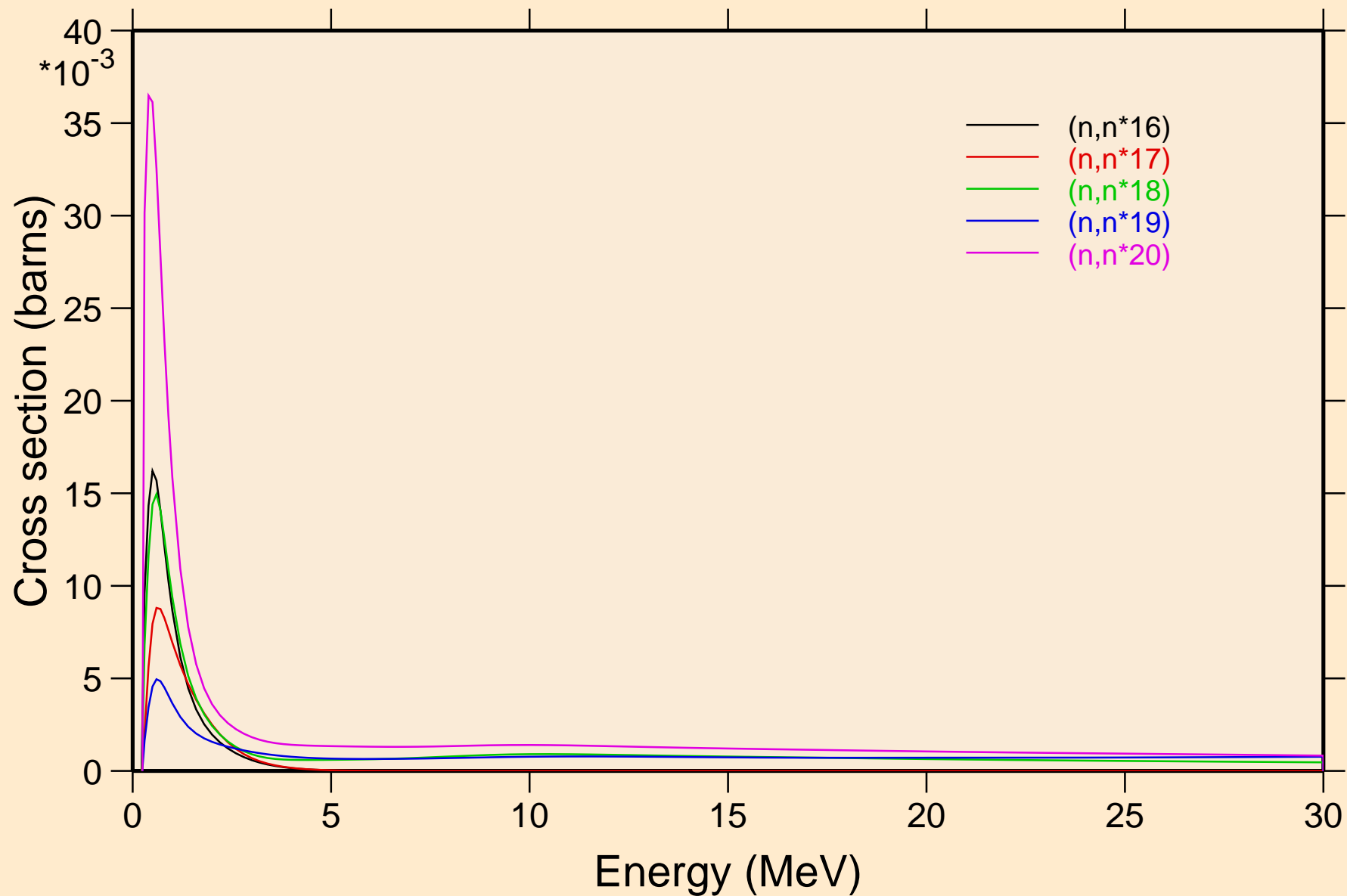

MAT=7722 ACE FILE PRODUCED AT NEA WITH NDEC
Inelastic levels

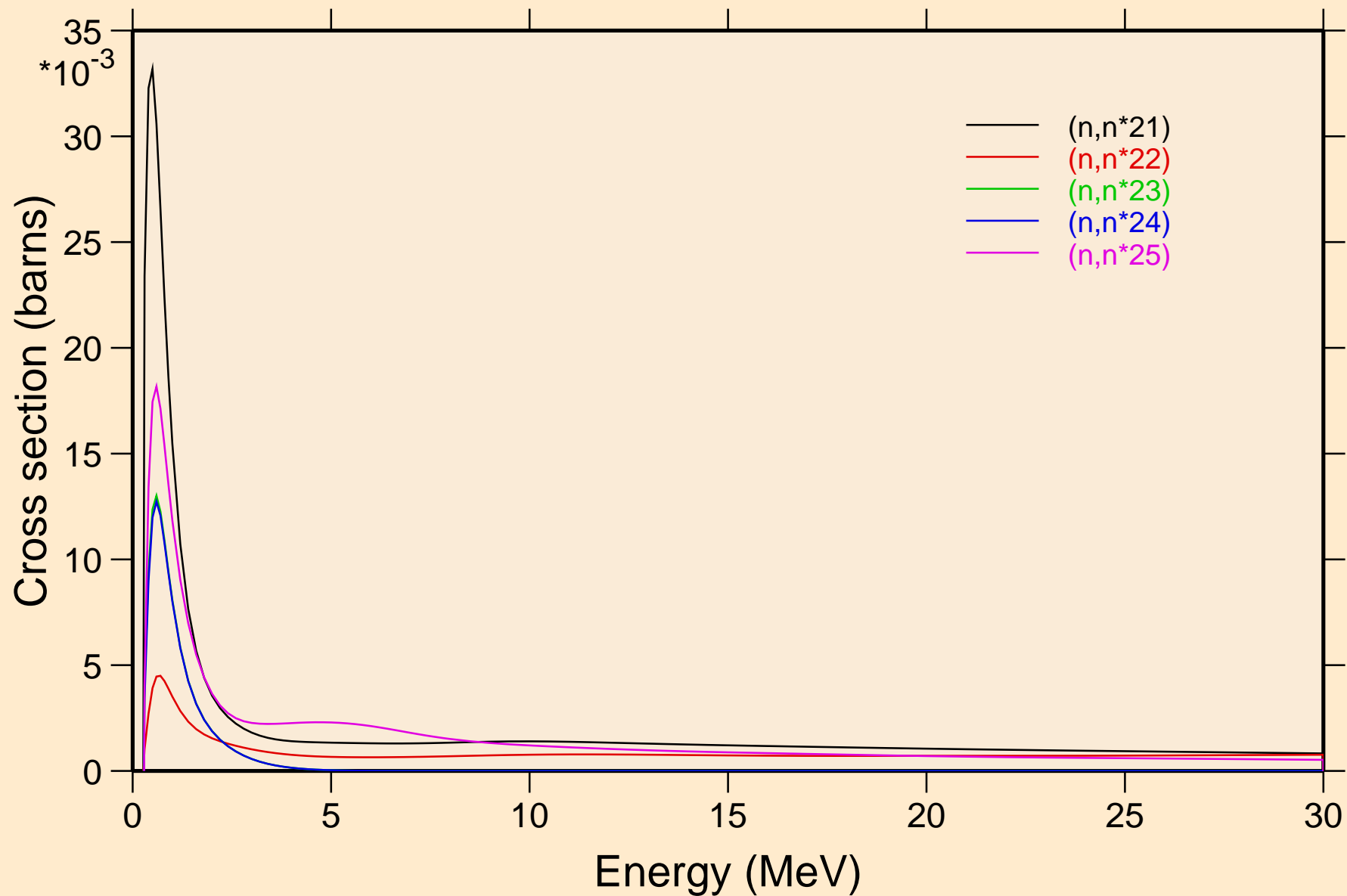

MAT=7722 ACE FILE PRODUCED AT NEA WITH NDEC
Inelastic levels

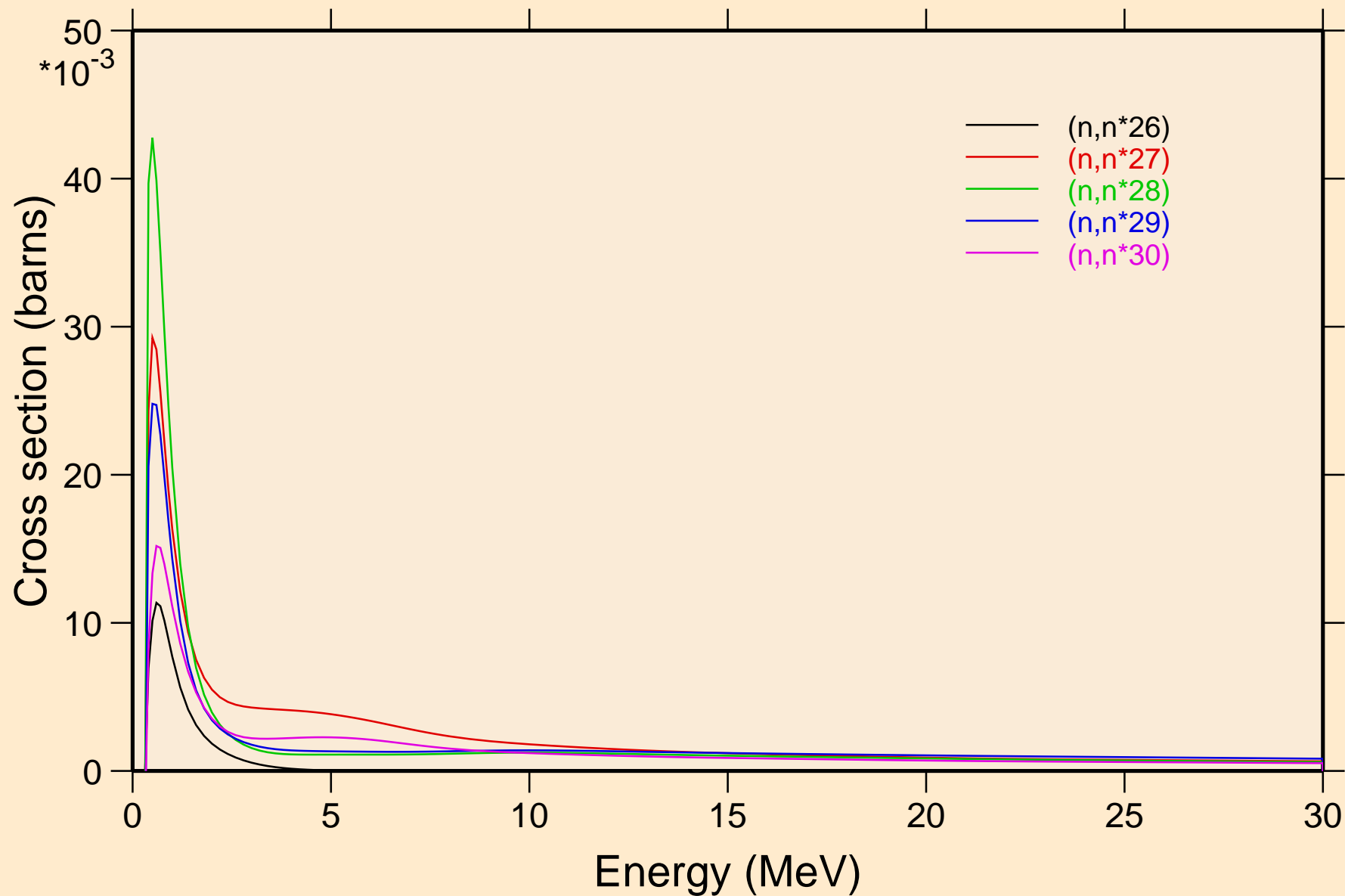

MAT=7722 ACE FILE PRODUCED AT NEA WITH NDEC
Threshold reactions

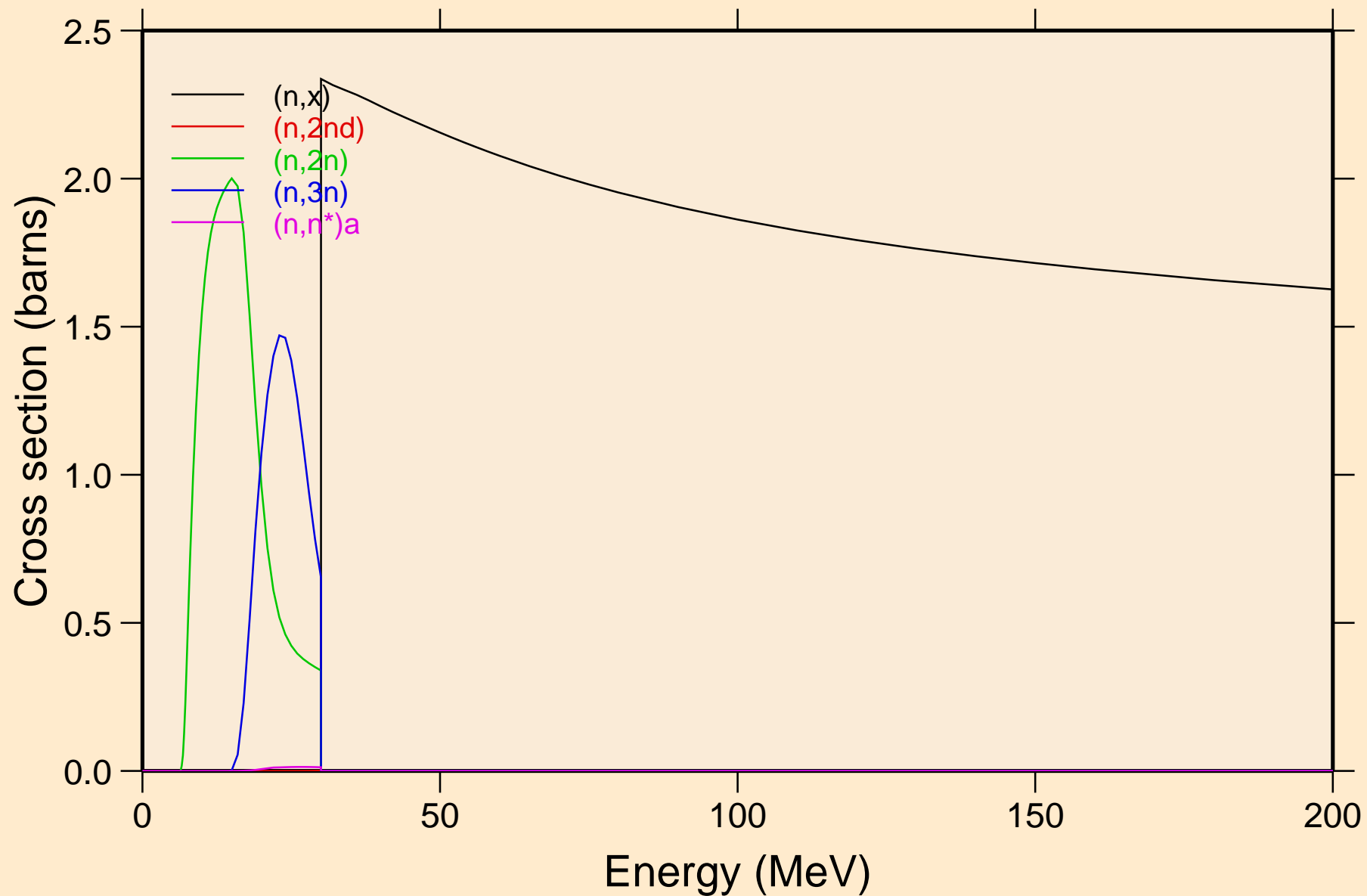

MAT=7722 ACE FILE PRODUCED AT NEA WITH NDEC
Threshold reactions

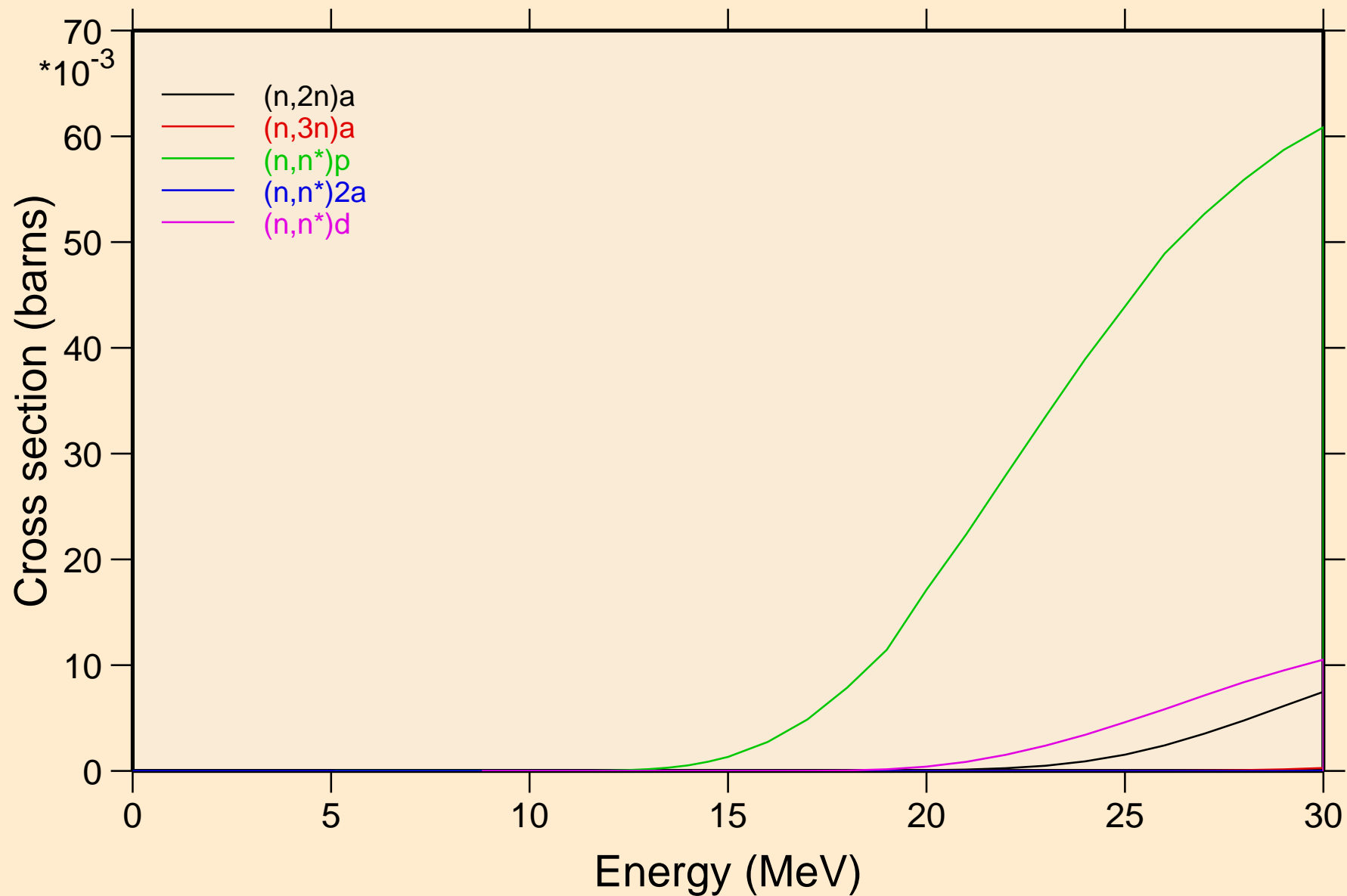

MAT=7722 ACE FILE PRODUCED AT NEA WITH NDEC
Threshold reactions

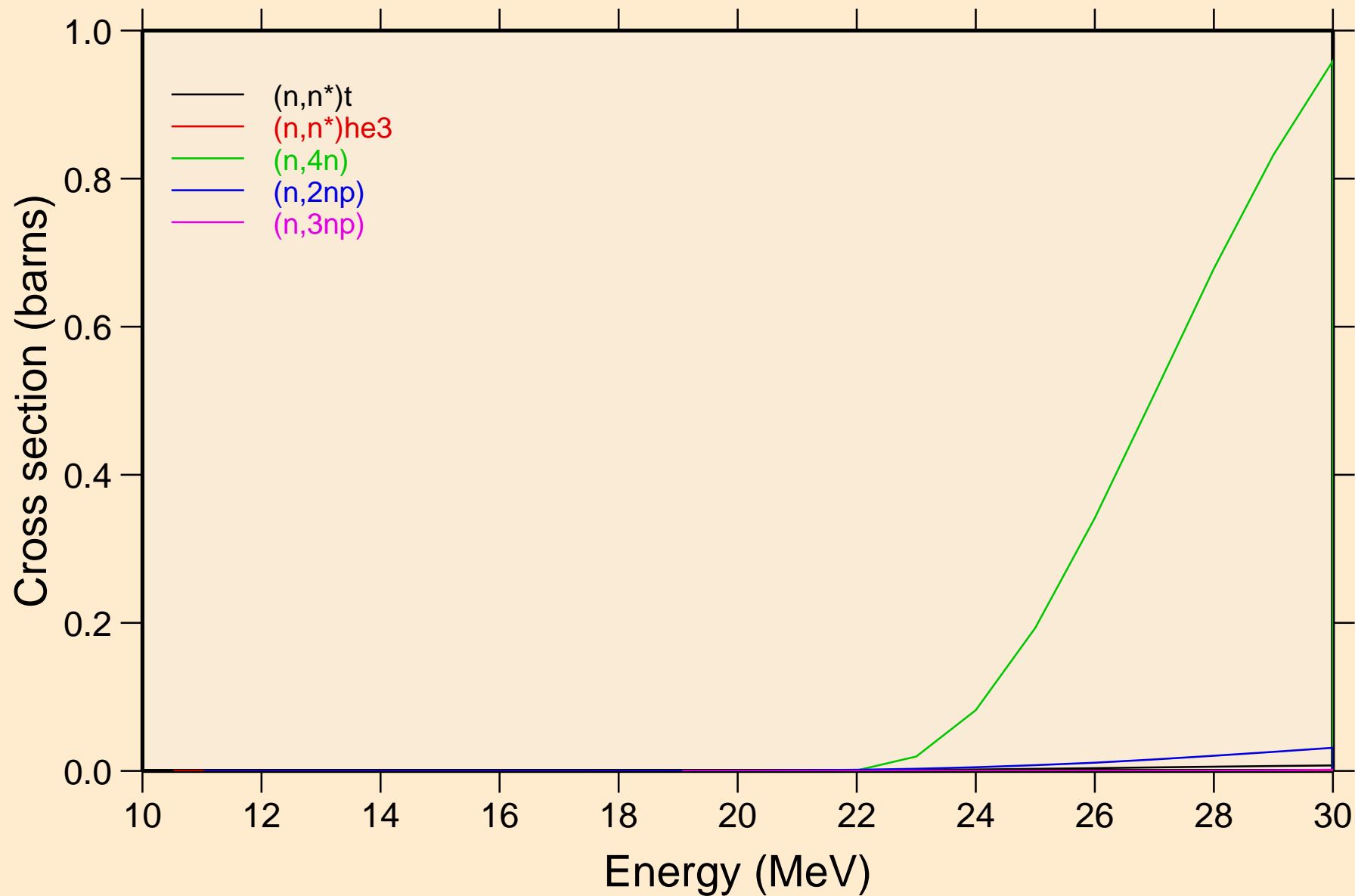

MAT=7722 ACE FILE PRODUCED AT NEA WITH NDEC
Threshold reactions

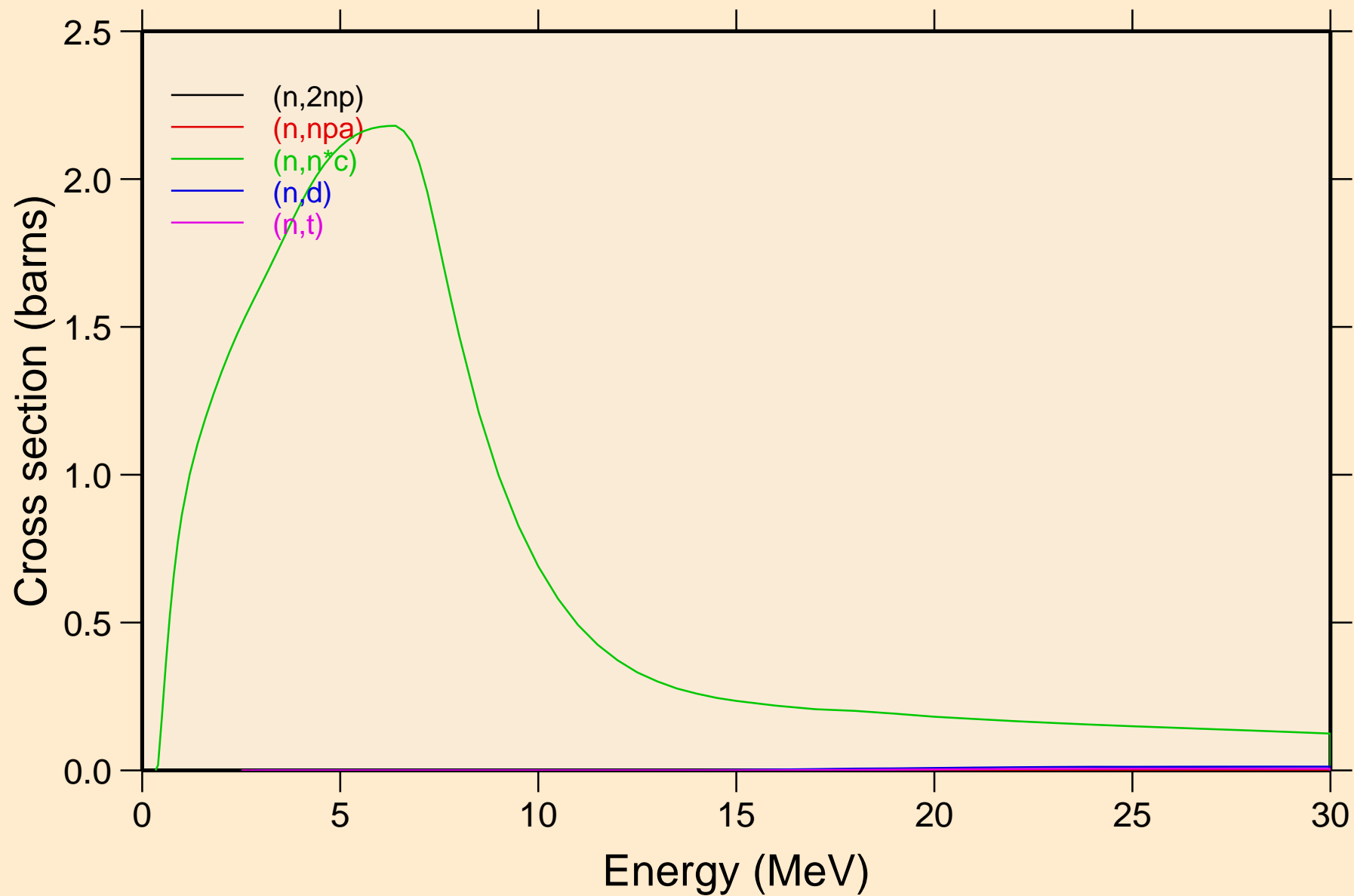

MAT=7722 ACE FILE PRODUCED AT NEA WITH NDEC
Threshold reactions

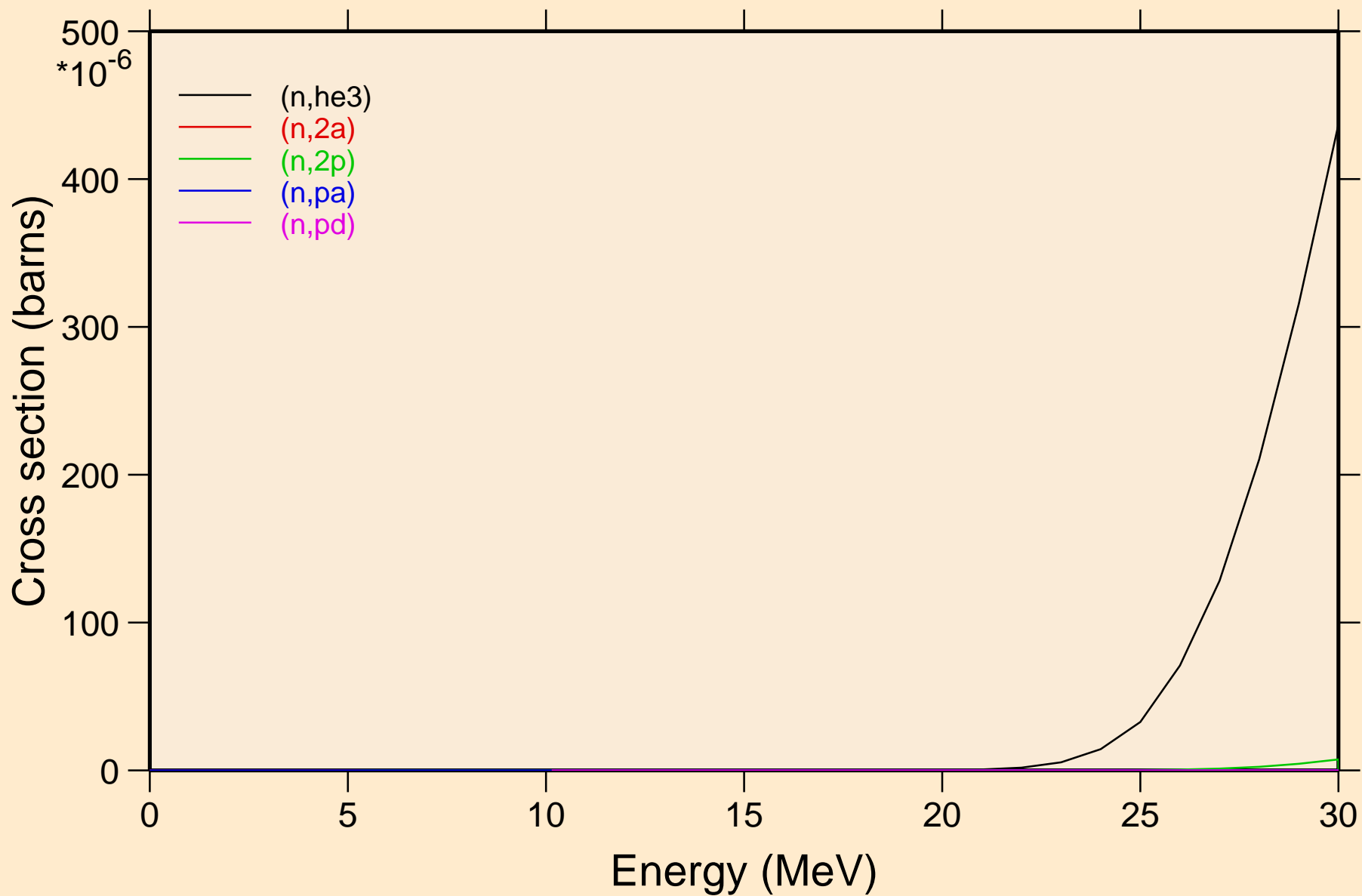

MAT=7722 ACE FILE PRODUCED AT NEA WITH NDEC
Threshold reactions

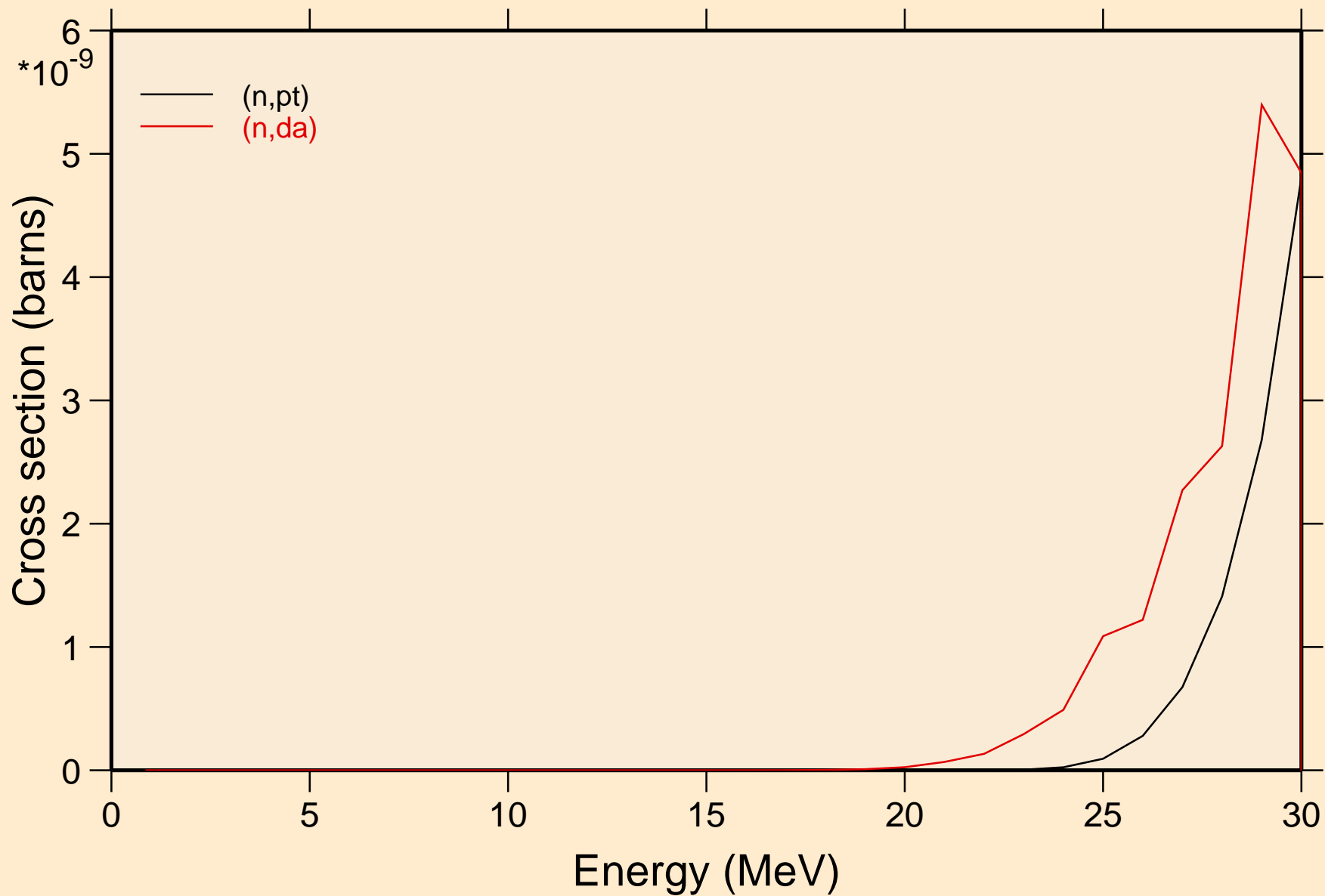

MAT=7722 ACE FILE PRODUCED AT NEA WITH NDEC
Threshold reactions

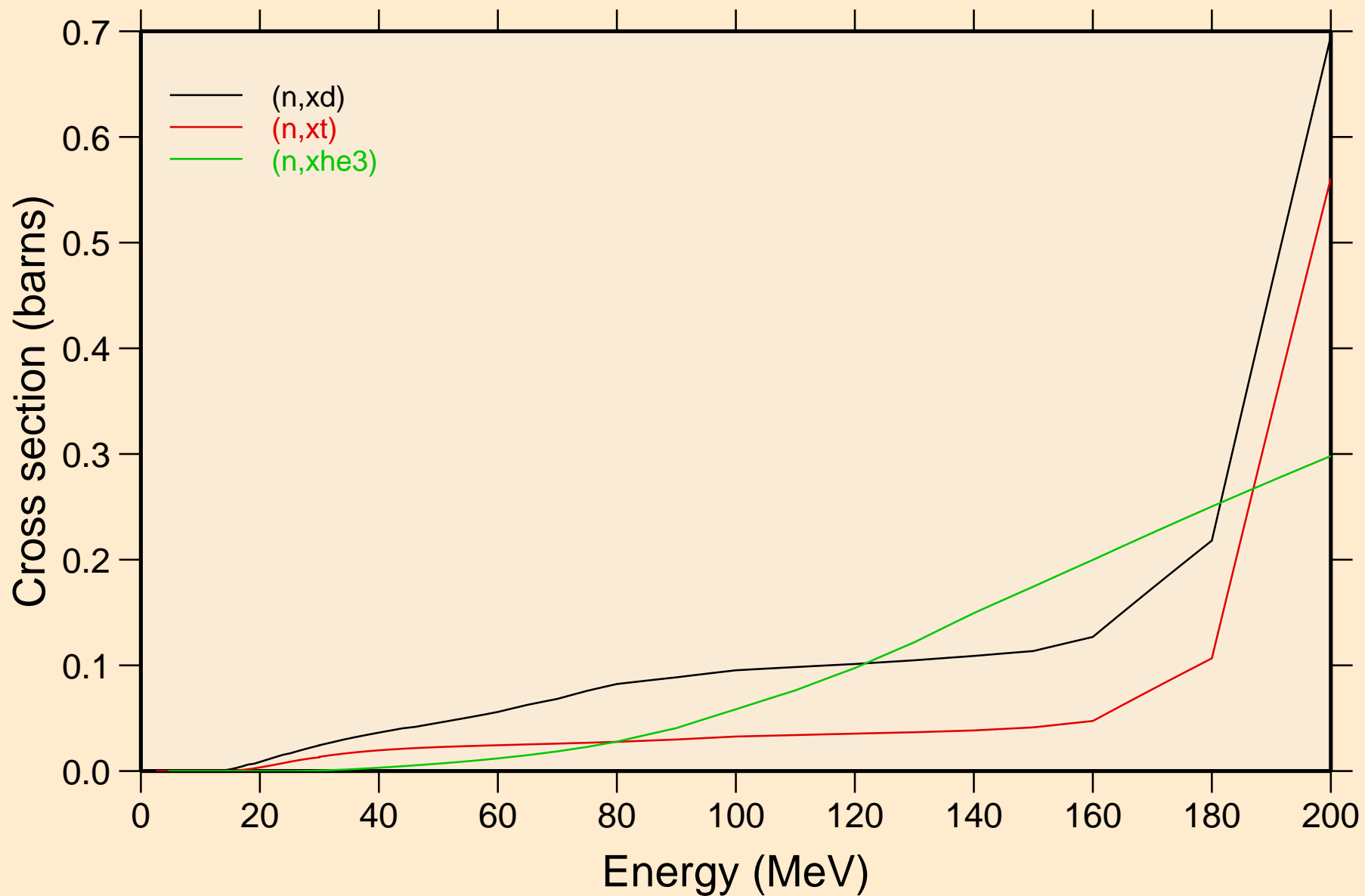

MAT=7722 ACE FILE PRODUCED AT NEA WITH NDEC
angular distribution for elastic

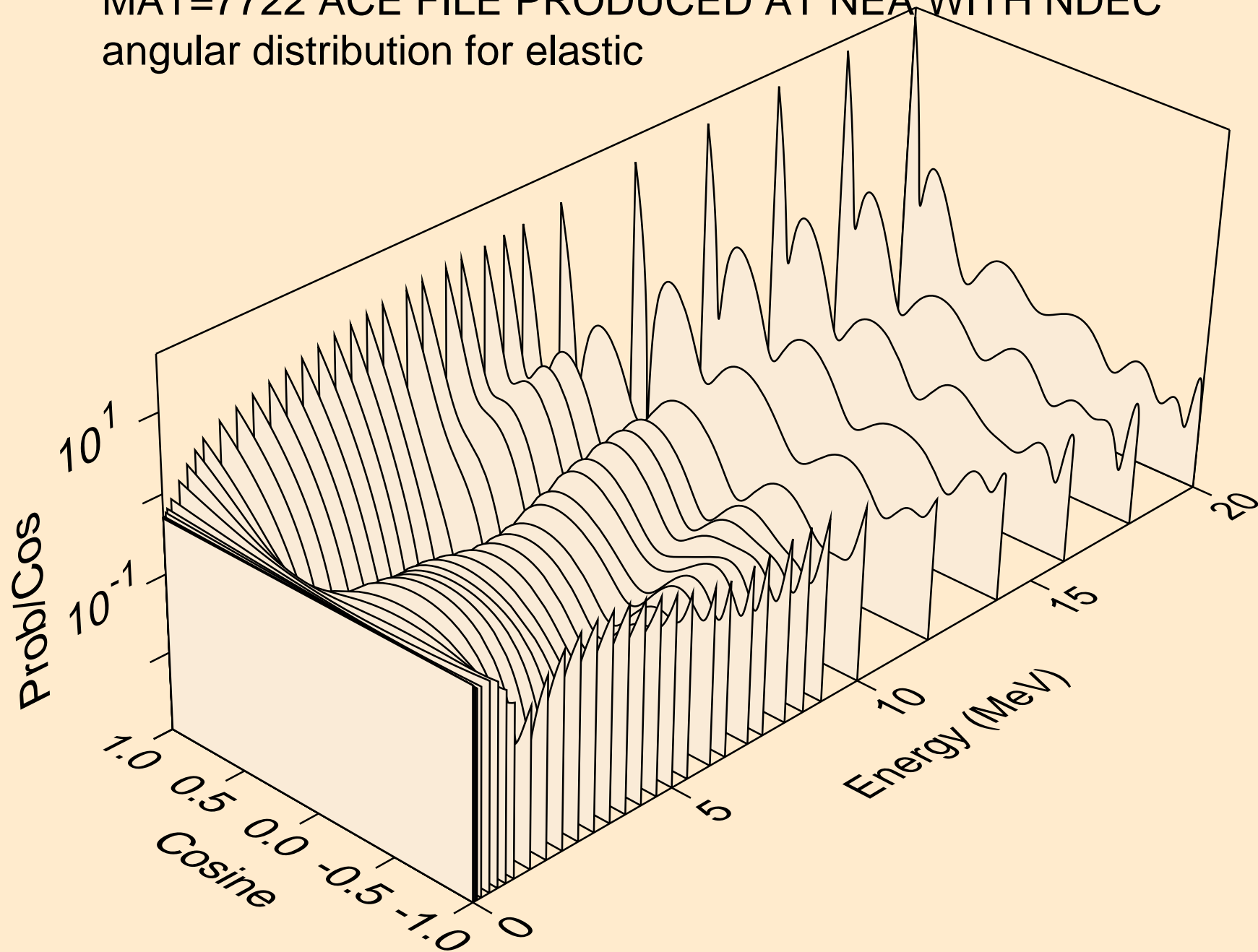

MAT=7722 ACE FILE PRODUCED AT NEA WITH NDEC
angular distribution for elastic

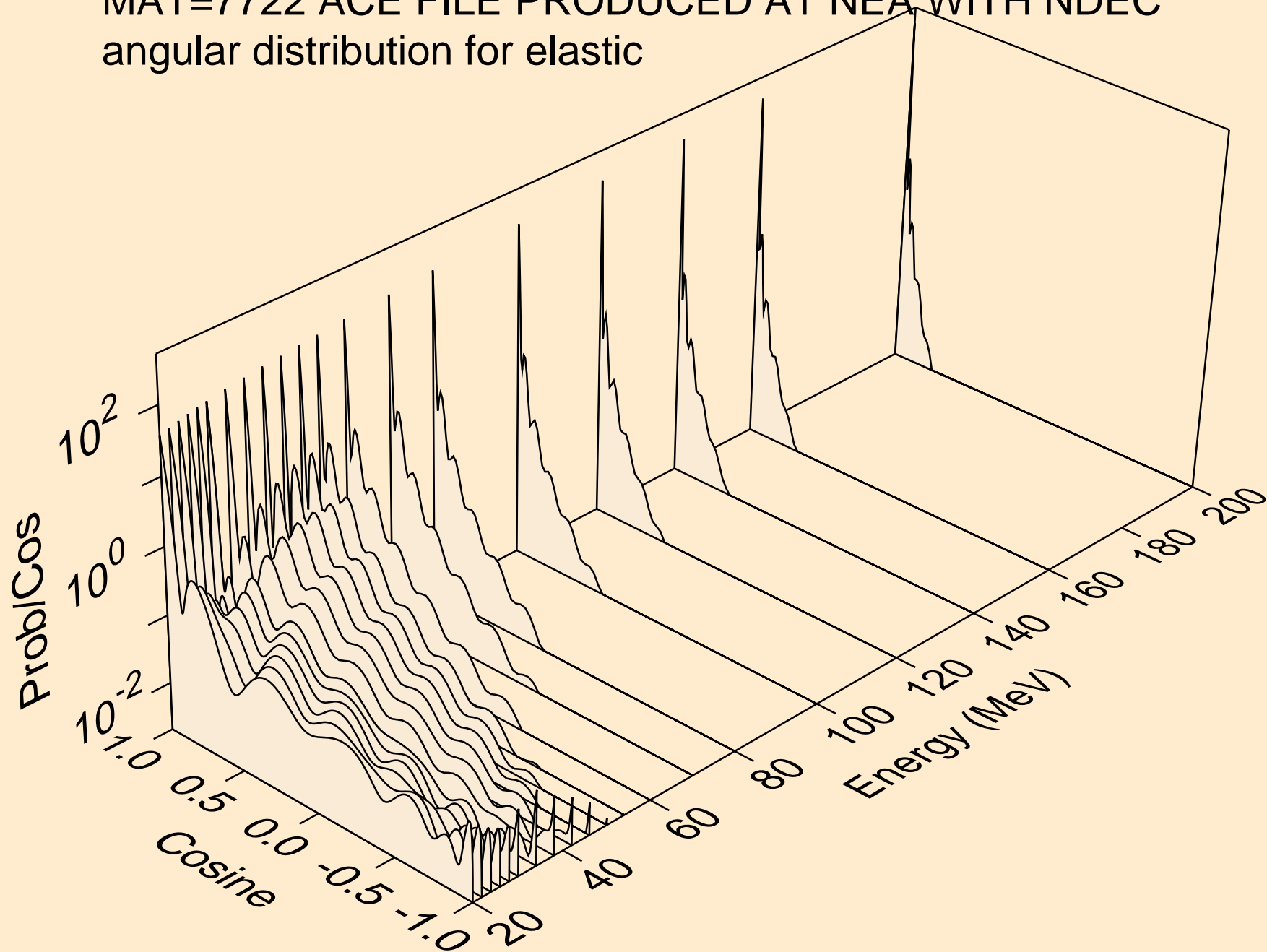

MAT=7722 ACE FILE PRODUCED AT NEA WITH NDEC
angular distribution for (n,n*1)

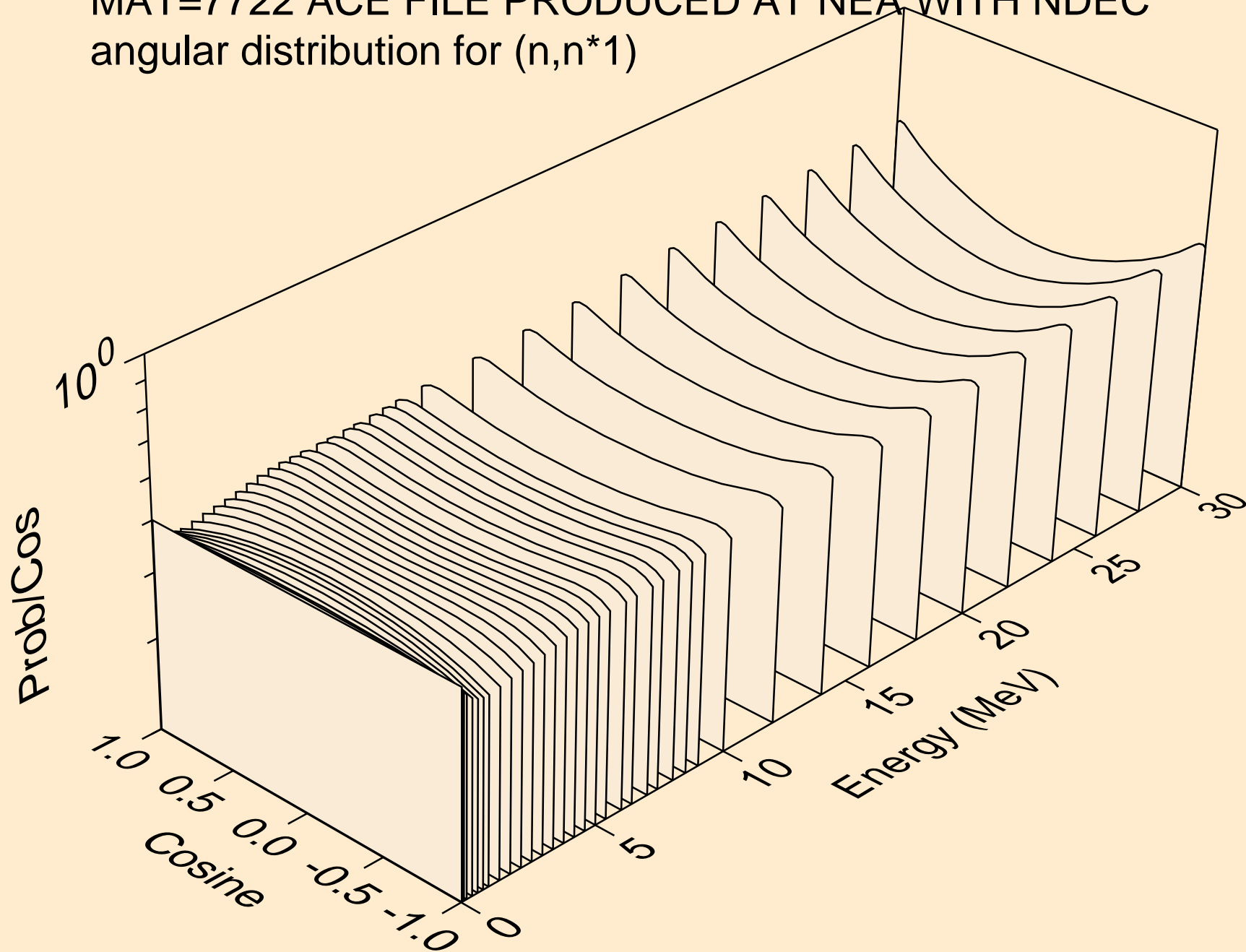

MAT=7722 ACE FILE PRODUCED AT NEA WITH NDEC
angular distribution for (n,n*2)

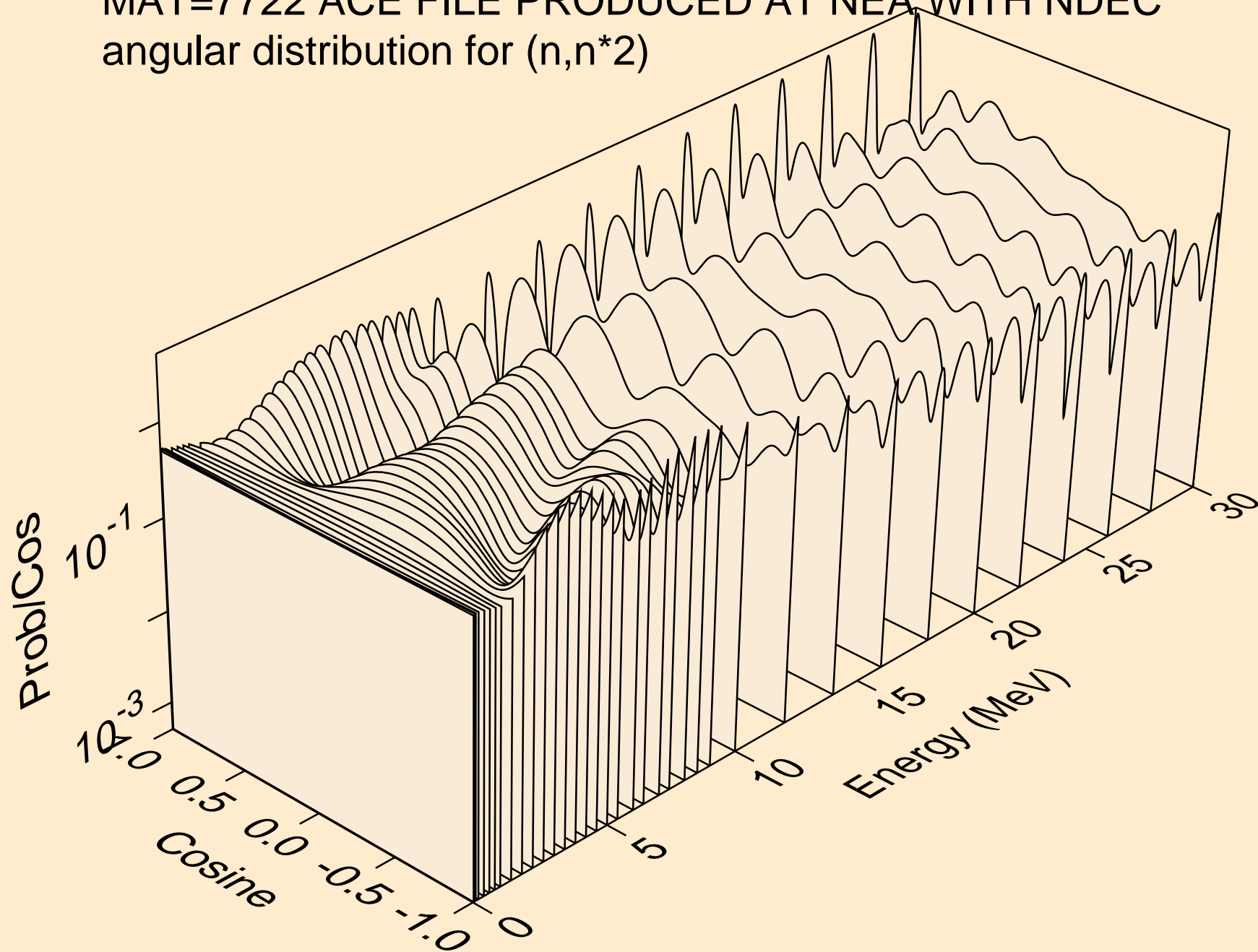

MAT=7722 ACE FILE PRODUCED AT NEA WITH NDEC
angular distribution for (n,n*3)

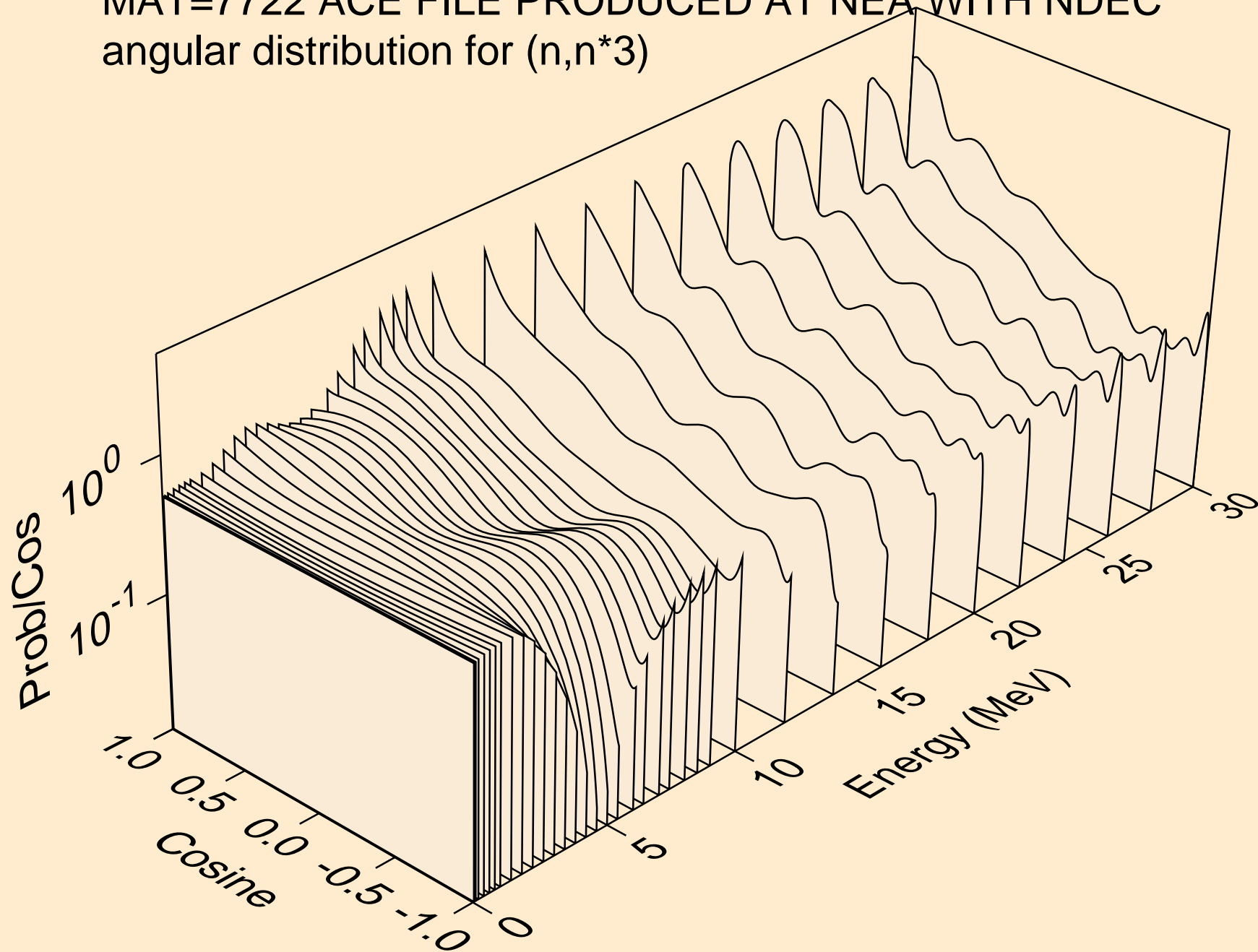

MAT=7722 ACE FILE PRODUCED AT NEA WITH NDEC
angular distribution for (n,n*4)

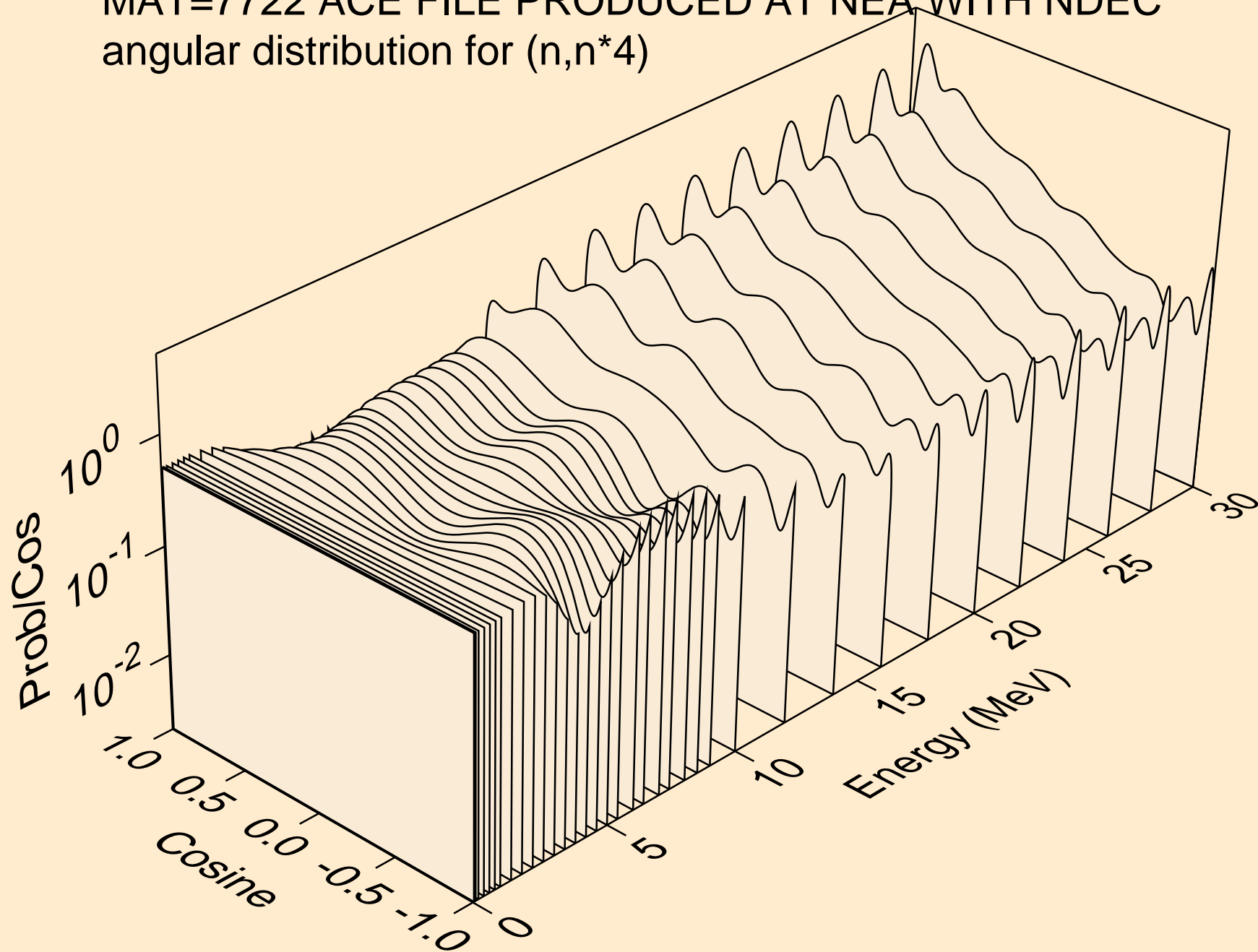

MAT=7722 ACE FILE PRODUCED AT NEA WITH NDEC
angular distribution for (n,n*5)

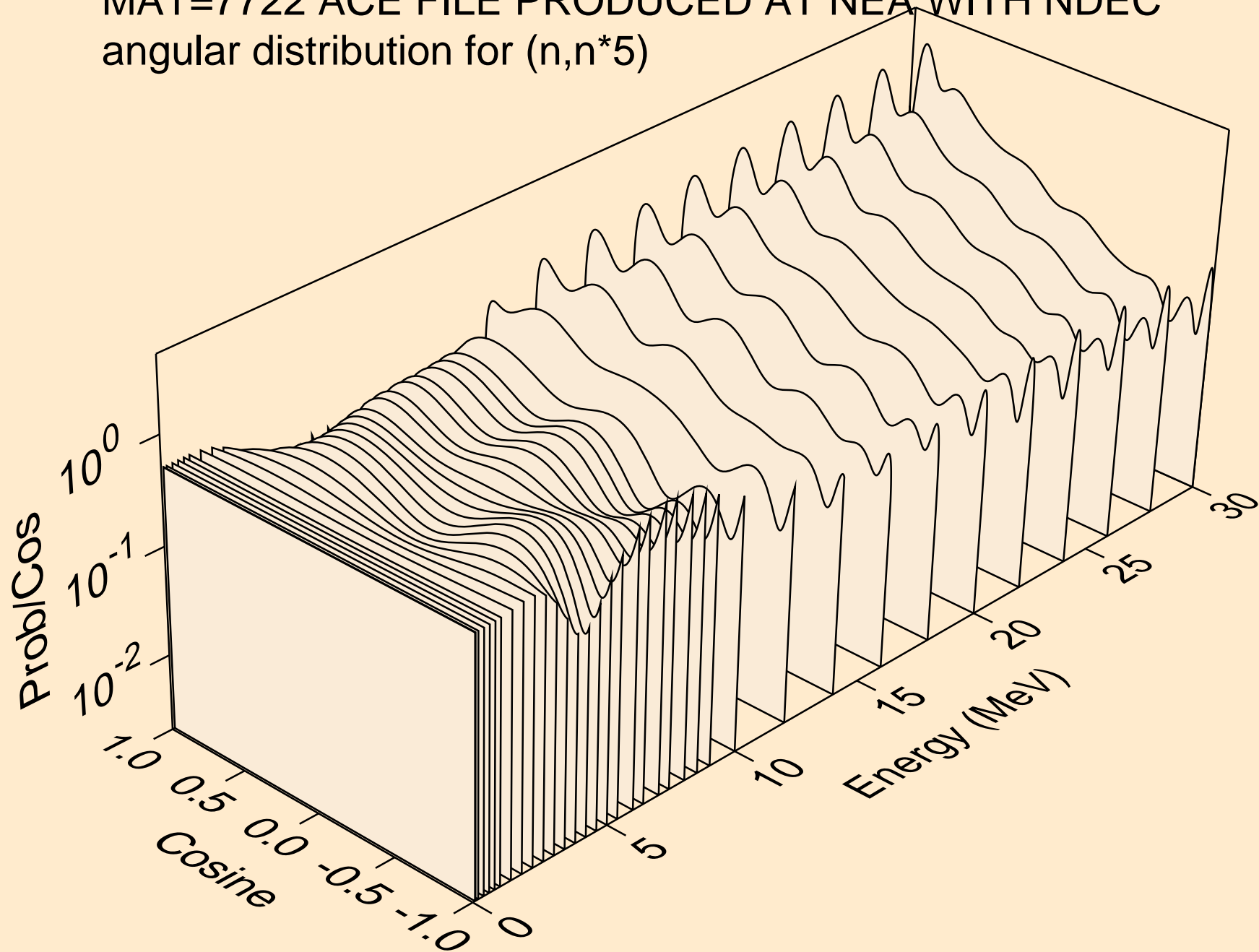

MAT=7722 ACE FILE PRODUCED AT NEA WITH NDEC
angular distribution for (n,n*6)

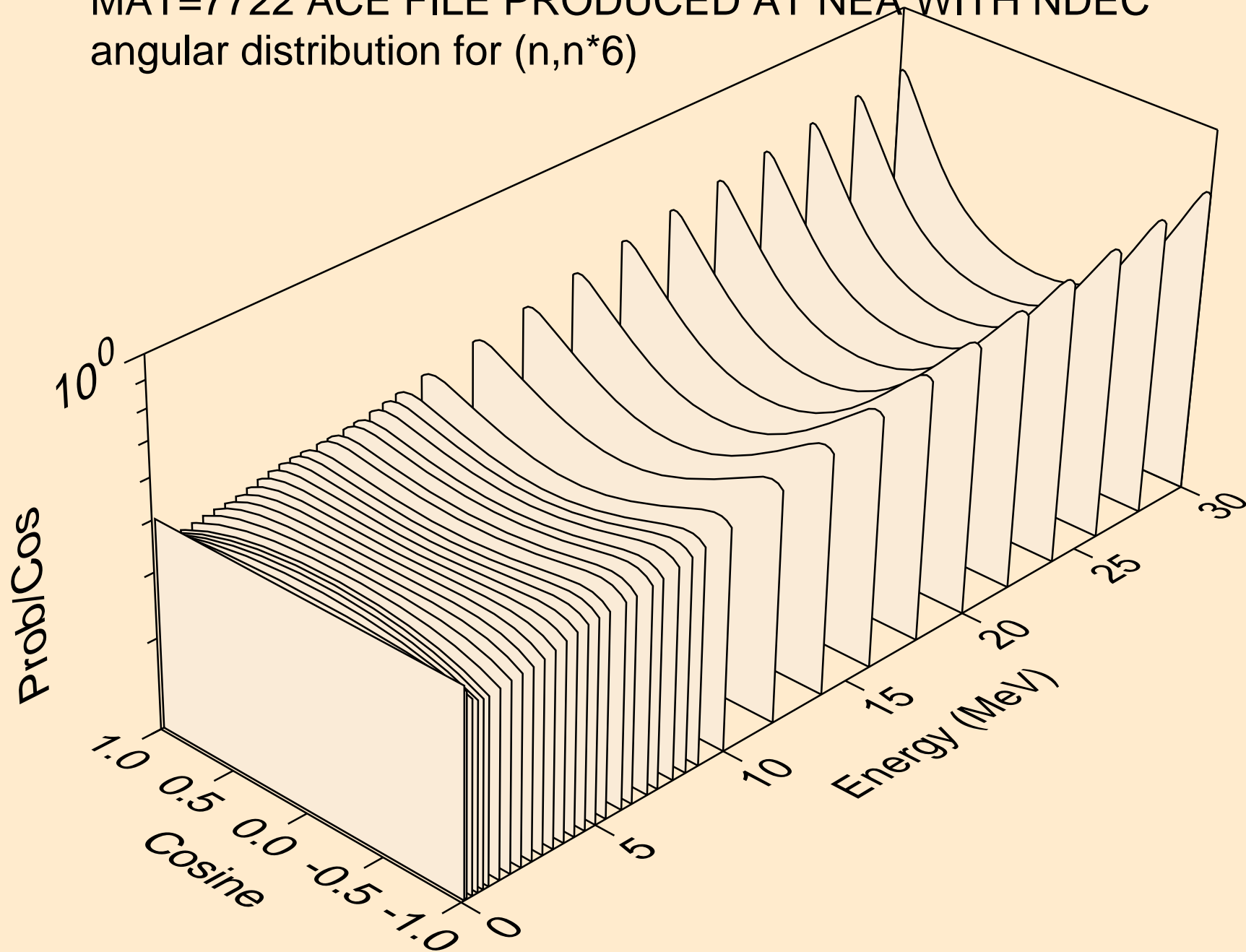

MAT=7722 ACE FILE PRODUCED AT NEA WITH NDEC
angular distribution for (n,n*7)

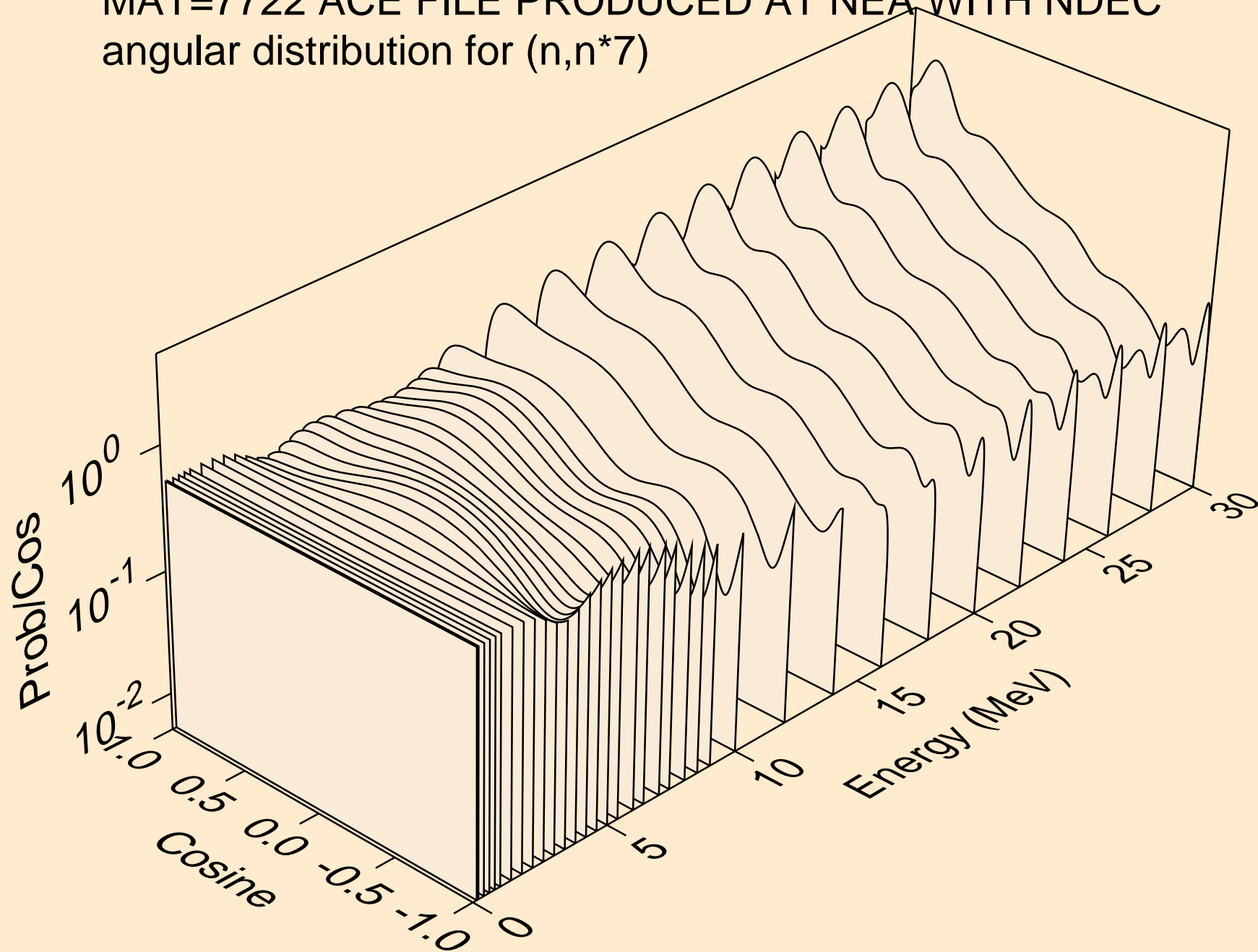

MAT=7722 ACE FILE PRODUCED AT NEA WITH NDEC
angular distribution for (n,n*8)

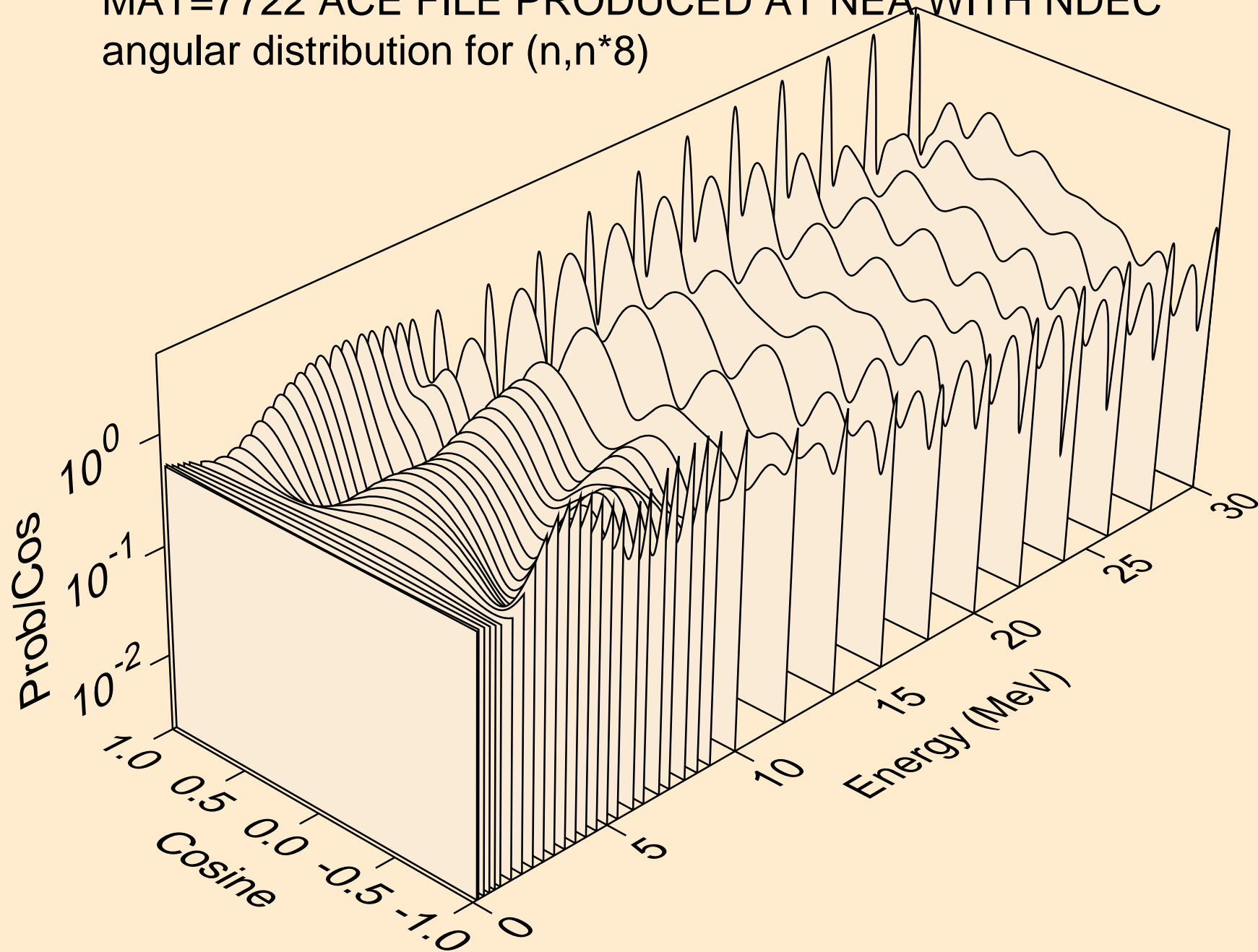

MAT=7722 ACE FILE PRODUCED AT NEA WITH NDEC
angular distribution for (n,n*9)

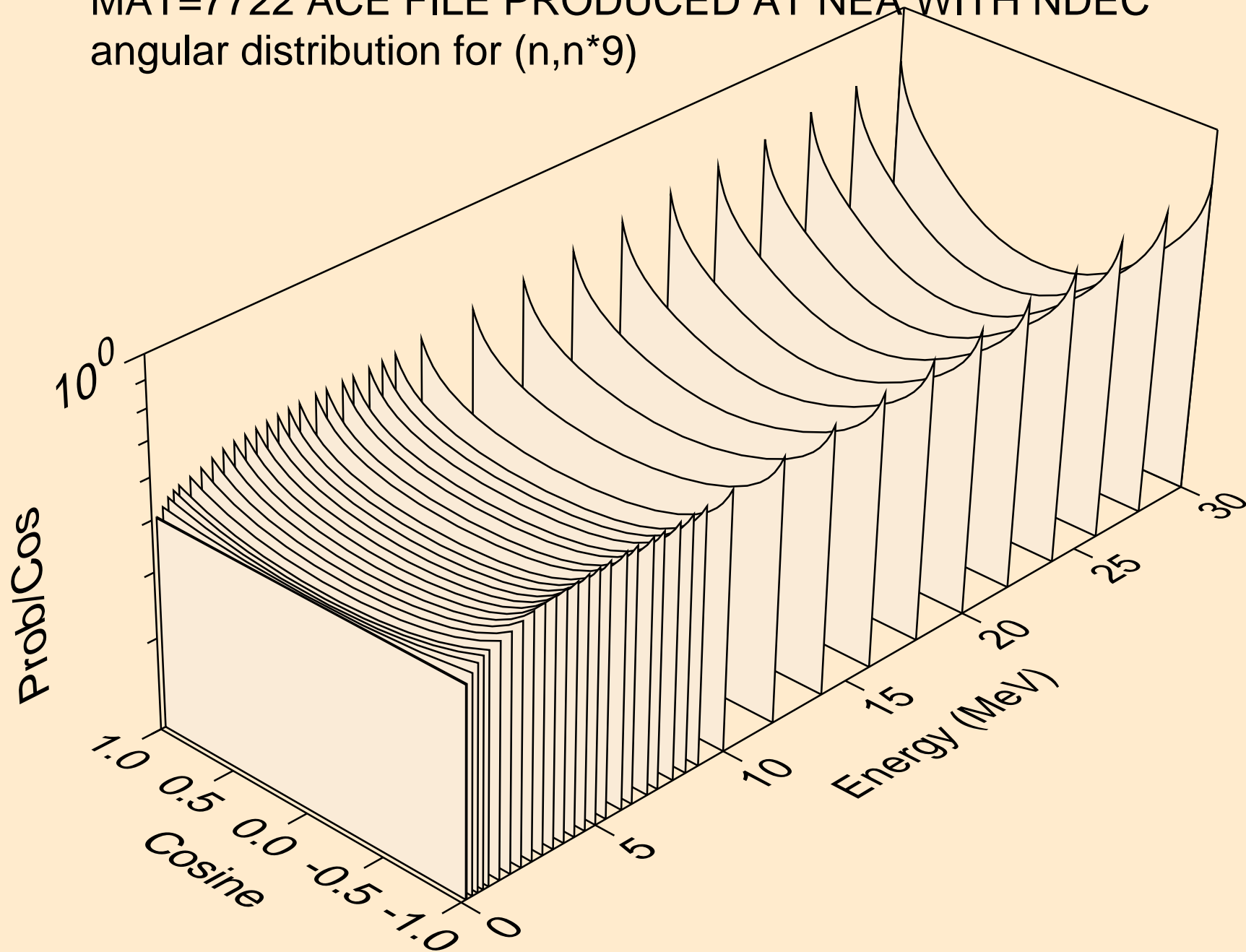

MAT=7722 ACE FILE PRODUCED AT NEA WITH NDEC
angular distribution for (n,n*10)

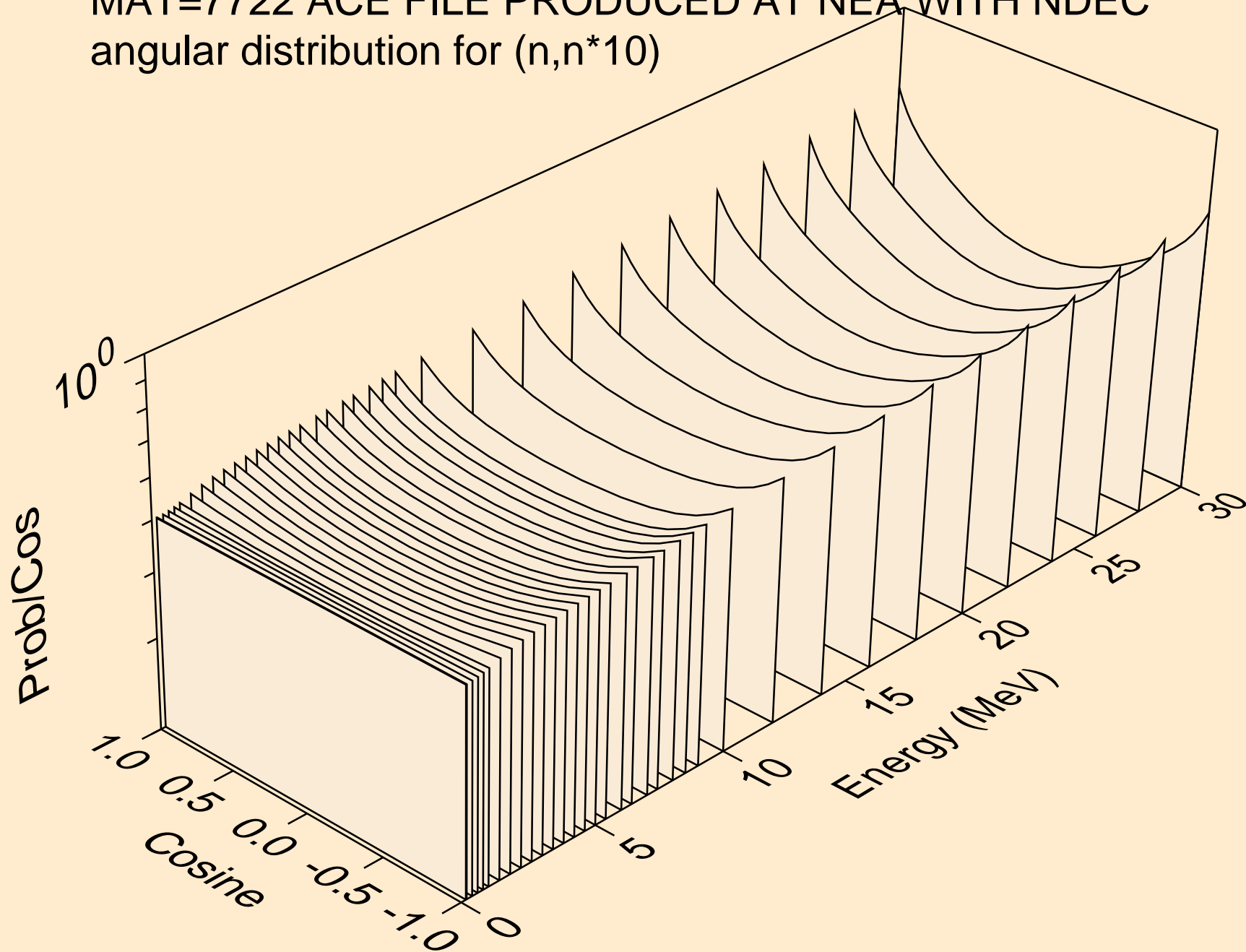

MAT=7722 ACE FILE PRODUCED AT NEA WITH NDEC
angular distribution for (n,n*11)

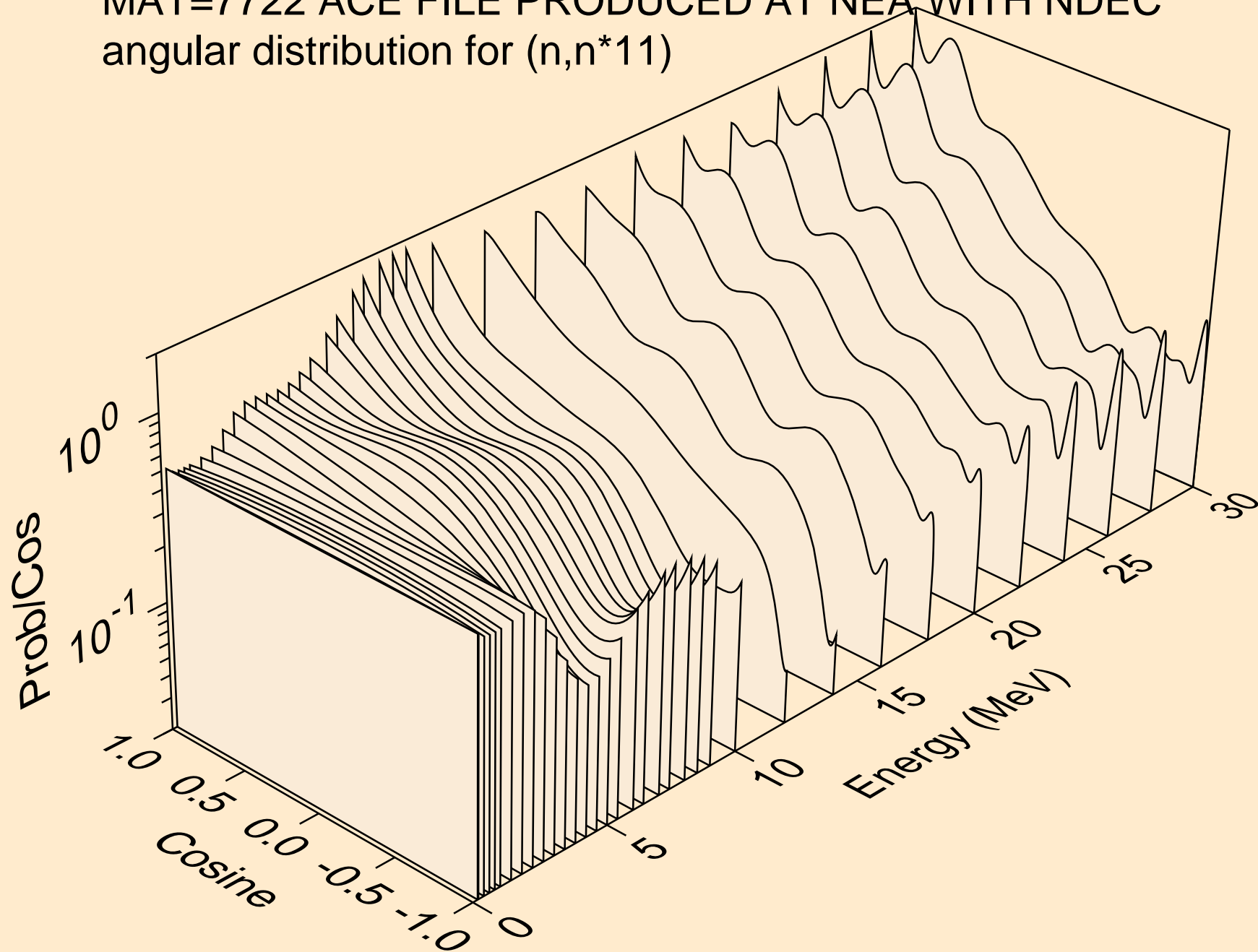

MAT=7722 ACE FILE PRODUCED AT NEA WITH NDEC
angular distribution for (n,n*12)

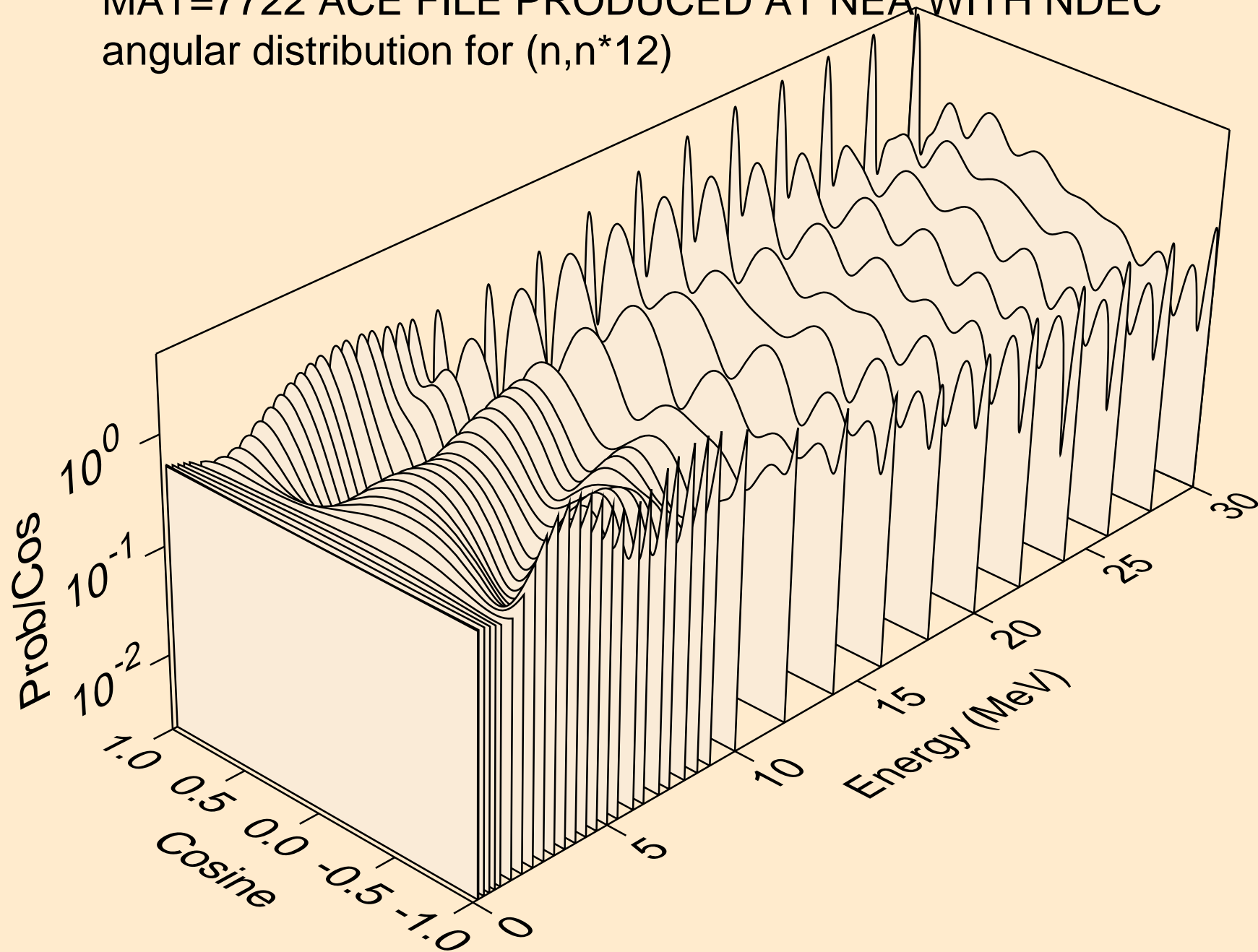

MAT=7722 ACE FILE PRODUCED AT NEA WITH NDEC
angular distribution for (n,n*13)

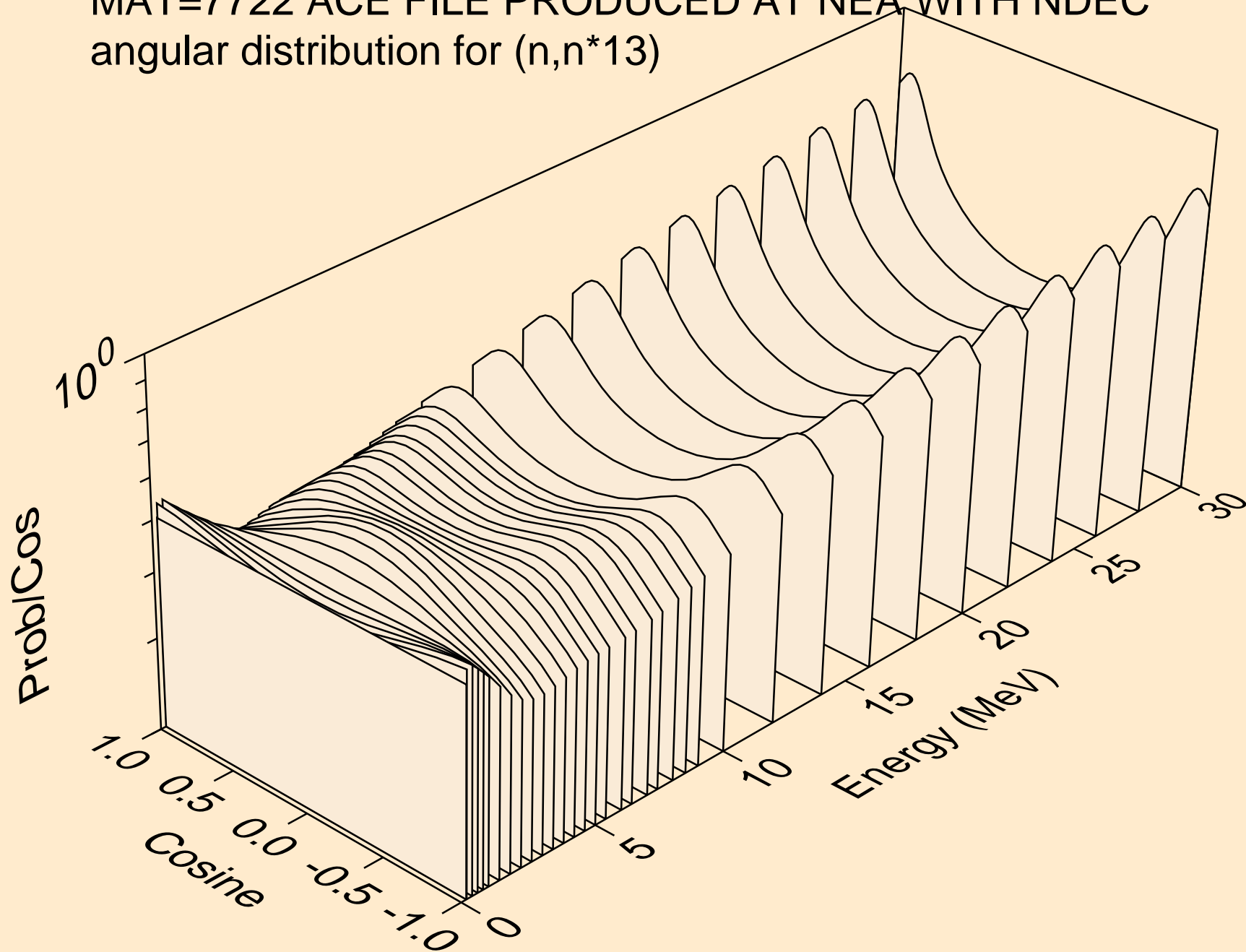

MAT=7722 ACE FILE PRODUCED AT NEA WITH NDEC
angular distribution for (n,n*14)

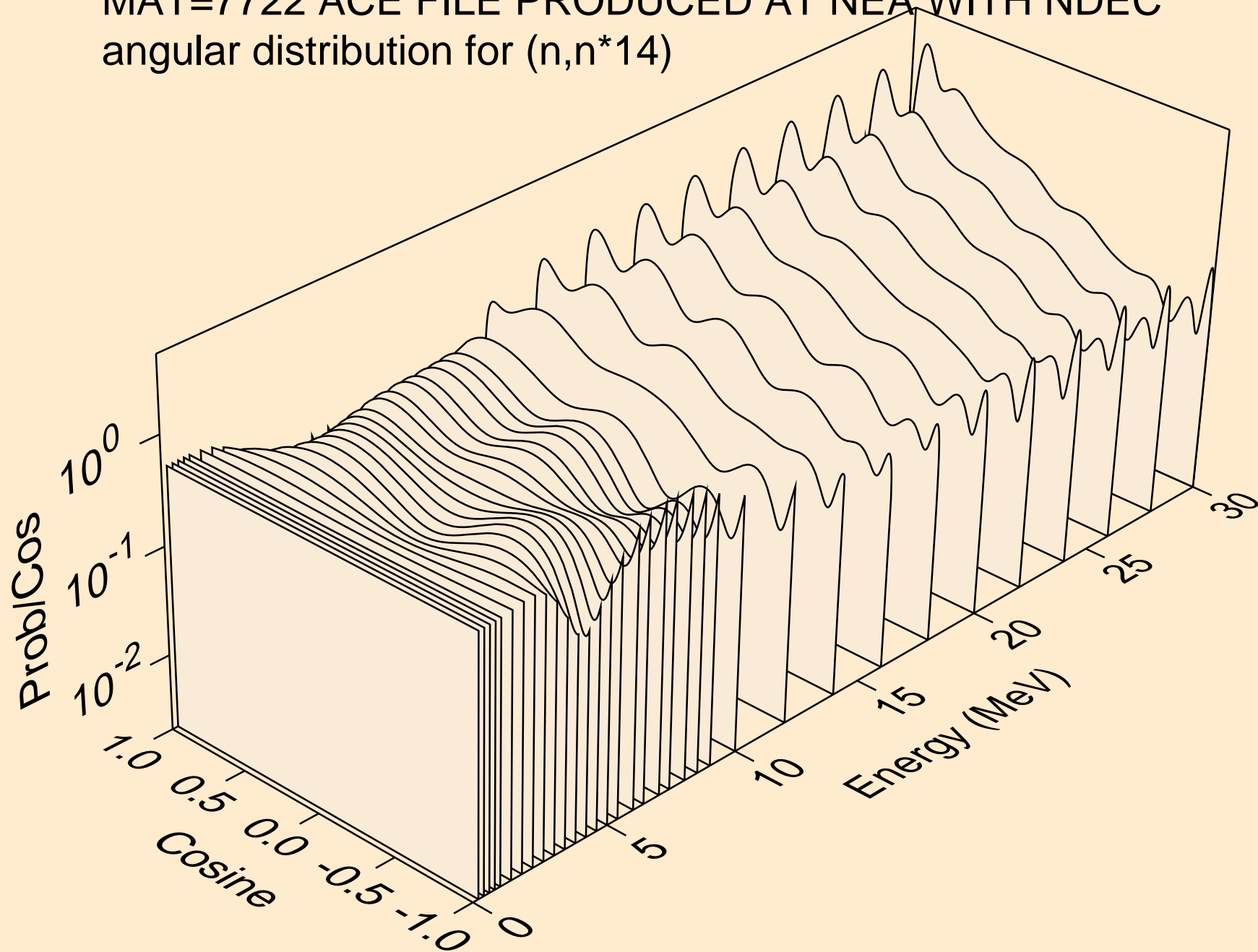

MAT=7722 ACE FILE PRODUCED AT NEA WITH NDEC
angular distribution for (n,n*15)

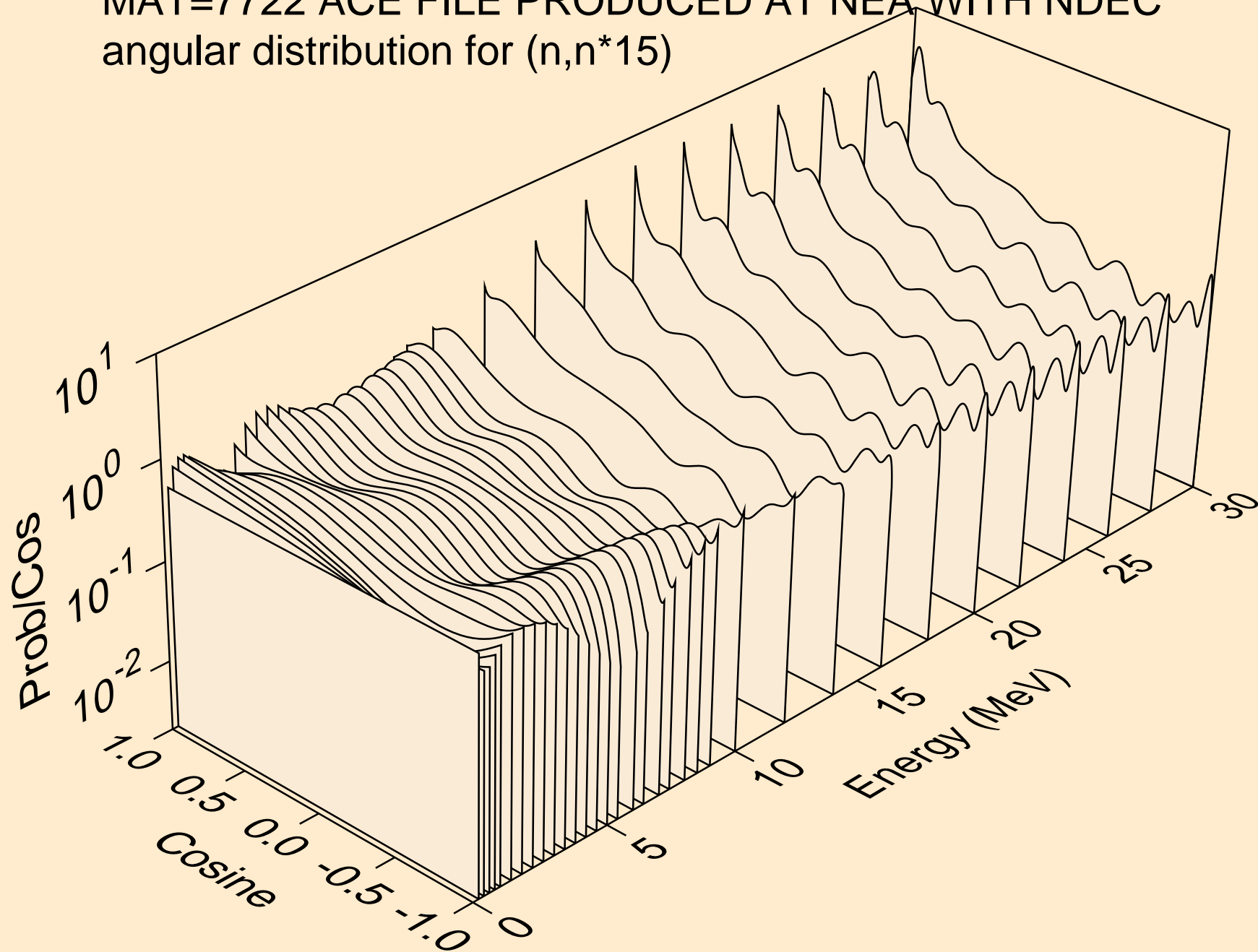

MAT=7722 ACE FILE PRODUCED AT NEA WITH NDEC
angular distribution for (n,n*16)

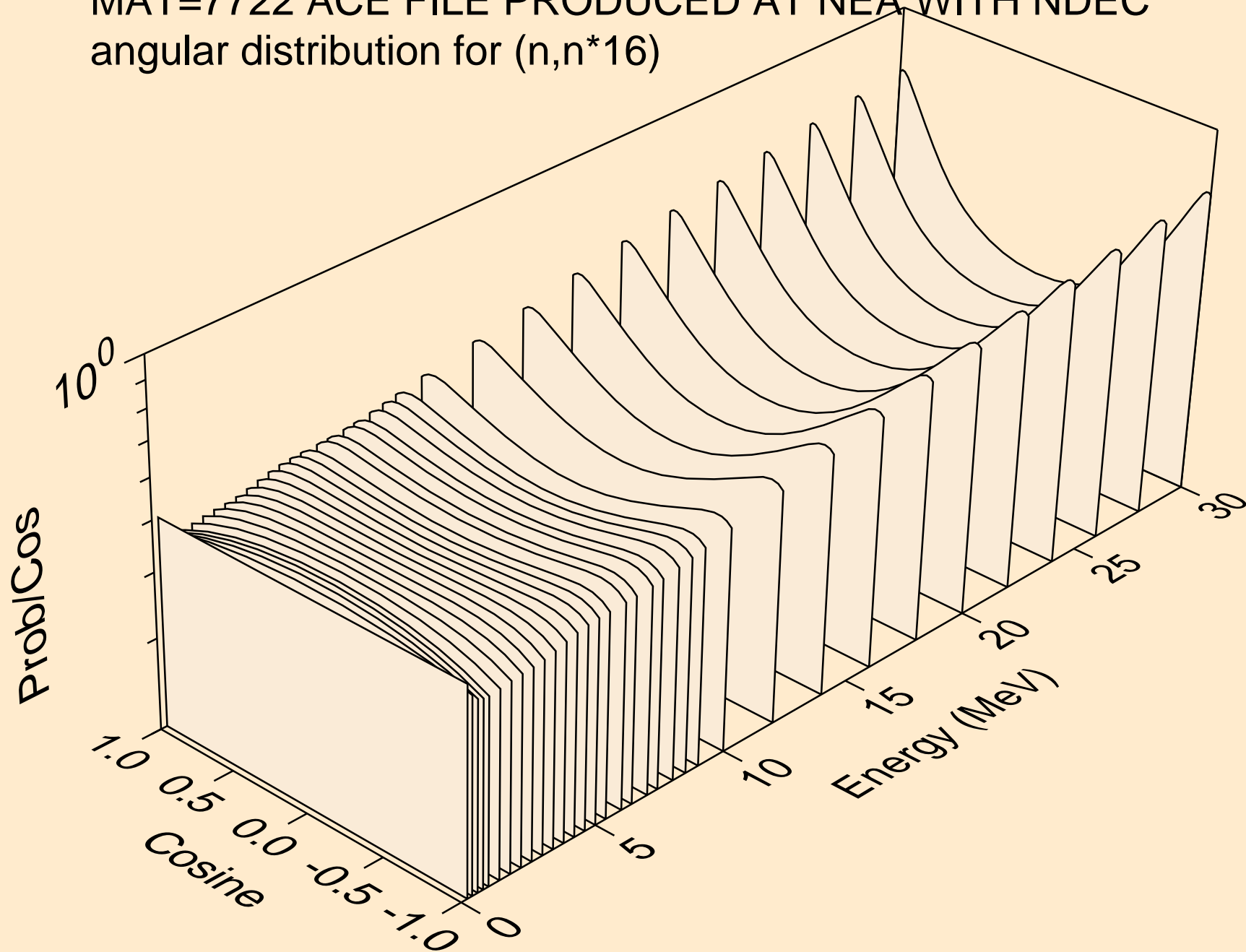

MAT=7722 ACE FILE PRODUCED AT NEA WITH NDEC
angular distribution for (n,n*17)

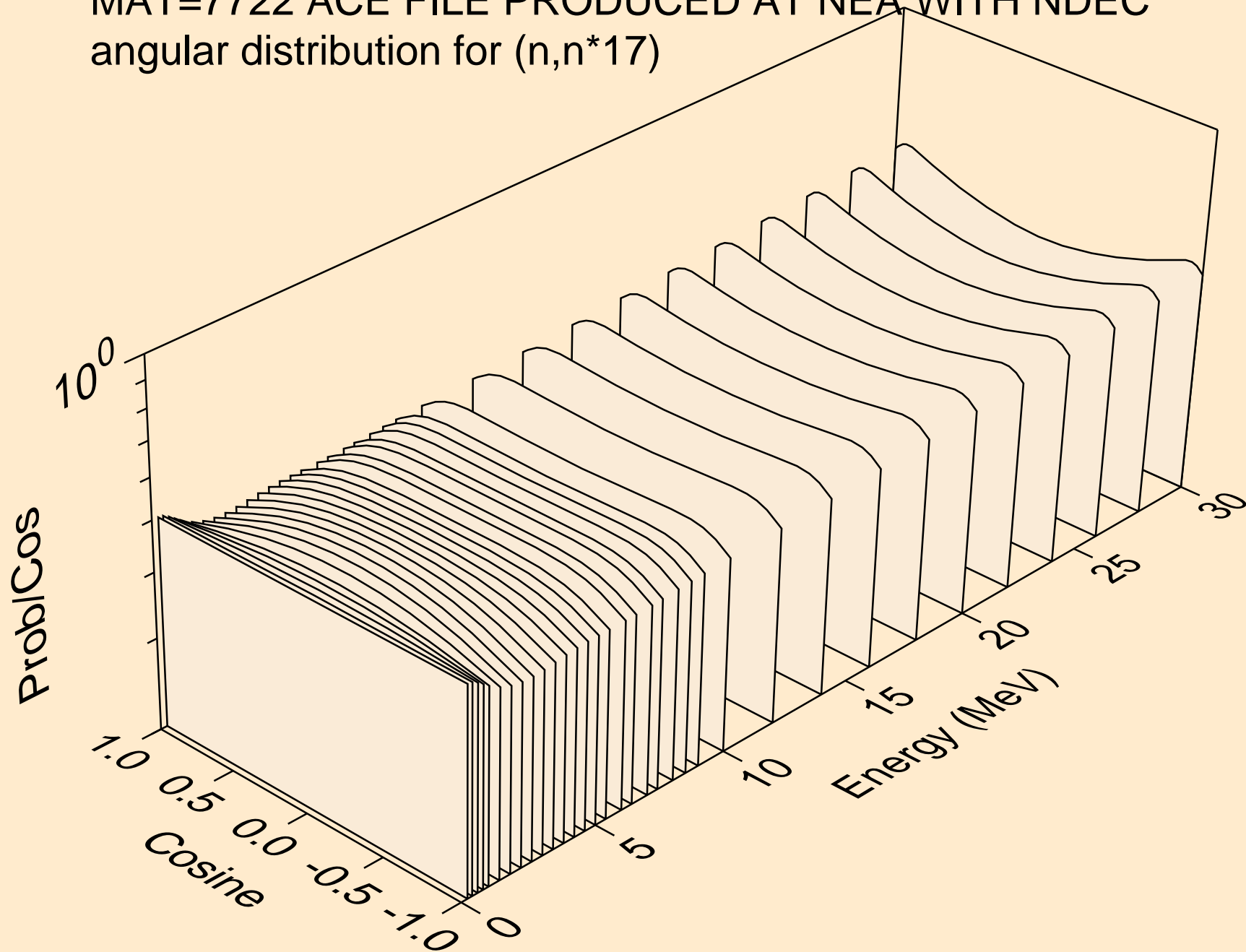

MAT=7722 ACE FILE PRODUCED AT NEA WITH NDEC
angular distribution for (n,n*18)

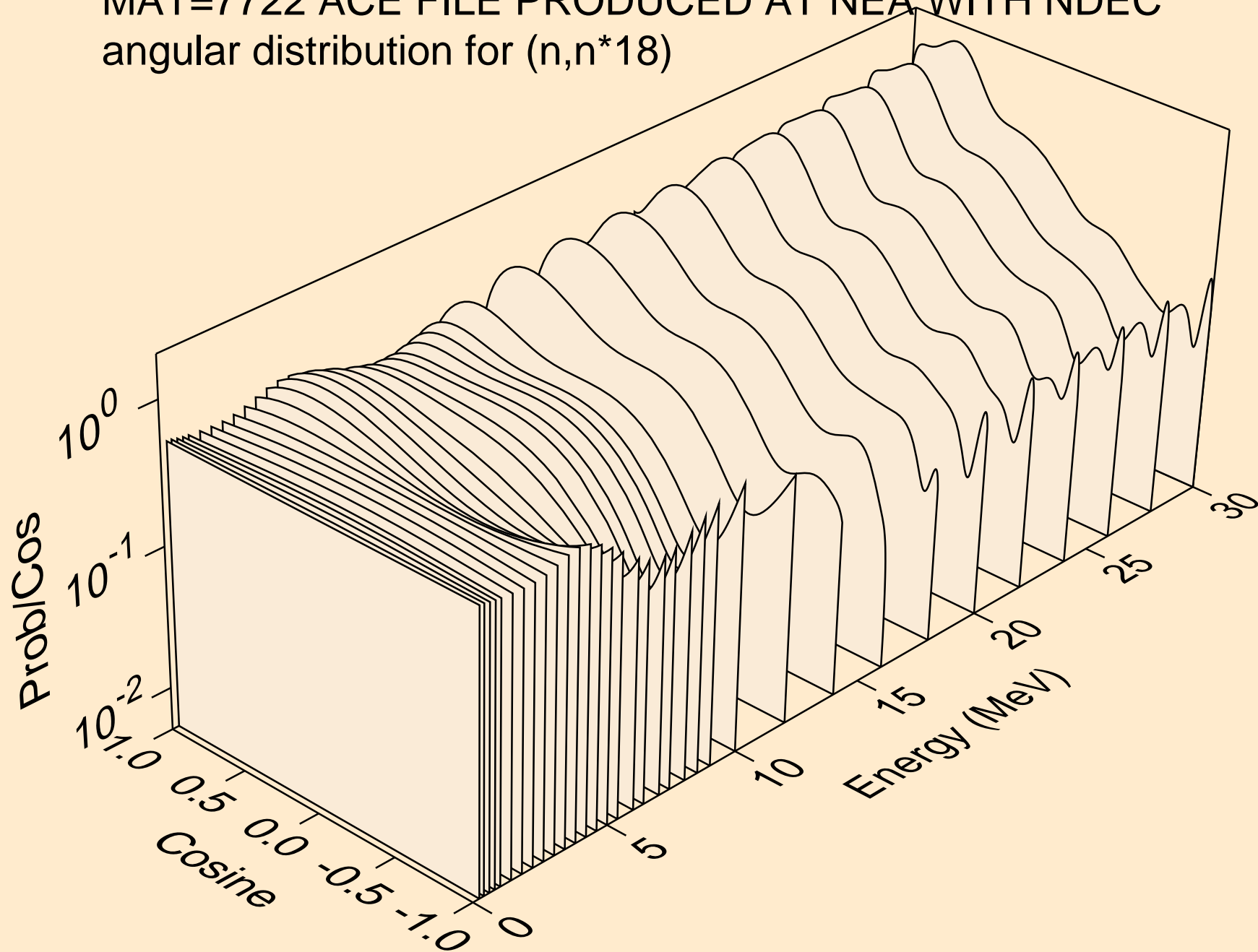

MAT=7722 ACE FILE PRODUCED AT NEA WITH NDEC
angular distribution for (n,n*19)

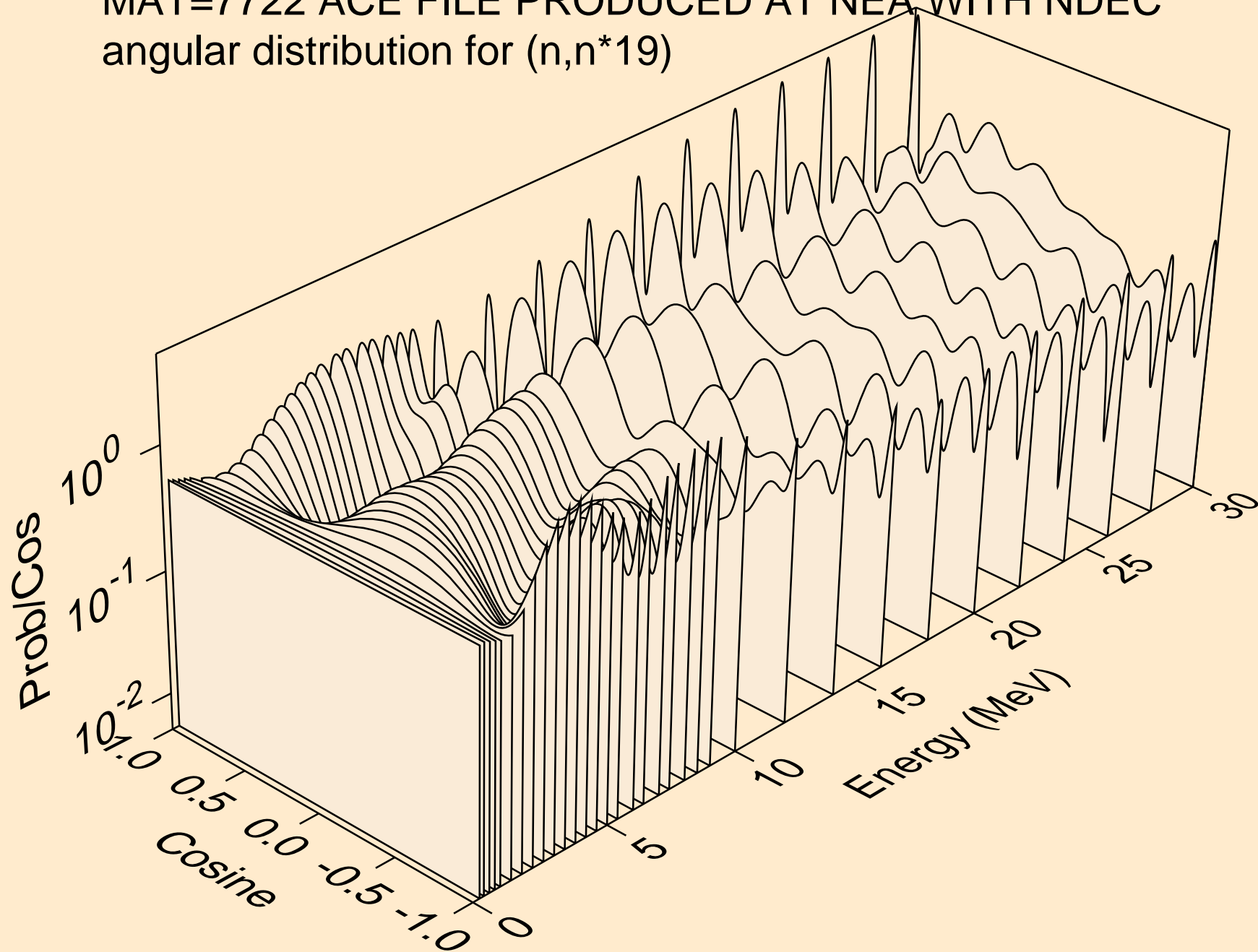

MAT=7722 ACE FILE PRODUCED AT NEA WITH NDEC
angular distribution for (n,n*20)

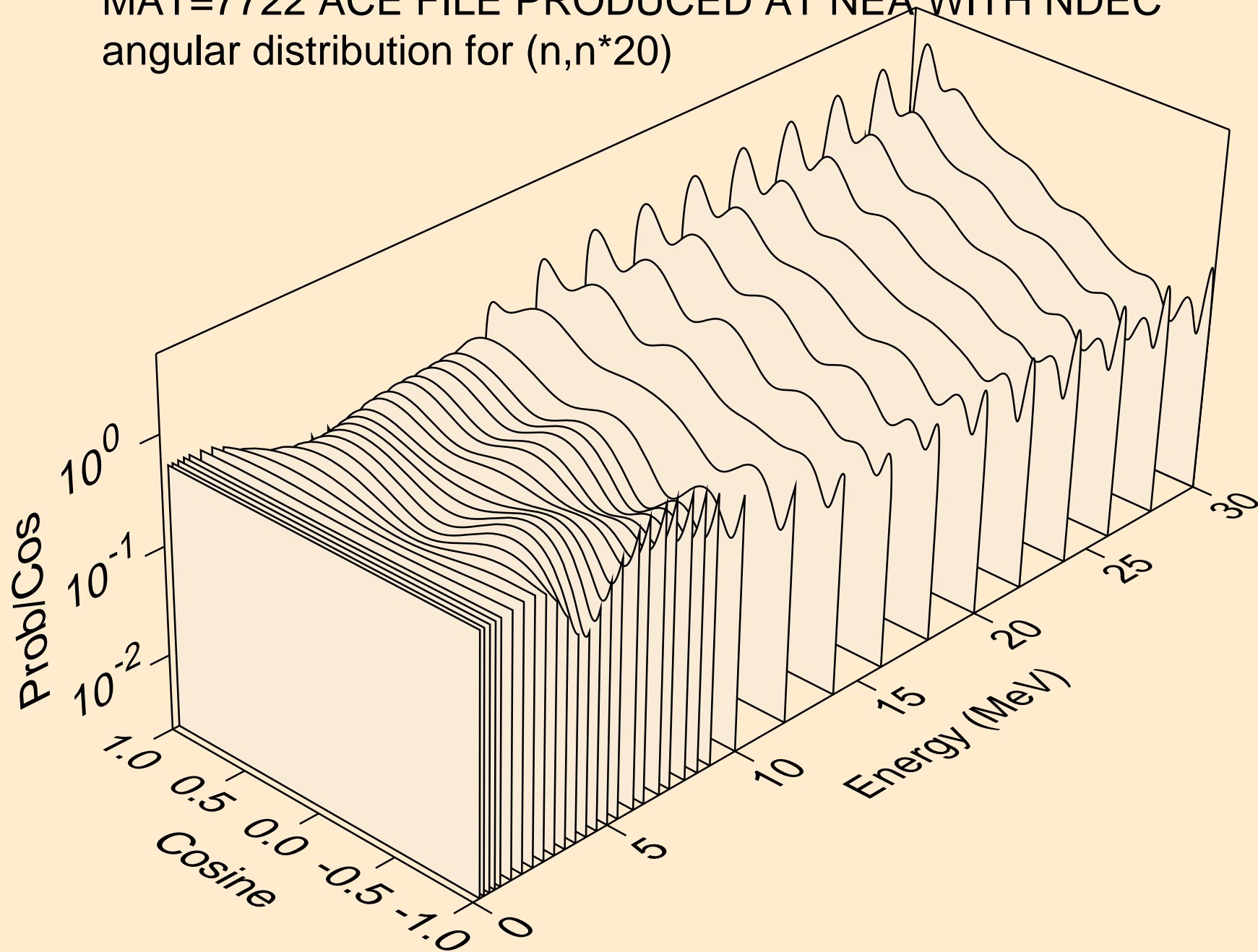

MAT=7722 ACE FILE PRODUCED AT NEA WITH NDEC
angular distribution for (n,n*21)

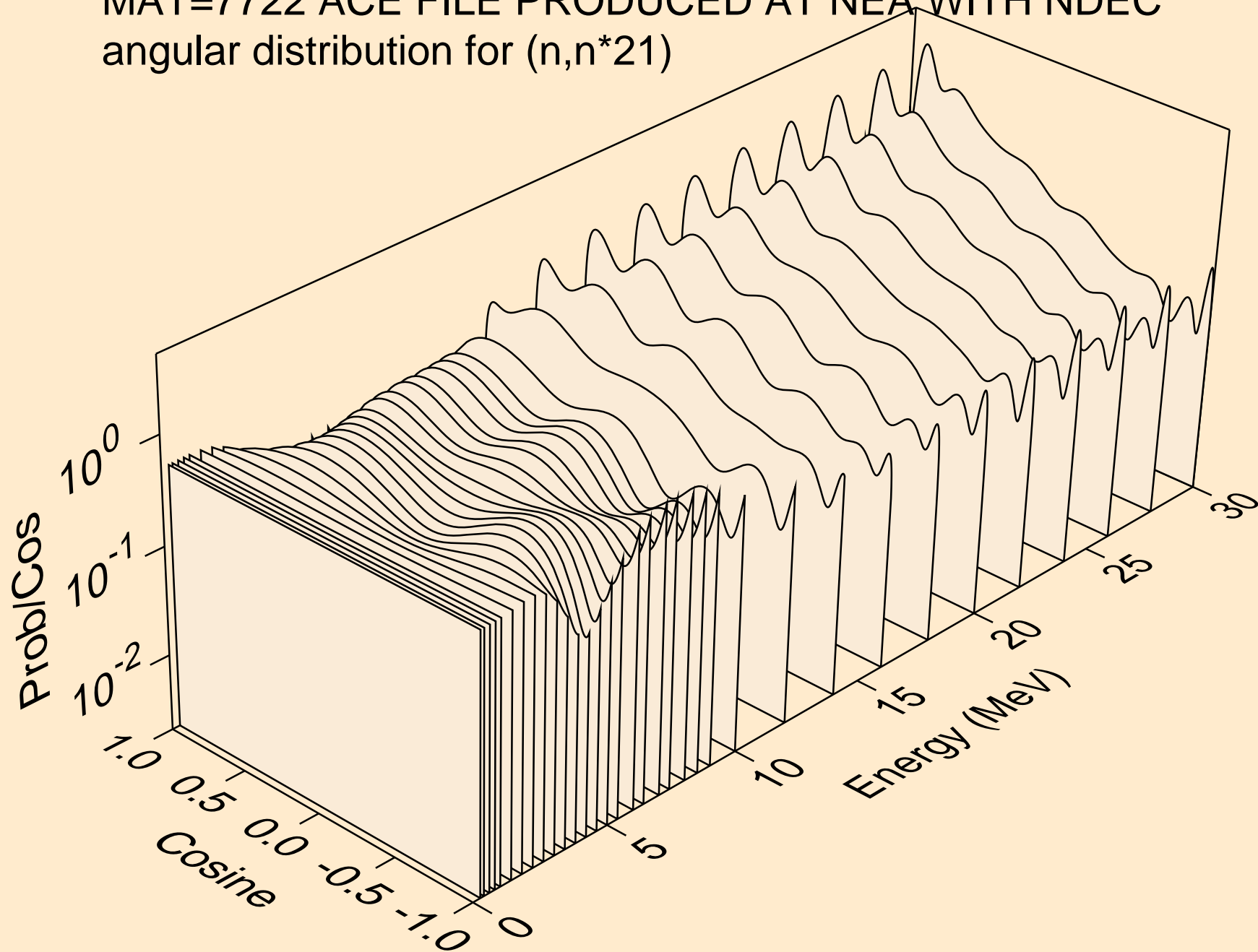

MAT=7722 ACE FILE PRODUCED AT NEA WITH NDEC
angular distribution for (n,n*22)

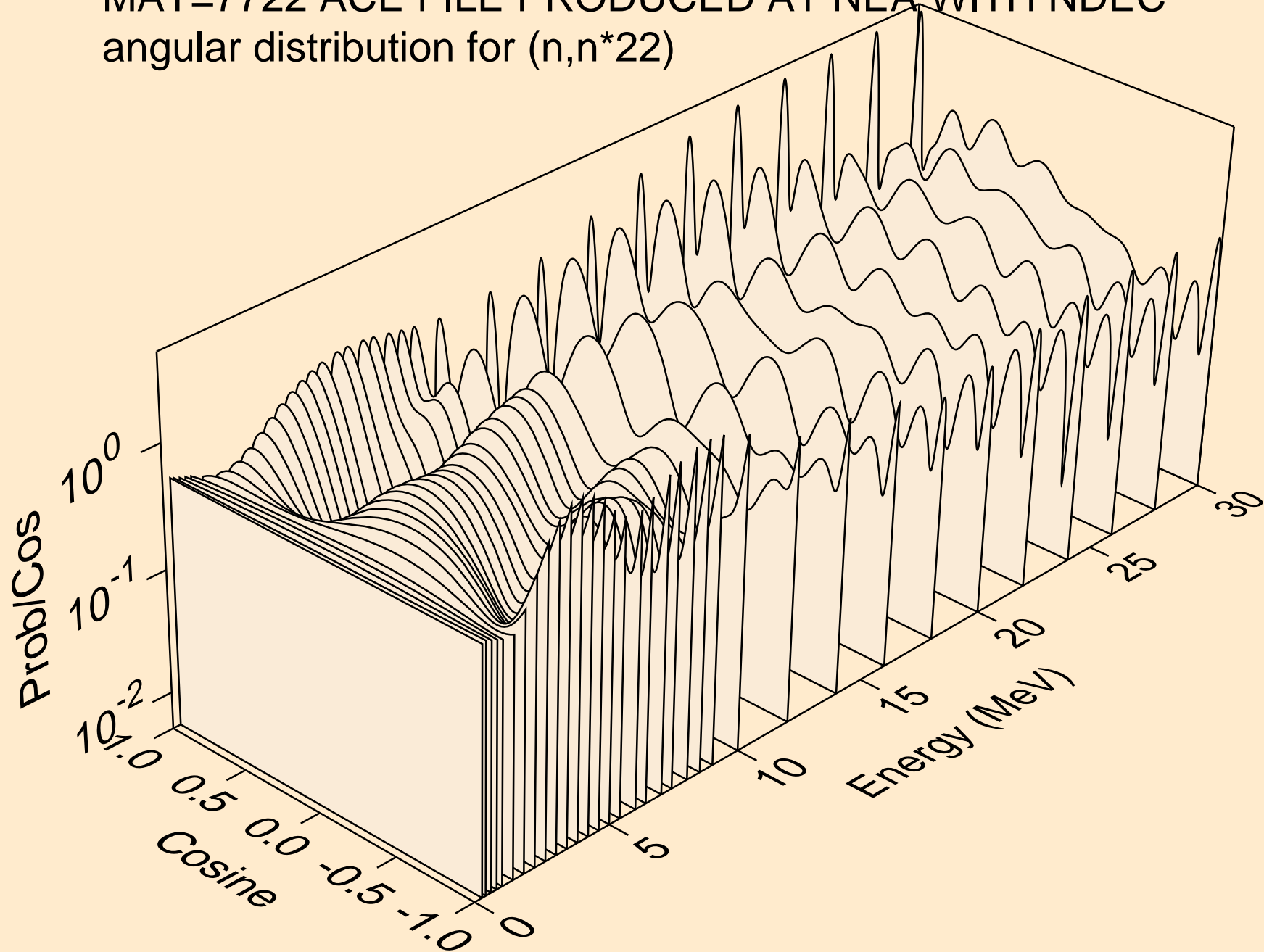

MAT=7722 ACE FILE PRODUCED AT NEA WITH NDEC
angular distribution for (n,n*23)

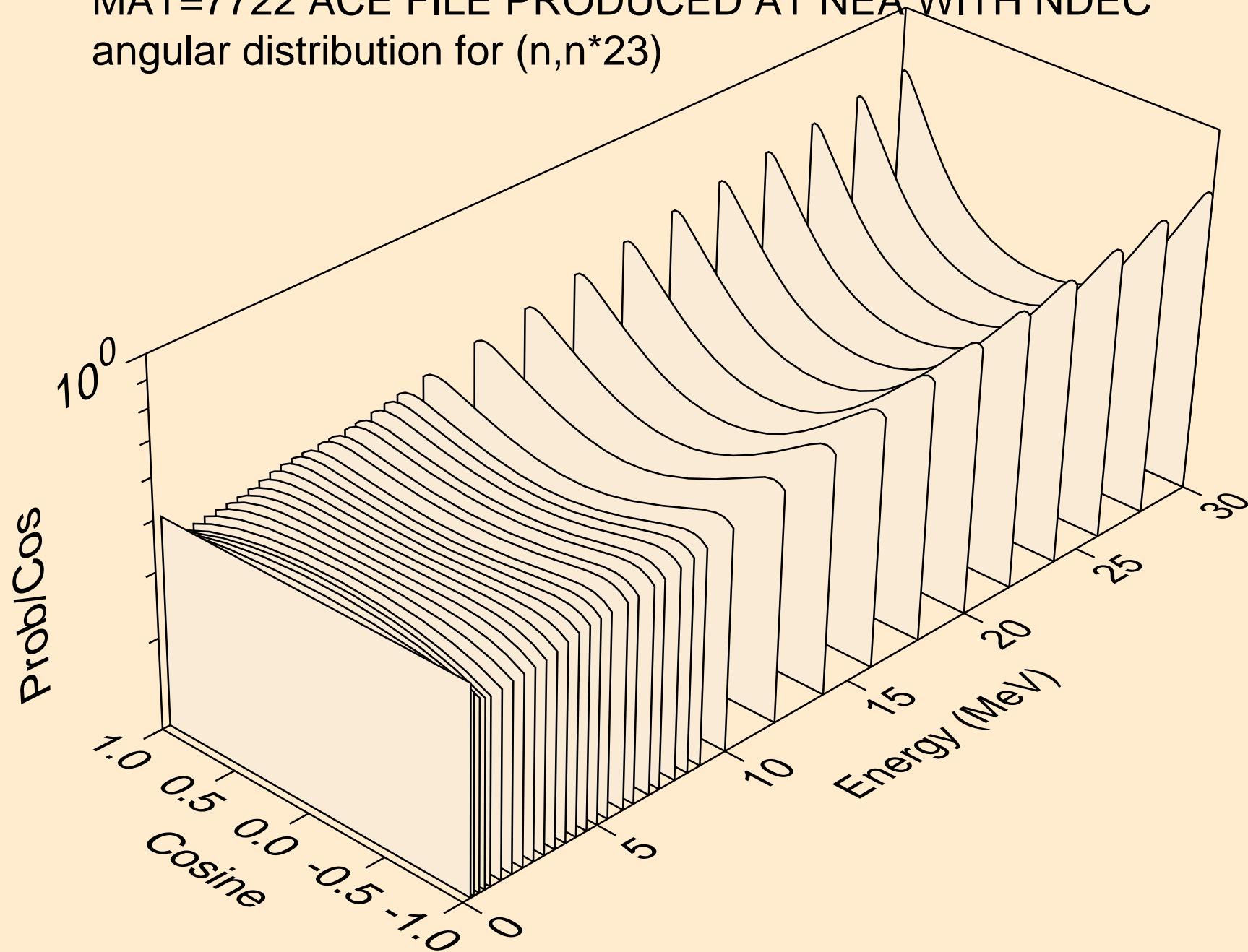

MAT=7722 ACE FILE PRODUCED AT NEA WITH NDEC
angular distribution for (n,n*24)

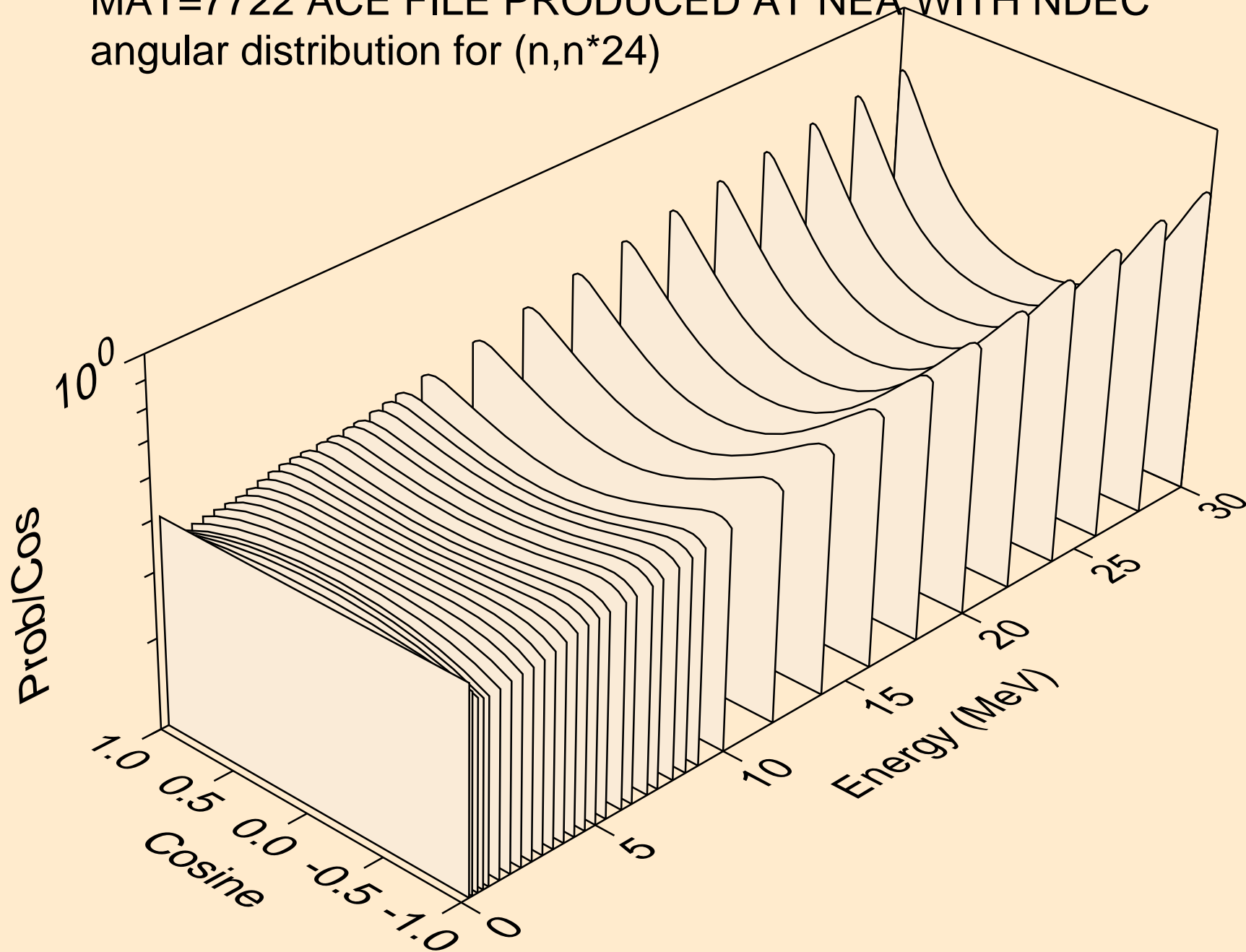

MAT=7722 ACE FILE PRODUCED AT NEA WITH NDEC
angular distribution for (n,n*25)

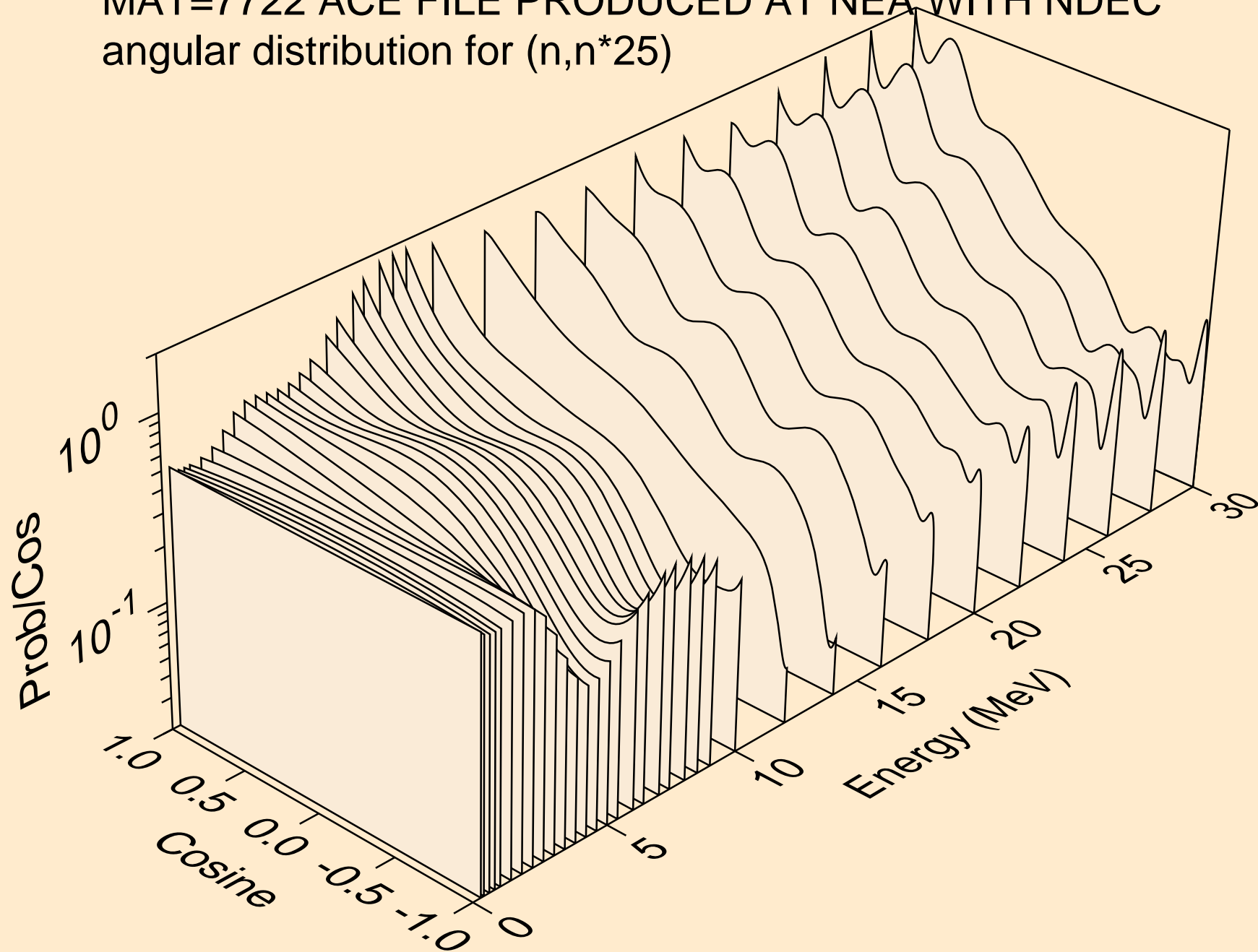

MAT=7722 ACE FILE PRODUCED AT NEA WITH NDEC
angular distribution for (n,n*26)

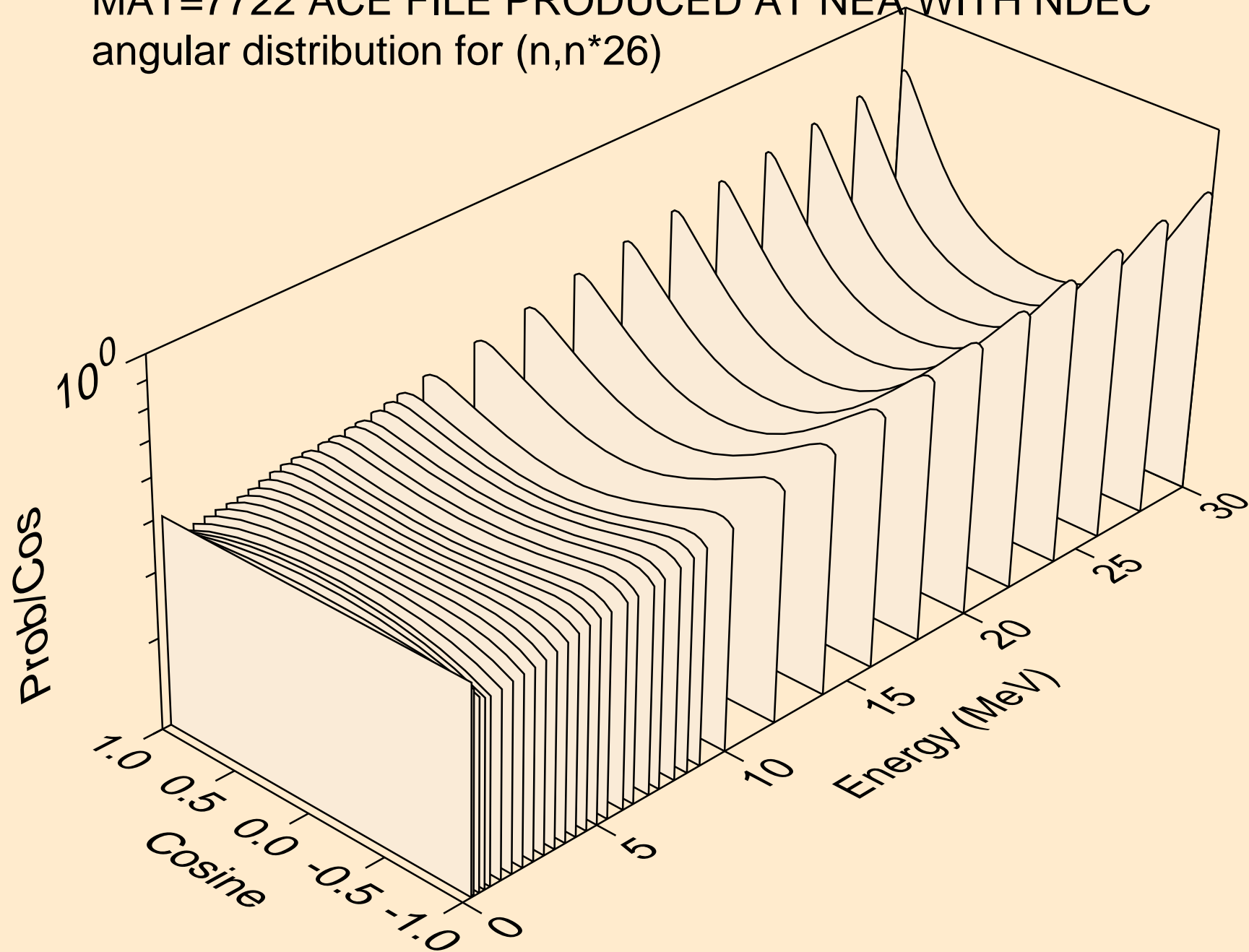

MAT=7722 ACE FILE PRODUCED AT NEA WITH NDEC
angular distribution for (n,n*27)

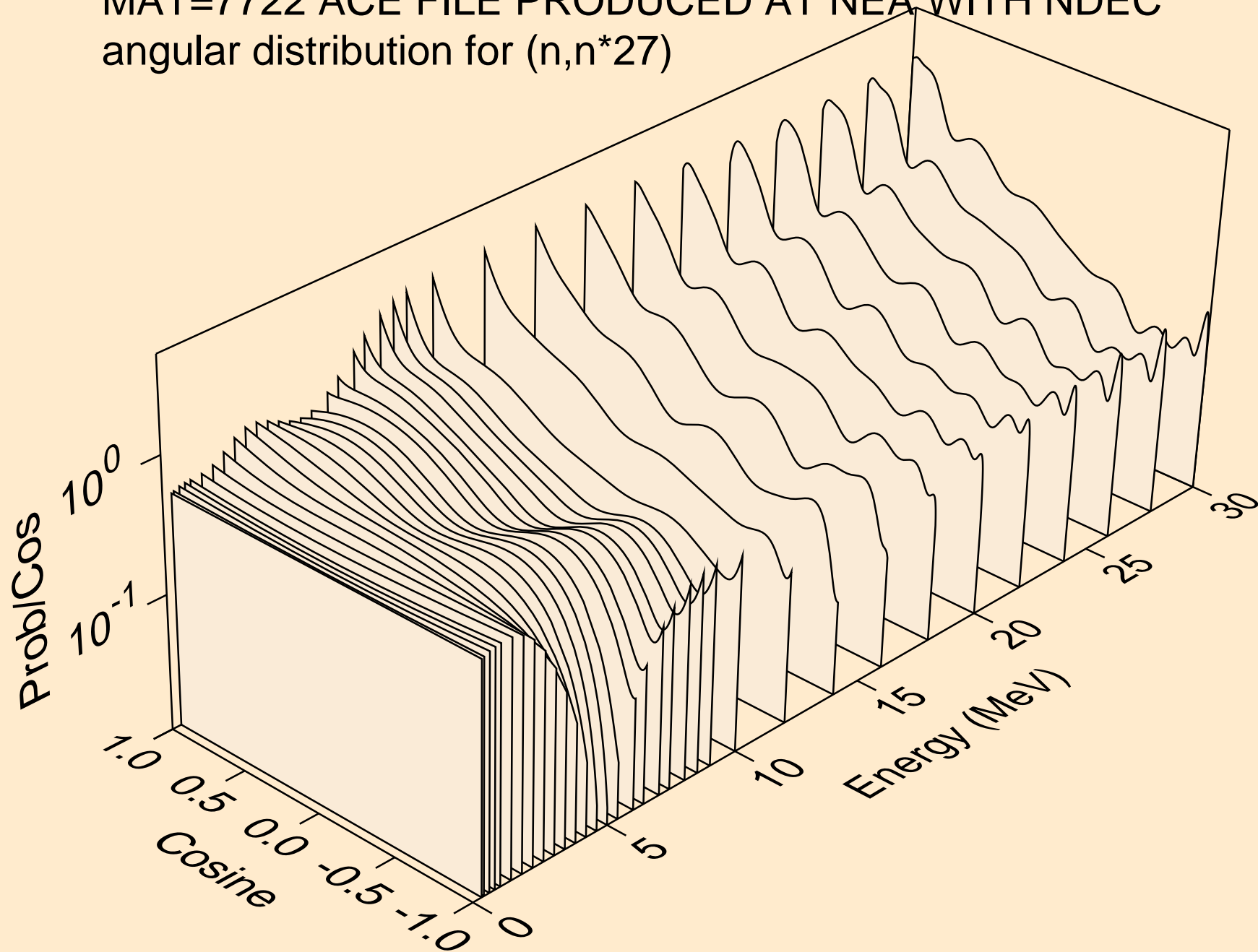

MAT=7722 ACE FILE PRODUCED AT NEA WITH NDEC
angular distribution for (n,n*28)

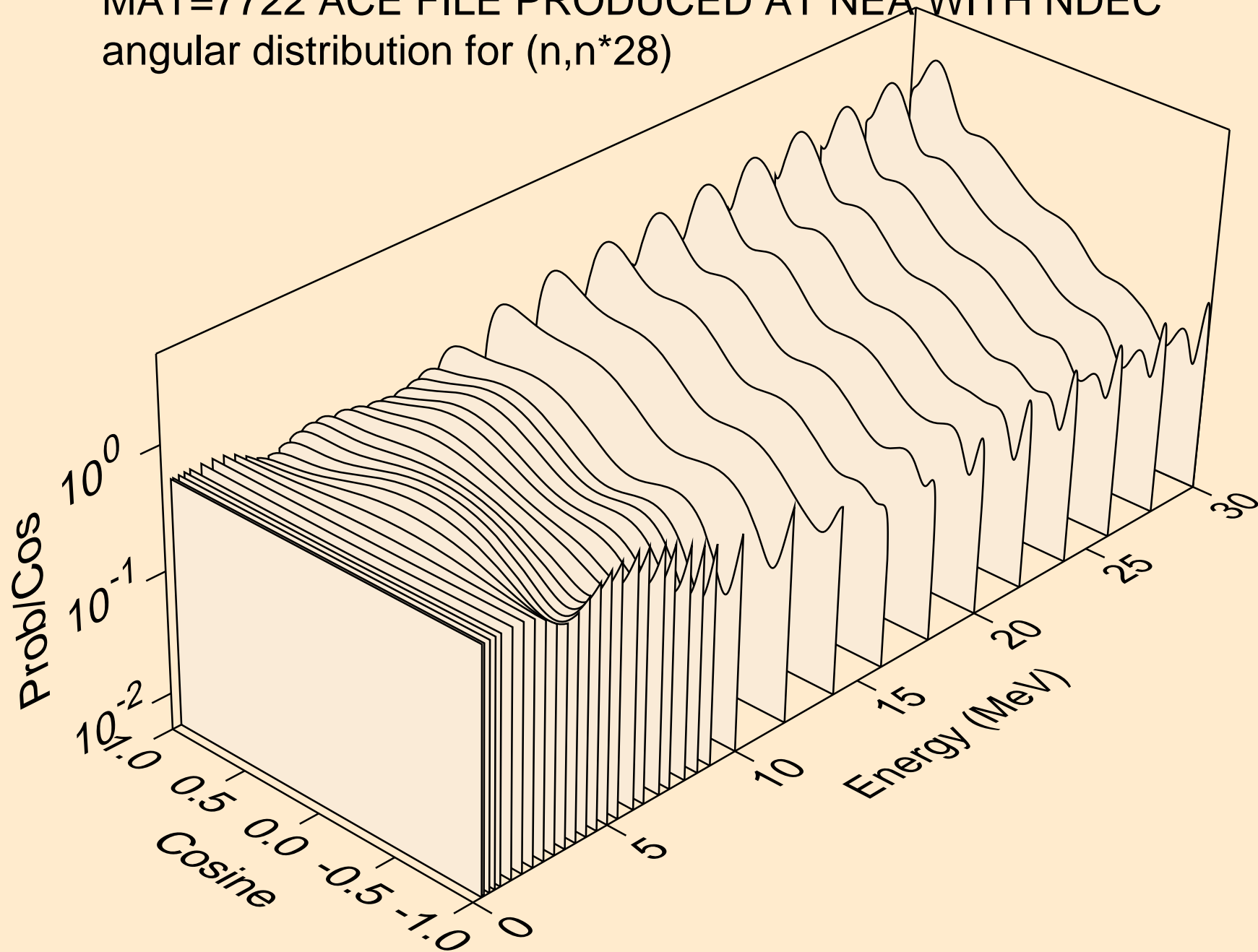

MAT=7722 ACE FILE PRODUCED AT NEA WITH NDEC
angular distribution for (n,n*29)

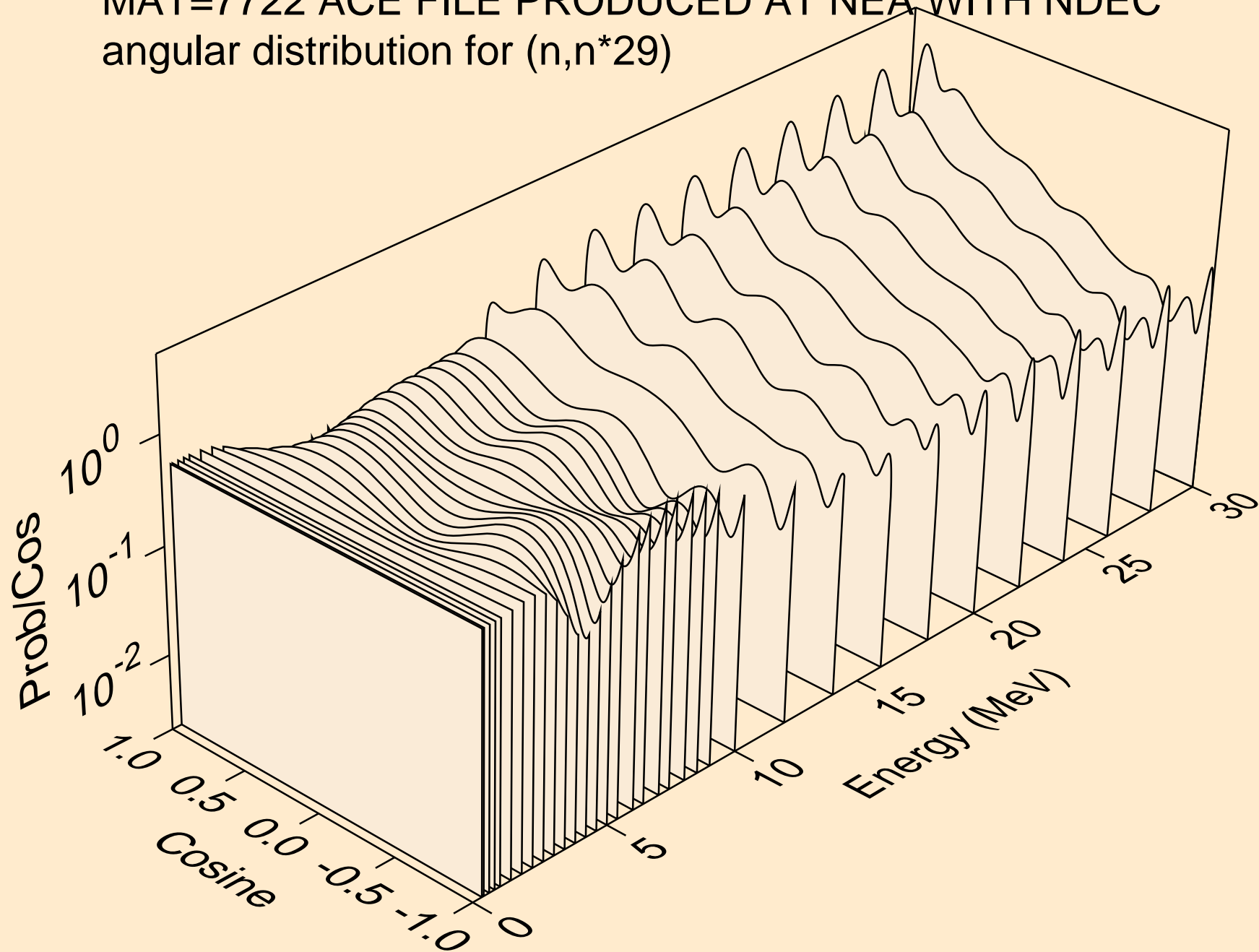

MAT=7722 ACE FILE PRODUCED AT NEA WITH NDEC
angular distribution for (n,n*30)

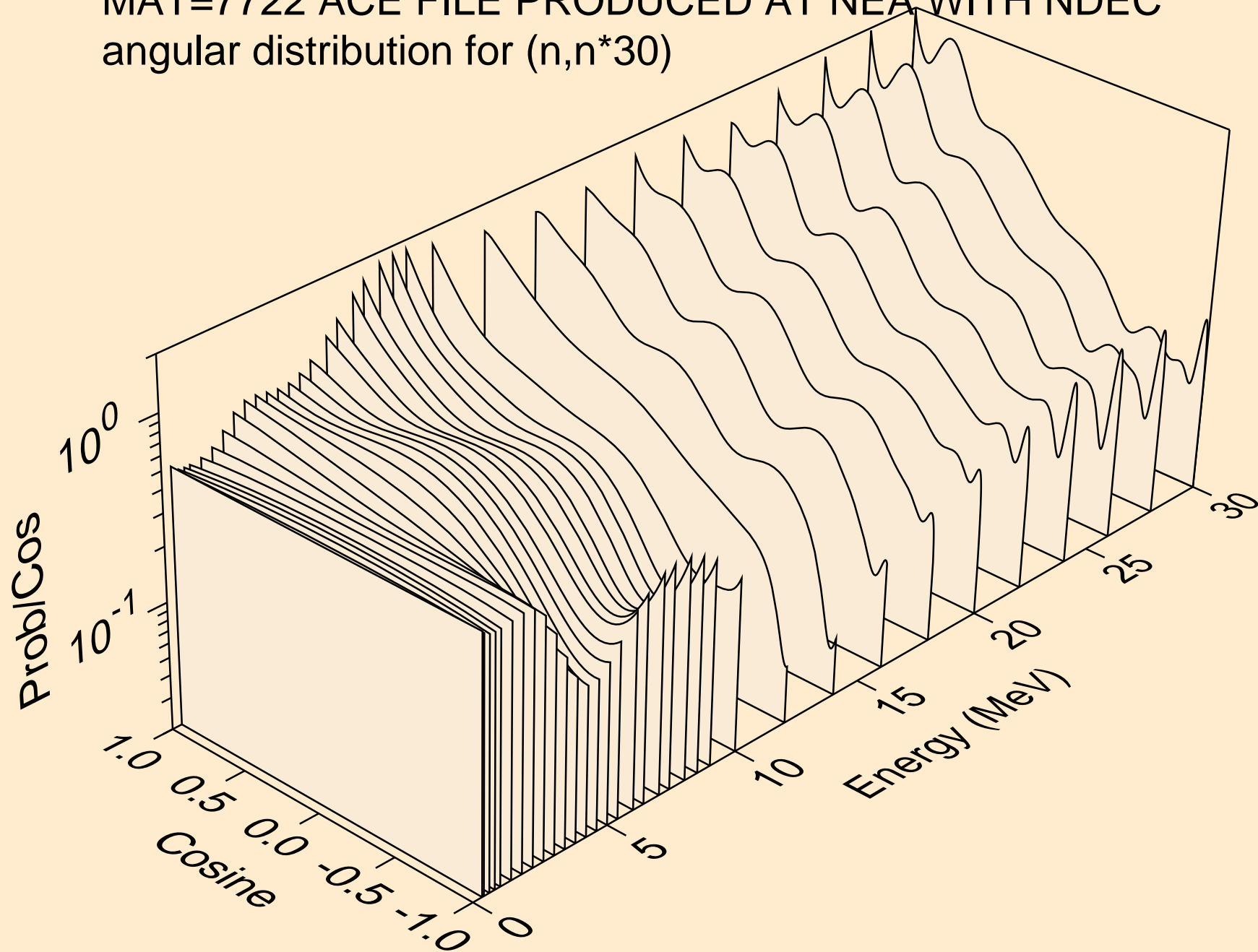

MAT=7722 ACE FILE PRODUCED AT NEA WITH NDEC
Neutron emission for (n,x)

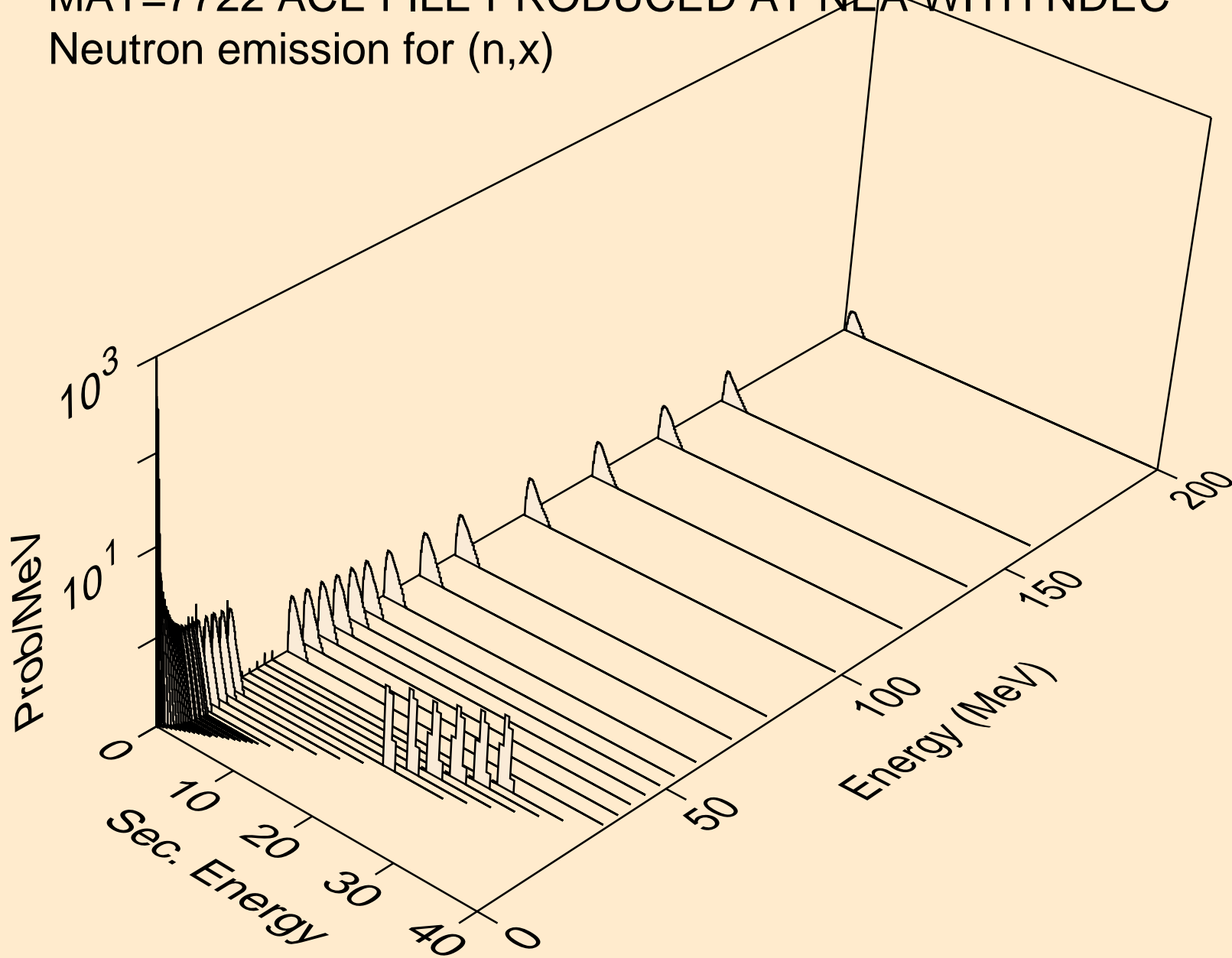

MAT=7722 ACE FILE PRODUCED AT NEA WITH NDEC
Neutron emission for (n,2nd)

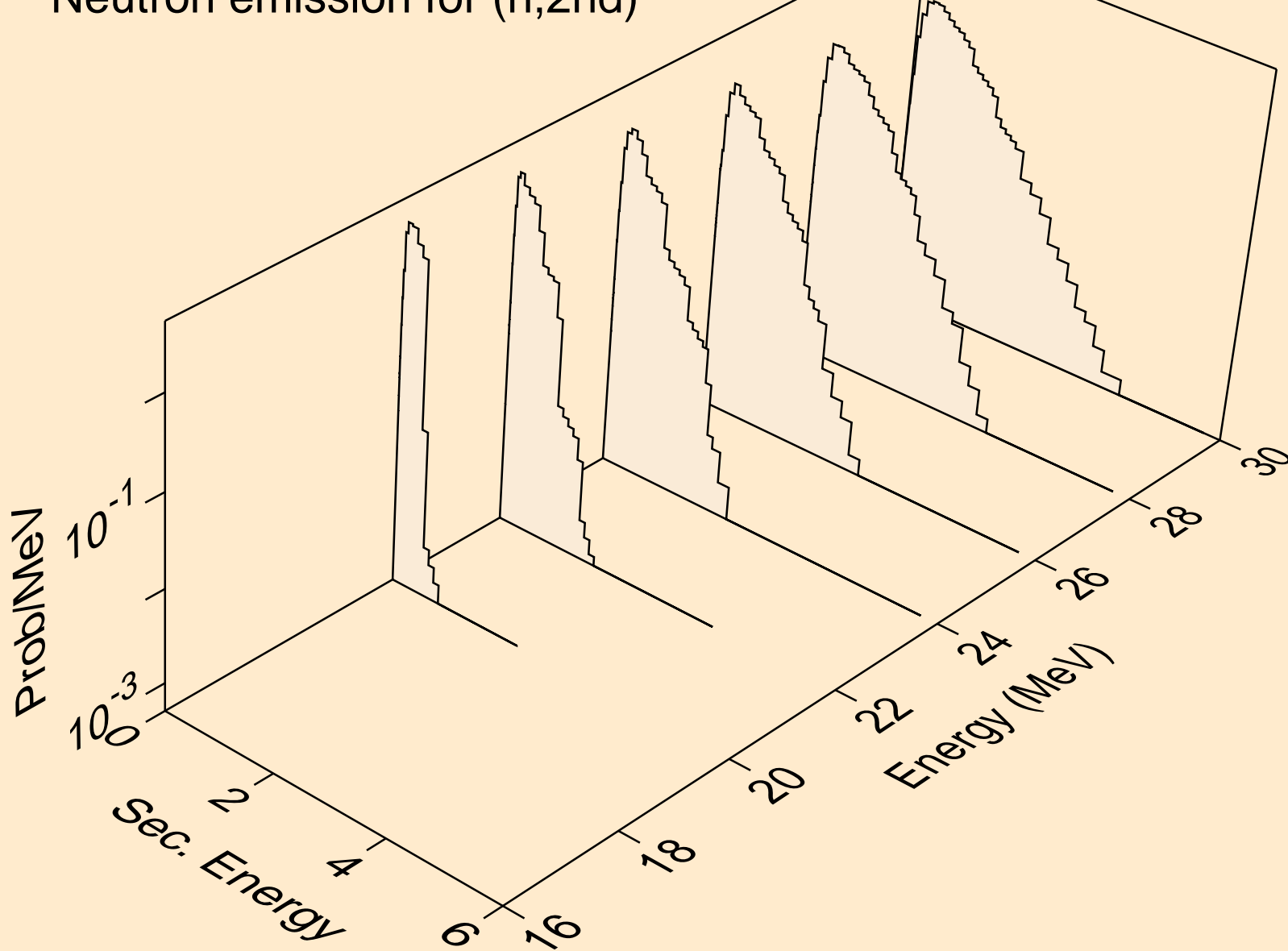

MAT=7722 ACE FILE PRODUCED AT NEA WITH NDEC
Neutron emission for (n,2n)

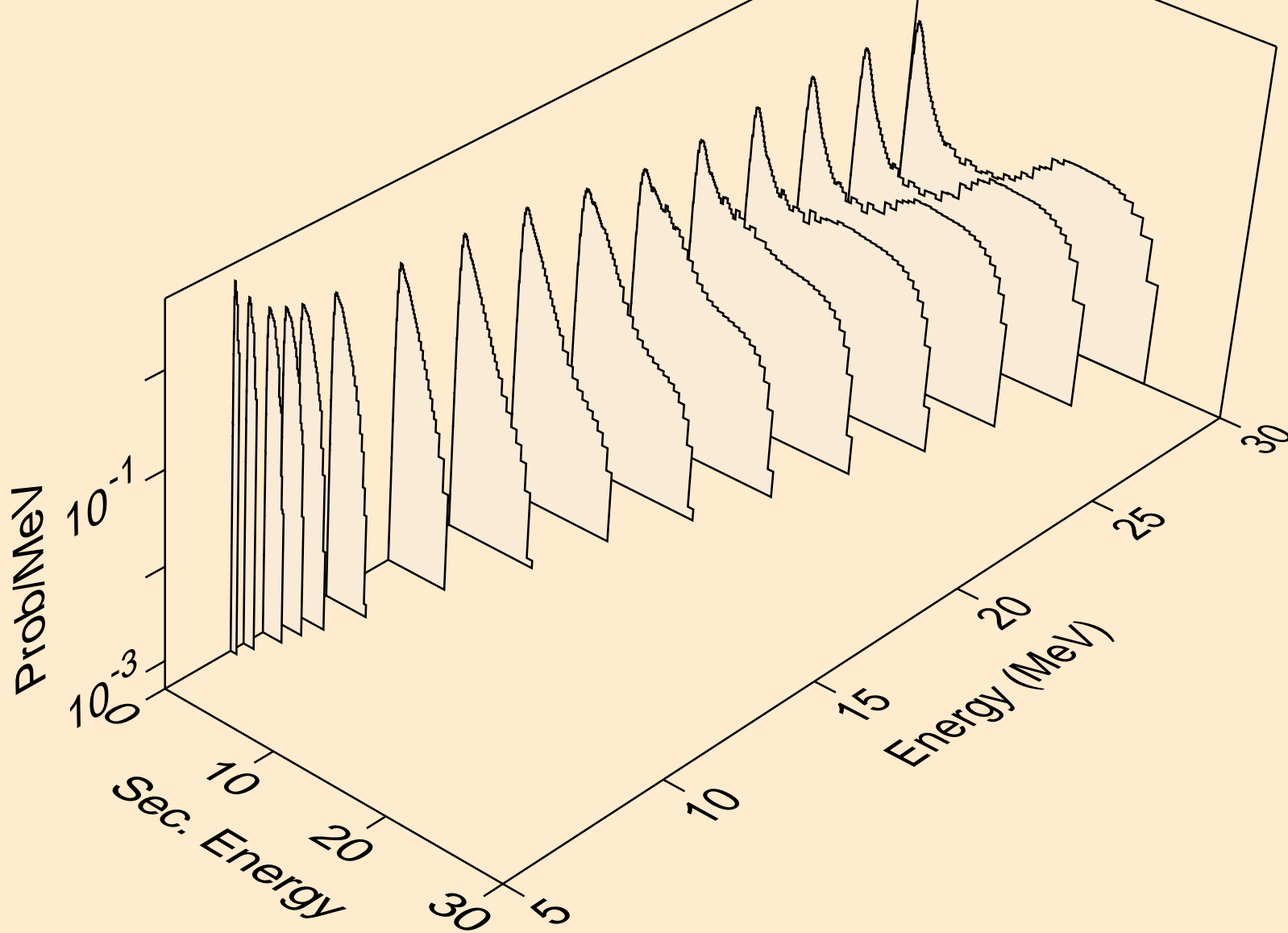

MAT=7722 ACE FILE PRODUCED AT NEA WITH NDEC
Neutron emission for (n,3n)

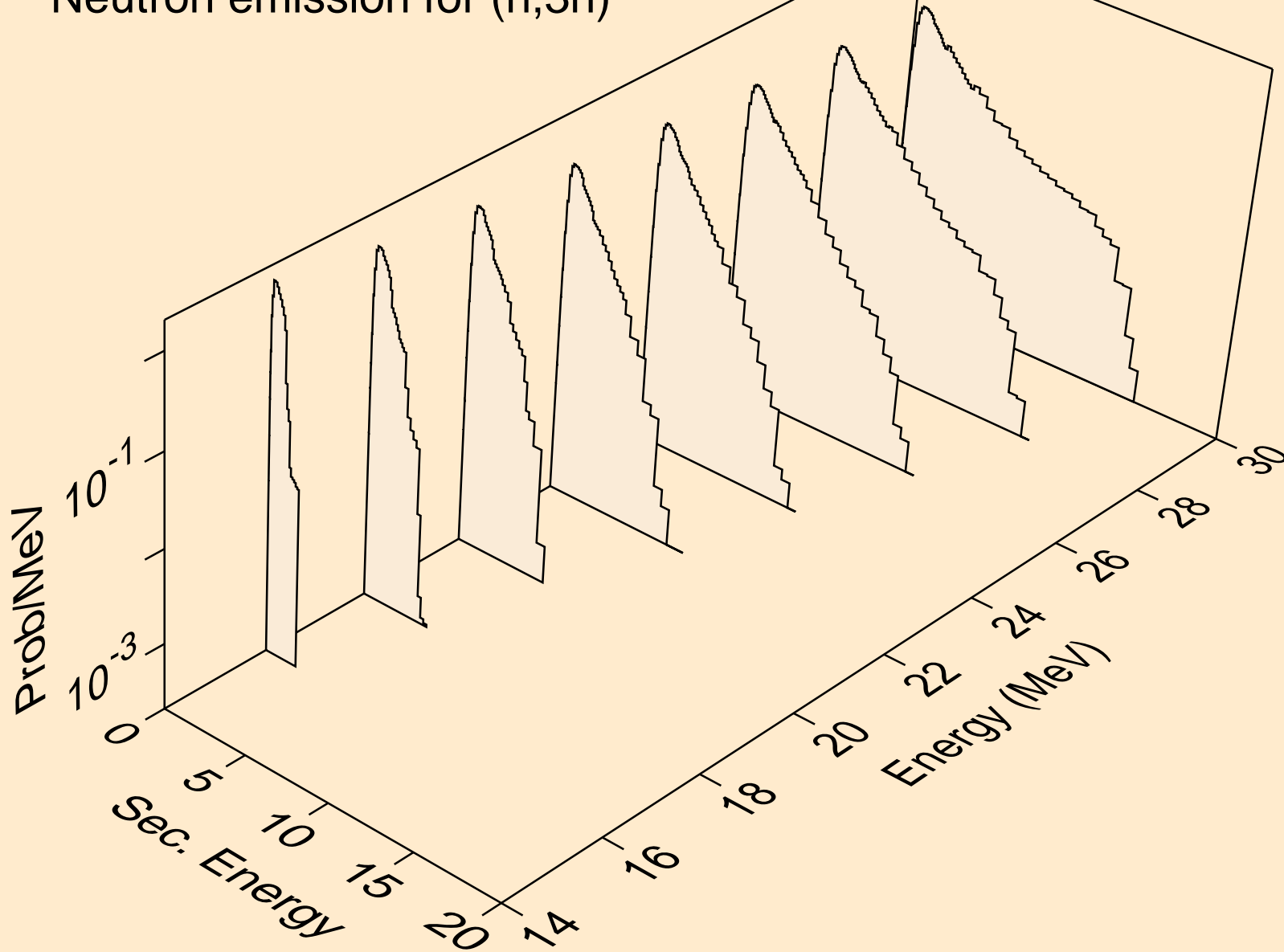

MAT=7722 ACE FILE PRODUCED AT NEA WITH NDEC
Neutron emission for (n,n*)a

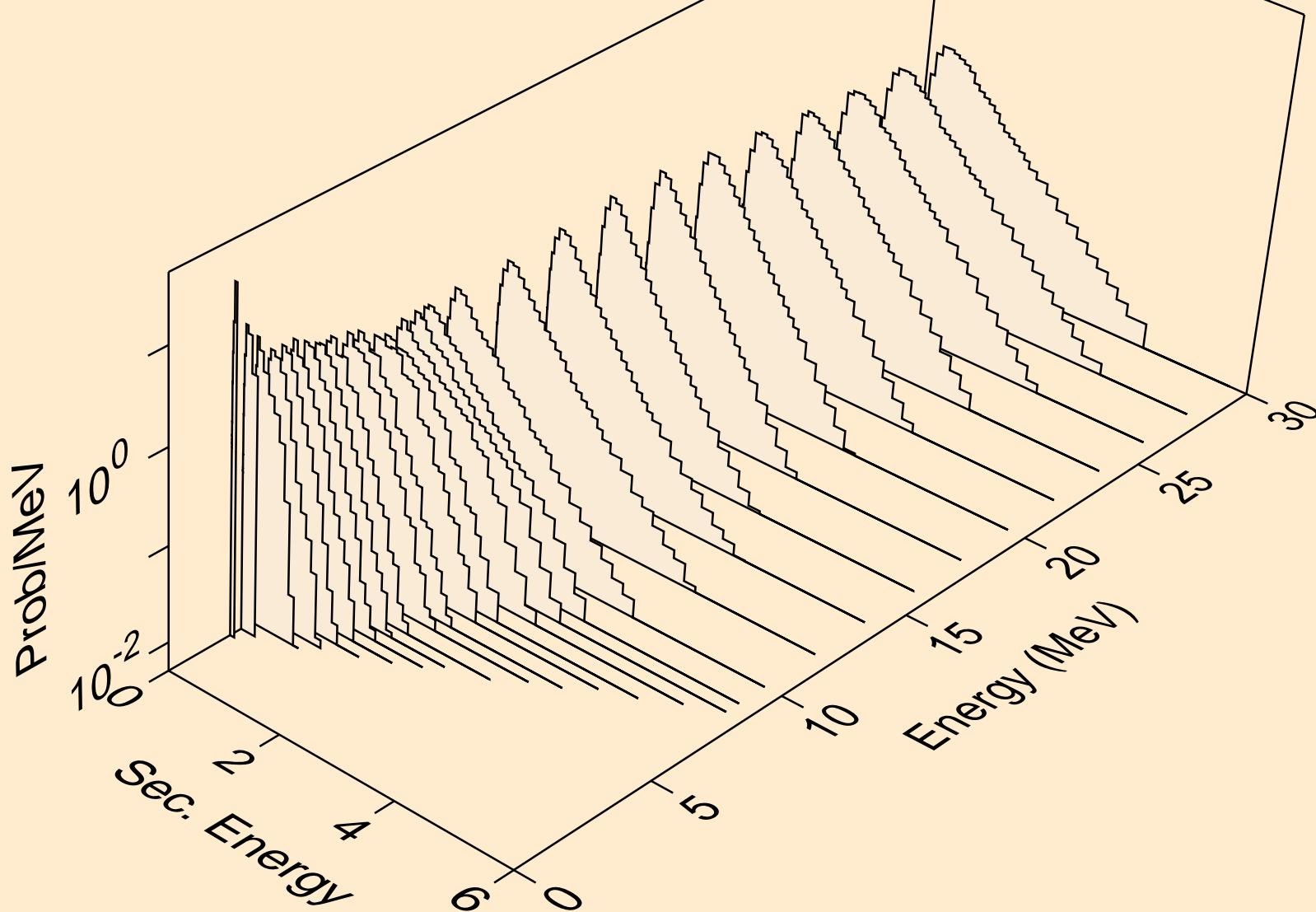

MAT=7722 ACE FILE PRODUCED AT NEA WITH NDEC
Neutron emission for (n,2n)a

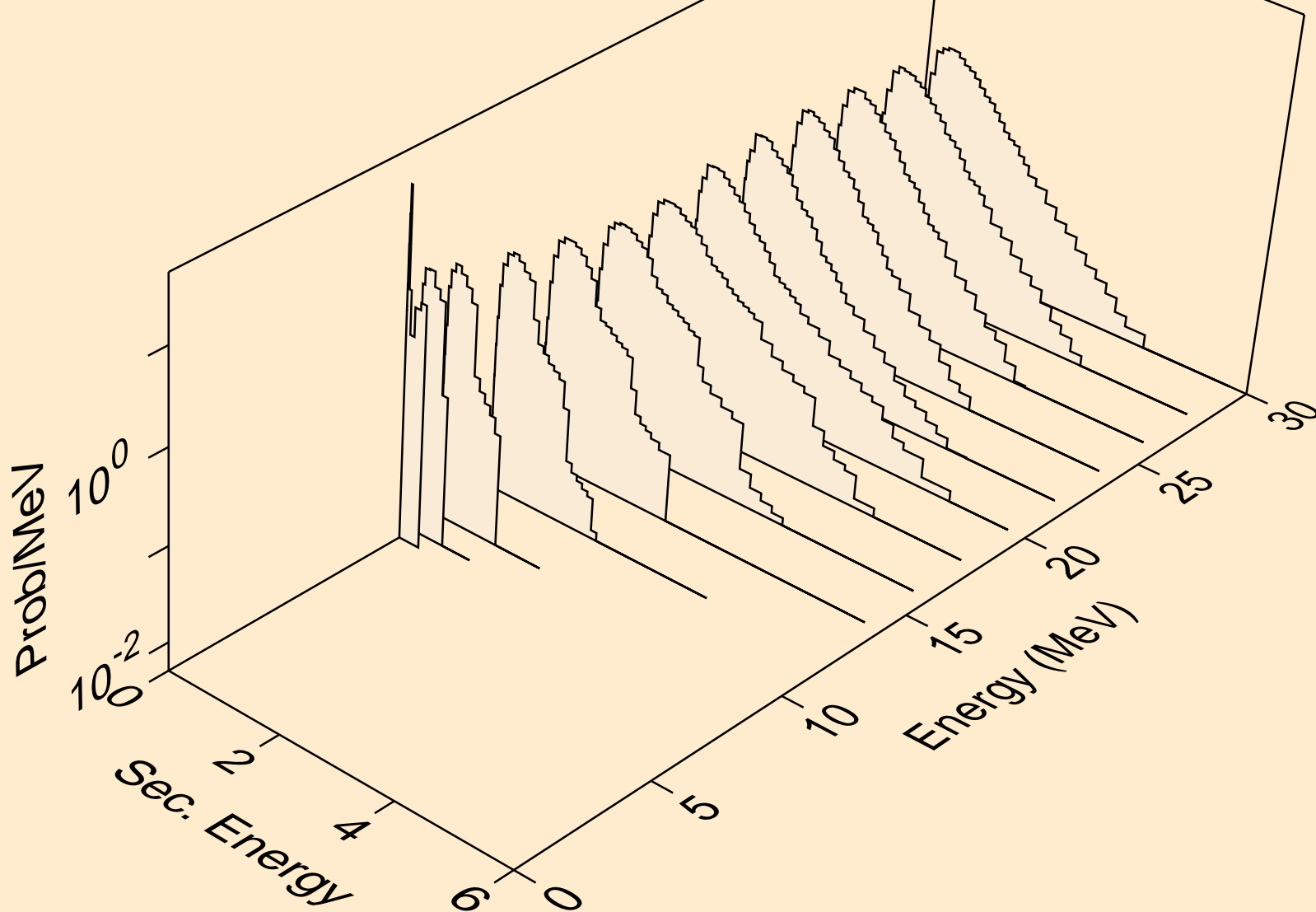

MAT=7722 ACE FILE PRODUCED AT NEA WITH NDEC
Neutron emission for (n,3n)a

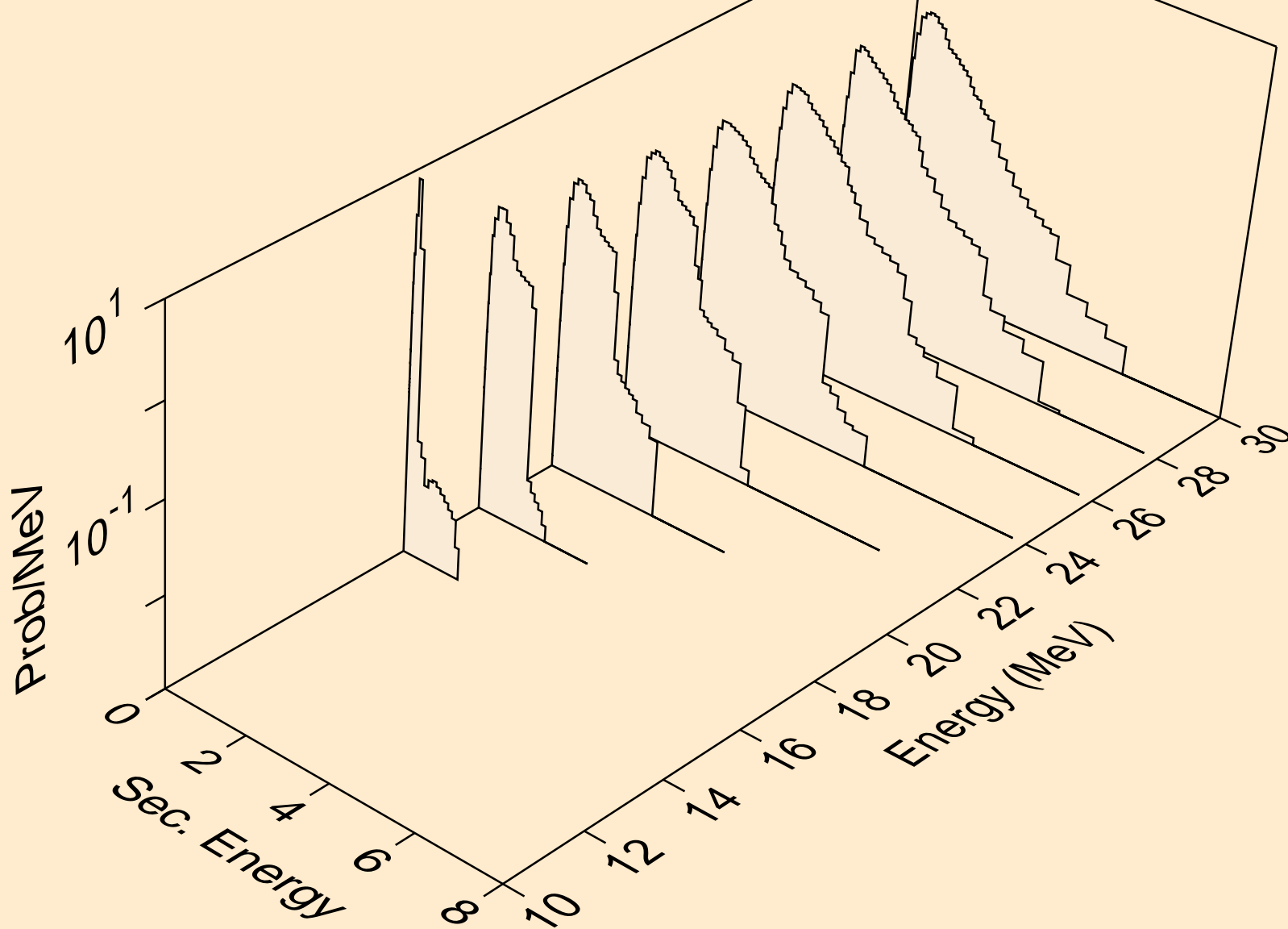

MAT=7722 ACE FILE PRODUCED AT NEA WITH NDEC
Neutron emission for (n,n*)p

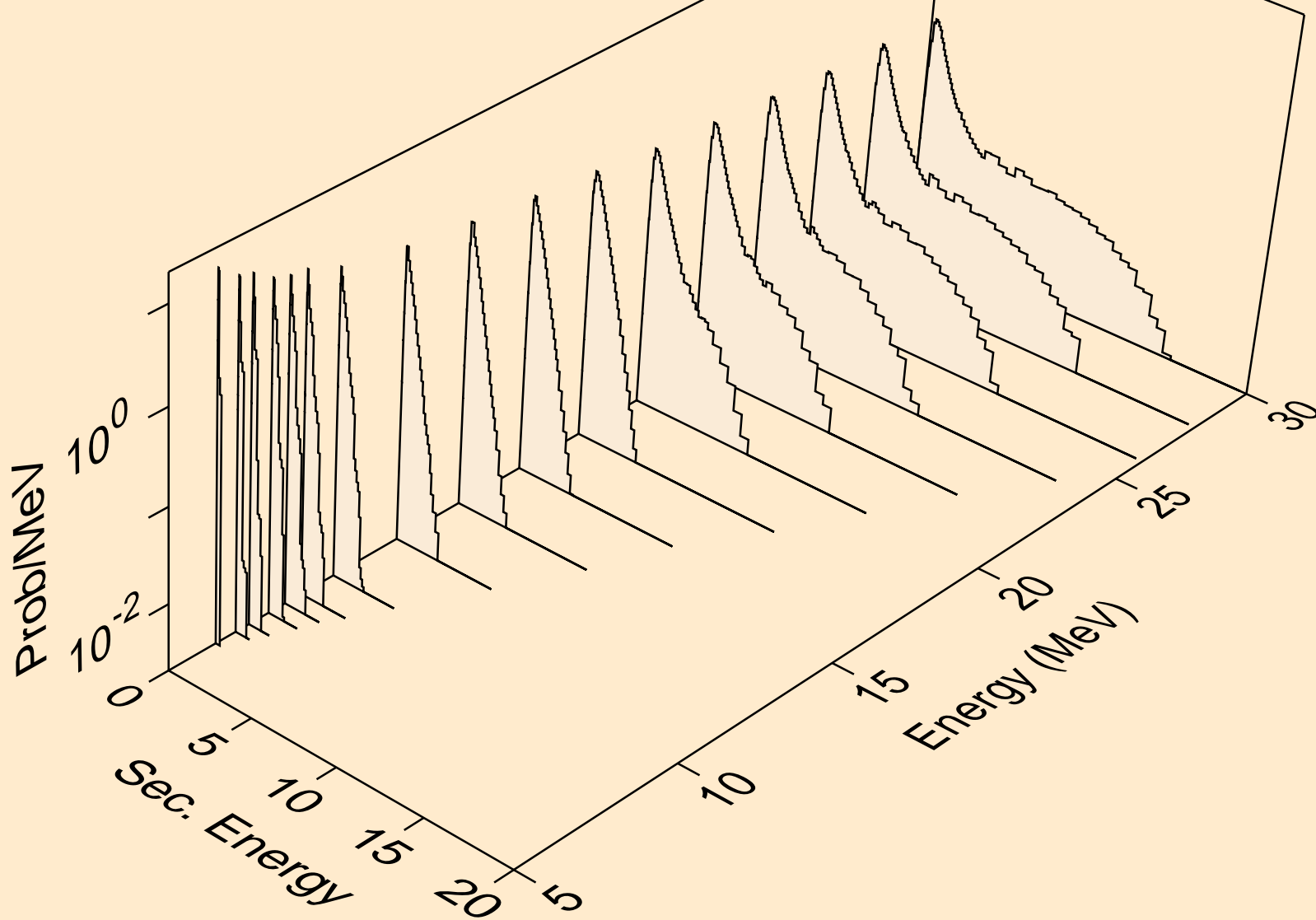

MAT=7722 ACE FILE PRODUCED AT NEA WITH NDEC
Neutron emission for (n,n*)2a

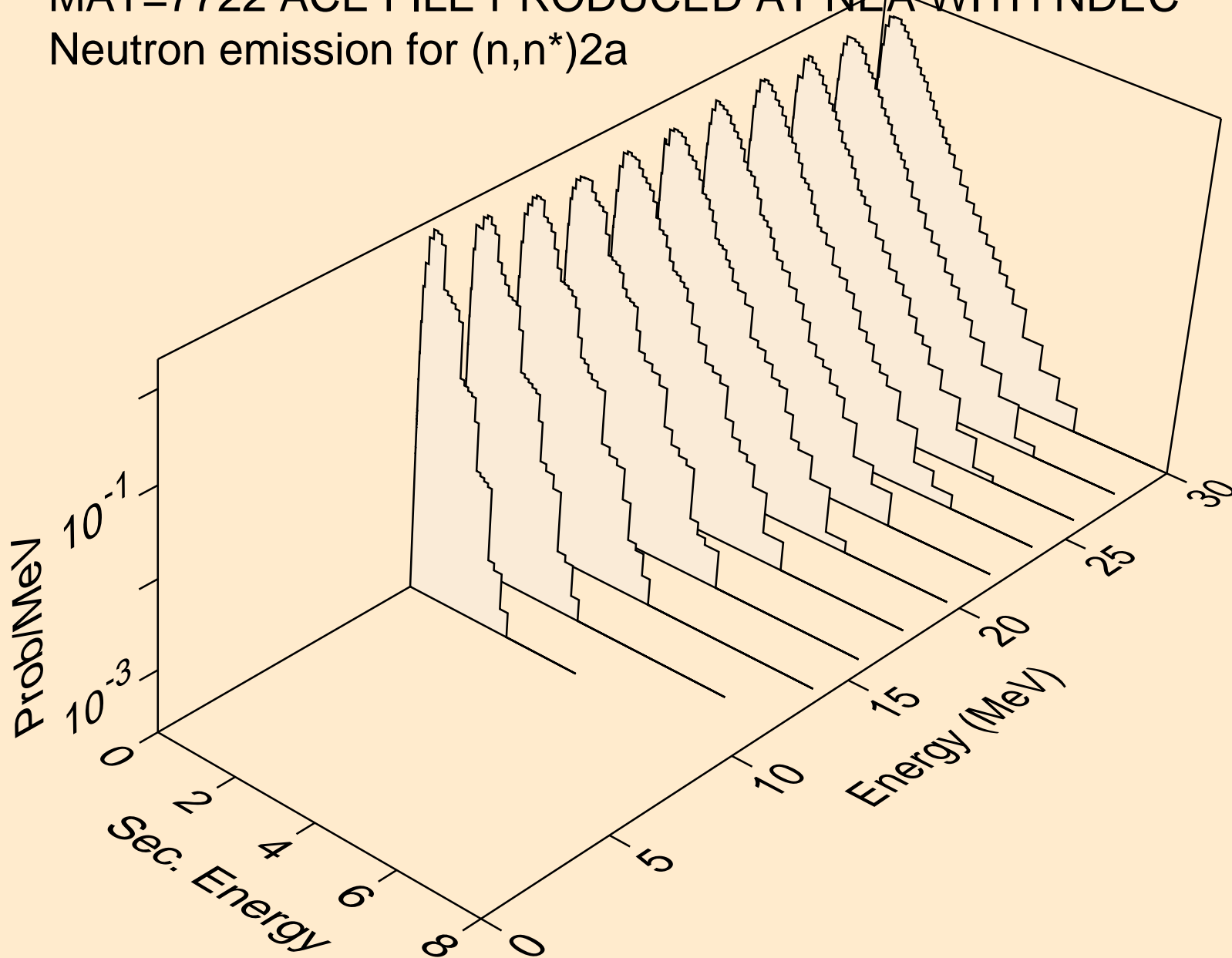

MAT=7722 ACE FILE PRODUCED AT NEA WITH NDEC
Neutron emission for (n,n*)d

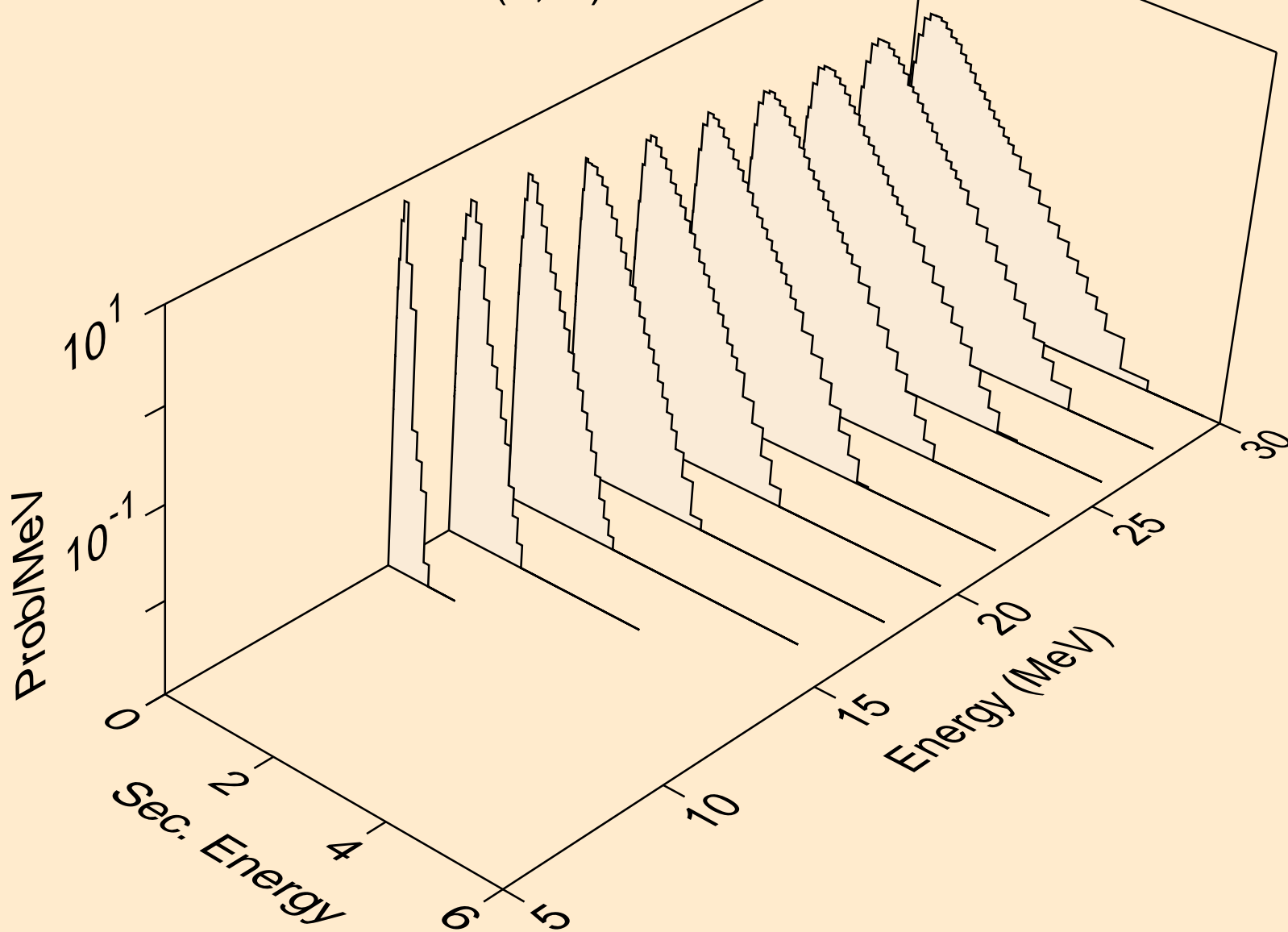

MAT=7722 ACE FILE PRODUCED AT NEA WITH NDEC
Neutron emission for (n,n*)t

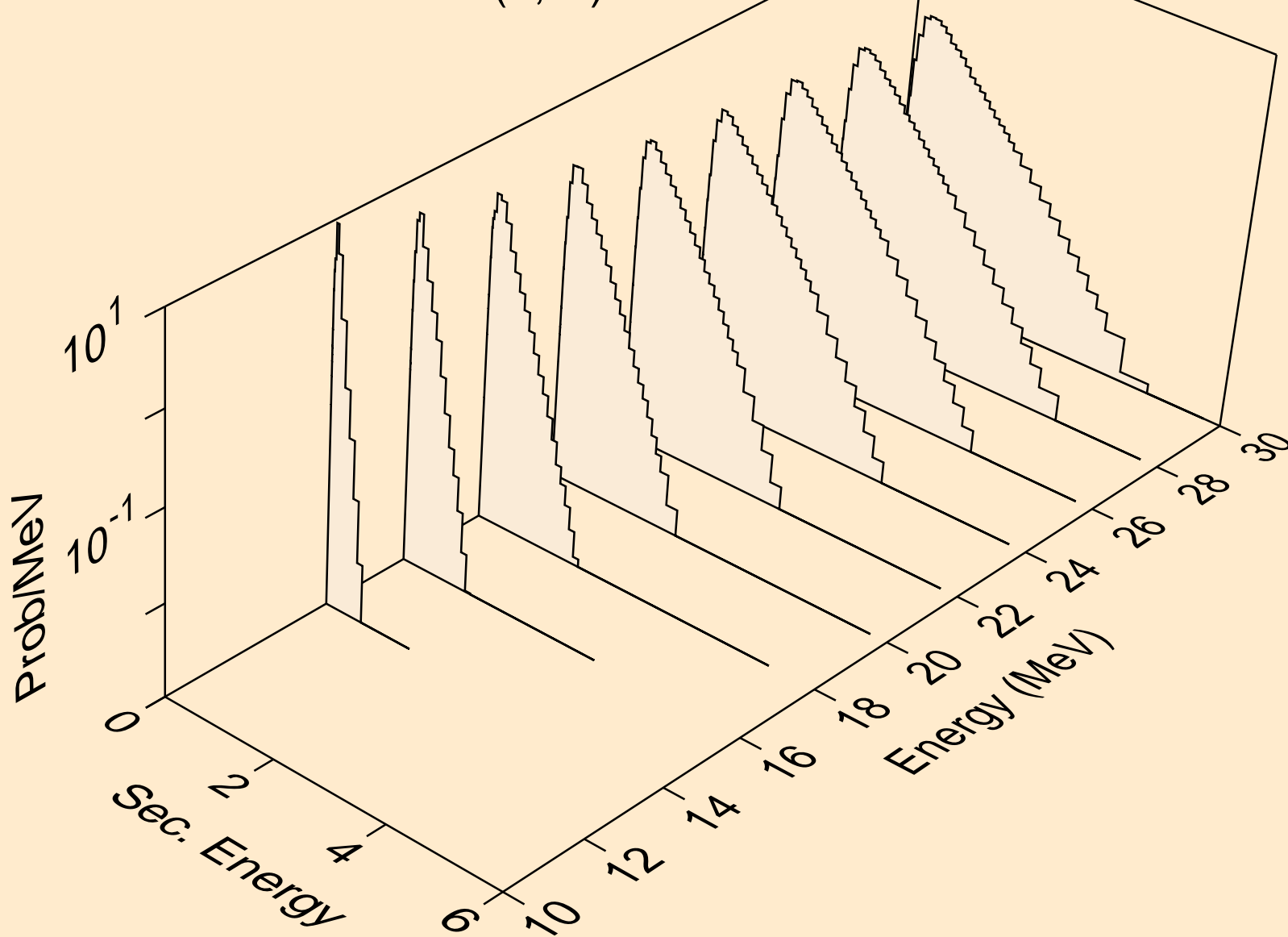

MAT=7722 ACE FILE PRODUCED AT NEA WITH NDEC
Neutron emission for (n,n*)he3

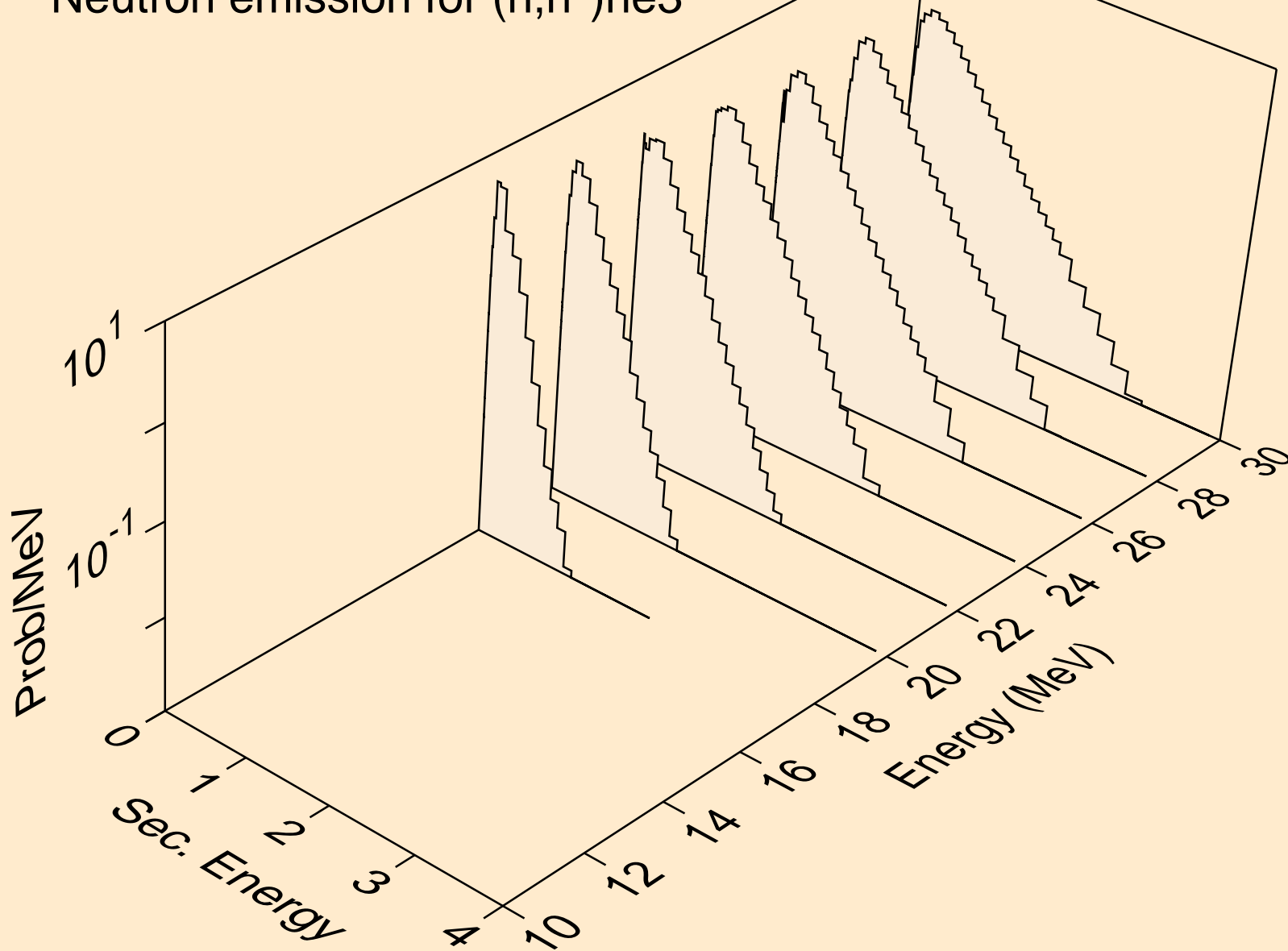

MAT=7722 ACE FILE PRODUCED AT NEA WITH NDEC
Neutron emission for (n,4n)

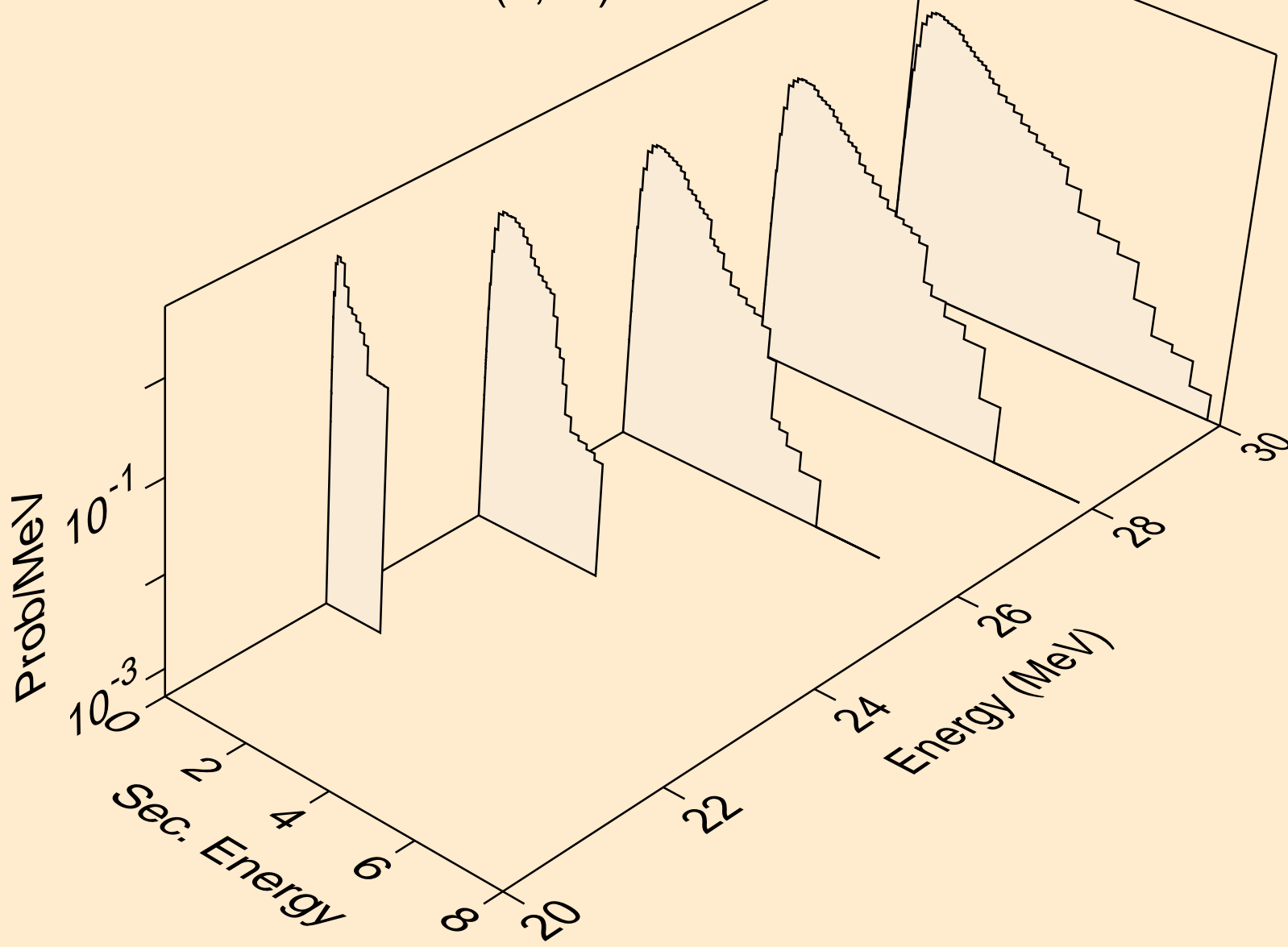

MAT=7722 ACE FILE PRODUCED AT NEA WITH NDEC
Neutron emission for (n,2np)

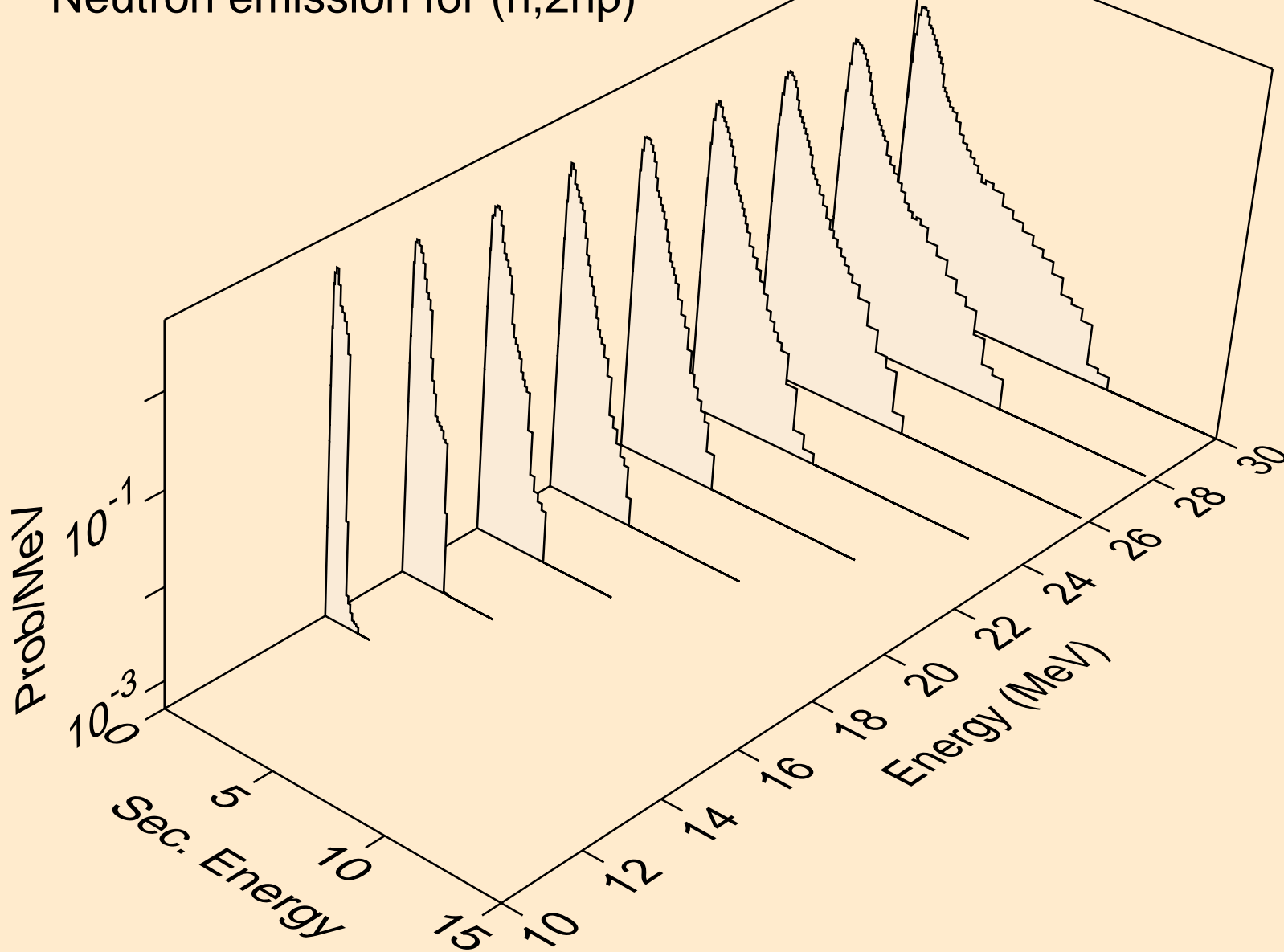

MAT=7722 ACE FILE PRODUCED AT NEA WITH NDEC
Neutron emission for (n,3np)

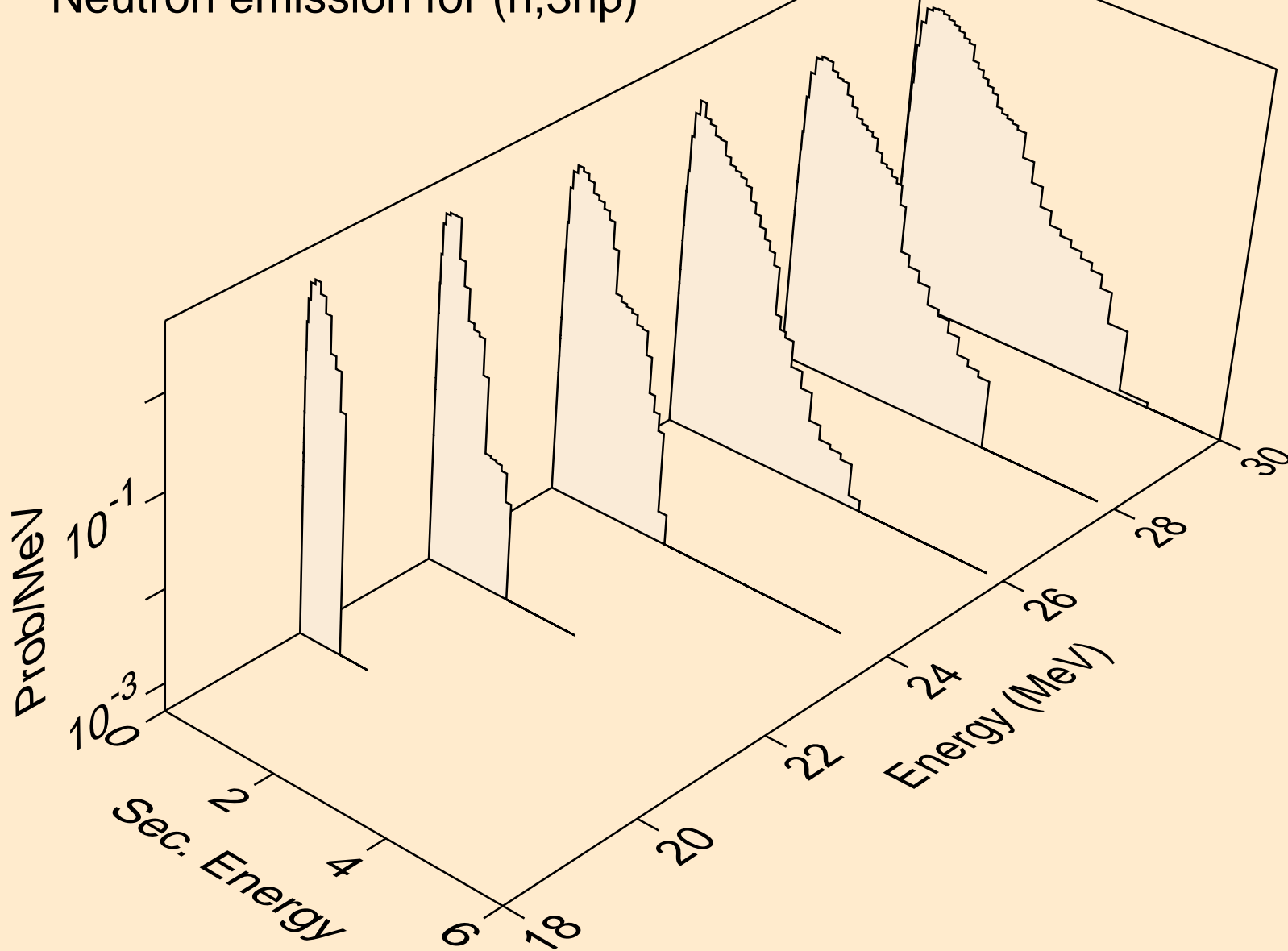

MAT=7722 ACE FILE PRODUCED AT NEA WITH NDEC
Neutron emission for (n,2np)

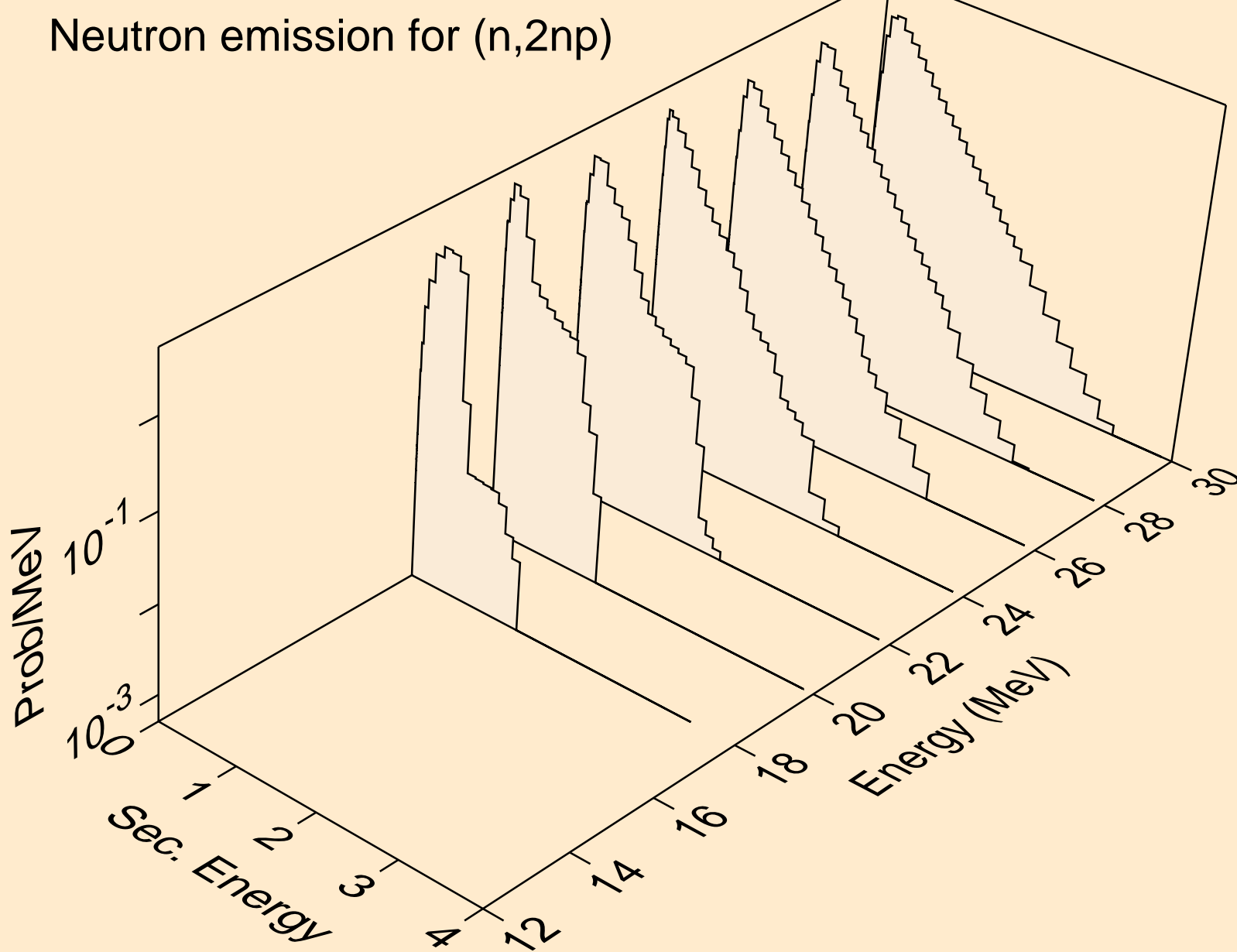

MAT=7722 ACE FILE PRODUCED AT NEA WITH NDEC
Neutron emission for (n,npa)

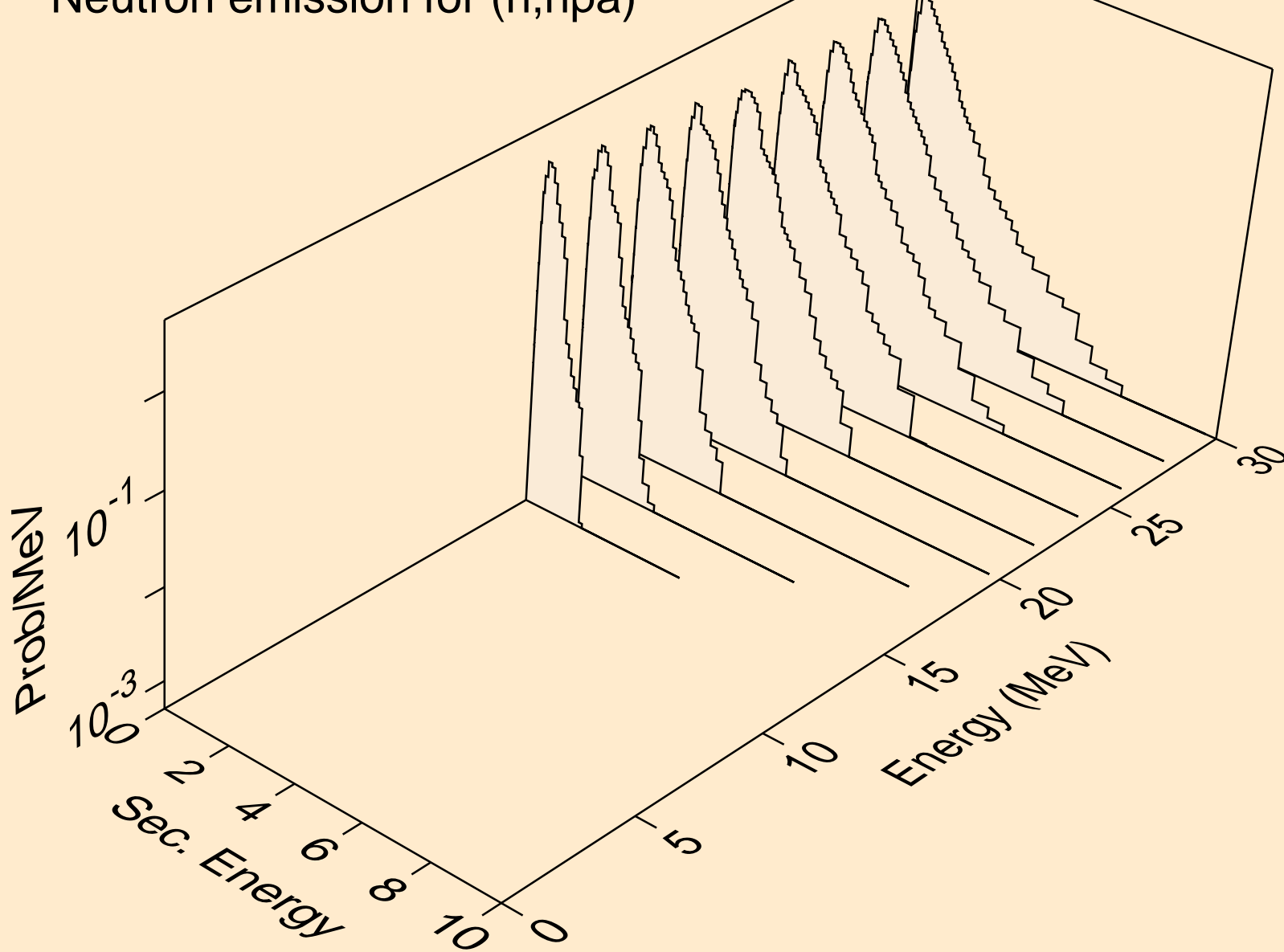

MAT=7722 ACE FILE PRODUCED AT NEA WITH NDEC
Neutron emission for (n,n*c)

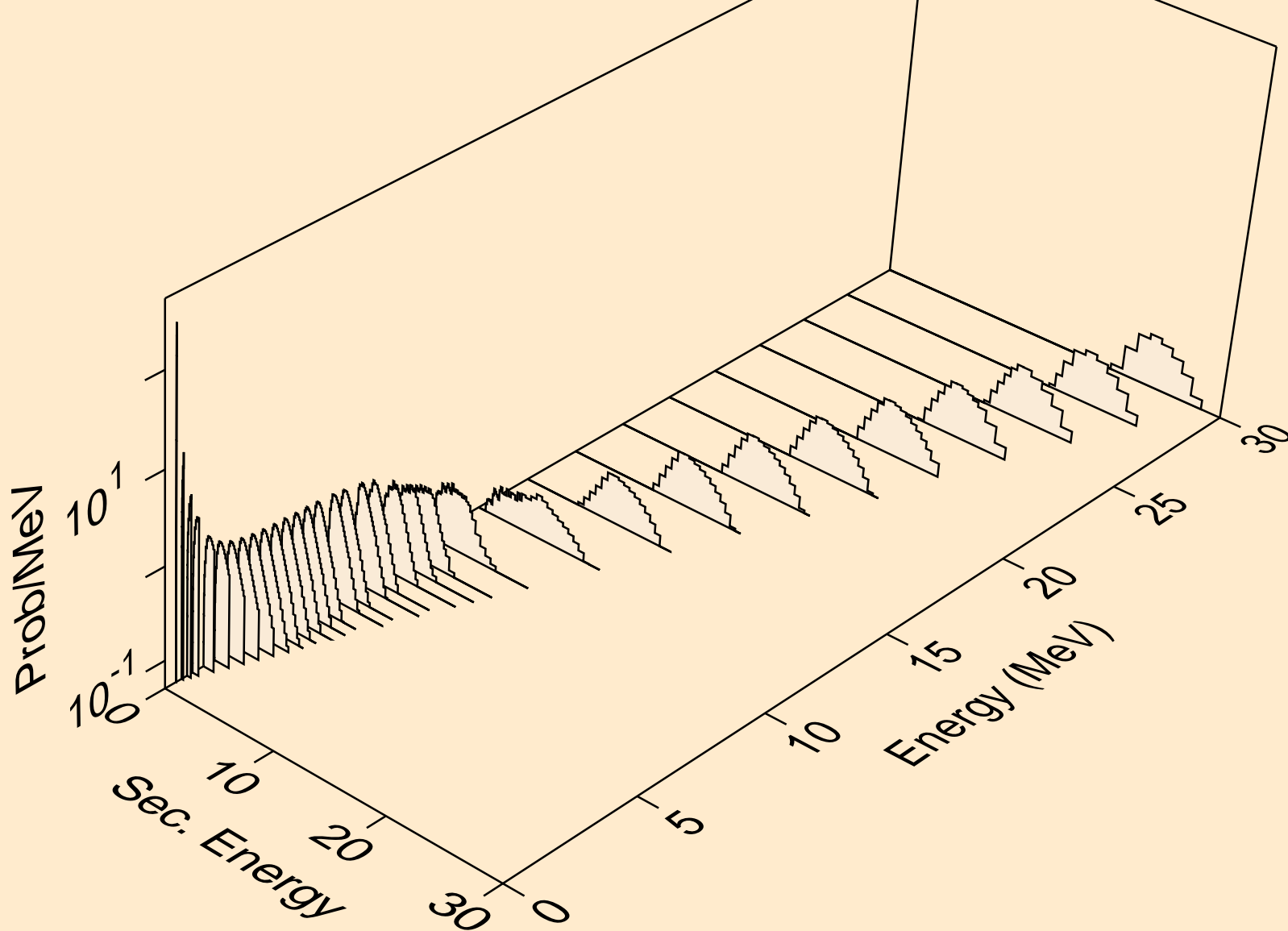

MAT=7722 ACE FILE PRODUCED AT NEA WITH NDEC
Photon emission for (n,x)

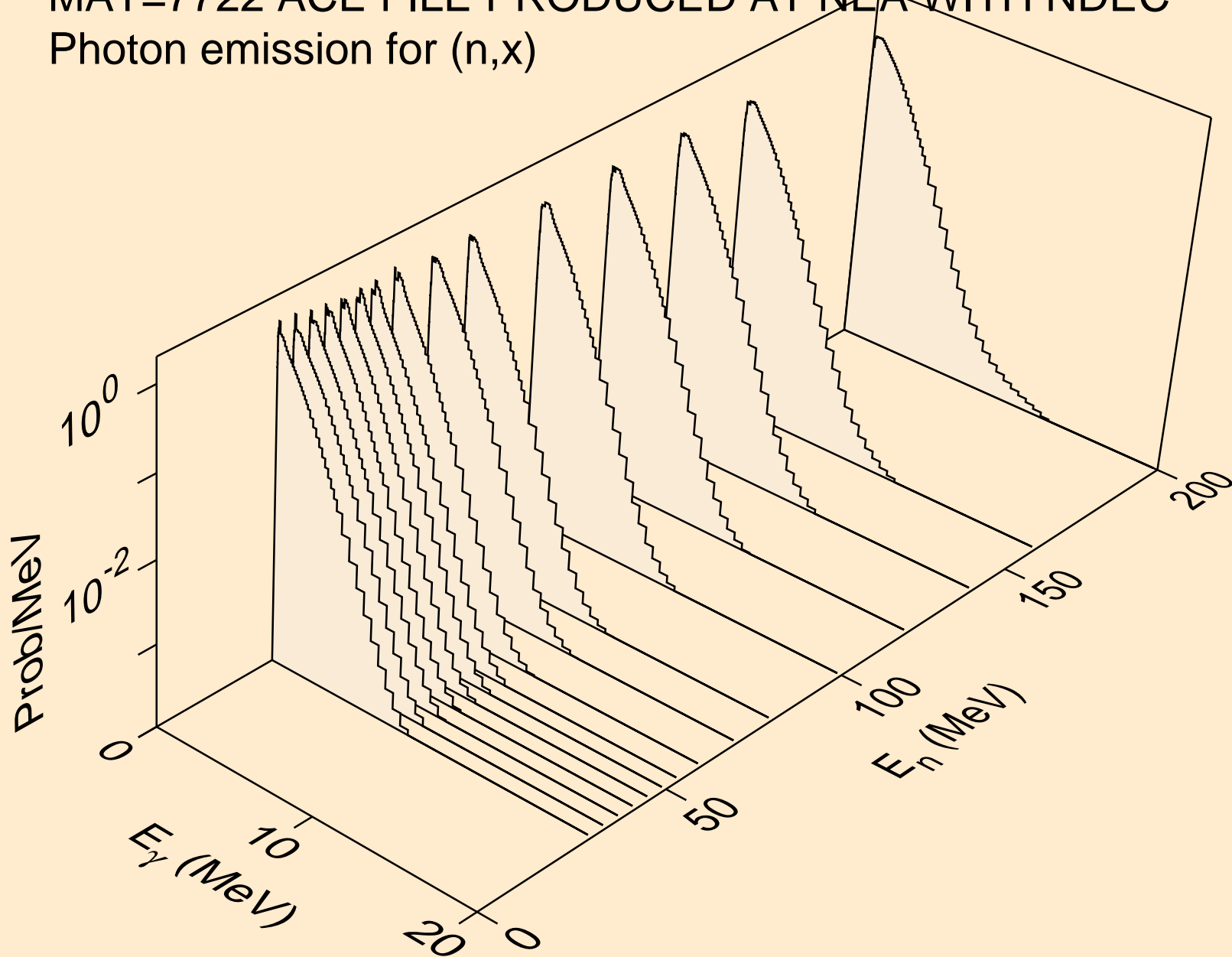

MAT=7722 ACE FILE PRODUCED AT NEA WITH NDEC
Photon emission for (n,2nd)

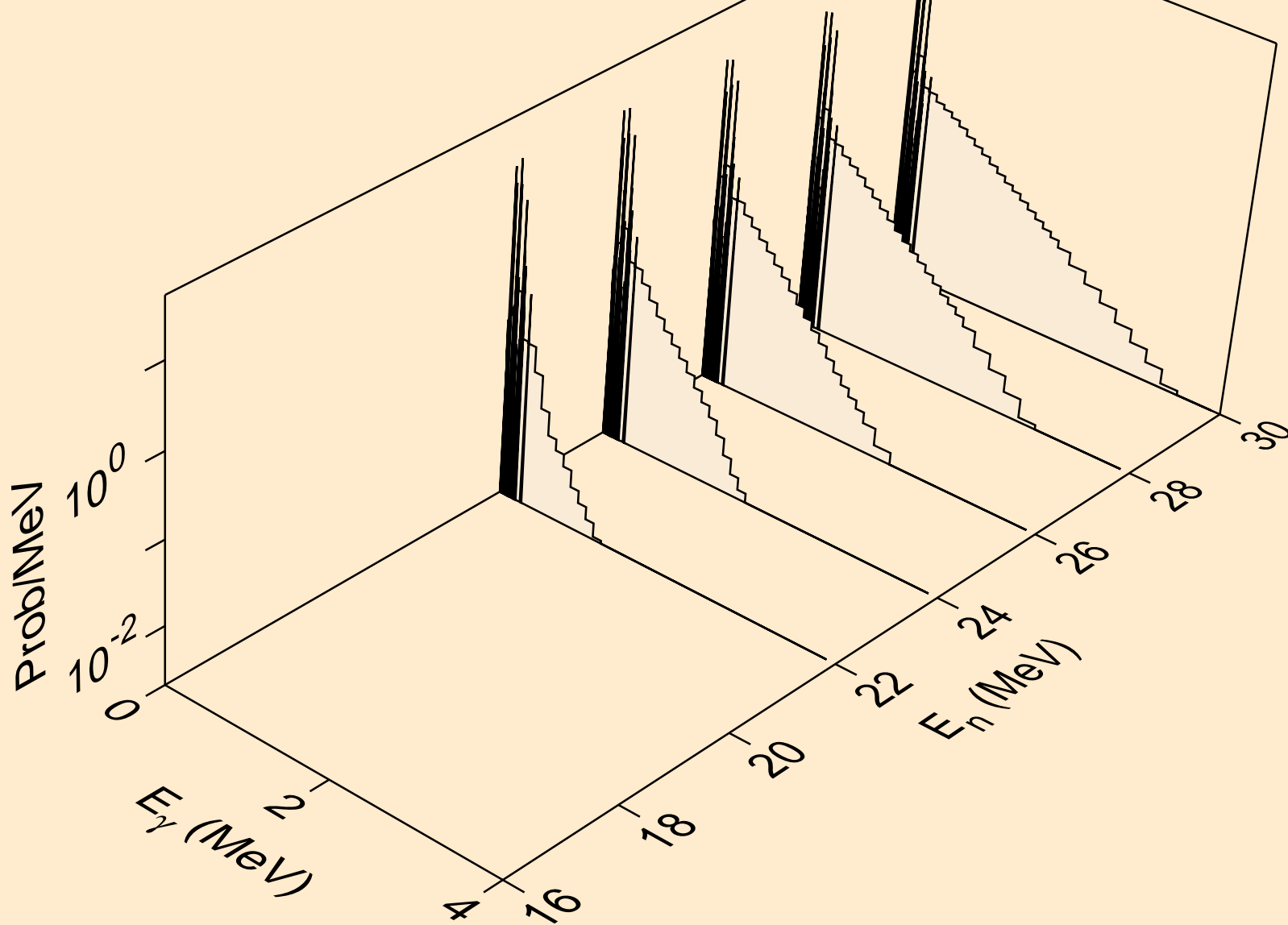

MAT=7722 ACE FILE PRODUCED AT NEA WITH NDEC
Photon emission for (n,2n)

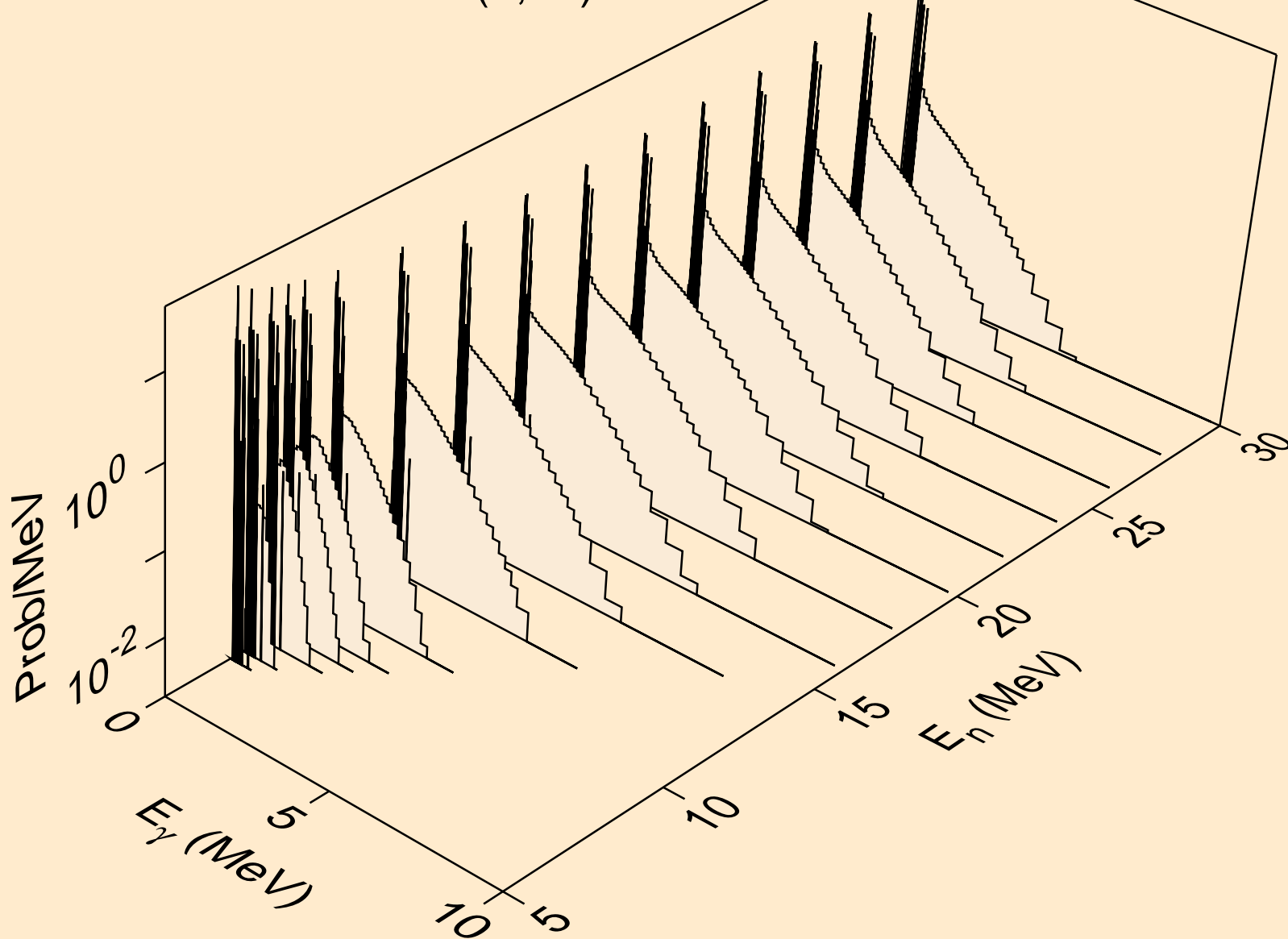

MAT=7722 ACE FILE PRODUCED AT NEA WITH NDEC
Photon emission for (n,3n)

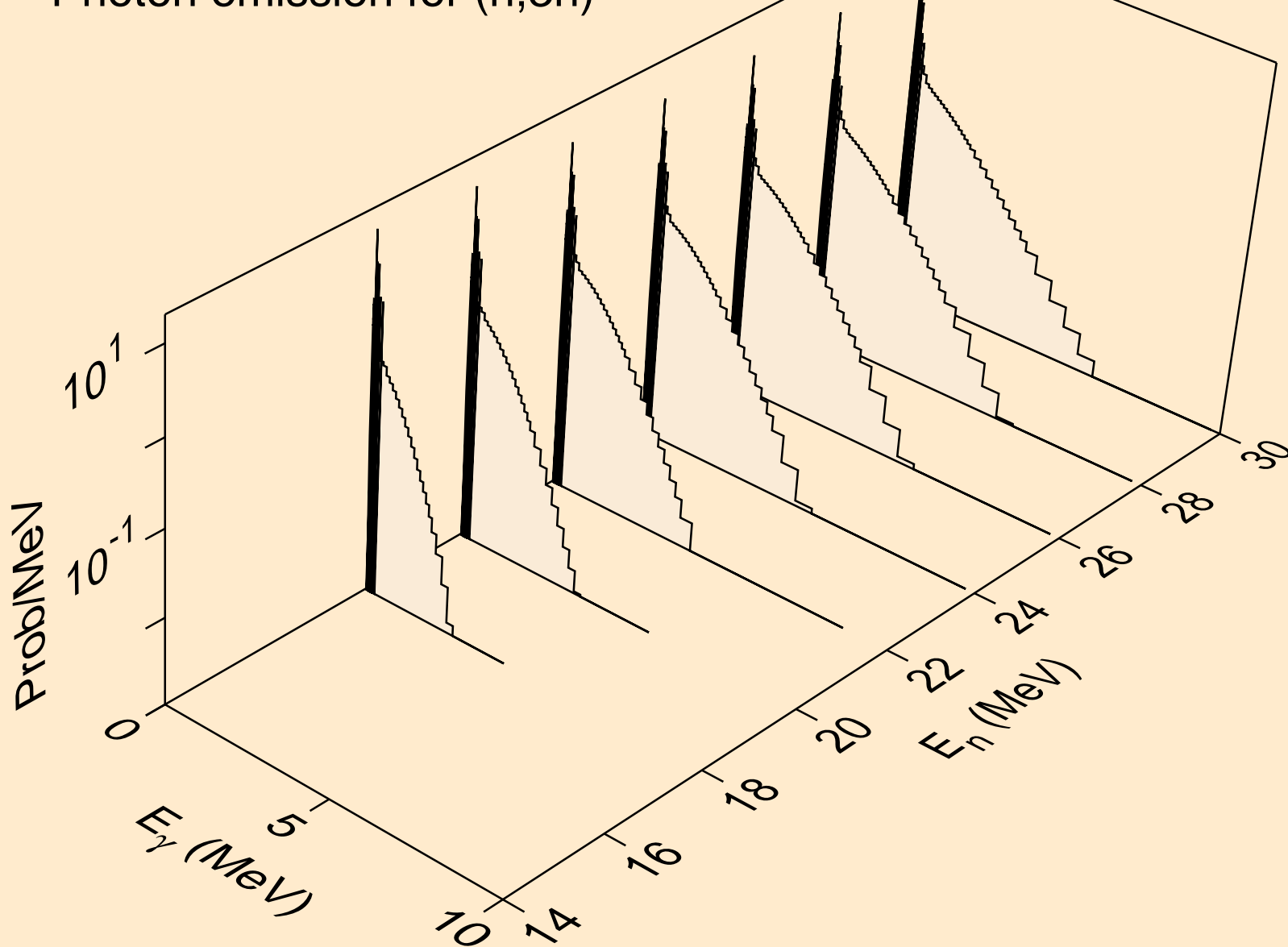

MAT=7722 ACE FILE PRODUCED AT NEA WITH NDEC
Photon emission for (n,n*)a

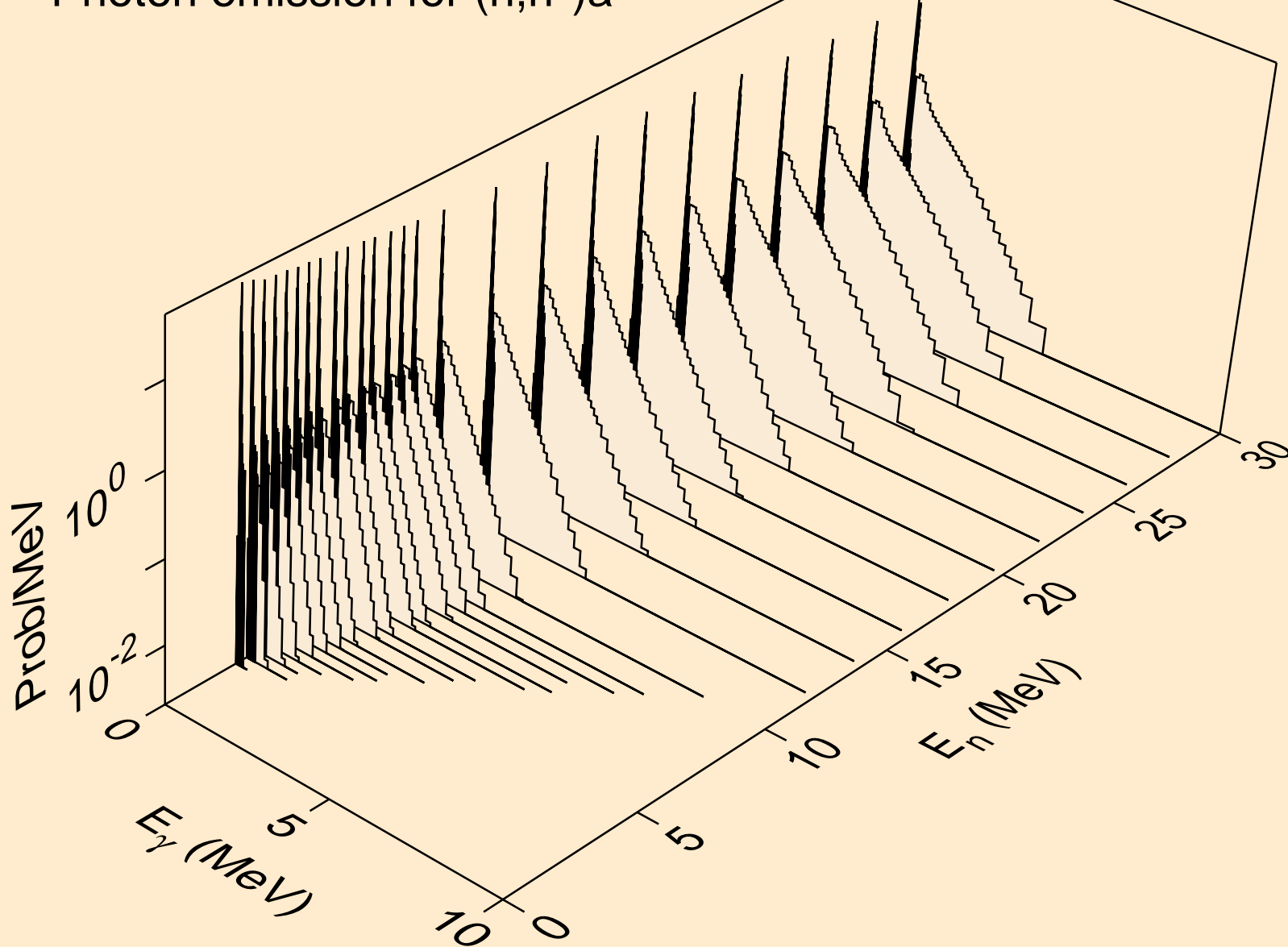

MAT=7722 ACE FILE PRODUCED AT NEA WITH NDEC
Photon emission for (n,2n)a

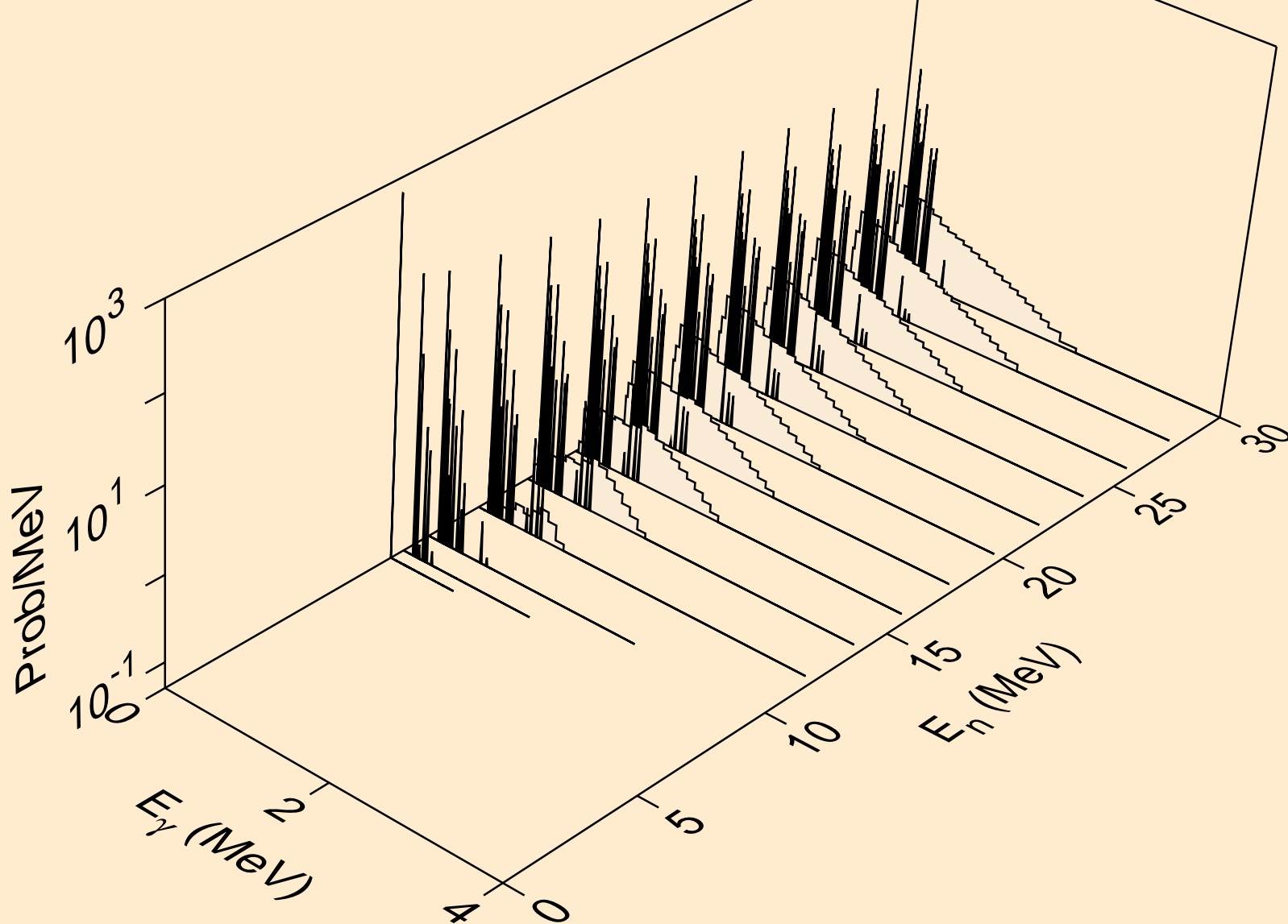

MAT=7722 ACE FILE PRODUCED AT NEA WITH NDEC
Photon emission for (n,3n)a

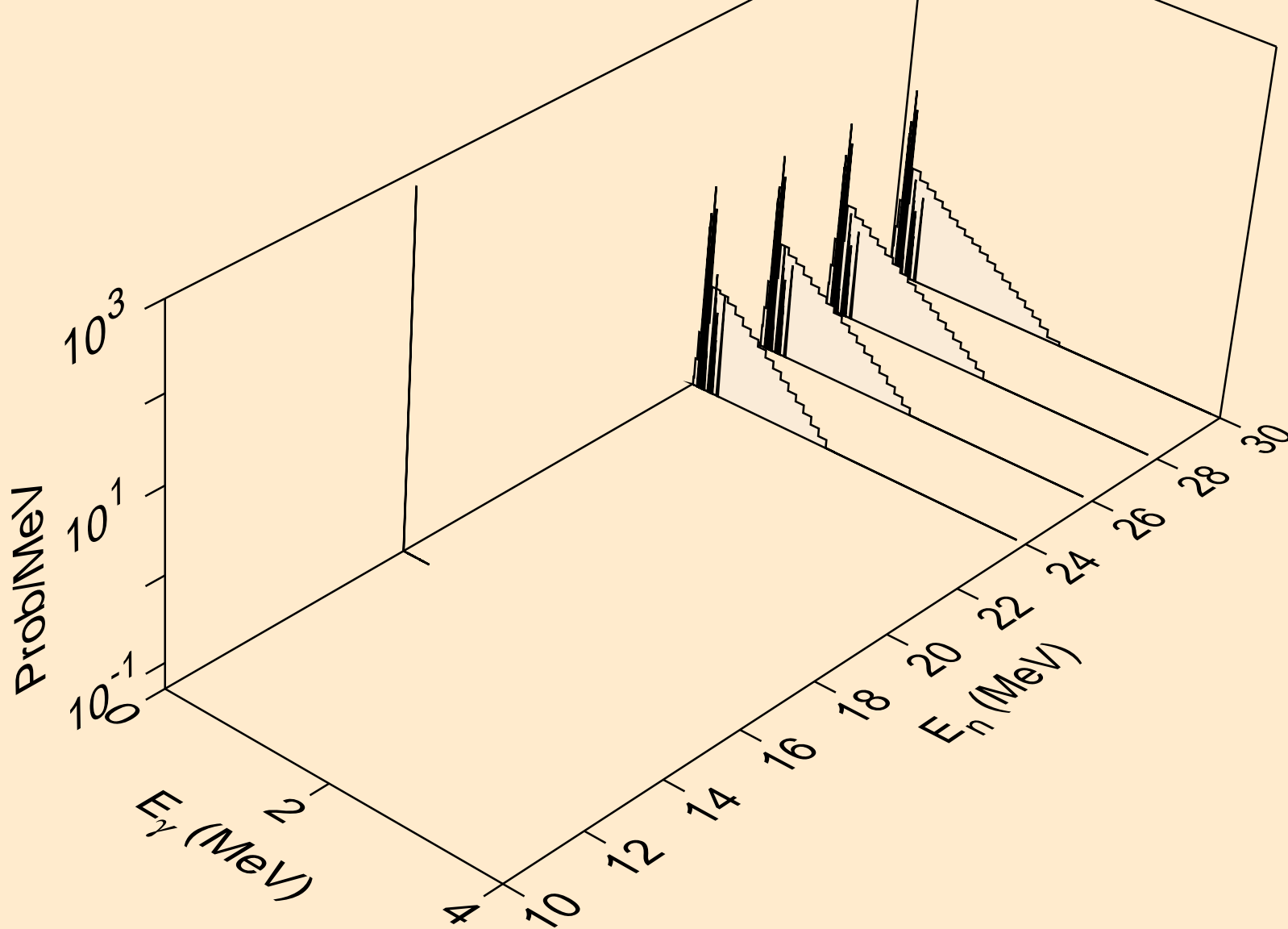

MAT=7722 ACE FILE PRODUCED AT NEA WITH NDEC
Photon emission for (n,n*)p

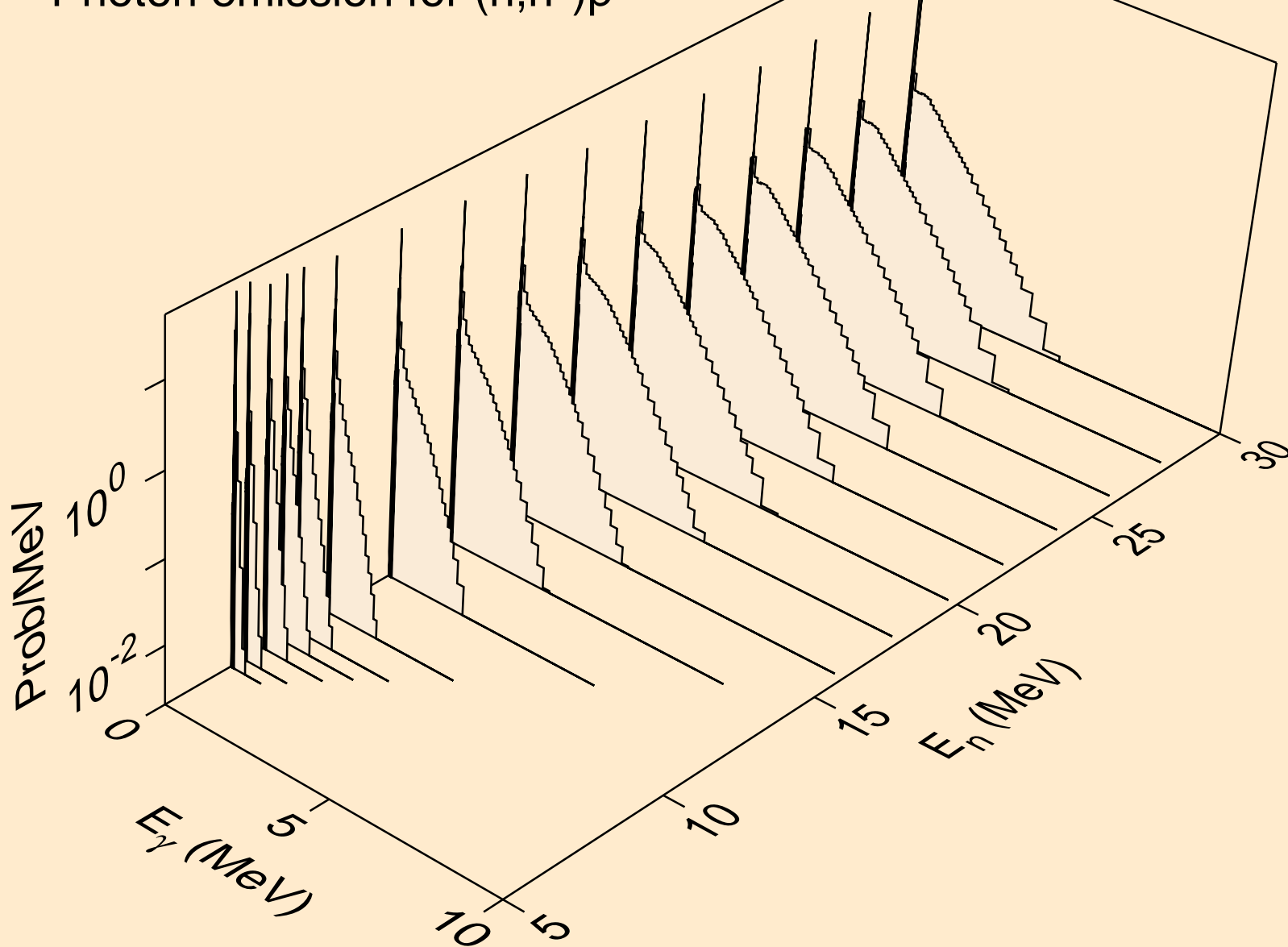

MAT=7722 ACE FILE PRODUCED AT NEA WITH NDEC
Photon emission for (n,n*)2a

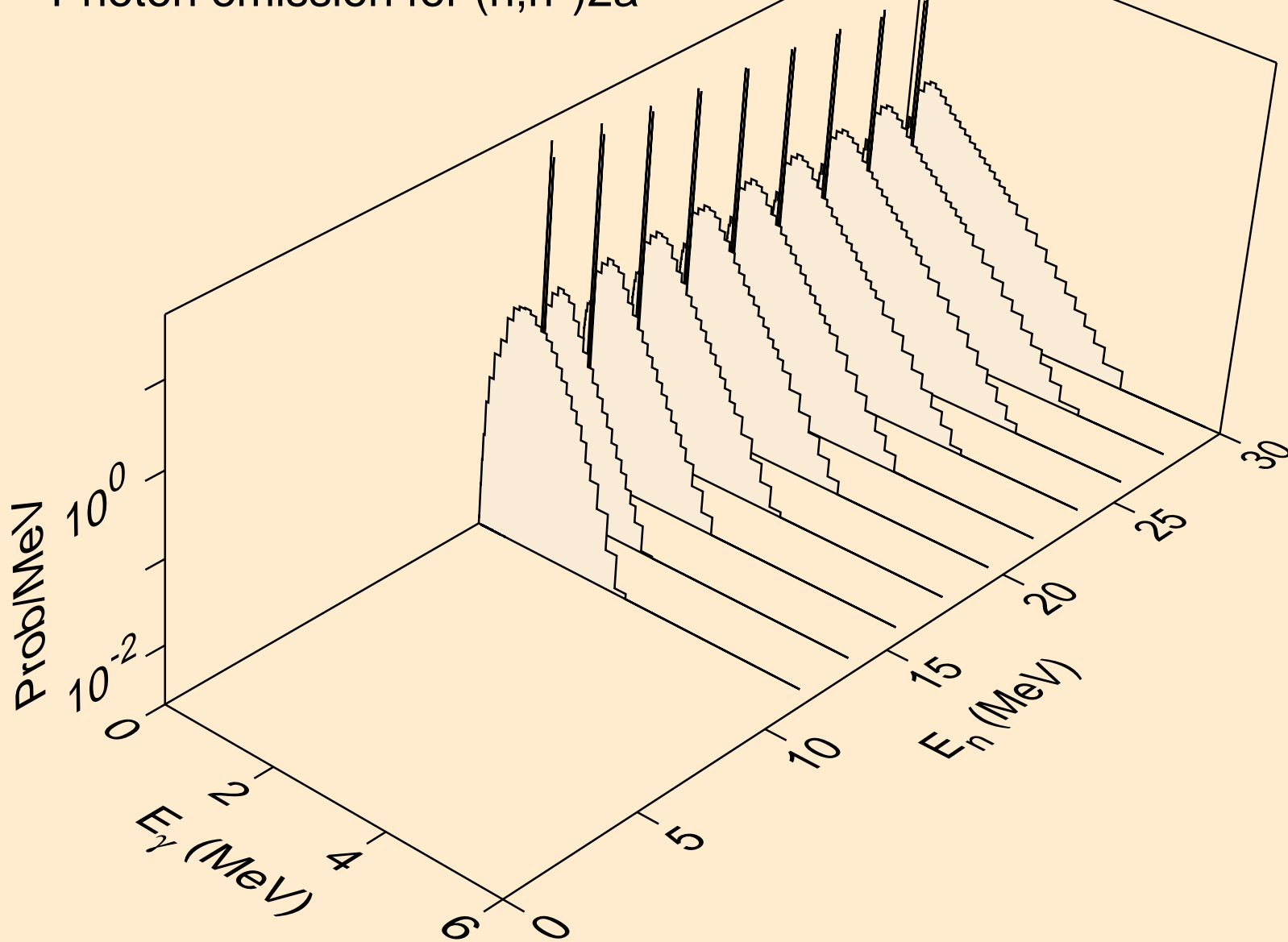

MAT=7722 ACE FILE PRODUCED AT NEA WITH NDEC
Photon emission for (n,n*)d

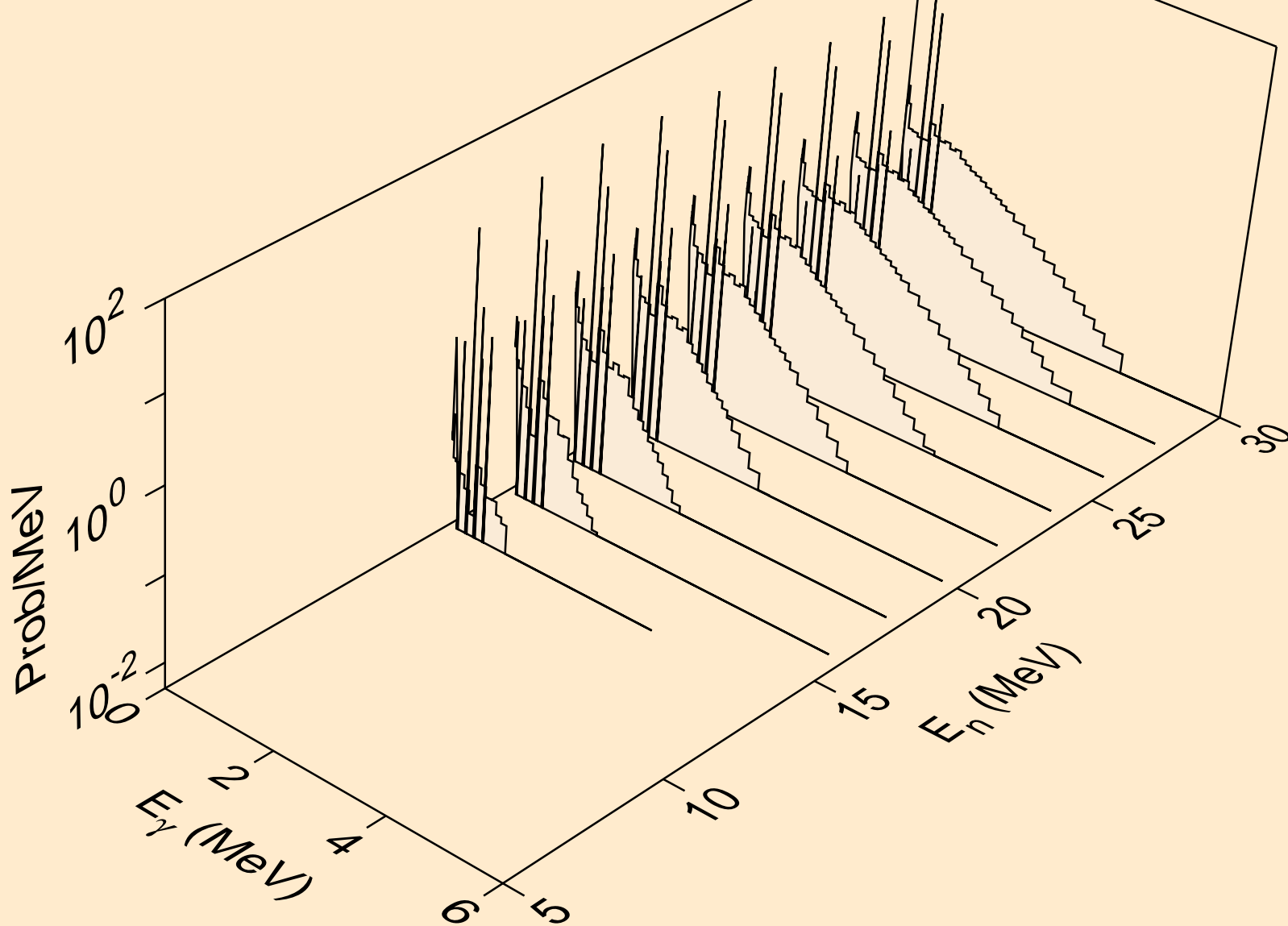

MAT=7722 ACE FILE PRODUCED AT NEA WITH NDEC
Photon emission for (n,n*)t

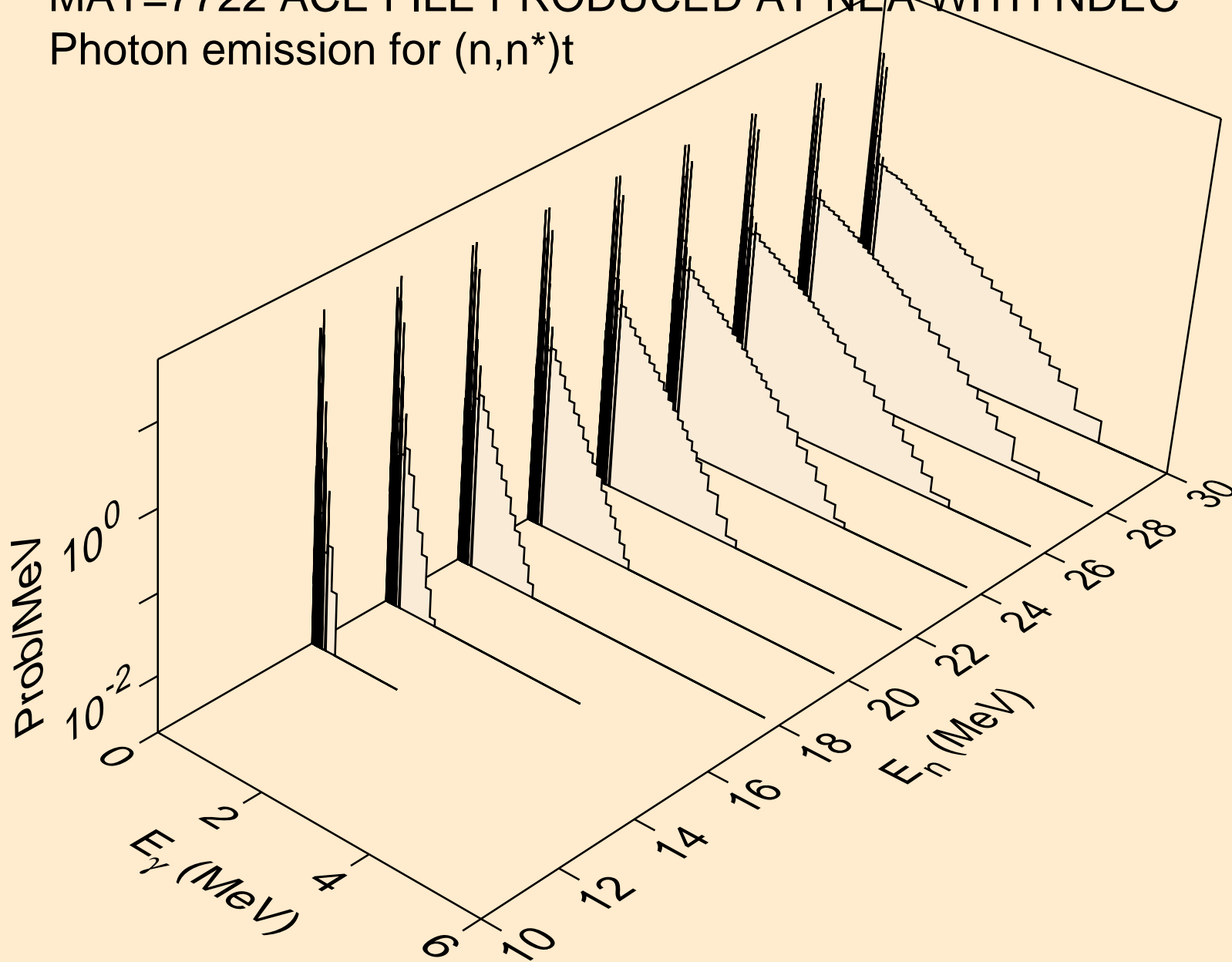

MAT=7722 ACE FILE PRODUCED AT NEA WITH NDEC
Photon emission for (n,n*)he3

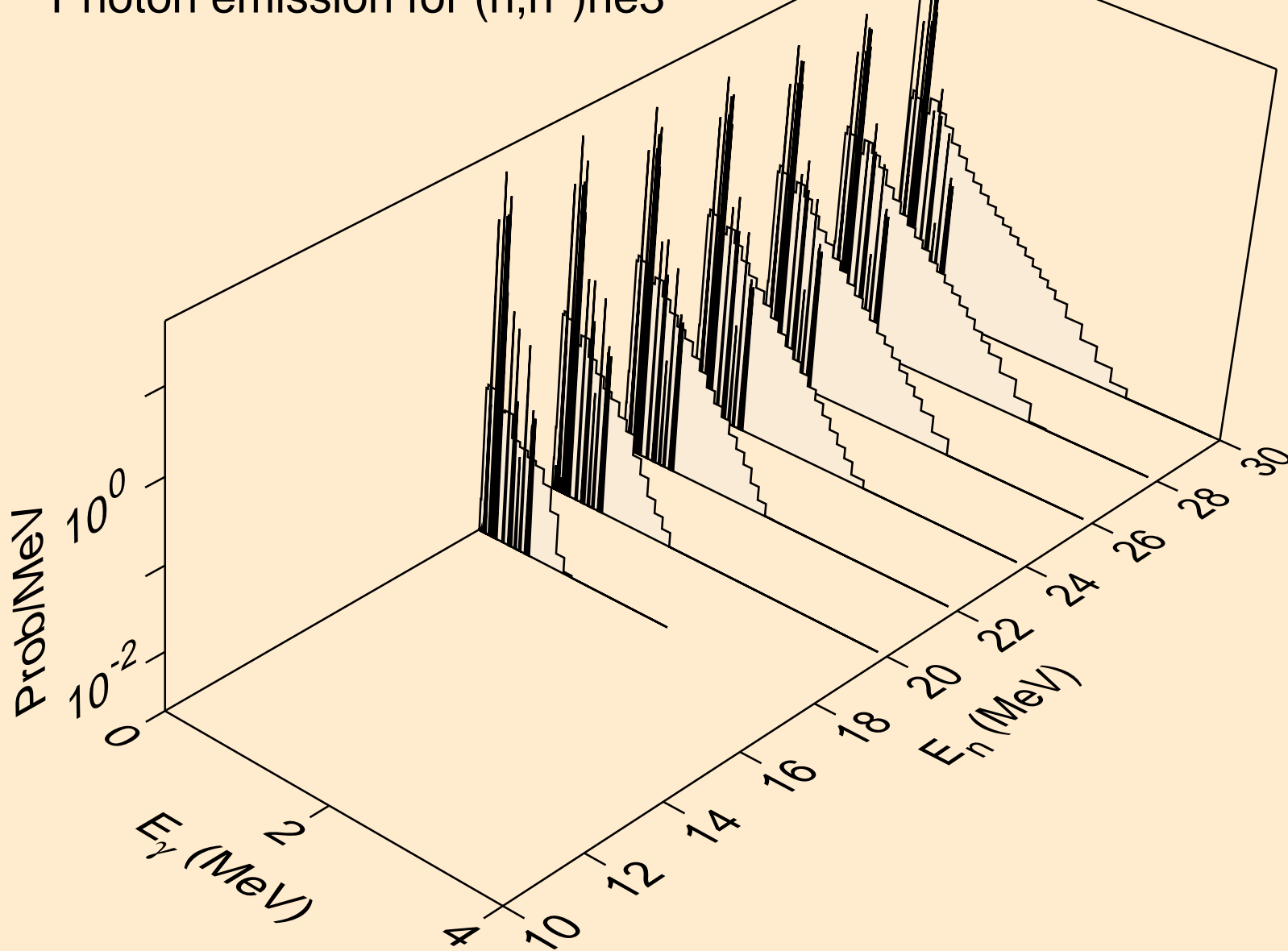

MAT=7722 ACE FILE PRODUCED AT NEA WITH NDEC
Photon emission for (n,4n)

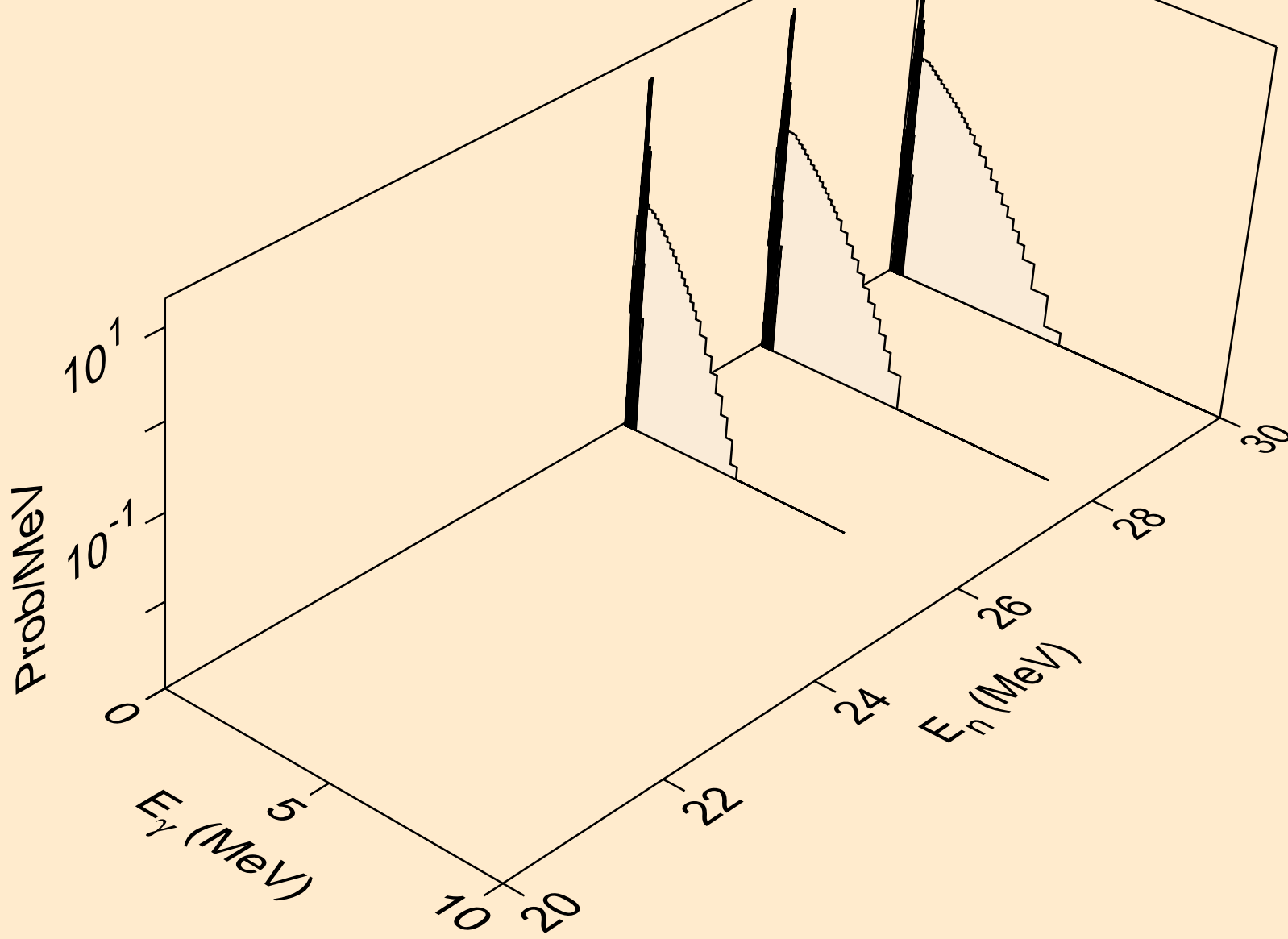

MAT=7722 ACE FILE PRODUCED AT NEA WITH NDEC
Photon emission for (n,2np)

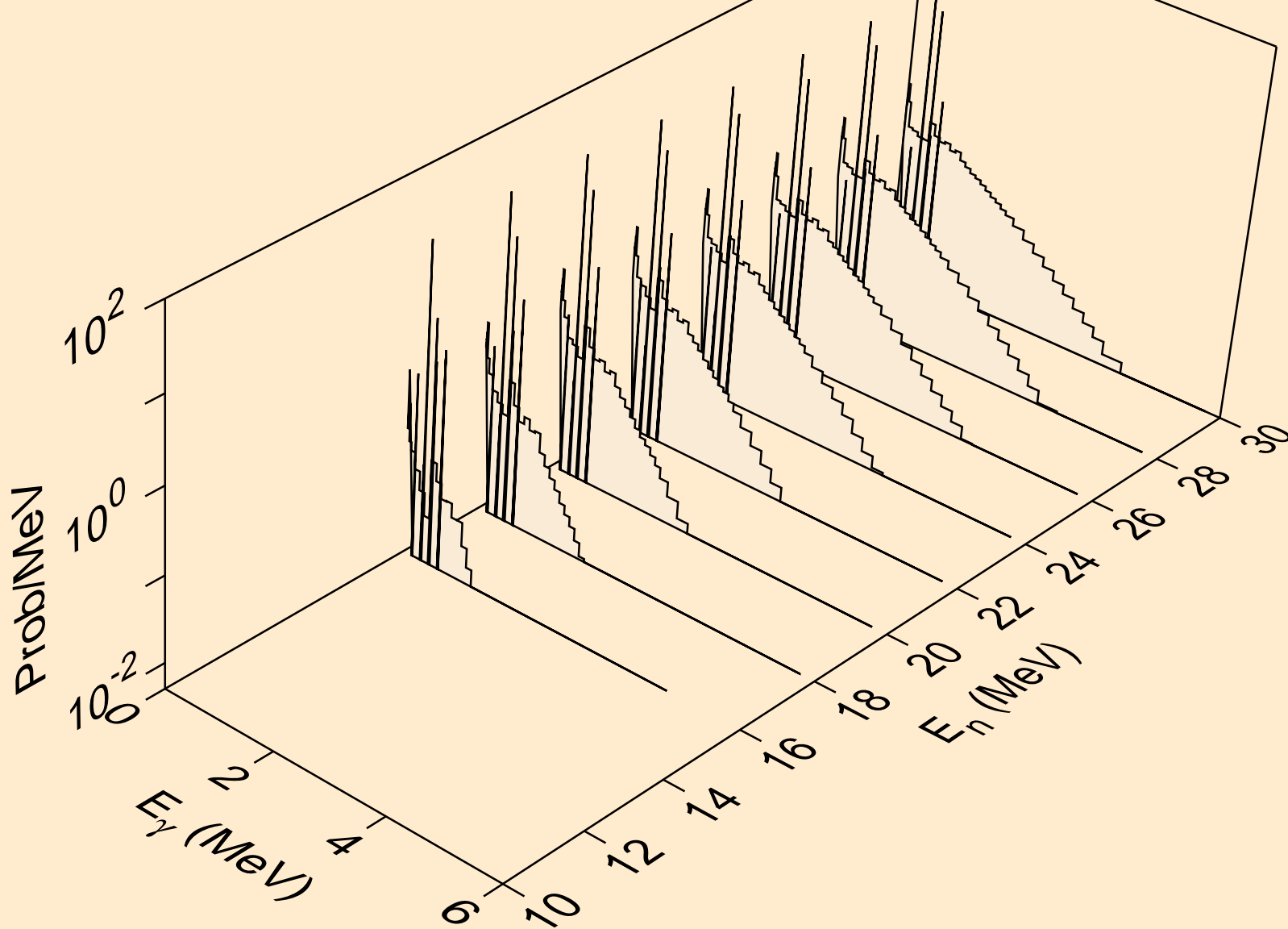

MAT=7722 ACE FILE PRODUCED AT NEA WITH NDEC
Photon emission for (n,3np)

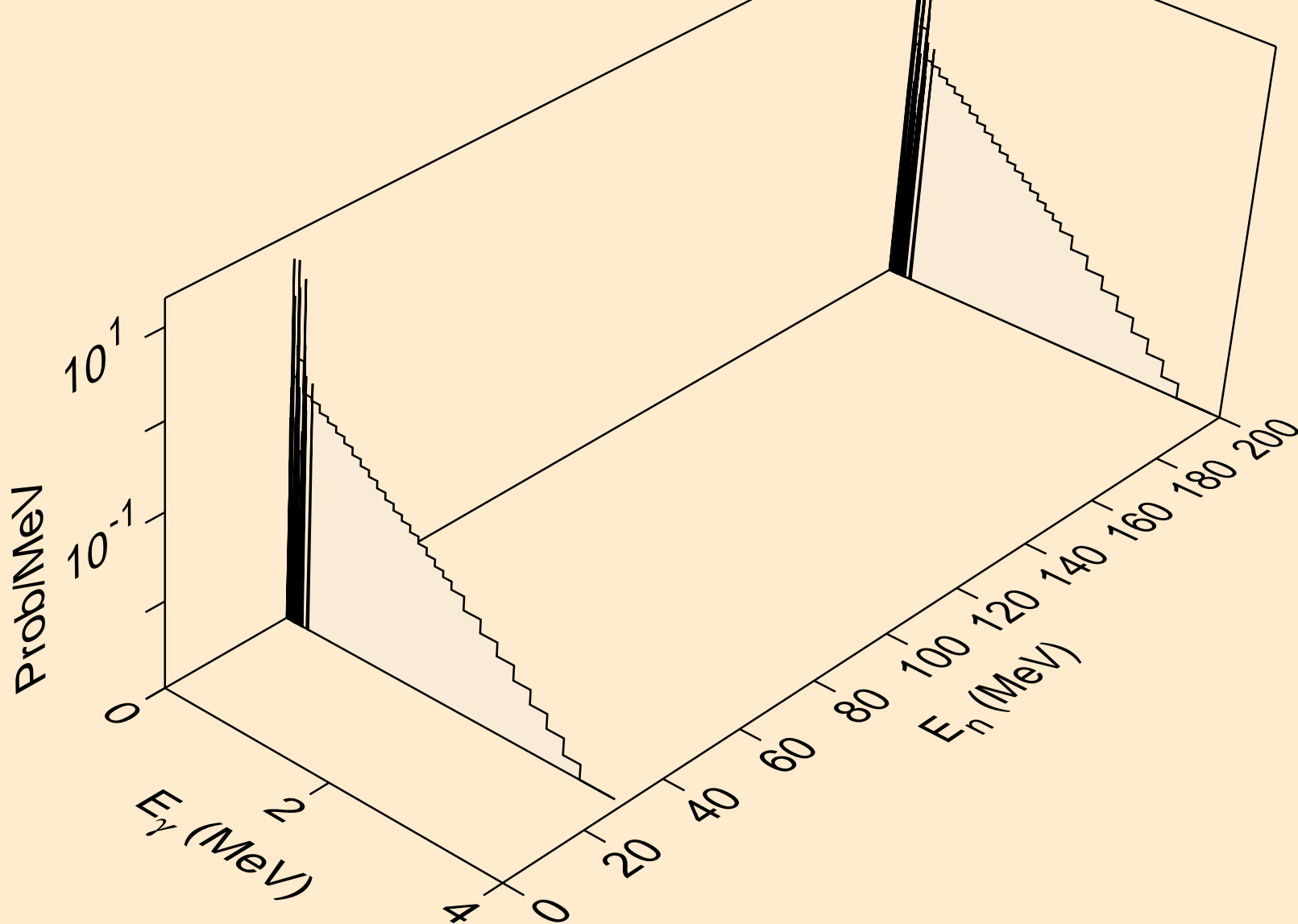

MAT=7722 ACE FILE PRODUCED AT NEA WITH NDEC
Photon emission for (n,2np)

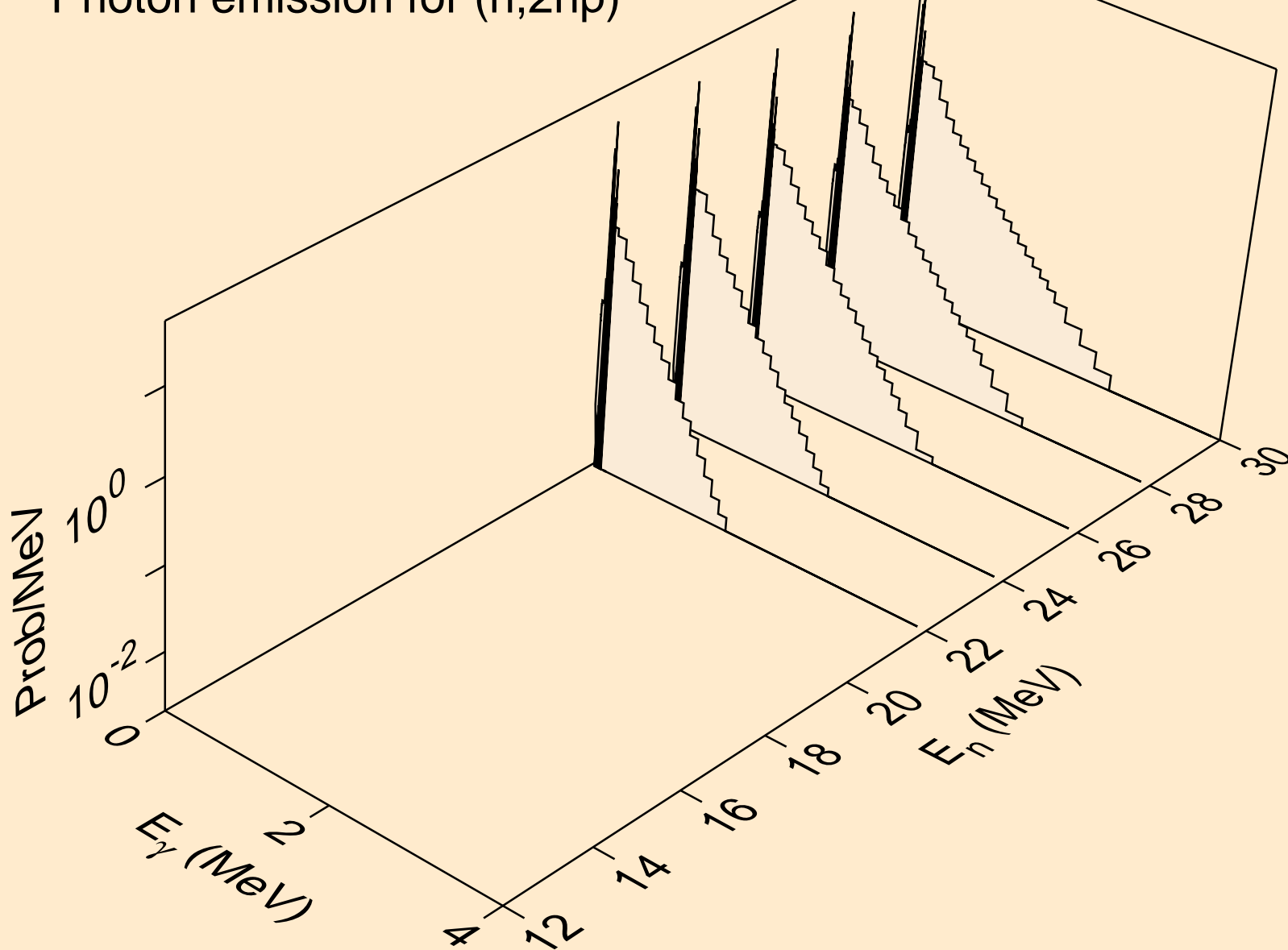

MAT=7722 ACE FILE PRODUCED AT NEA WITH NDEC
Photon emission for (n,npa)

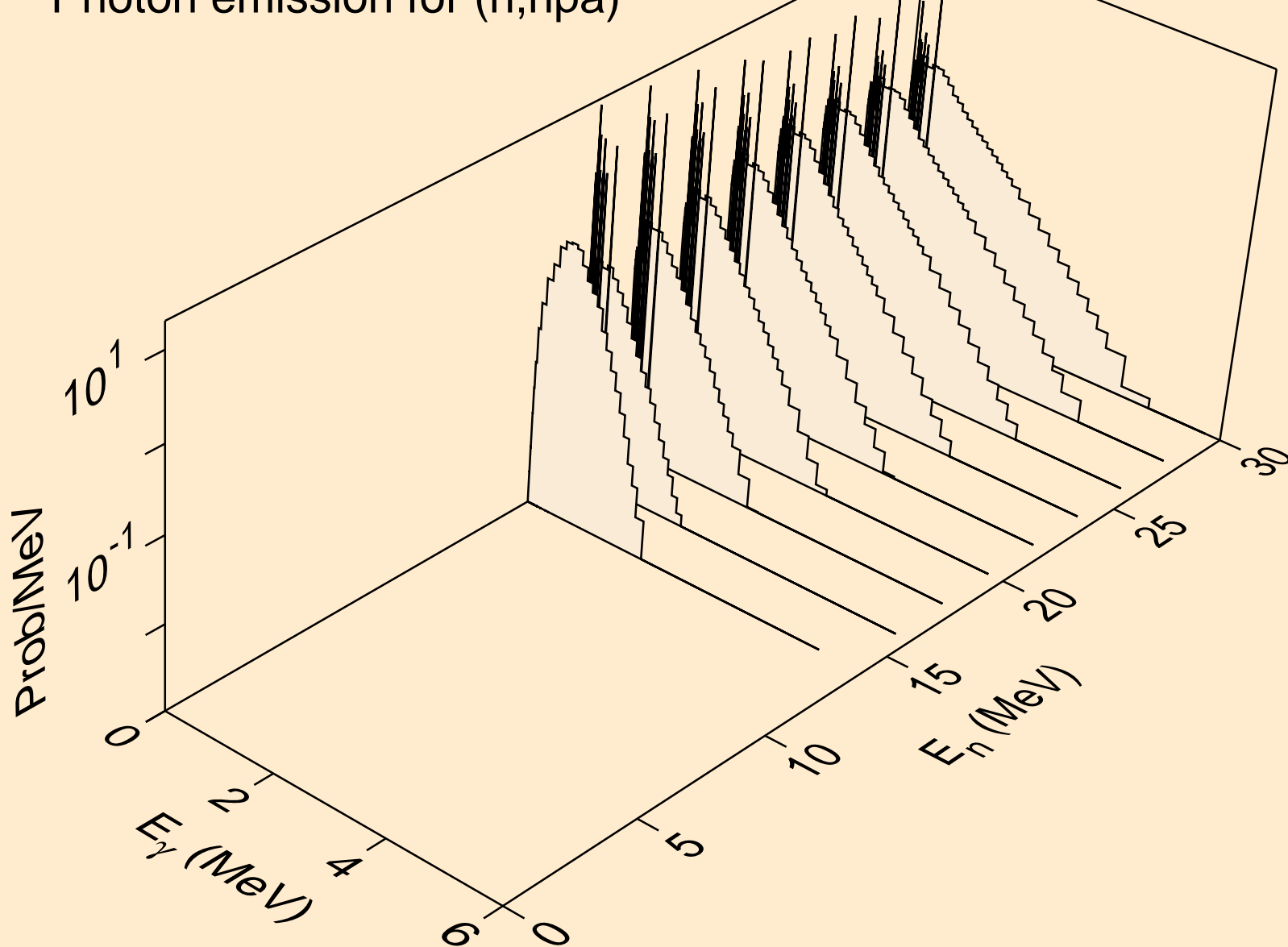

MAT=7722 ACE FILE PRODUCED AT NEA WITH NDEC
Photon emission for (n,n*c)

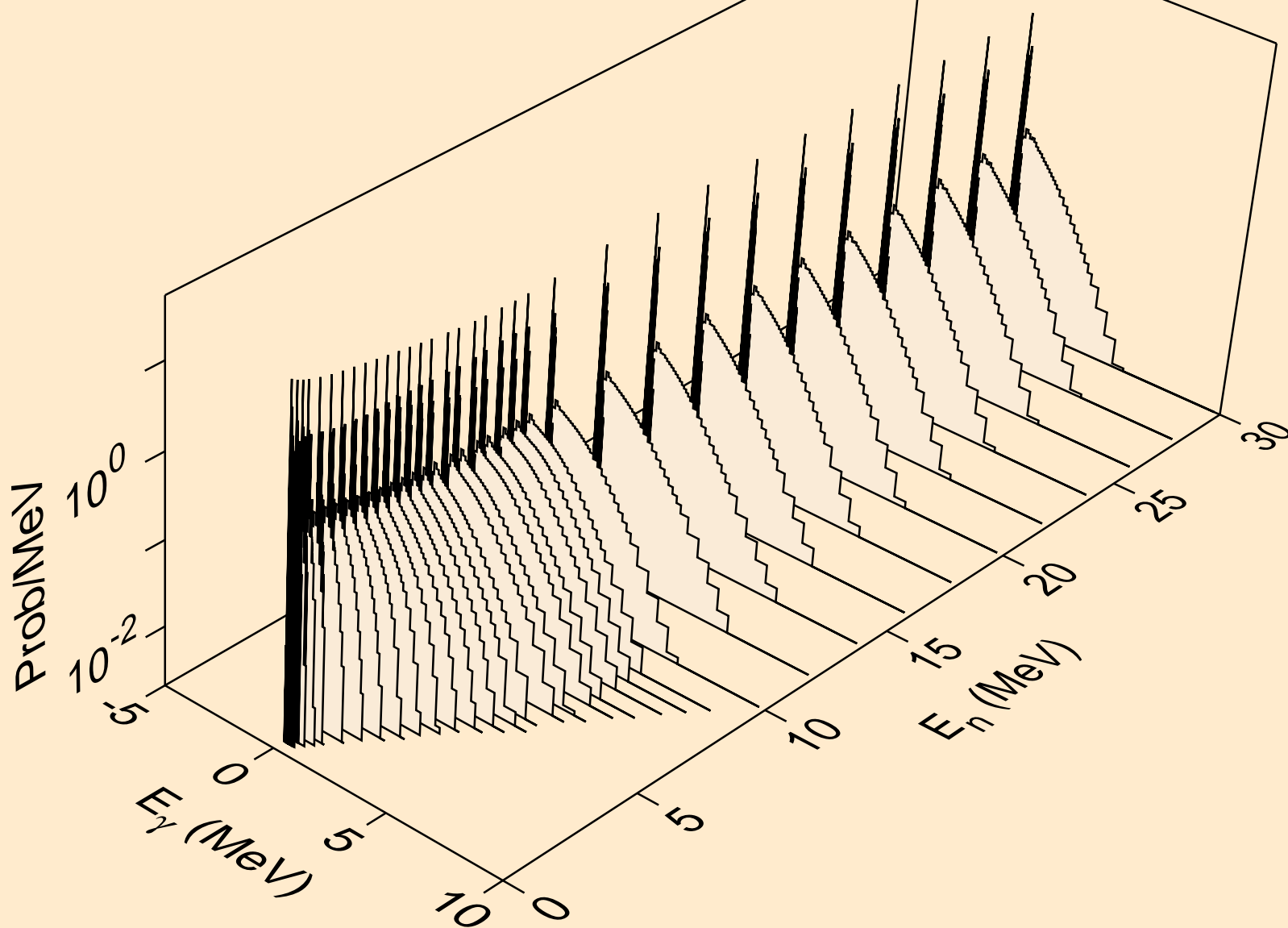

MAT=7722 ACE FILE PRODUCED AT NEA WITH NDEC
Photon emission for (n,gma)

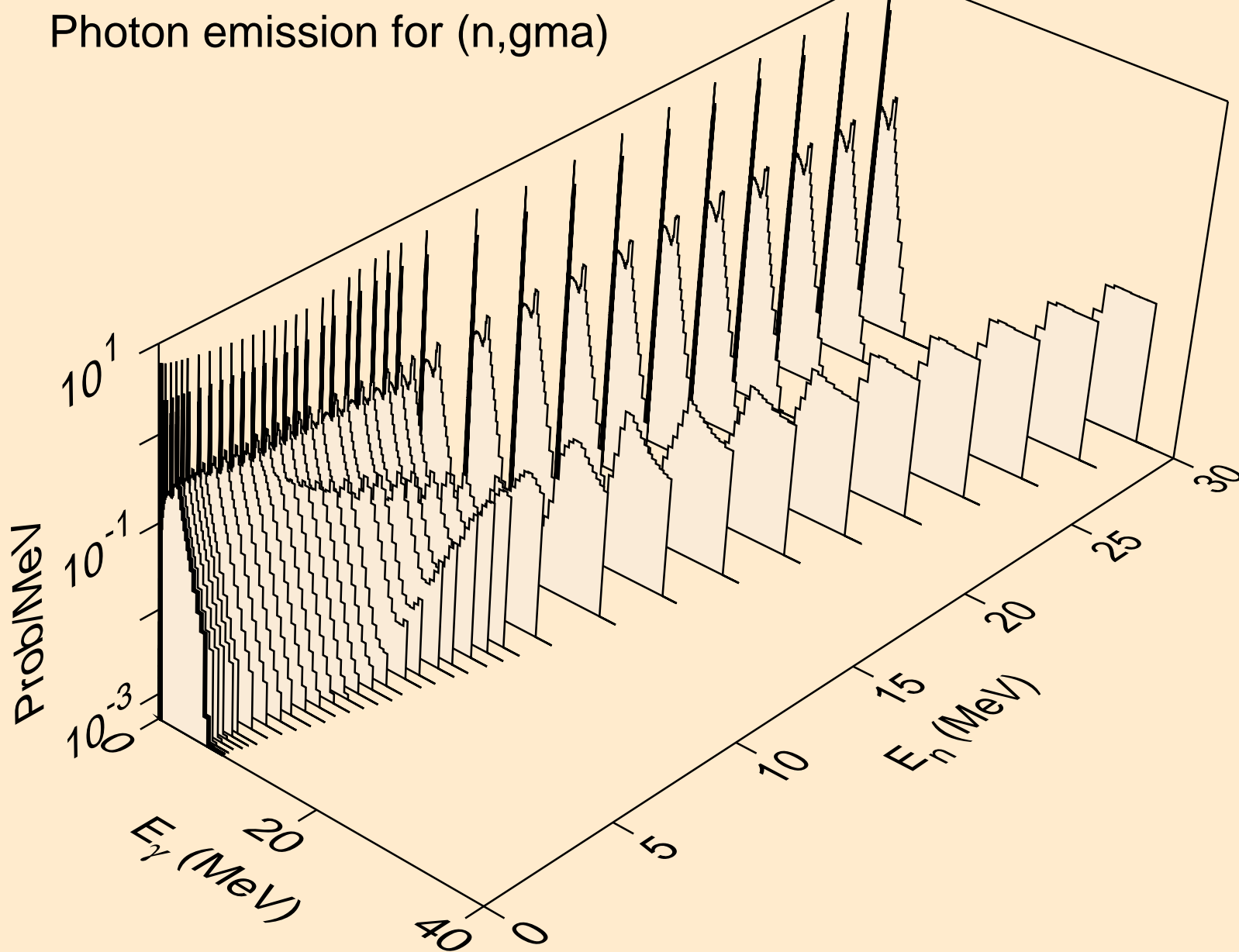

MAT=7722 ACE FILE PRODUCED AT NEA WITH NDEC
Photon emission for (n,p)

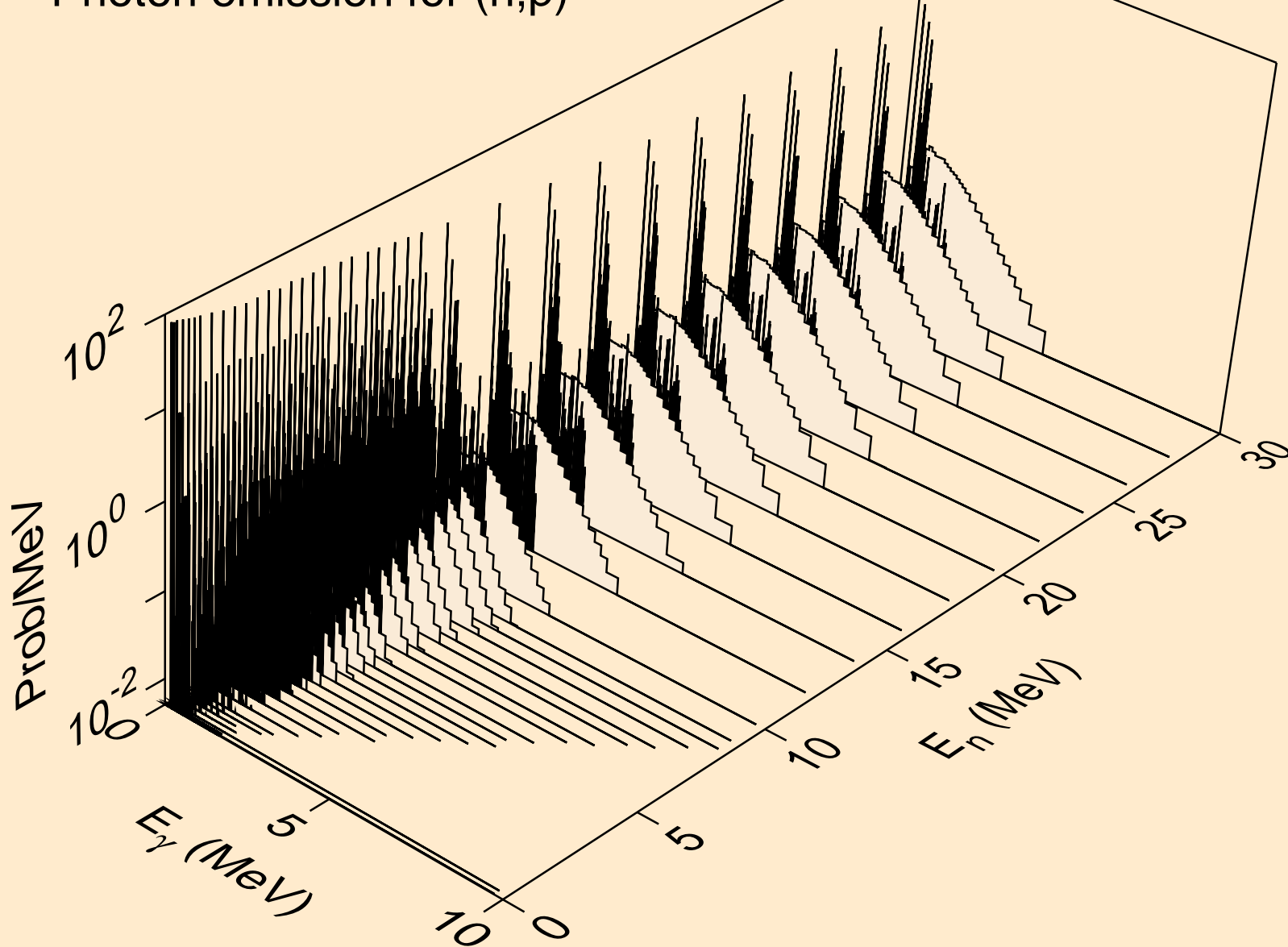

MAT=7722 ACE FILE PRODUCED AT NEA WITH NDEC
Photon emission for (n,d)

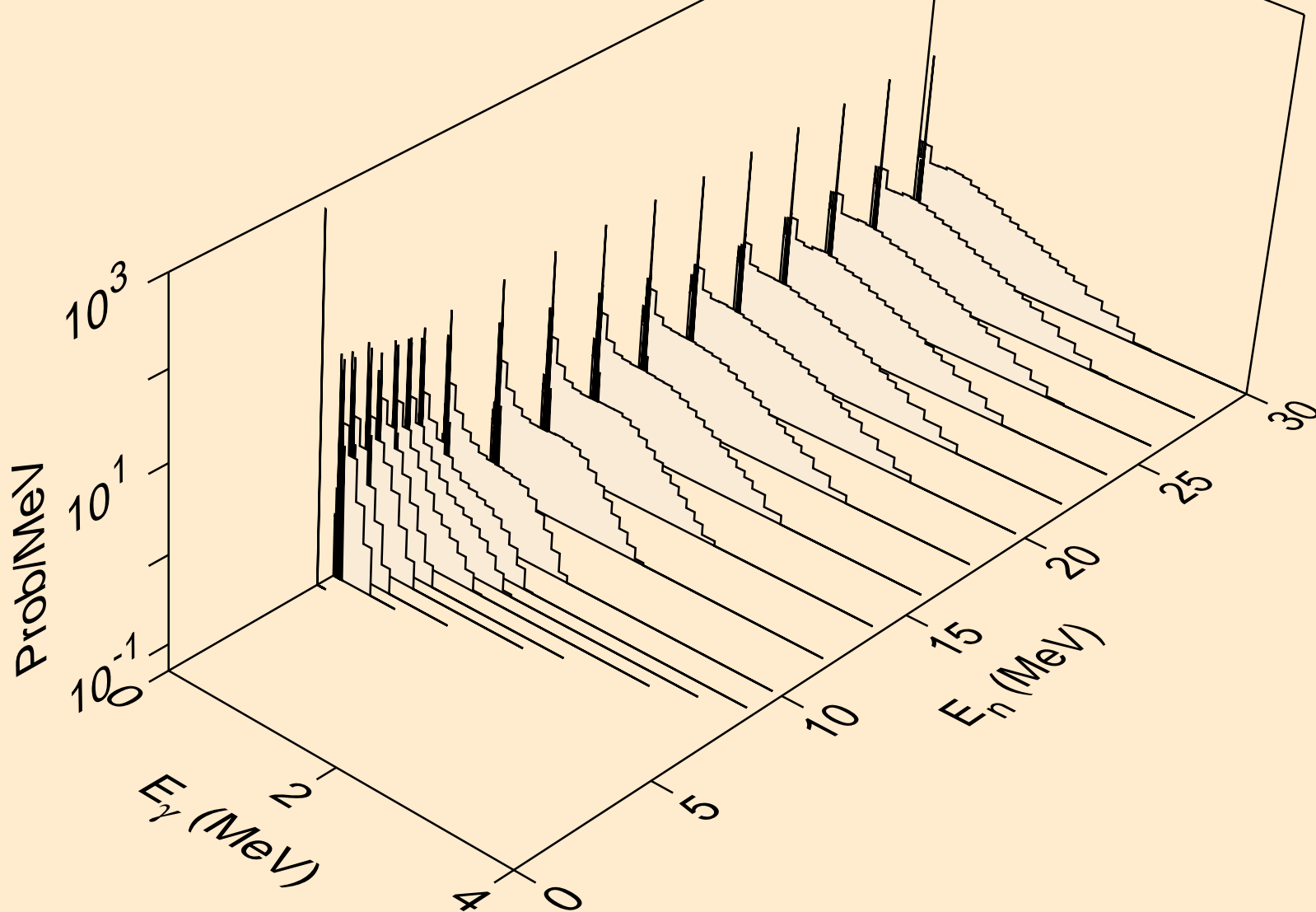

MAT=7722 ACE FILE PRODUCED AT NEA WITH NDEC
Photon emission for (n,t)

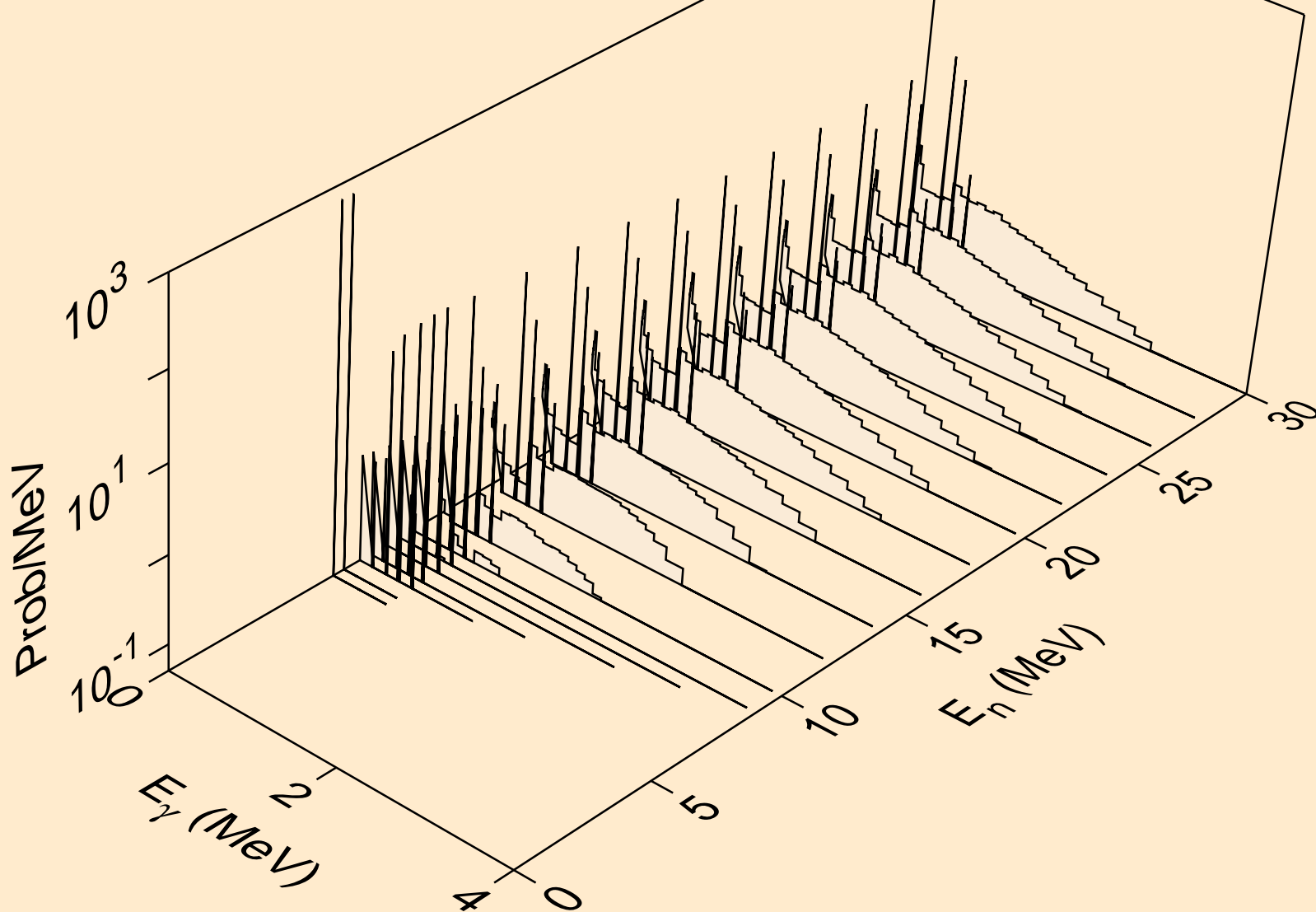

MAT=7722 ACE FILE PRODUCED AT NEA WITH NDEC
Photon emission for (n,he3)

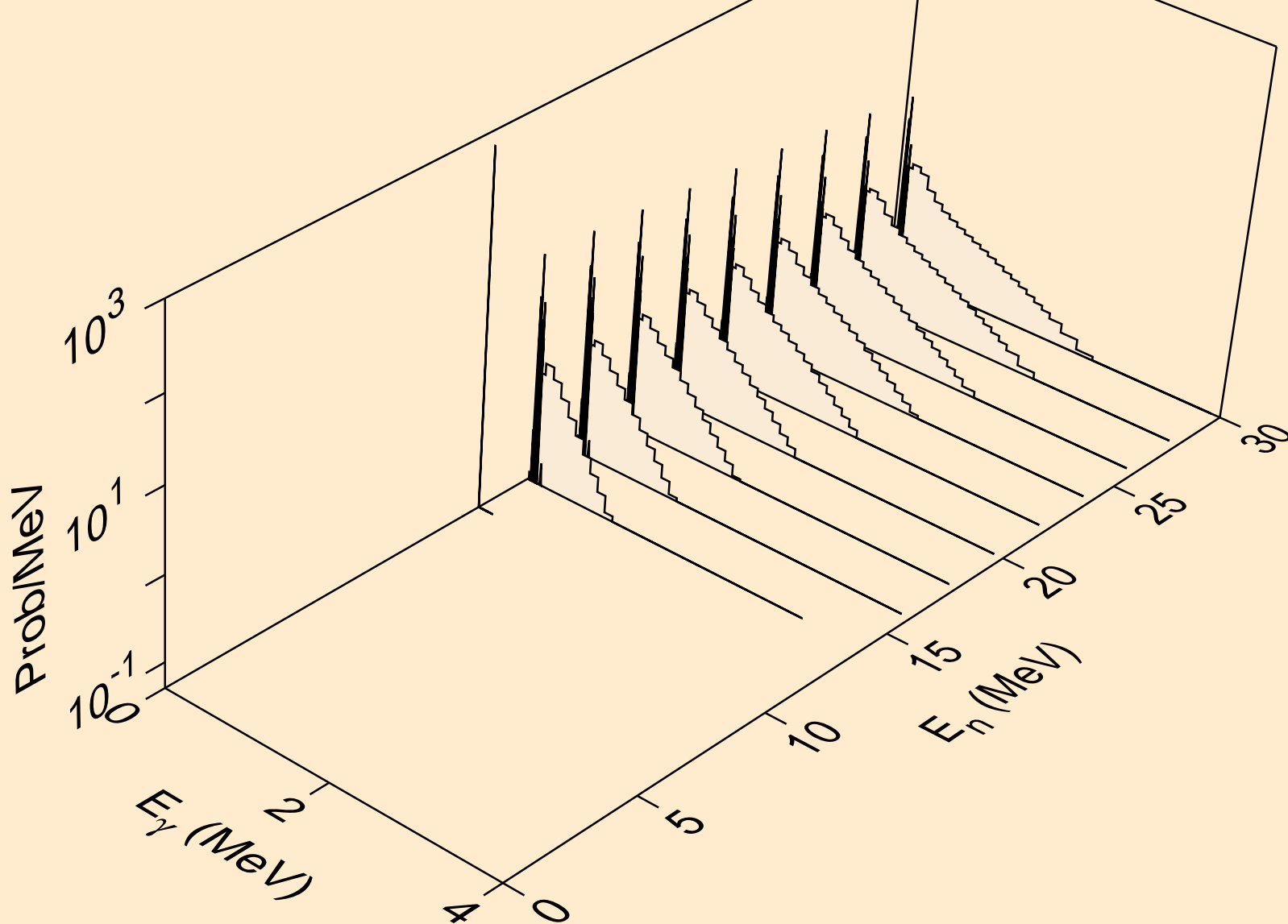

MAT=7722 ACE FILE PRODUCED AT NEA WITH NDEC
Photon emission for (n,a)

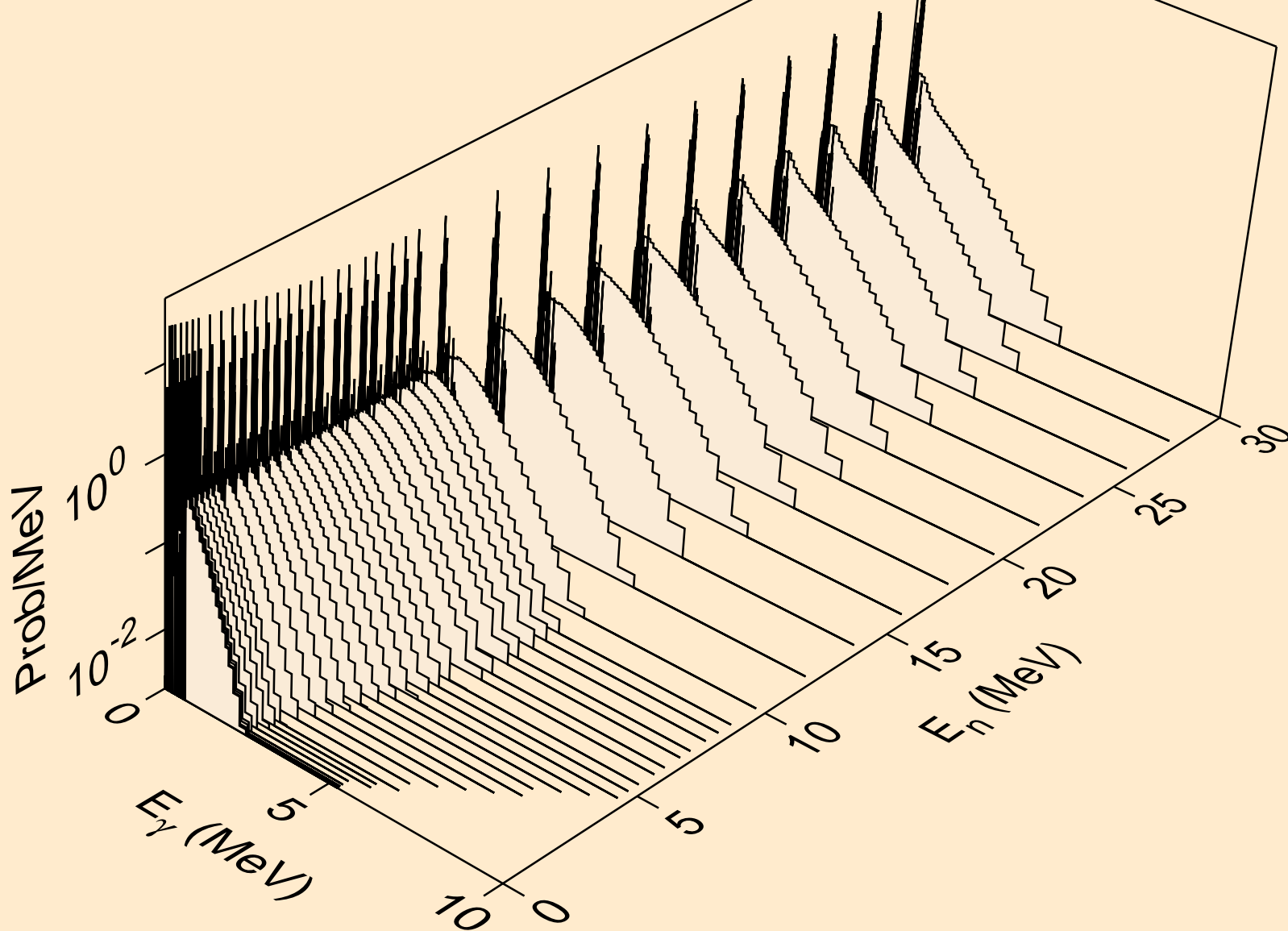

MAT=7722 ACE FILE PRODUCED AT NEA WITH NDEC
Photon emission for (n,2a)

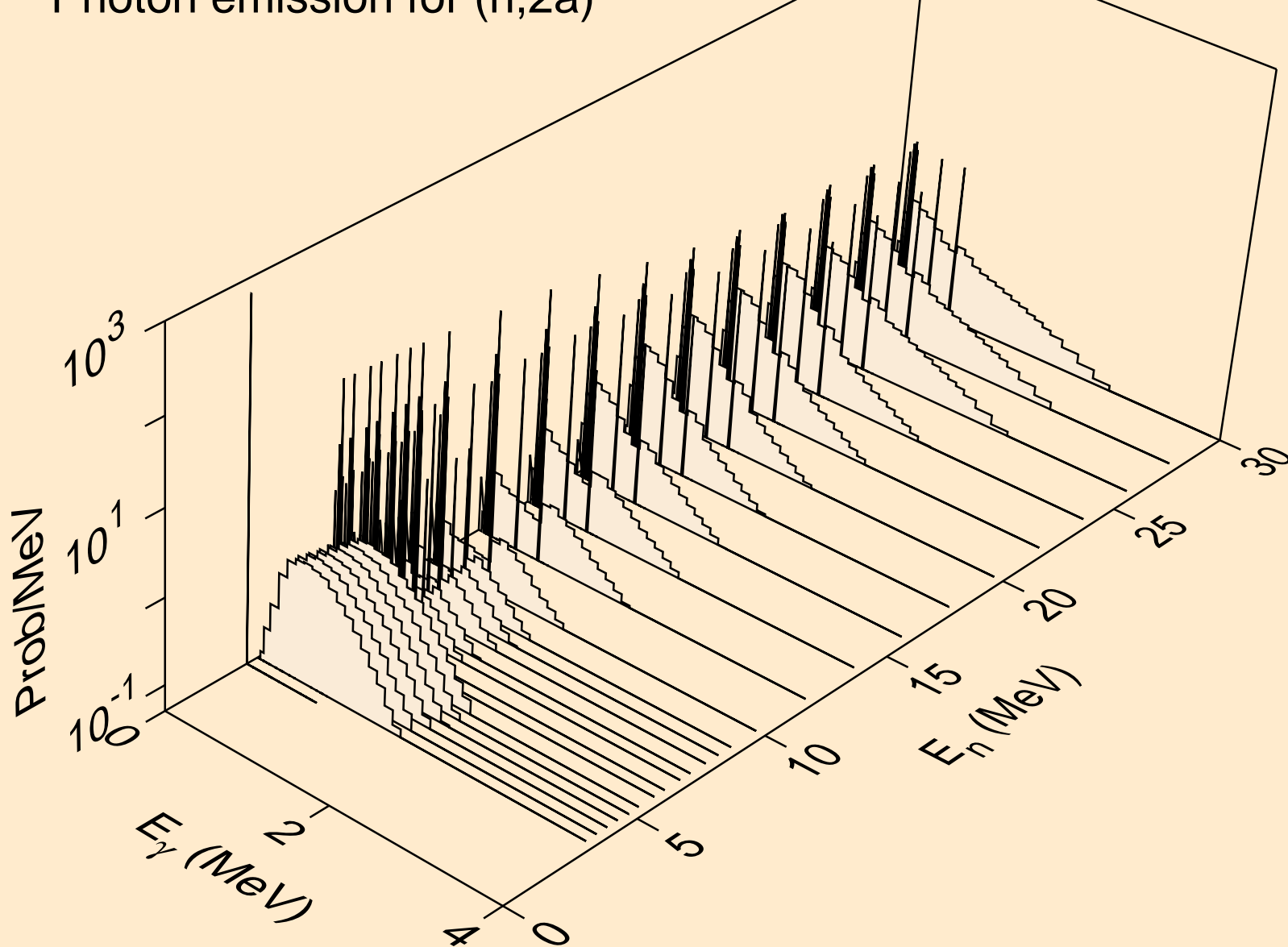

MAT=7722 ACE FILE PRODUCED AT NEA WITH NDEC
Photon emission for (n,2p)

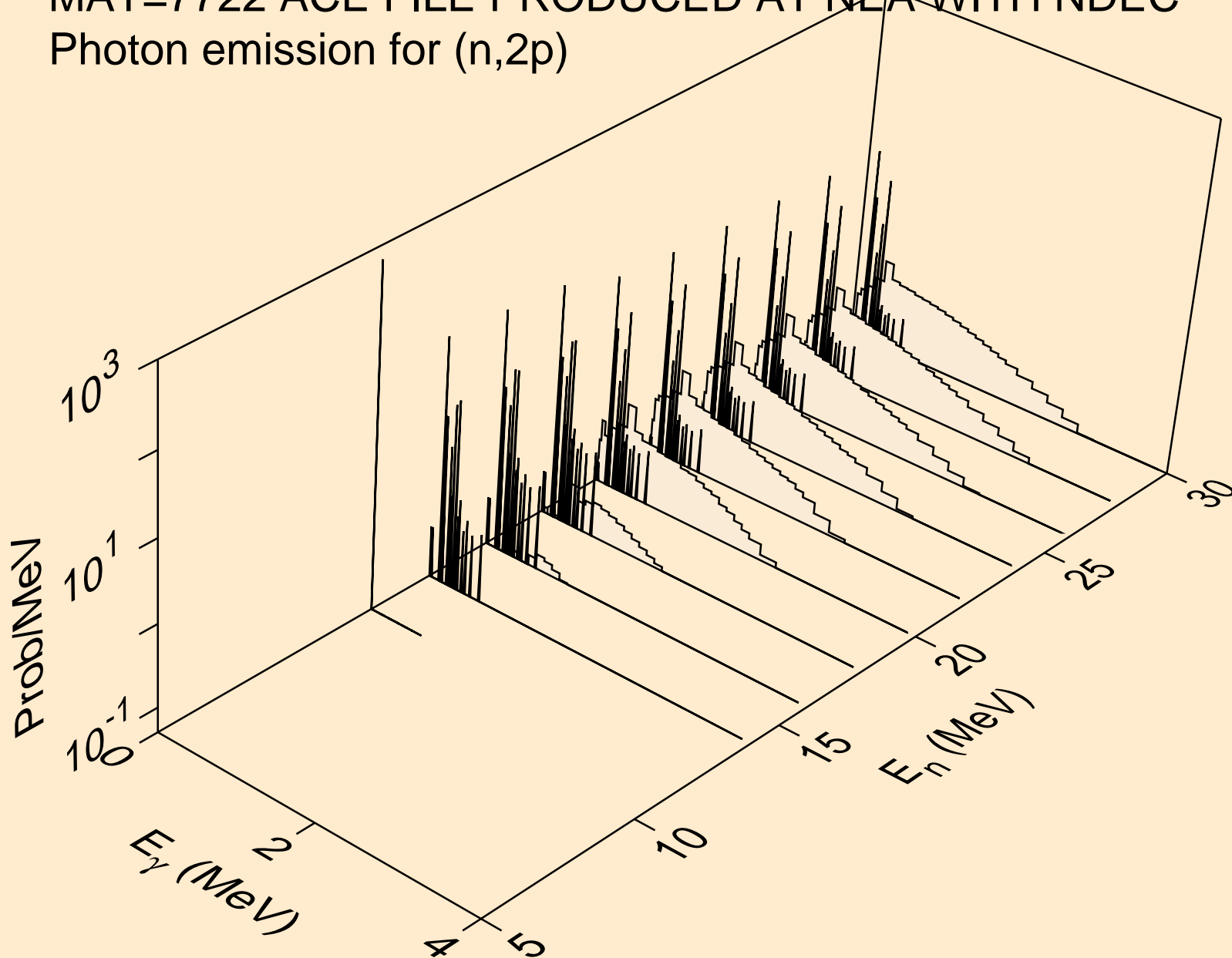

MAT=7722 ACE FILE PRODUCED AT NEA WITH NDEC
Photon emission for (n,pa)

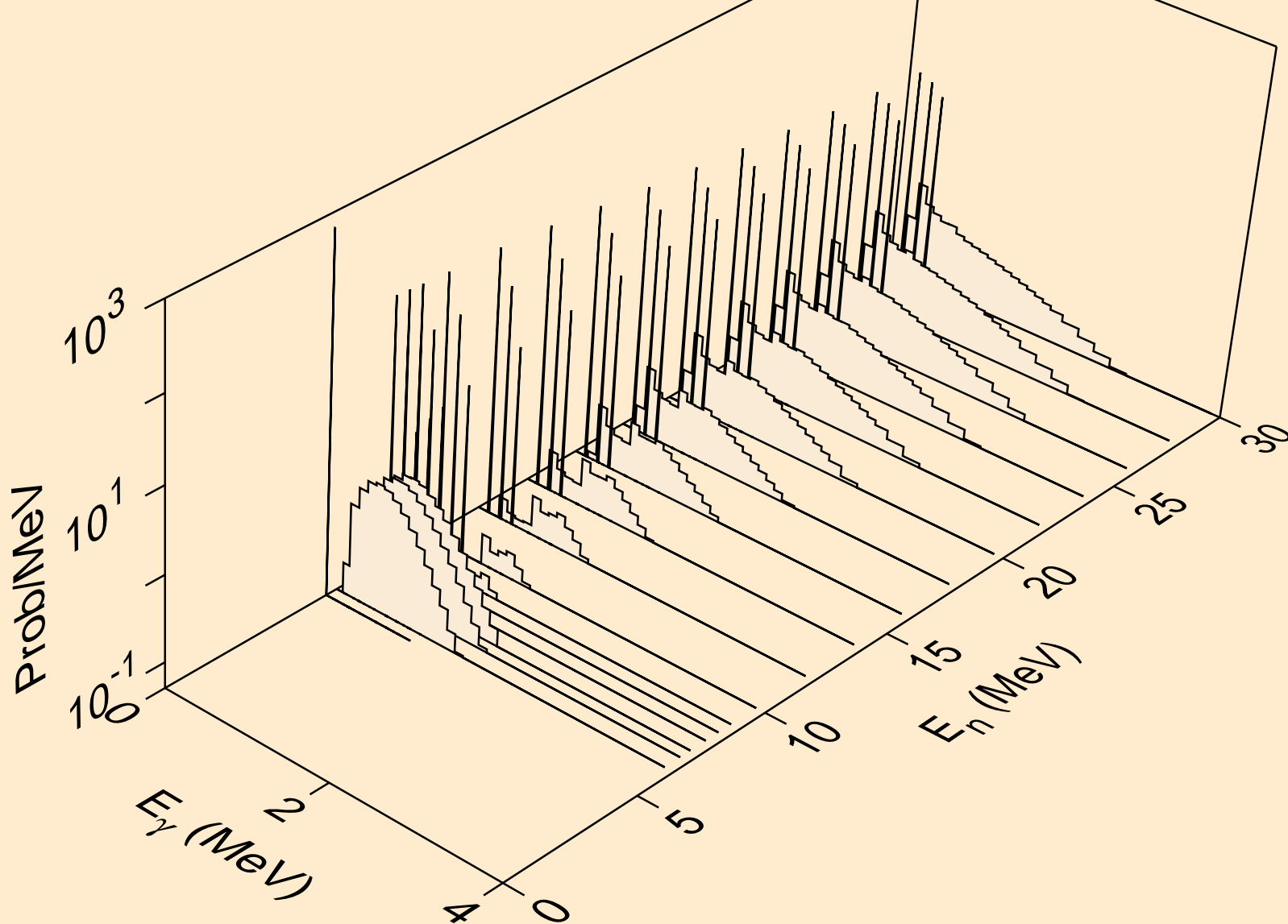

MAT=7722 ACE FILE PRODUCED AT NEA WITH NDEC
Photon emission for (n,pd)

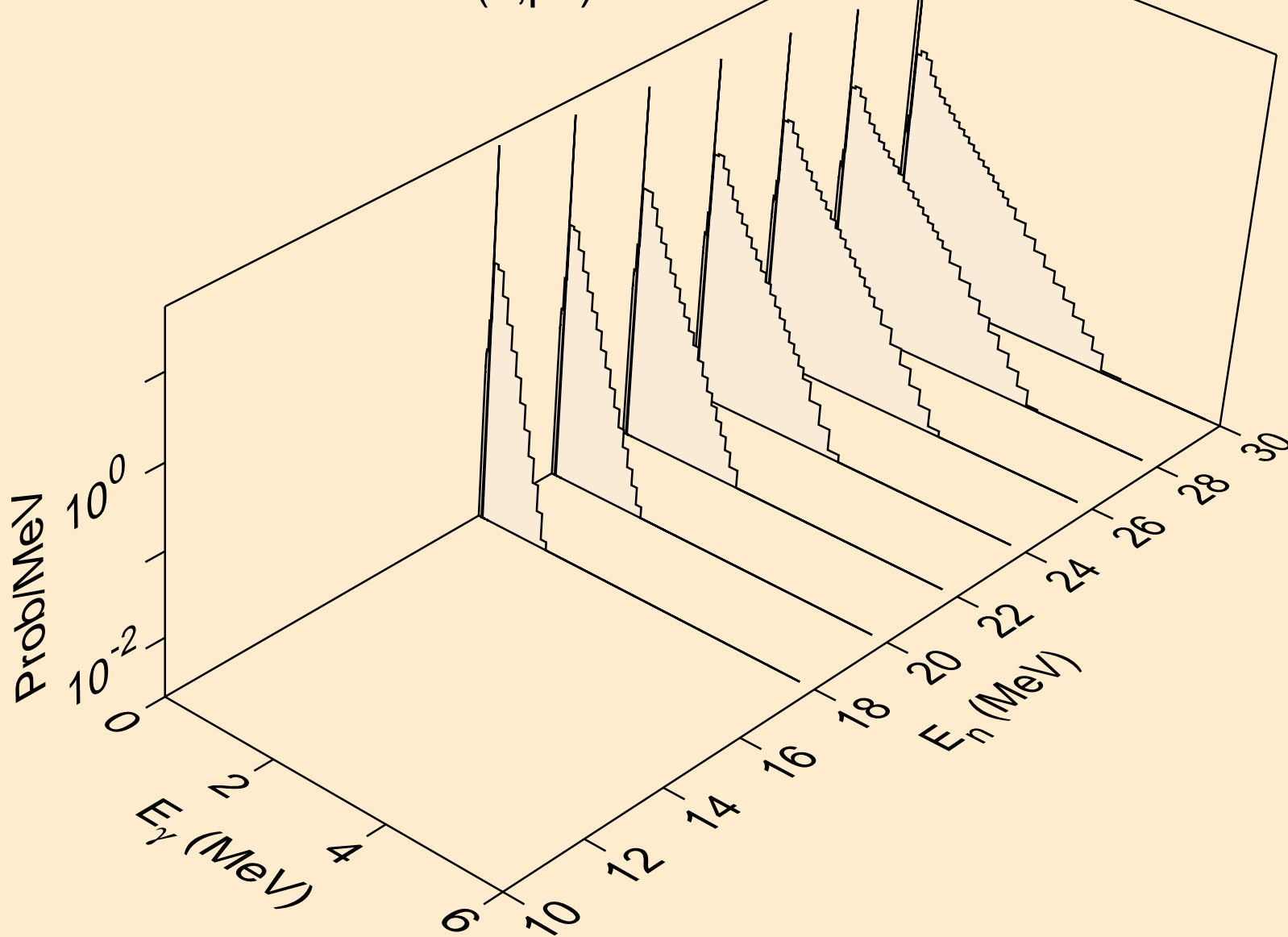

MAT=7722 ACE FILE PRODUCED AT NEA WITH NDEC
Photon emission for (n,pt)

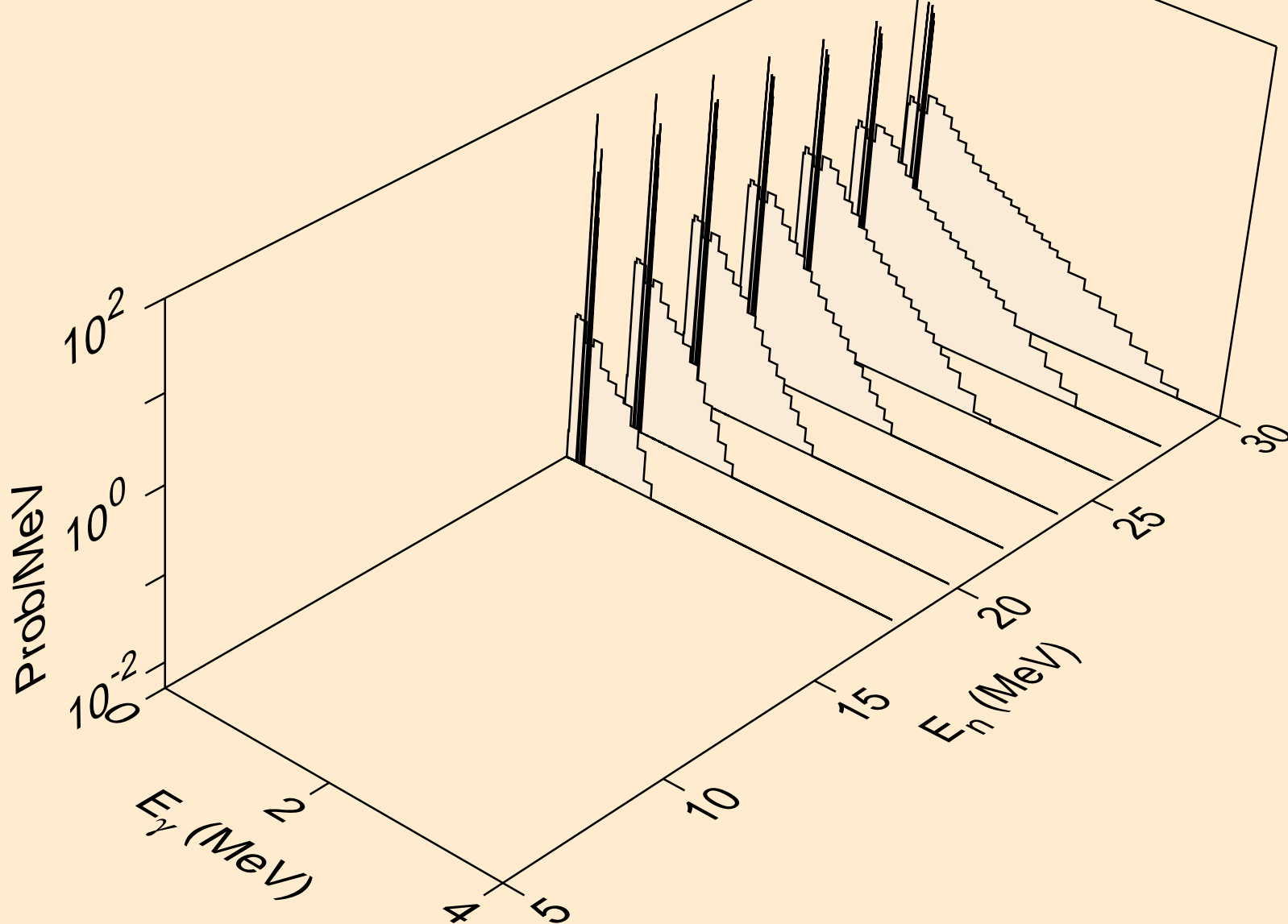

MAT=7722 ACE FILE PRODUCED AT NEA WITH NDEC
Photon emission for (n,da)

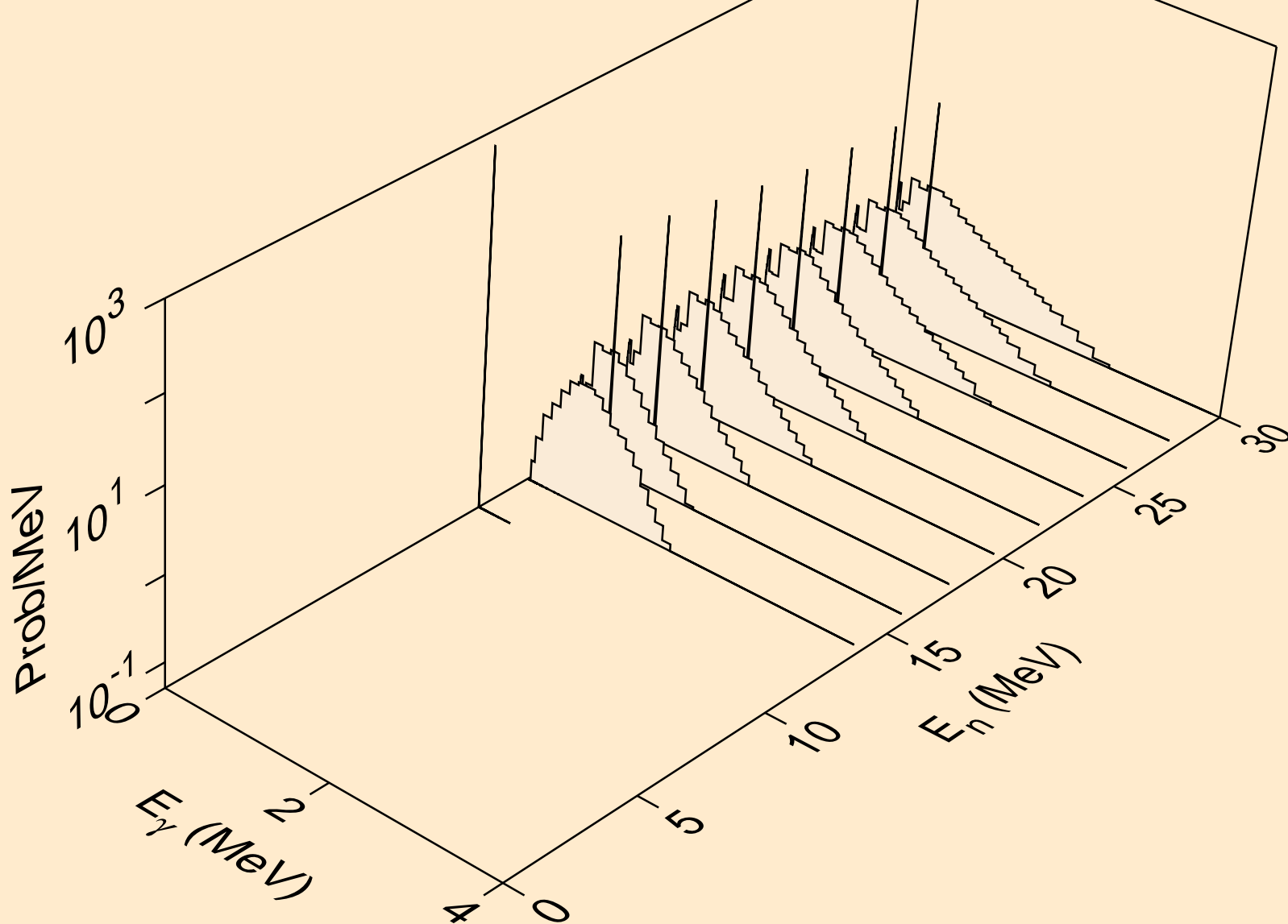

MAT=7722 ACE FILE PRODUCED AT NEA WITH NDEC
thermal capture photon spectrum

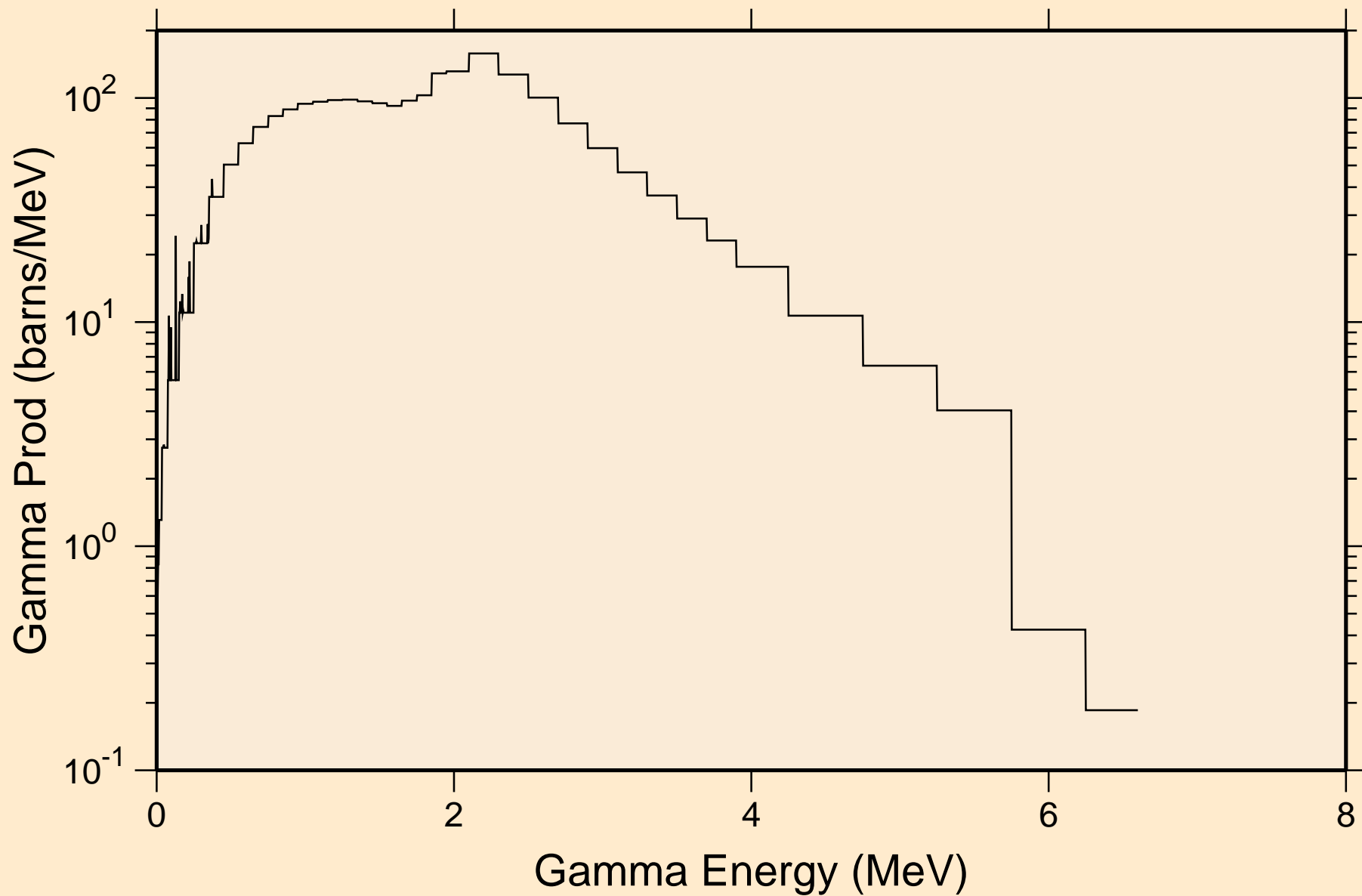

MAT=7722 ACE FILE PRODUCED AT NEA WITH NDEC
14 MeV photon spectrum

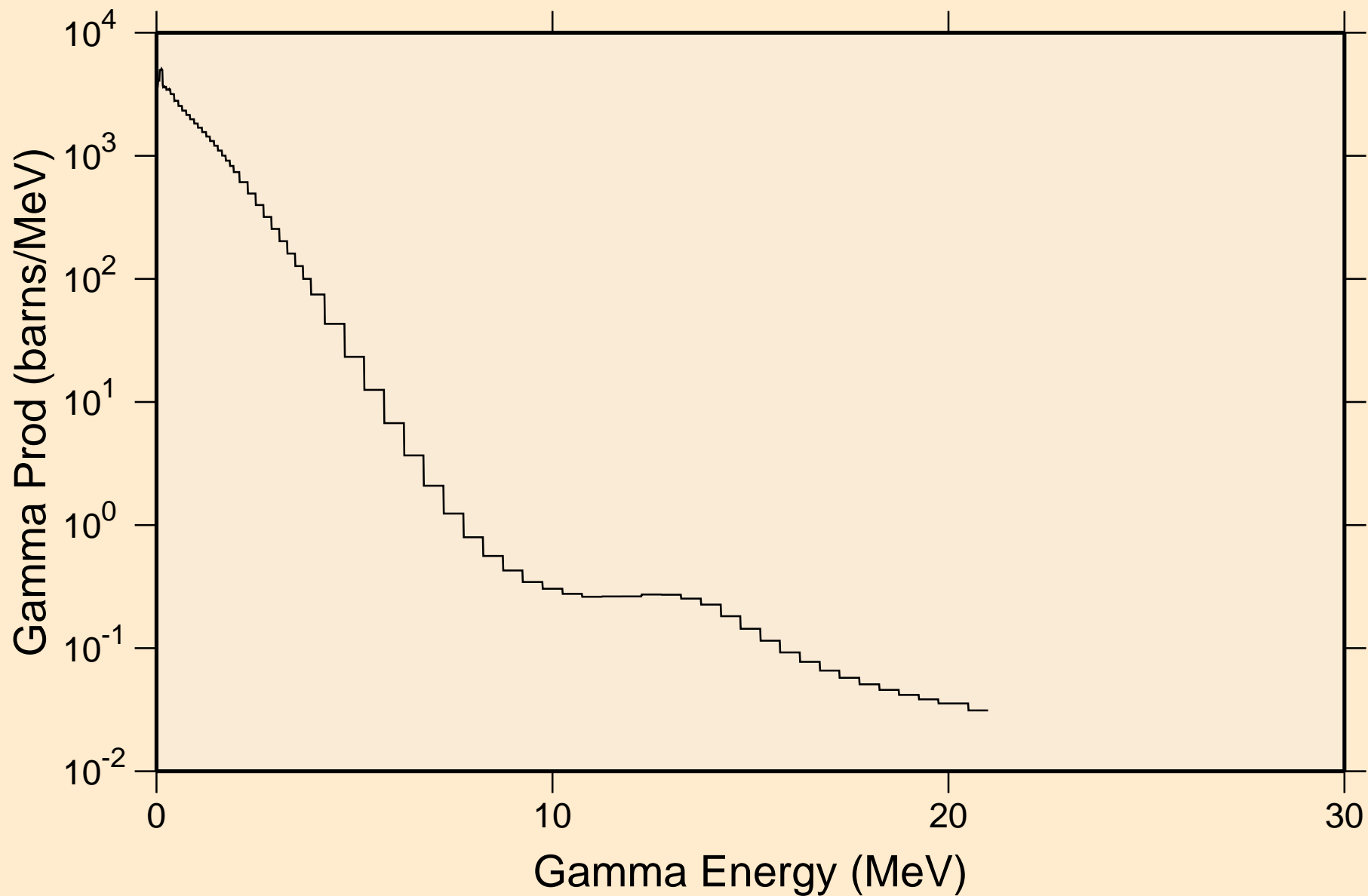

MAT=7722 ACE FILE PRODUCED AT NEA WITH NDEC
Particle heating contributions

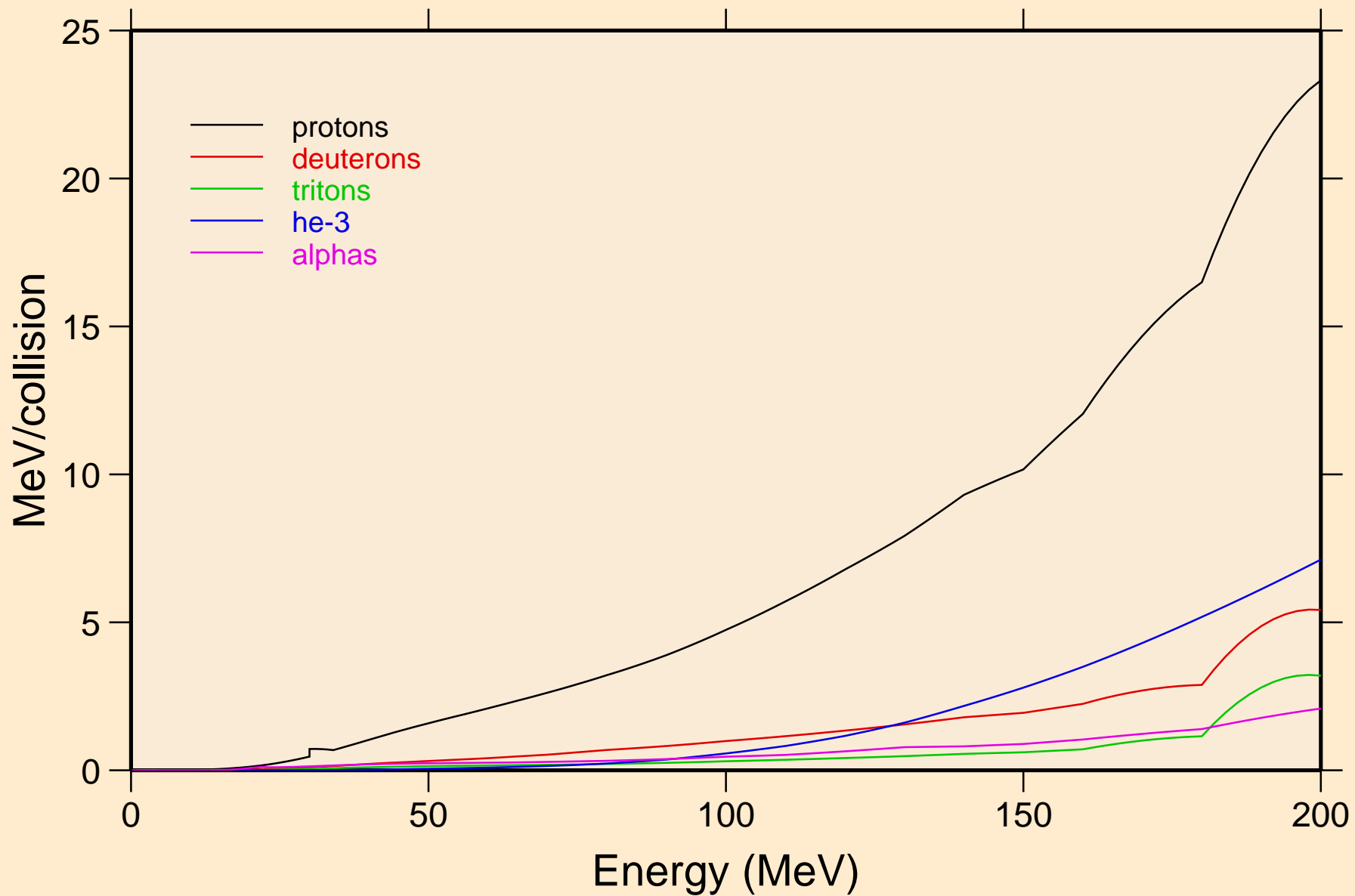

MAT=7722 ACE FILE PRODUCED AT NEA WITH NDEC
Recoil Heating

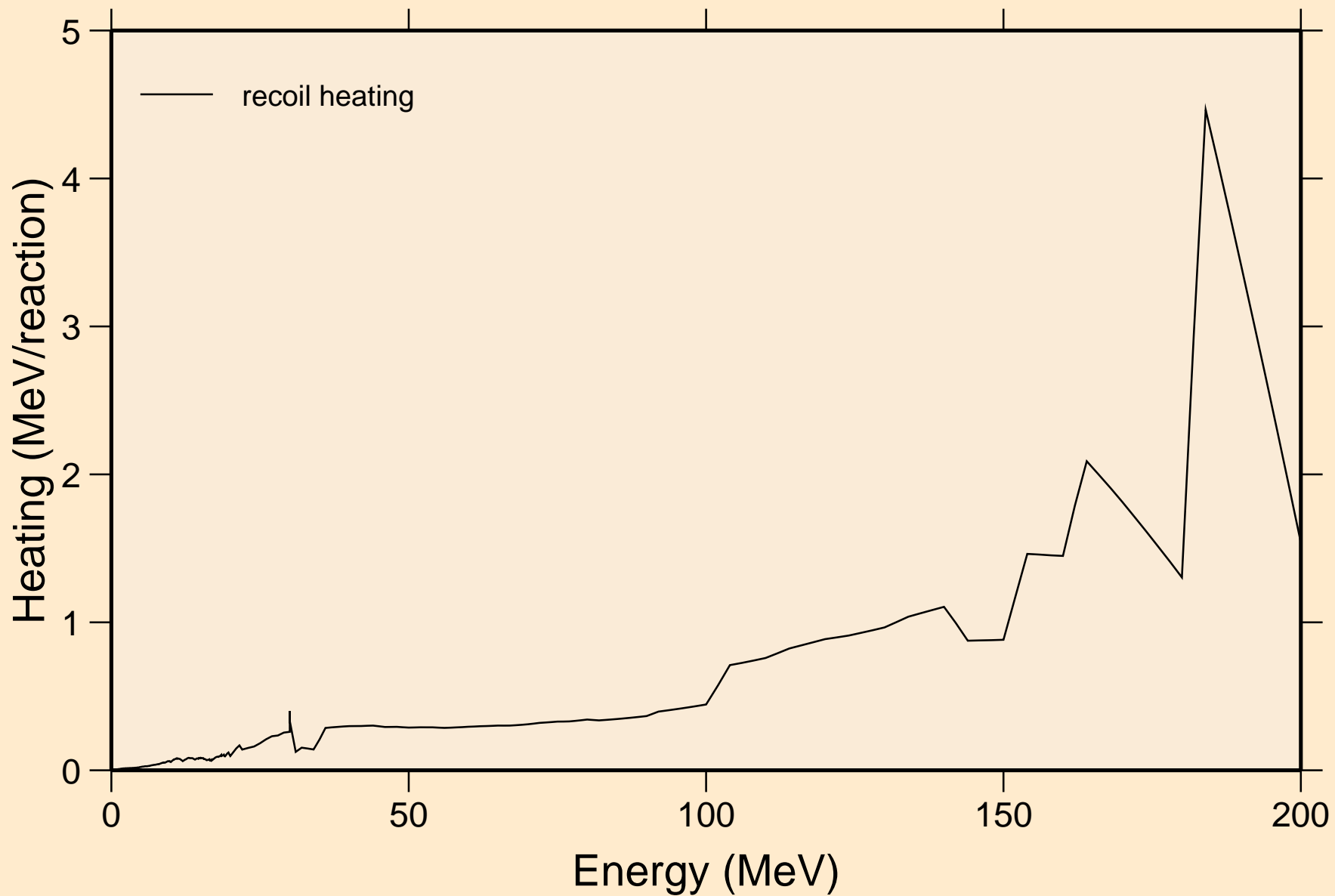

MAT=7722 ACE FILE PRODUCED AT NEA WITH NDEC
Particle production cross sections

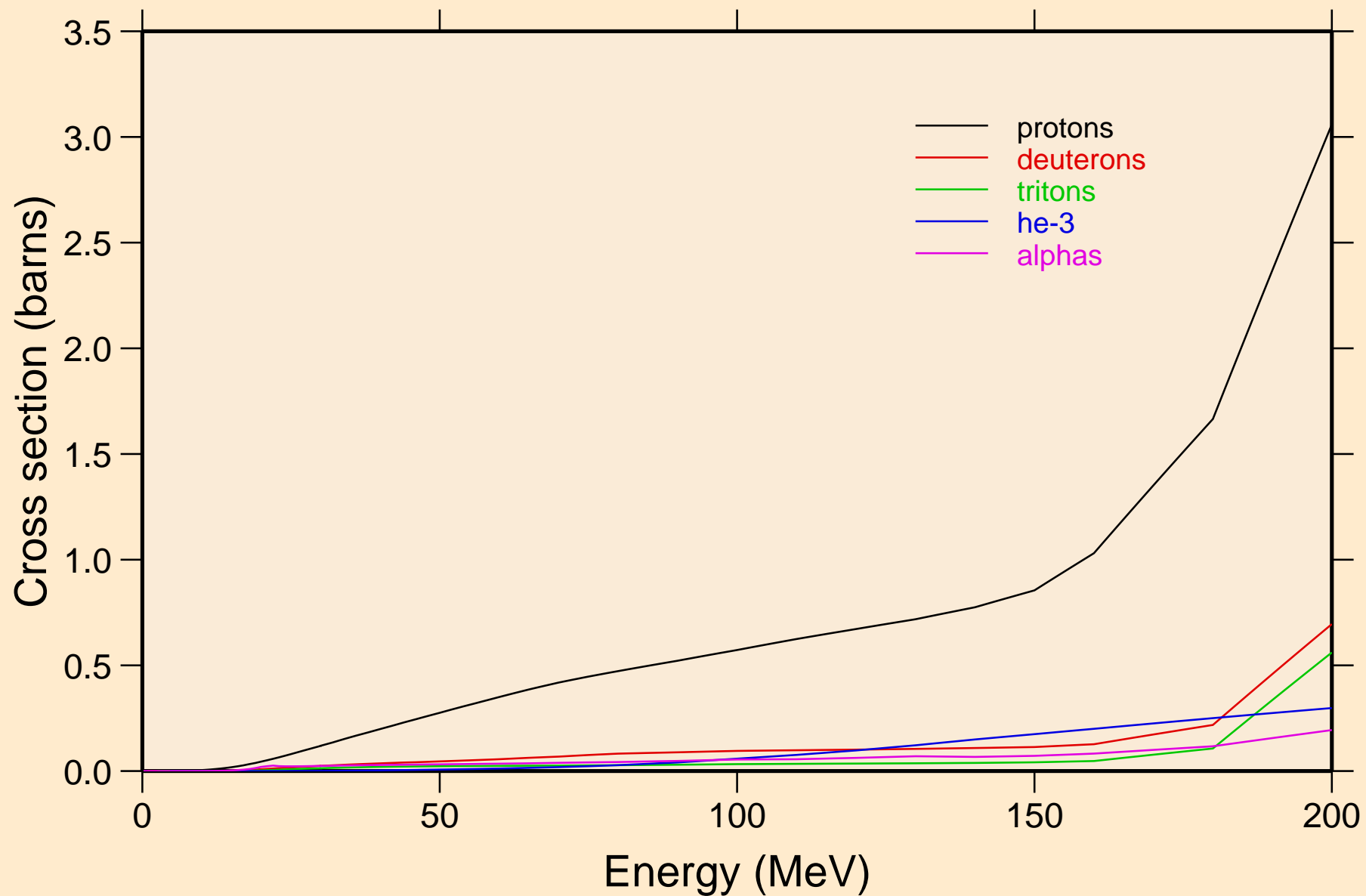

MAT=7722 ACE FILE PRODUCED AT NEA WITH NDEC
protons from (n,x)

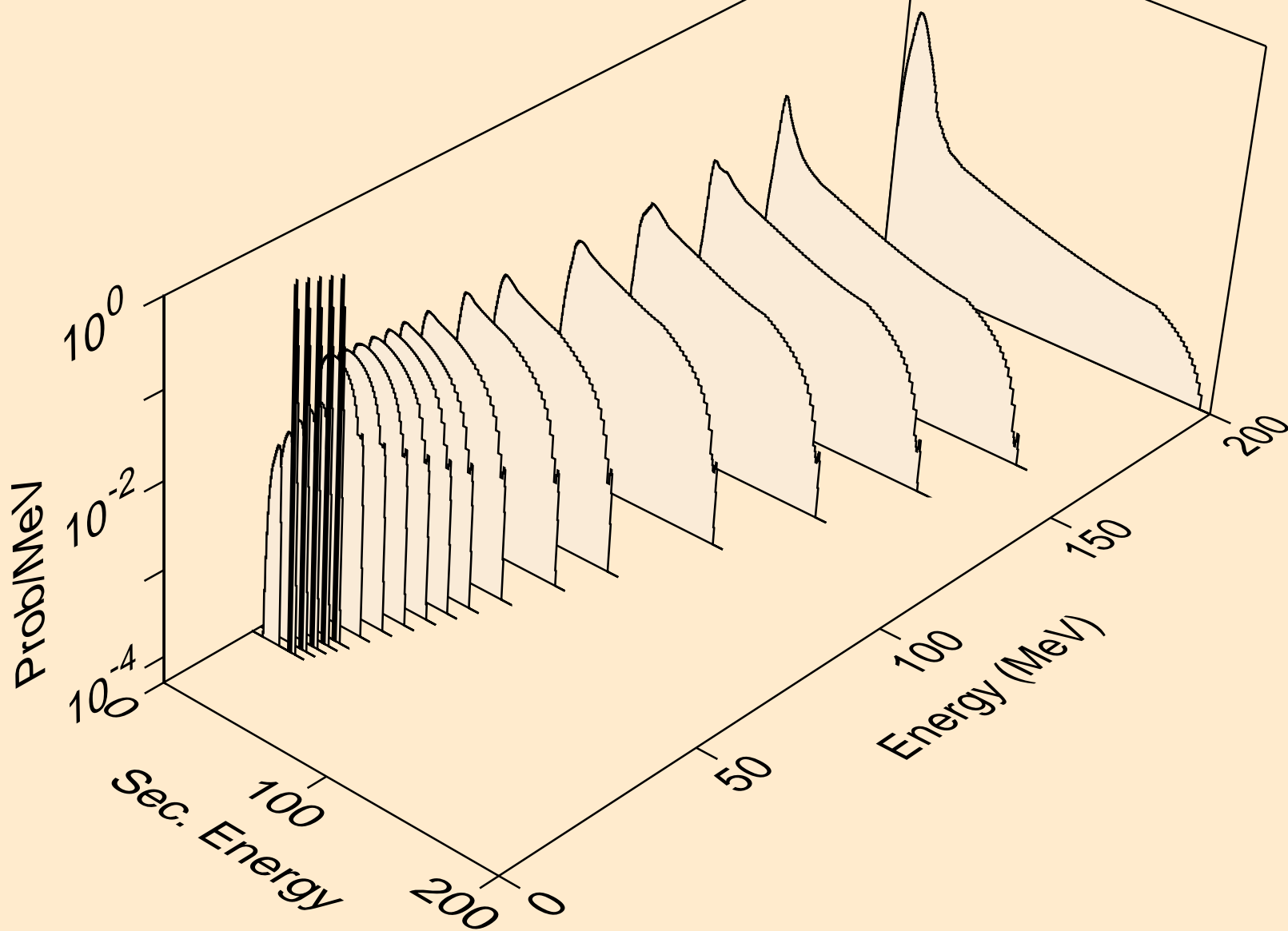

MAT=7722 ACE FILE PRODUCED AT NEA WITH NDEC
protons from (n,n*)p

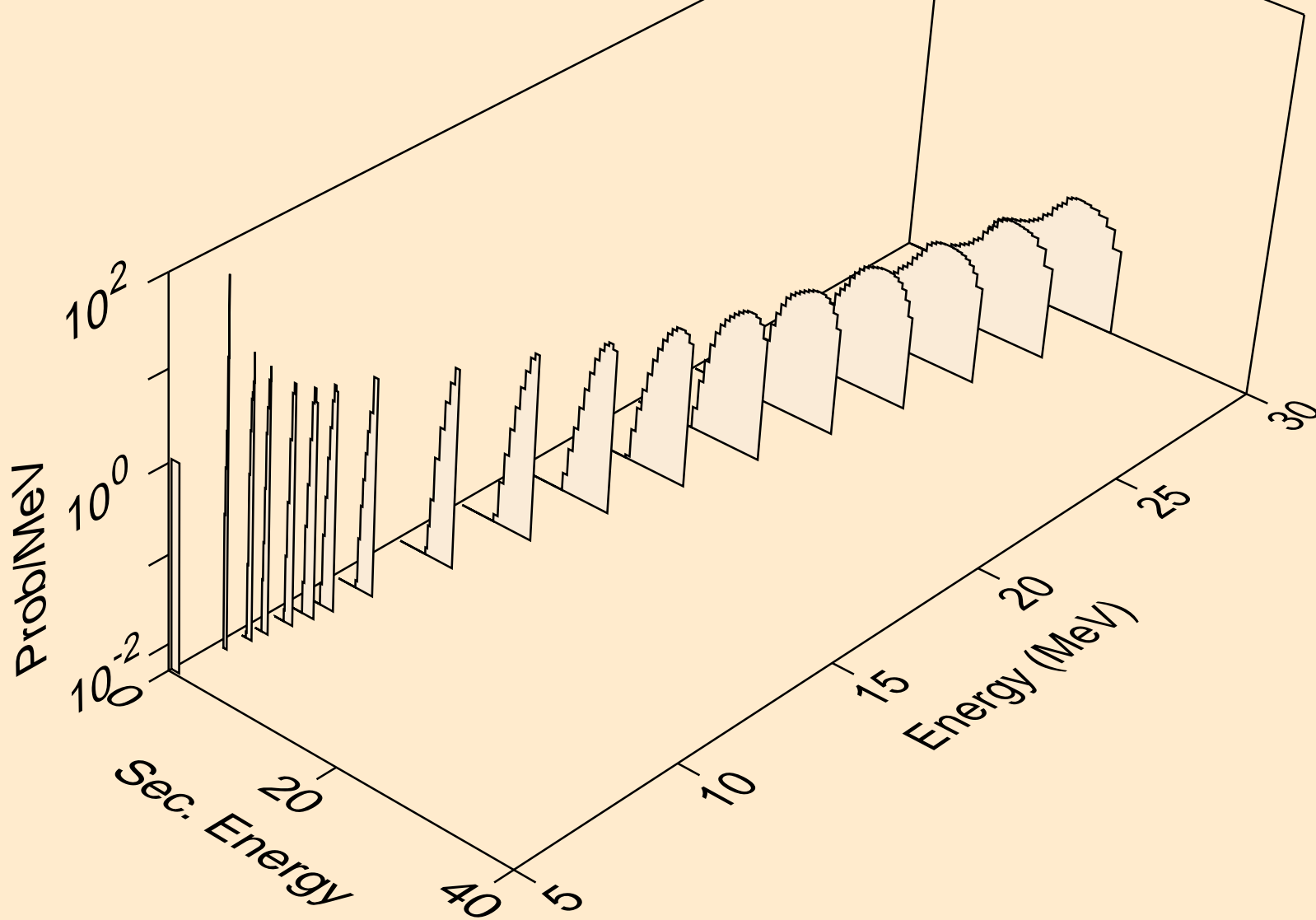

MAT=7722 ACE FILE PRODUCED AT NEA WITH NDEC
protons from (n,2np)

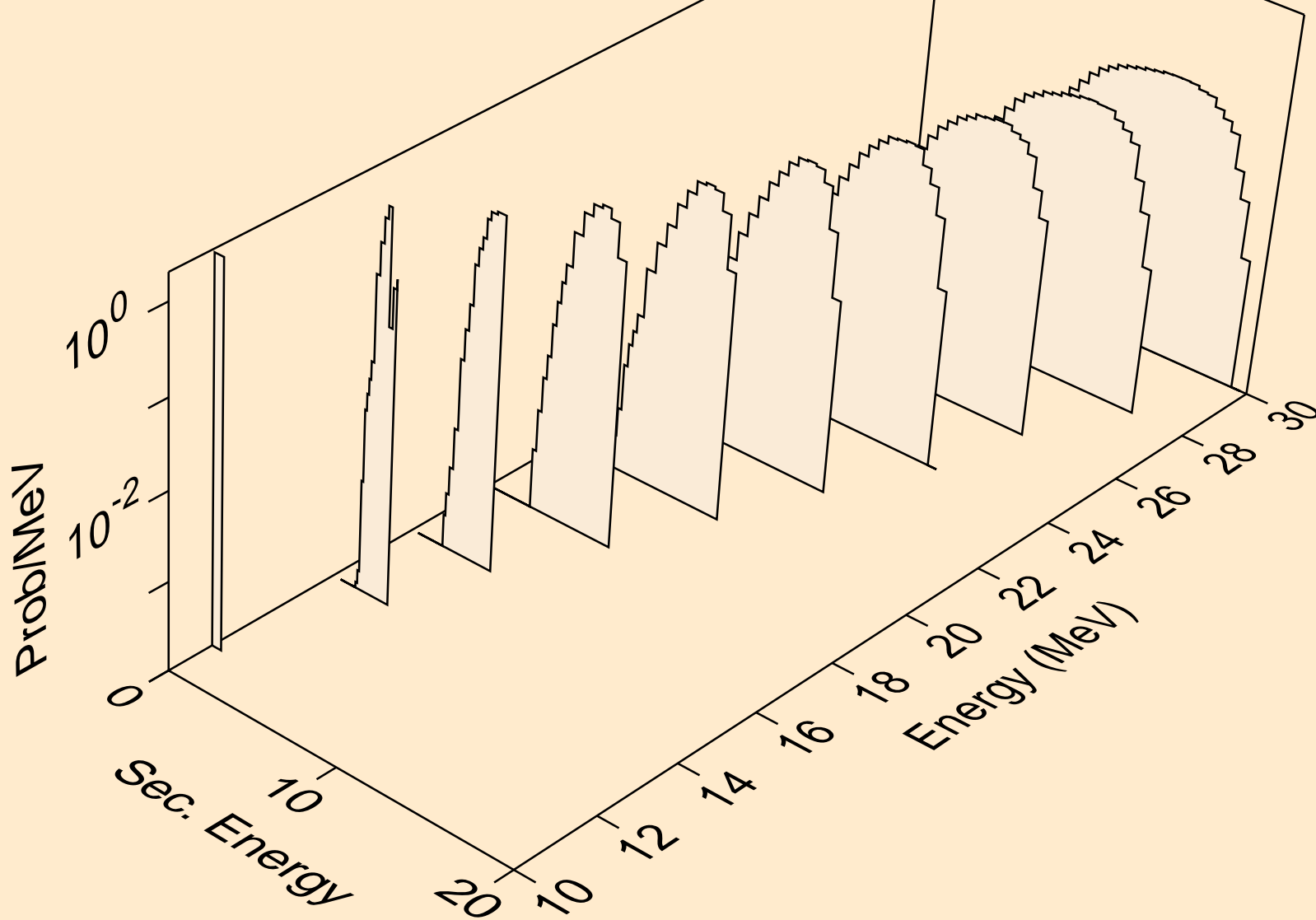

MAT=7722 ACE FILE PRODUCED AT NEA WITH NDEC
protons from (n,3np)

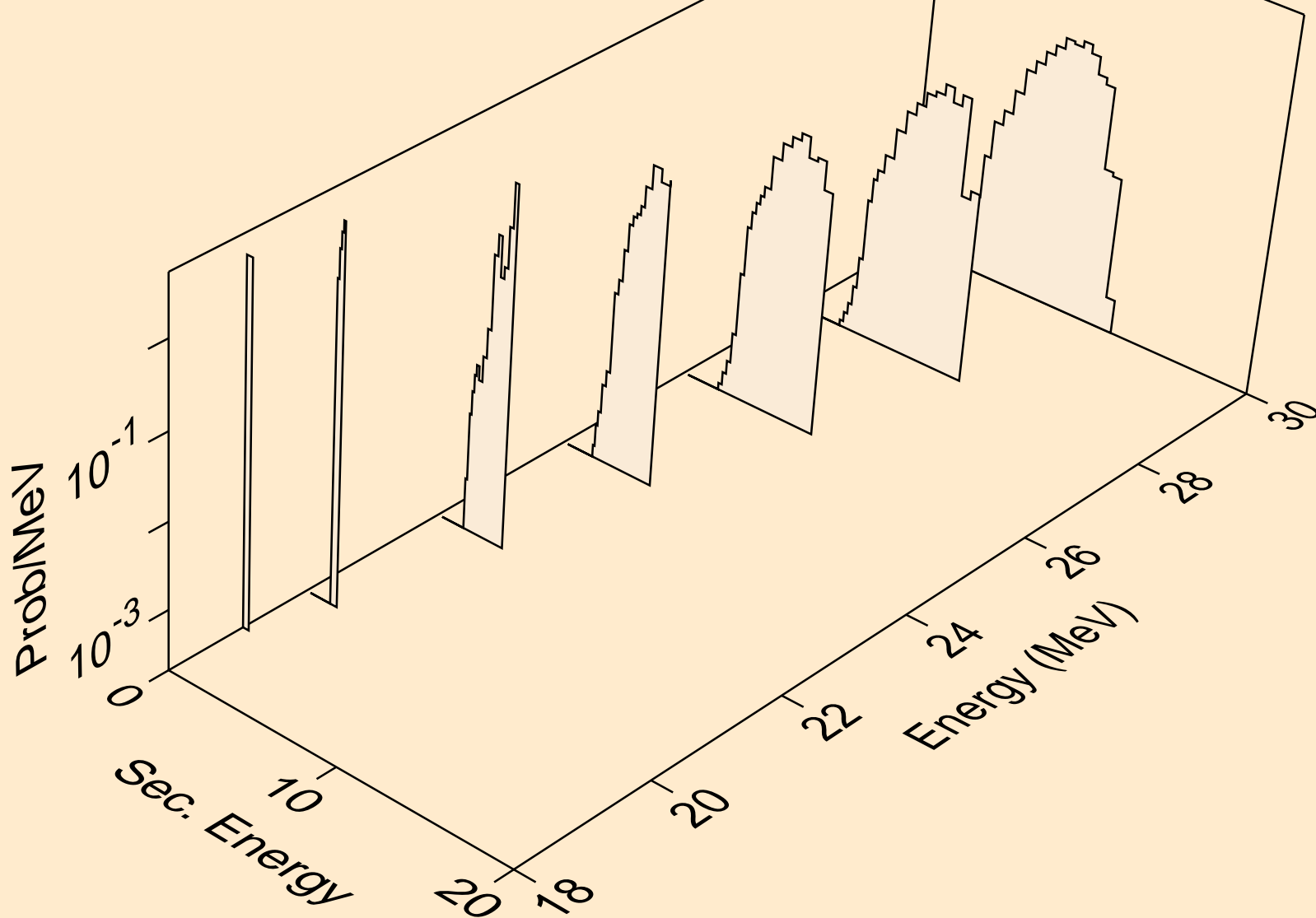

MAT=7722 ACE FILE PRODUCED AT NEA WITH NDEC
protons from (n,2np)

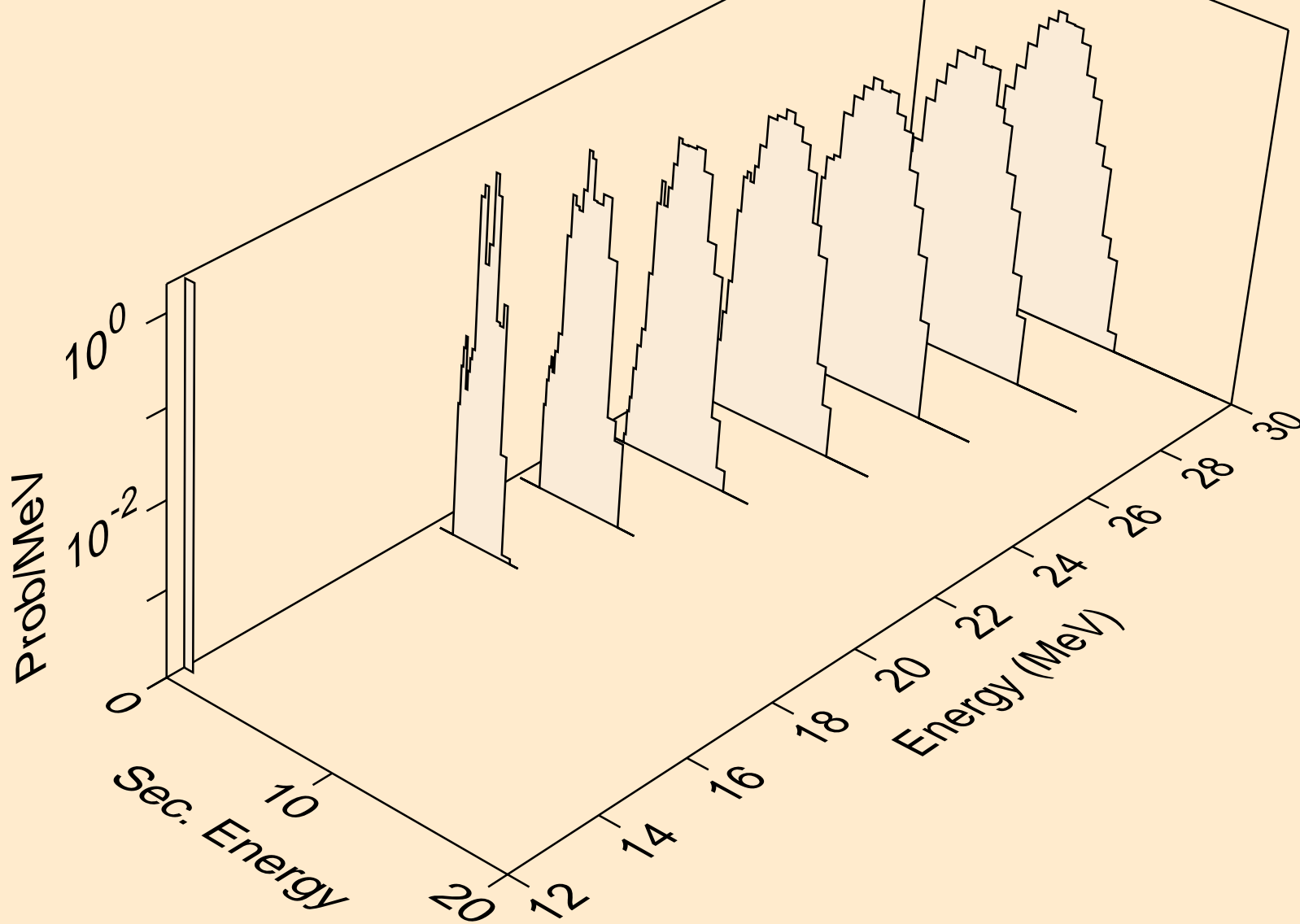

MAT=7722 ACE FILE PRODUCED AT NEA WITH NDEC
protons from (n,npa)

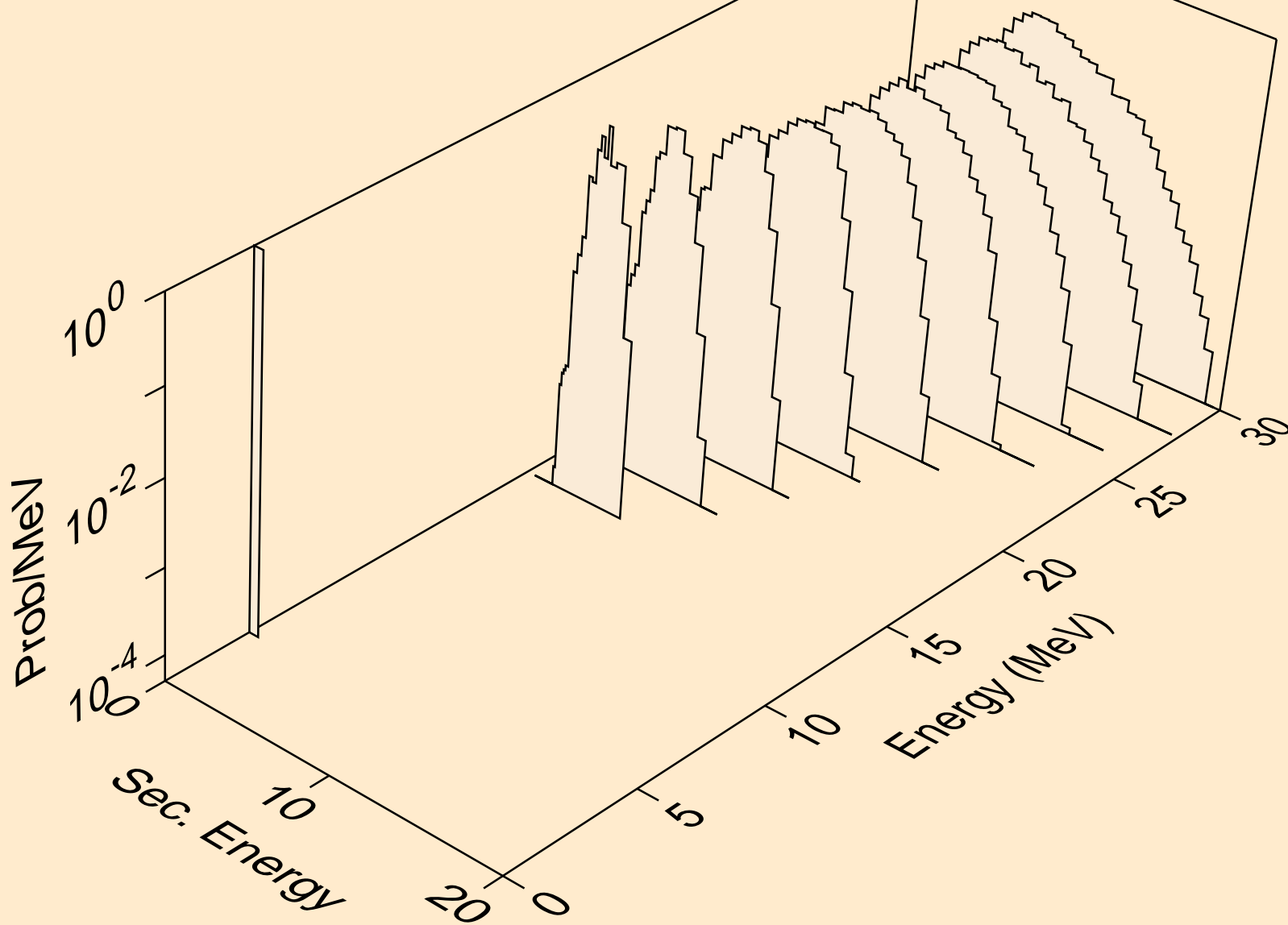

MAT=7722 ACE FILE PRODUCED AT NEA WITH NDEC
protons from (n,p)

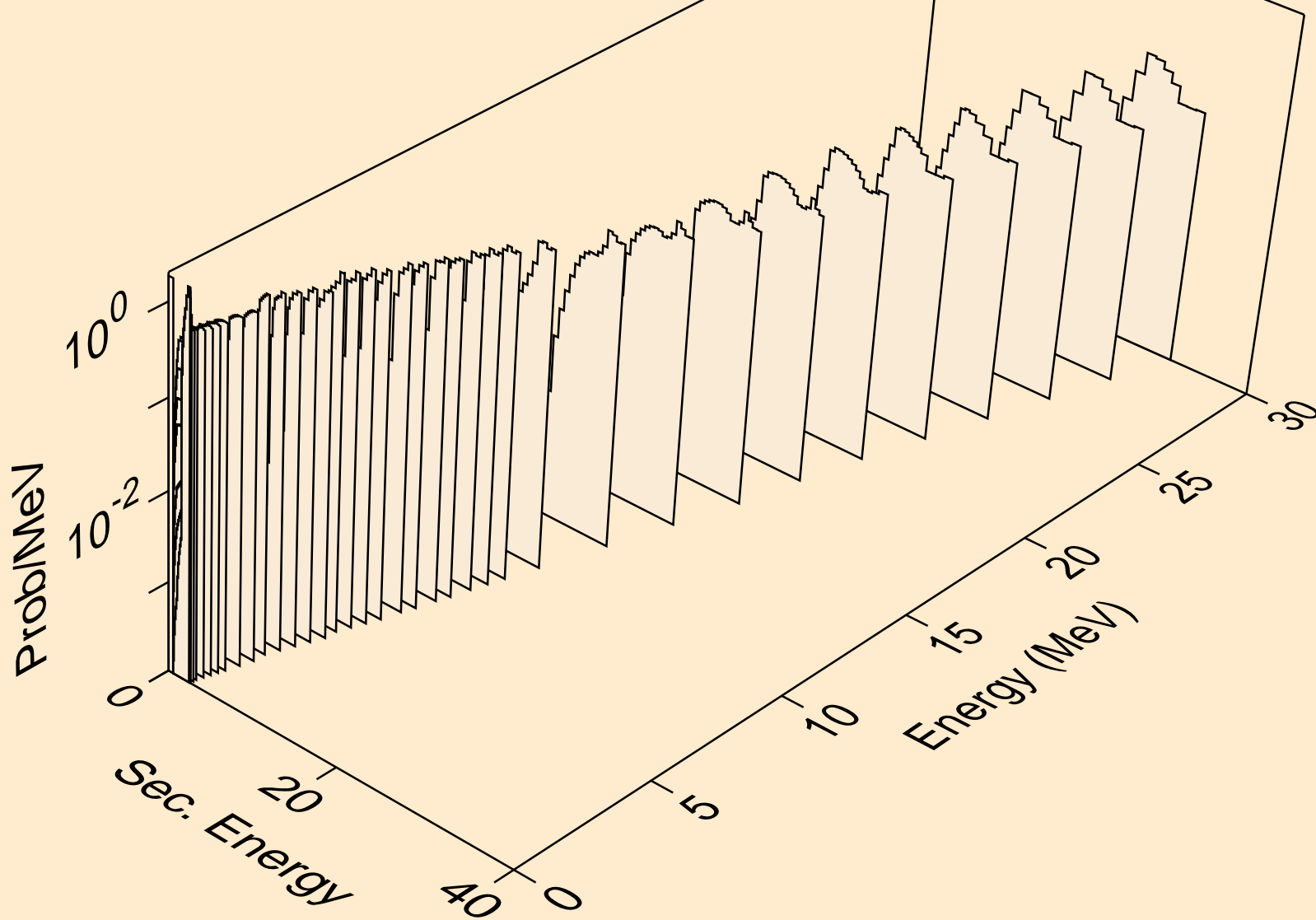

MAT=7722 ACE FILE PRODUCED AT NEA WITH NDEC
protons from (n,2p)

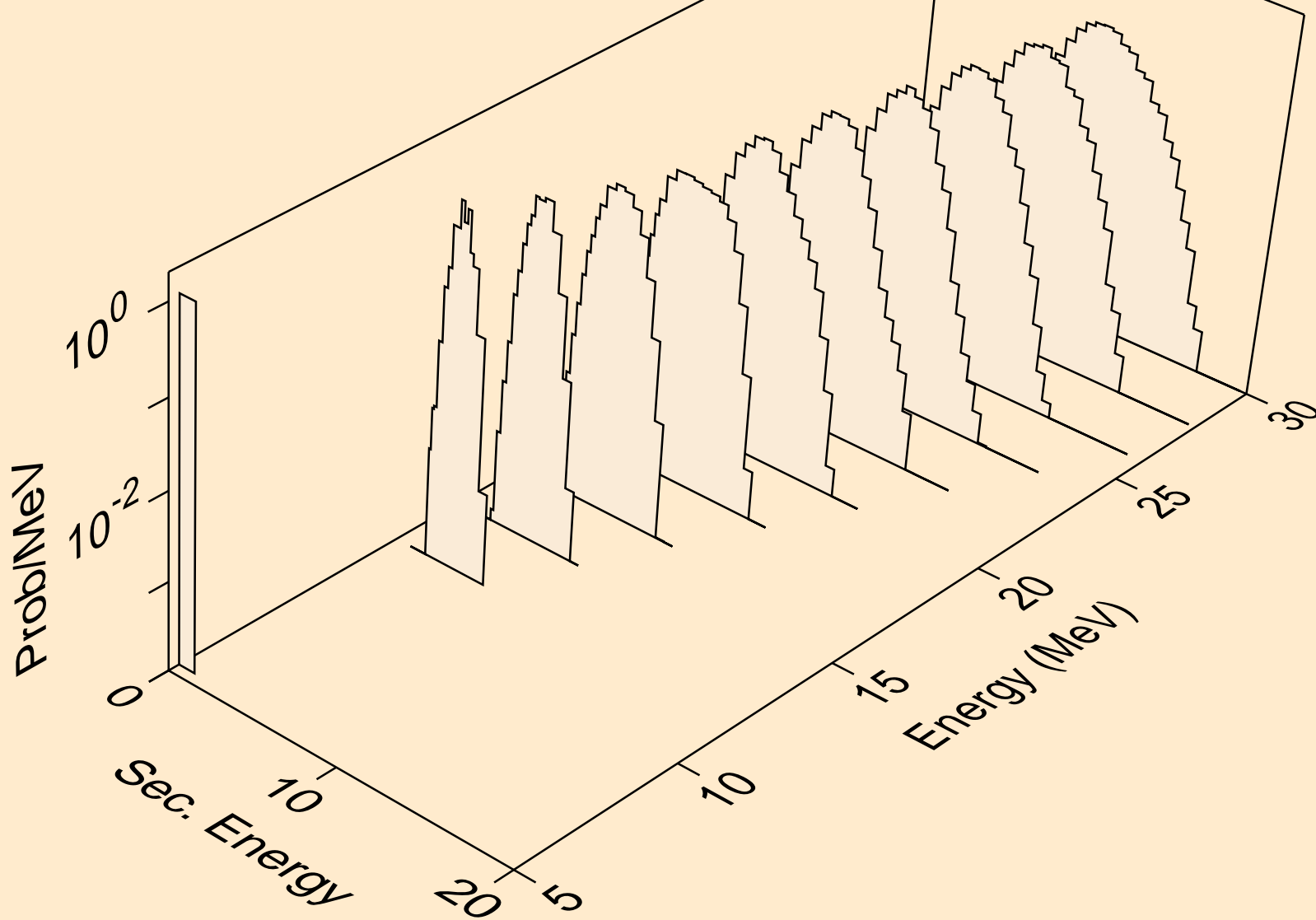

MAT=7722 ACE FILE PRODUCED AT NEA WITH NDEC
protons from (n,pa)

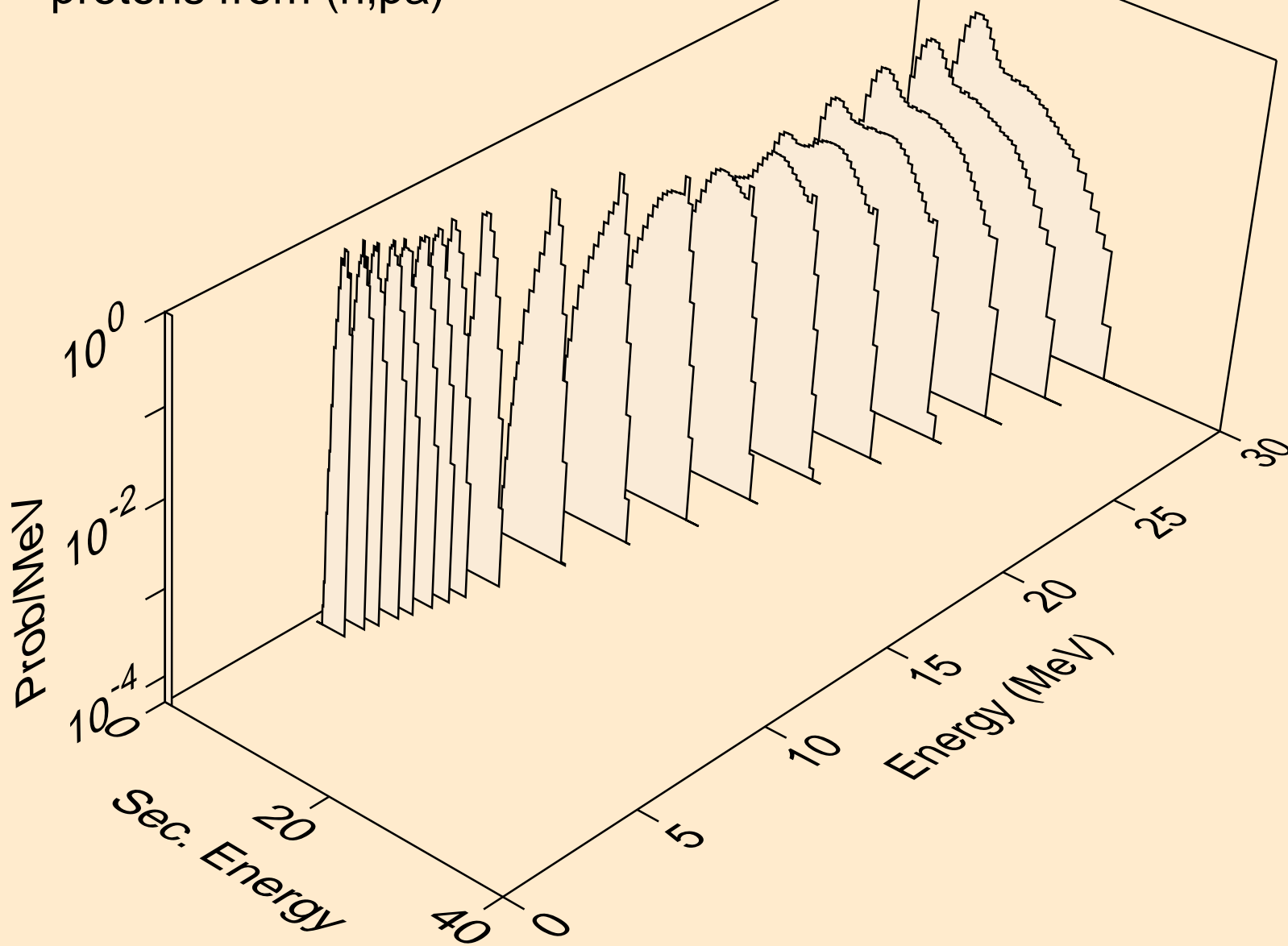

MAT=7722 ACE FILE PRODUCED AT NEA WITH NDEC
protons from (n,pd)

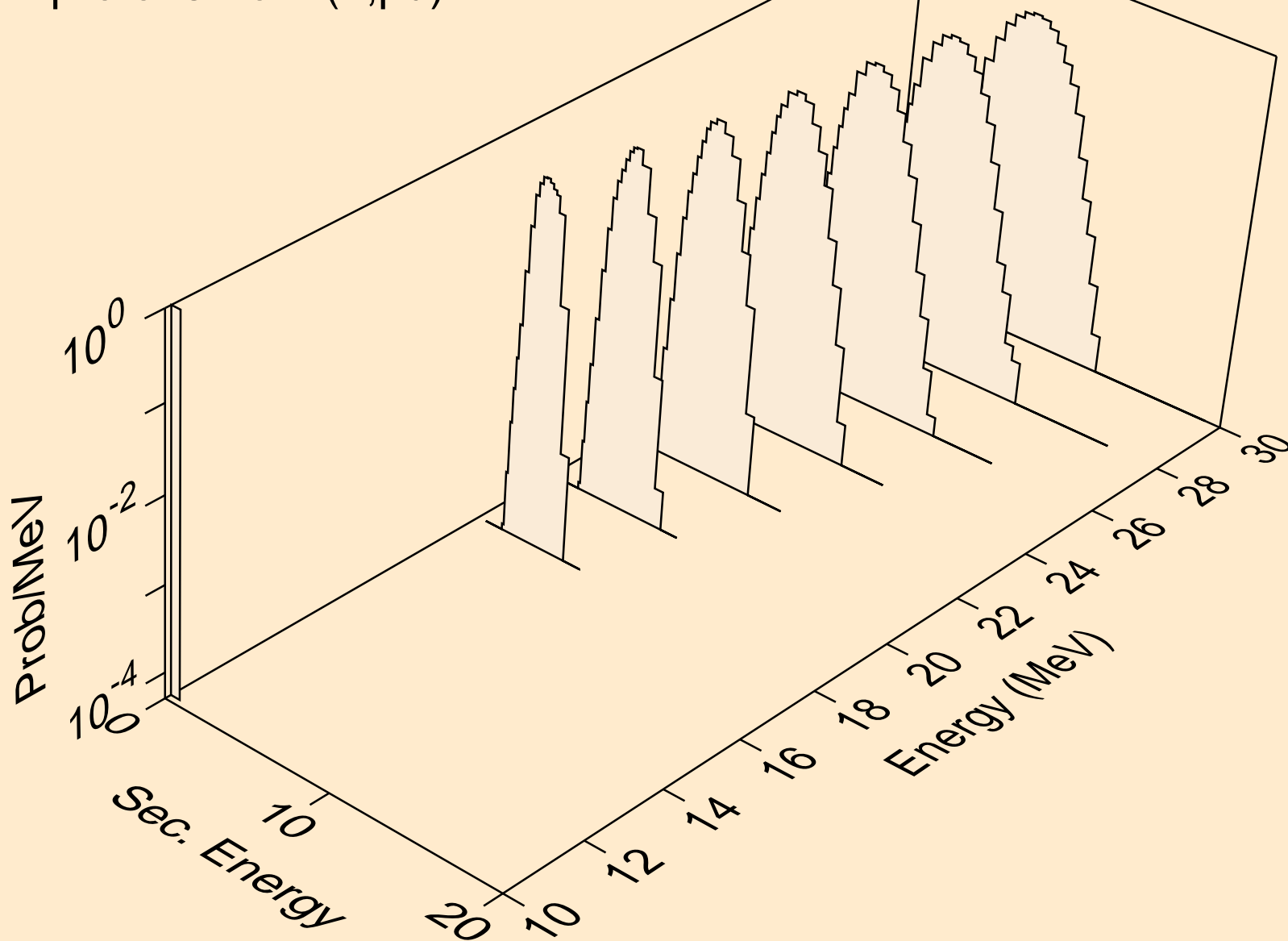

MAT=7722 ACE FILE PRODUCED AT NEA WITH NDEC
protons from (n,pt)

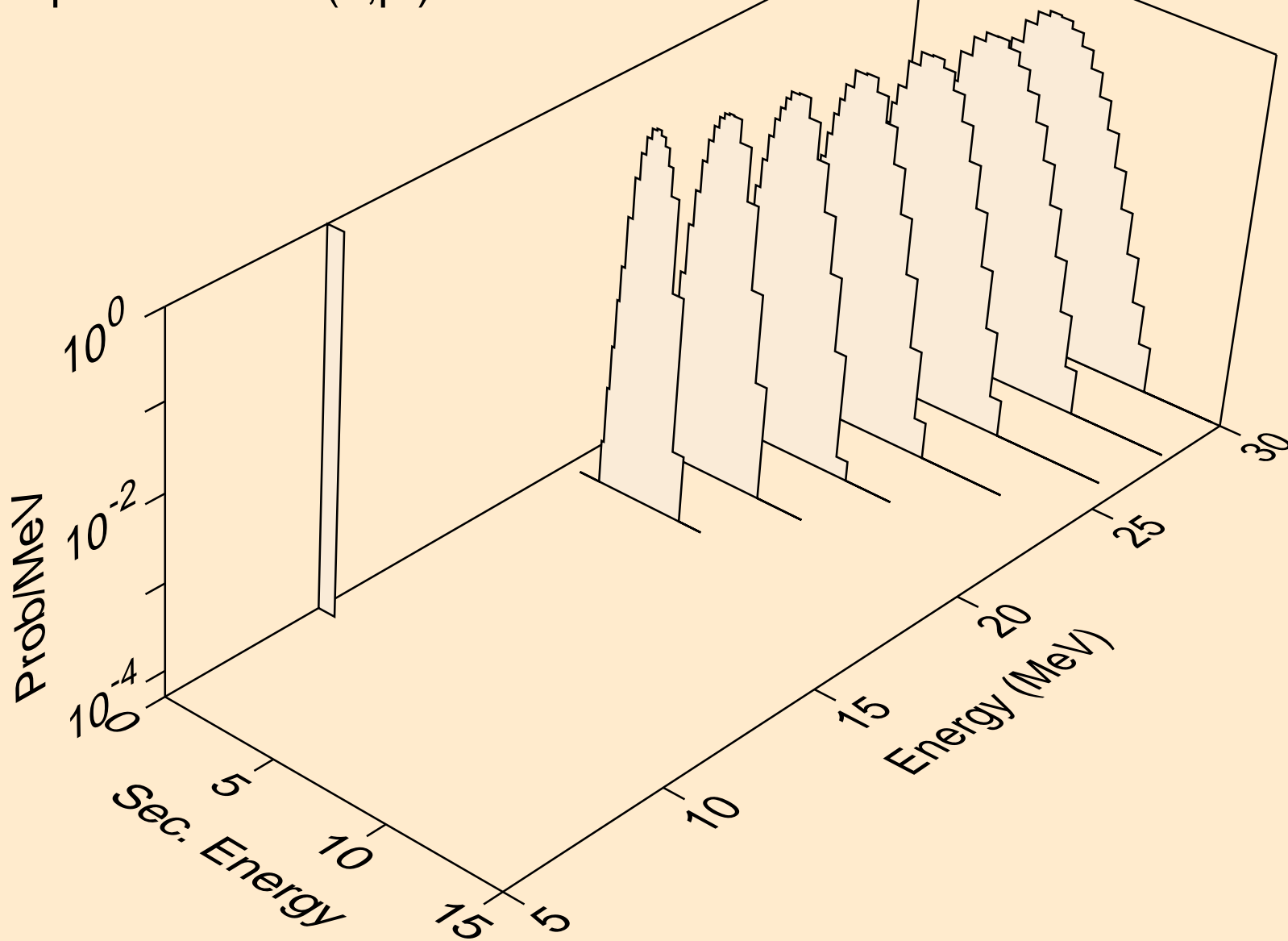

MAT=7722 ACE FILE PRODUCED AT NEA WITH NDEC
deuterons from (n,x)

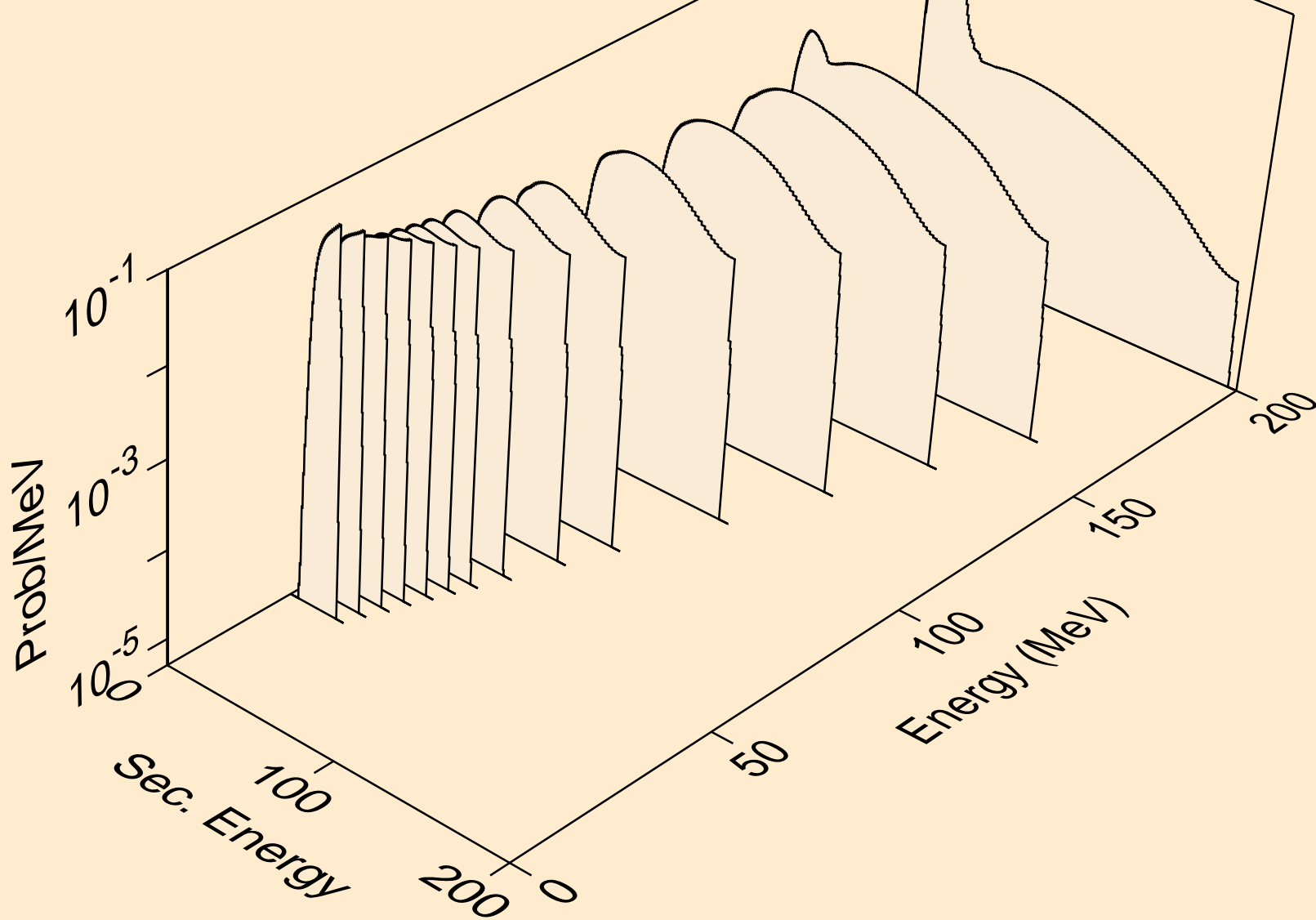

MAT=7722 ACE FILE PRODUCED AT NEA WITH NDEC
deuterons from (n,2nd)

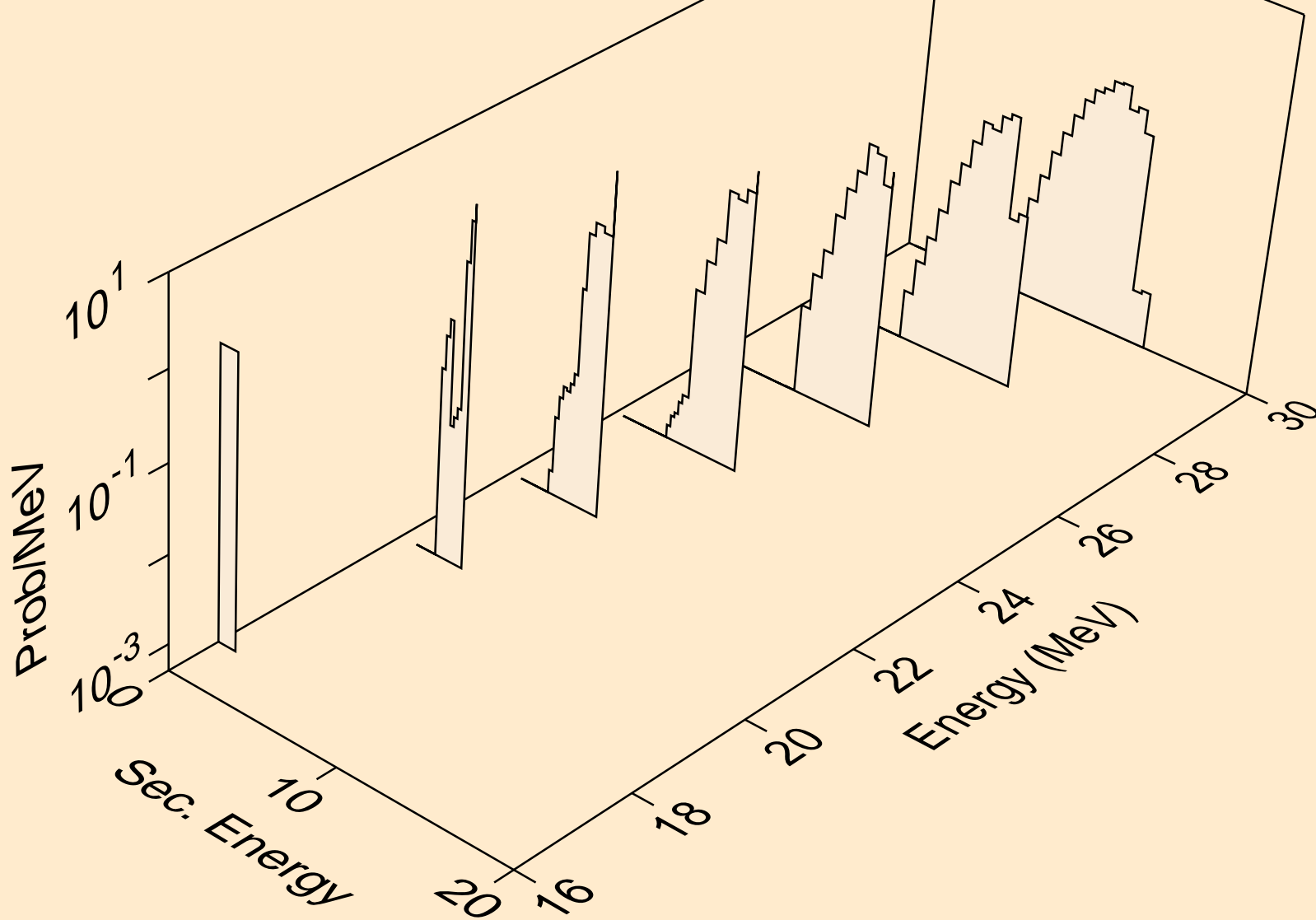

MAT=7722 ACE FILE PRODUCED AT NEA WITH NDEC
deuterons from (n,n*)d

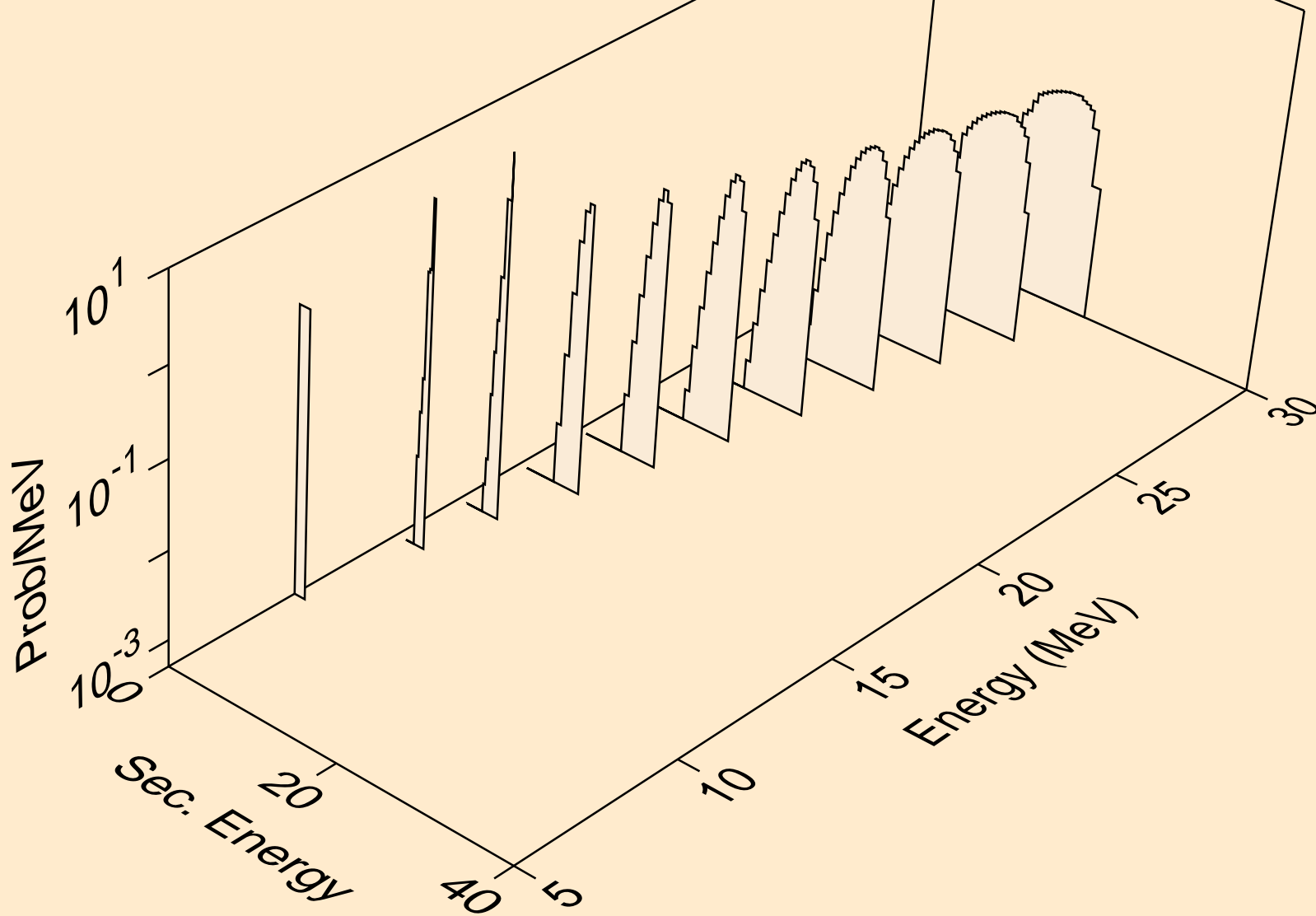

MAT=7722 ACE FILE PRODUCED AT NEA WITH NDEC
deuterons from (n,d)

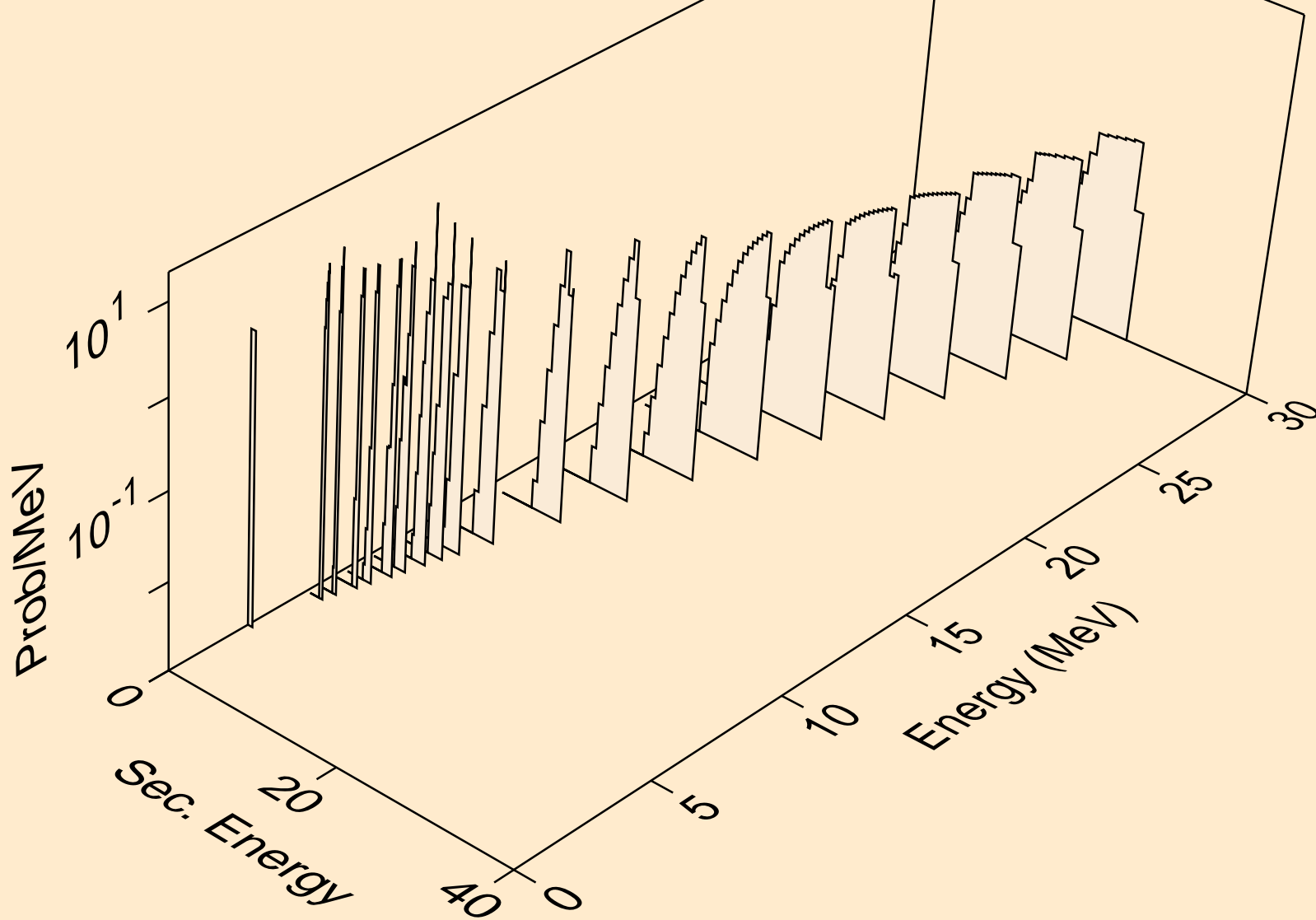

MAT=7722 ACE FILE PRODUCED AT NEA WITH NDEC
deuterons from (n,pd)

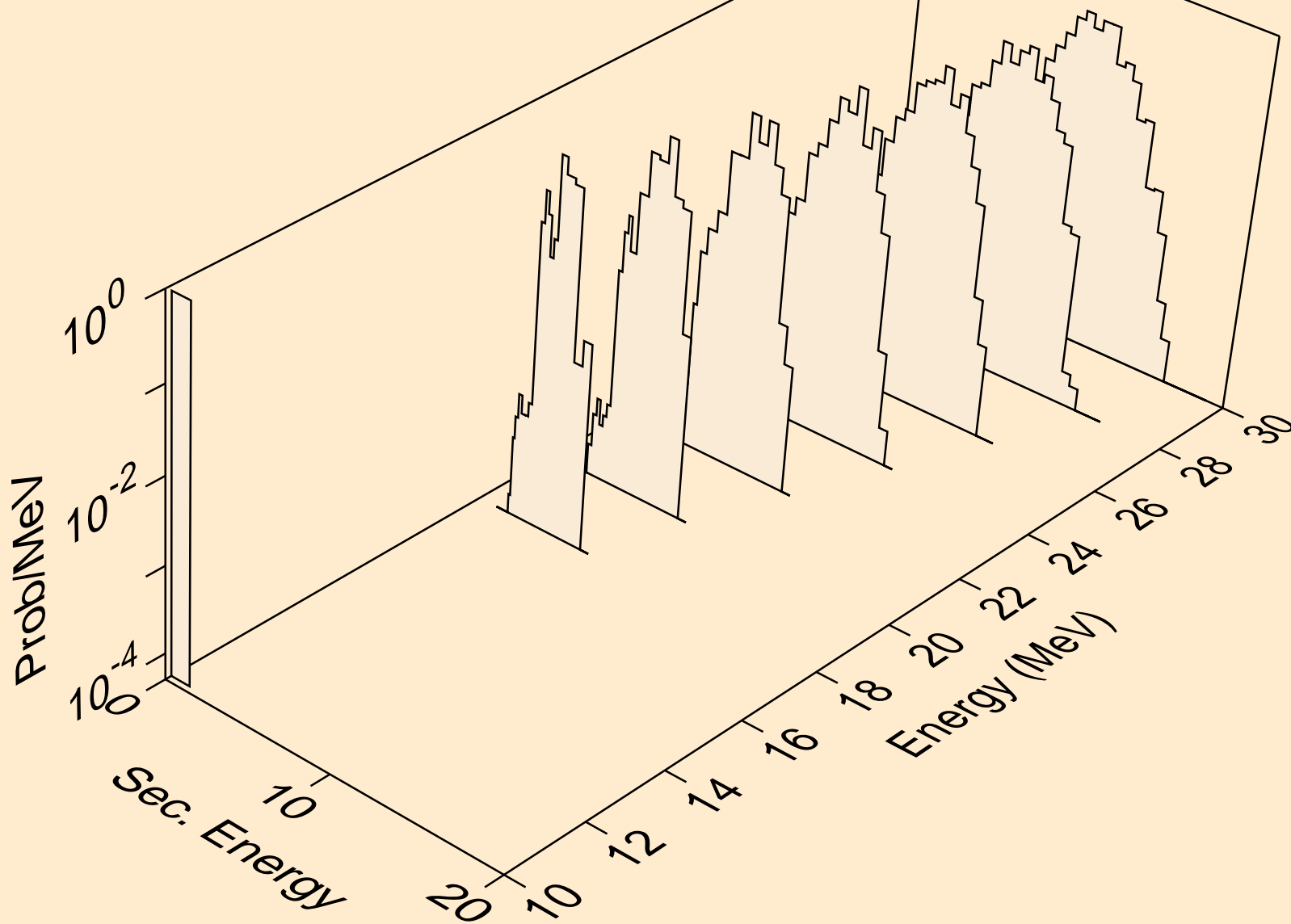

MAT=7722 ACE FILE PRODUCED AT NEA WITH NDEC
deuterons from (n,da)

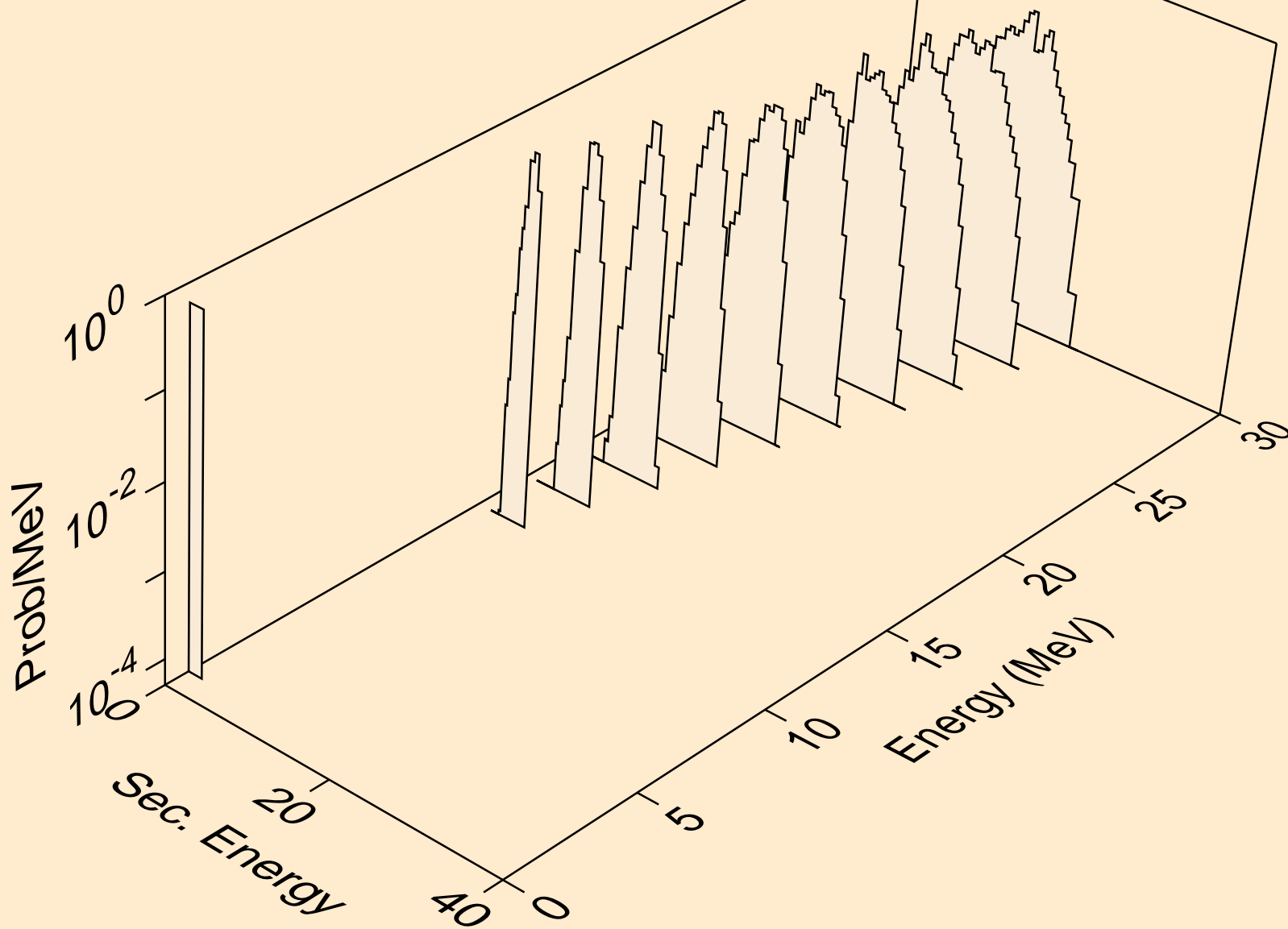

MAT=7722 ACE FILE PRODUCED AT NEA WITH NDEC
tritons from (n,x)

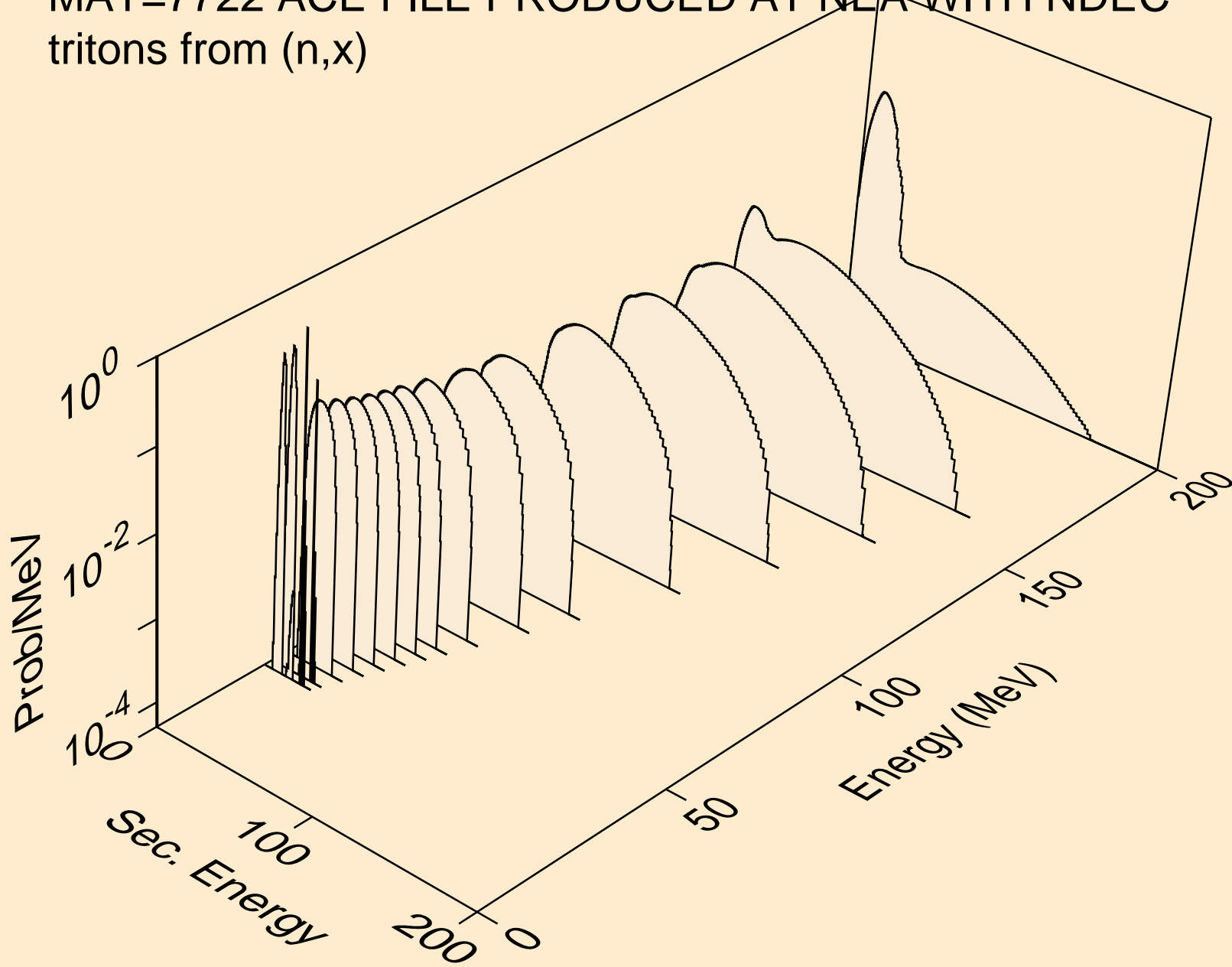

MAT=7722 ACE FILE PRODUCED AT NEA WITH NDEC
tritons from (n,n*)t

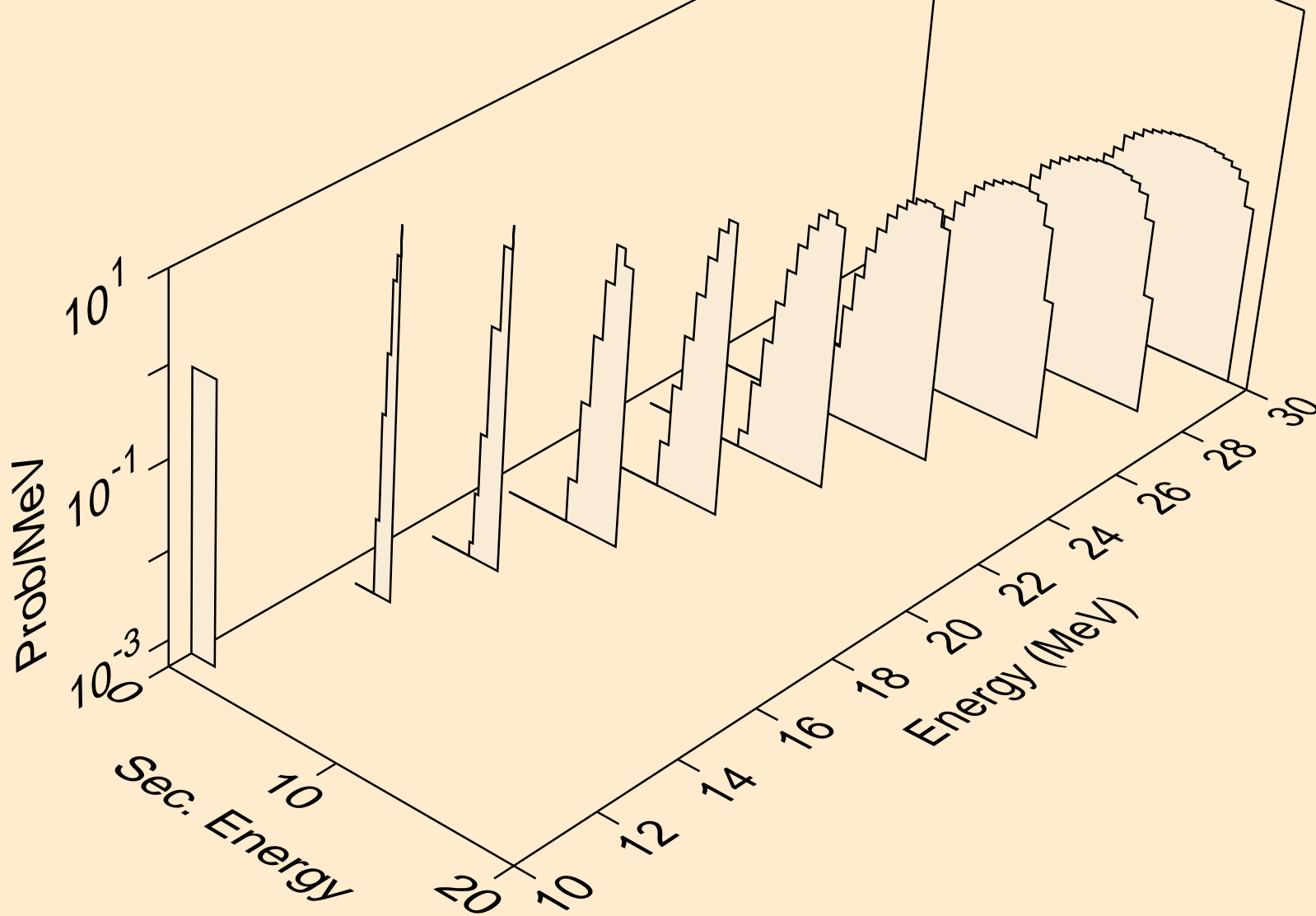

MAT=7722 ACE FILE PRODUCED AT NEA WITH NDEC
tritons from (n,t)

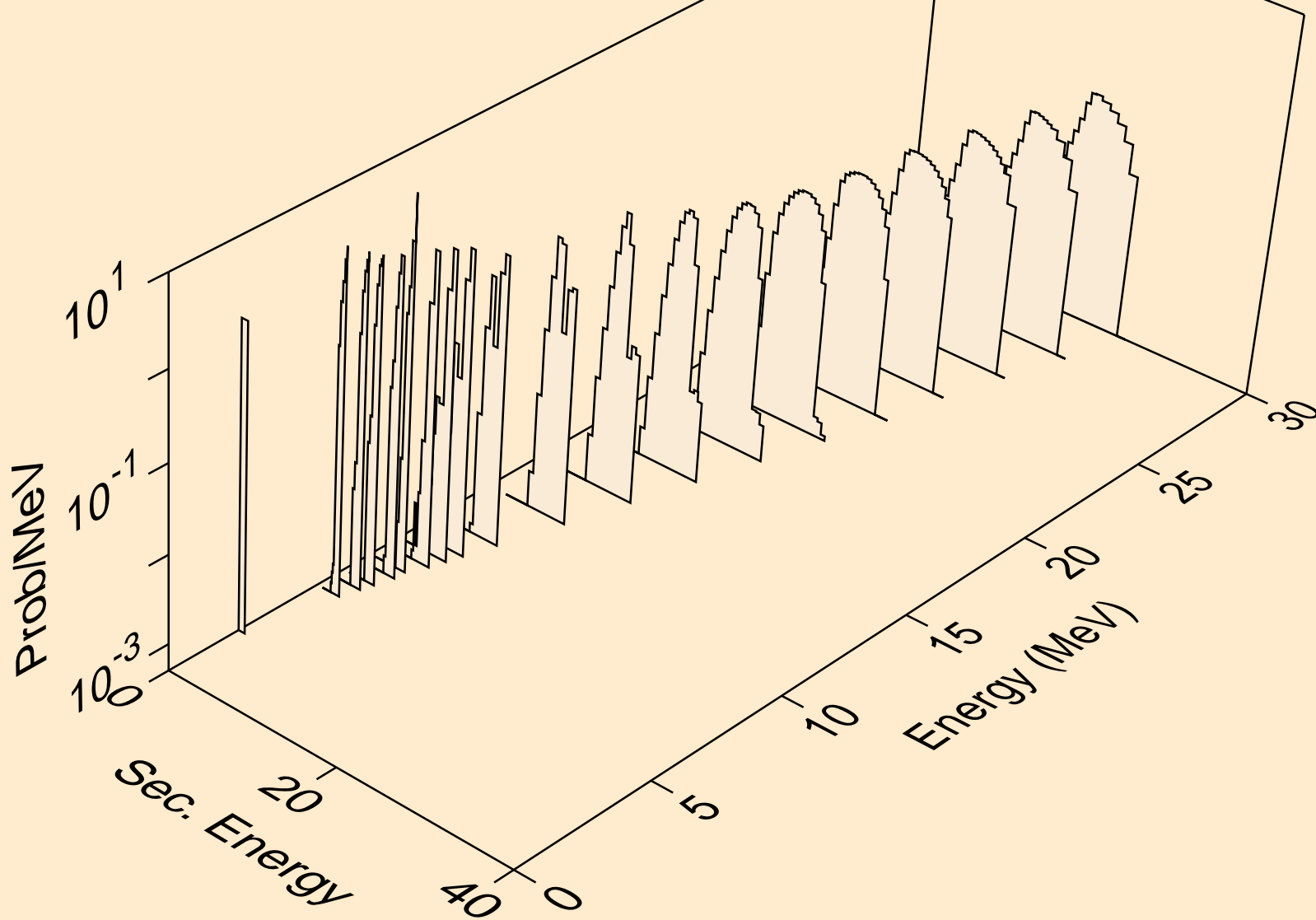

MAT=7722 ACE FILE PRODUCED AT NEA WITH NDEC
tritons from (n,pt)

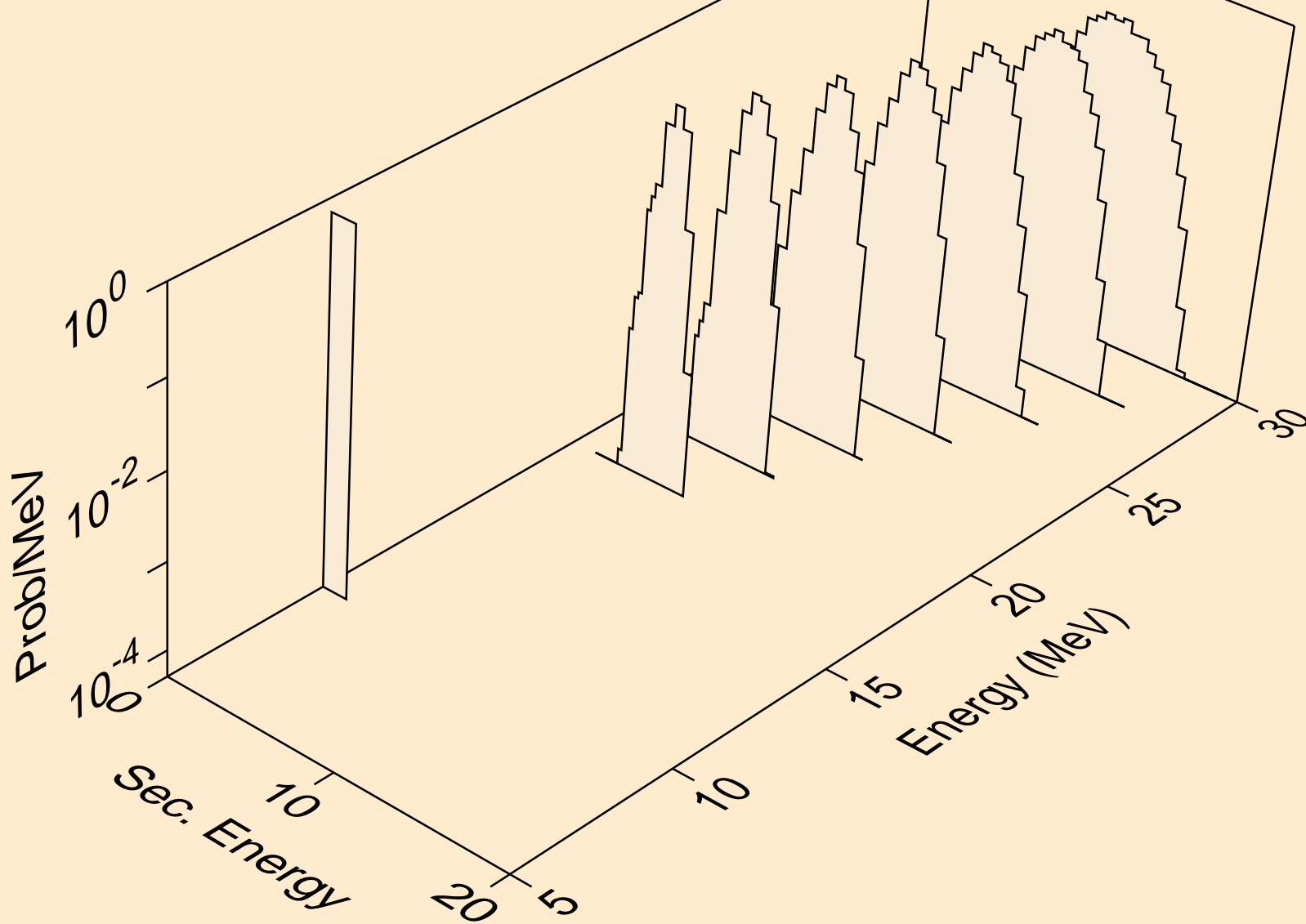

MAT=7722 ACE FILE PRODUCED AT NEA WITH NDEC
he3s from (n,x)

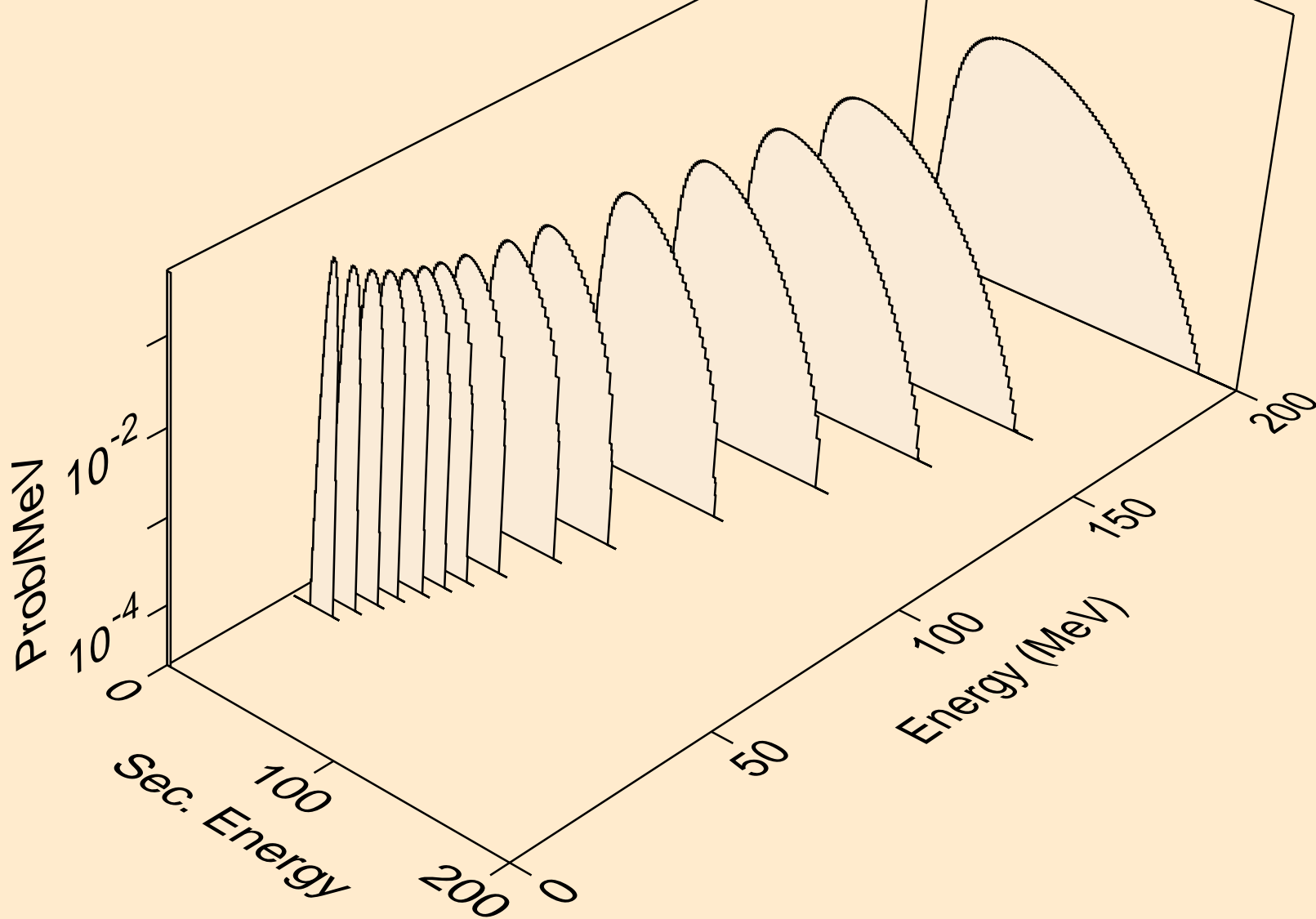

MAT=7722 ACE FILE PRODUCED AT NEA WITH NDEC
he3s from (n,n*)he3

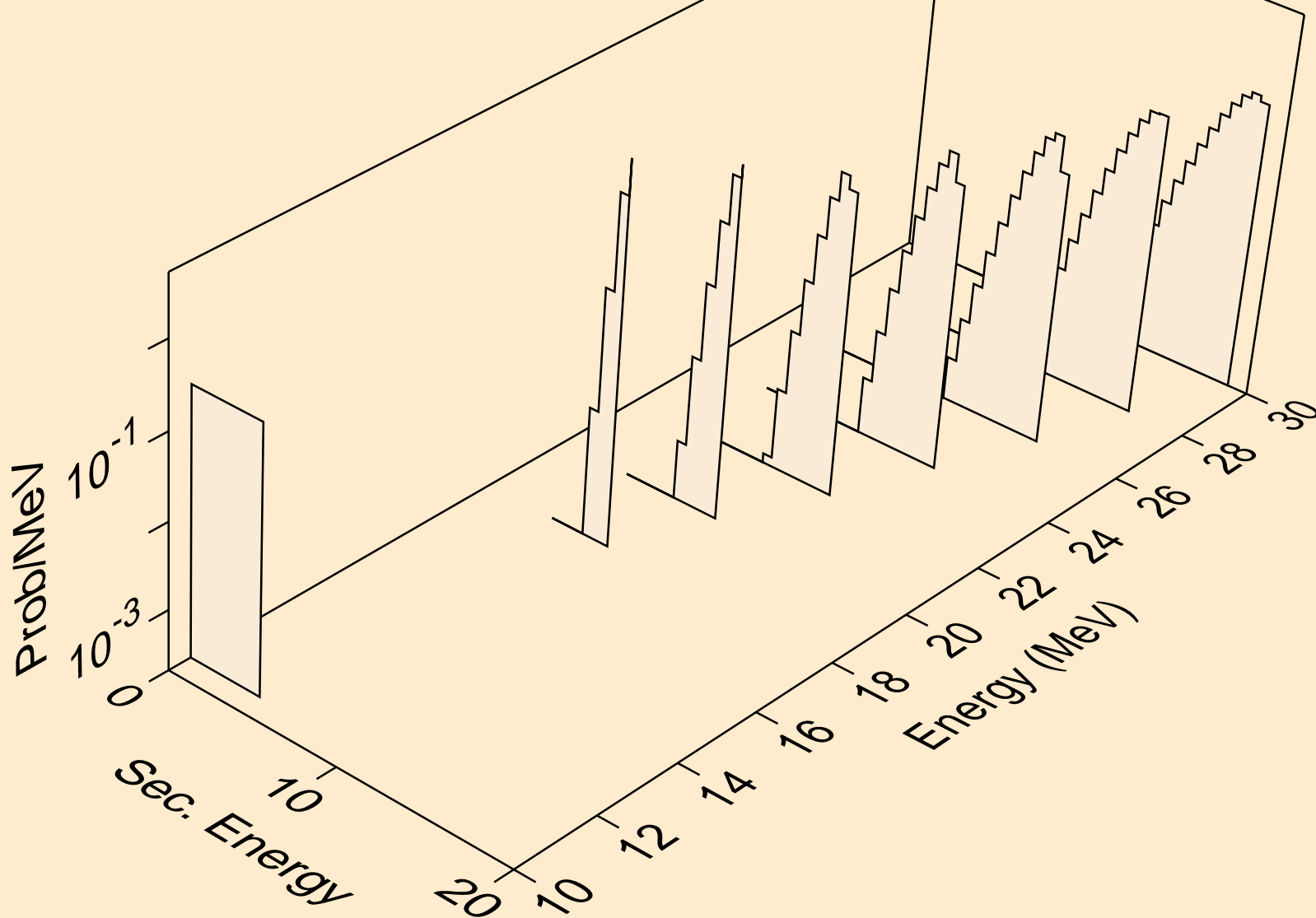

MAT=7722 ACE FILE PRODUCED AT NEA WITH NDEC
he3s from (n,he3)

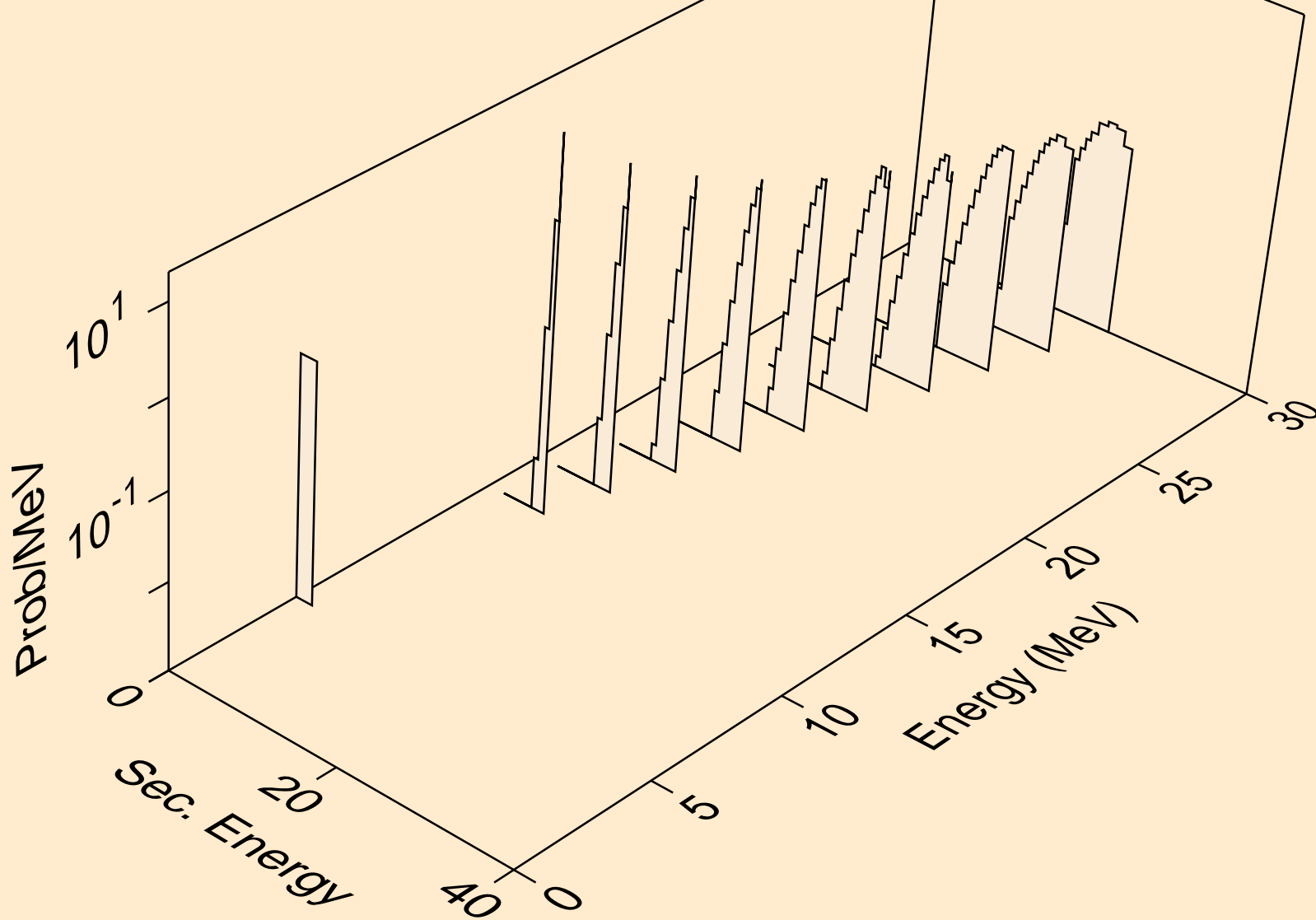

MAT=7722 ACE FILE PRODUCED AT NEA WITH NDEC
alphas from (n,x)

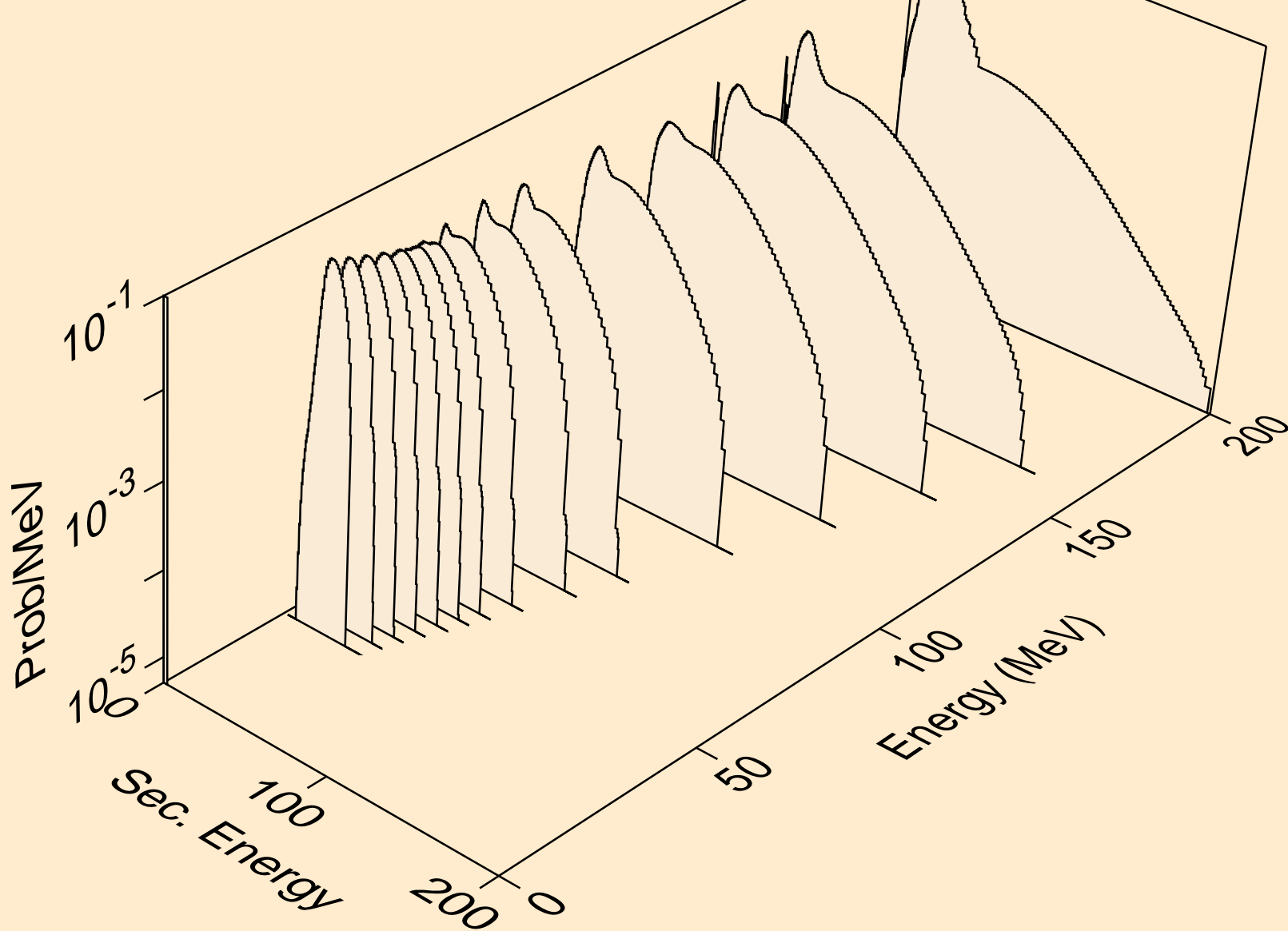

MAT=7722 ACE FILE PRODUCED AT NEA WITH NDEC
alphas from (n,n*)a

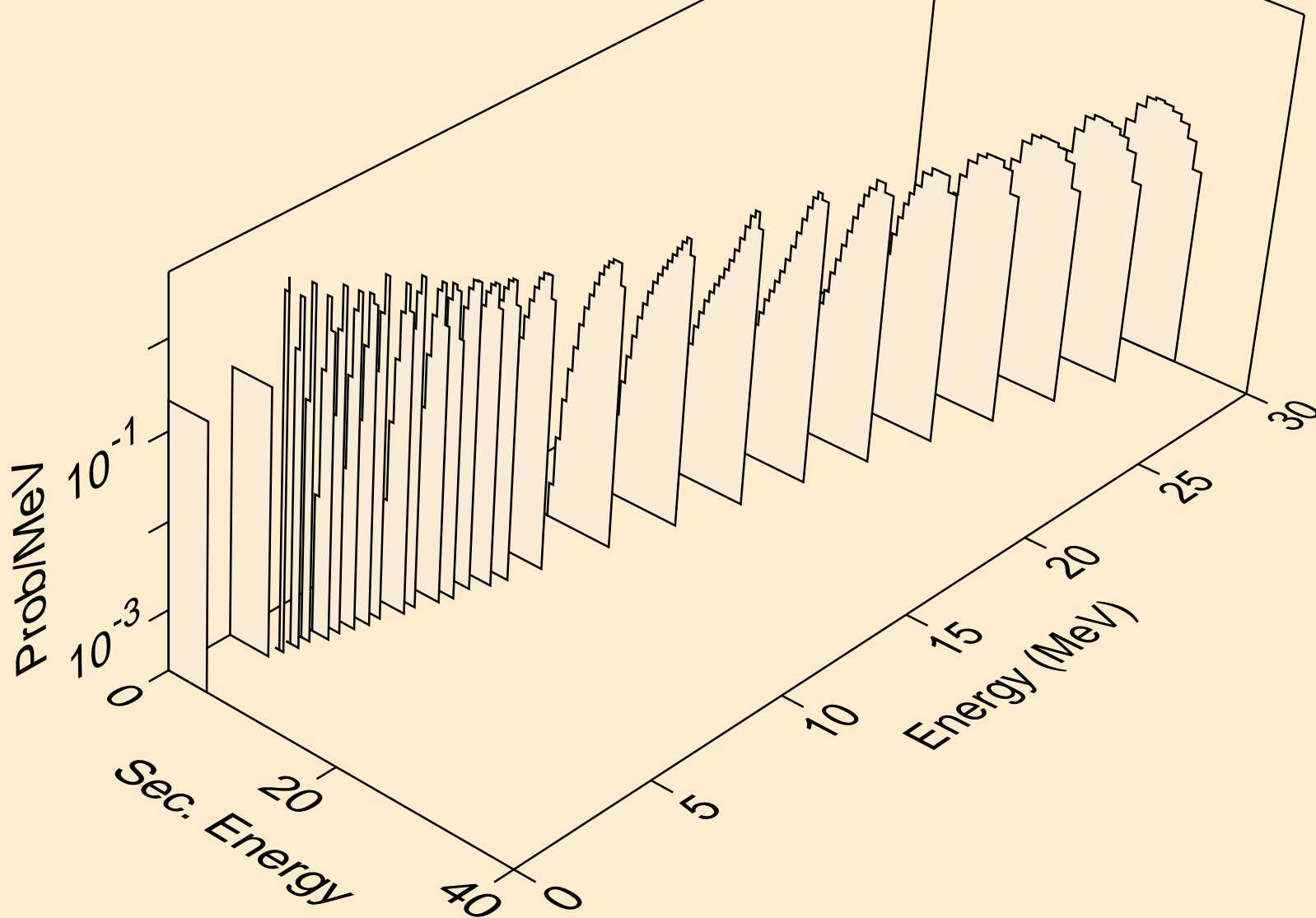

MAT=7722 ACE FILE PRODUCED AT NEA WITH NDEC
alphas from (n,2n)a

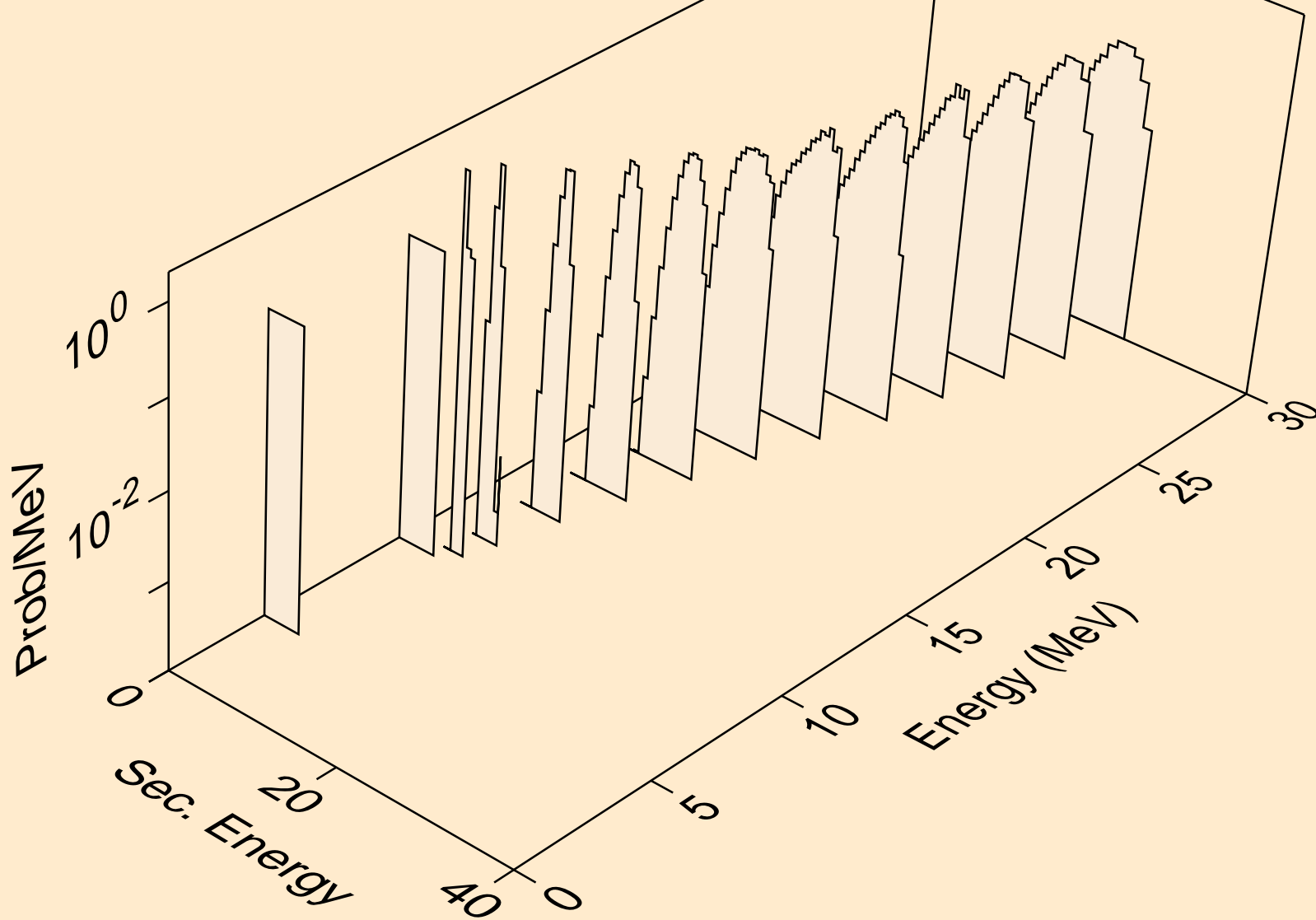

MAT=7722 ACE FILE PRODUCED AT NEA WITH NDEC
alphas from (n,3n)a

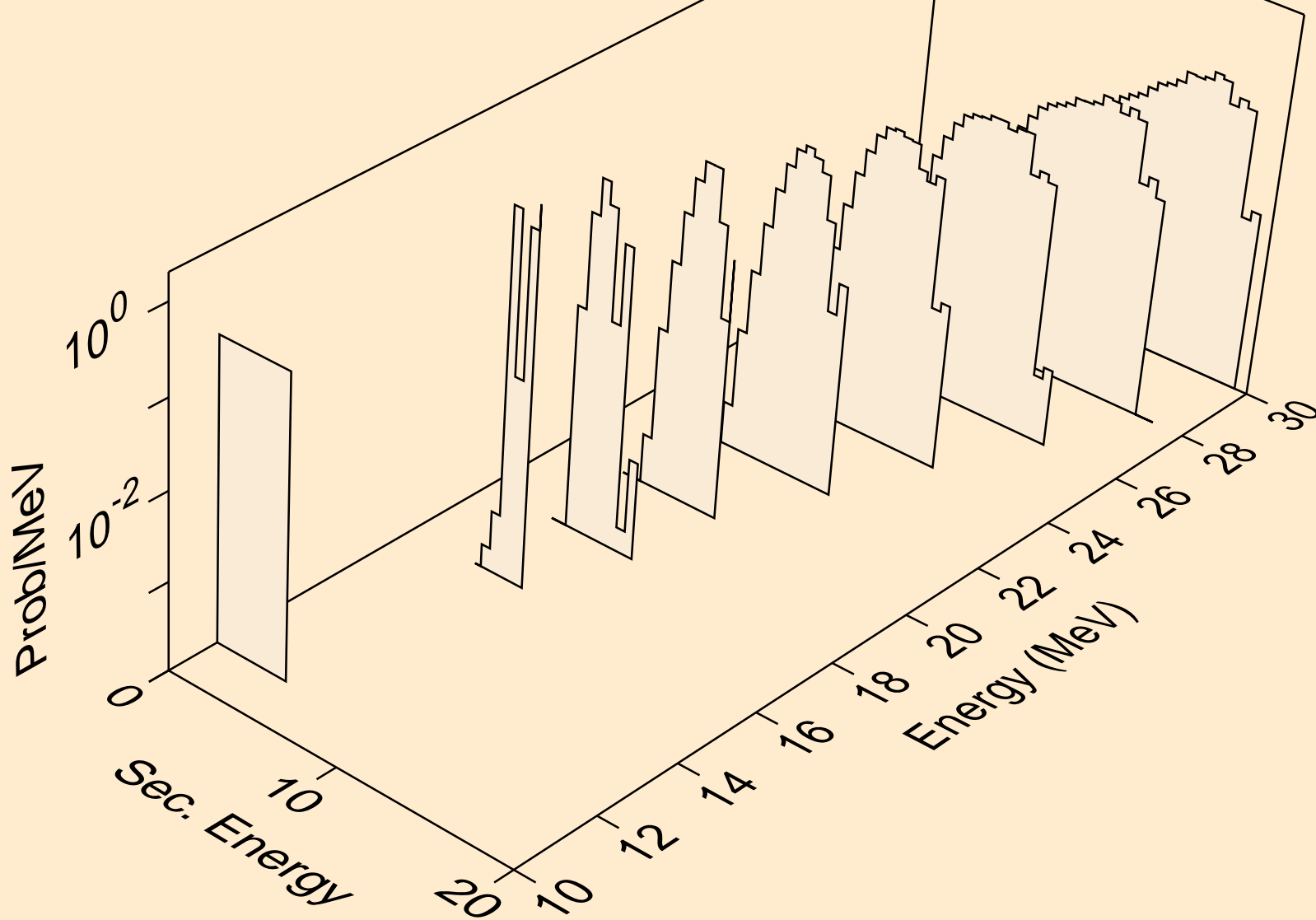

MAT=7722 ACE FILE PRODUCED AT NEA WITH NDEC
alphas from (n,n*)2a

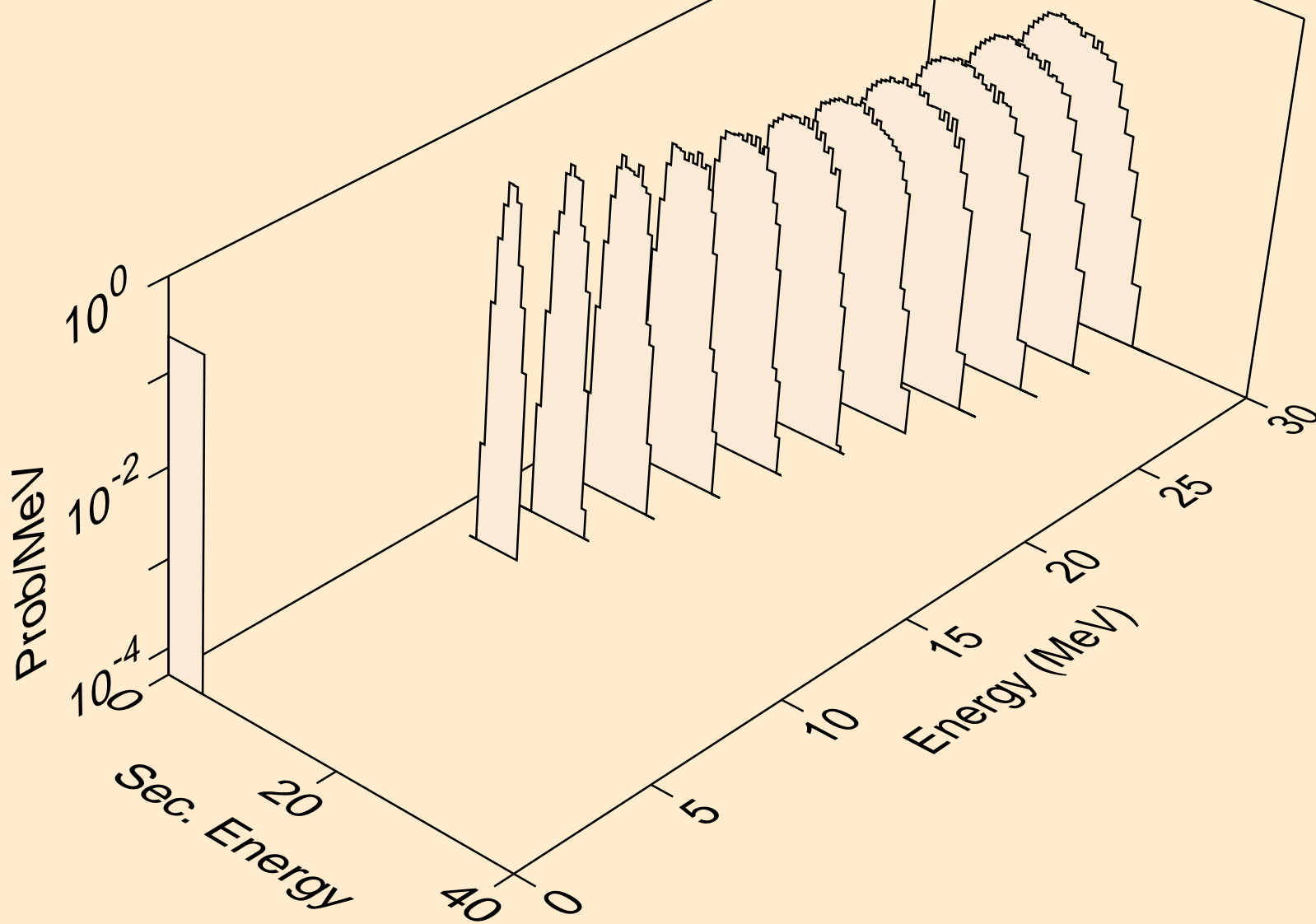

MAT=7722 ACE FILE PRODUCED AT NEA WITH NDEC
alphas from (n,npa)

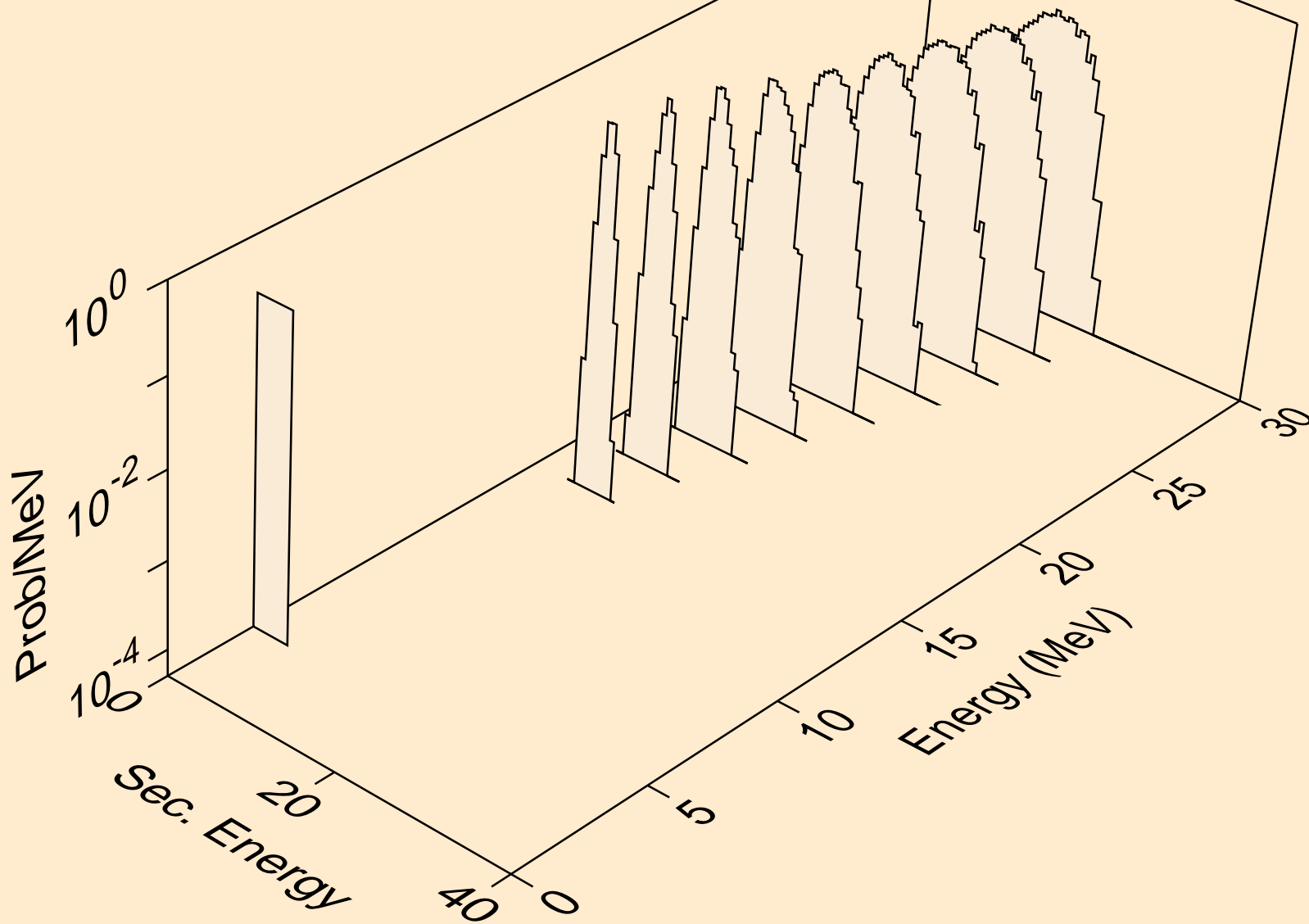

MAT=7722 ACE FILE PRODUCED AT NEA WITH NDEC
alphas from (n,a)

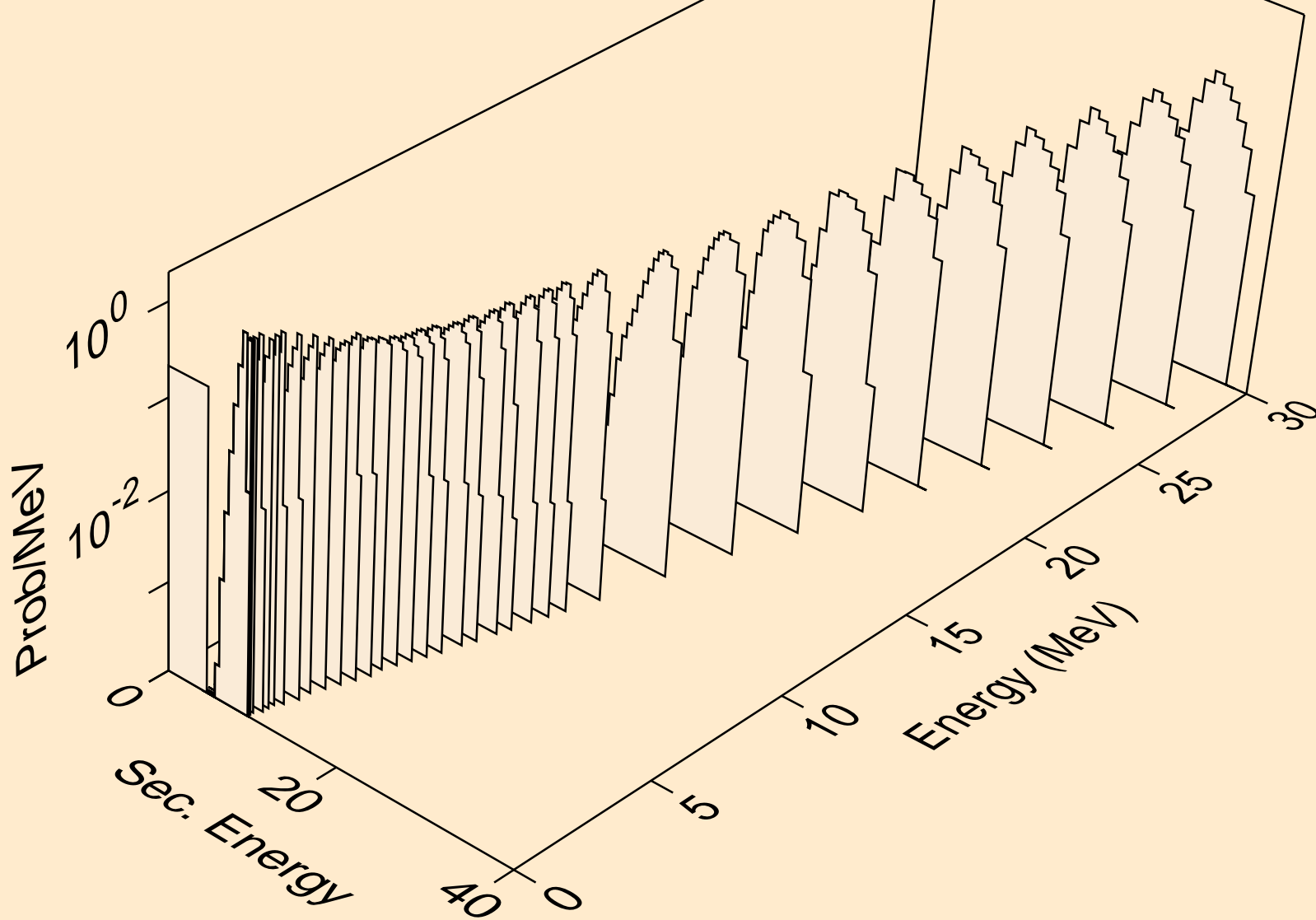

MAT=7722 ACE FILE PRODUCED AT NEA WITH NDEC
alphas from (n,2a)

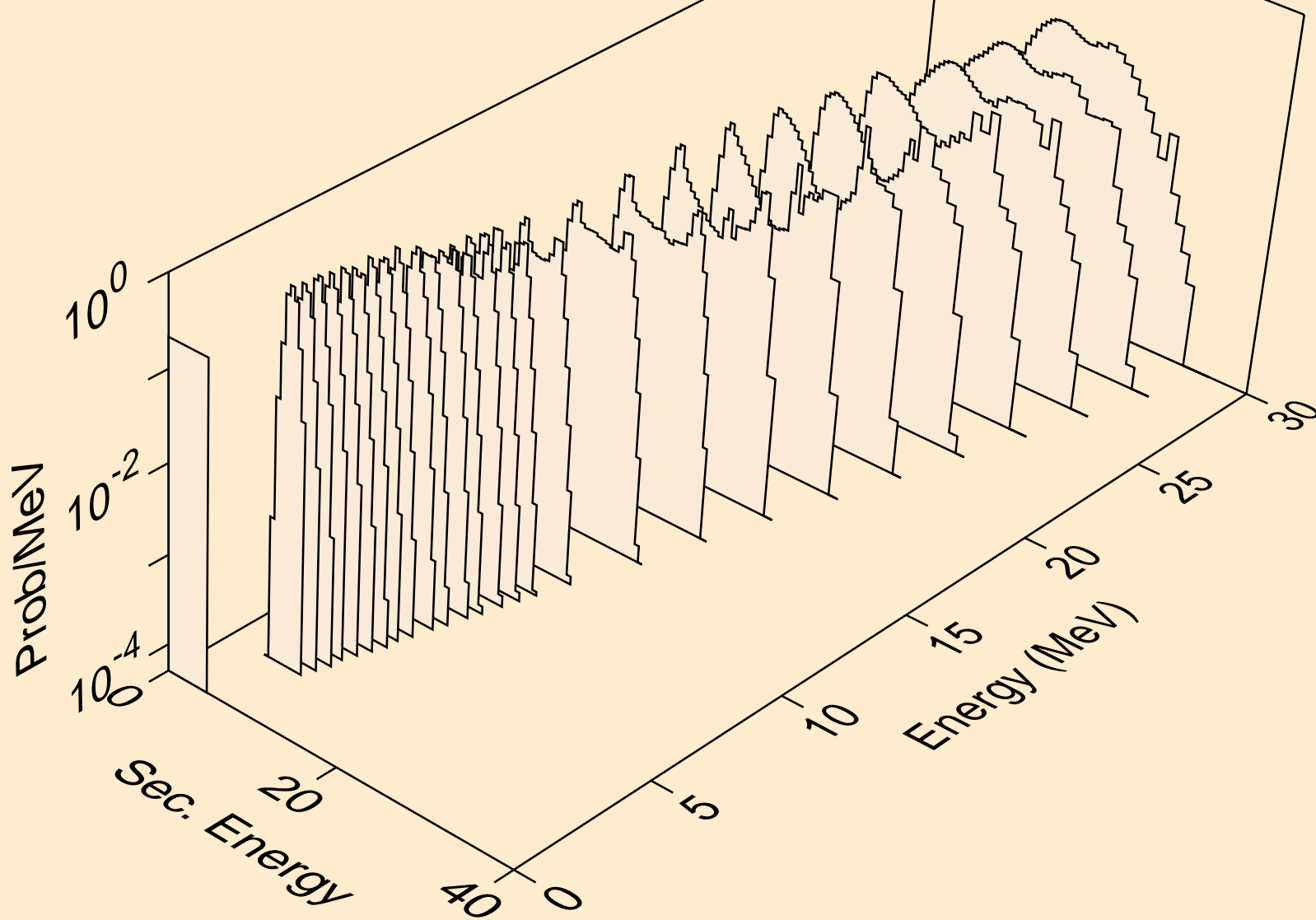

MAT=7722 ACE FILE PRODUCED AT NEA WITH NDEC
alphas from (n,pa)

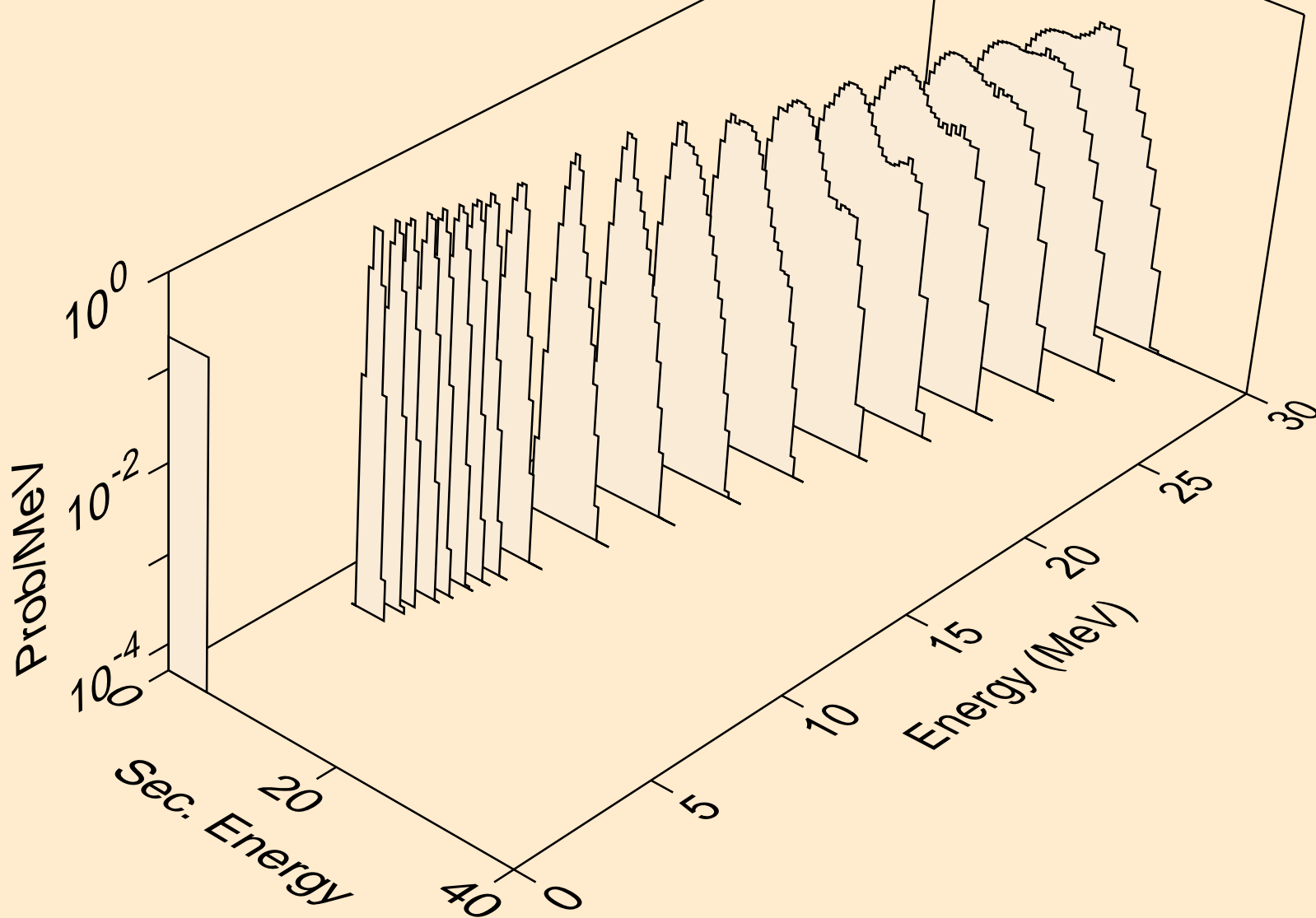

MAT=7722 ACE FILE PRODUCED AT NEA WITH NDEC
alphas from (n,da)

