

MAT=6831 ACE FILE PRODUCED AT NEA WITH NDEC  
Principal cross sections

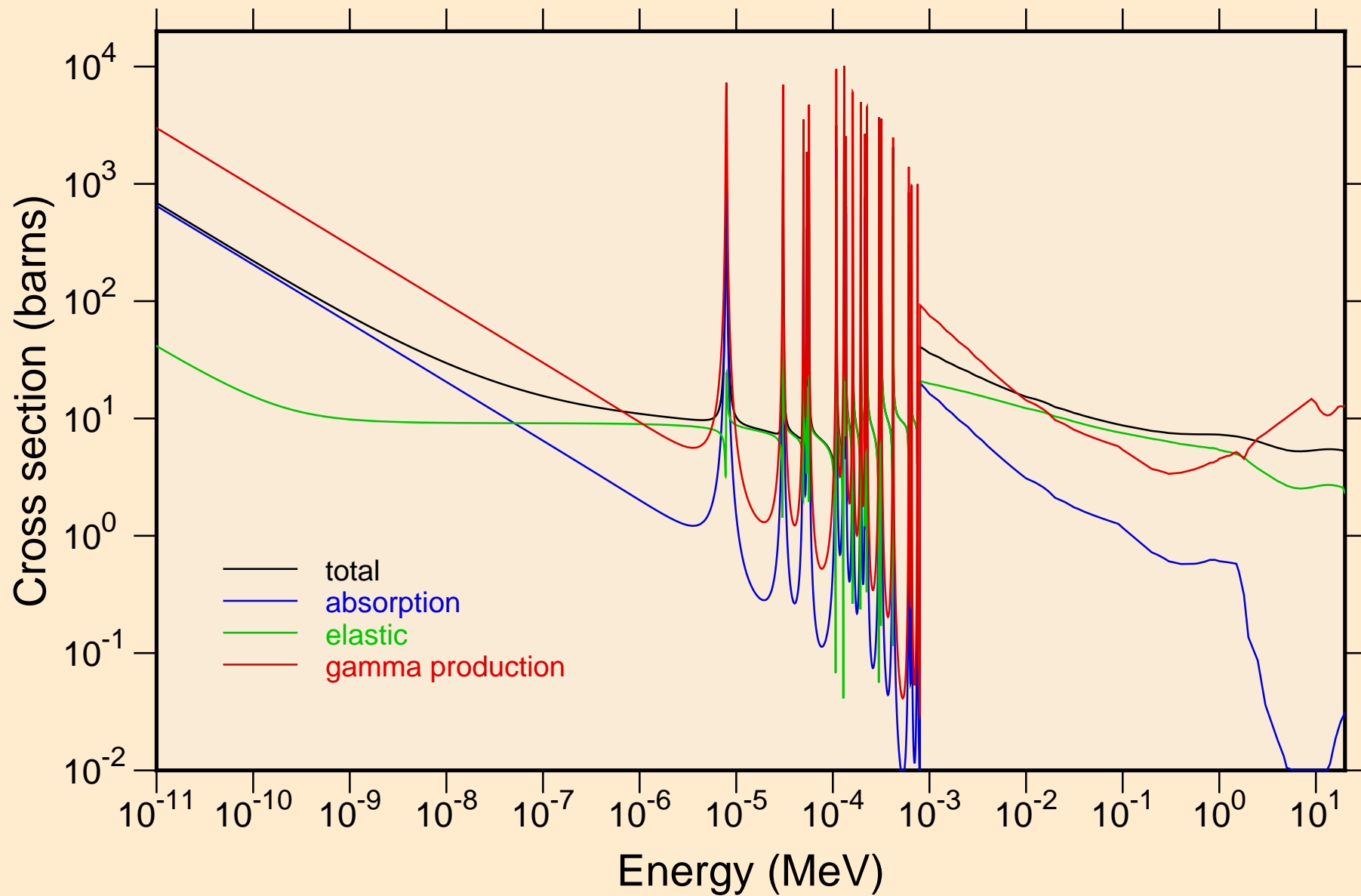

MAT=6831 ACE FILE PRODUCED AT NEA WITH NDEC  
resonance total cross section

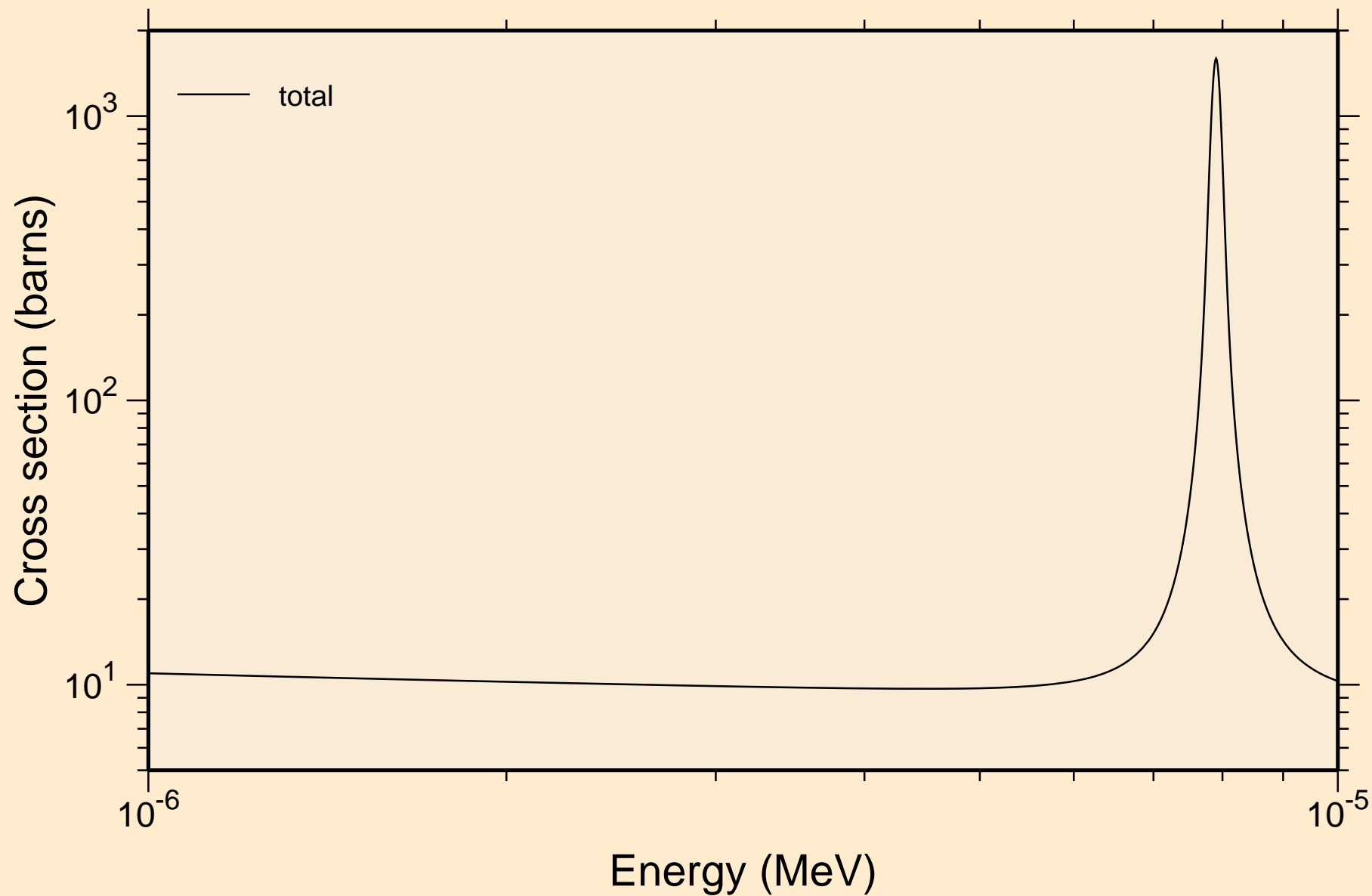

MAT=6831 ACE FILE PRODUCED AT NEA WITH NDEC  
resonance total cross section

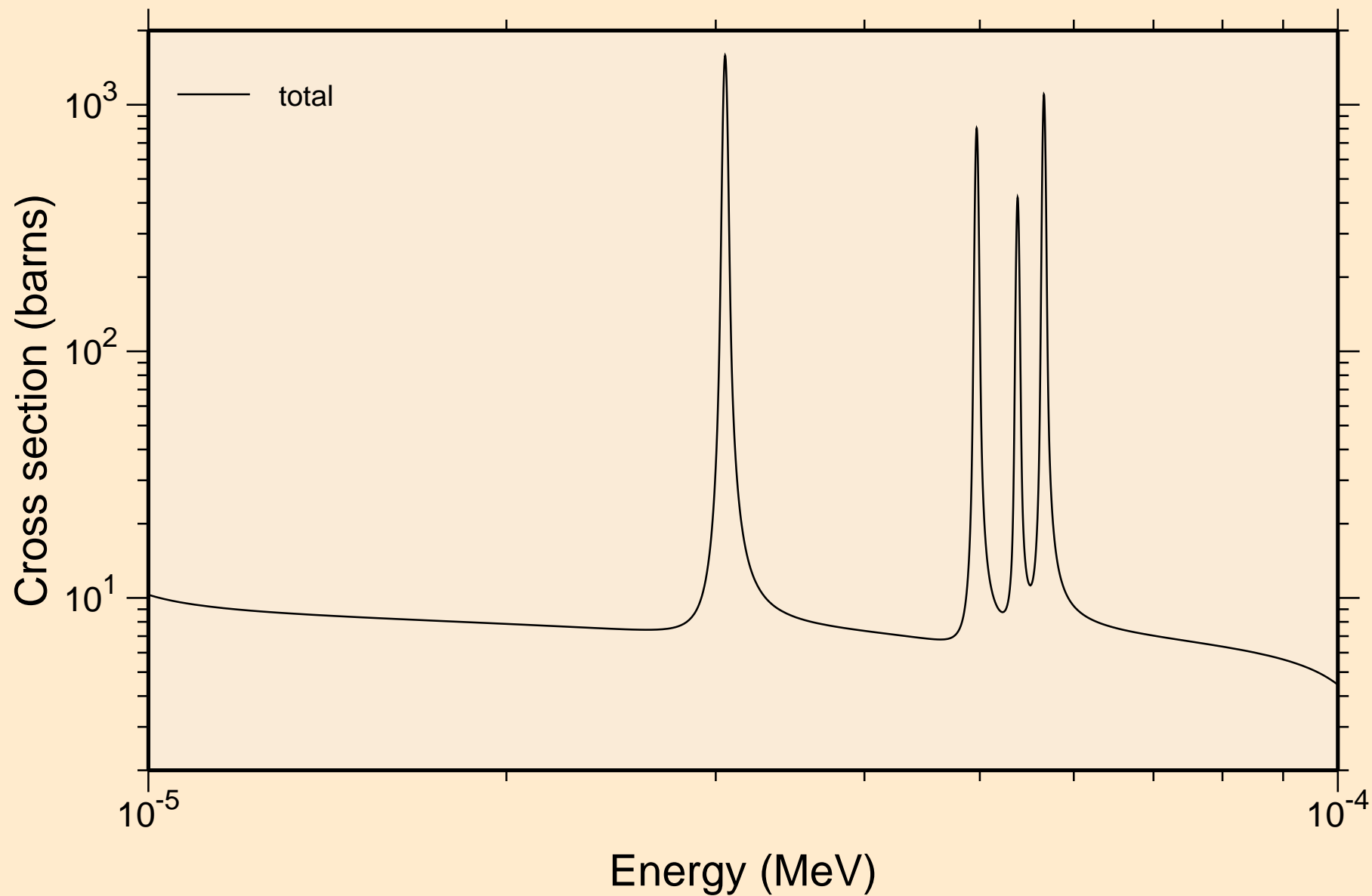

MAT=6831 ACE FILE PRODUCED AT NEA WITH NDEC  
resonance total cross section

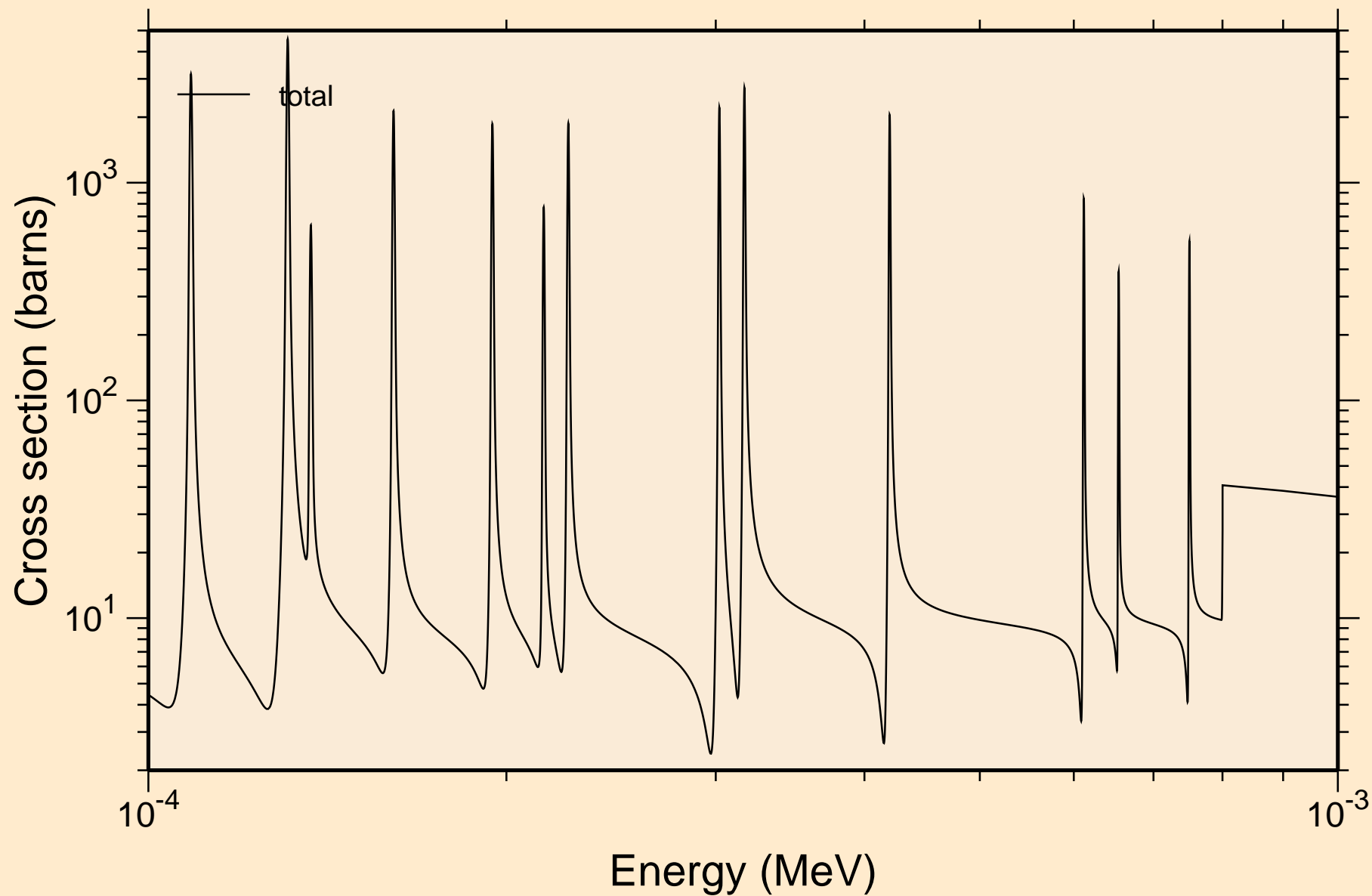

MAT=6831 ACE FILE PRODUCED AT NEA WITH NDEC  
resonance absorption cross sections

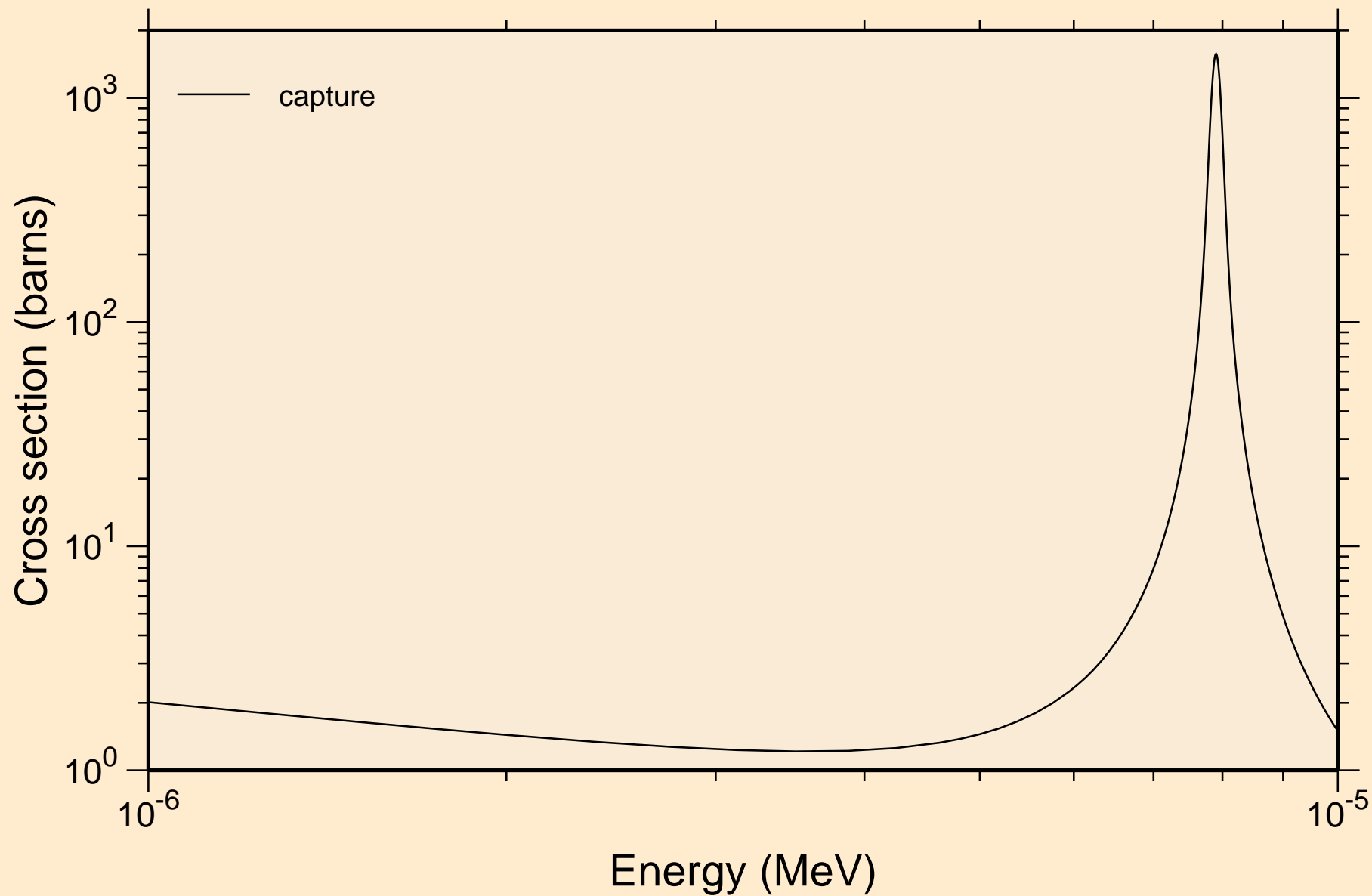

MAT=6831 ACE FILE PRODUCED AT NEA WITH NDEC  
resonance absorption cross sections

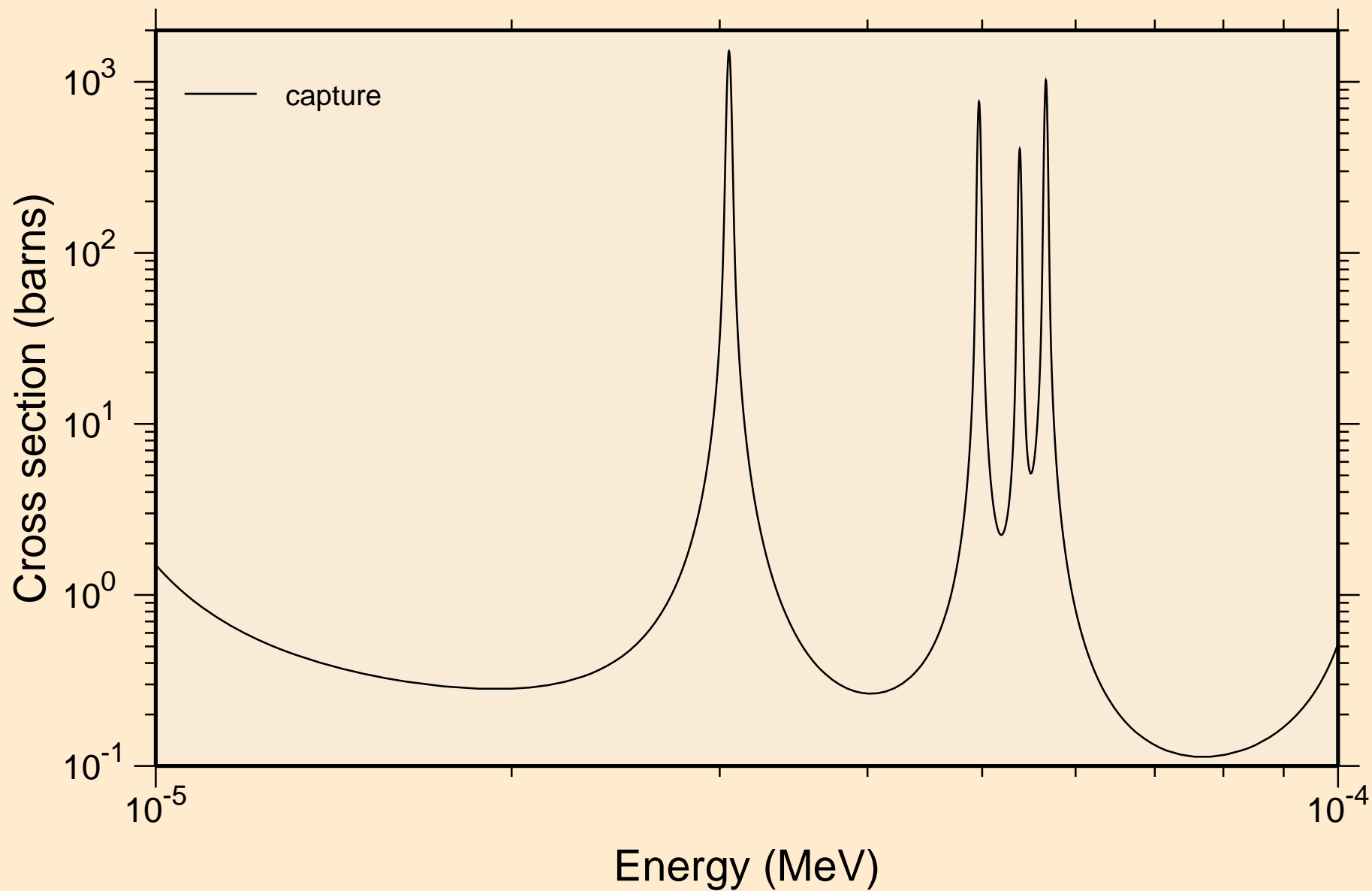



MAT=6831 ACE FILE PRODUCED AT NEA WITH NDEC  
UR total cross section

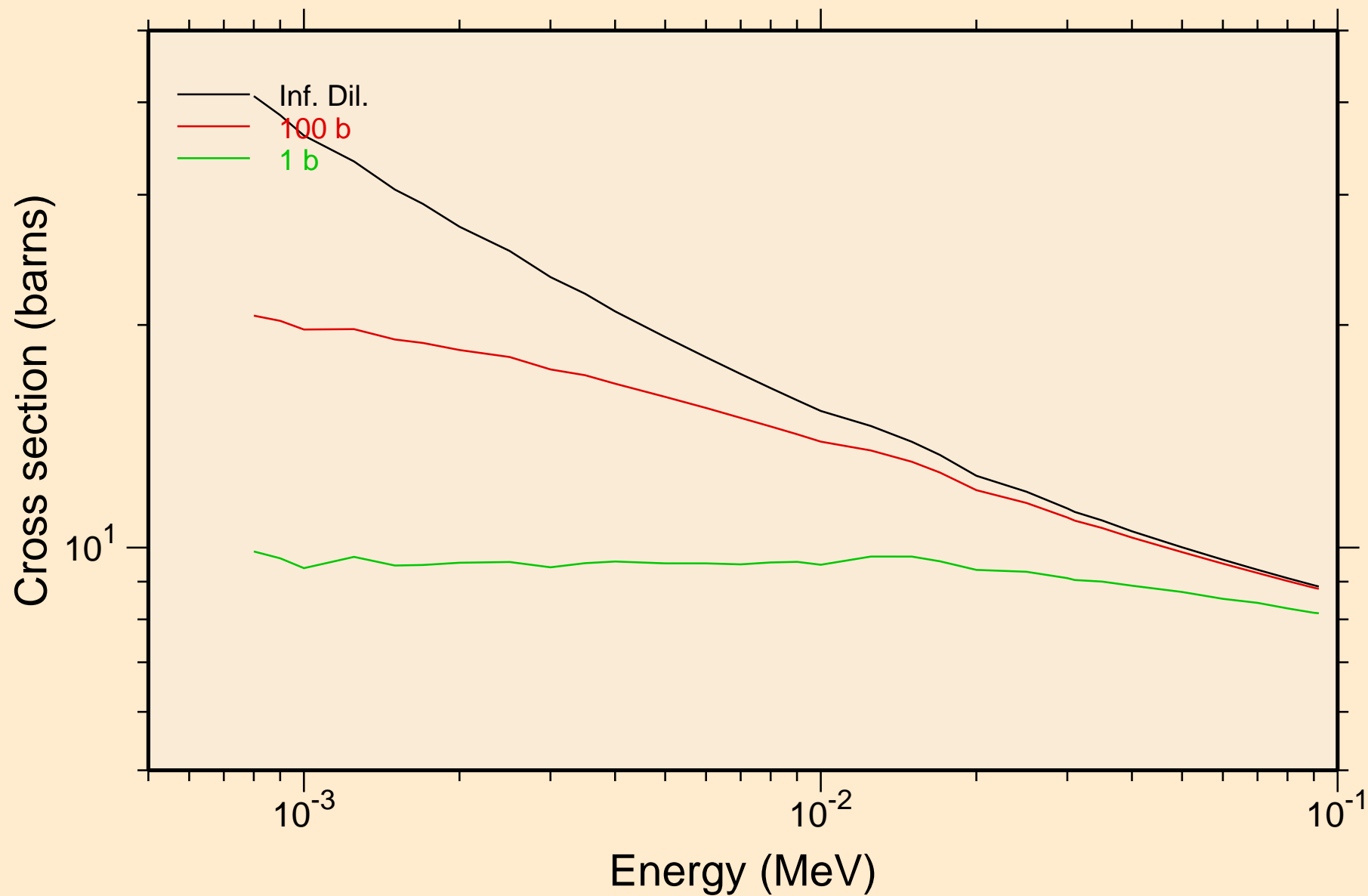

MAT=6831 ACE FILE PRODUCED AT NEA WITH NDEC  
UR elastic cross section

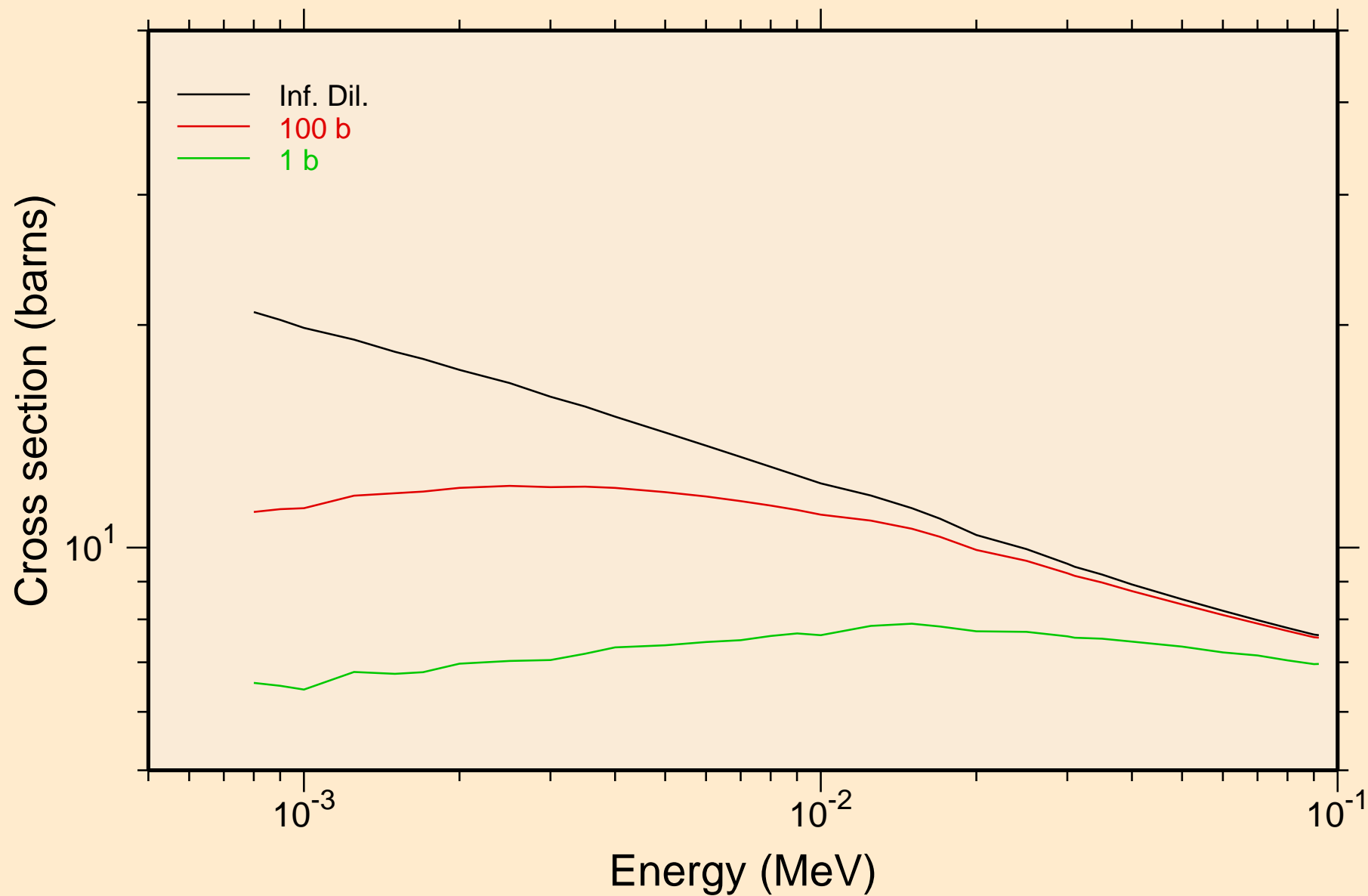

MAT=6831 ACE FILE PRODUCED AT NEA WITH NDEC  
UR capture cross section

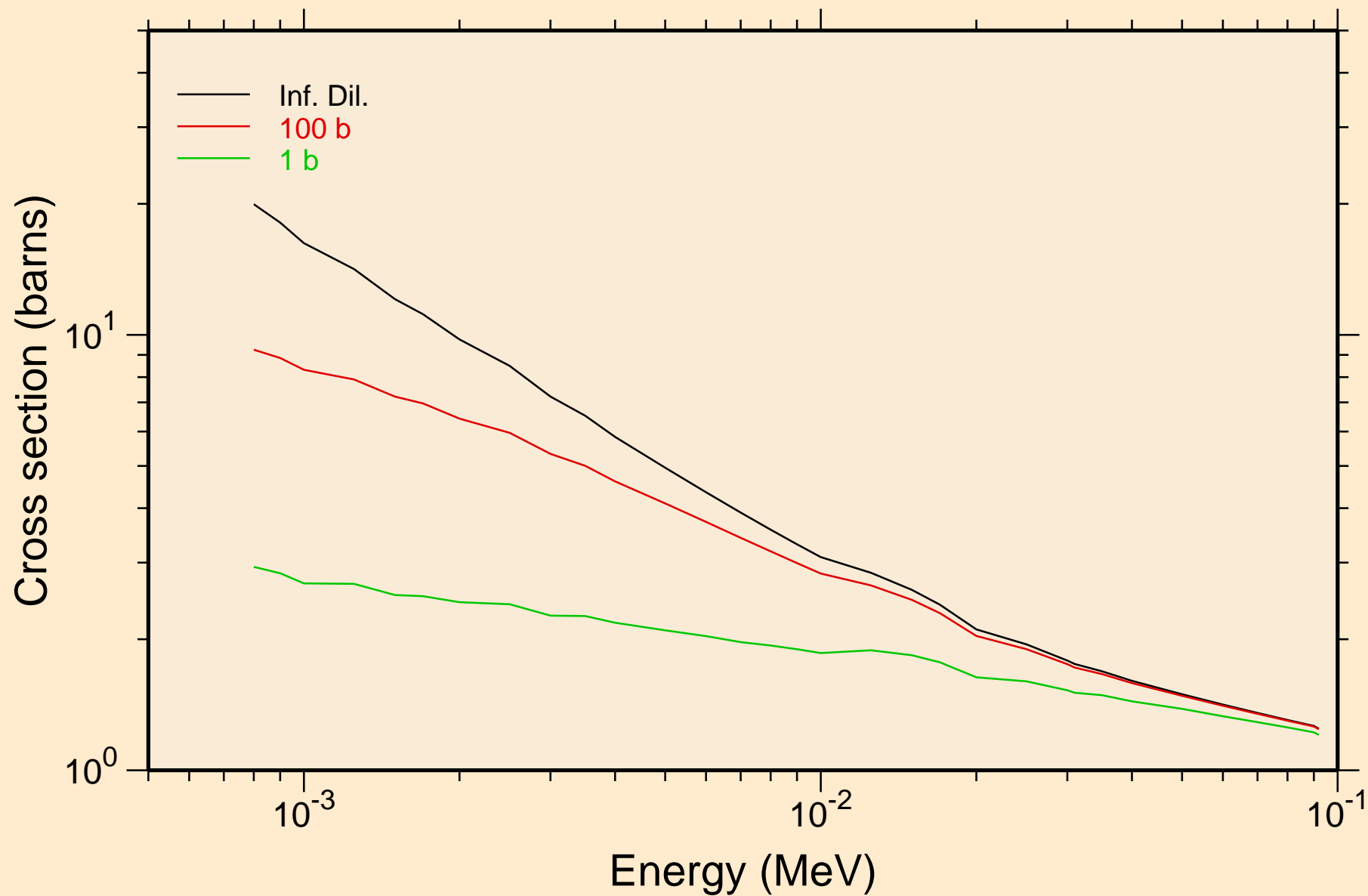

MAT=6831 ACE FILE PRODUCED AT NEA WITH NDEC  
Heating

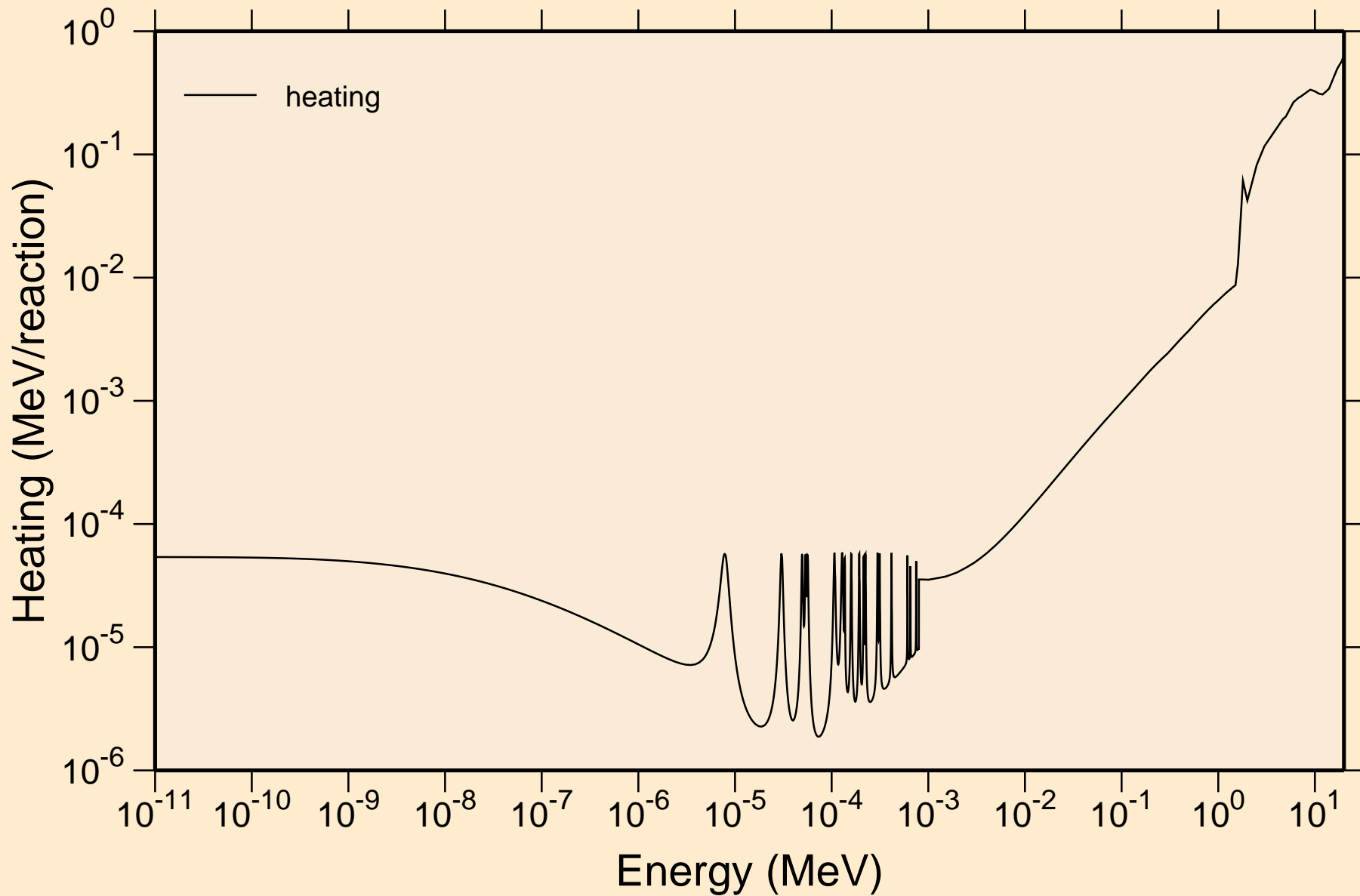

MAT=6831 ACE FILE PRODUCED AT NEA WITH NDEC  
Damage

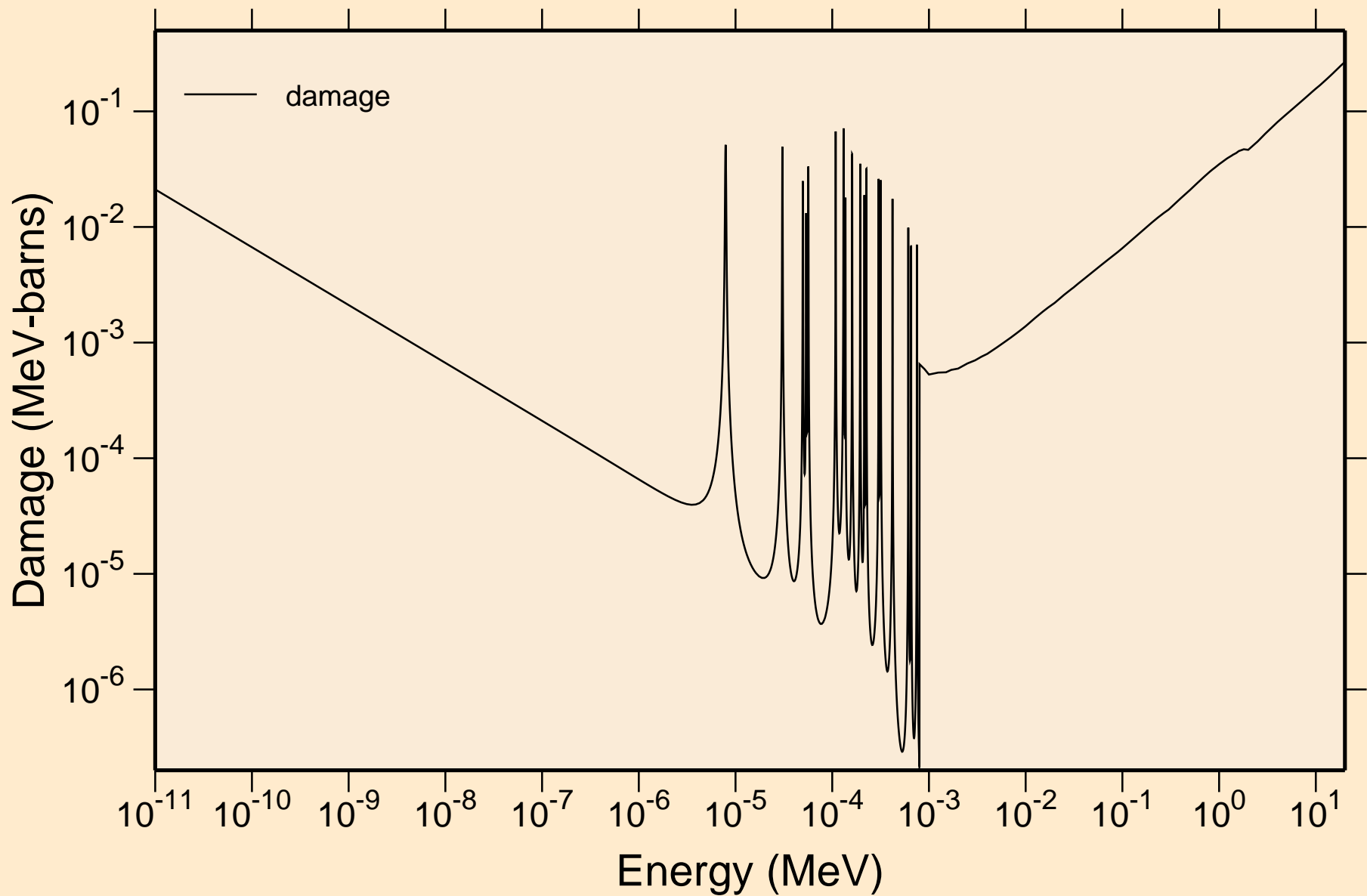

MAT=6831 ACE FILE PRODUCED AT NEA WITH NDEC  
Non-threshold reactions

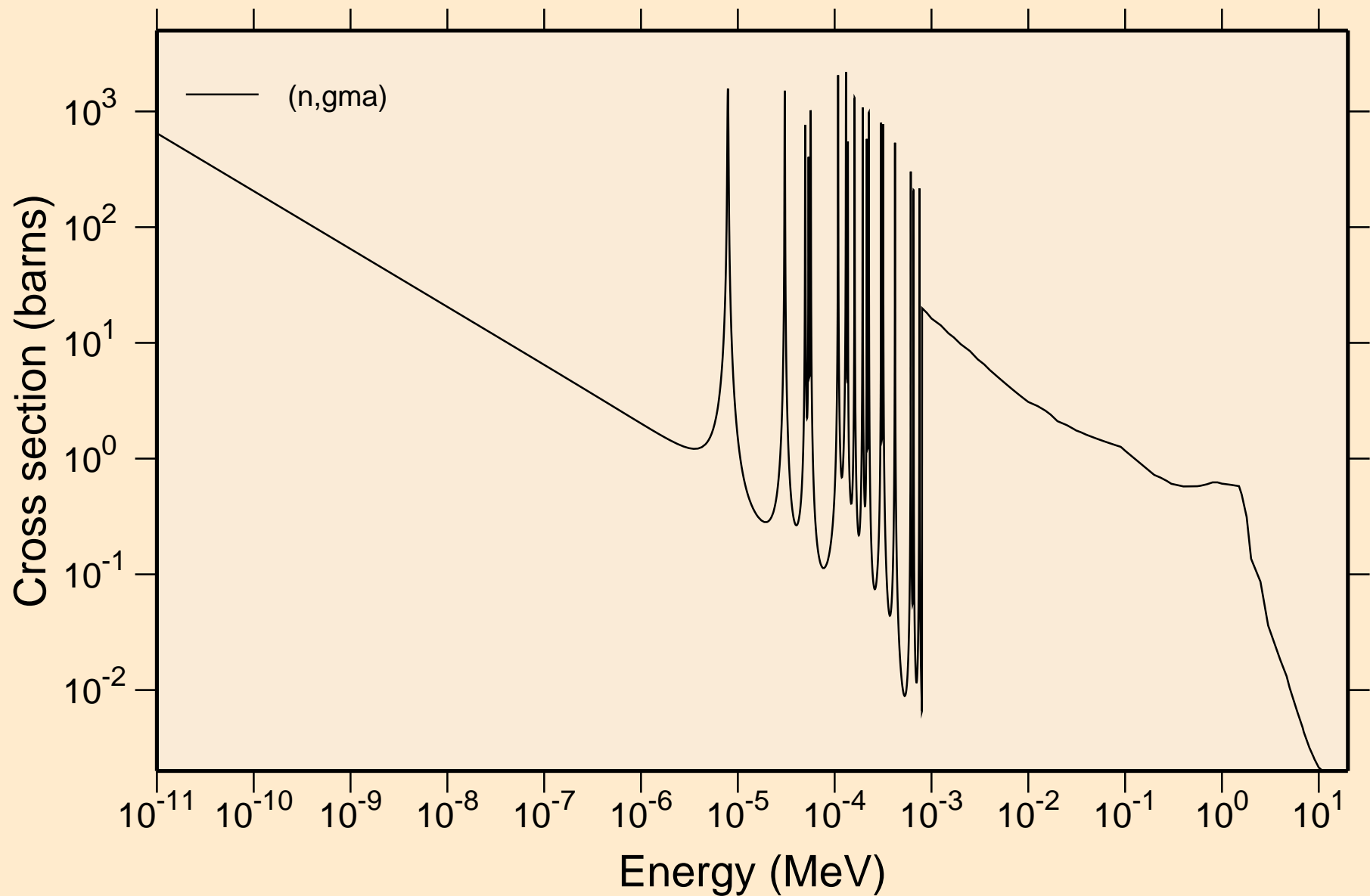

# MAT=6831 ACE FILE PRODUCED AT NEA WITH NDEC

## Principal cross sections

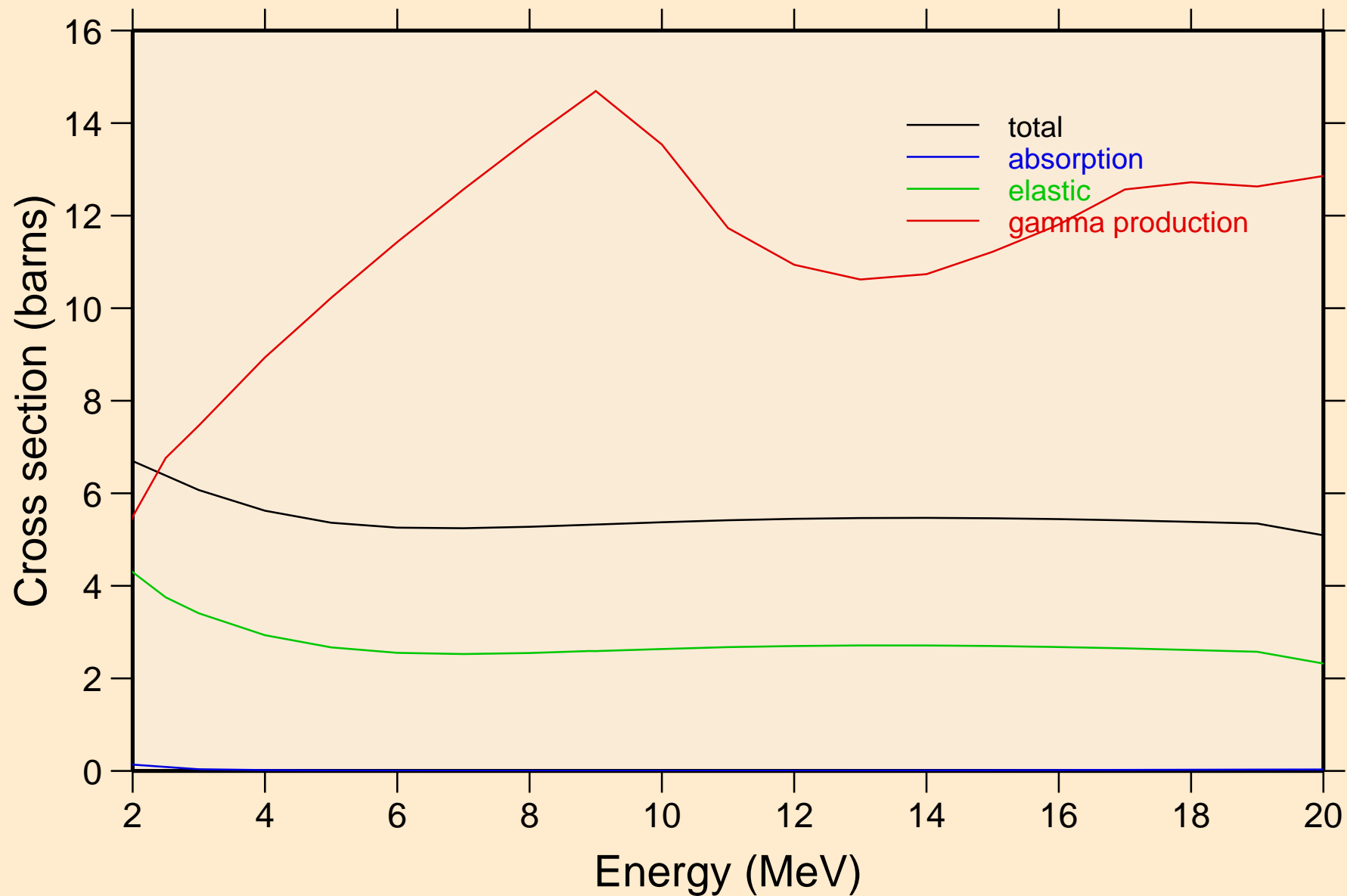

MAT=6831 ACE FILE PRODUCED AT NEA WITH NDEC  
Heating

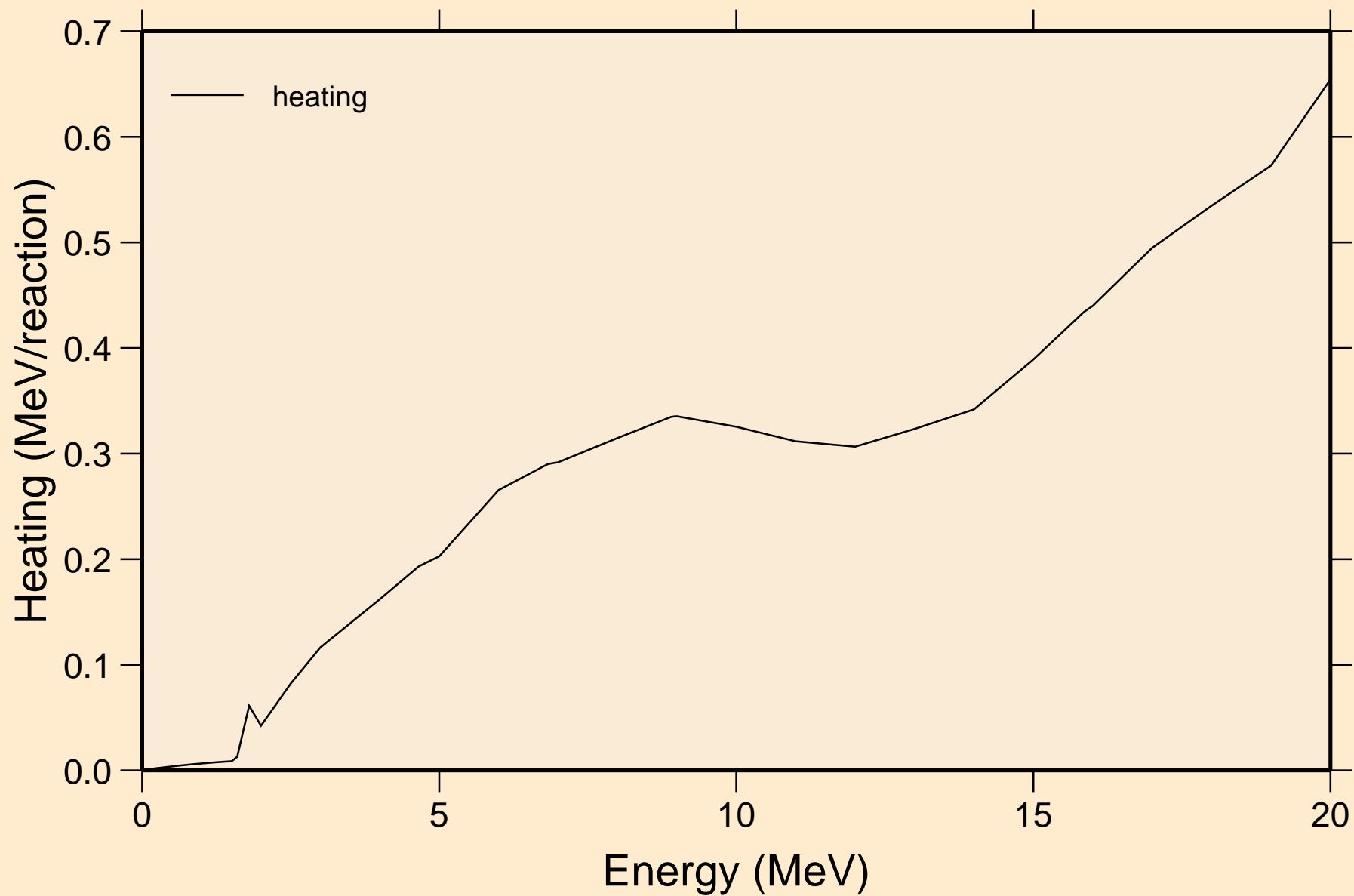

MAT=6831 ACE FILE PRODUCED AT NEA WITH NDEC  
Damage

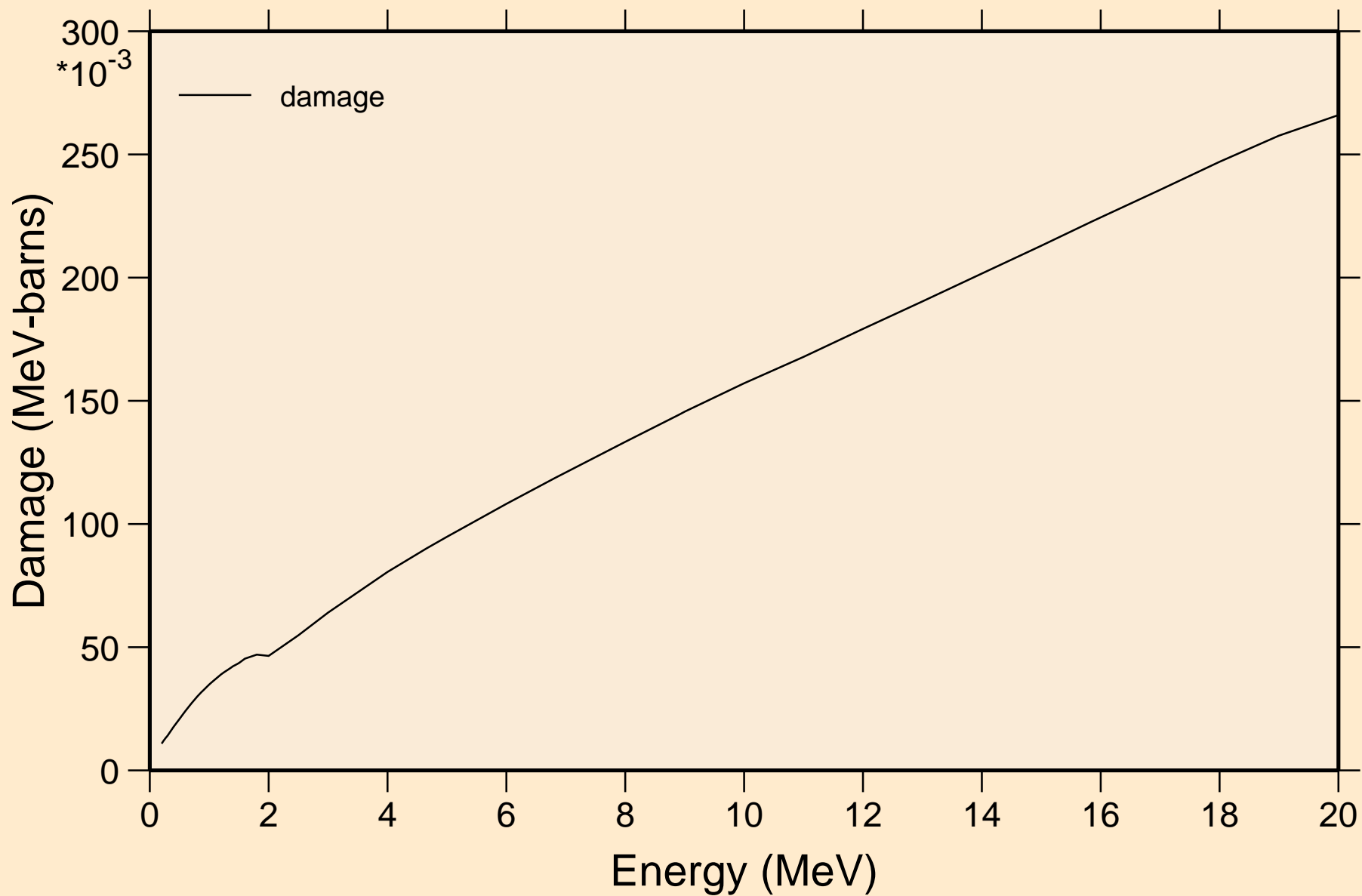

MAT=6831 ACE FILE PRODUCED AT NEA WITH NDEC  
Non-threshold reactions

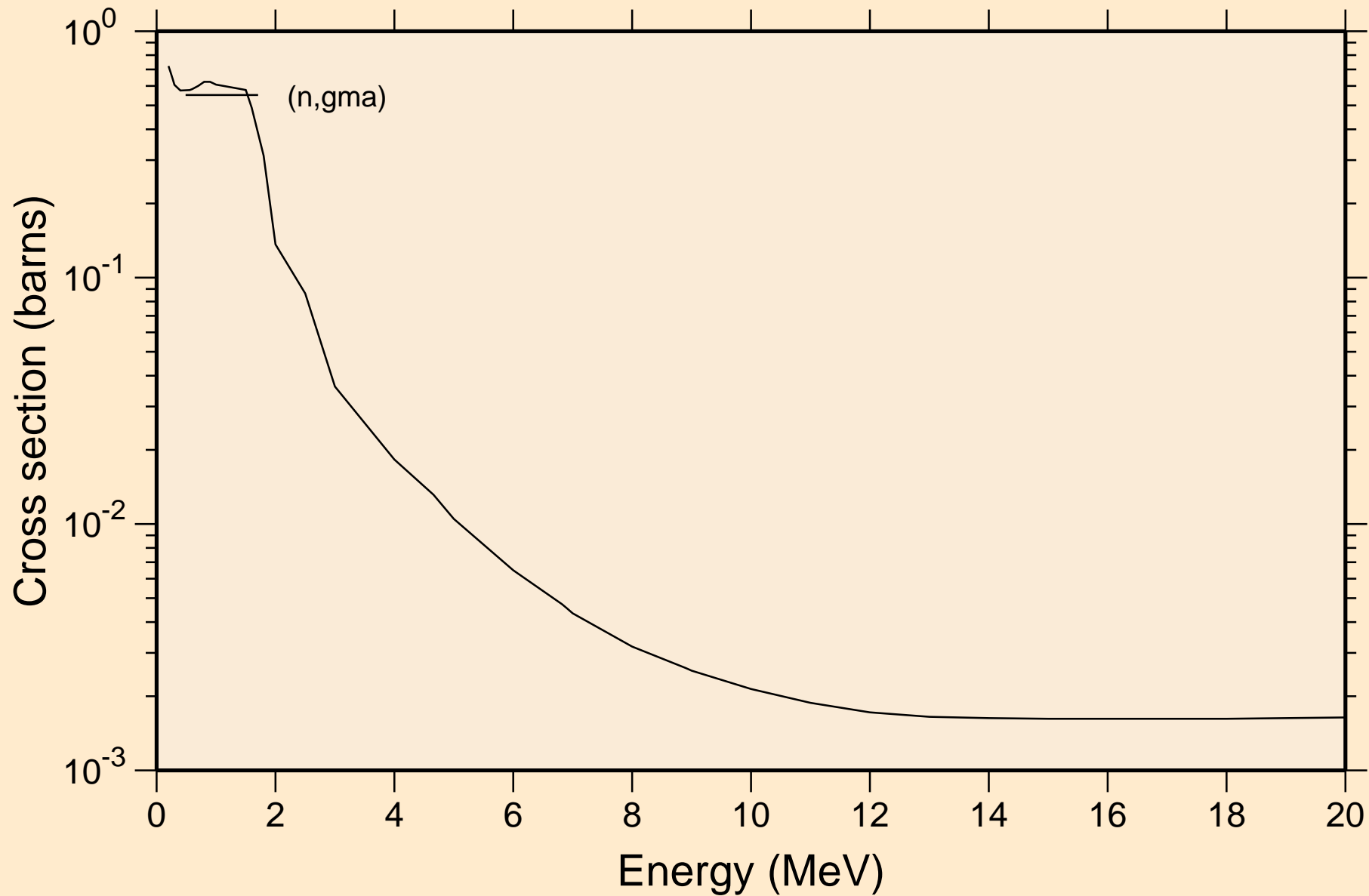

MAT=6831 ACE FILE PRODUCED AT NEA WITH NDEC  
Inelastic levels

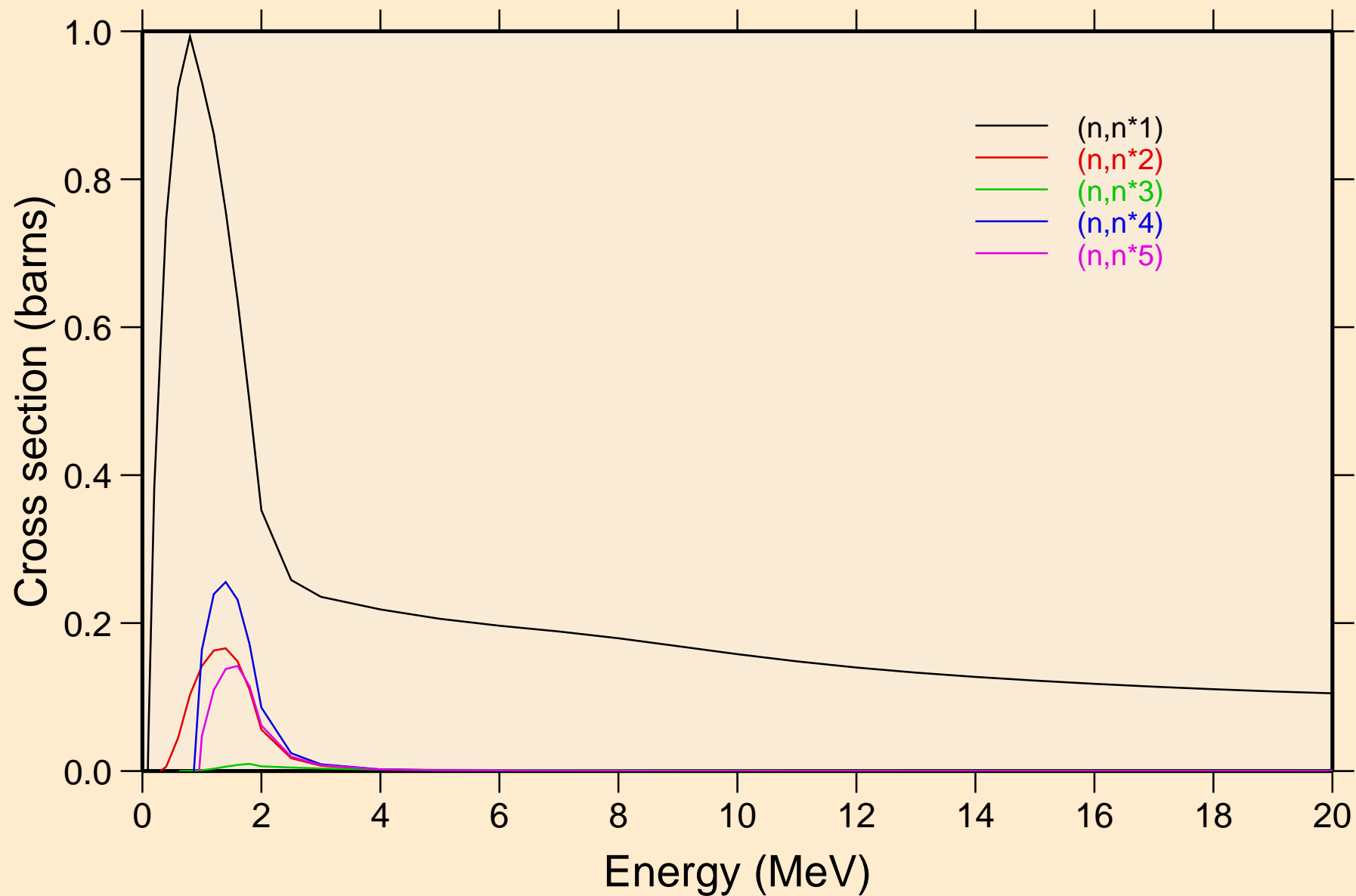

MAT=6831 ACE FILE PRODUCED AT NEA WITH NDEC  
Inelastic levels

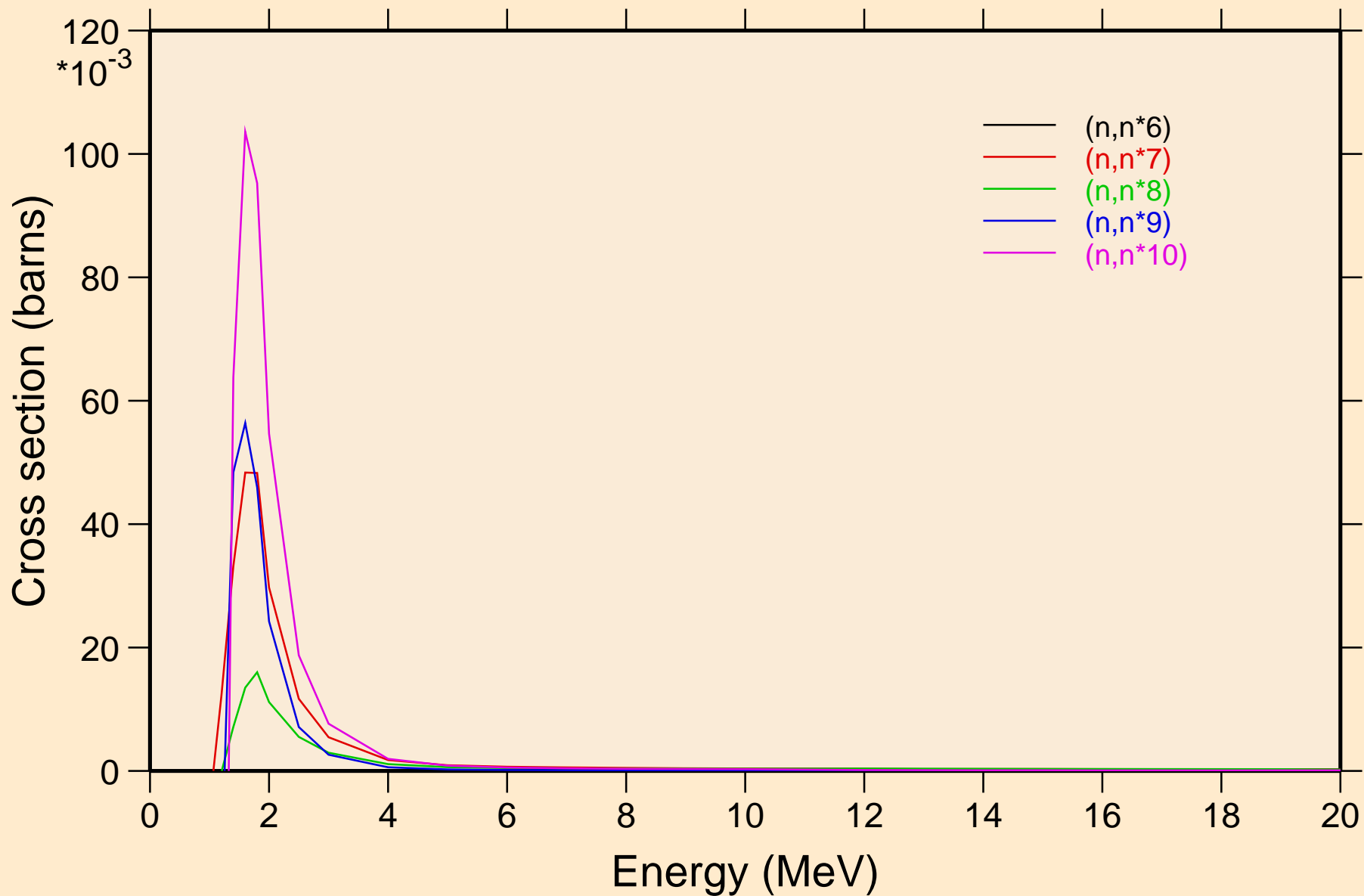

MAT=6831 ACE FILE PRODUCED AT NEA WITH NDEC  
Inelastic levels

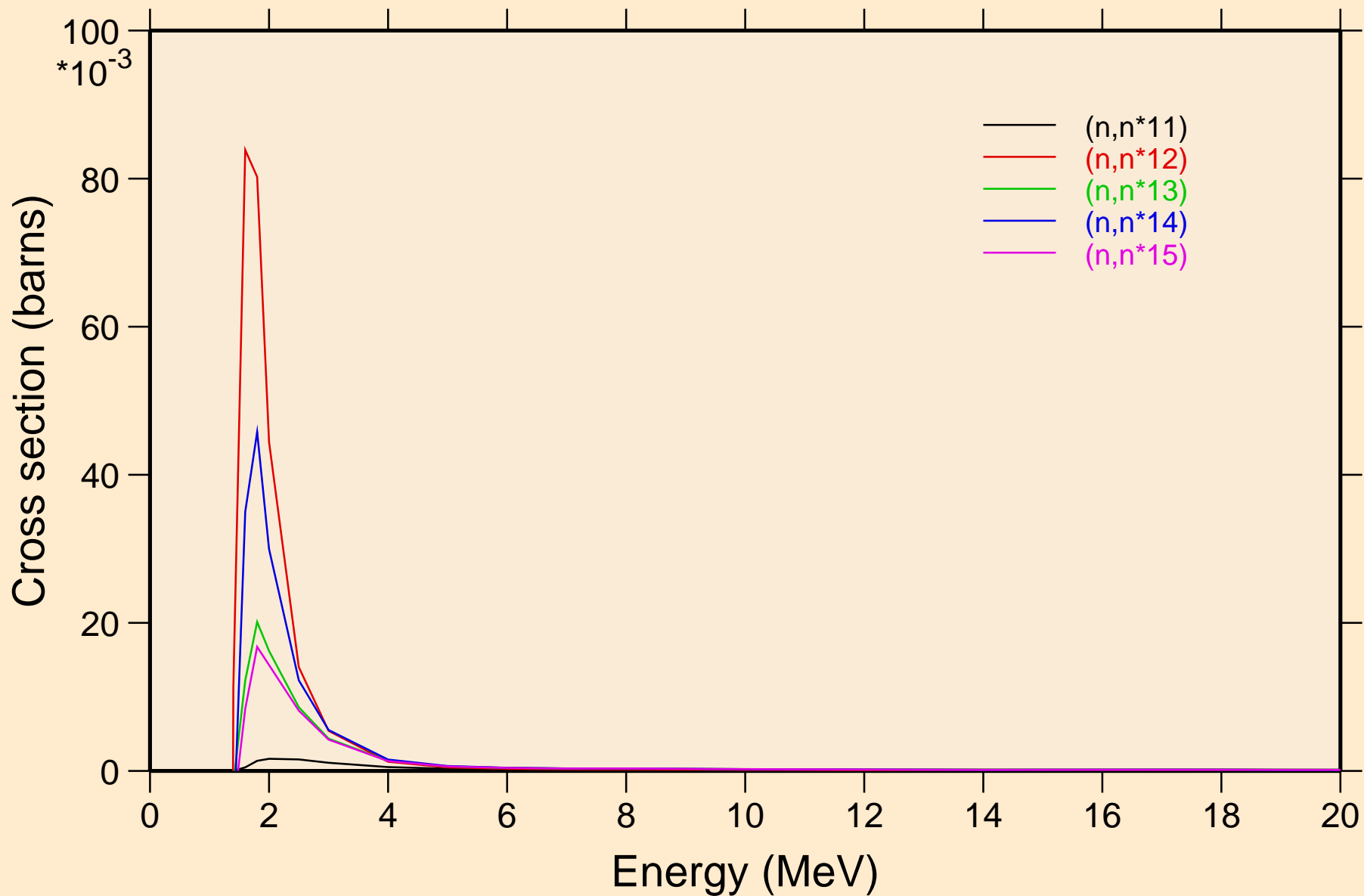

MAT=6831 ACE FILE PRODUCED AT NEA WITH NDEC  
Inelastic levels

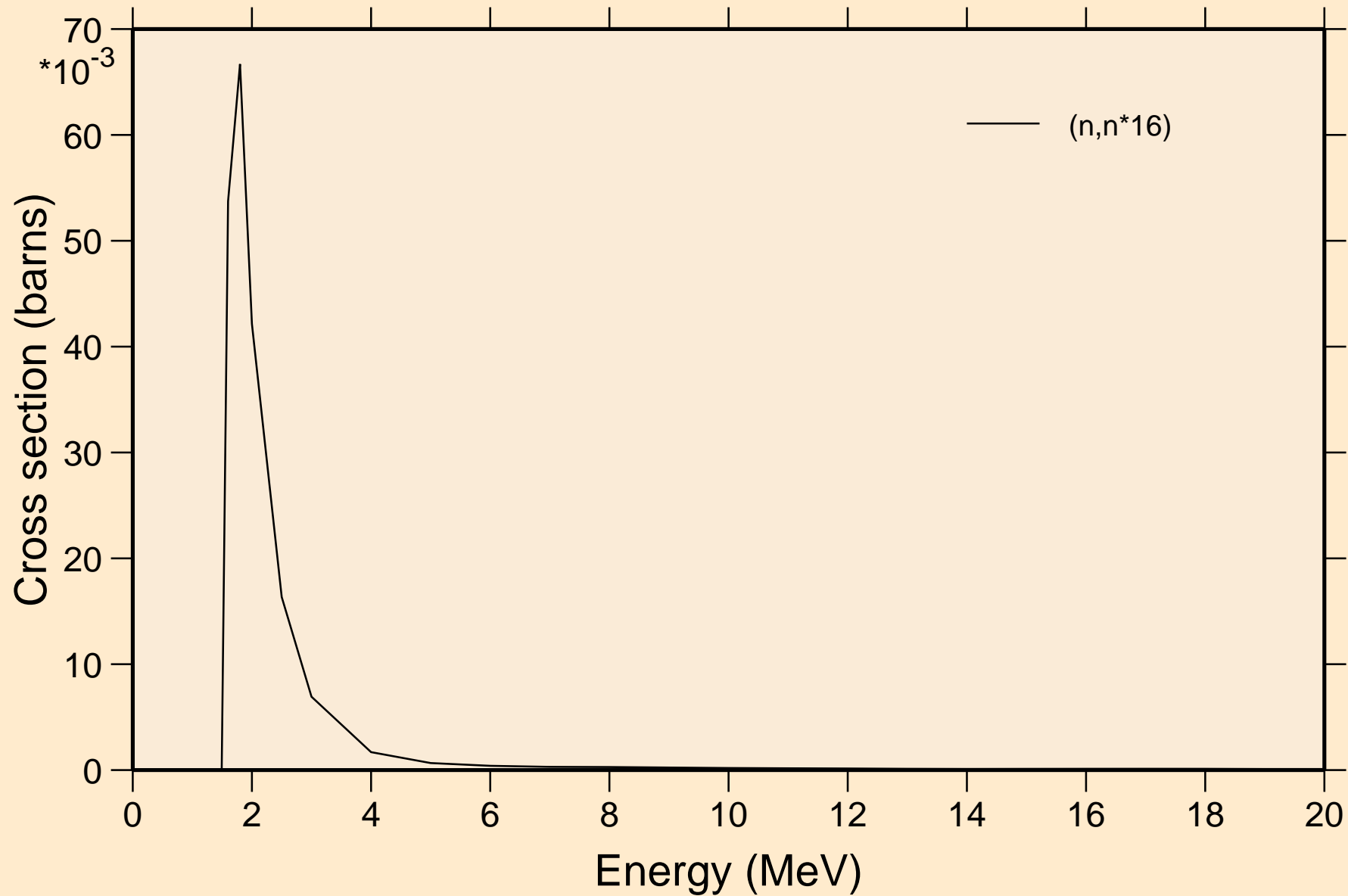

MAT=6831 ACE FILE PRODUCED AT NEA WITH NDEC  
Threshold reactions

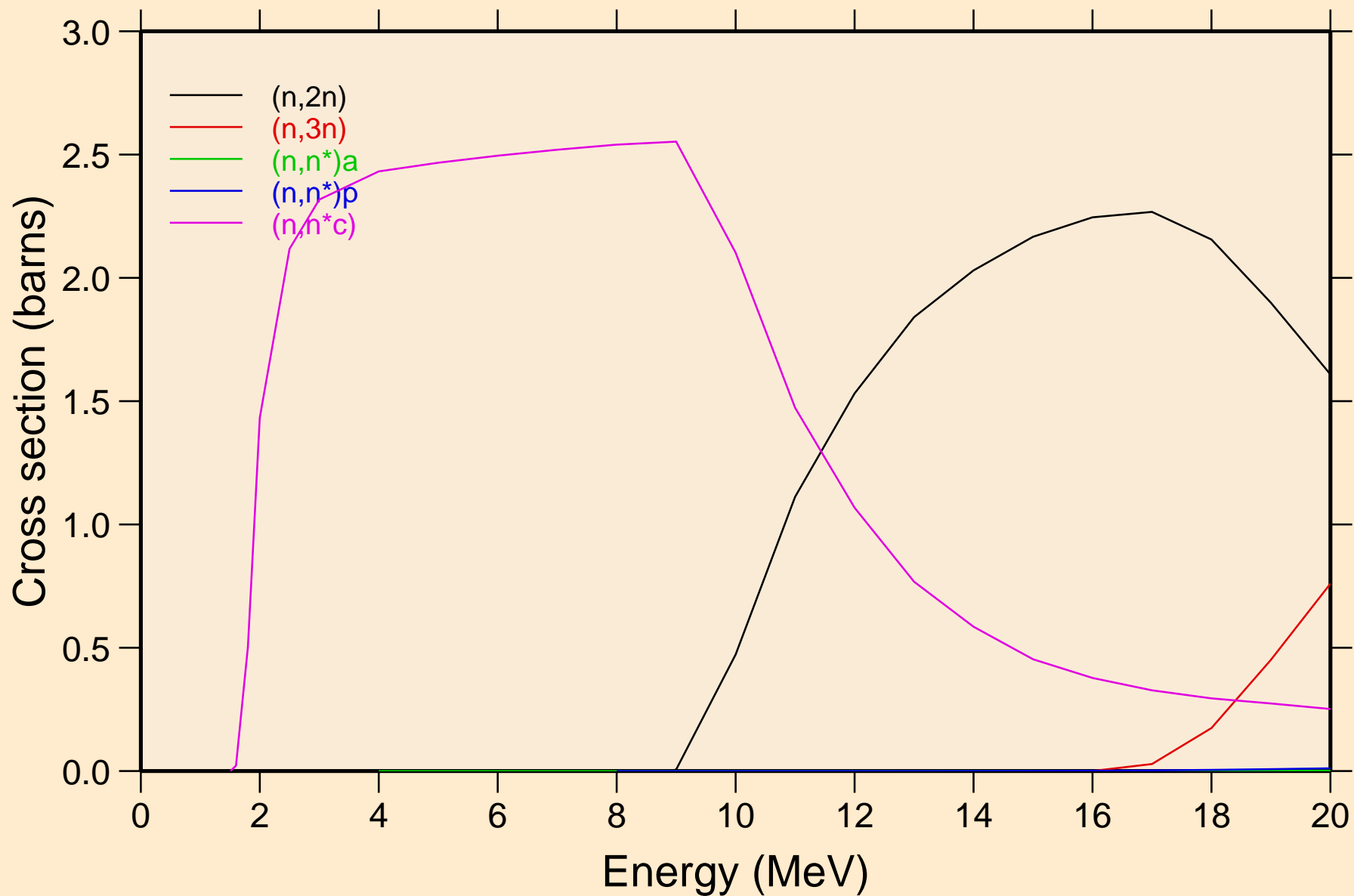

MAT=6831 ACE FILE PRODUCED AT NEA WITH NDEC  
Threshold reactions

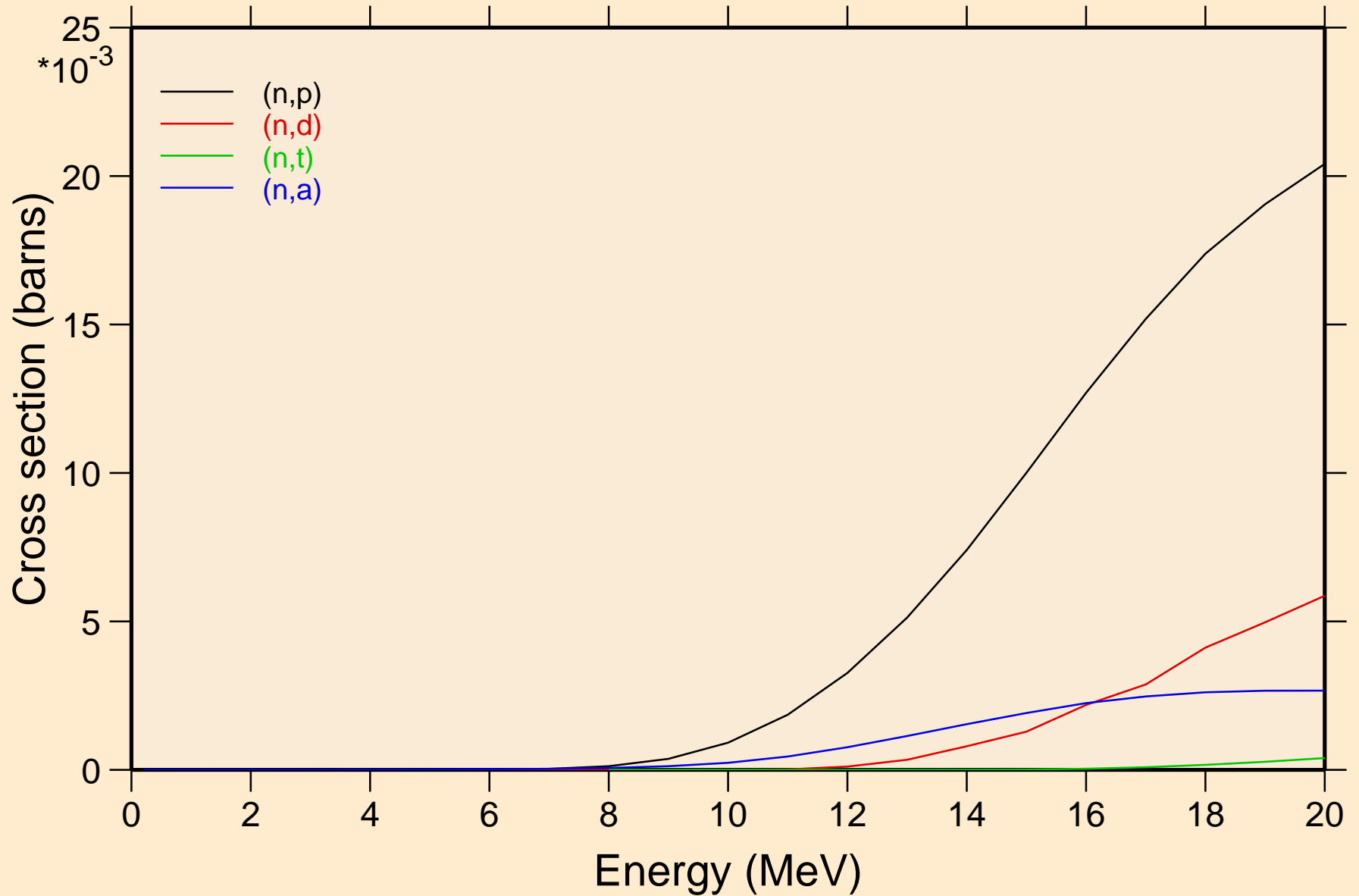

MAT=6831 ACE FILE PRODUCED AT NEA WITH NDEC  
Threshold reactions

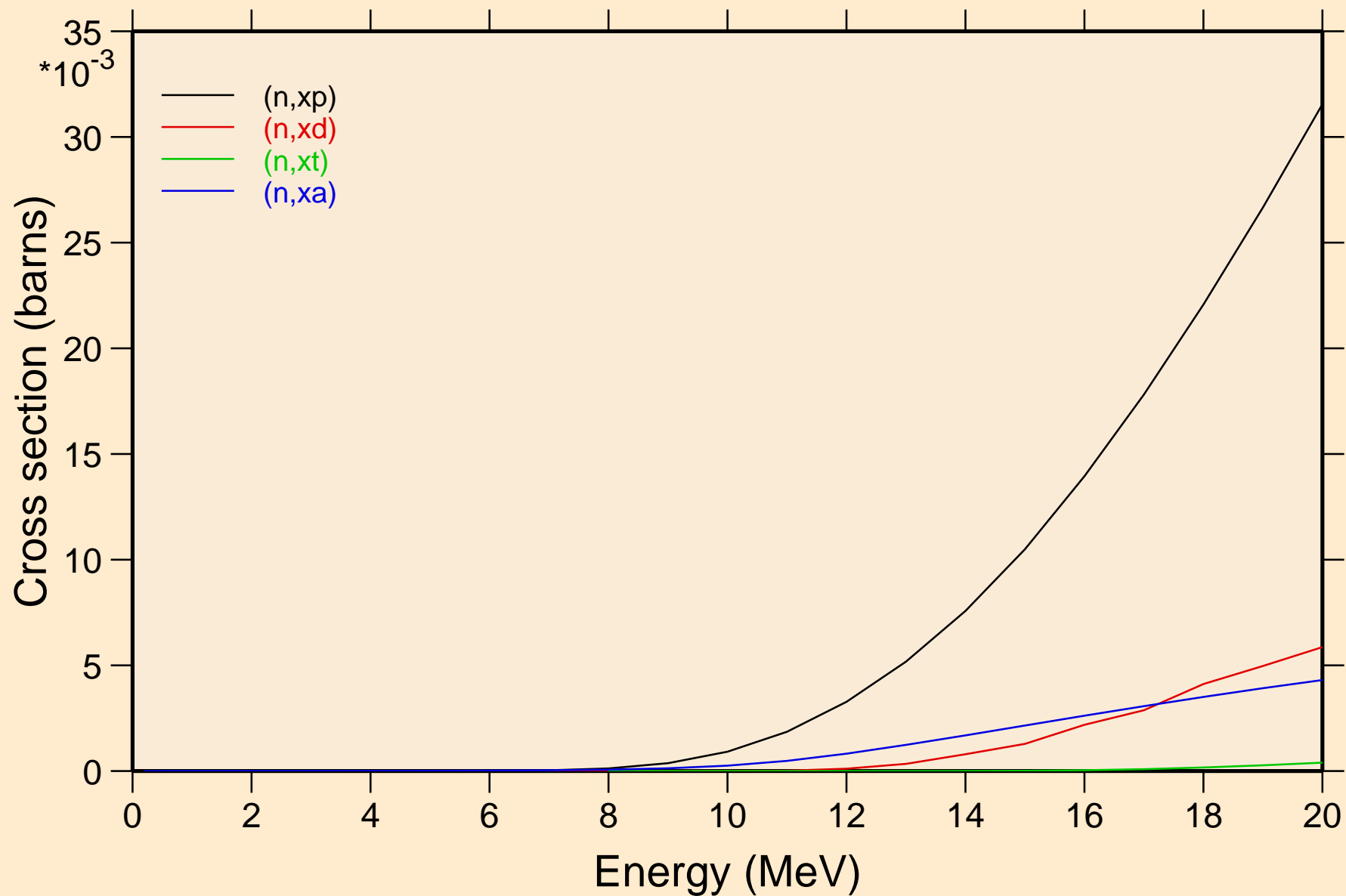

MAT=6831 ACE FILE PRODUCED AT NEA WITH NDEC  
angular distribution for elastic

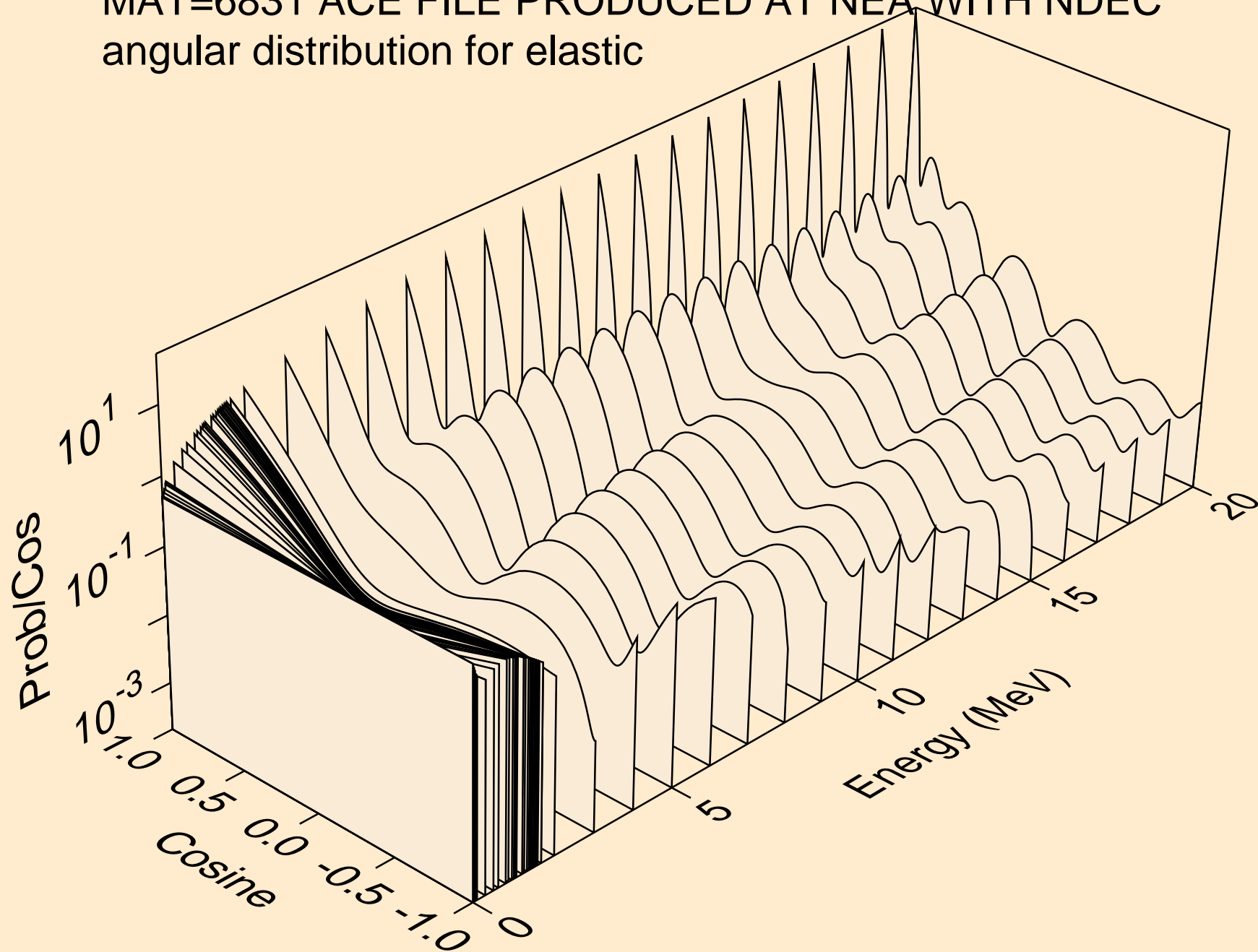

MAT=6831 ACE FILE PRODUCED AT NEA WITH NDEC  
angular distribution for (n,n\*1)

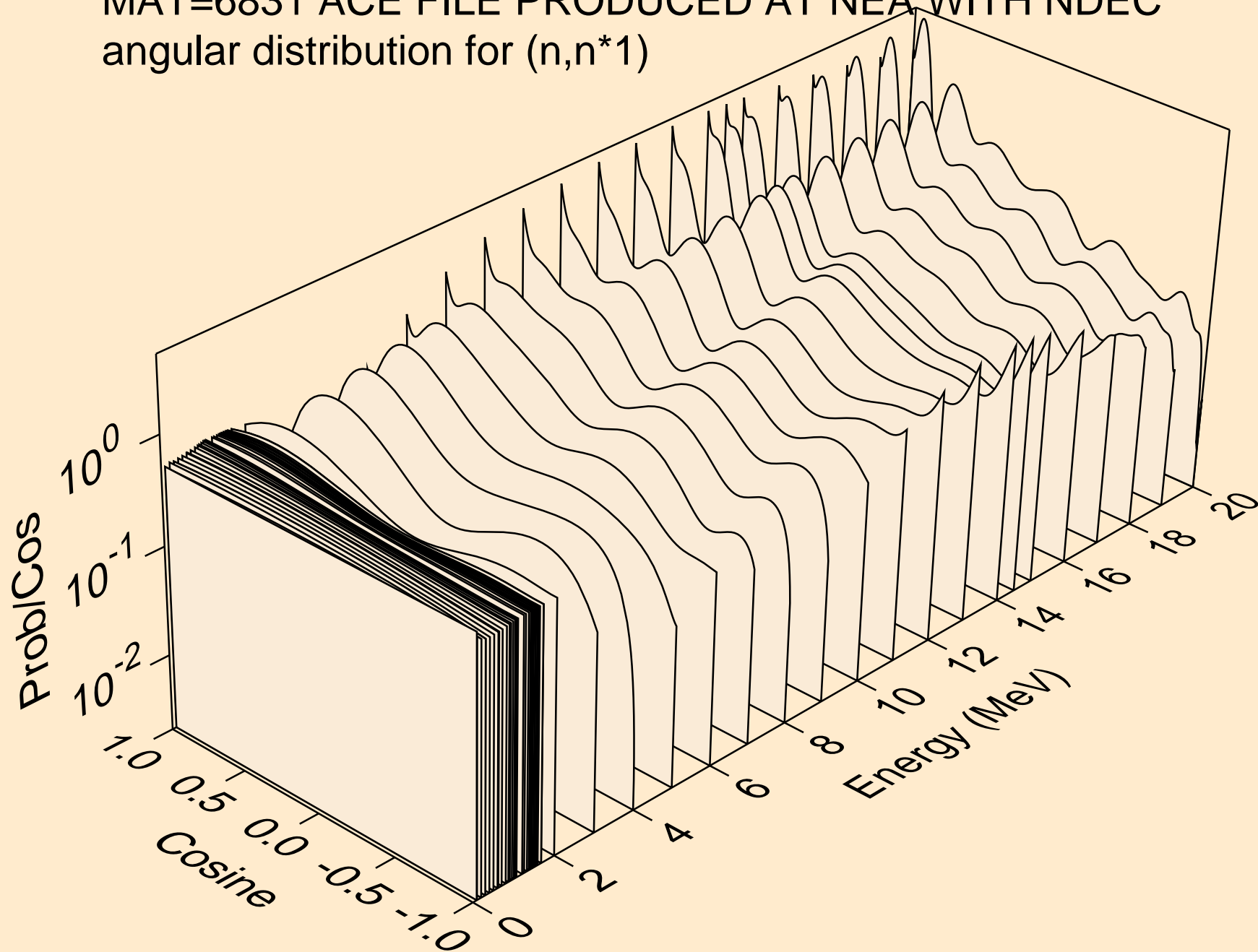

MAT=6831 ACE FILE PRODUCED AT NEA WITH NDEC  
angular distribution for (n,n\*2)

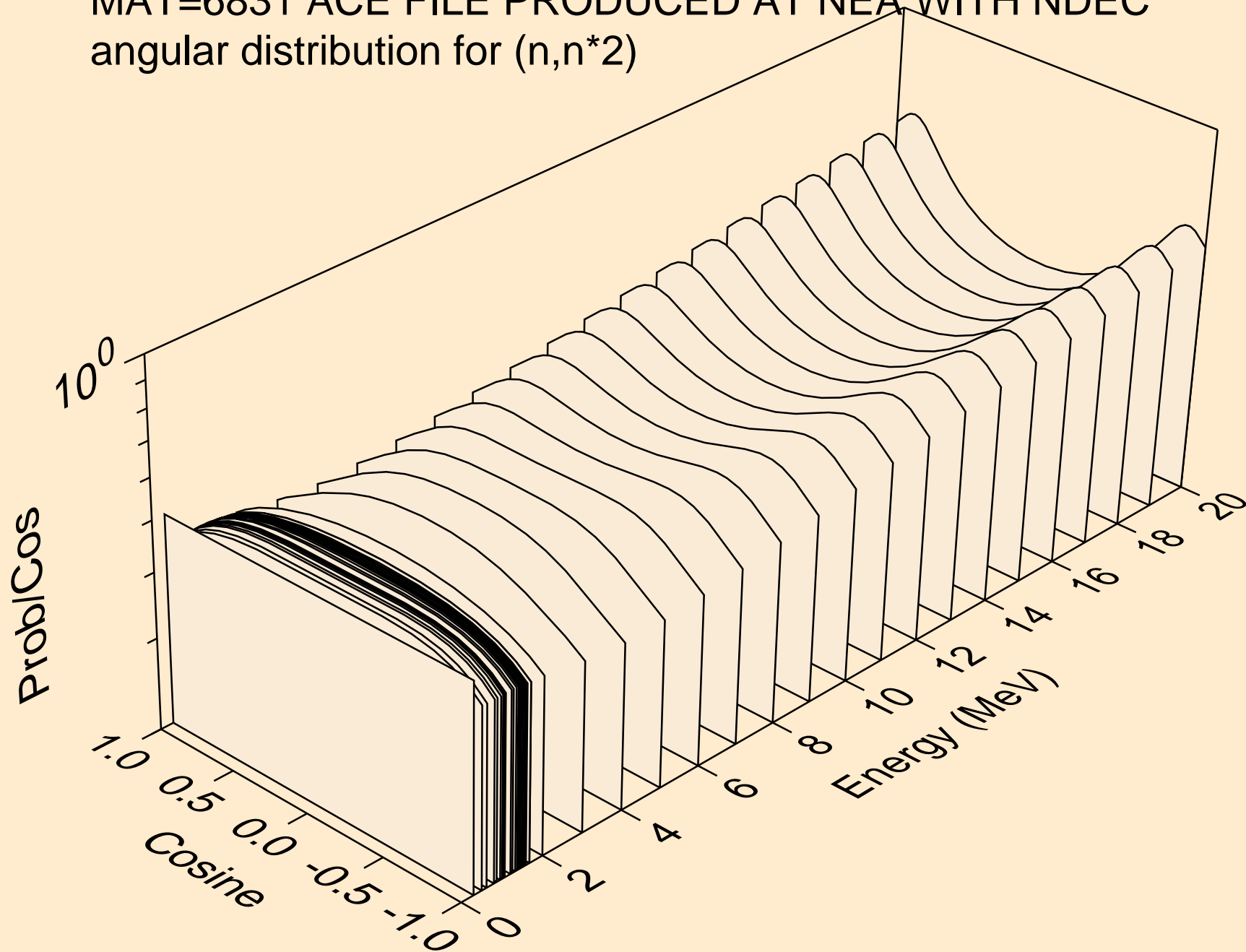

MAT=6831 ACE FILE PRODUCED AT NEA WITH NDEC  
angular distribution for (n,n\*3)

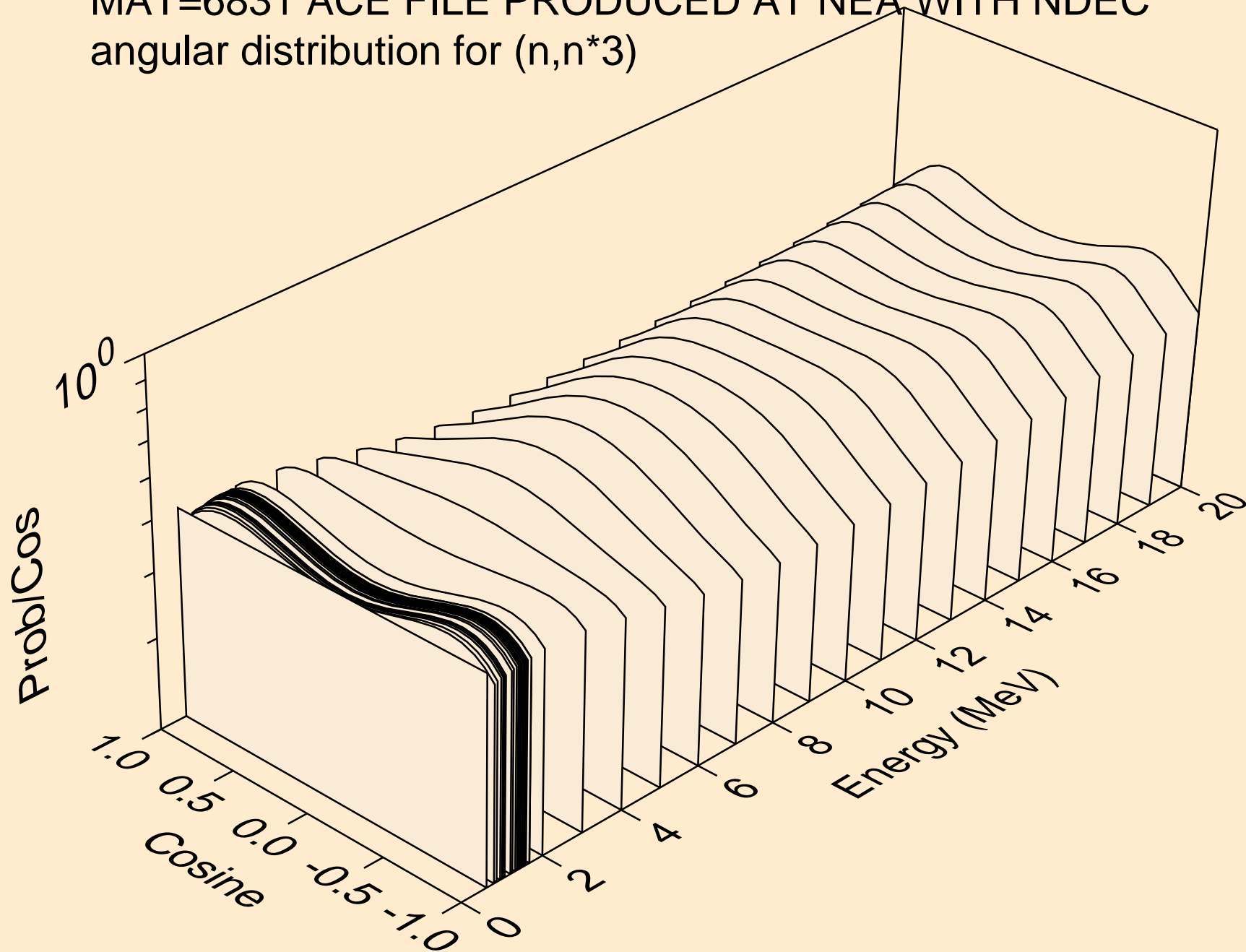

MAT=6831 ACE FILE PRODUCED AT NEA WITH NDEC  
angular distribution for (n,n\*4)

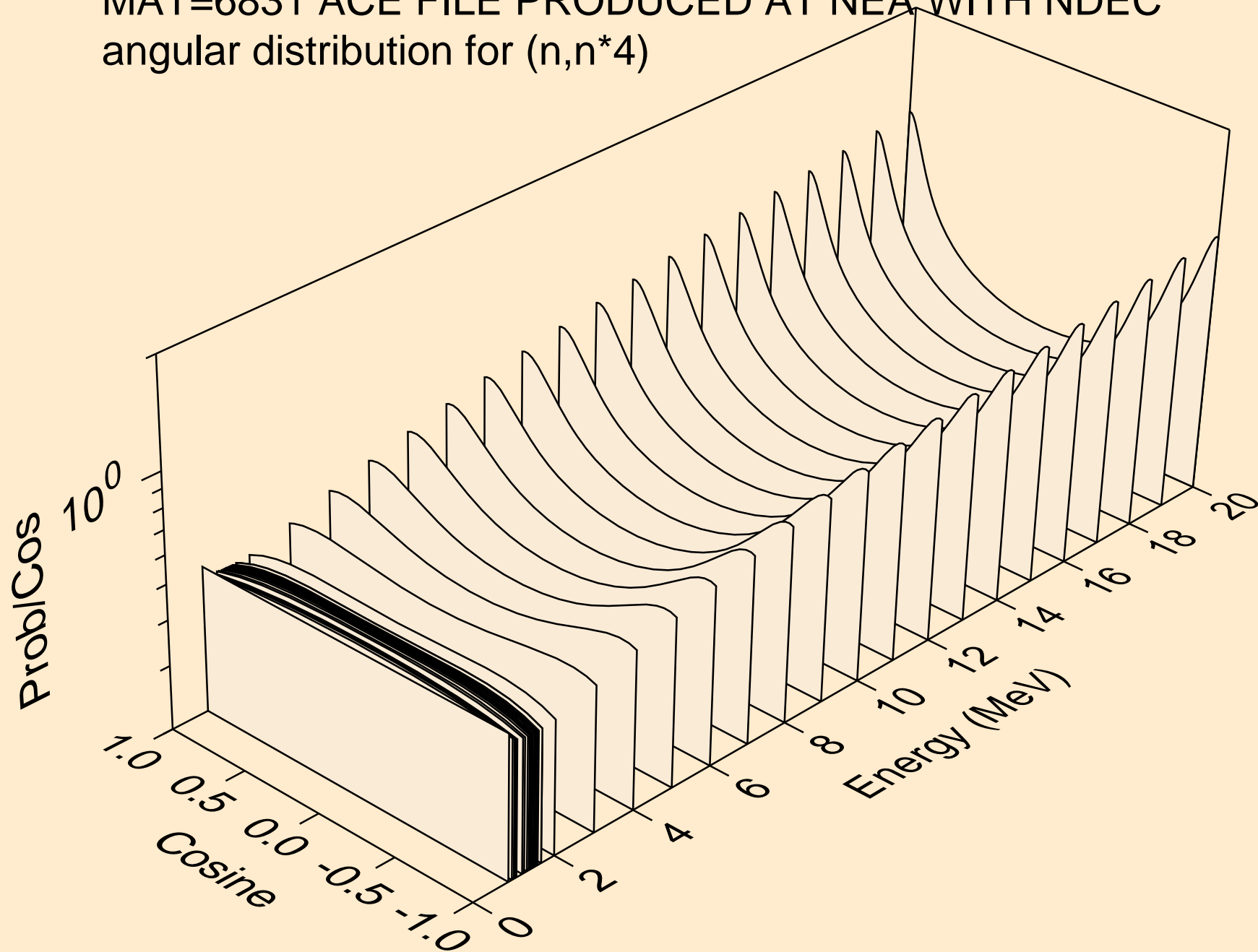

MAT=6831 ACE FILE PRODUCED AT NEA WITH NDEC  
angular distribution for (n,n\*5)

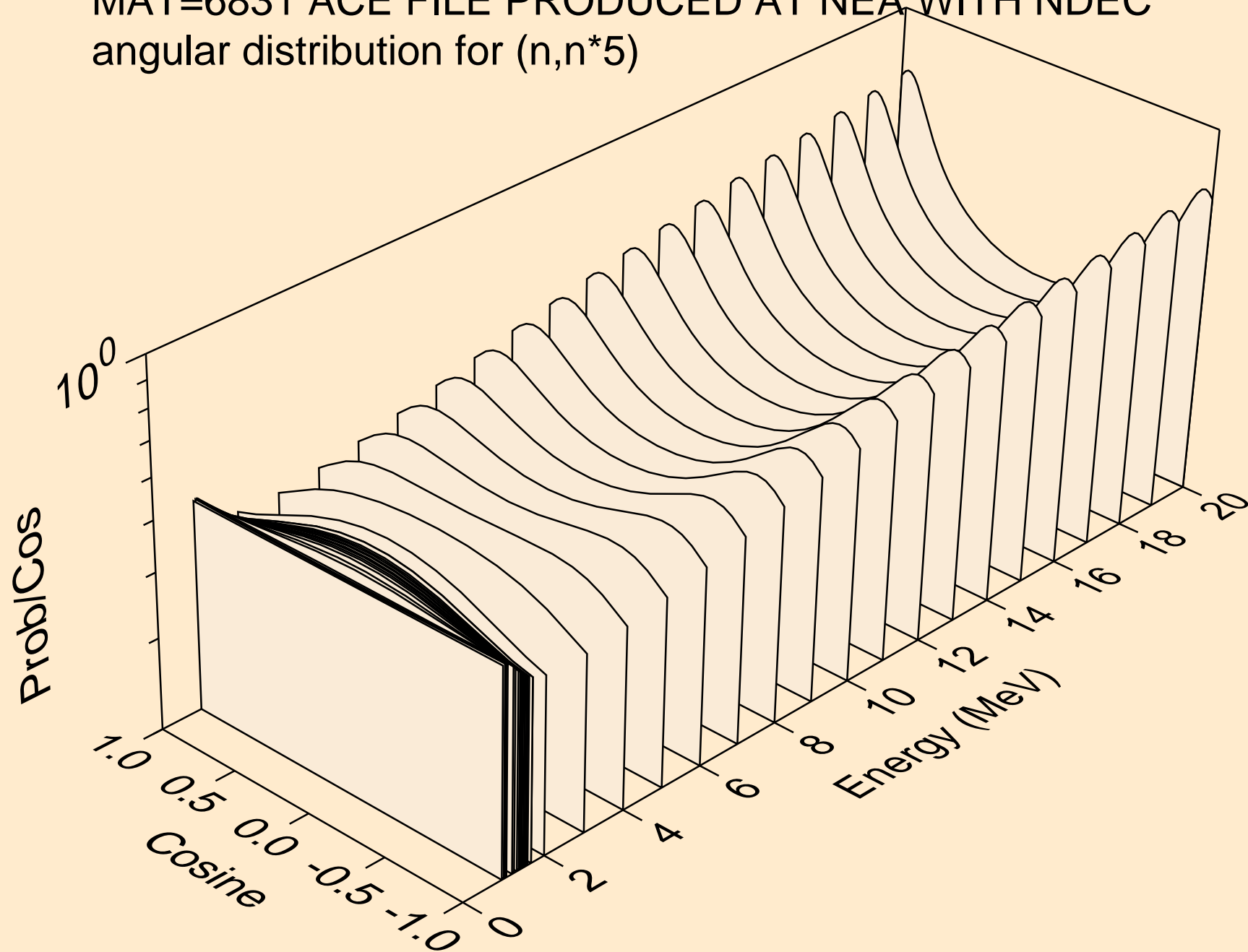

MAT=6831 ACE FILE PRODUCED AT NEA WITH NDEC  
angular distribution for (n,n\*6)

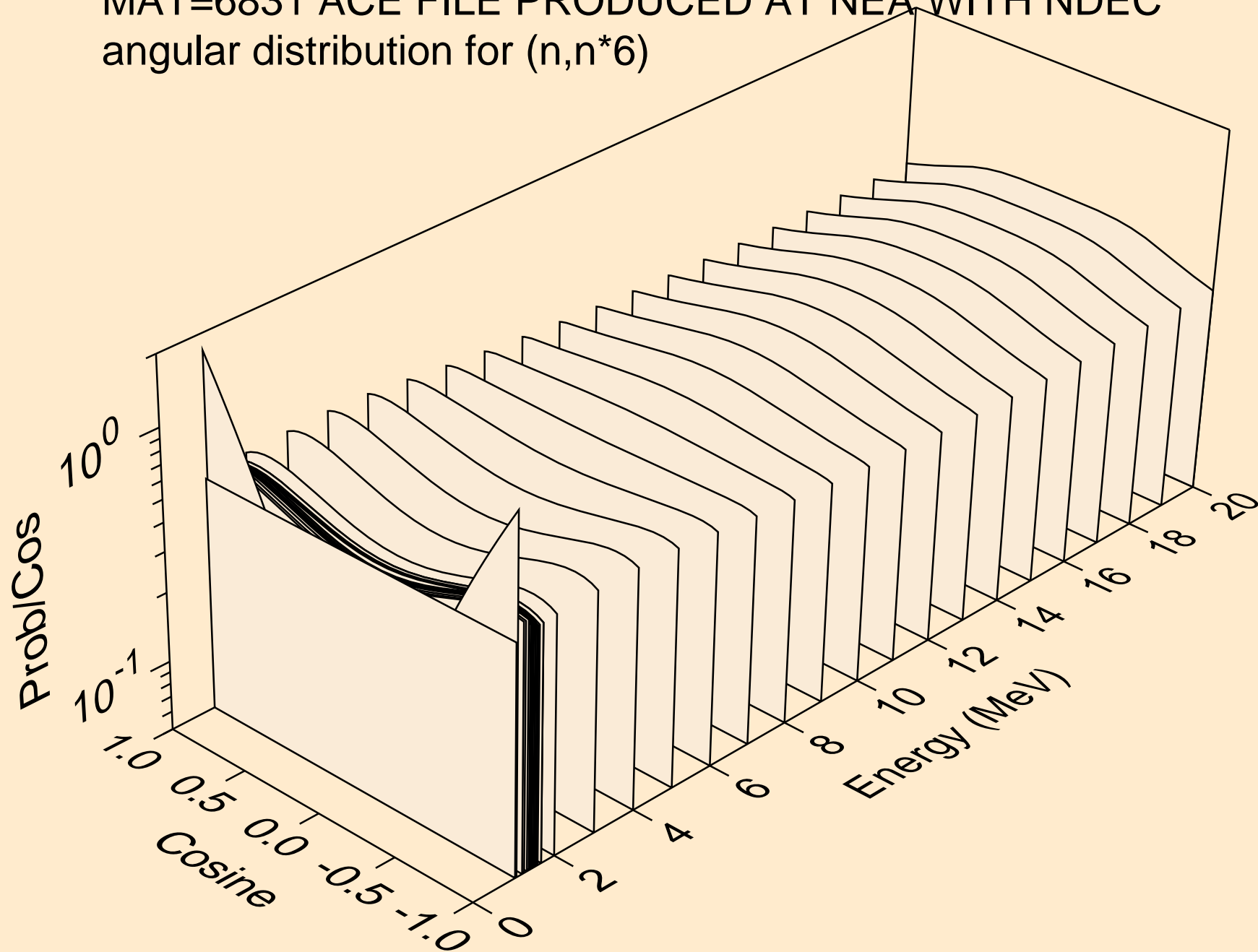

MAT=6831 ACE FILE PRODUCED AT NEA WITH NDEC  
angular distribution for (n,n\*7)

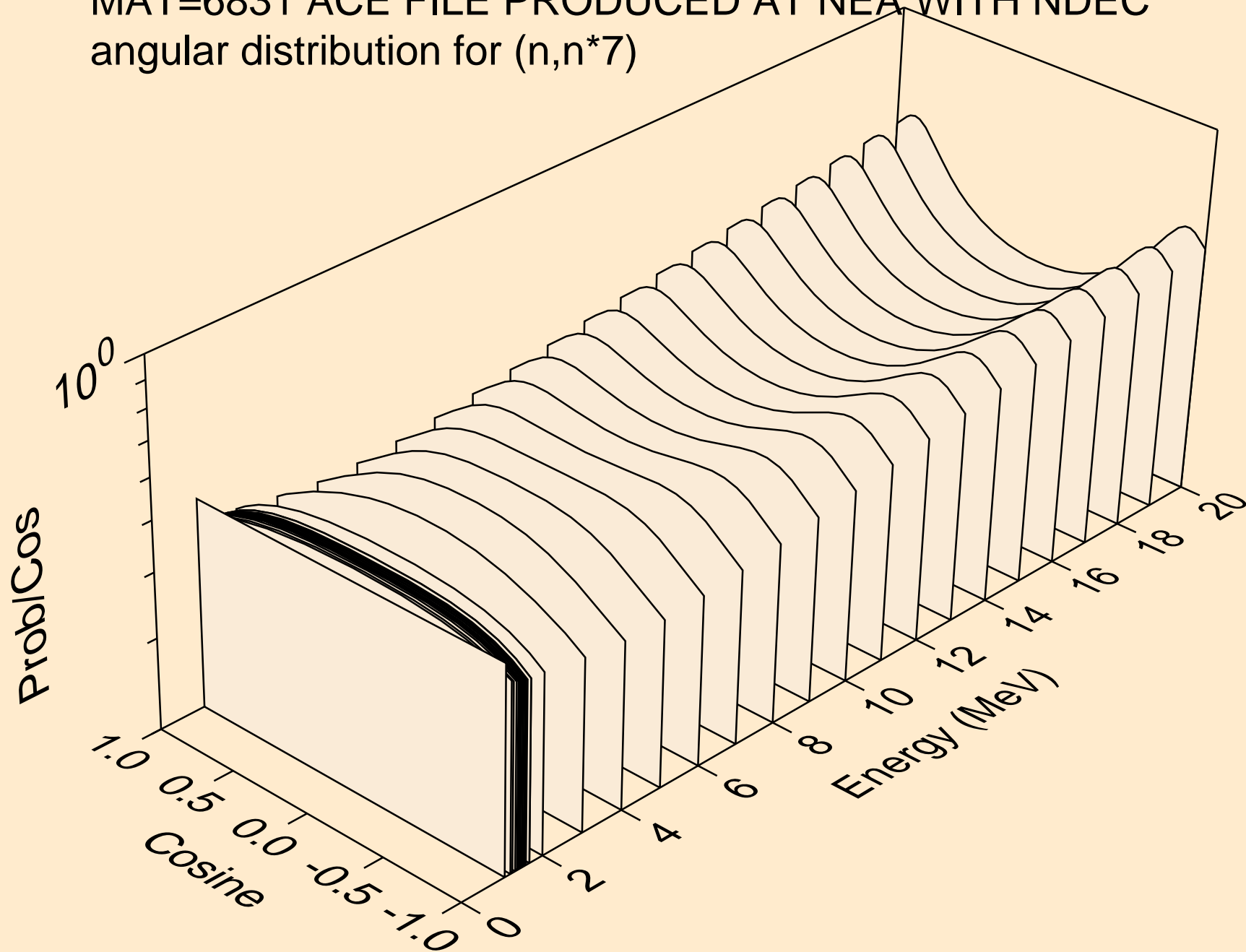

MAT=6831 ACE FILE PRODUCED AT NEA WITH NDEC  
angular distribution for (n,n\*8)

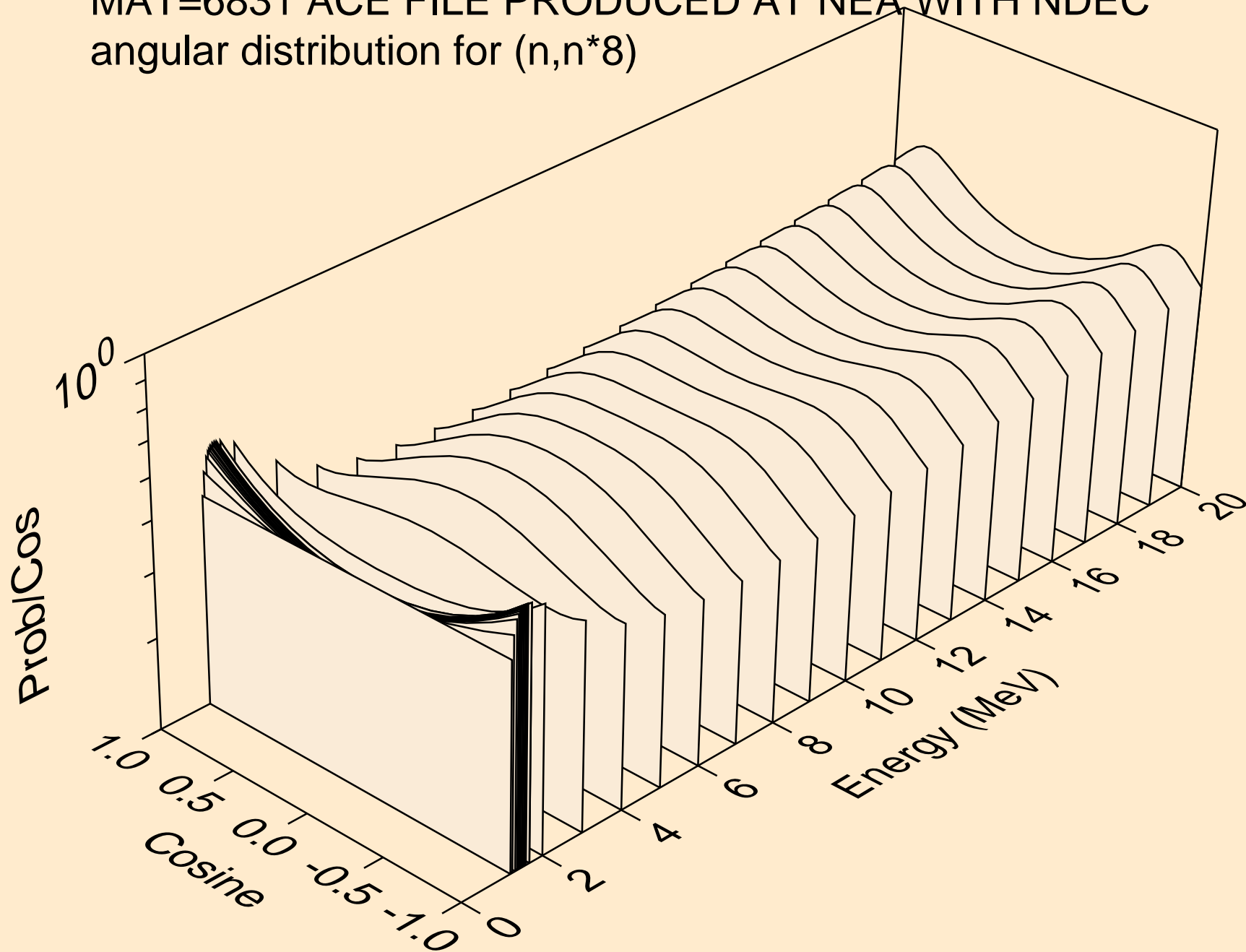

MAT=6831 ACE FILE PRODUCED AT NEA WITH NDEC  
angular distribution for (n,n\*9)

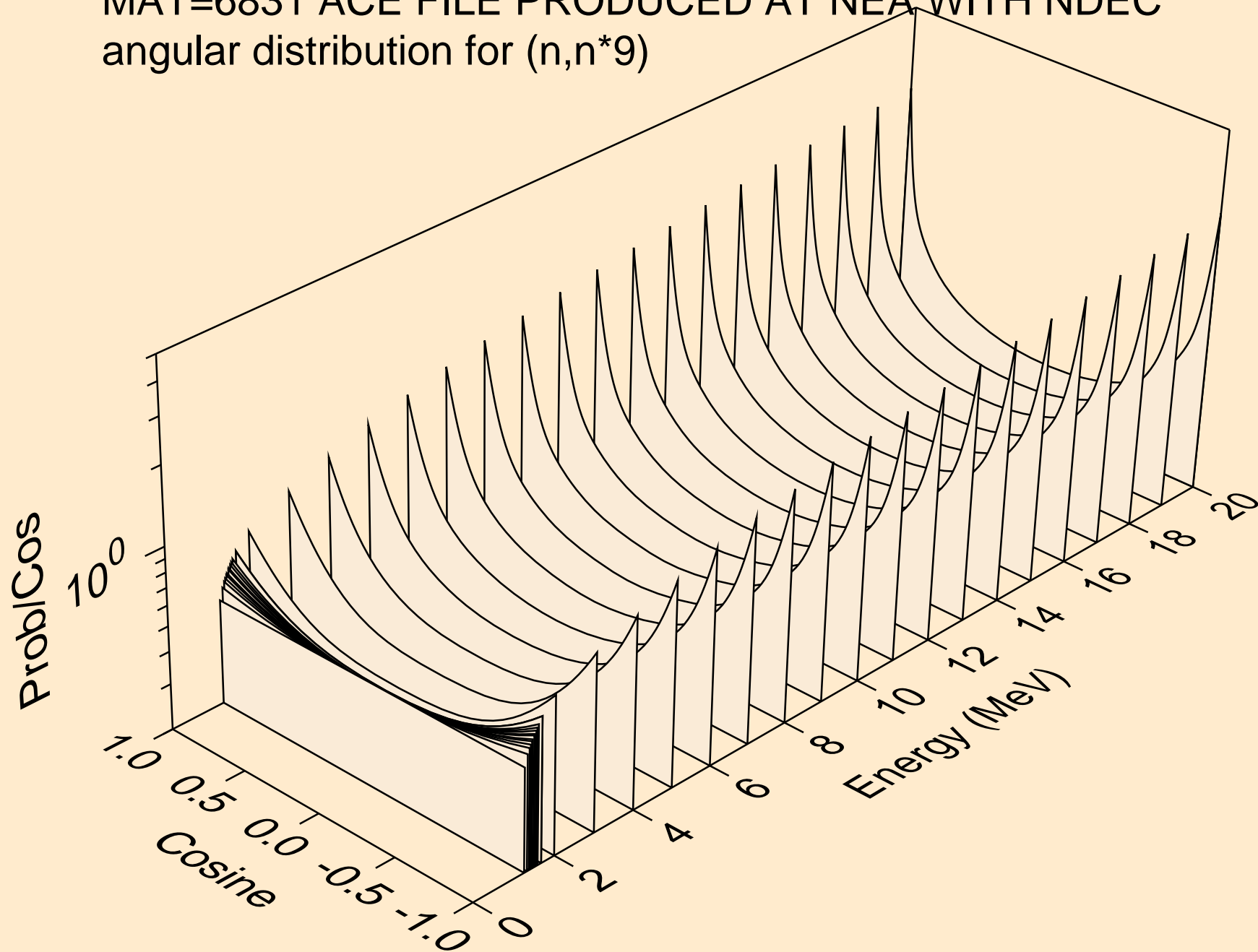

MAT=6831 ACE FILE PRODUCED AT NEA WITH NDEC  
angular distribution for (n,n\*10)

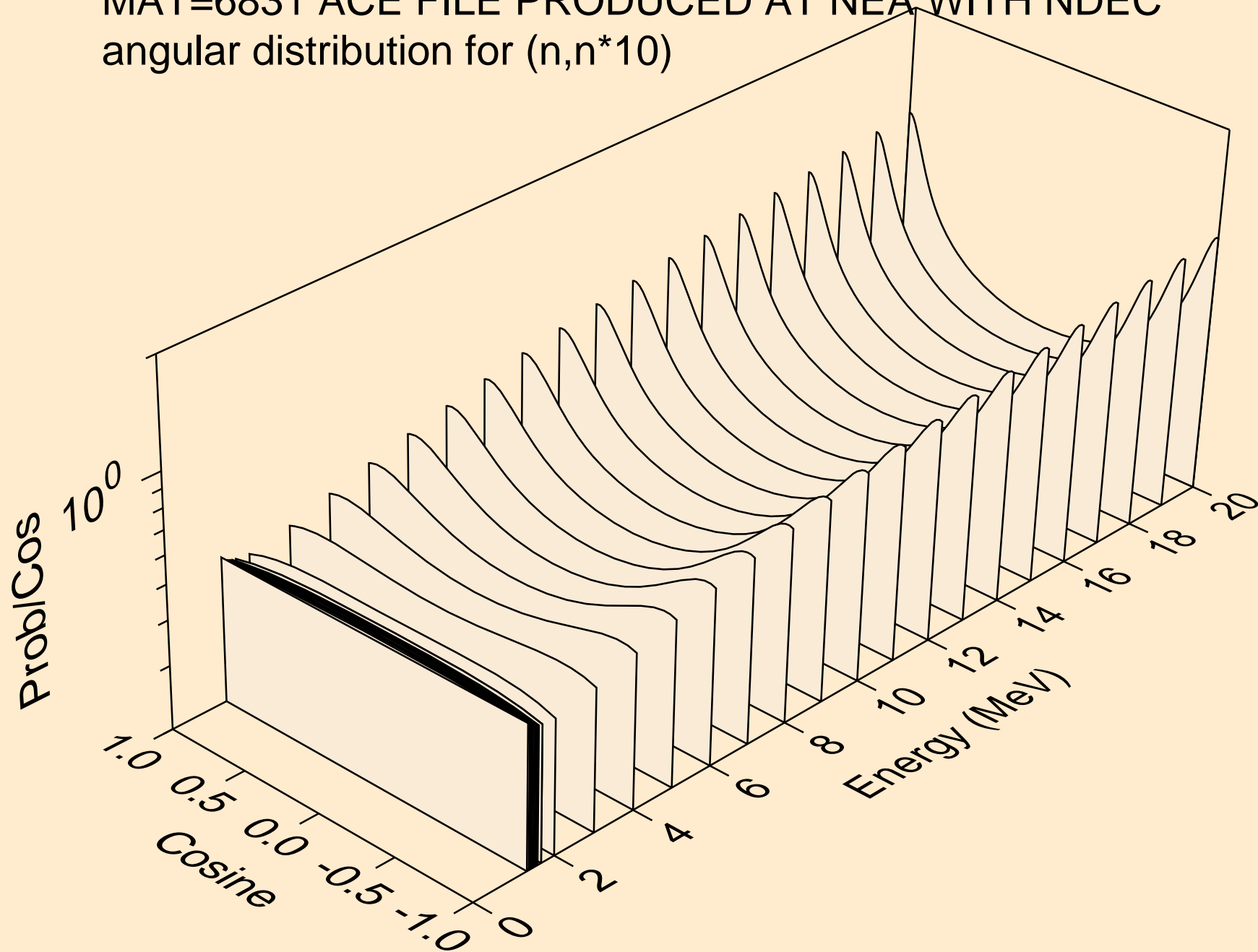

MAT=6831 ACE FILE PRODUCED AT NEA WITH NDEC  
angular distribution for (n,n\*11)

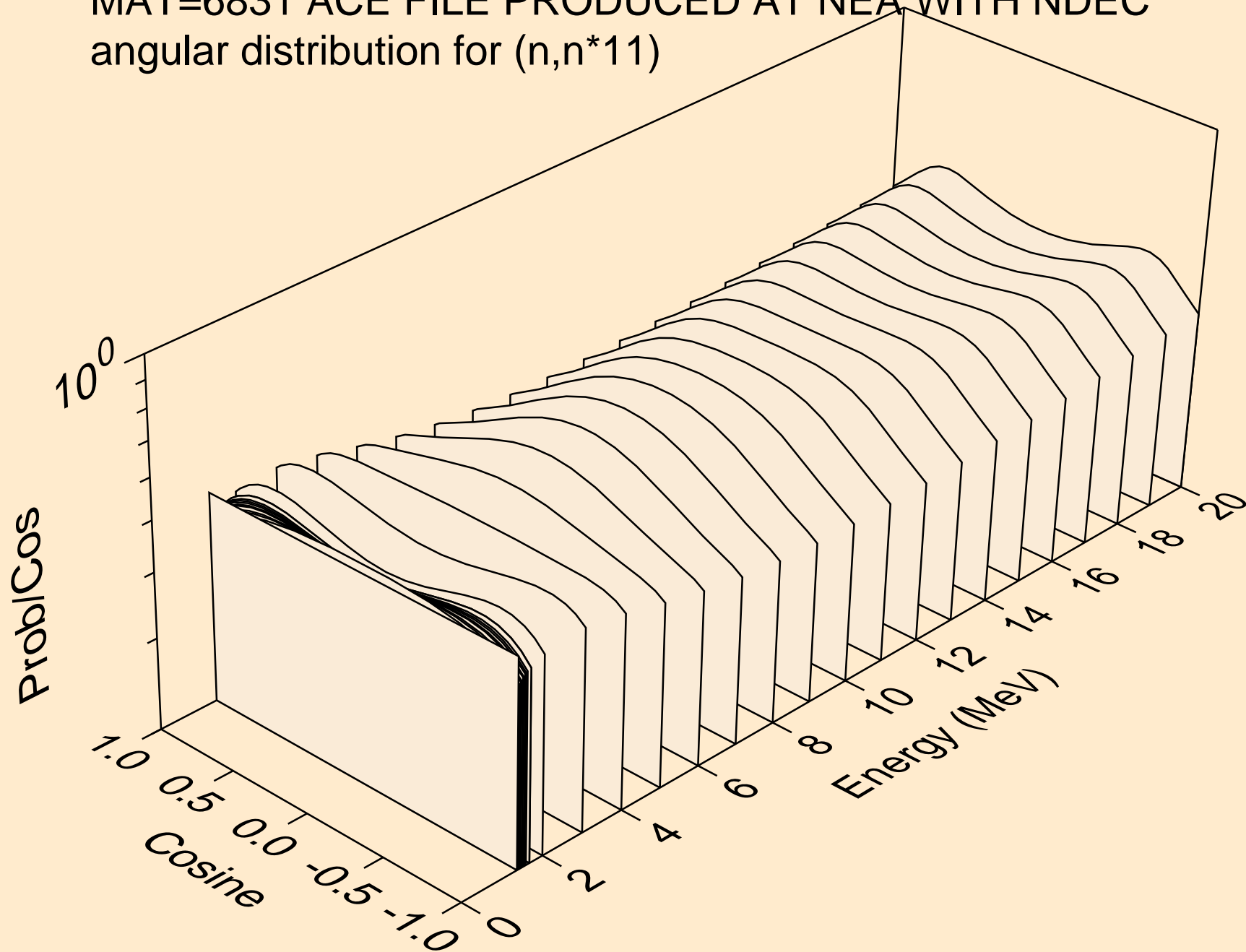

MAT=6831 ACE FILE PRODUCED AT NEA WITH NDEC  
angular distribution for (n,n\*12)

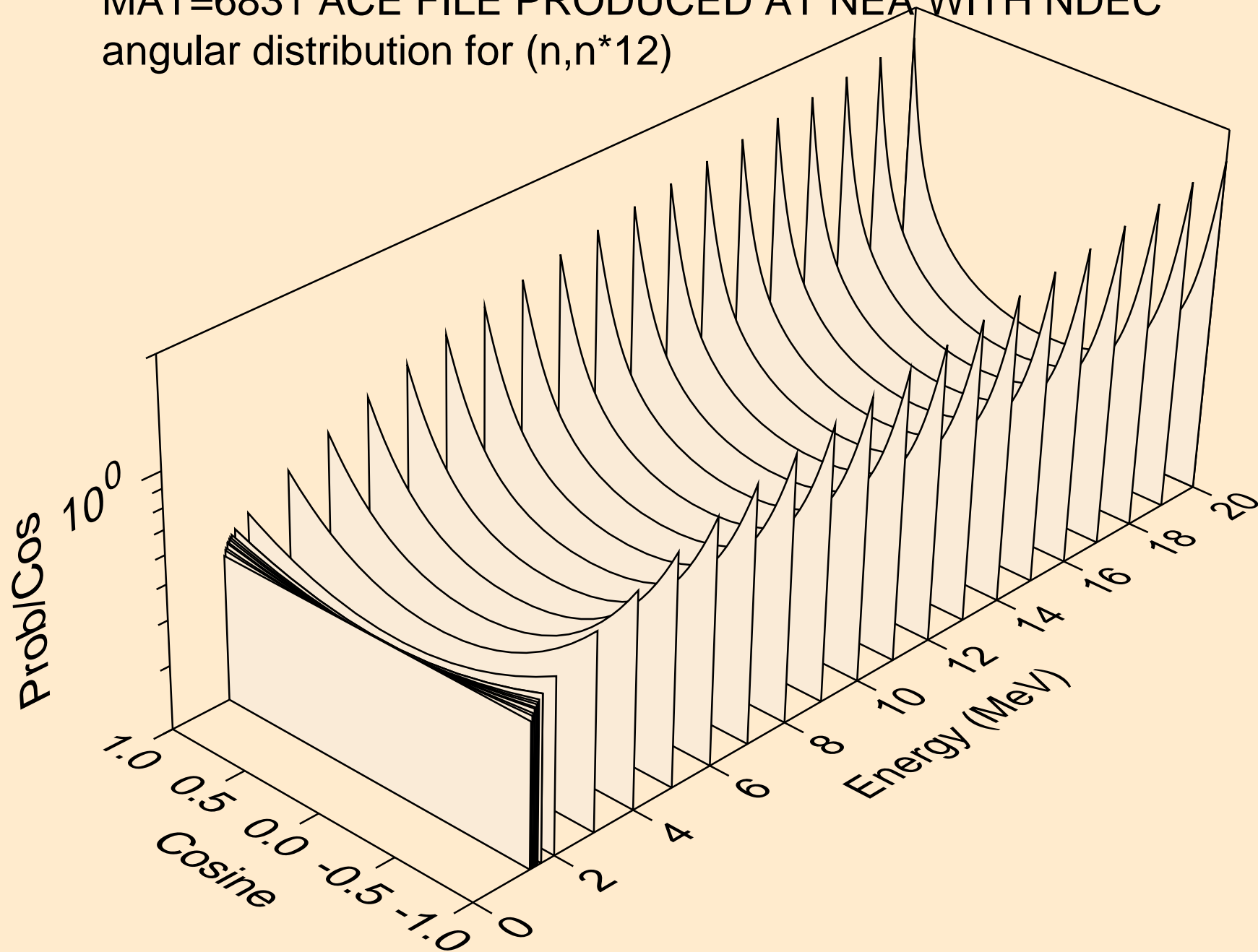

MAT=6831 ACE FILE PRODUCED AT NEA WITH NDEC  
angular distribution for (n,n\*13)

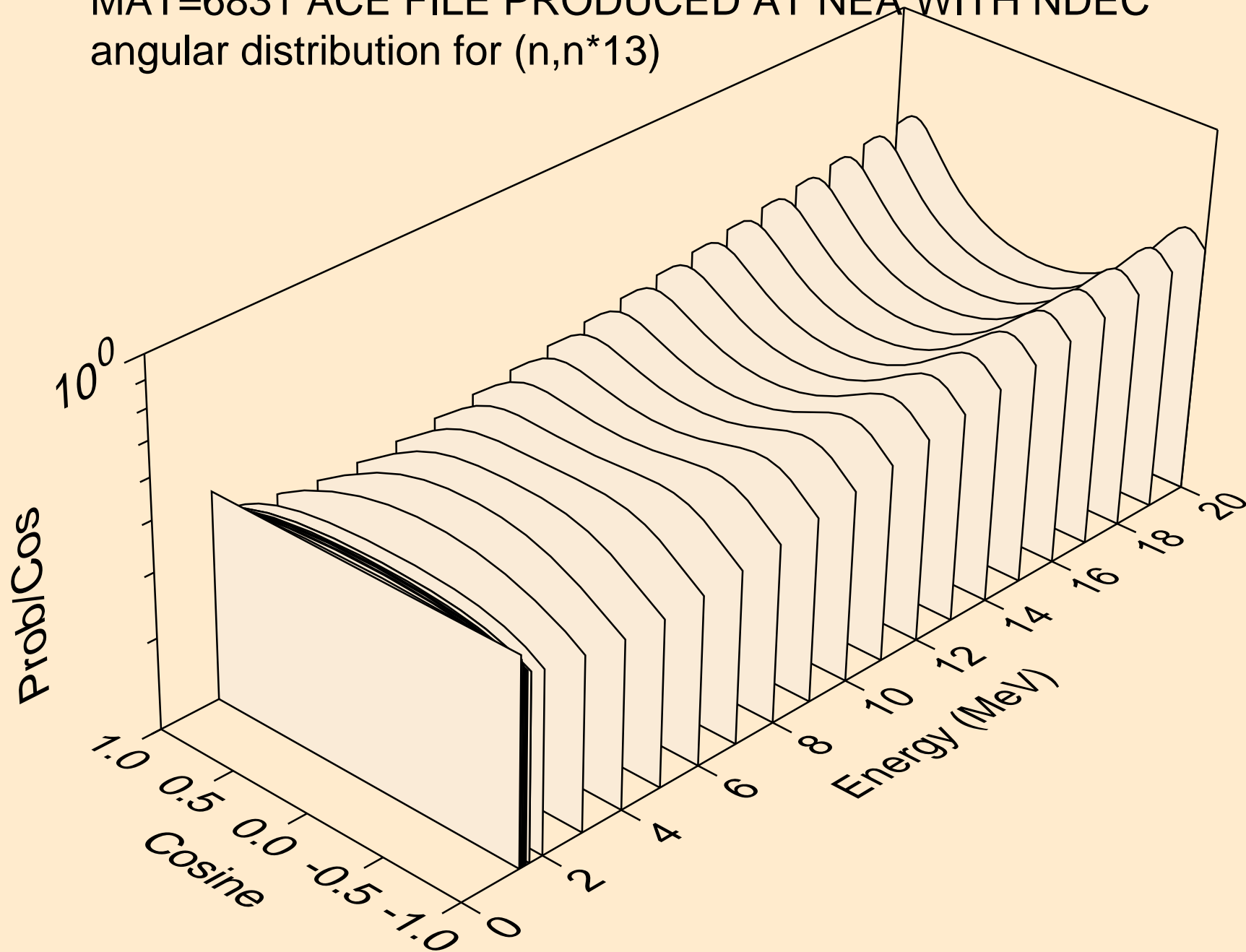

MAT=6831 ACE FILE PRODUCED AT NEA WITH NDEC  
angular distribution for (n,n\*14)

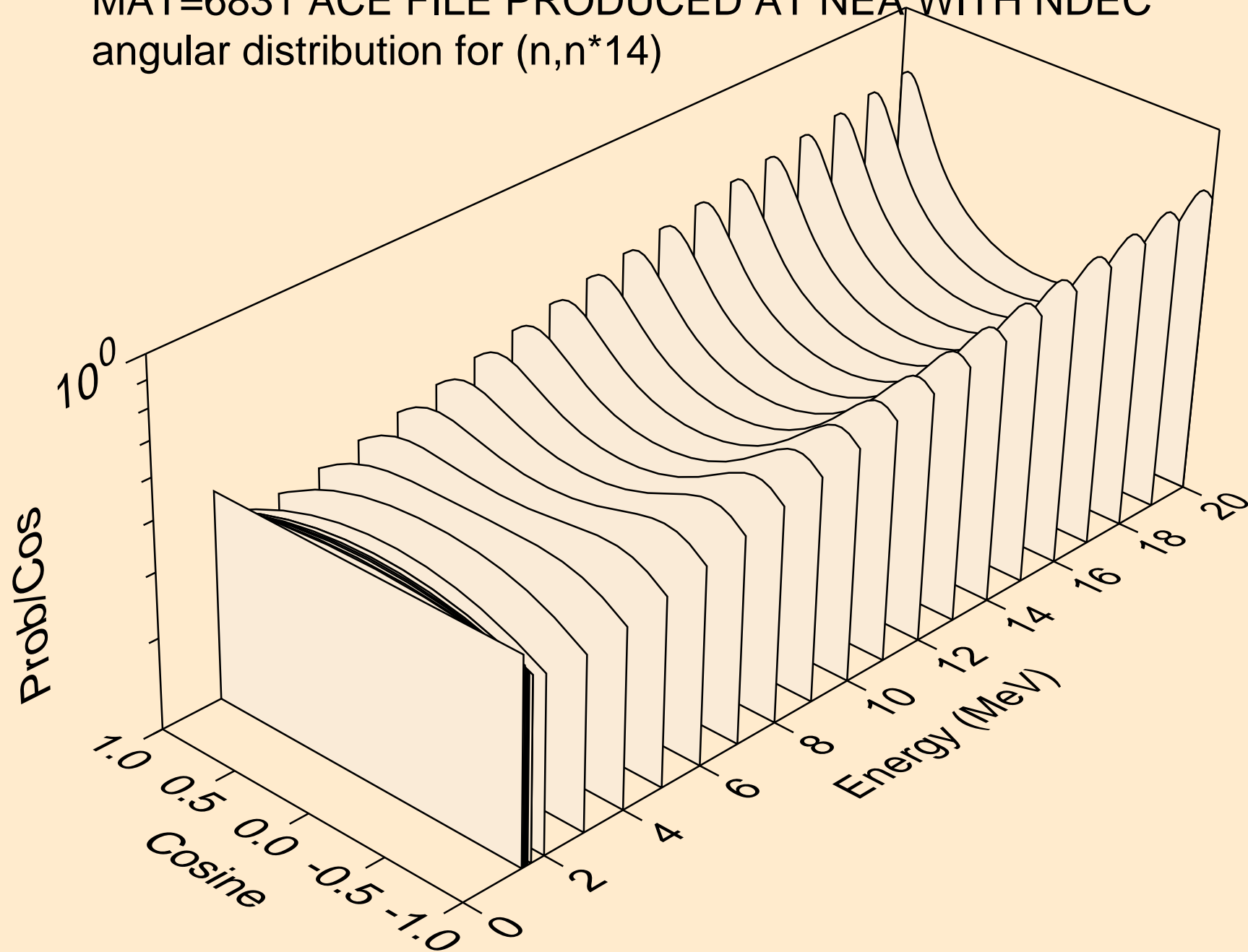

MAT=6831 ACE FILE PRODUCED AT NEA WITH NDEC  
angular distribution for (n,n\*15)

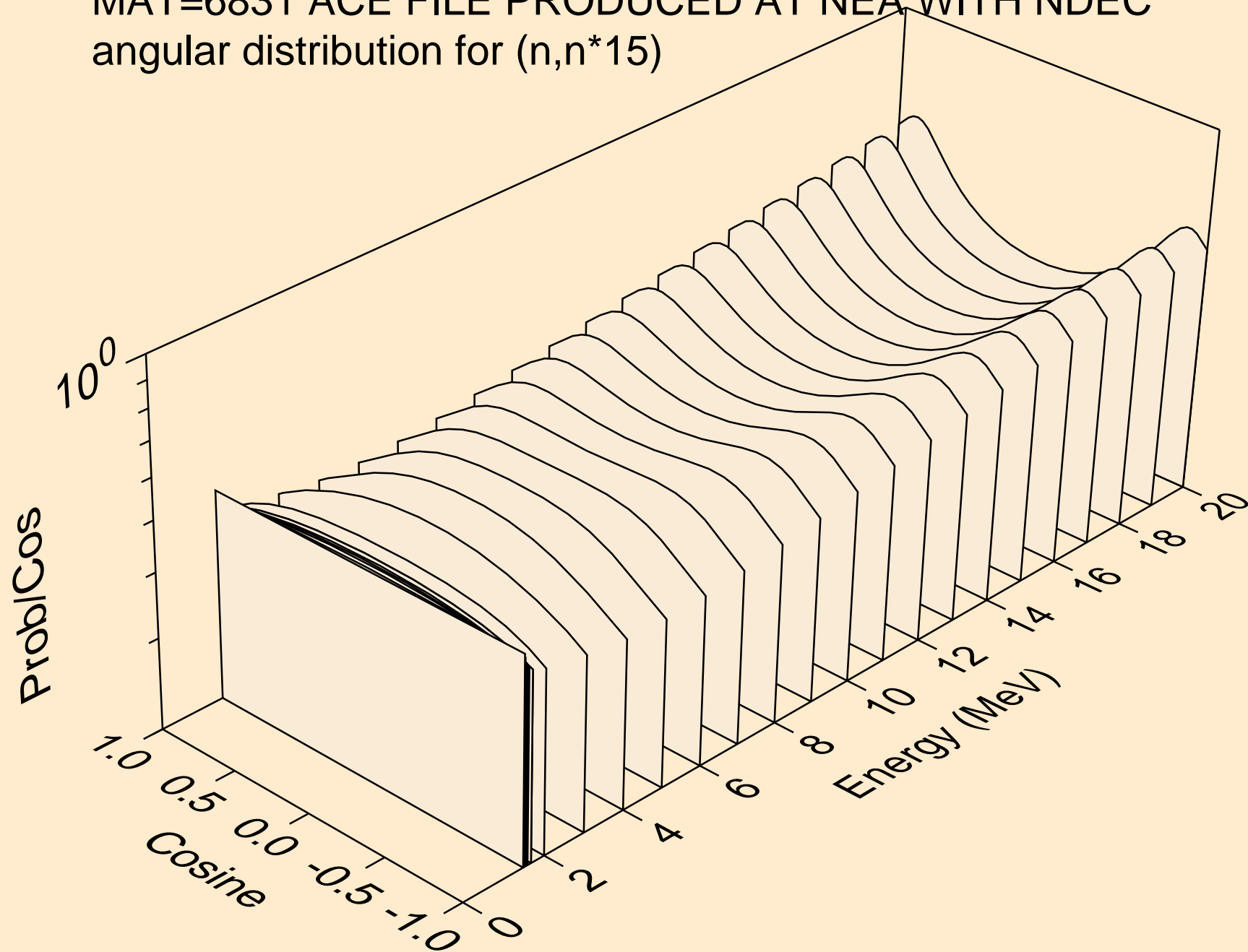

MAT=6831 ACE FILE PRODUCED AT NEA WITH NDEC  
angular distribution for (n,n\*16)

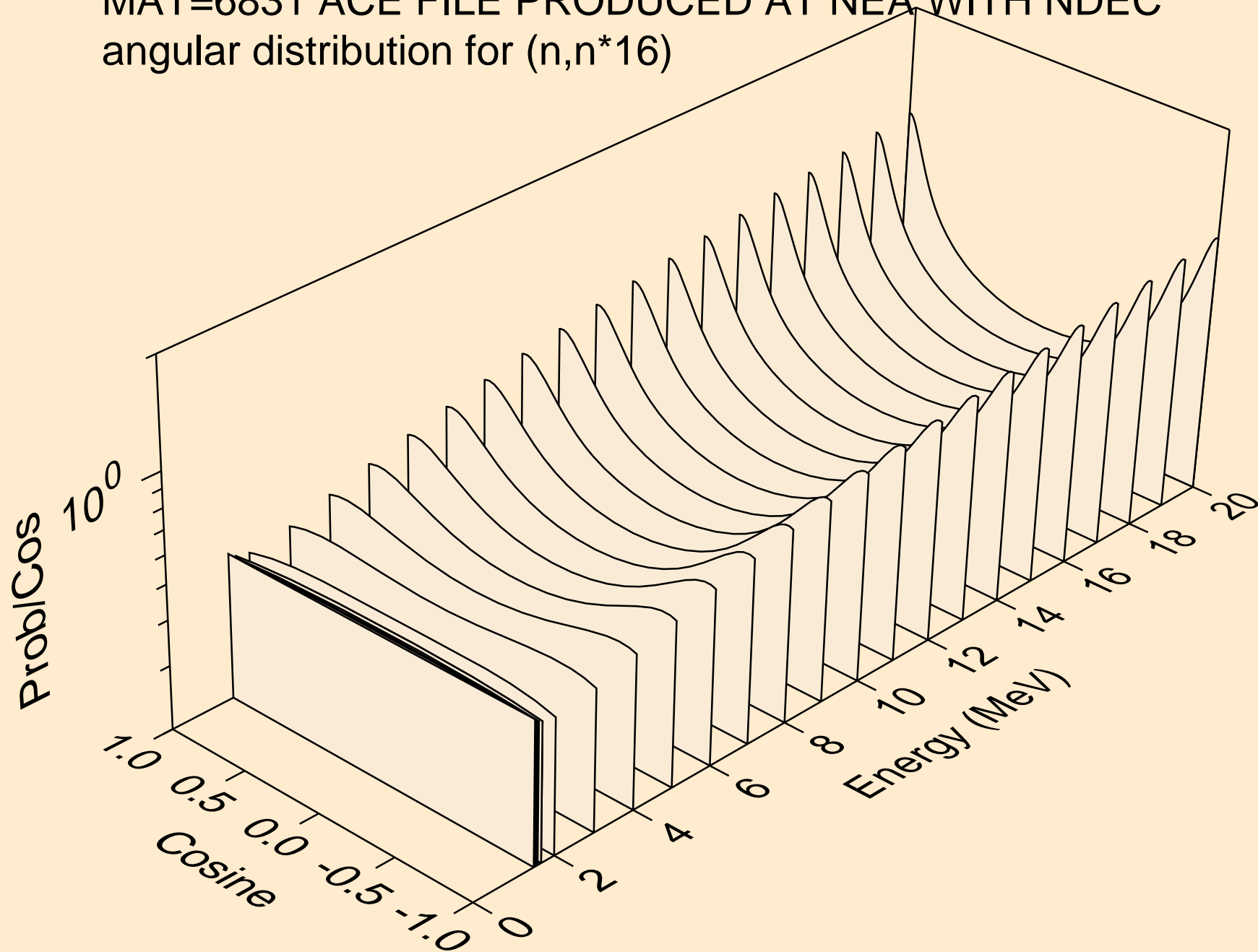

MAT=6831 ACE FILE PRODUCED AT NEA WITH NDEC  
angular distribution for (n,n\*c)

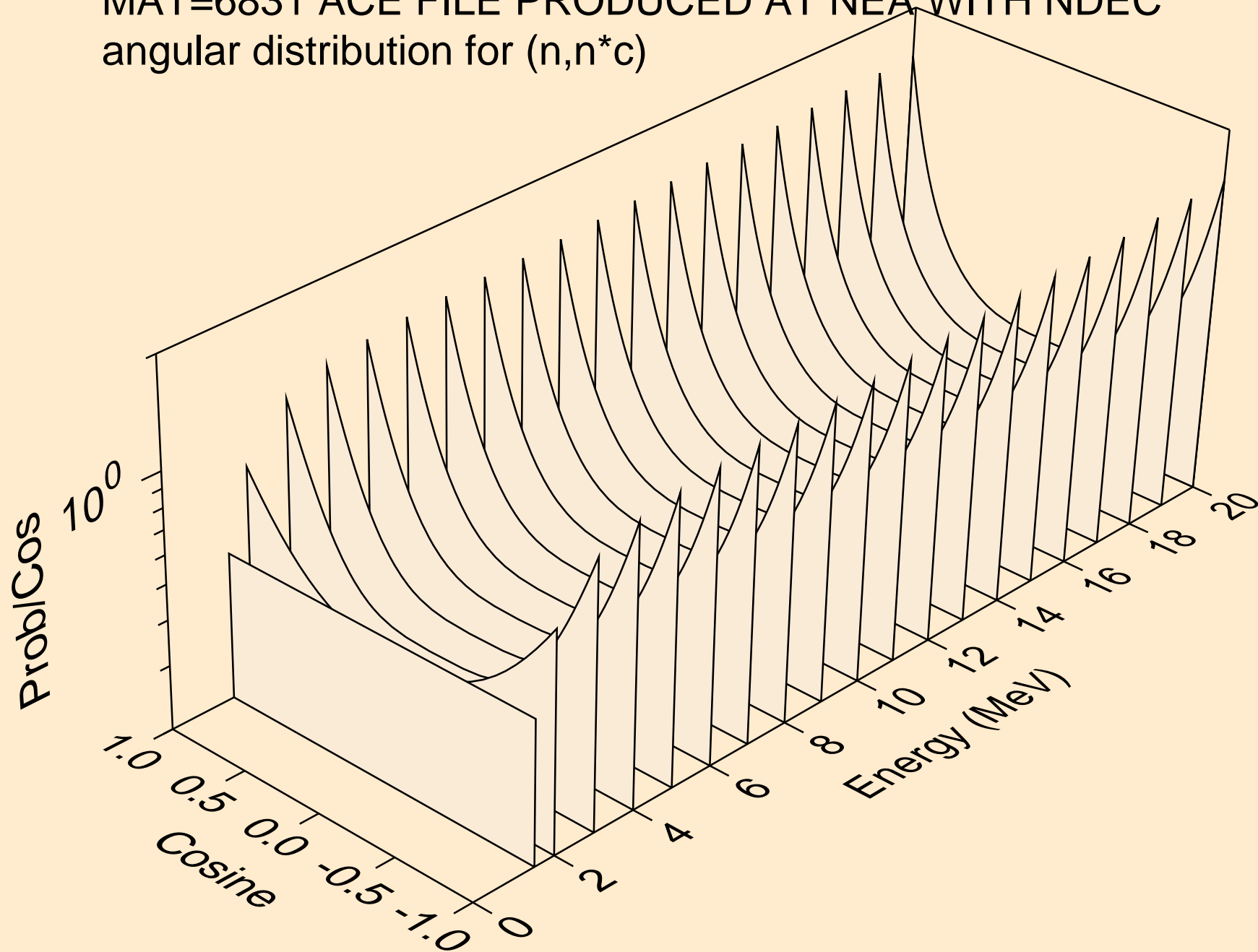

MAT=6831 ACE FILE PRODUCED AT NEA WITH NDEC  
Neutron emission for (n,2n)

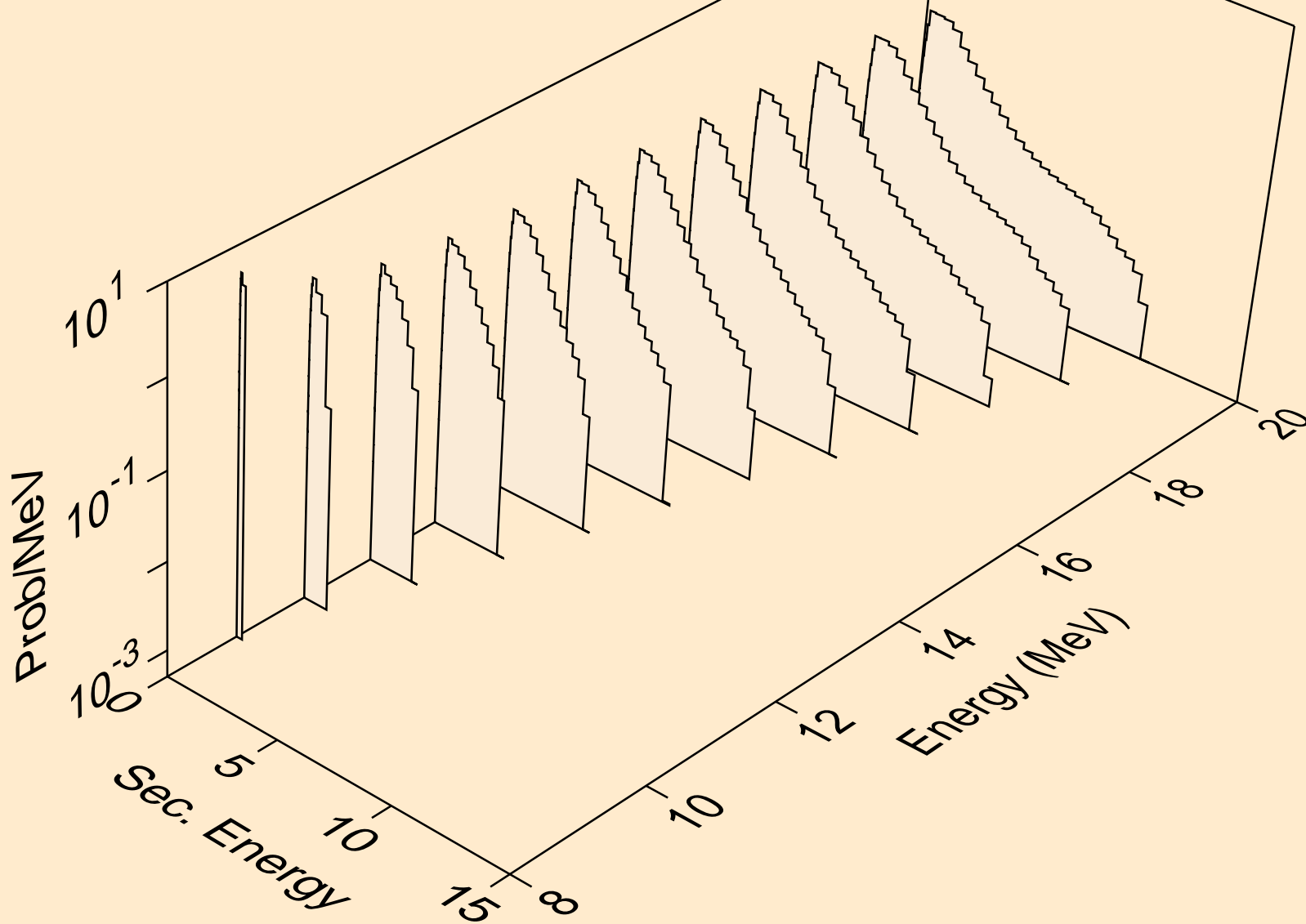

MAT=6831 ACE FILE PRODUCED AT NEA WITH NDEC  
Neutron emission for (n,3n)

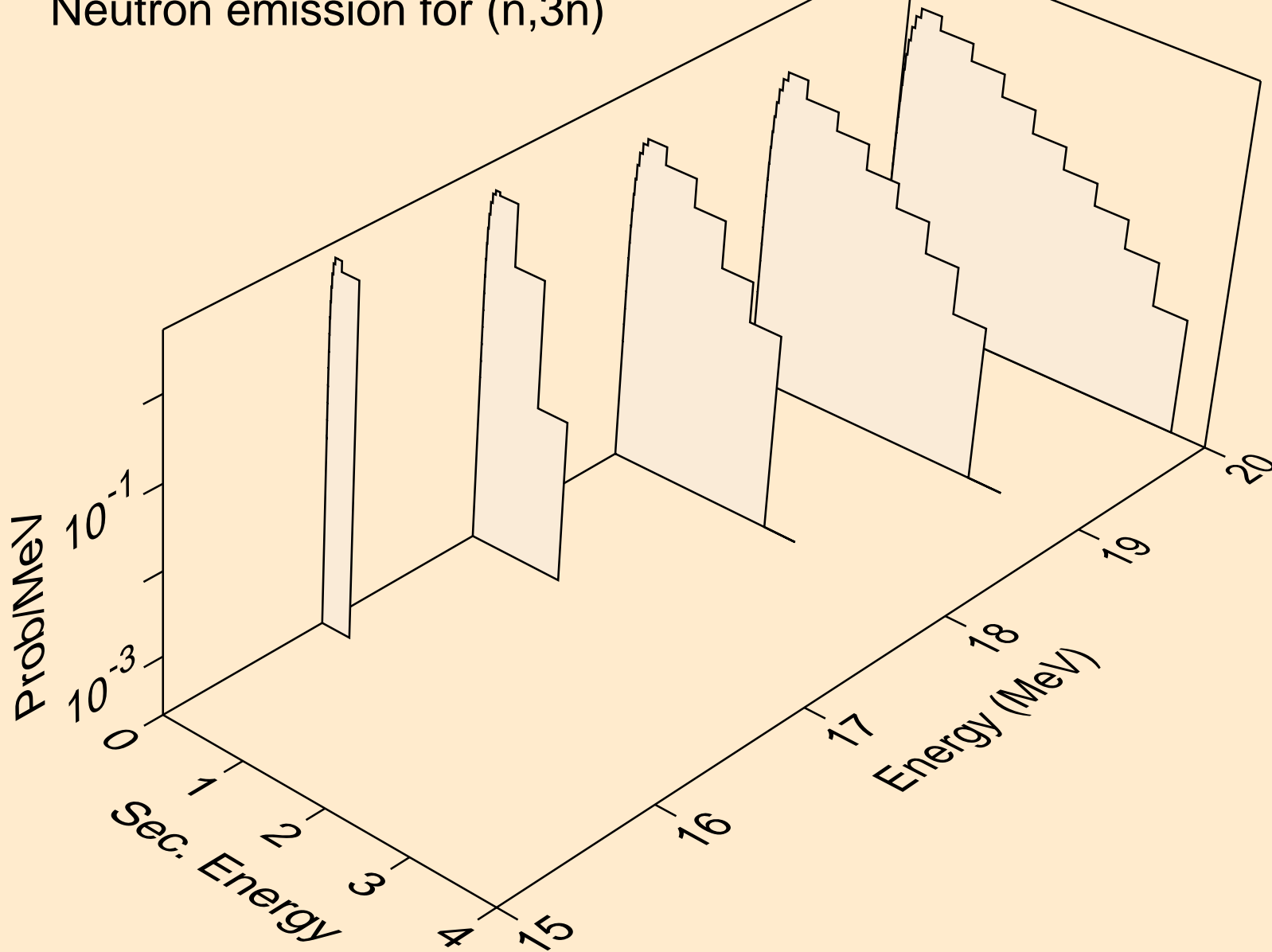

MAT=6831 ACE FILE PRODUCED AT NEA WITH NDEC  
Neutron emission for (n,n\*)a

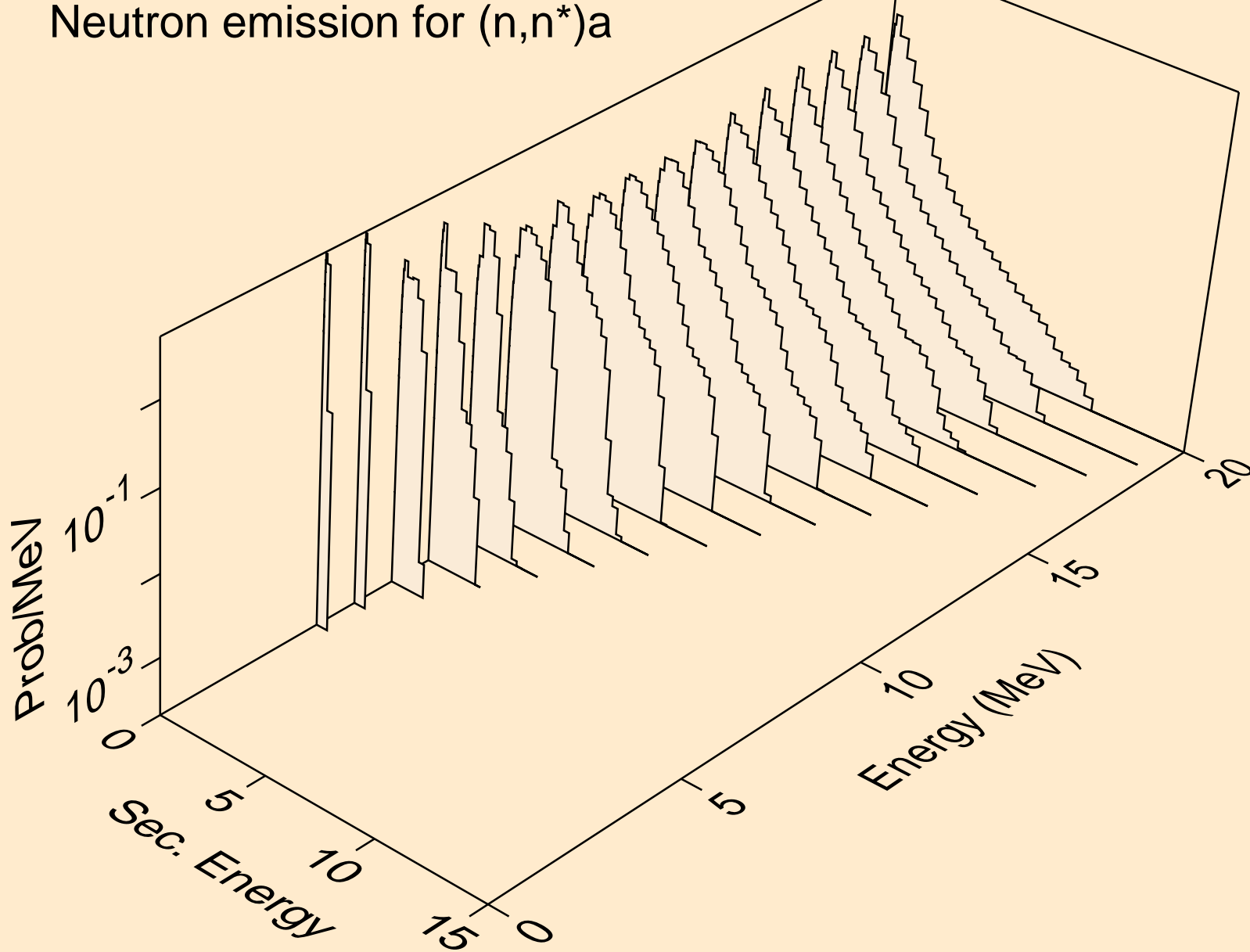

MAT=6831 ACE FILE PRODUCED AT NEA WITH NDEC  
Neutron emission for (n,n\*)p

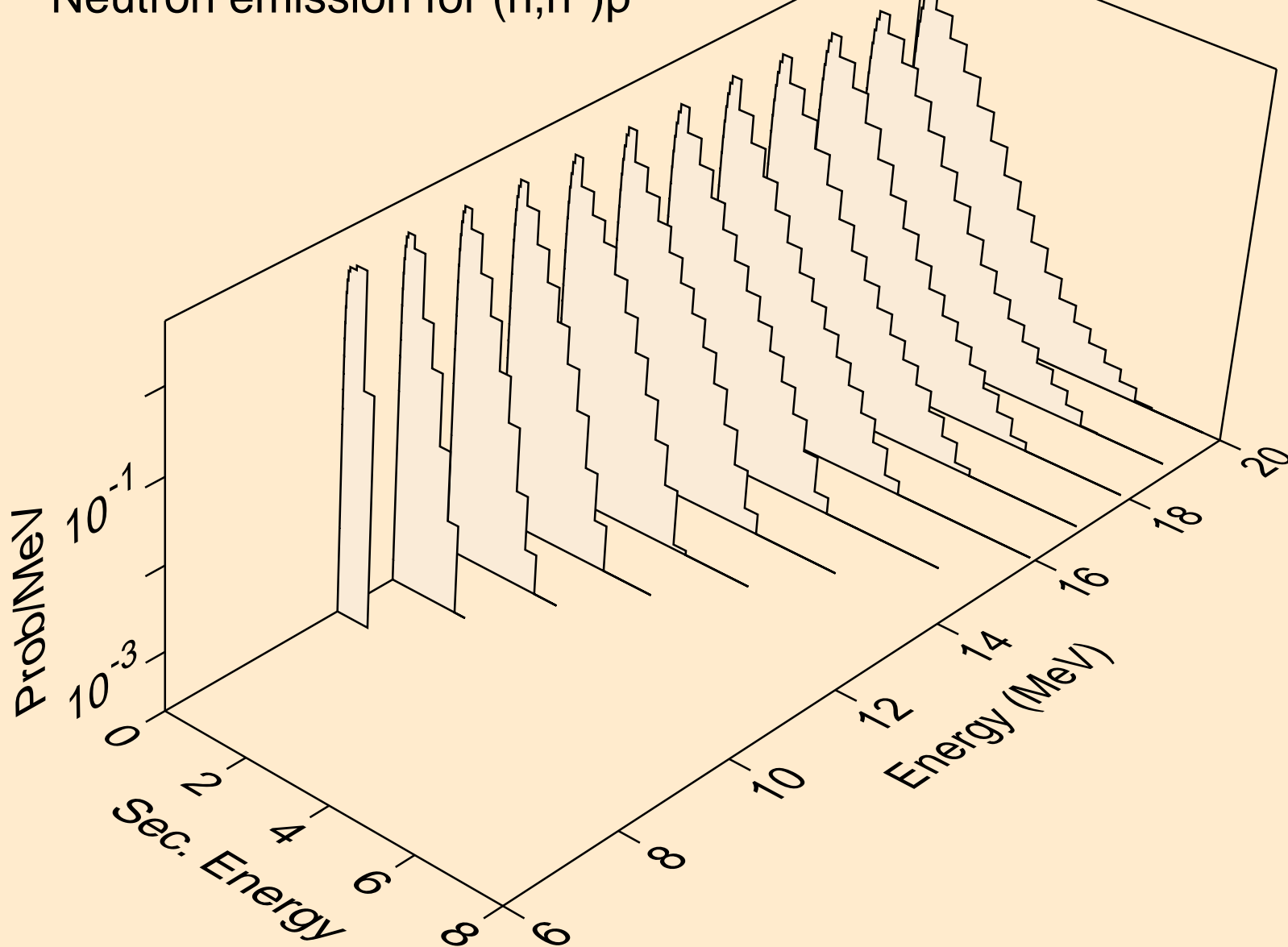

MAT=6831 ACE FILE PRODUCED AT NEA WITH NDEC  
Neutron emission for (n,n\*c)

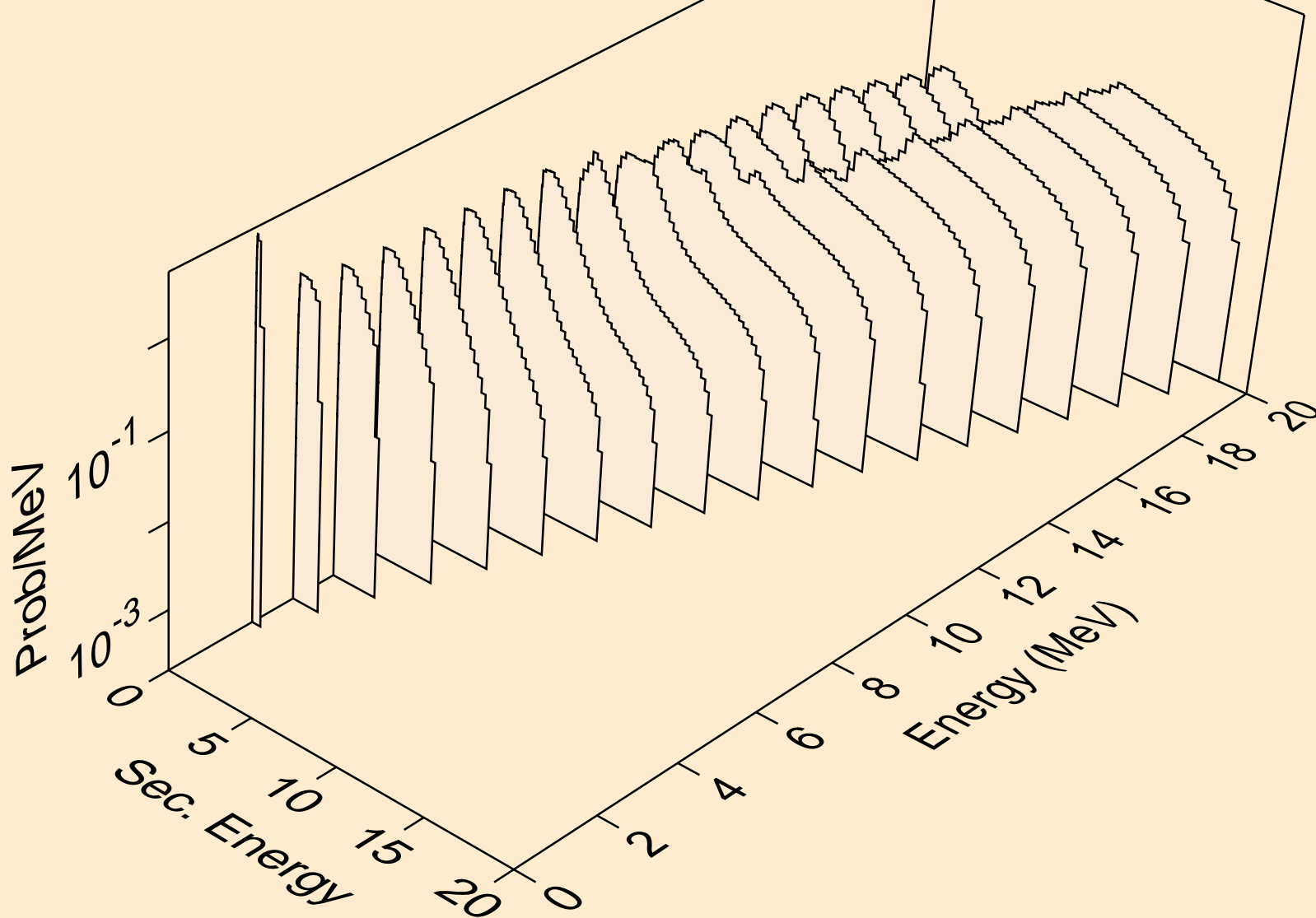

MAT=6831 ACE FILE PRODUCED AT NEA WITH NDEC  
Photon emission for (n,2n)

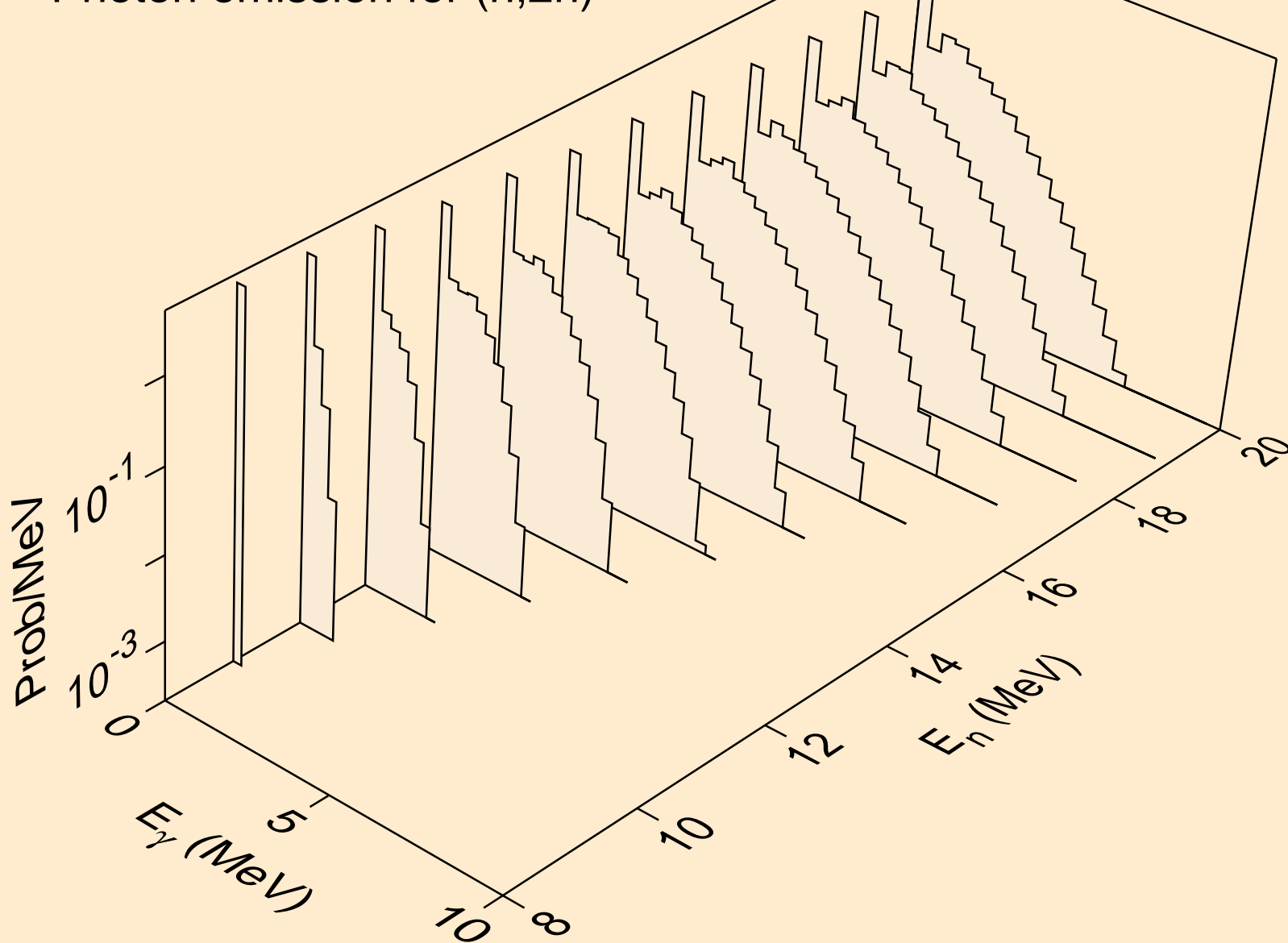

MAT=6831 ACE FILE PRODUCED AT NEA WITH NDEC  
Photon emission for (n,3n)

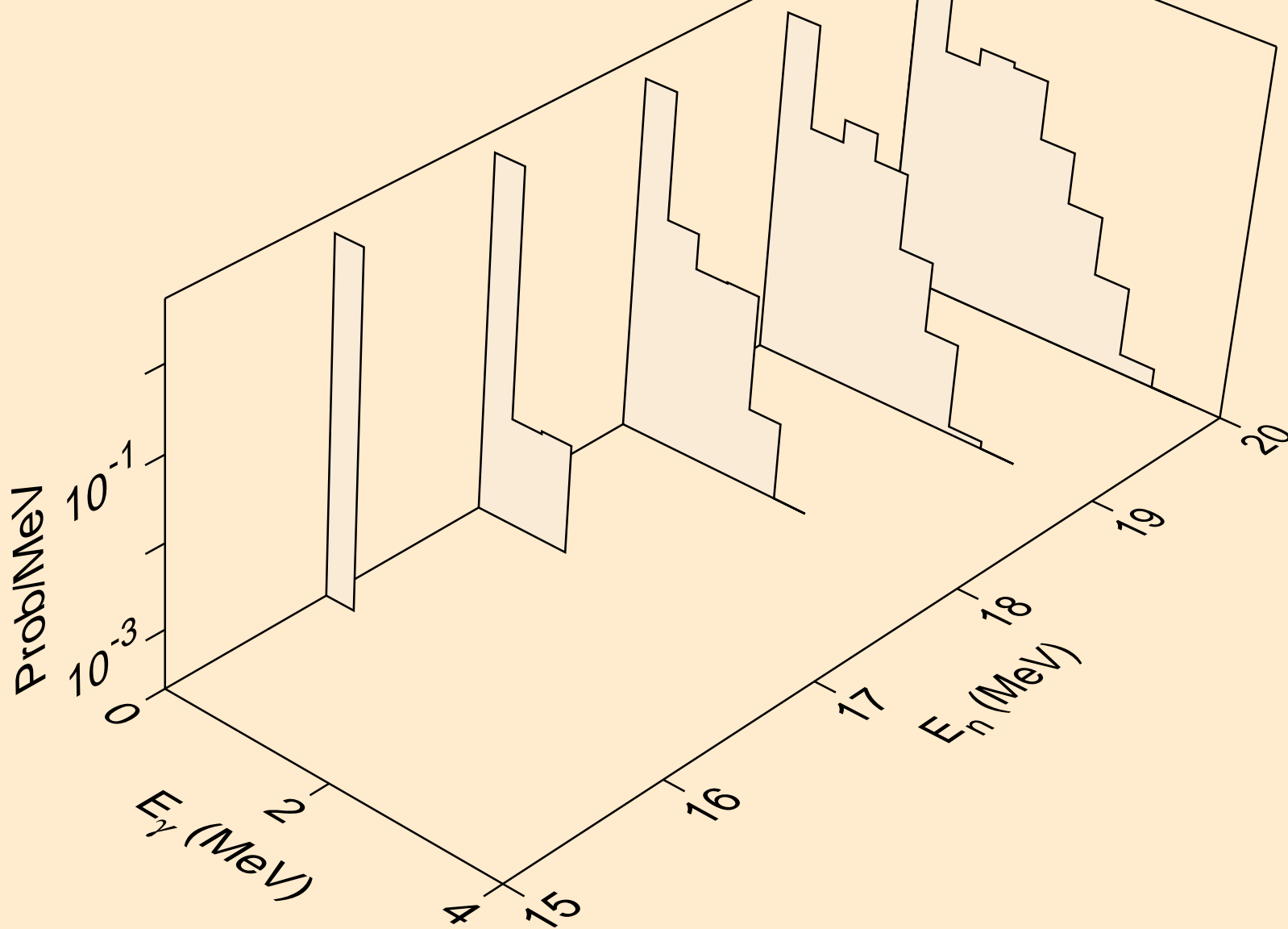

MAT=6831 ACE FILE PRODUCED AT NEA WITH NDEC  
Photon emission for (n,n\*c)

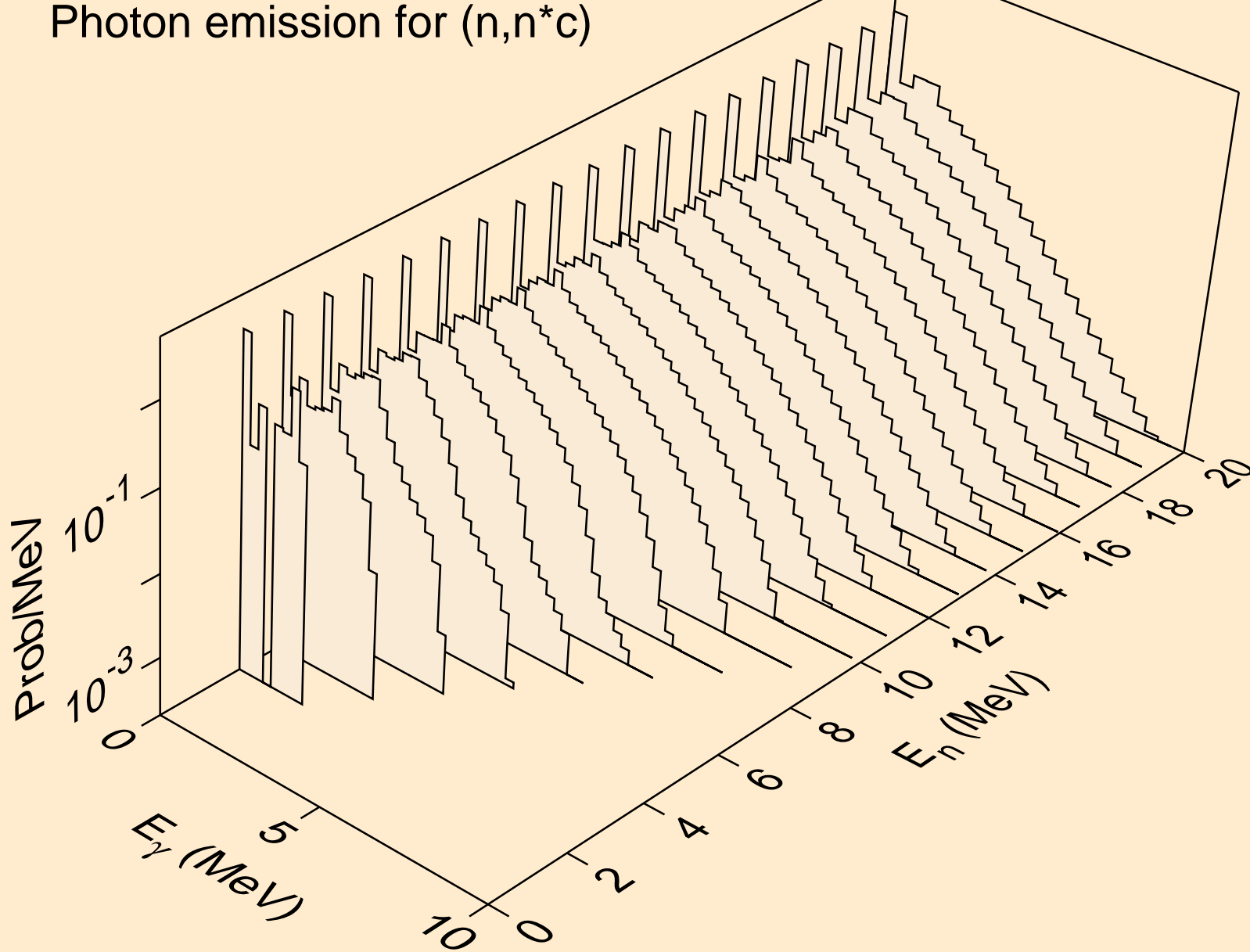

MAT=6831 ACE FILE PRODUCED AT NEA WITH NDEC  
Photon emission for (n,gma)

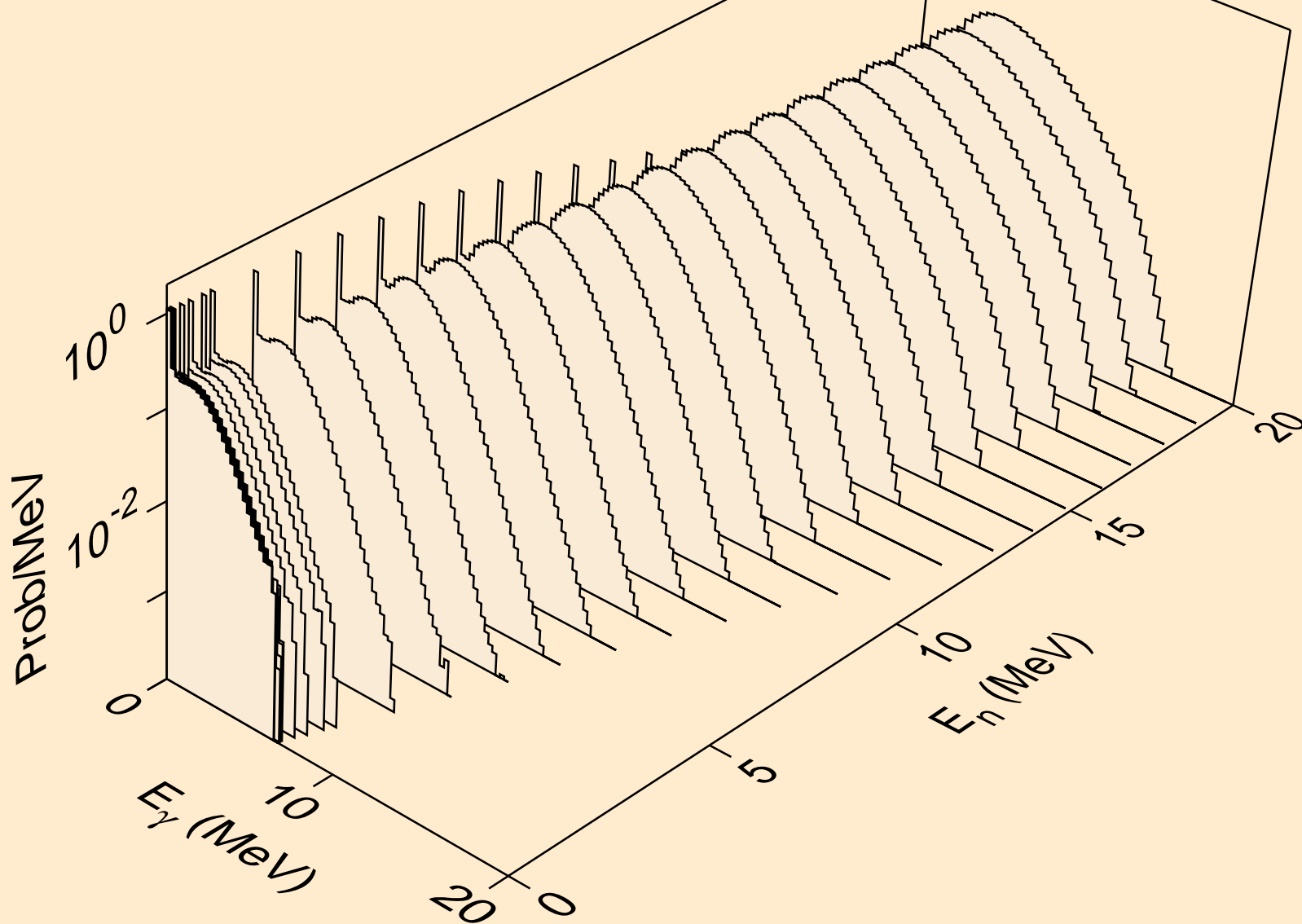

MAT=6831 ACE FILE PRODUCED AT NEA WITH NDEC  
Photon emission for (n,p)

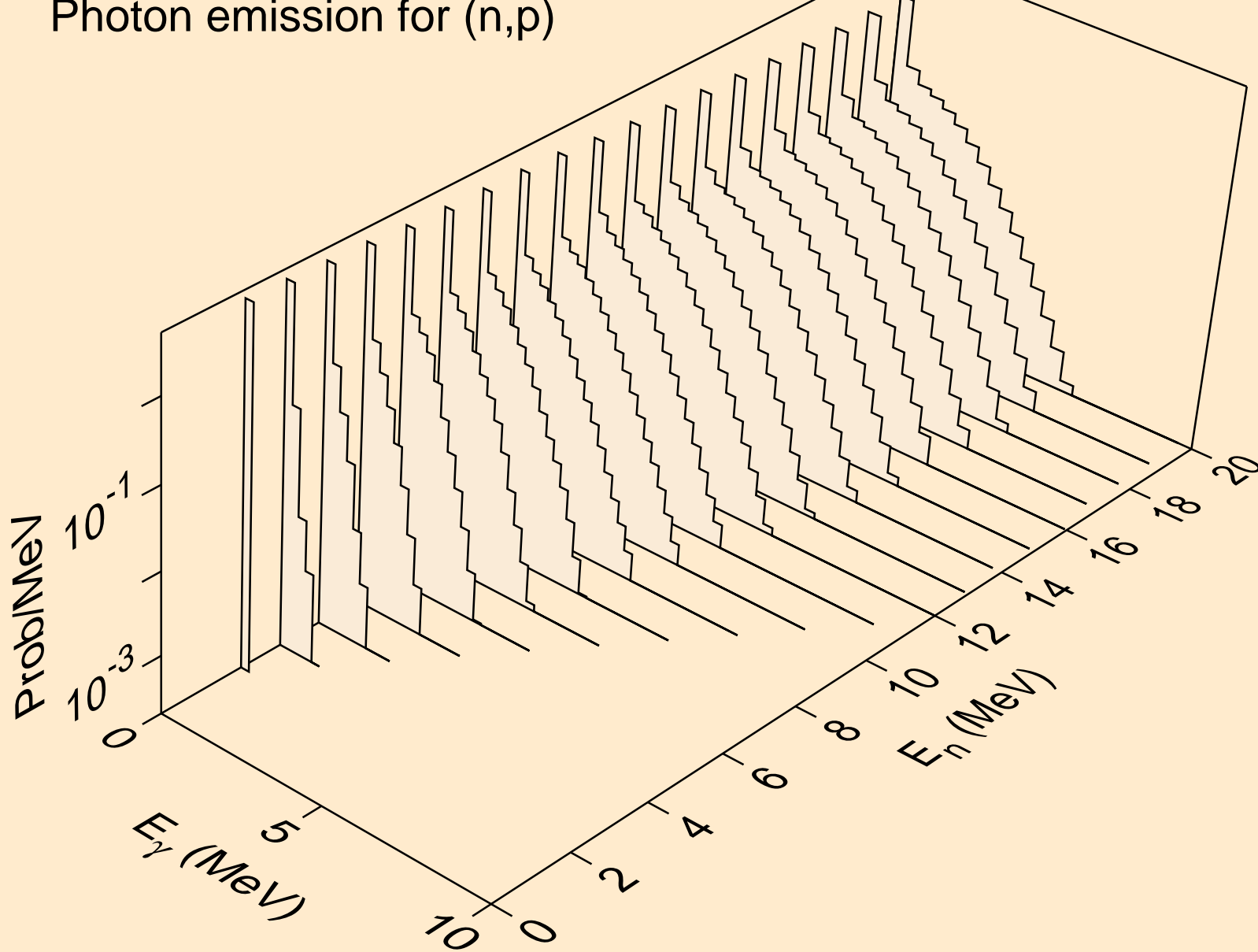

MAT=6831 ACE FILE PRODUCED AT NEA WITH NDEC  
Photon emission for (n,a)

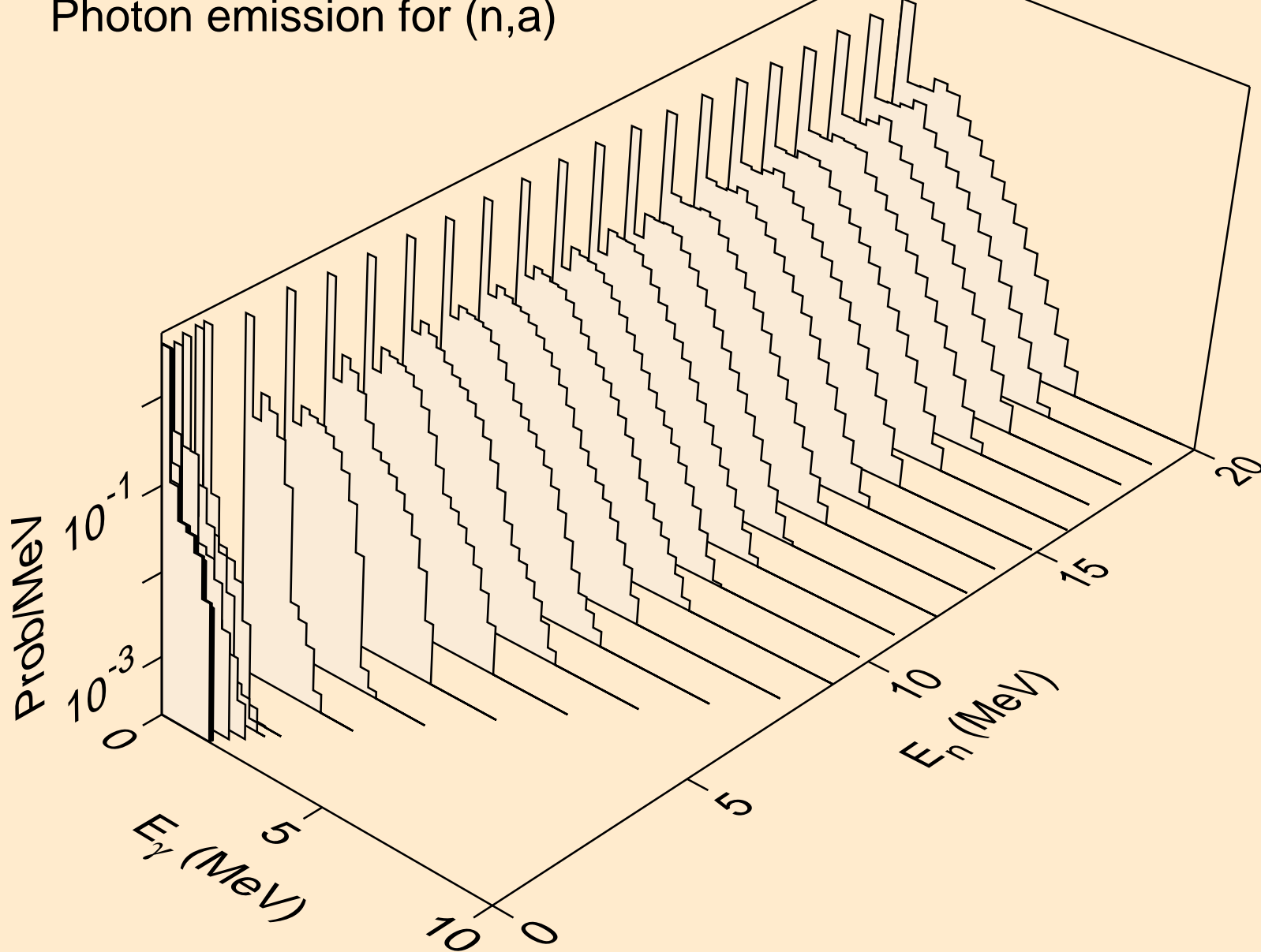

MAT=6831 ACE FILE PRODUCED AT NEA WITH NDEC  
thermal capture photon spectrum

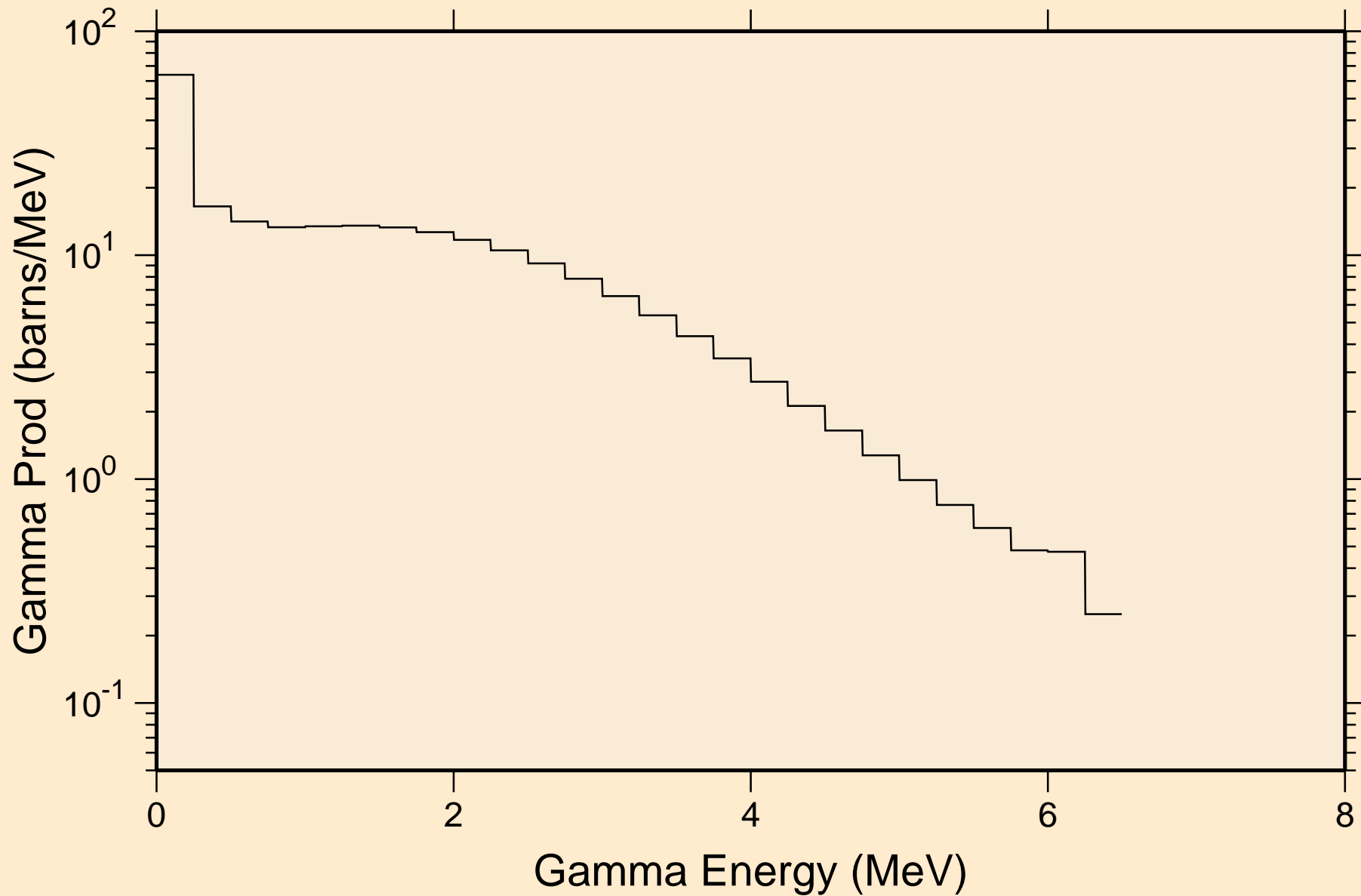

MAT=6831 ACE FILE PRODUCED AT NEA WITH NDEC  
14 MeV photon spectrum

