

MAT=3925 ACE FILE PRODUCED AT NEA WITH NDEC  
Principal cross sections

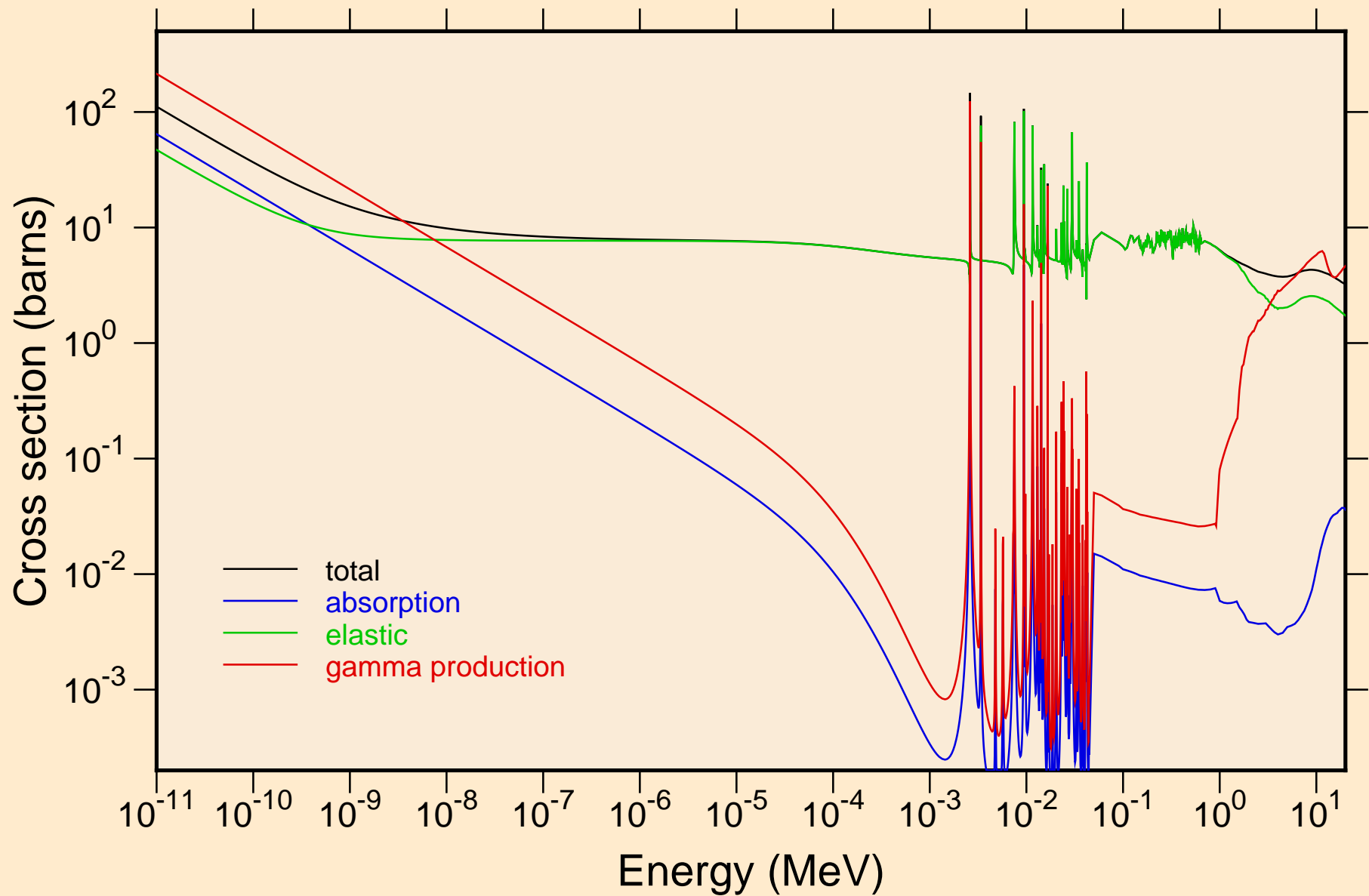

MAT=3925 ACE FILE PRODUCED AT NEA WITH NDEC  
resonance total cross section

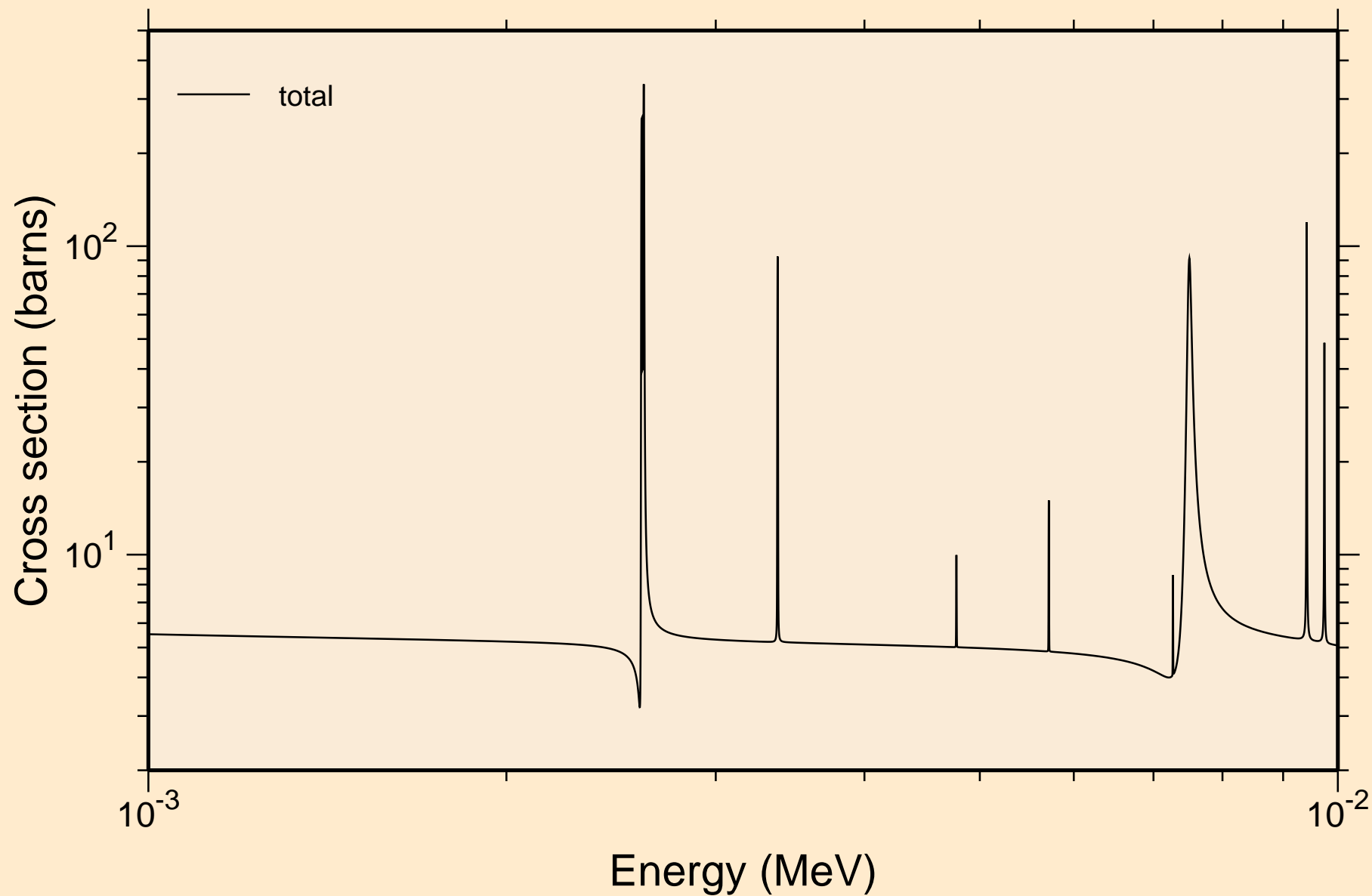

MAT=3925 ACE FILE PRODUCED AT NEA WITH NDEC  
resonance total cross section

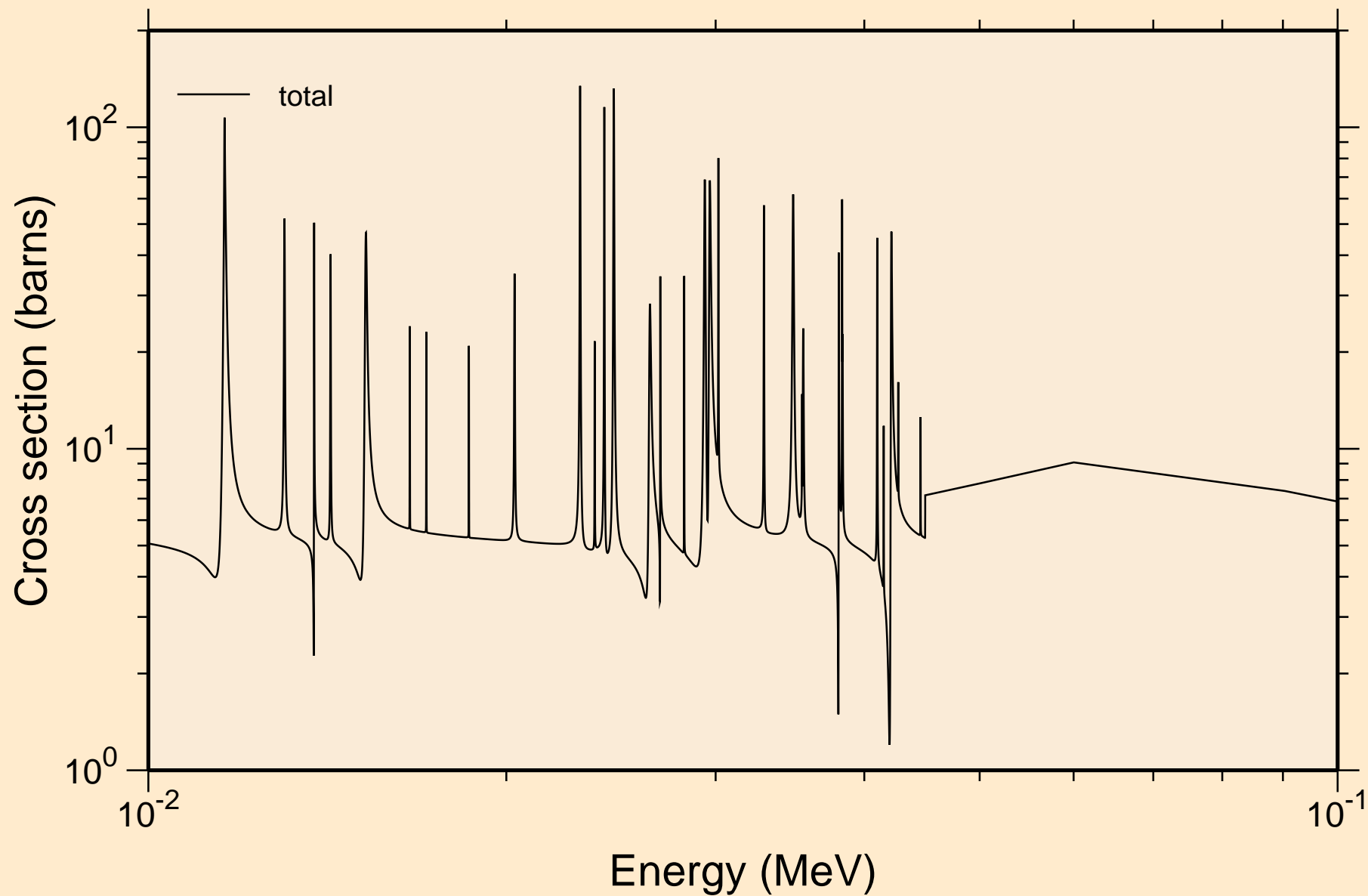

MAT=3925 ACE FILE PRODUCED AT NEA WITH NDEC  
resonance total cross section

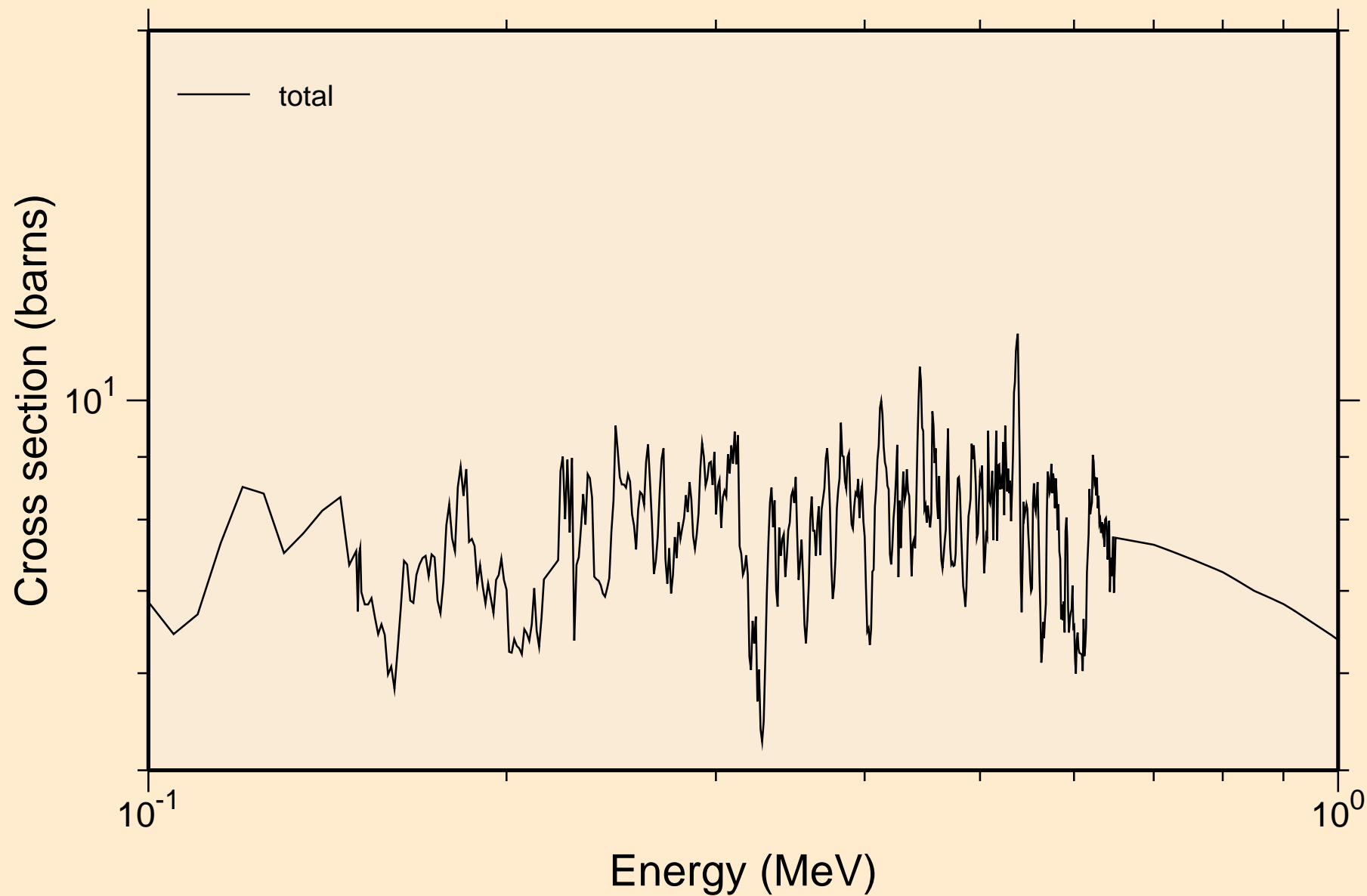

MAT=3925 ACE FILE PRODUCED AT NEA WITH NDEC  
resonance total cross section

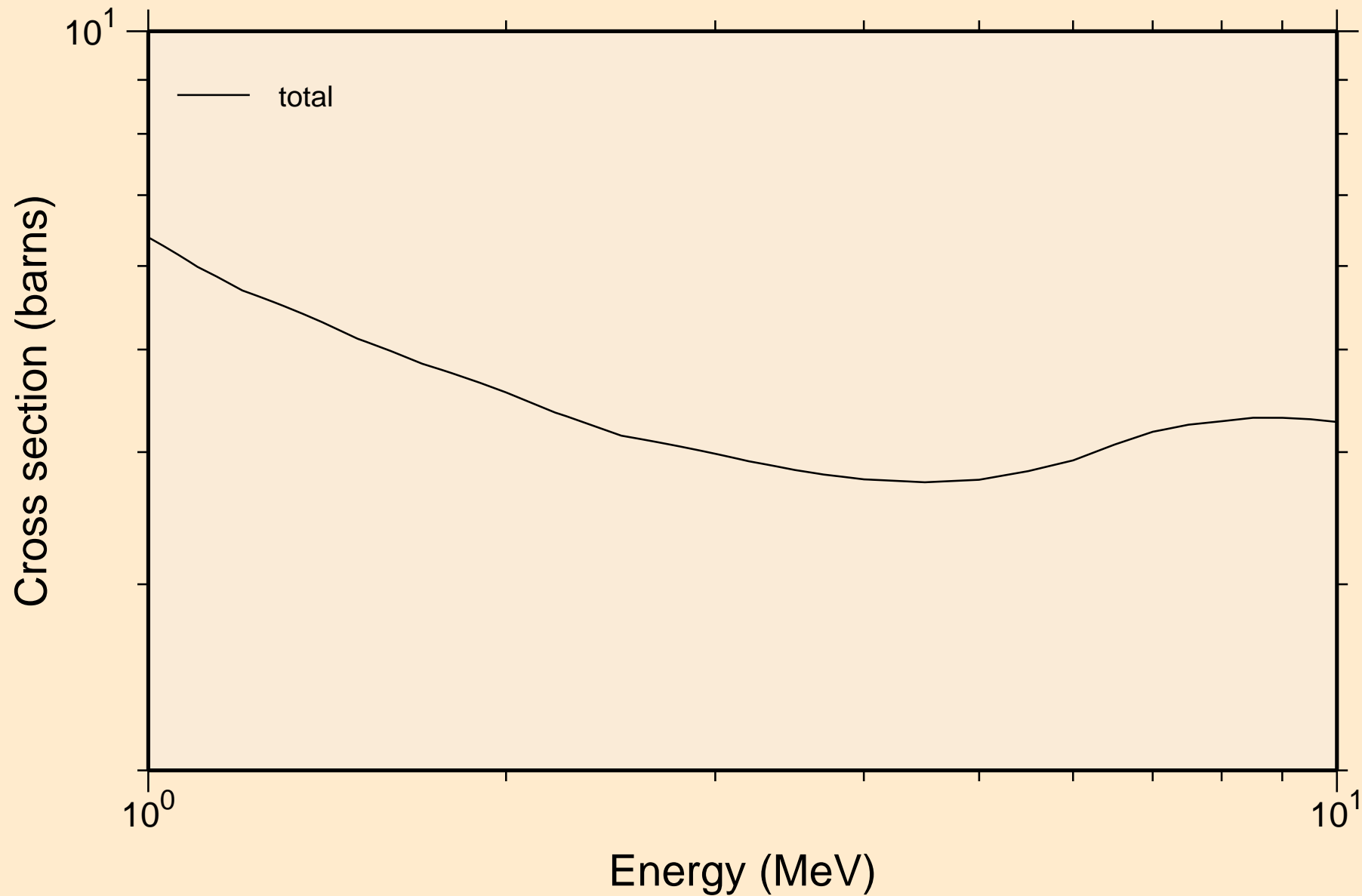

MAT=3925 ACE FILE PRODUCED AT NEA WITH NDEC  
resonance absorption cross sections

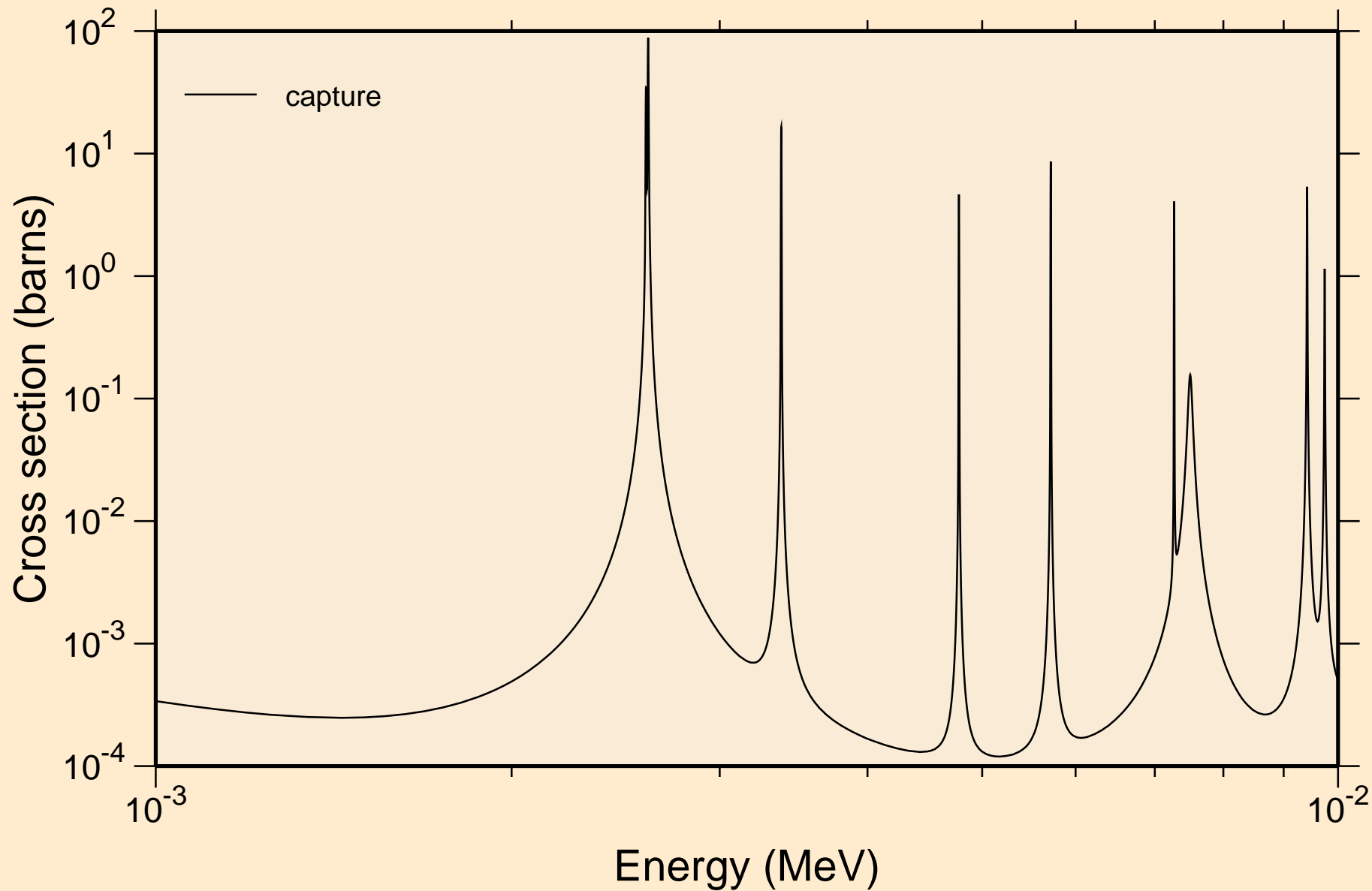

MAT=3925 ACE FILE PRODUCED AT NEA WITH NDEC  
resonance absorption cross sections

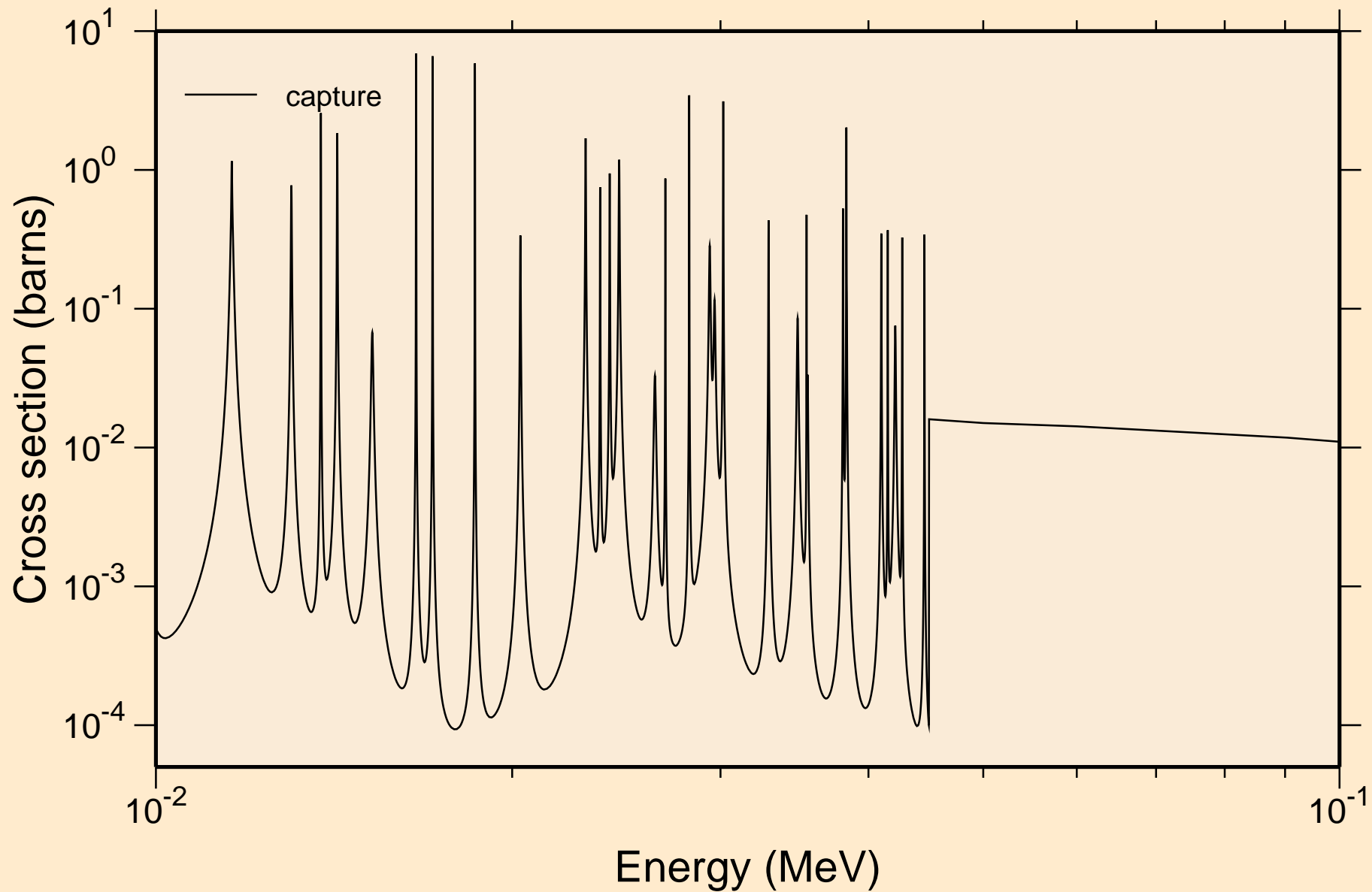

MAT=3925 ACE FILE PRODUCED AT NEA WITH NDEC  
resonance absorption cross sections

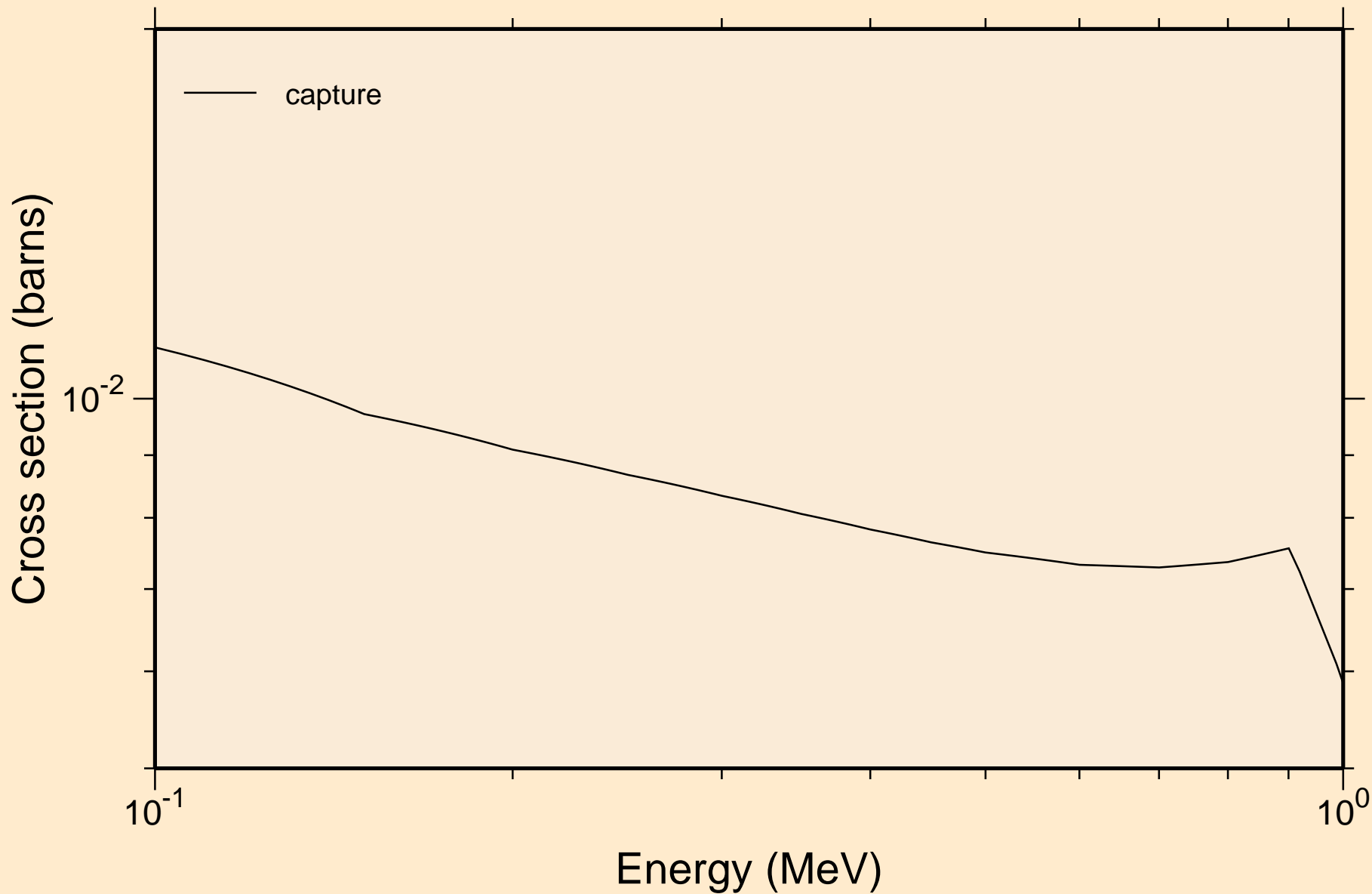



MAT=3925 ACE FILE PRODUCED AT NEA WITH NDEC  
resonance absorption cross sections

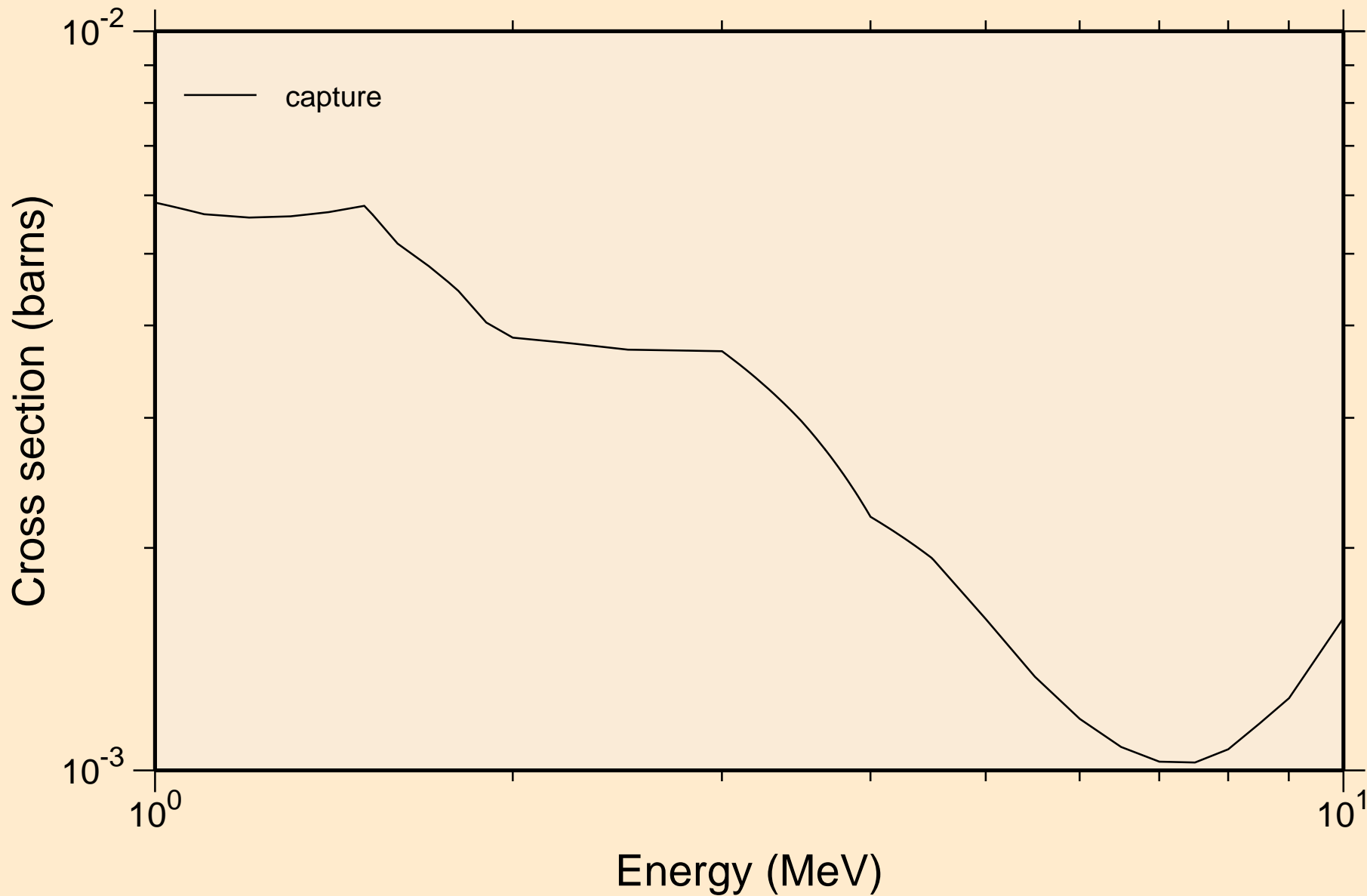

MAT=3925 ACE FILE PRODUCED AT NEA WITH NDEC  
Heating

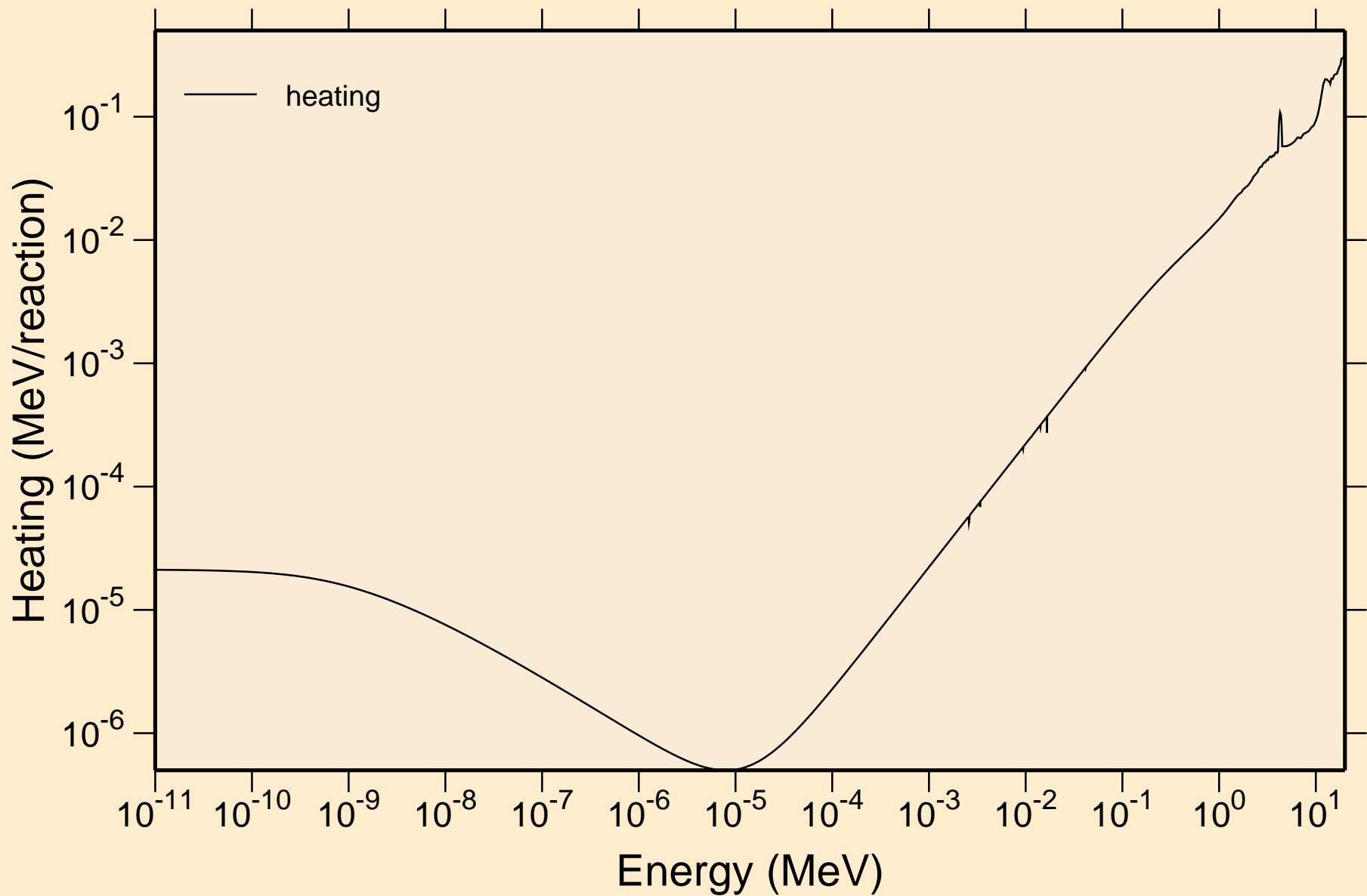

MAT=3925 ACE FILE PRODUCED AT NEA WITH NDEC  
Damage

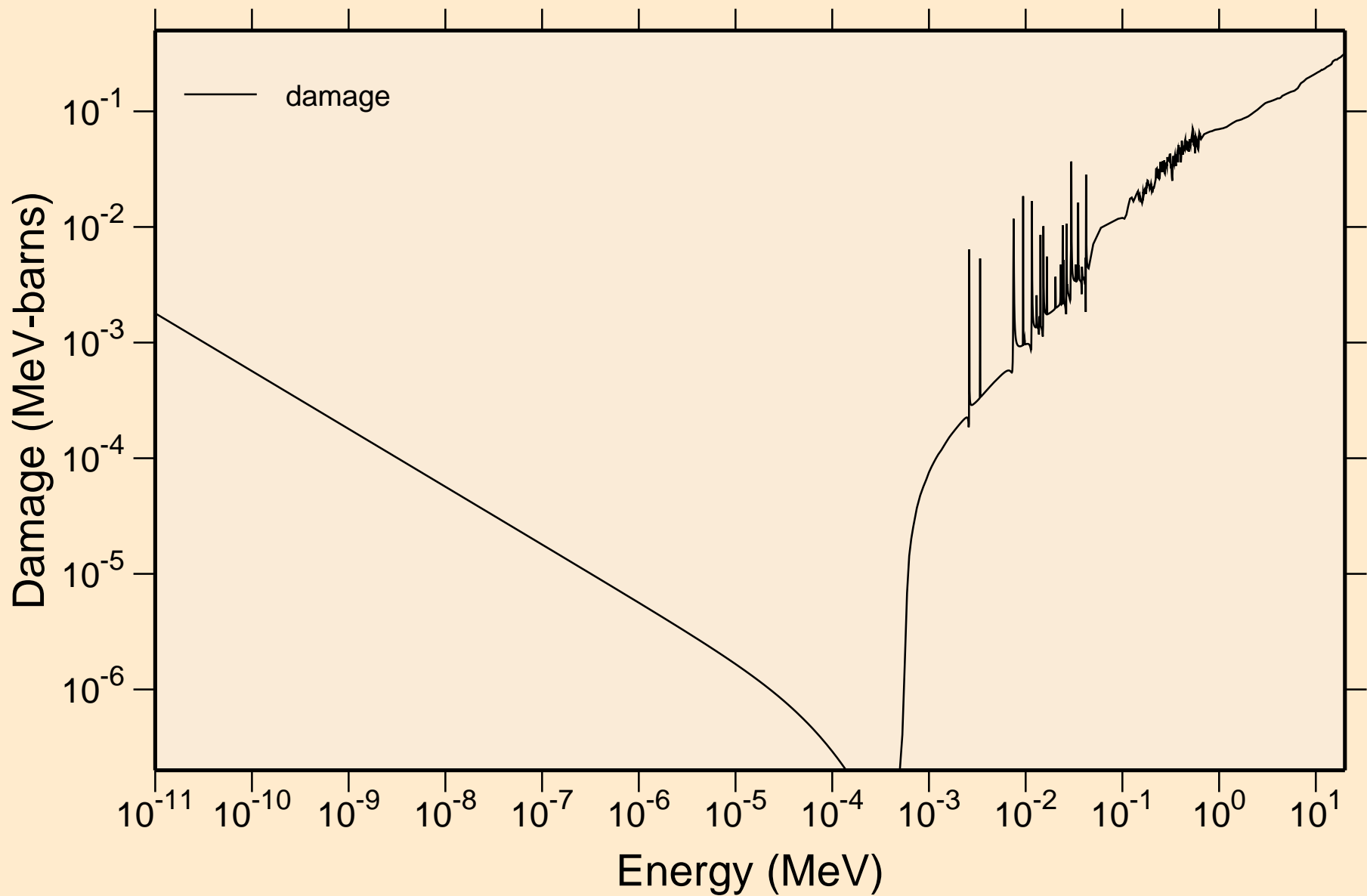

MAT=3925 ACE FILE PRODUCED AT NEA WITH NDEC  
Non-threshold reactions

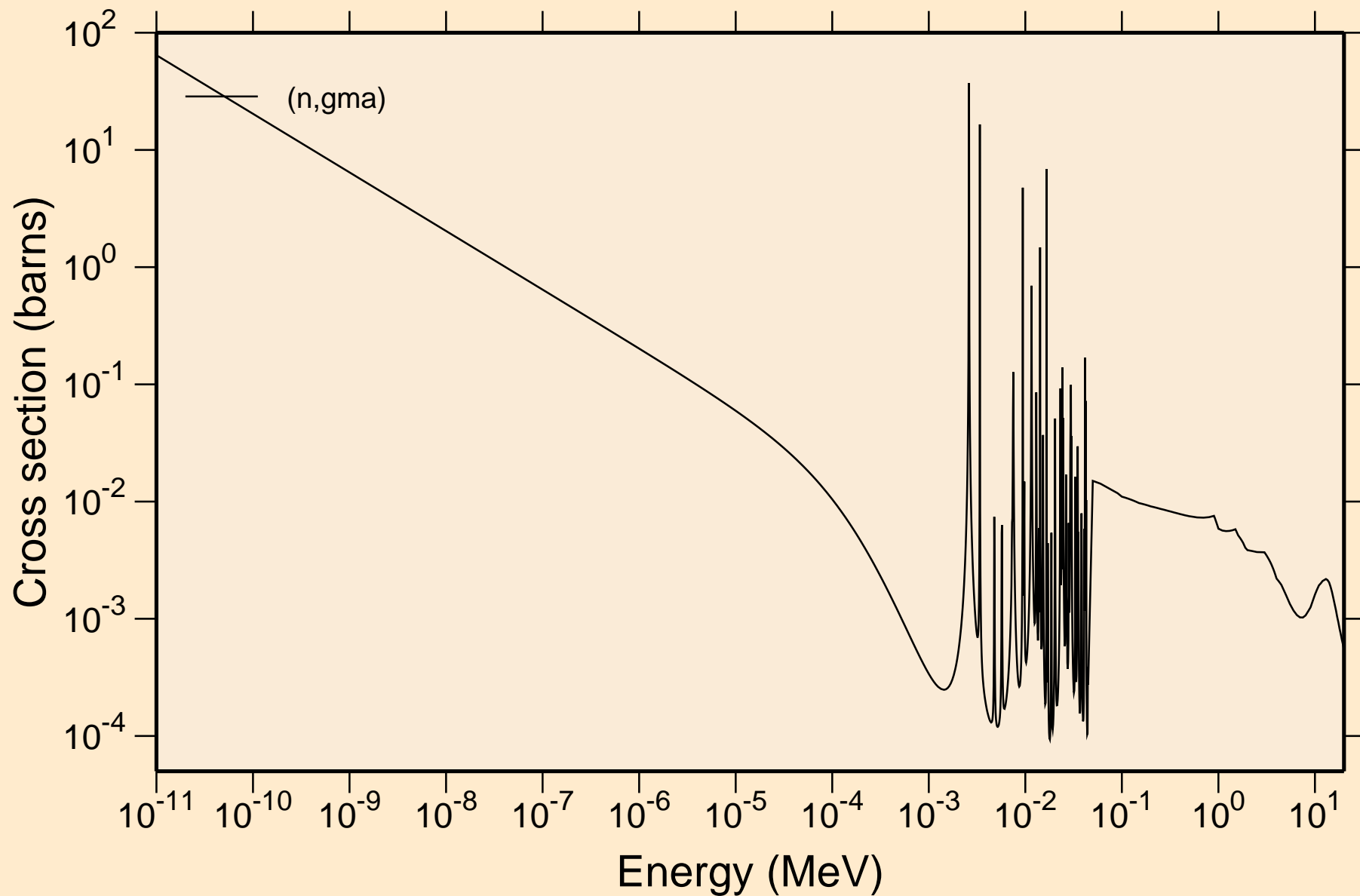

# MAT=3925 ACE FILE PRODUCED AT NEA WITH NDEC

## Principal cross sections

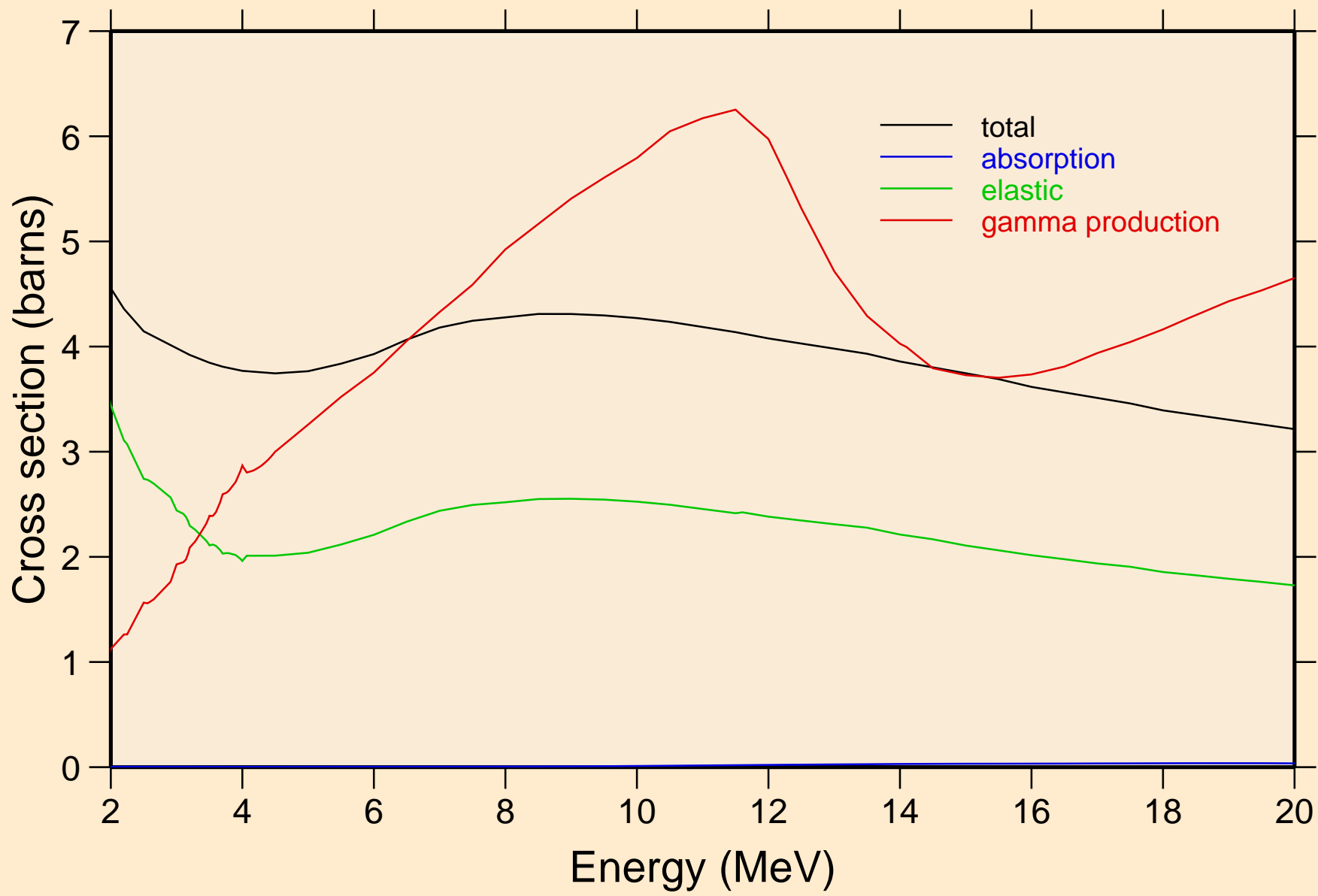

MAT=3925 ACE FILE PRODUCED AT NEA WITH NDEC  
Heating

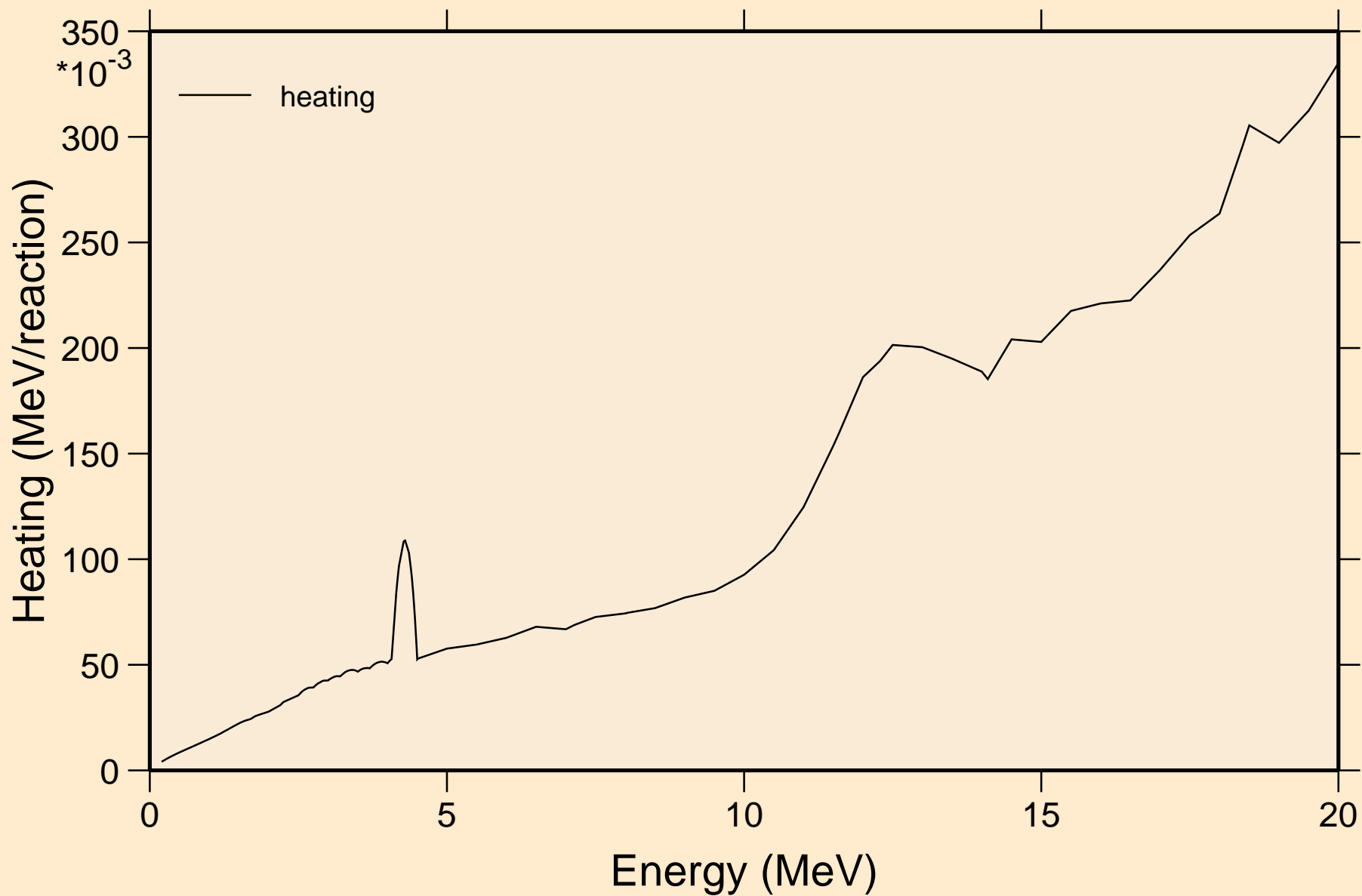

MAT=3925 ACE FILE PRODUCED AT NEA WITH NDEC  
Damage

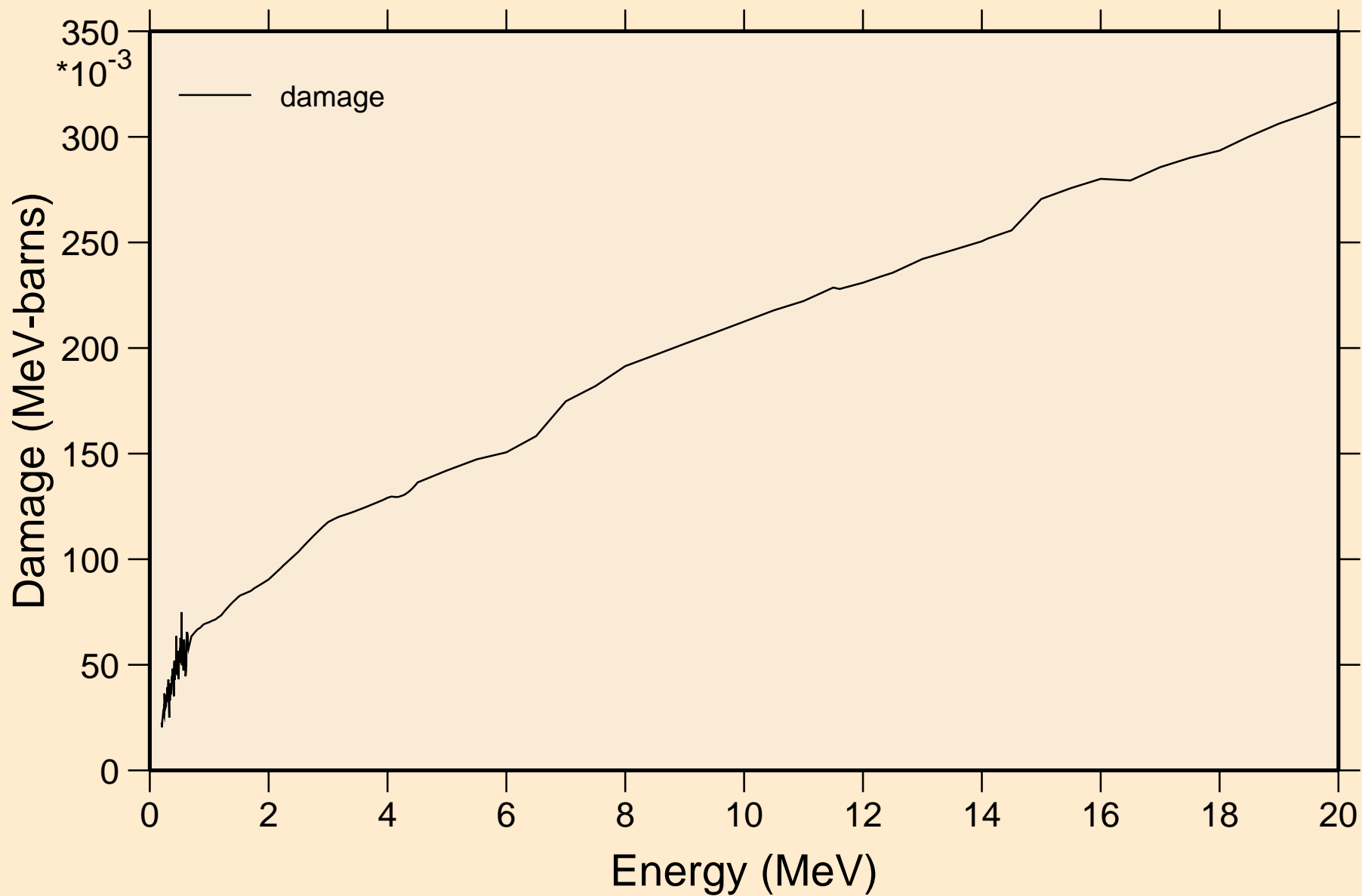

MAT=3925 ACE FILE PRODUCED AT NEA WITH NDEC  
Non-threshold reactions

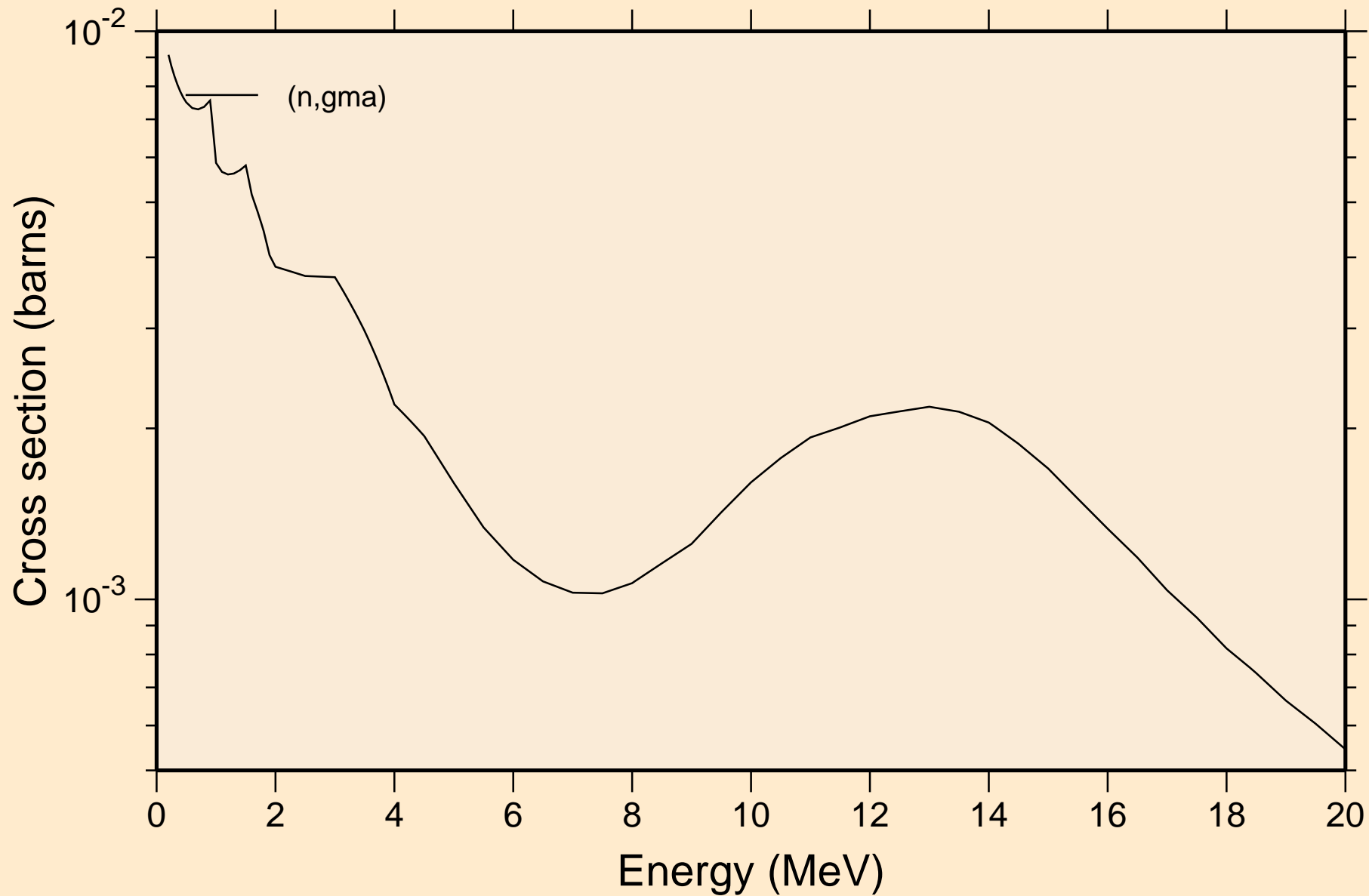



MAT=3925 ACE FILE PRODUCED AT NEA WITH NDEC  
Inelastic levels

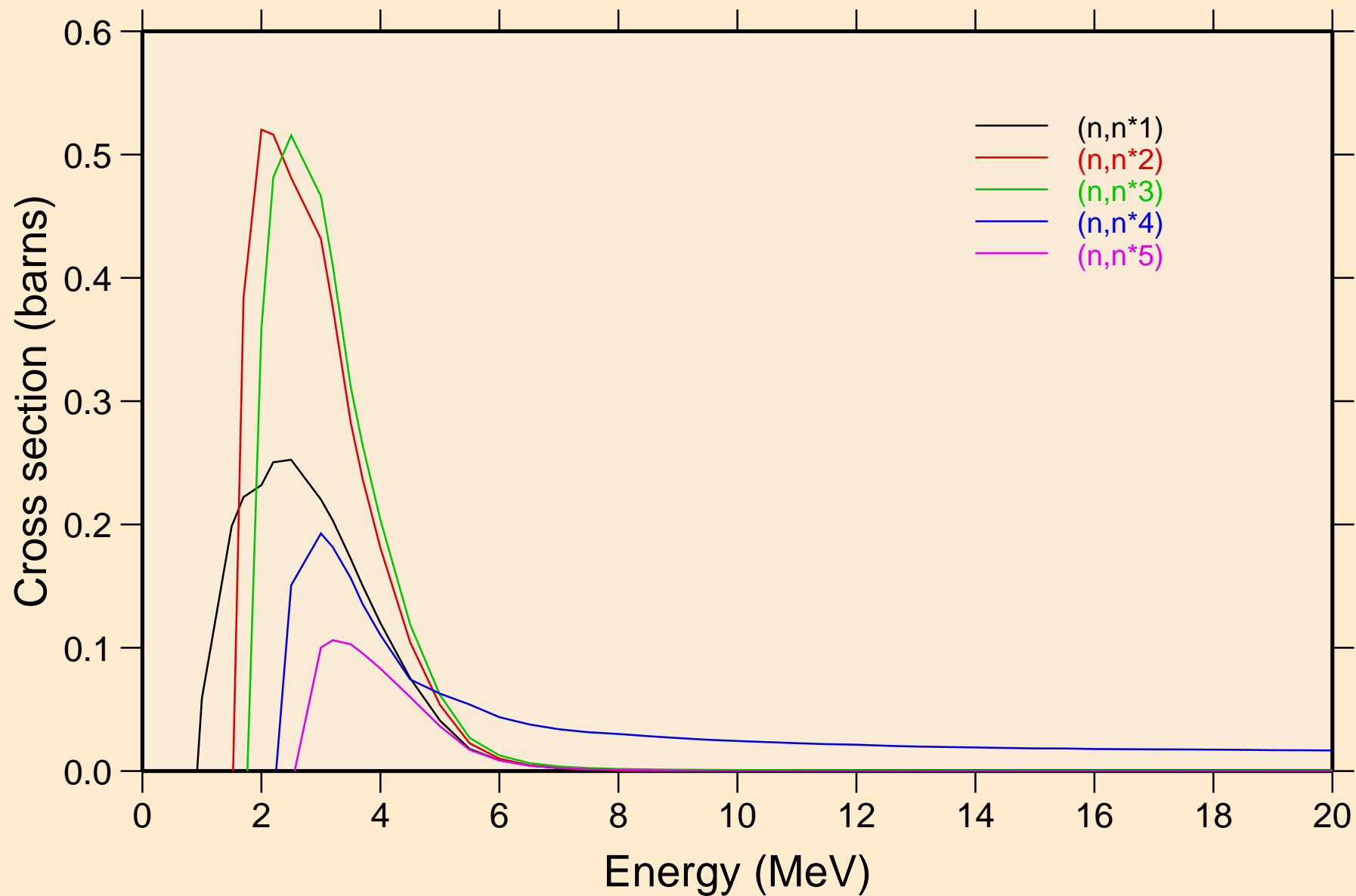

MAT=3925 ACE FILE PRODUCED AT NEA WITH NDEC  
Inelastic levels

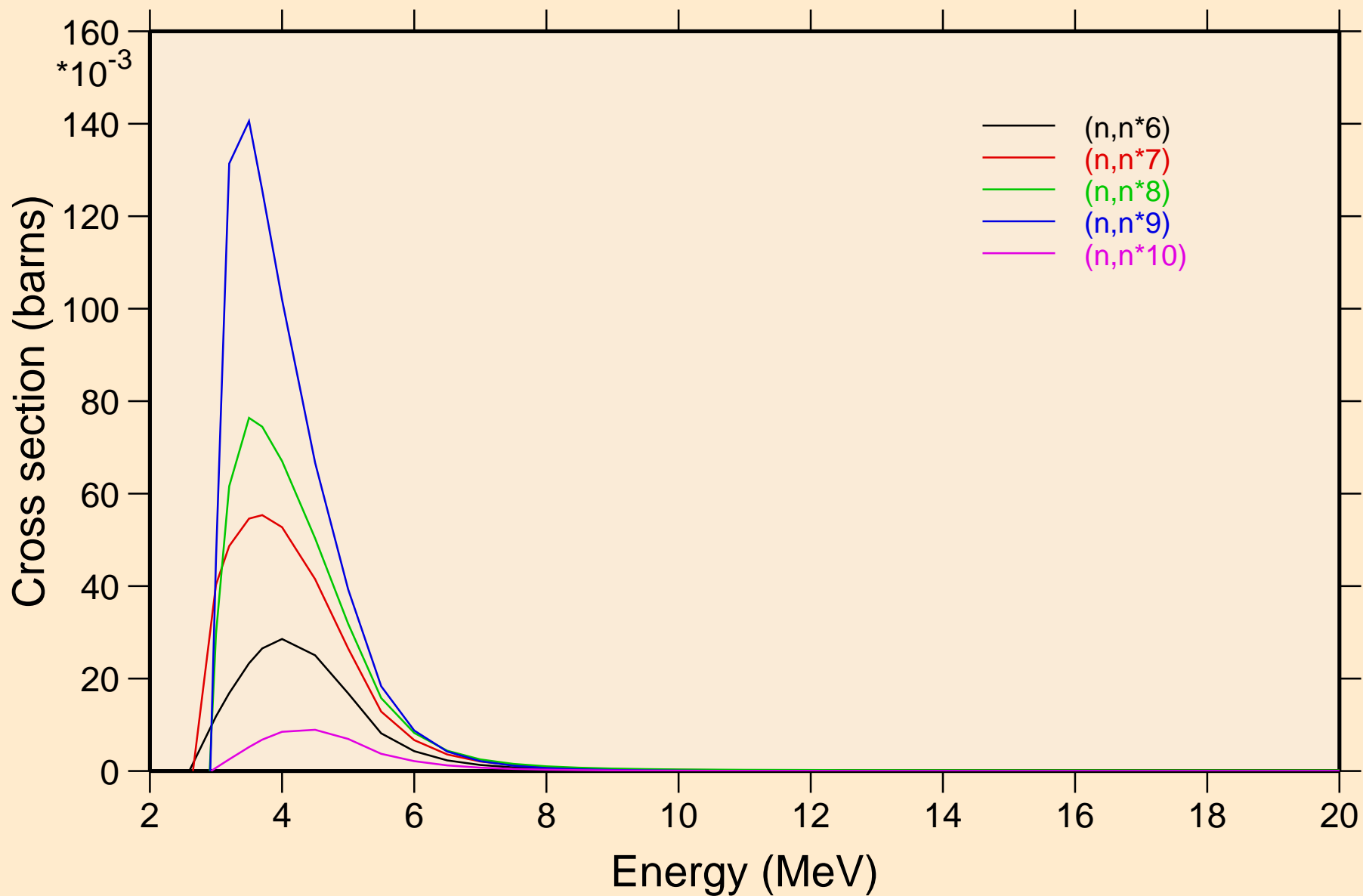

MAT=3925 ACE FILE PRODUCED AT NEA WITH NDEC  
Inelastic levels

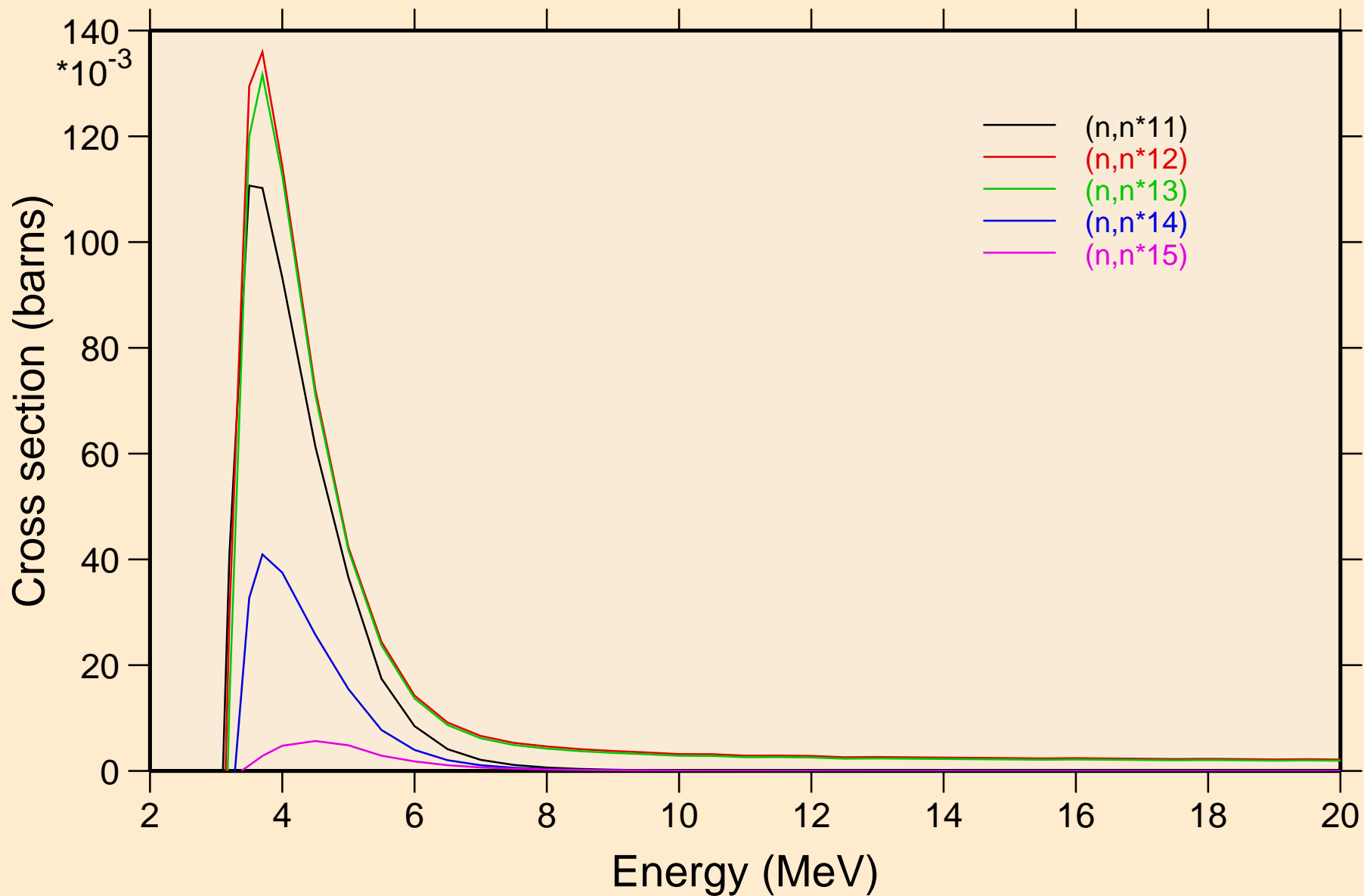

MAT=3925 ACE FILE PRODUCED AT NEA WITH NDEC  
Inelastic levels

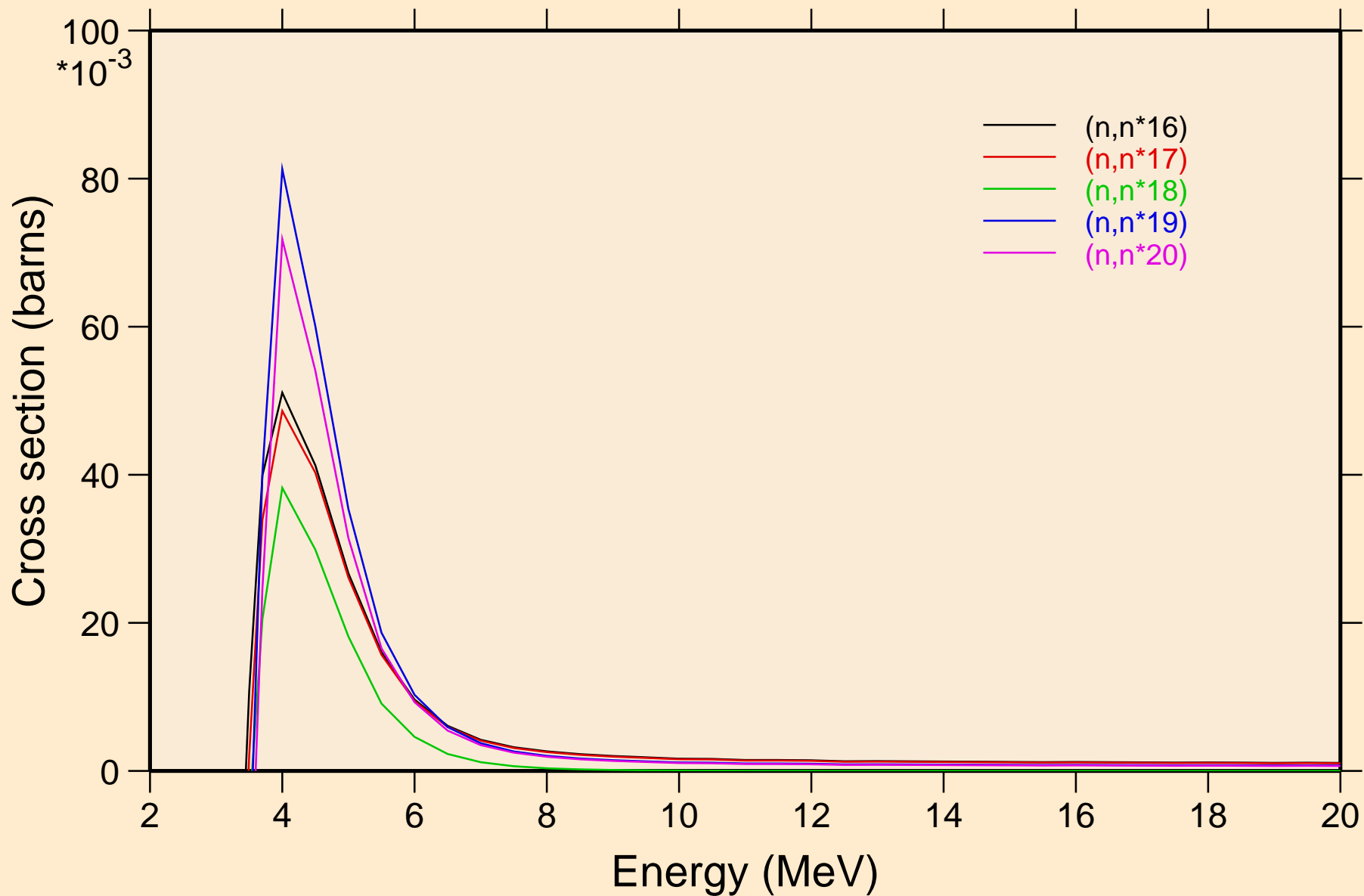

MAT=3925 ACE FILE PRODUCED AT NEA WITH NDEC  
Inelastic levels

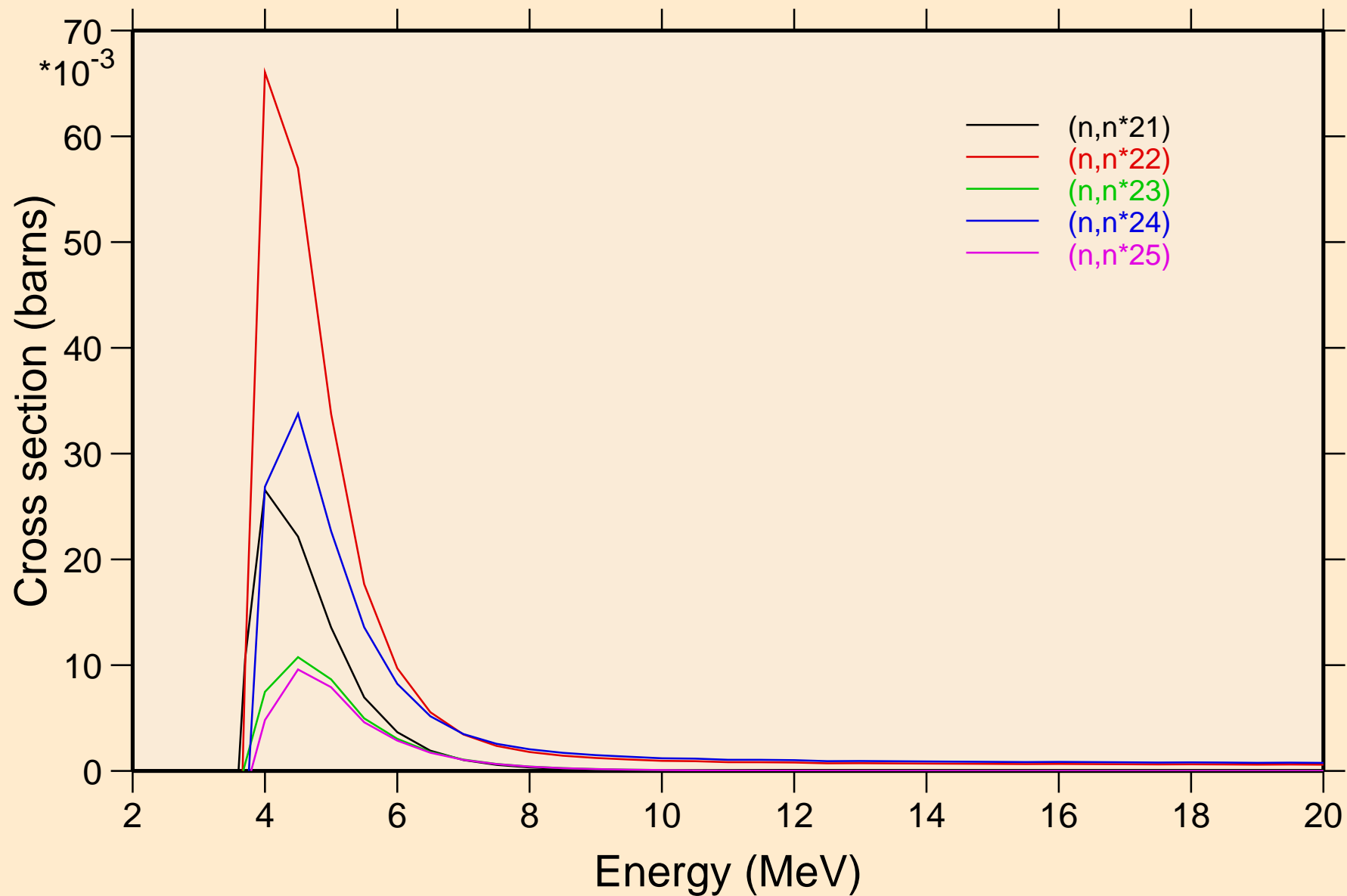

MAT=3925 ACE FILE PRODUCED AT NEA WITH NDEC  
Inelastic levels

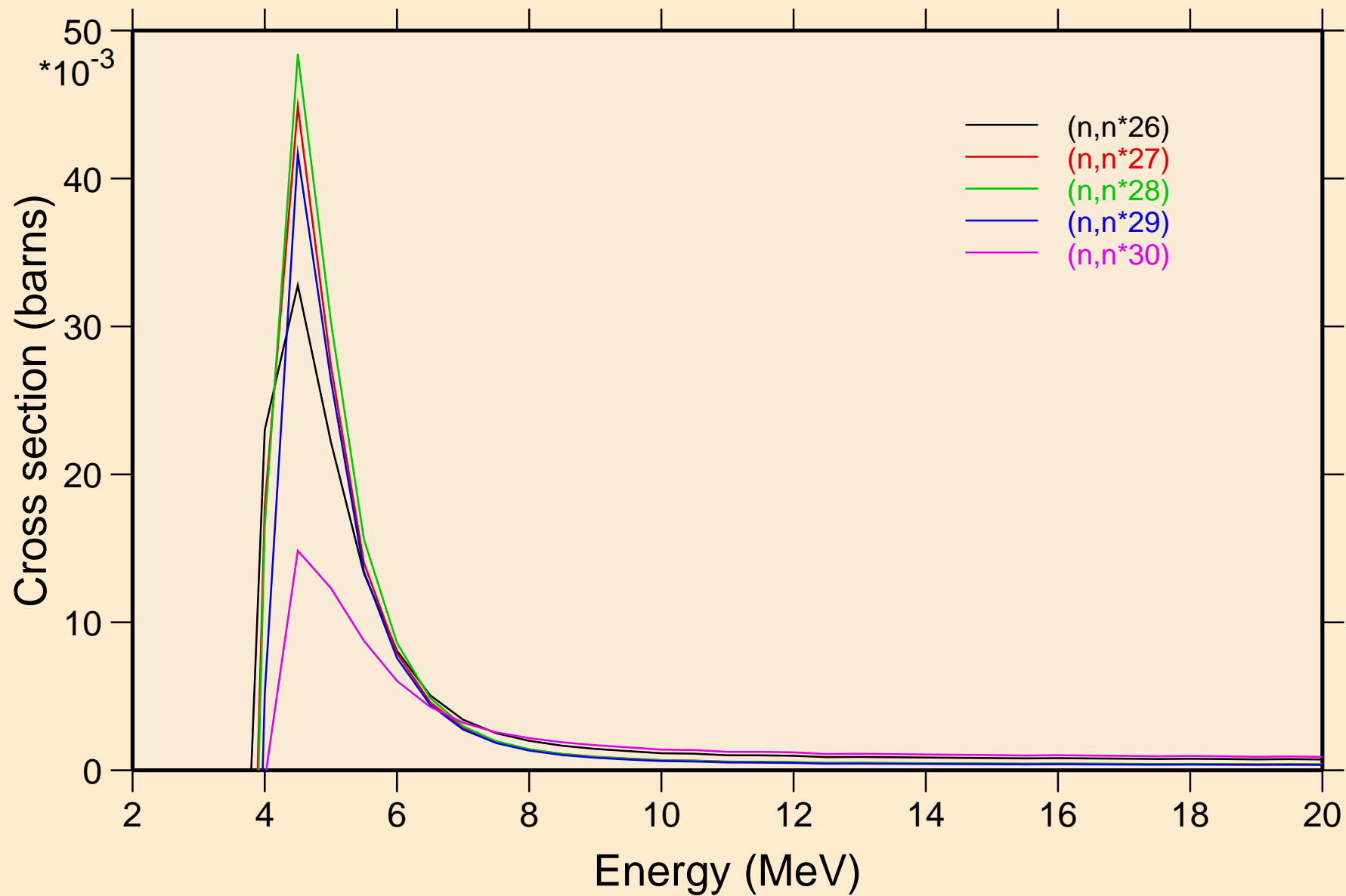

MAT=3925 ACE FILE PRODUCED AT NEA WITH NDEC  
Inelastic levels

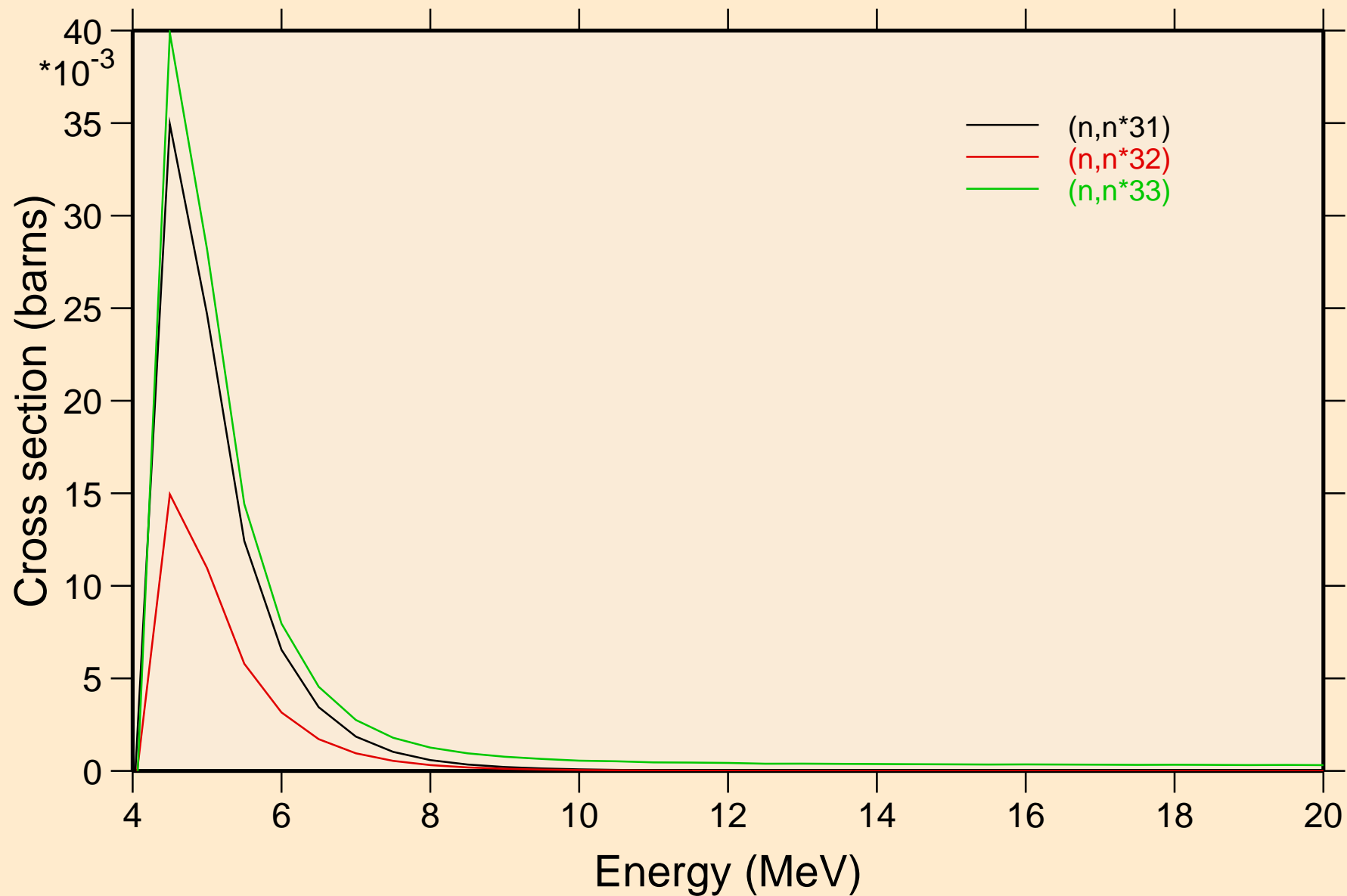

MAT=3925 ACE FILE PRODUCED AT NEA WITH NDEC  
Threshold reactions

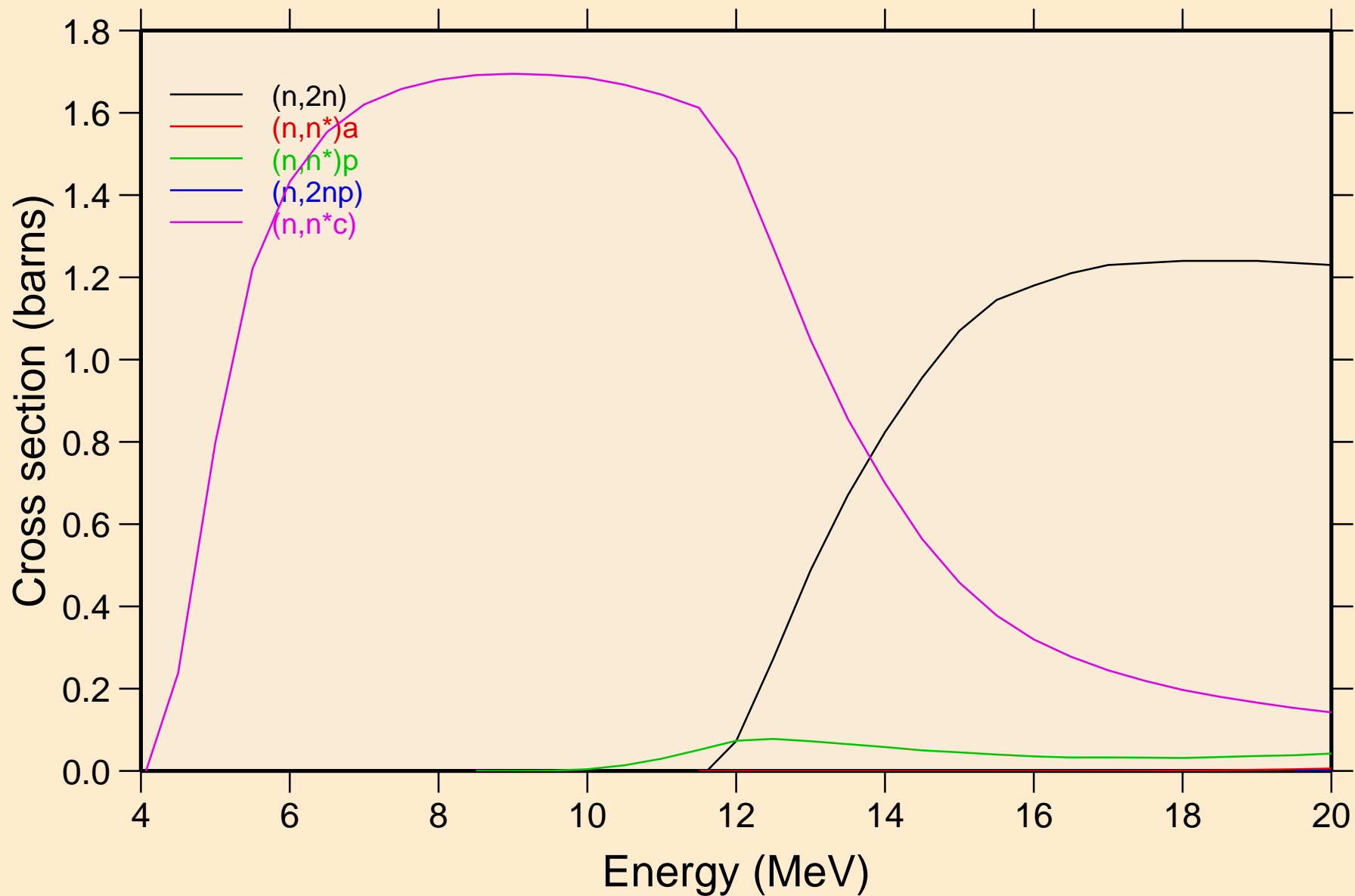



MAT=3925 ACE FILE PRODUCED AT NEA WITH NDEC  
Threshold reactions

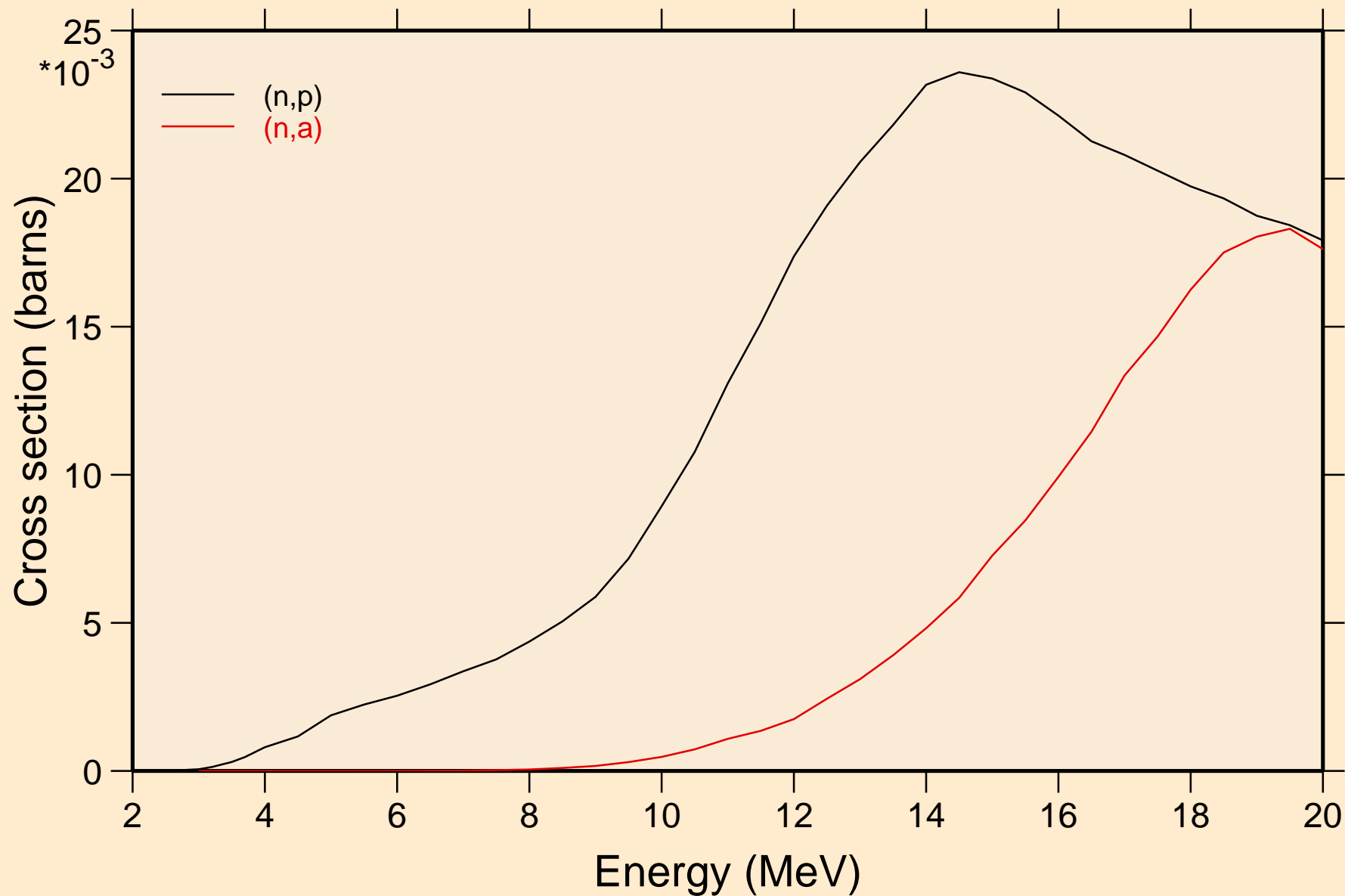

MAT=3925 ACE FILE PRODUCED AT NEA WITH NDEC  
Threshold reactions

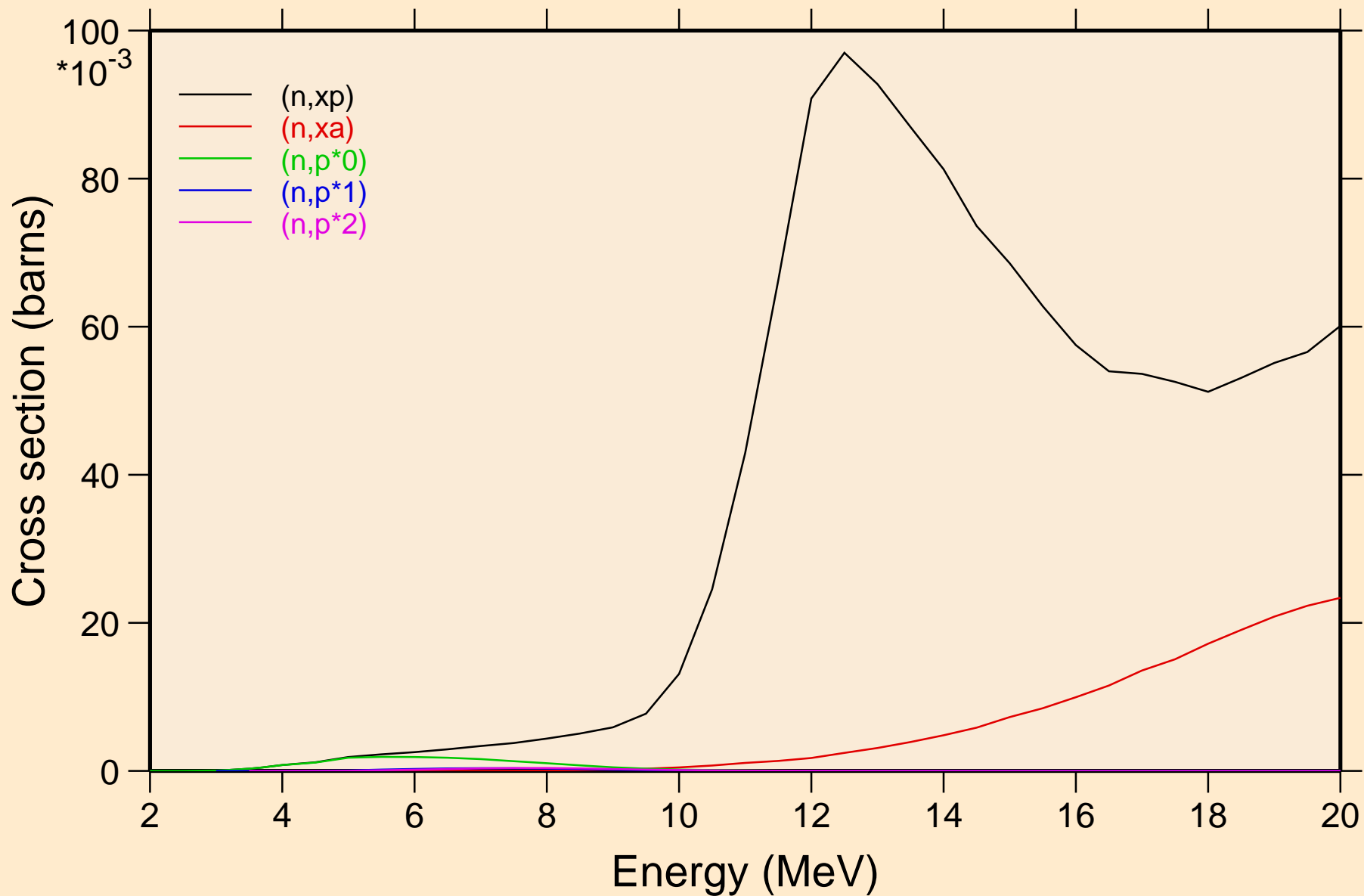

MAT=3925 ACE FILE PRODUCED AT NEA WITH NDEC  
Threshold reactions

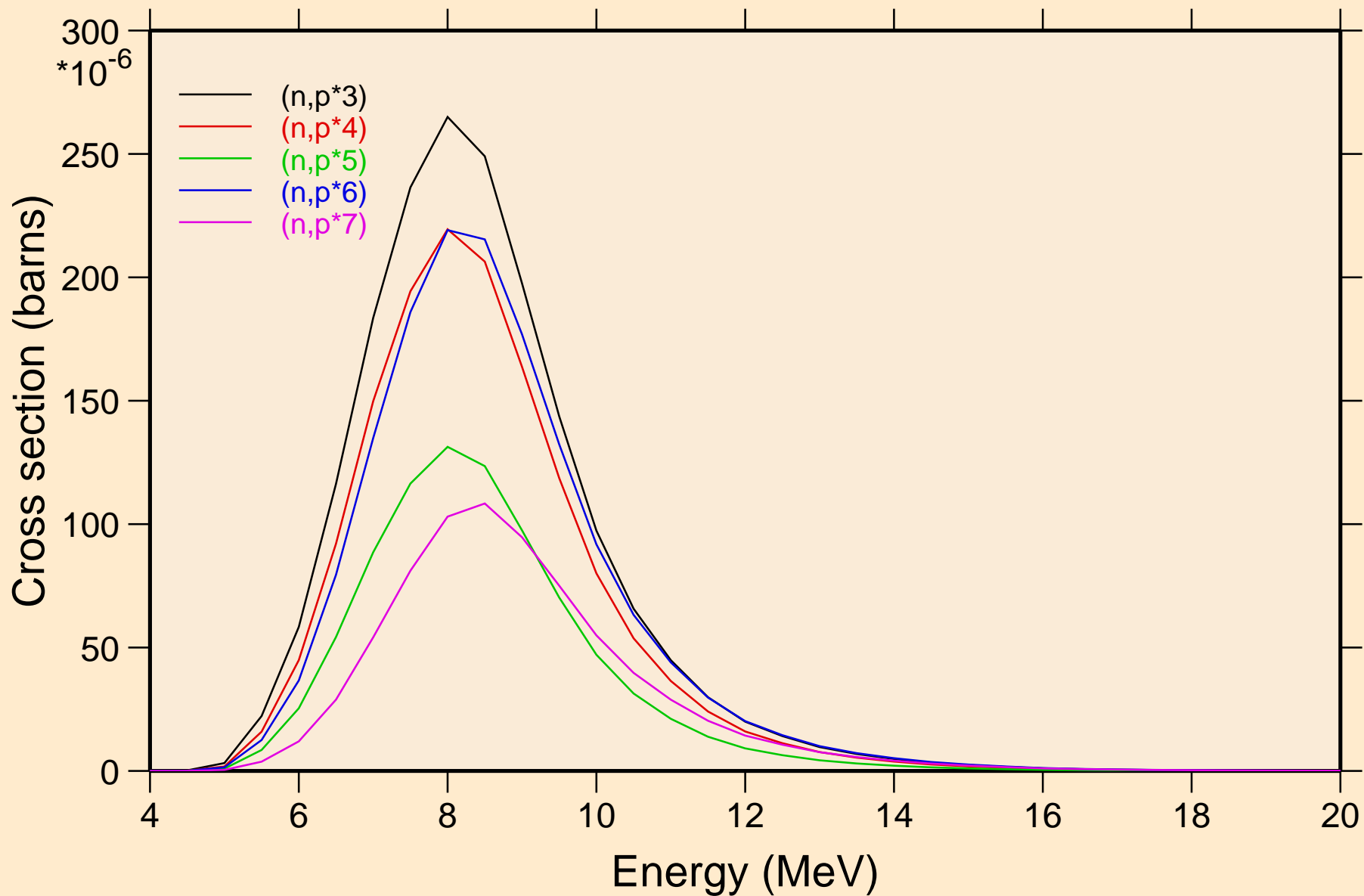

MAT=3925 ACE FILE PRODUCED AT NEA WITH NDEC  
Threshold reactions

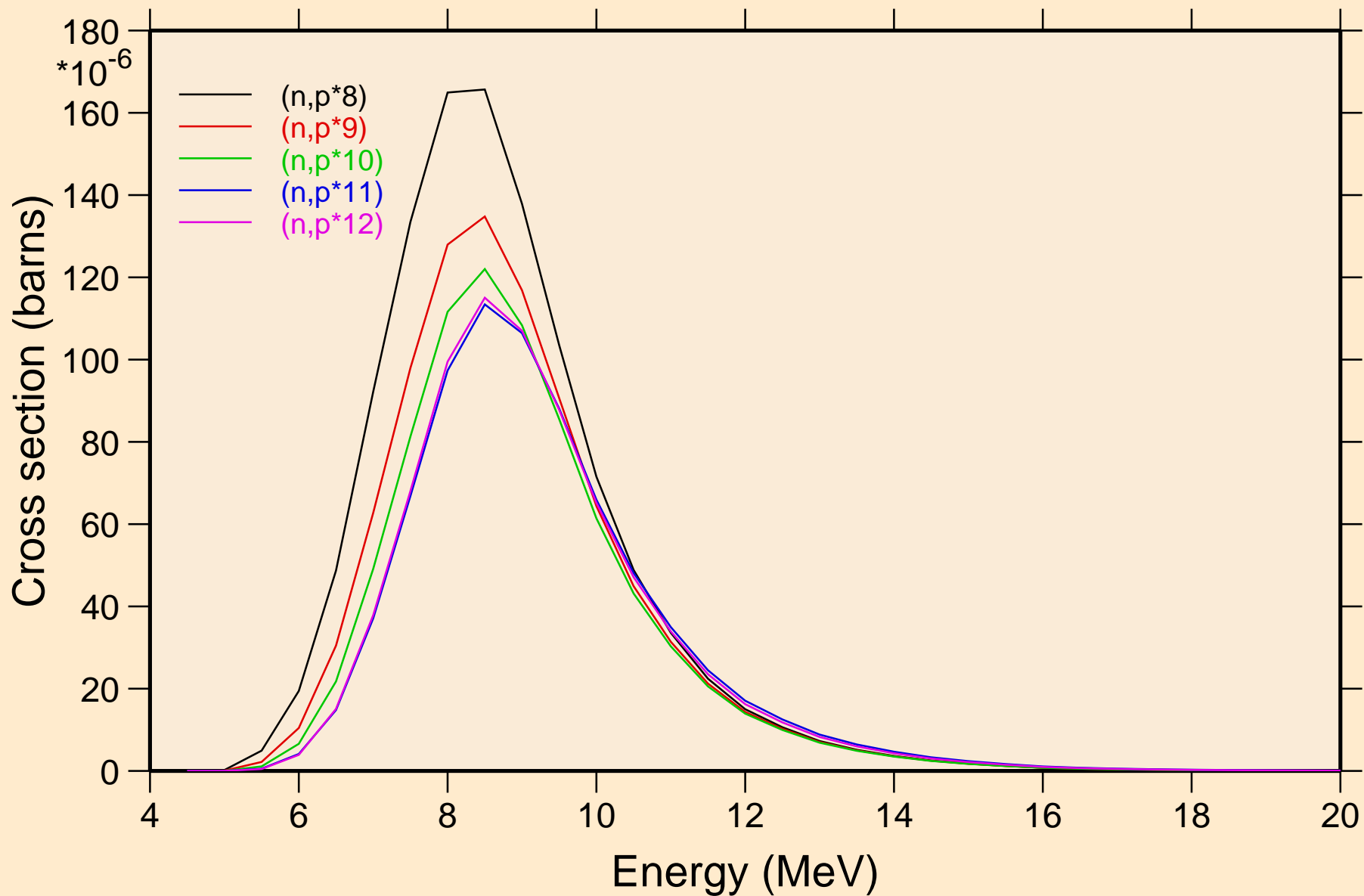

MAT=3925 ACE FILE PRODUCED AT NEA WITH NDEC  
Threshold reactions

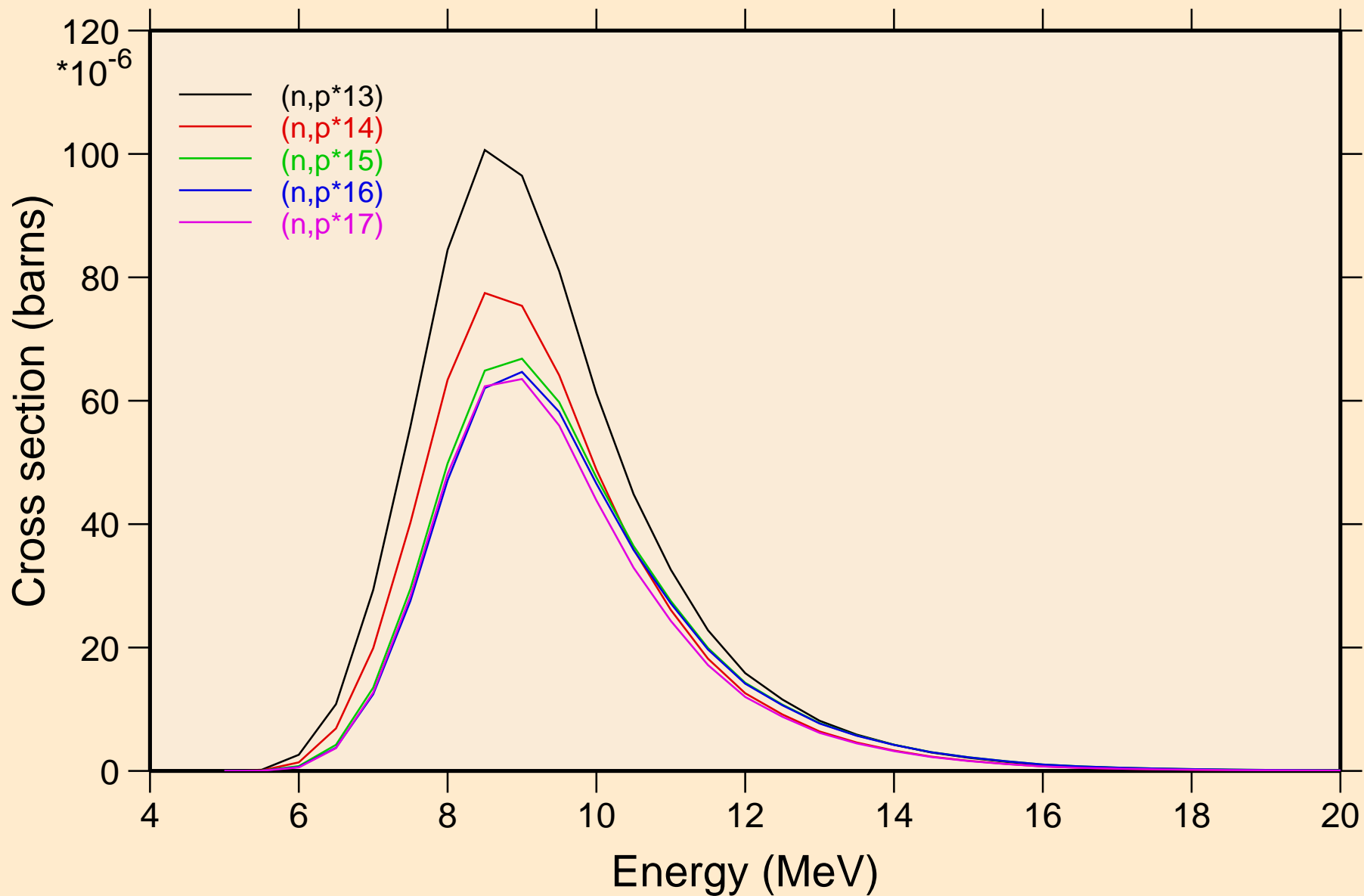

MAT=3925 ACE FILE PRODUCED AT NEA WITH NDEC  
Threshold reactions

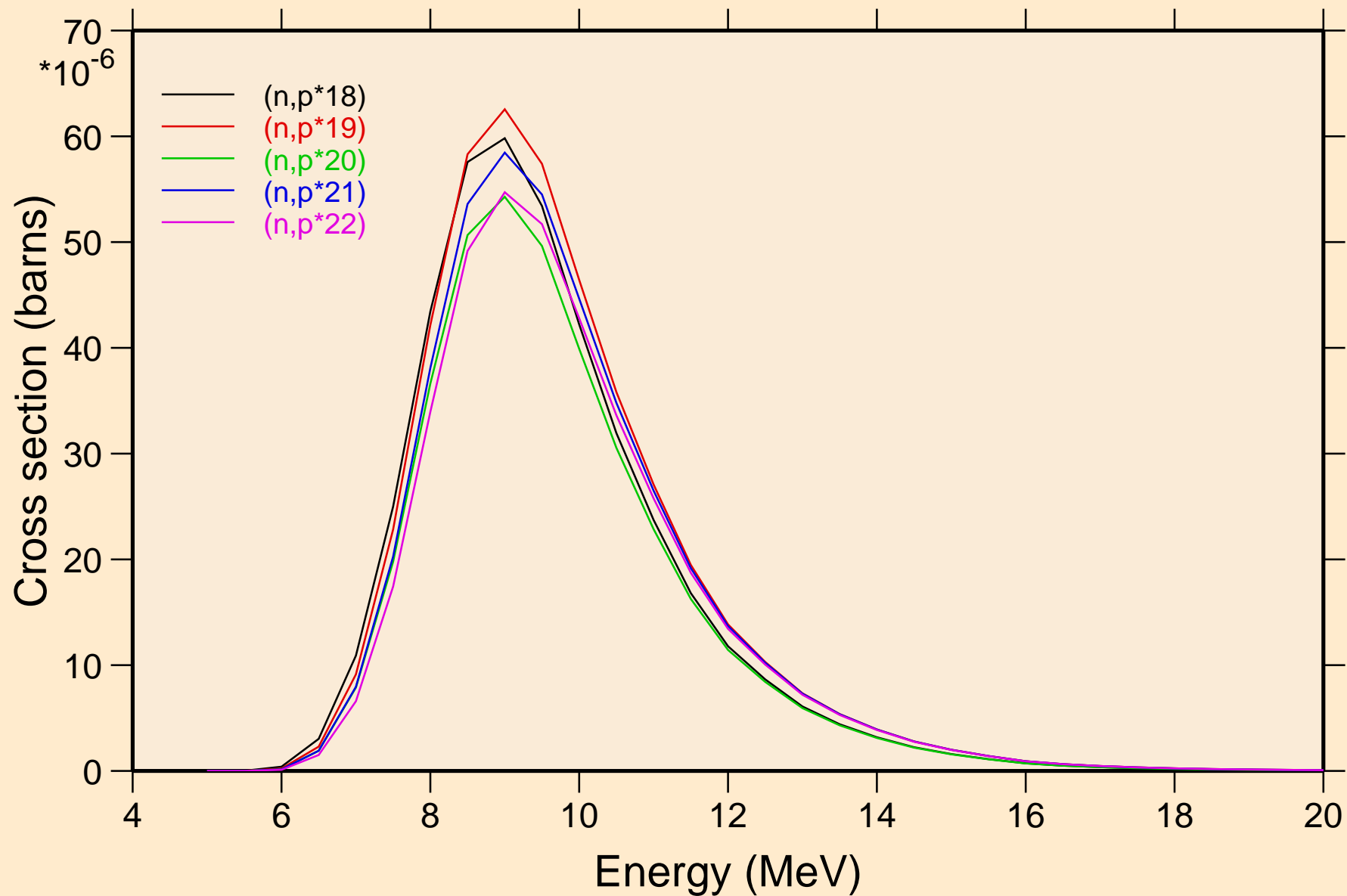

MAT=3925 ACE FILE PRODUCED AT NEA WITH NDEC  
Threshold reactions

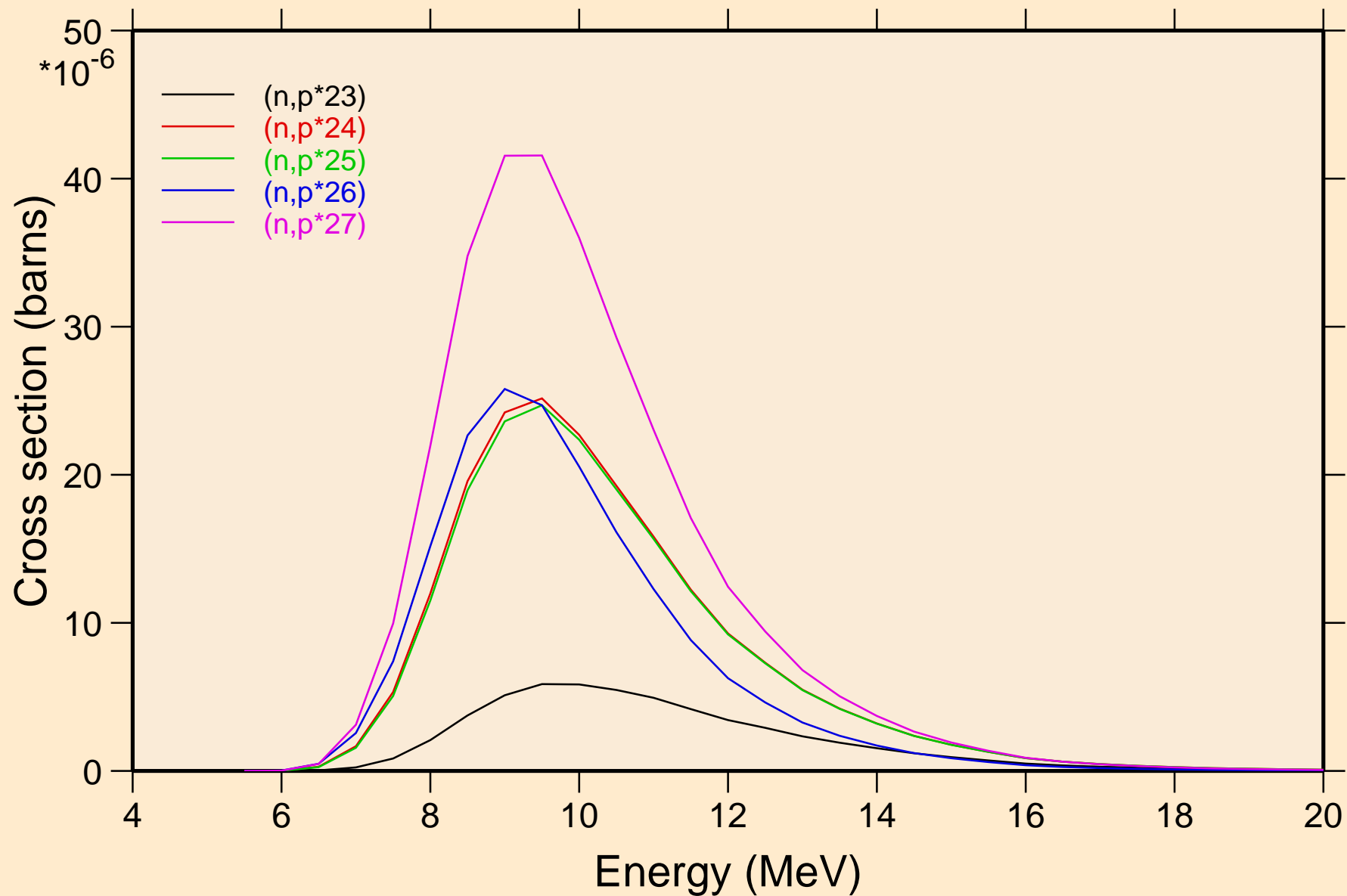

MAT=3925 ACE FILE PRODUCED AT NEA WITH NDEC  
Threshold reactions

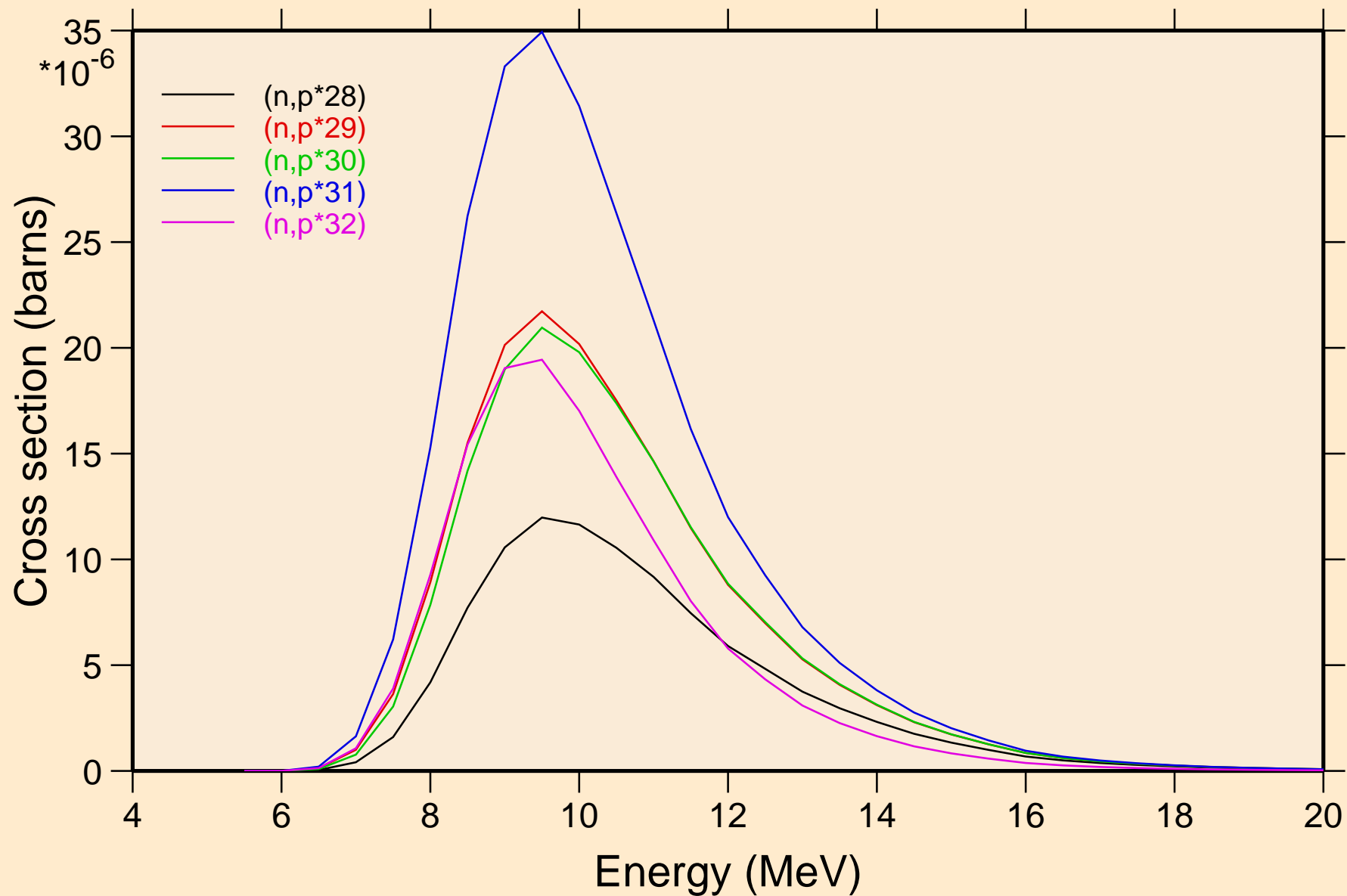



MAT=3925 ACE FILE PRODUCED AT NEA WITH NDEC  
Threshold reactions

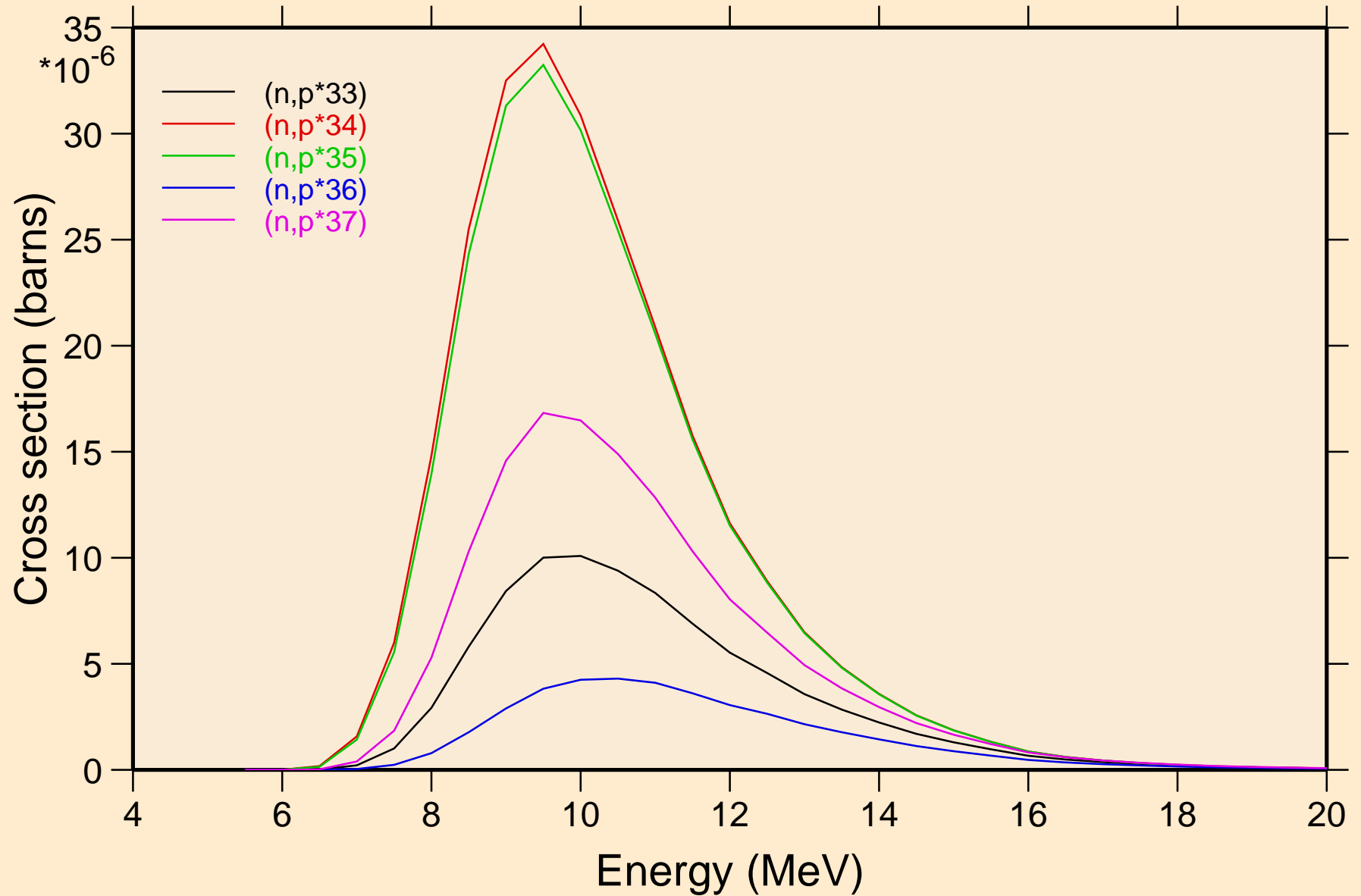

MAT=3925 ACE FILE PRODUCED AT NEA WITH NDEC  
Threshold reactions

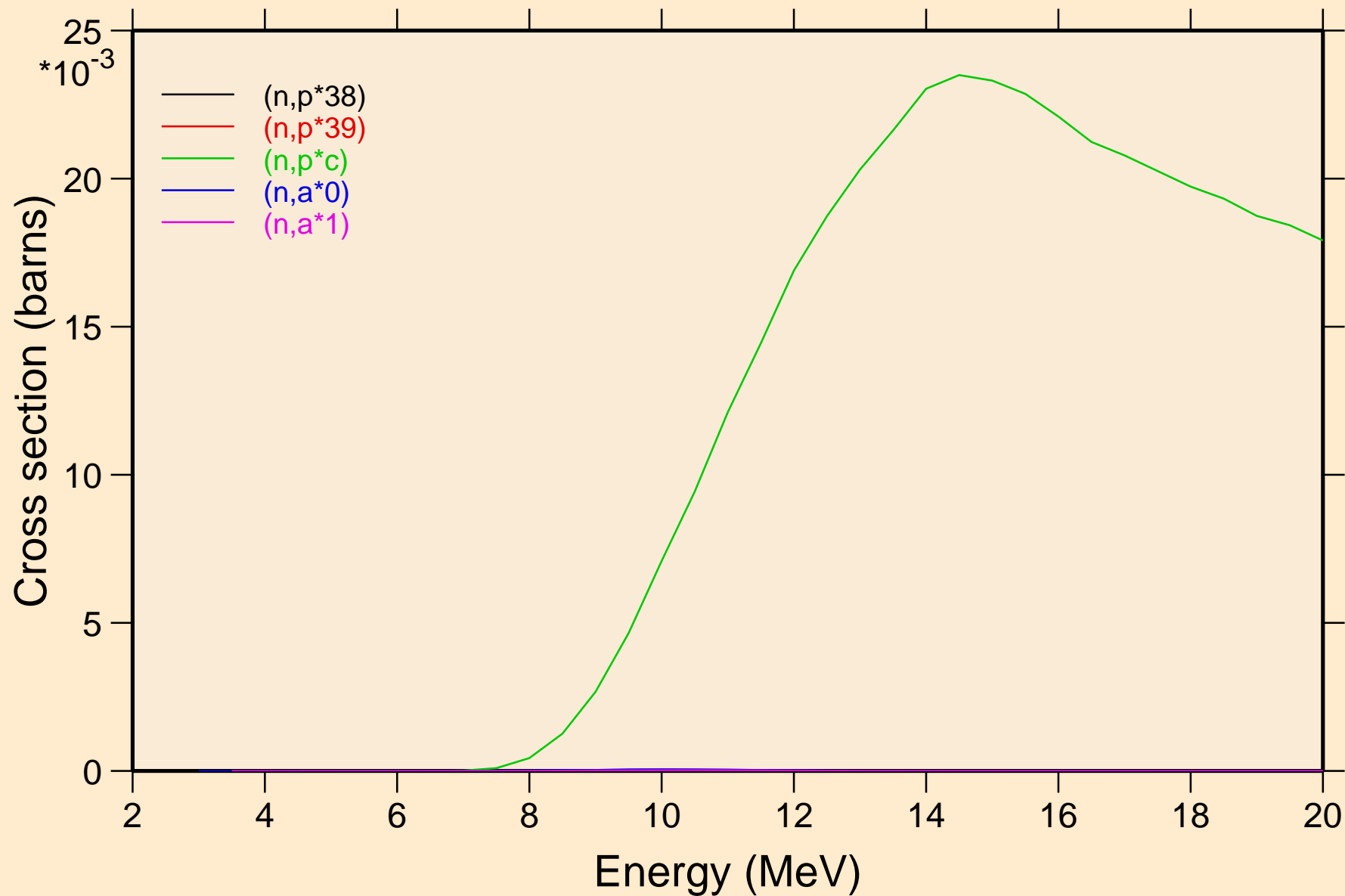

MAT=3925 ACE FILE PRODUCED AT NEA WITH NDEC  
Threshold reactions

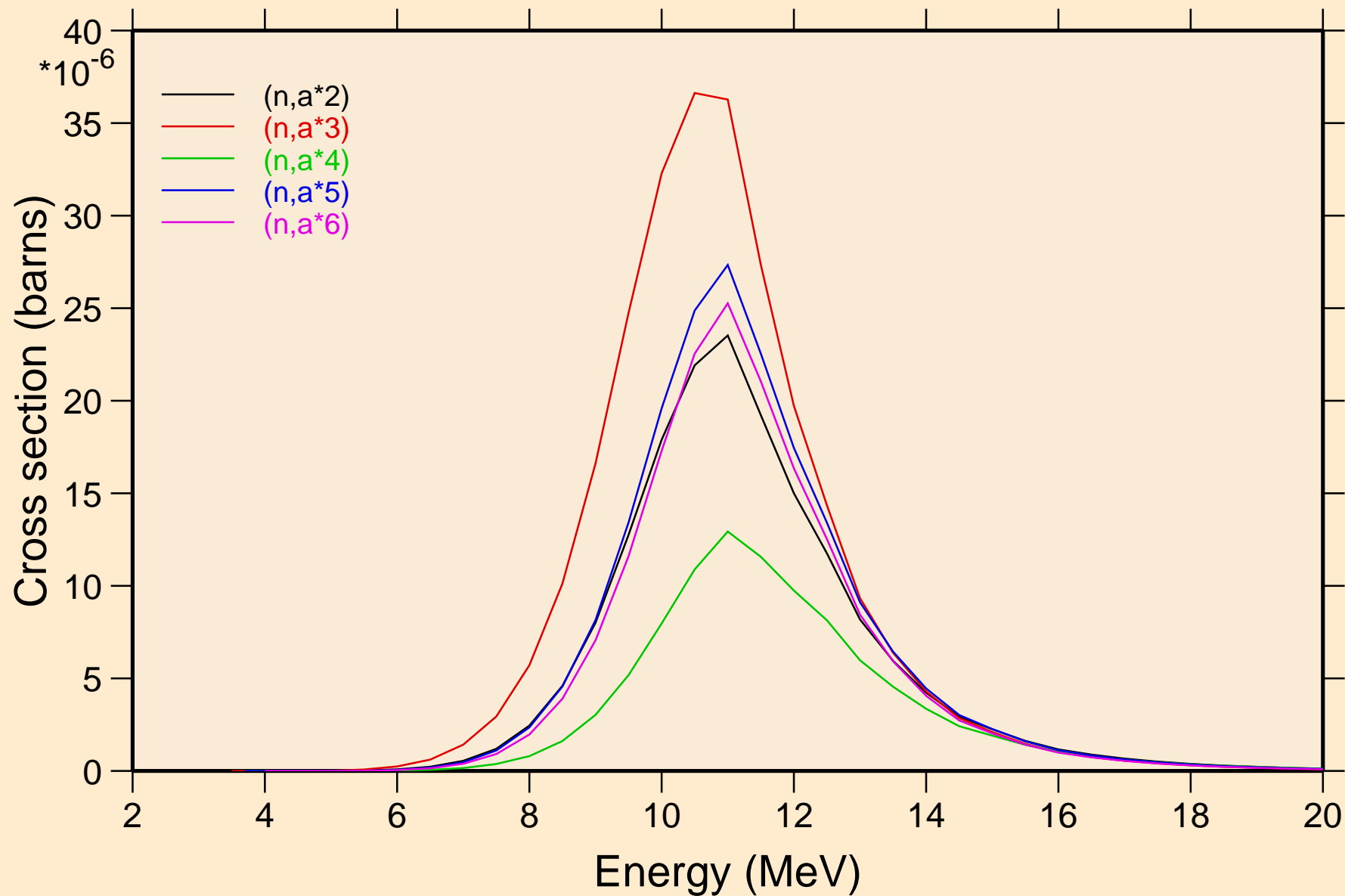

MAT=3925 ACE FILE PRODUCED AT NEA WITH NDEC  
Threshold reactions

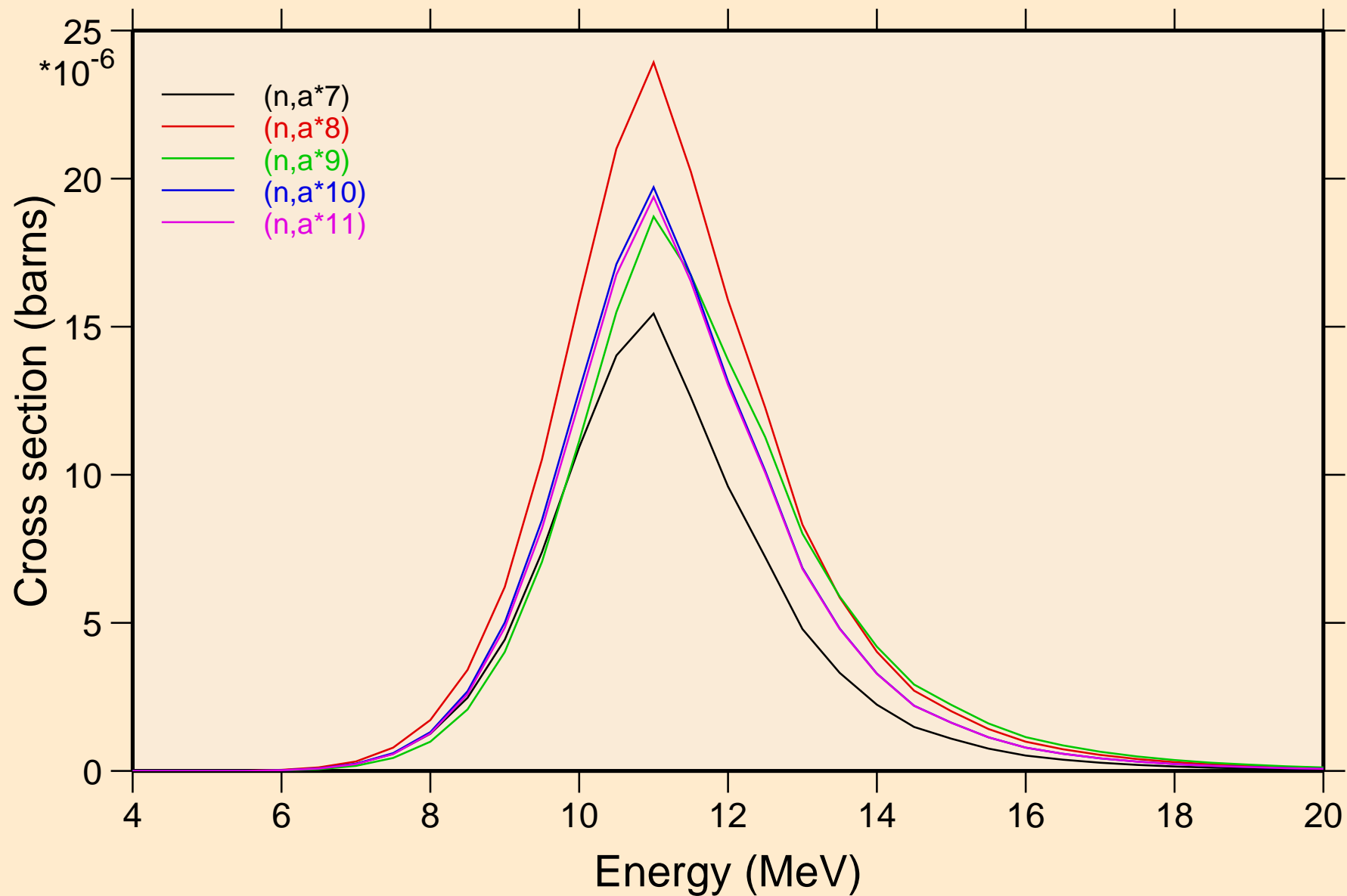

MAT=3925 ACE FILE PRODUCED AT NEA WITH NDEC  
Threshold reactions

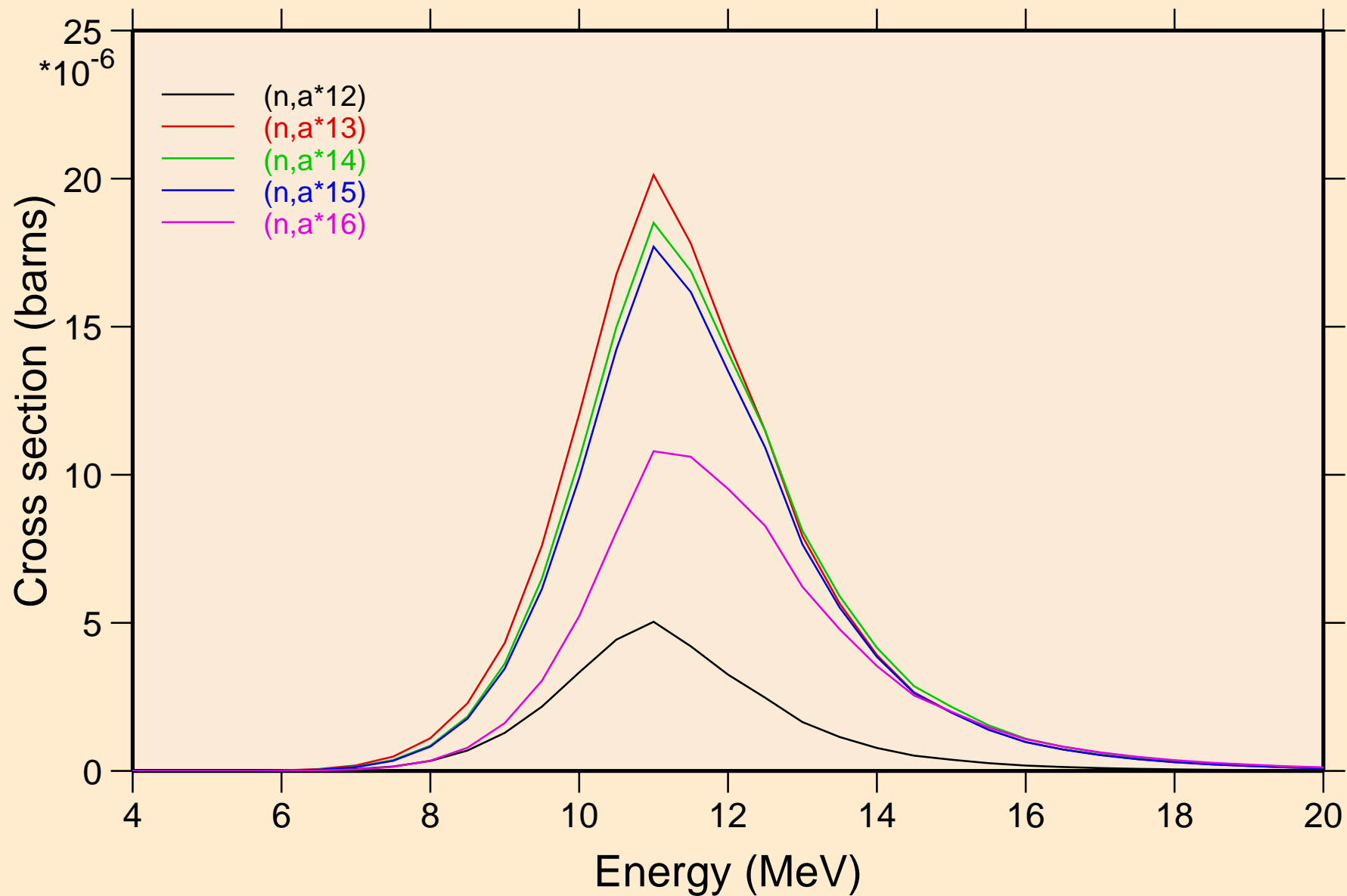

MAT=3925 ACE FILE PRODUCED AT NEA WITH NDEC  
Threshold reactions

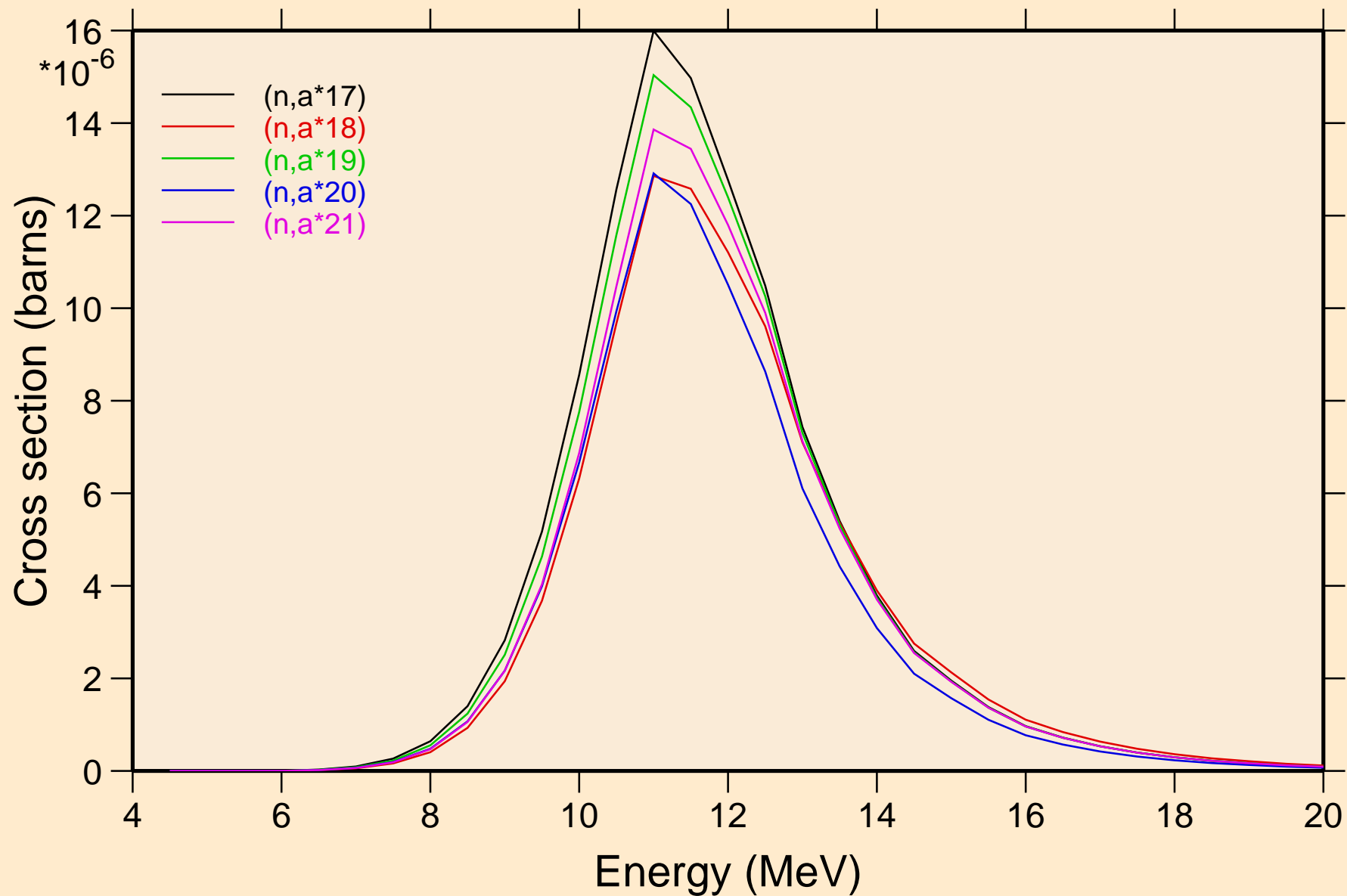

MAT=3925 ACE FILE PRODUCED AT NEA WITH NDEC  
Threshold reactions

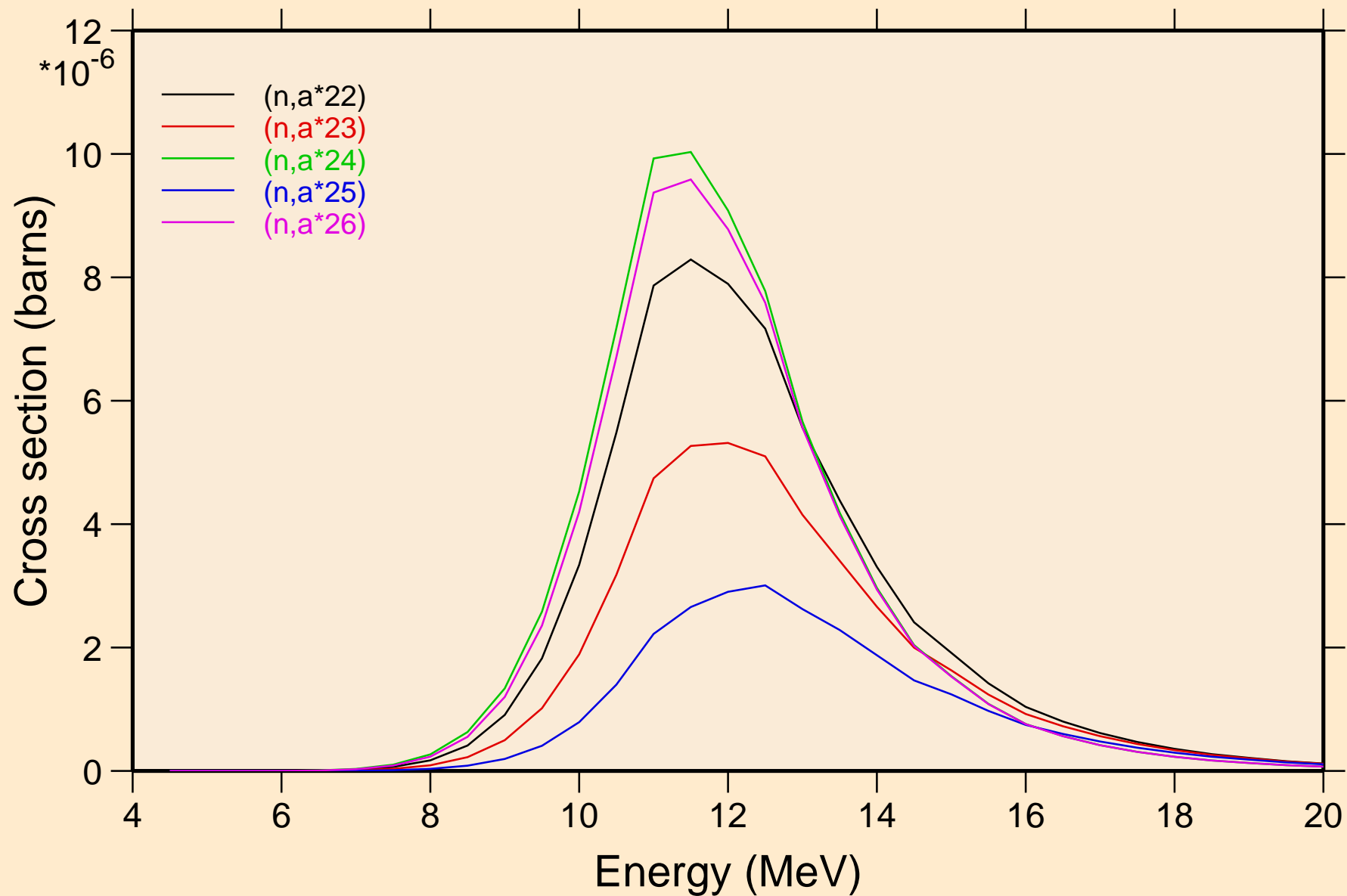

MAT=3925 ACE FILE PRODUCED AT NEA WITH NDEC  
Threshold reactions

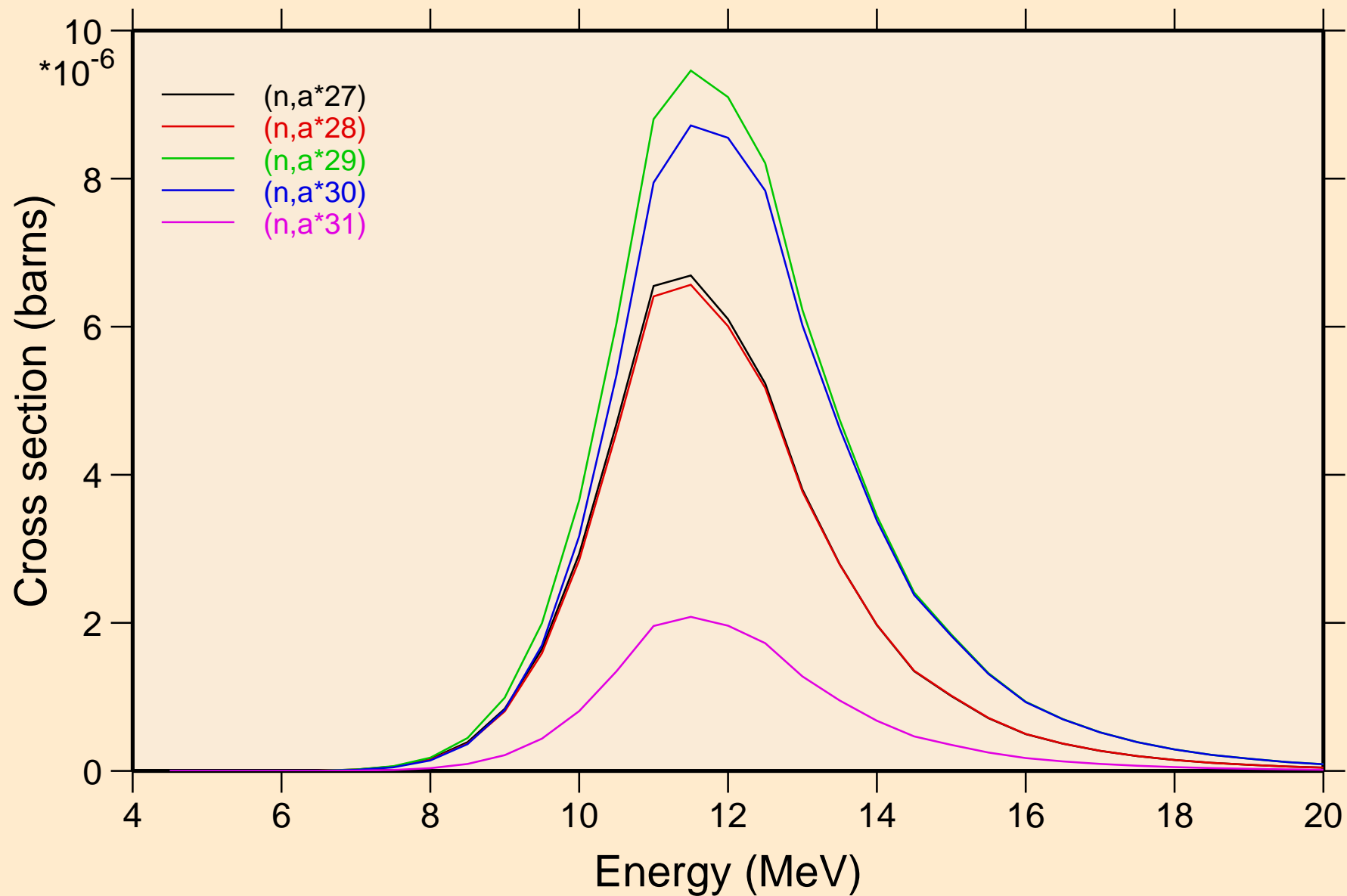



MAT=3925 ACE FILE PRODUCED AT NEA WITH NDEC  
Threshold reactions

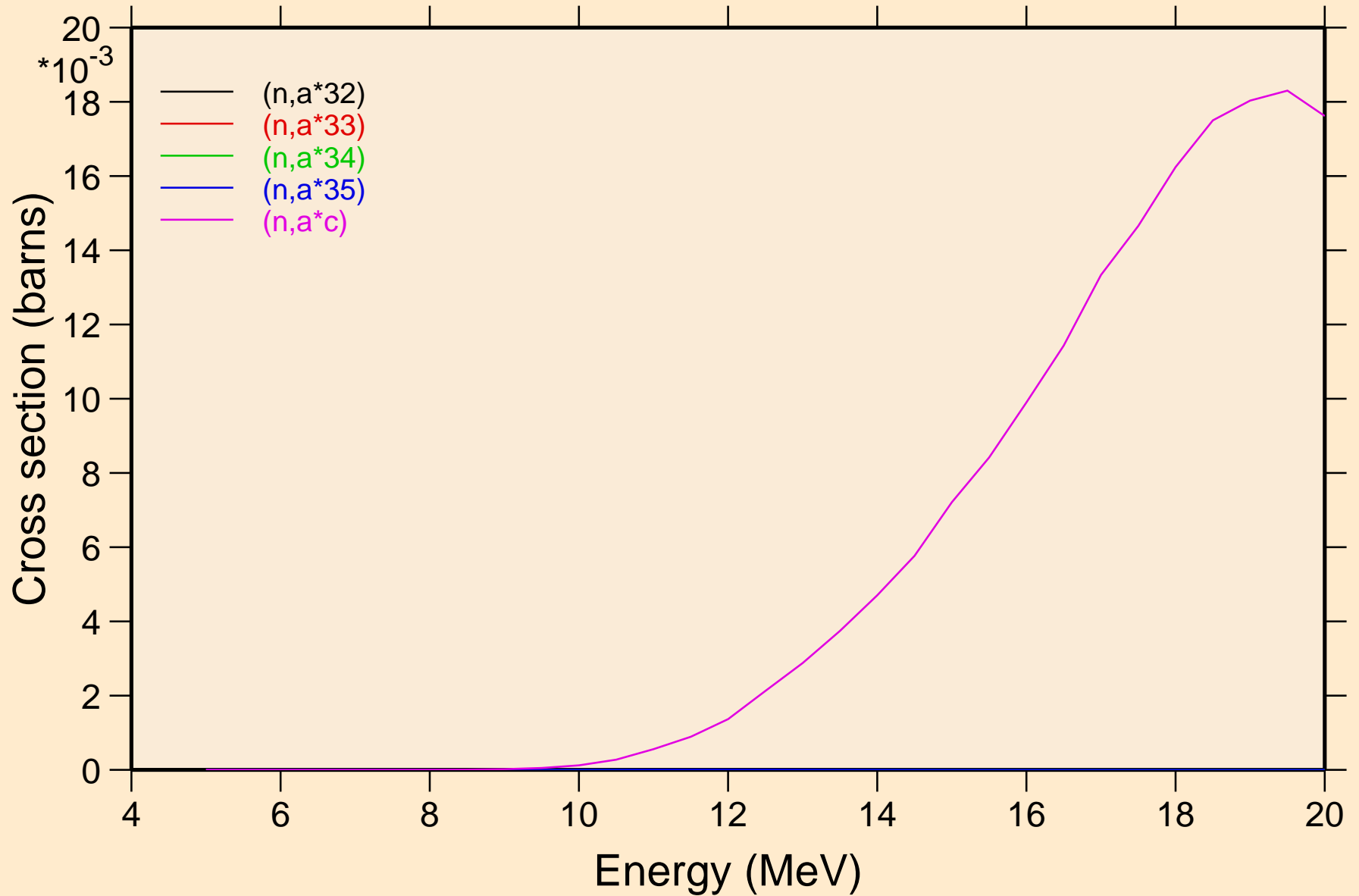

MAT=3925 ACE FILE PRODUCED AT NEA WITH NDEC  
angular distribution for elastic

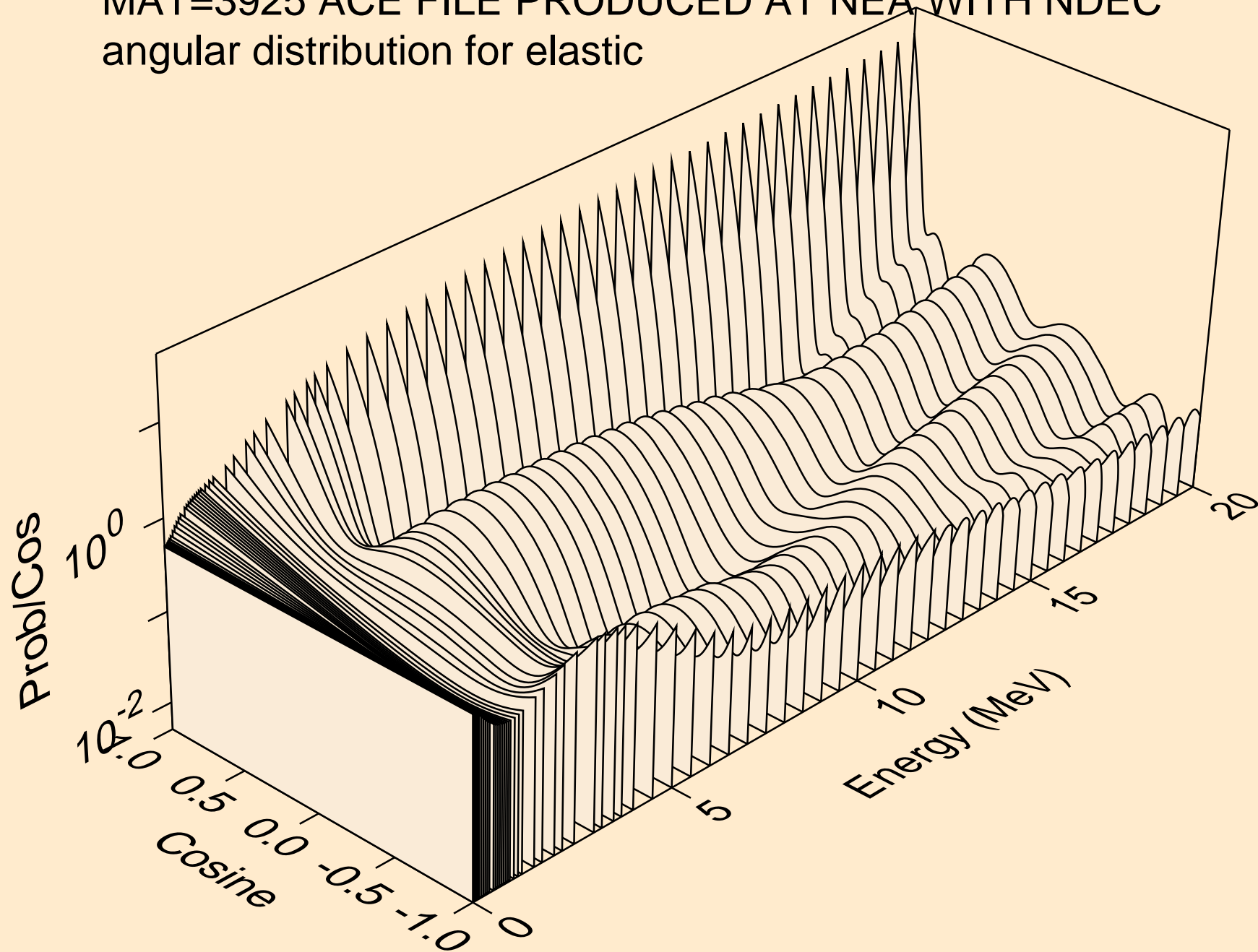

MAT=3925 ACE FILE PRODUCED AT NEA WITH NDEC  
angular distribution for (n,n\*1)

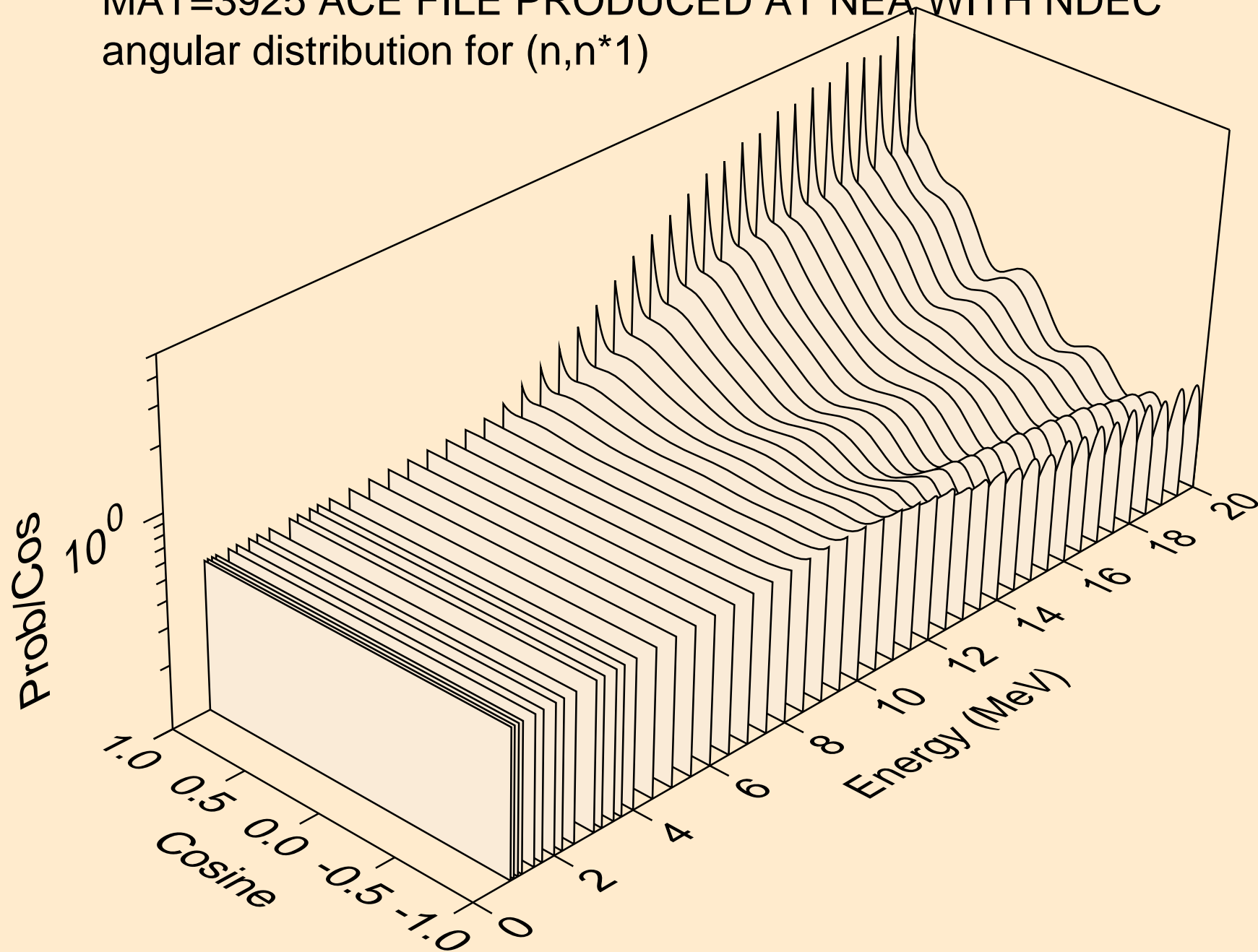

MAT=3925 ACE FILE PRODUCED AT NEA WITH NDEC  
angular distribution for (n,n\*2)

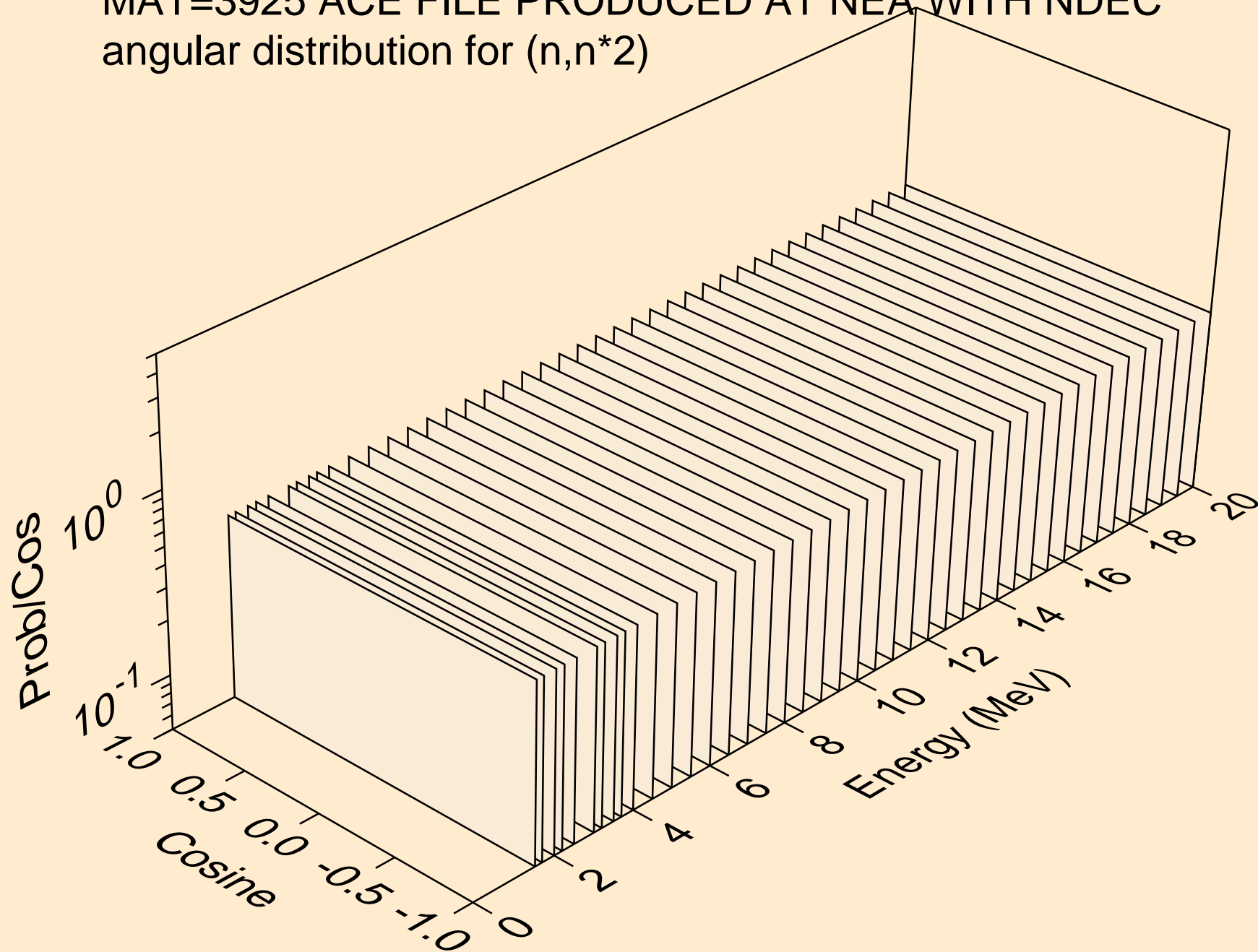

MAT=3925 ACE FILE PRODUCED AT NEA WITH NDEC  
angular distribution for (n,n\*3)

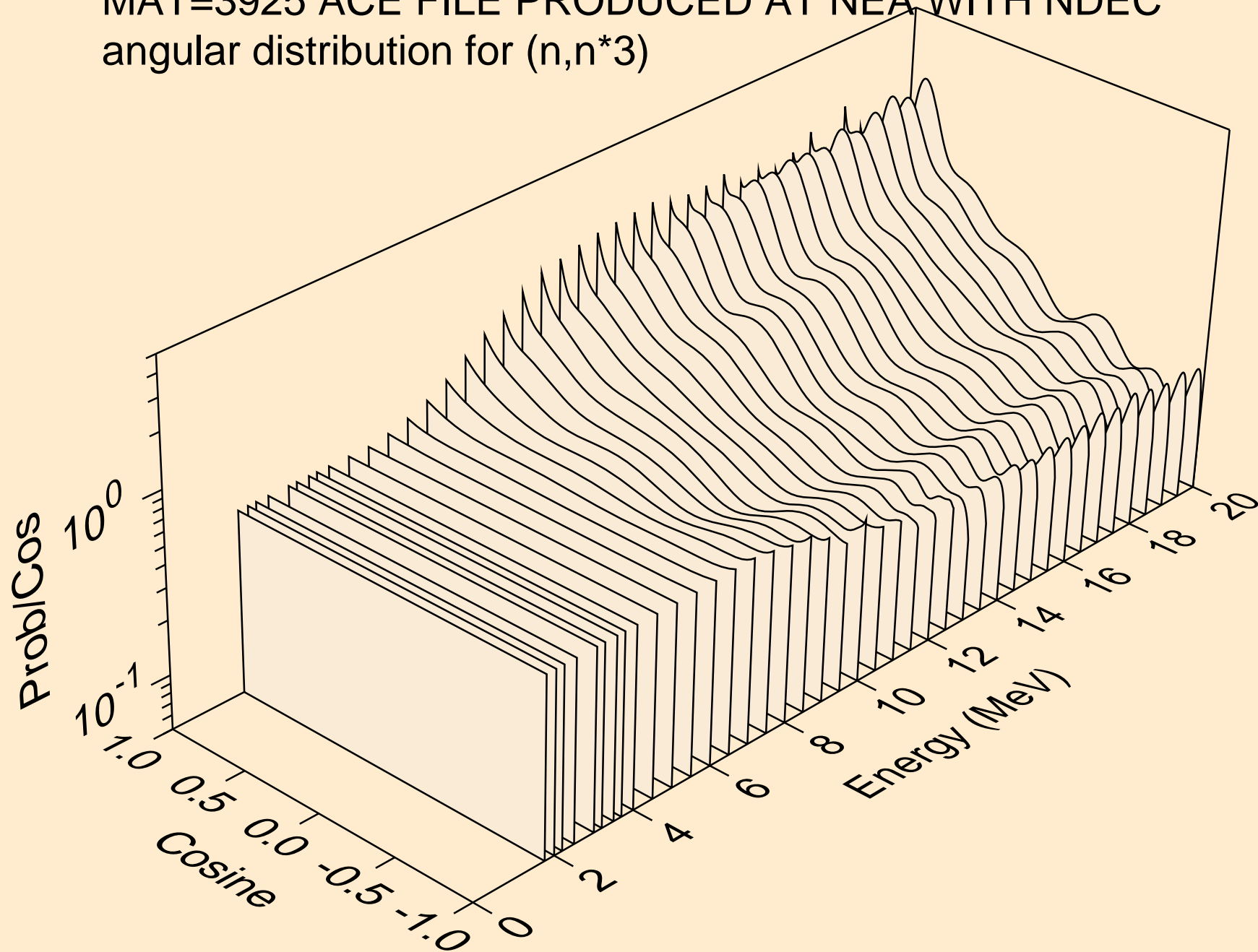

MAT=3925 ACE FILE PRODUCED AT NEA WITH NDEC  
angular distribution for (n,n\*4)

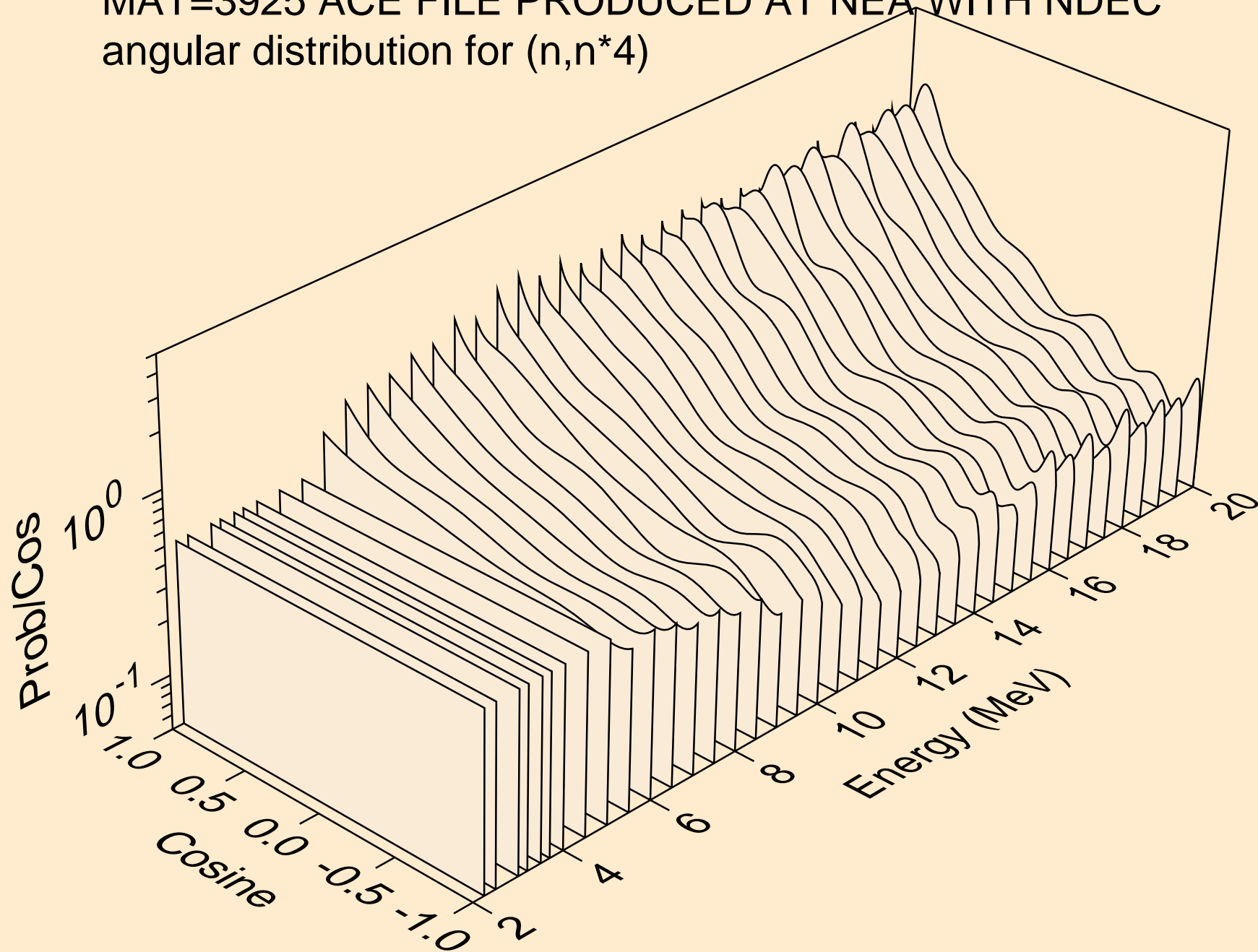

MAT=3925 ACE FILE PRODUCED AT NEA WITH NDEC  
angular distribution for (n,n\*5)

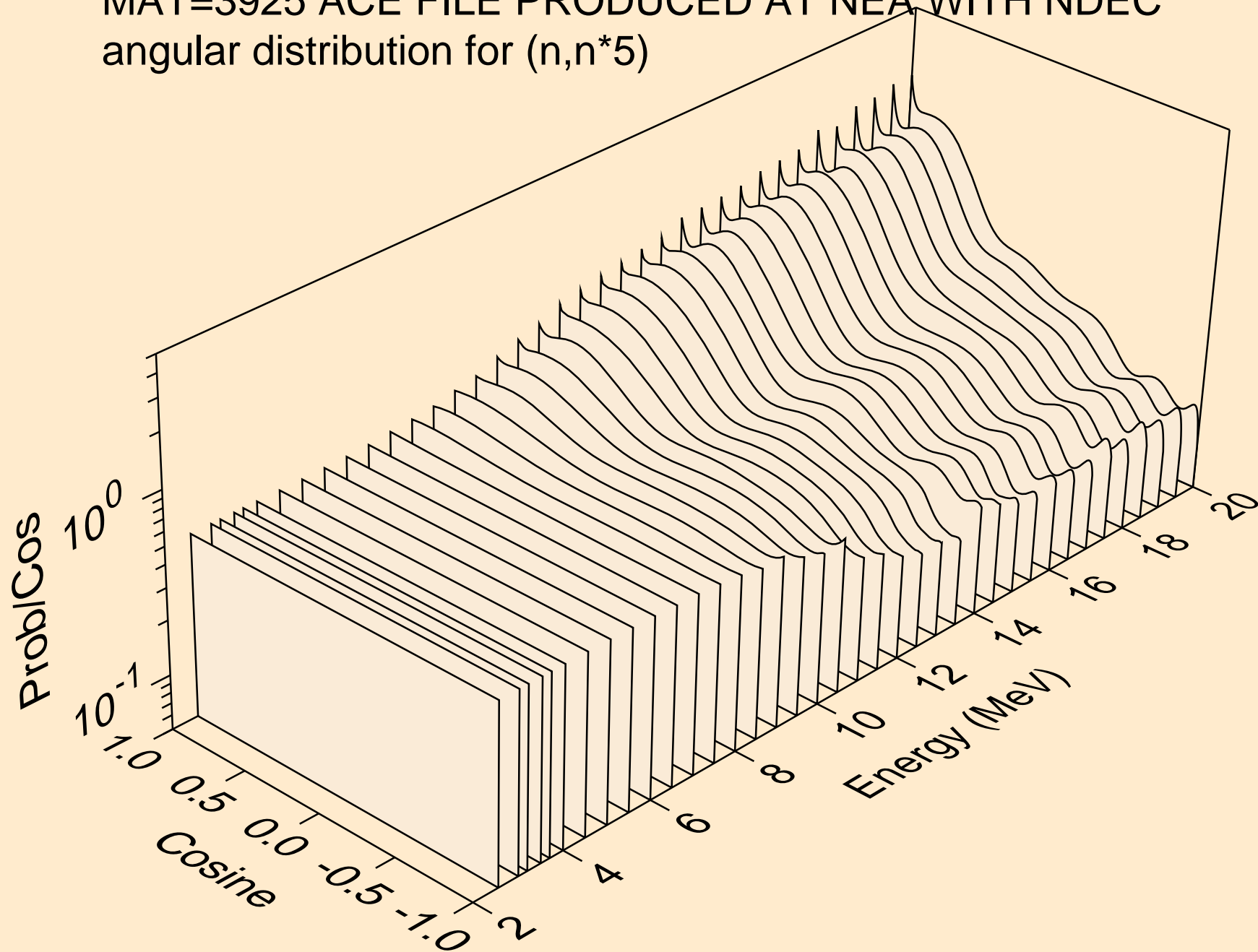

MAT=3925 ACE FILE PRODUCED AT NEA WITH NDEC  
angular distribution for (n,n\*6)

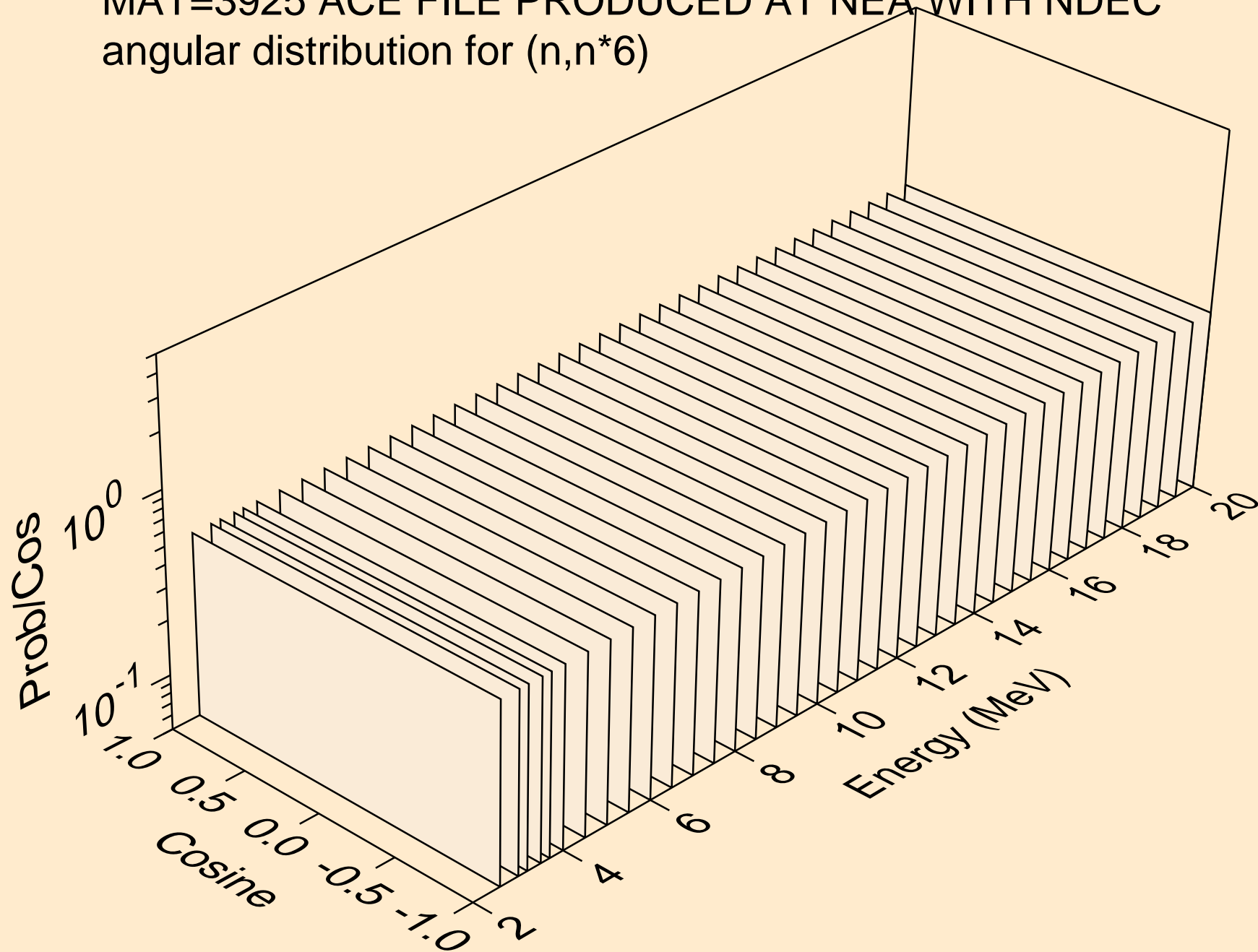



MAT=3925 ACE FILE PRODUCED AT NEA WITH NDEC  
angular distribution for (n,n\*7)

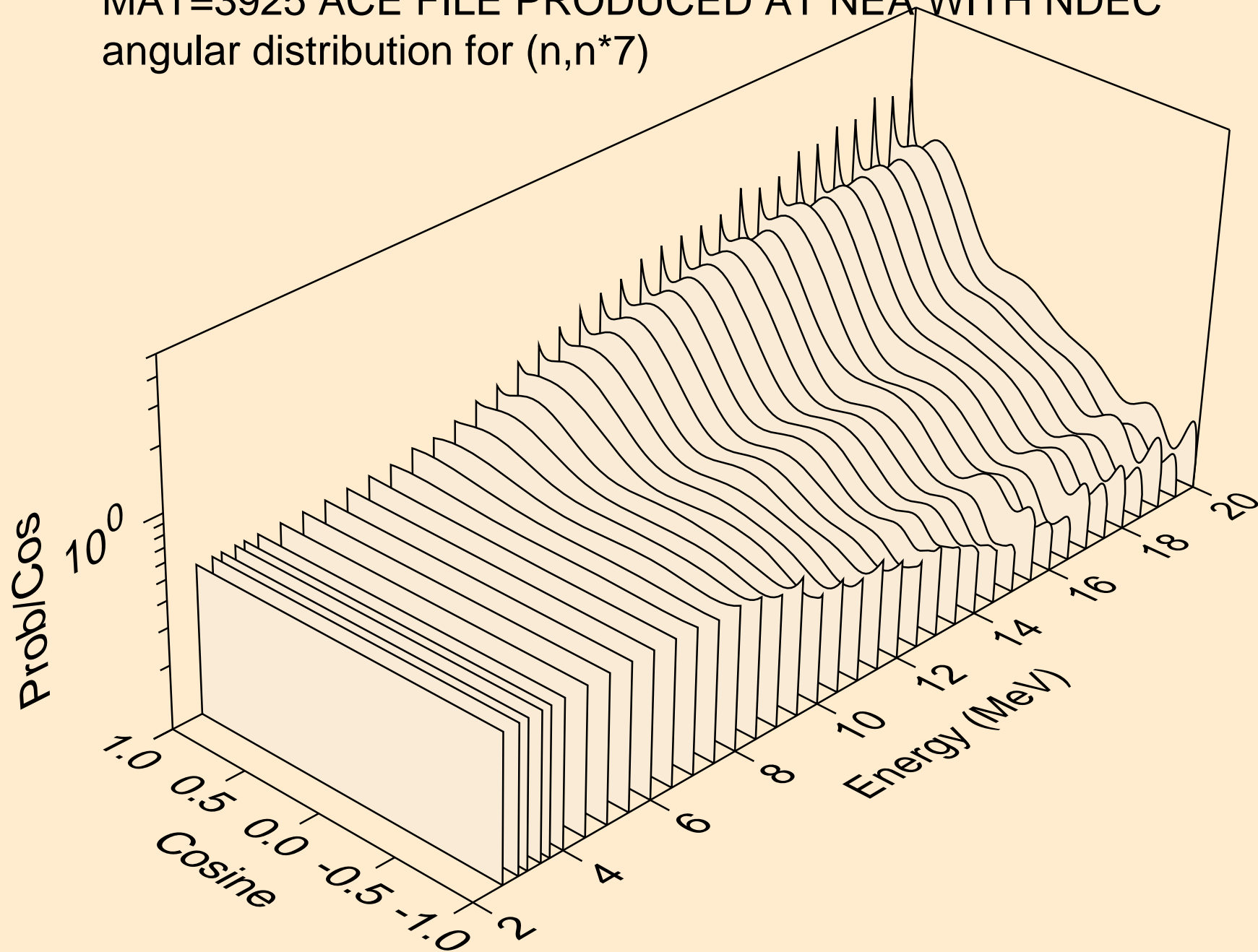

MAT=3925 ACE FILE PRODUCED AT NEA WITH NDEC  
angular distribution for (n,n\*8)

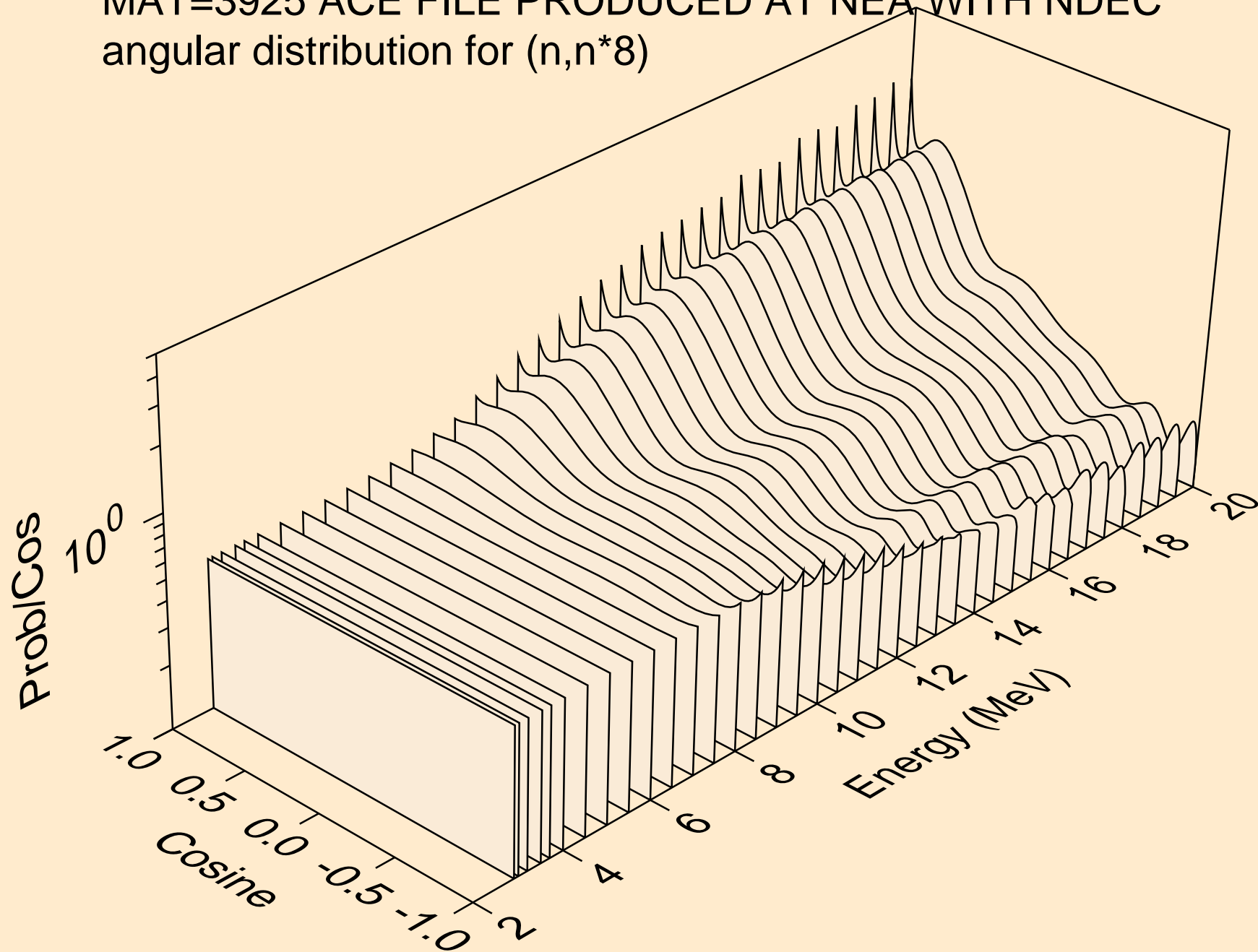

MAT=3925 ACE FILE PRODUCED AT NEA WITH NDEC  
angular distribution for (n,n\*9)

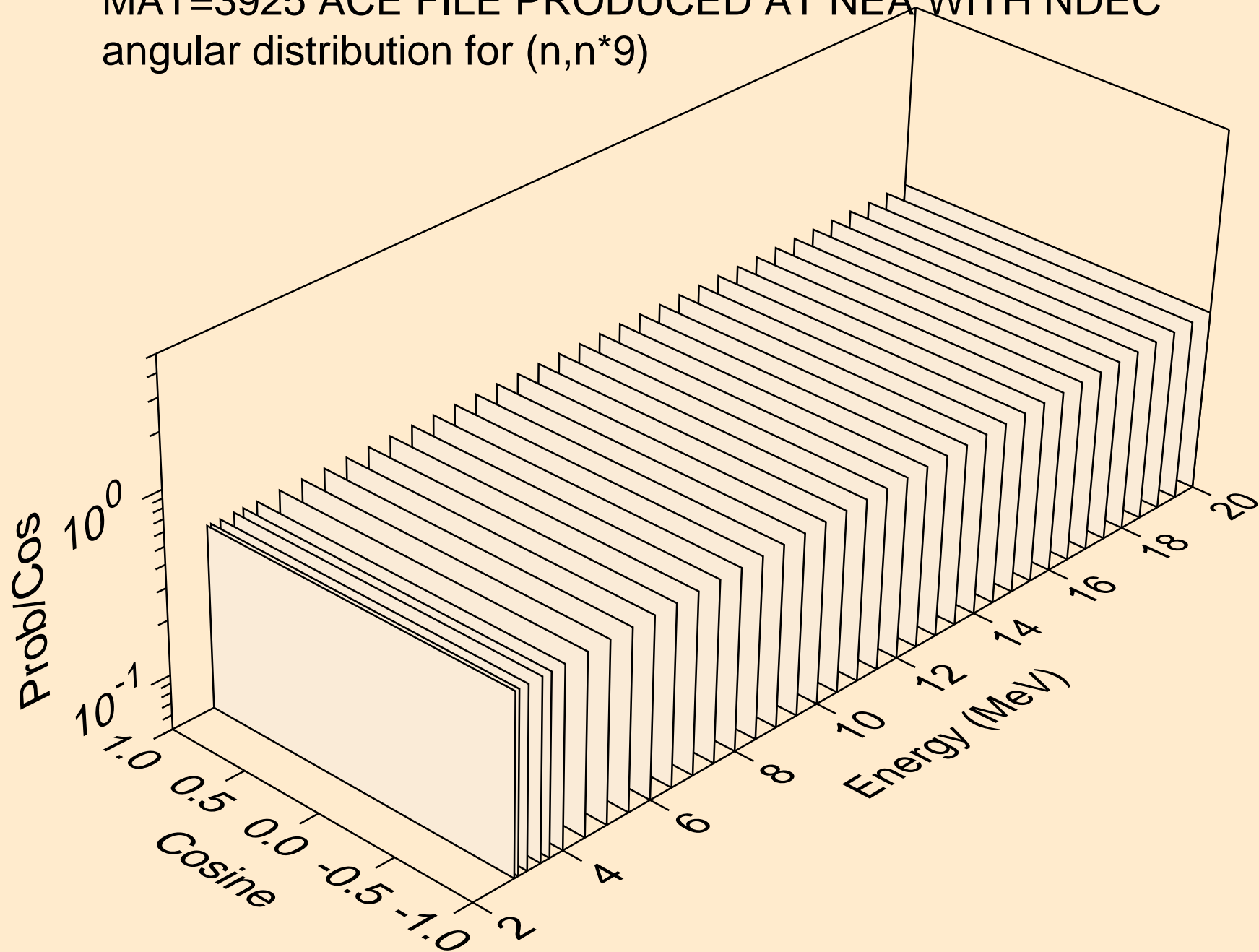

MAT=3925 ACE FILE PRODUCED AT NEA WITH NDEC  
angular distribution for (n,n\*10)

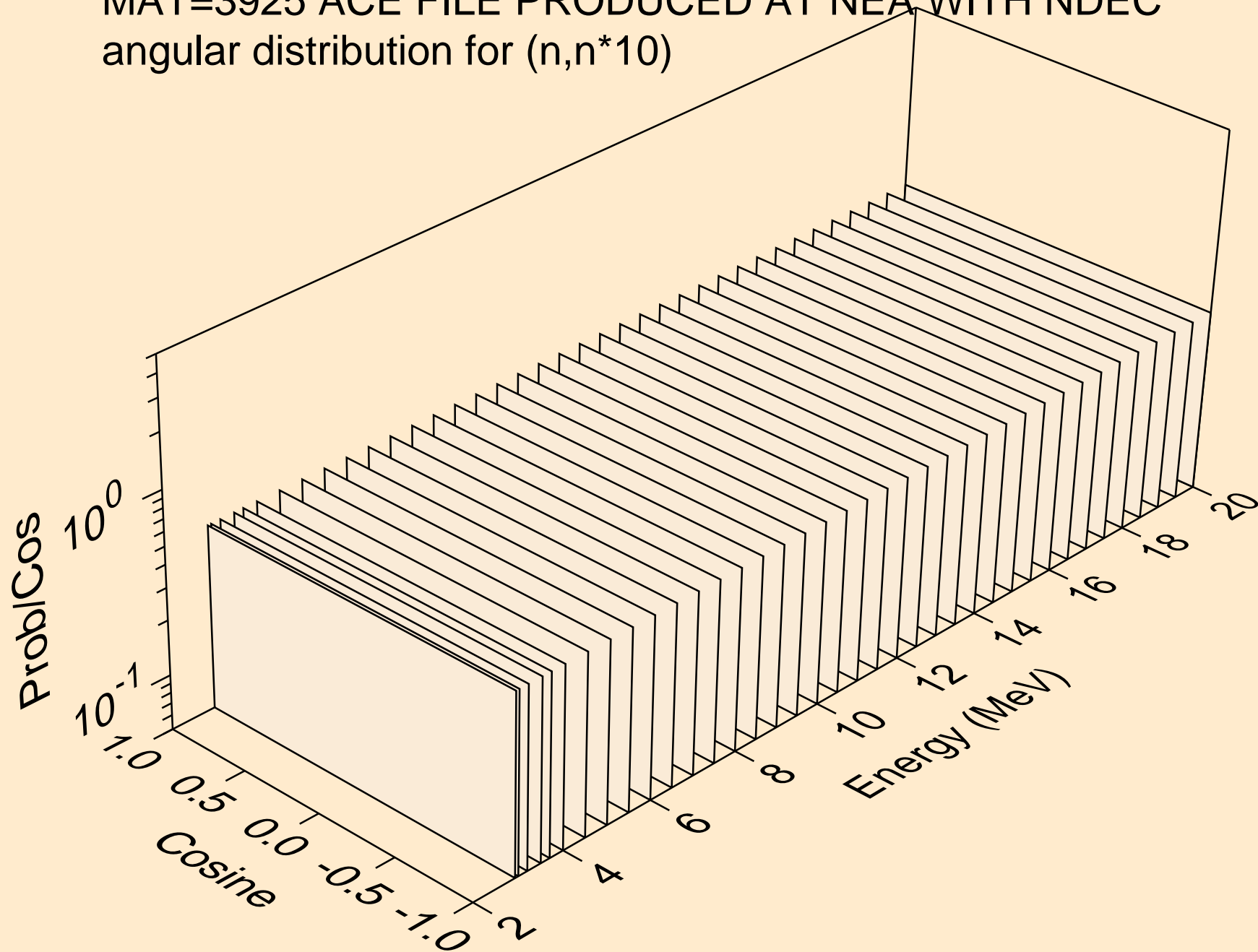

MAT=3925 ACE FILE PRODUCED AT NEA WITH NDEC  
angular distribution for (n,n\*11)

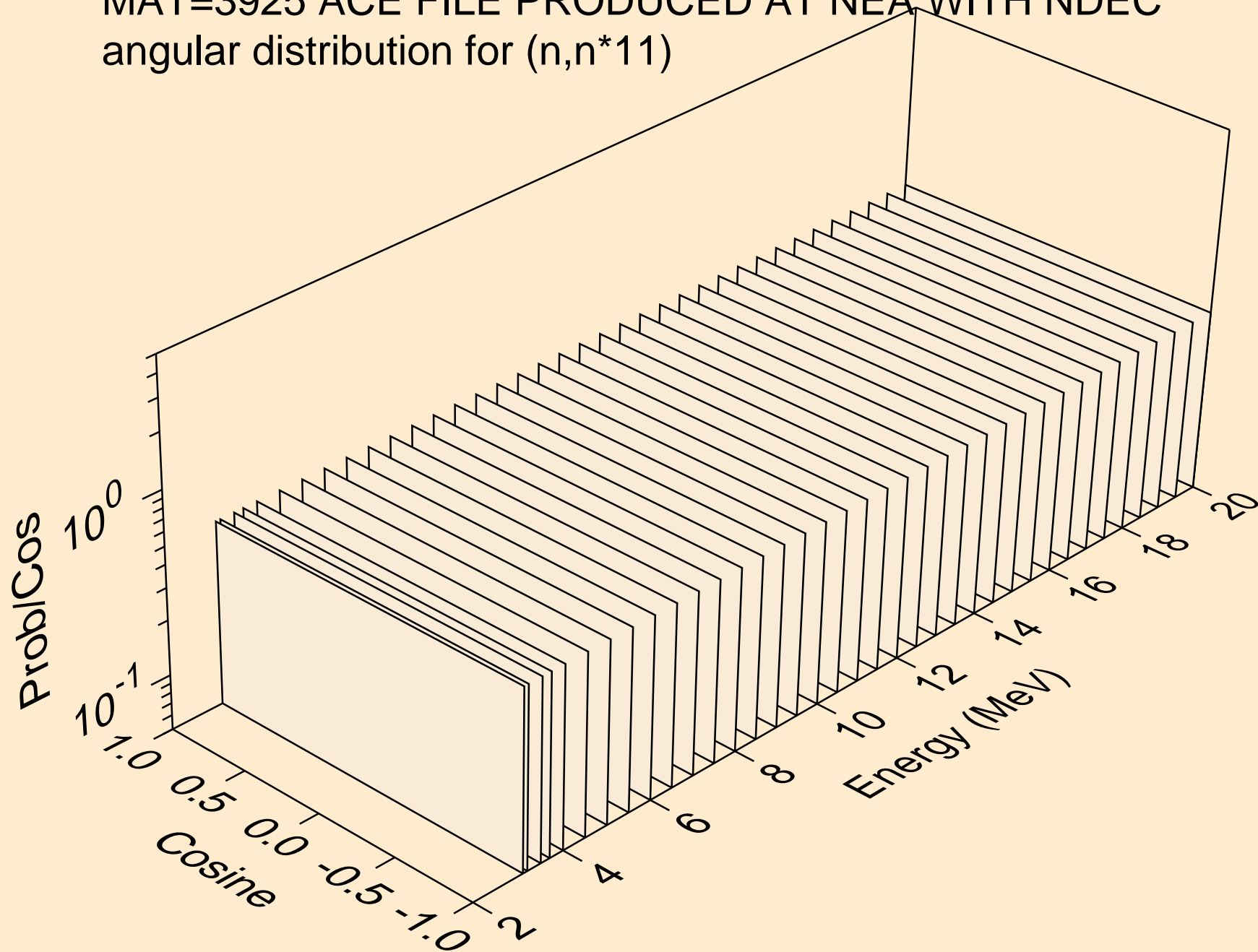

MAT=3925 ACE FILE PRODUCED AT NEA WITH NDEC  
angular distribution for (n,n\*12)

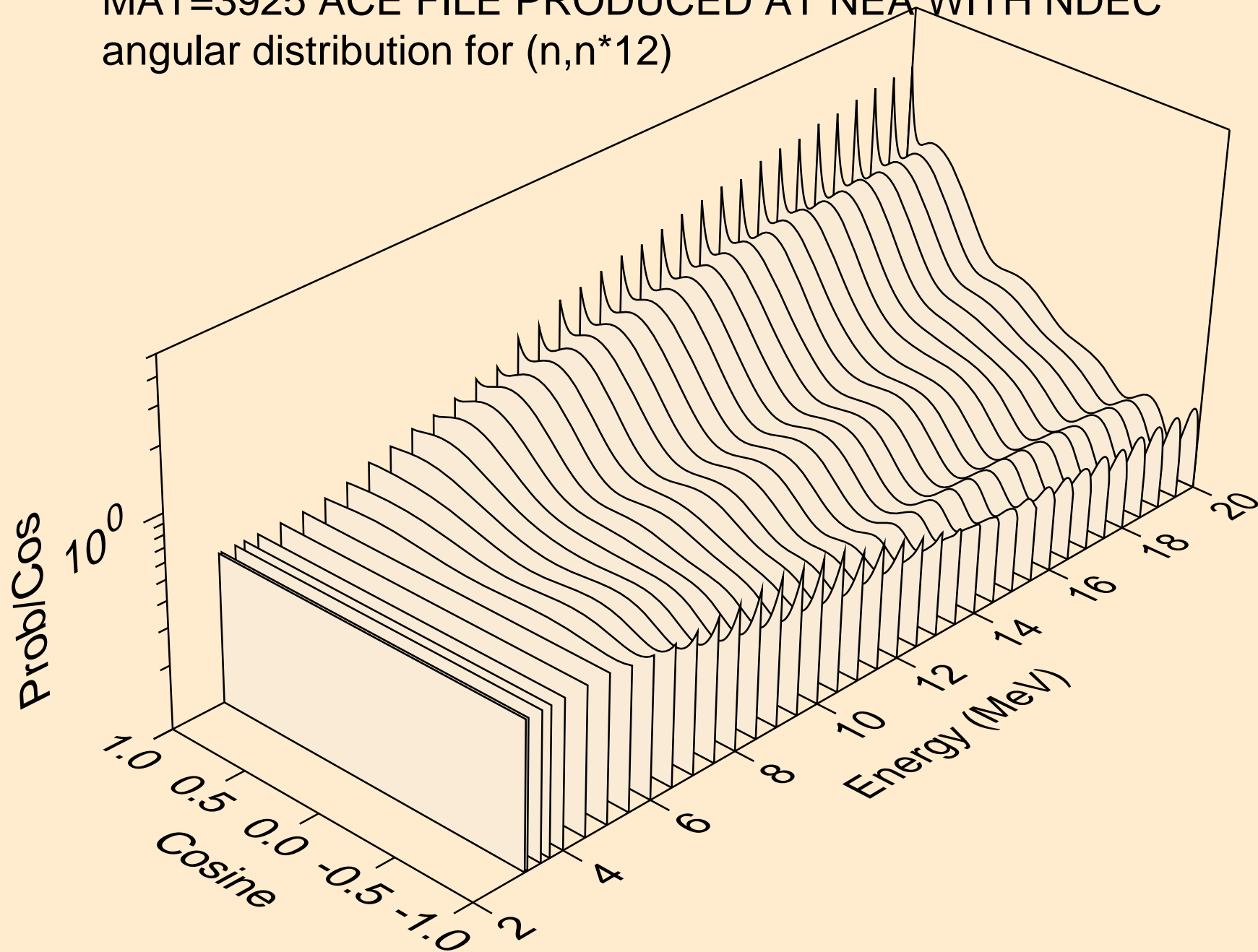

MAT=3925 ACE FILE PRODUCED AT NEA WITH NDEC  
angular distribution for (n,n\*13)

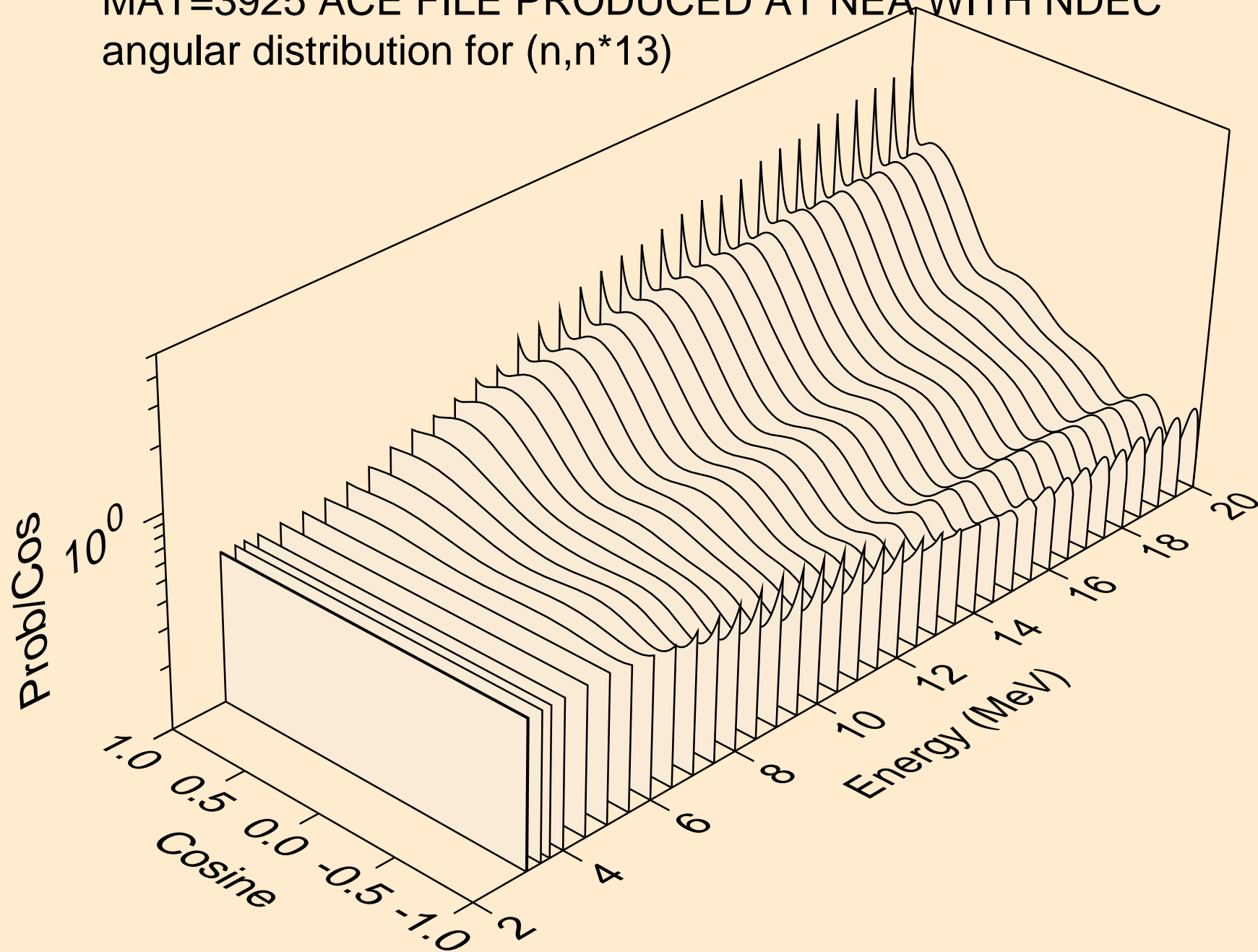

MAT=3925 ACE FILE PRODUCED AT NEA WITH NDEC  
angular distribution for (n,n\*14)

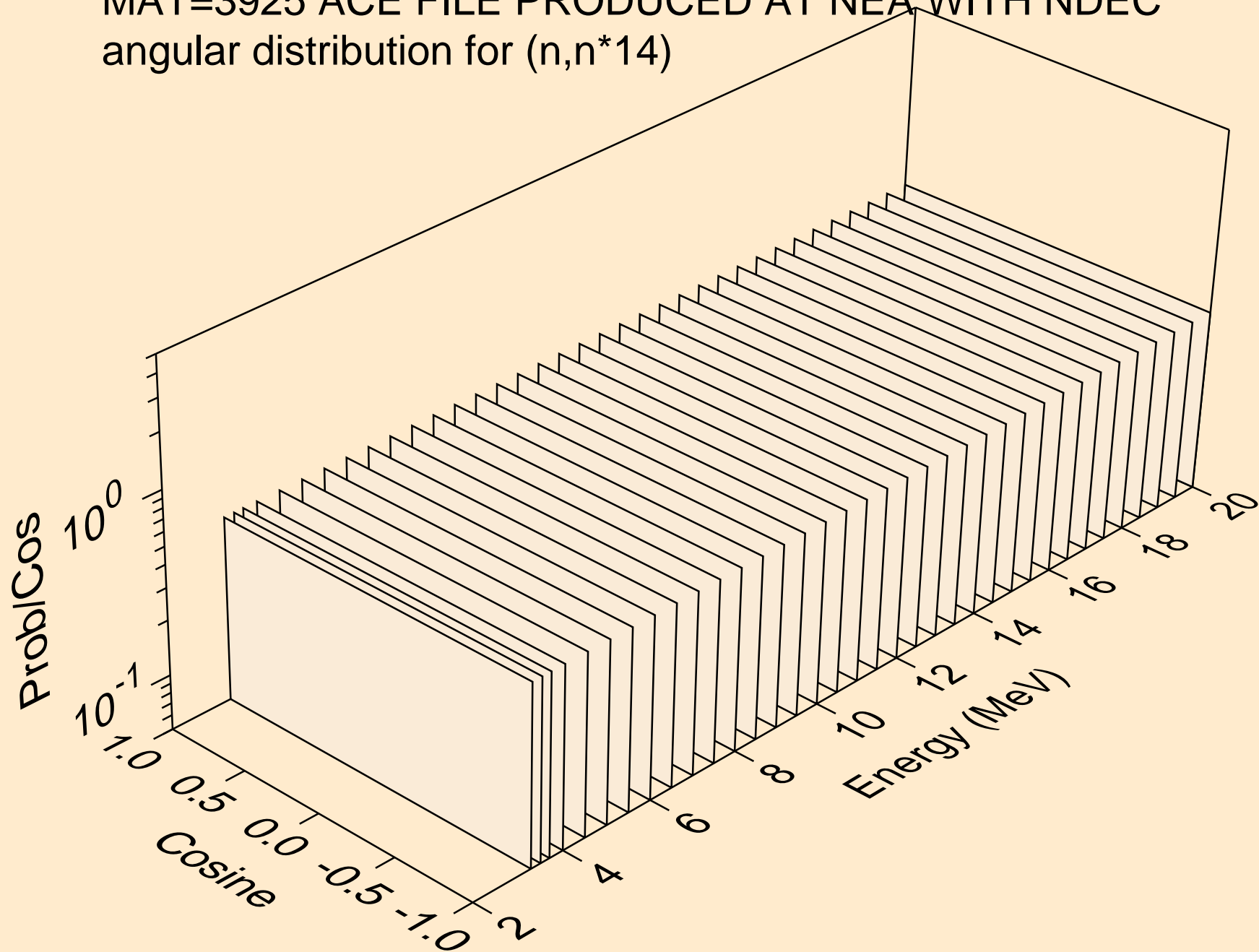



MAT=3925 ACE FILE PRODUCED AT NEA WITH NDEC  
angular distribution for (n,n\*15)

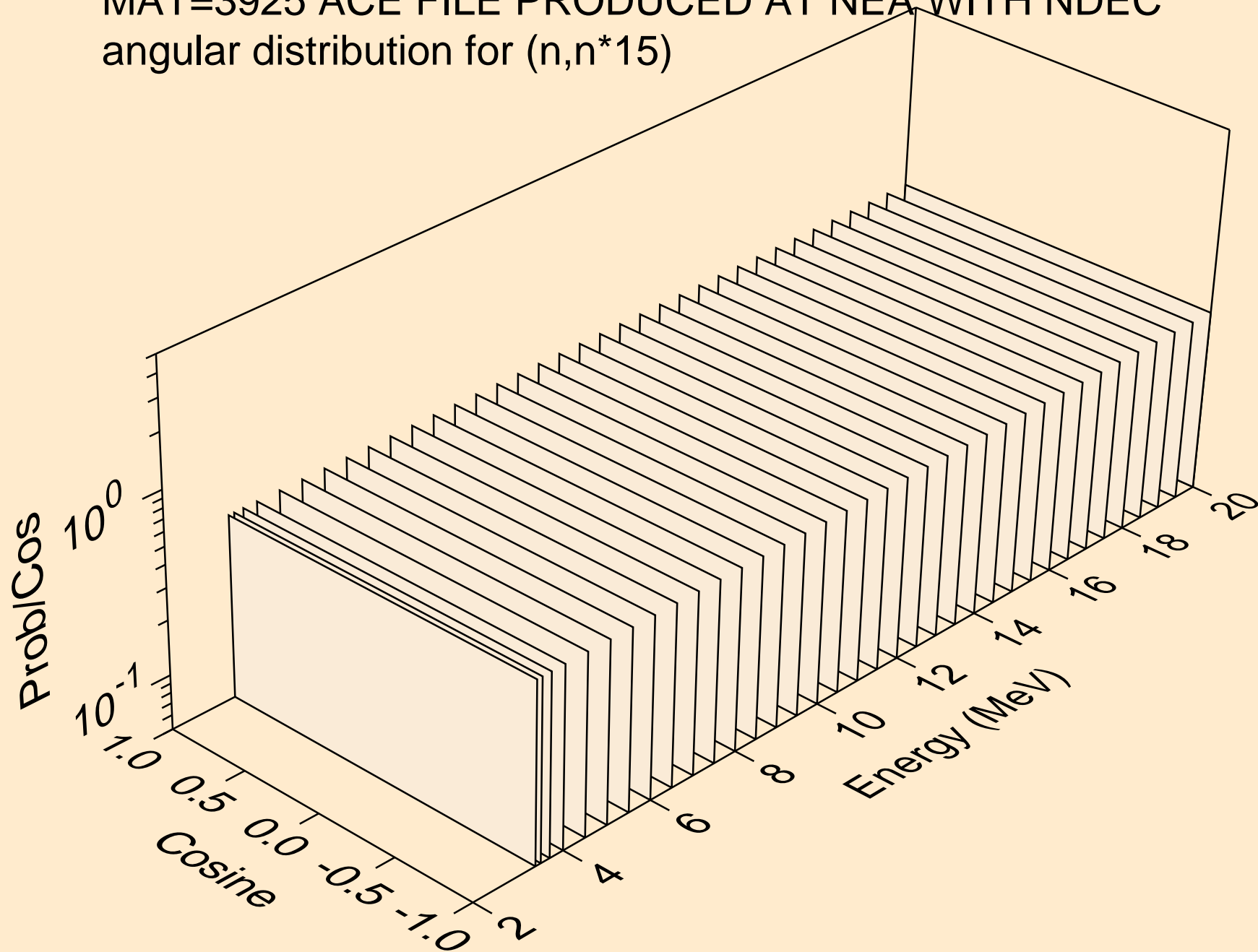

MAT=3925 ACE FILE PRODUCED AT NEA WITH NDEC  
angular distribution for (n,n\*16)

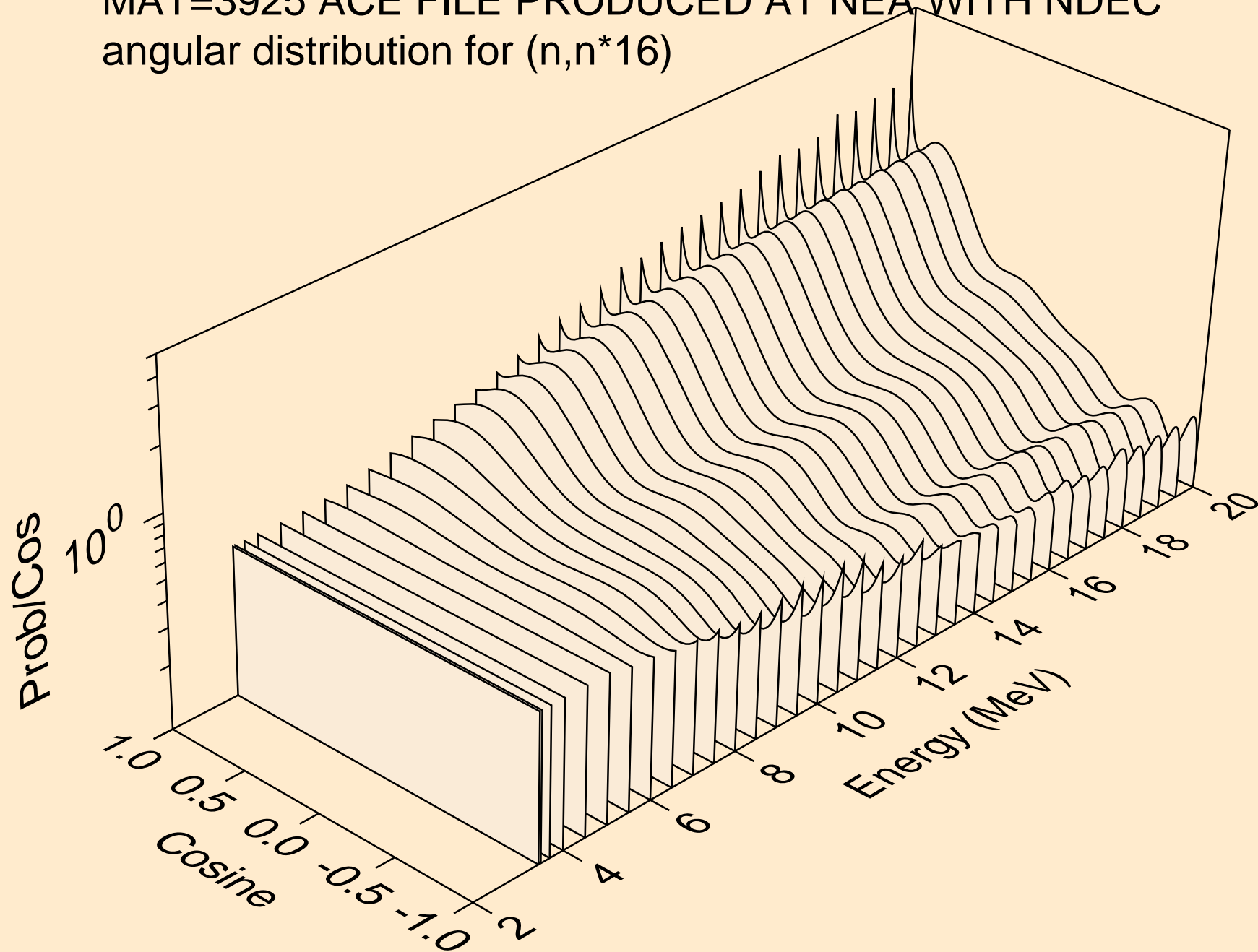

MAT=3925 ACE FILE PRODUCED AT NEA WITH NDEC  
angular distribution for (n,n\*17)

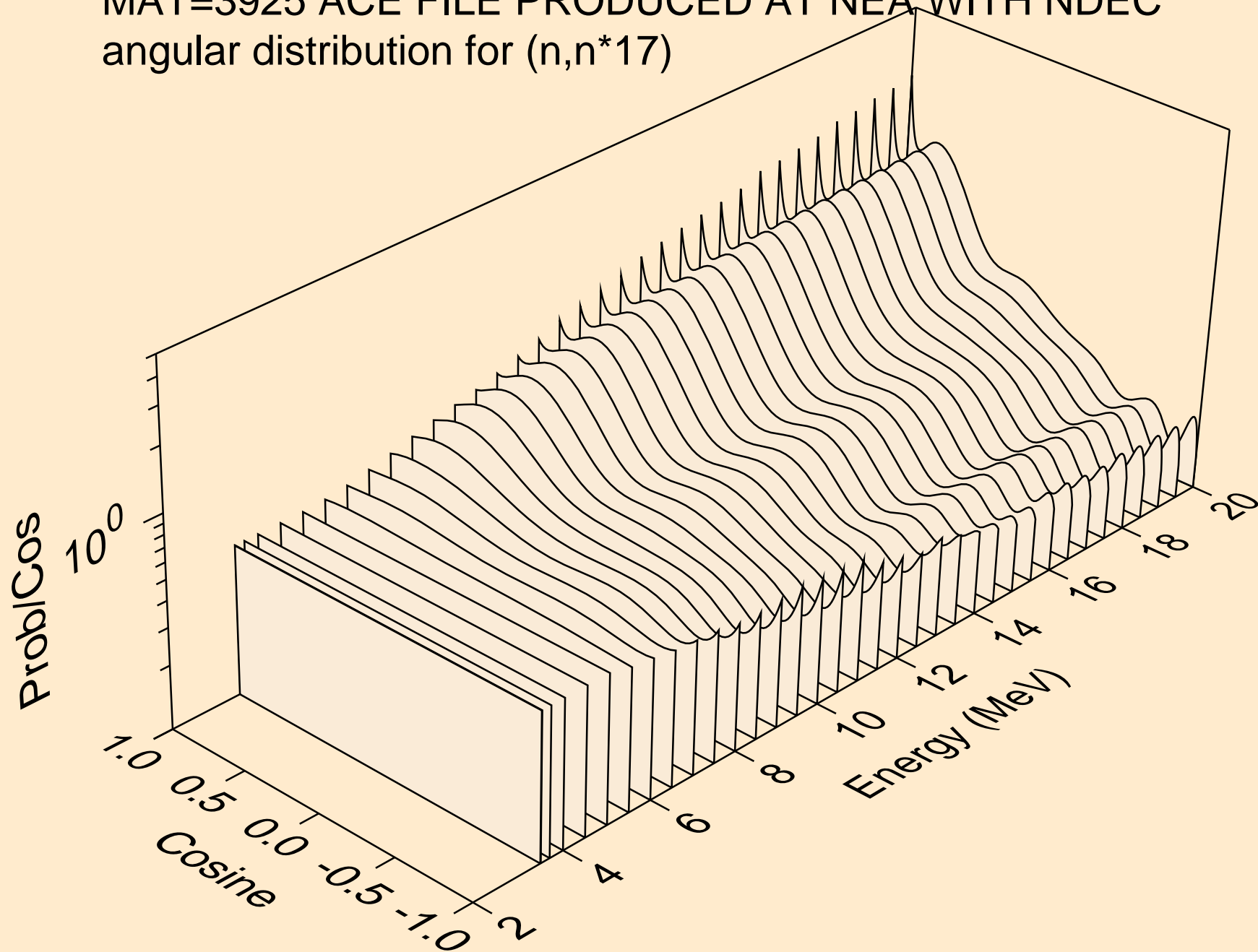

MAT=3925 ACE FILE PRODUCED AT NEA WITH NDEC  
angular distribution for (n,n\*18)

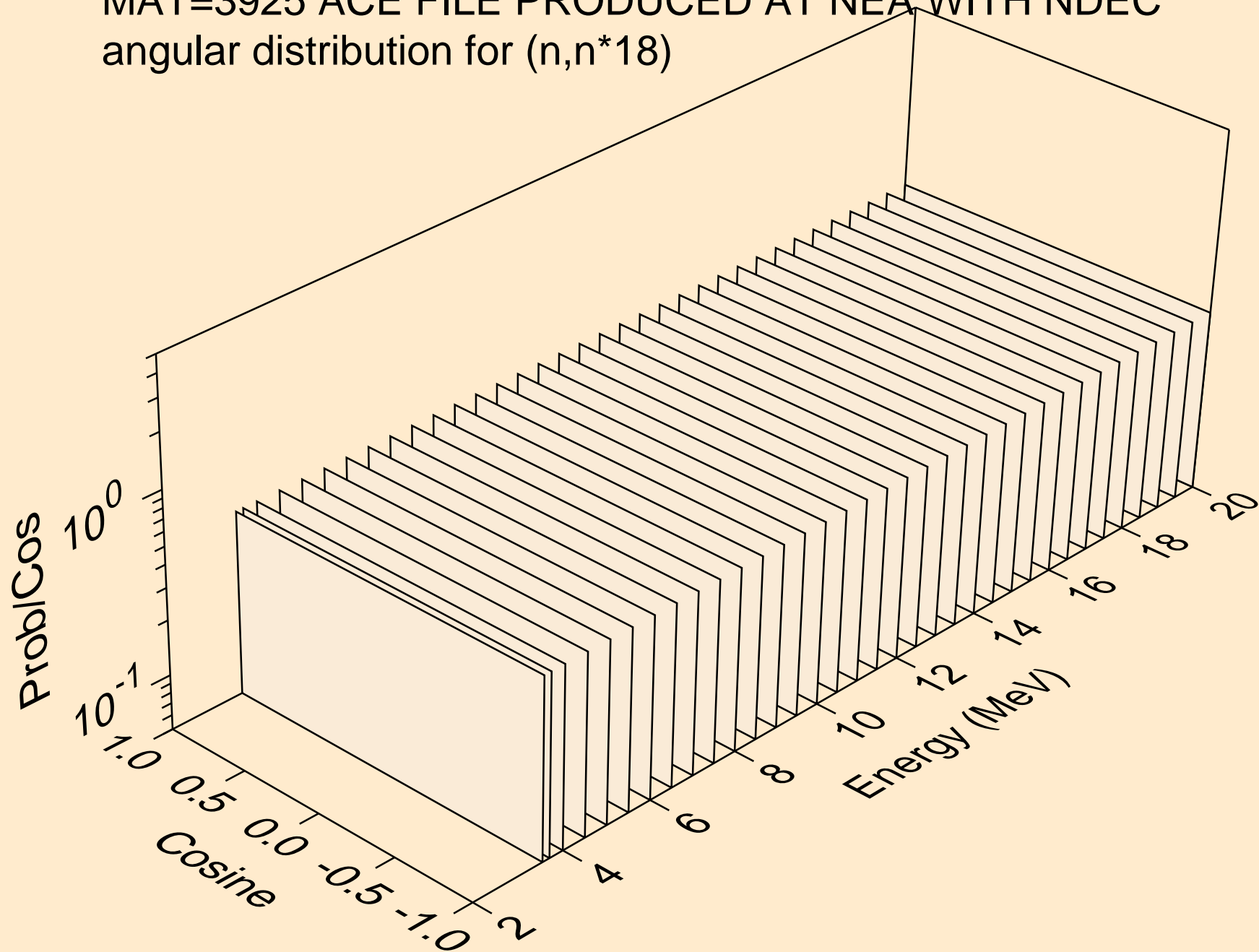

MAT=3925 ACE FILE PRODUCED AT NEA WITH NDEC  
angular distribution for (n,n\*19)

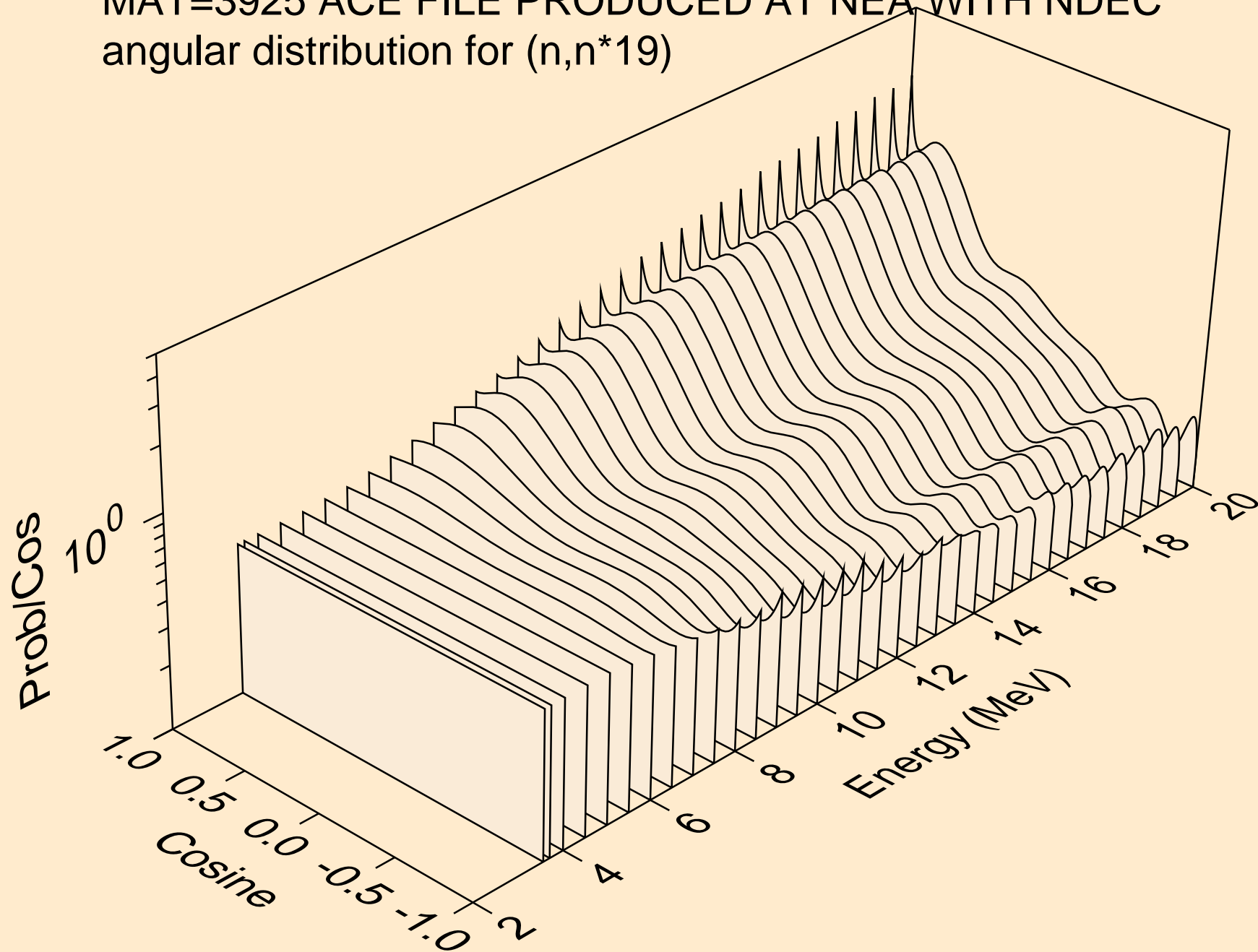

MAT=3925 ACE FILE PRODUCED AT NEA WITH NDEC  
angular distribution for (n,n\*20)

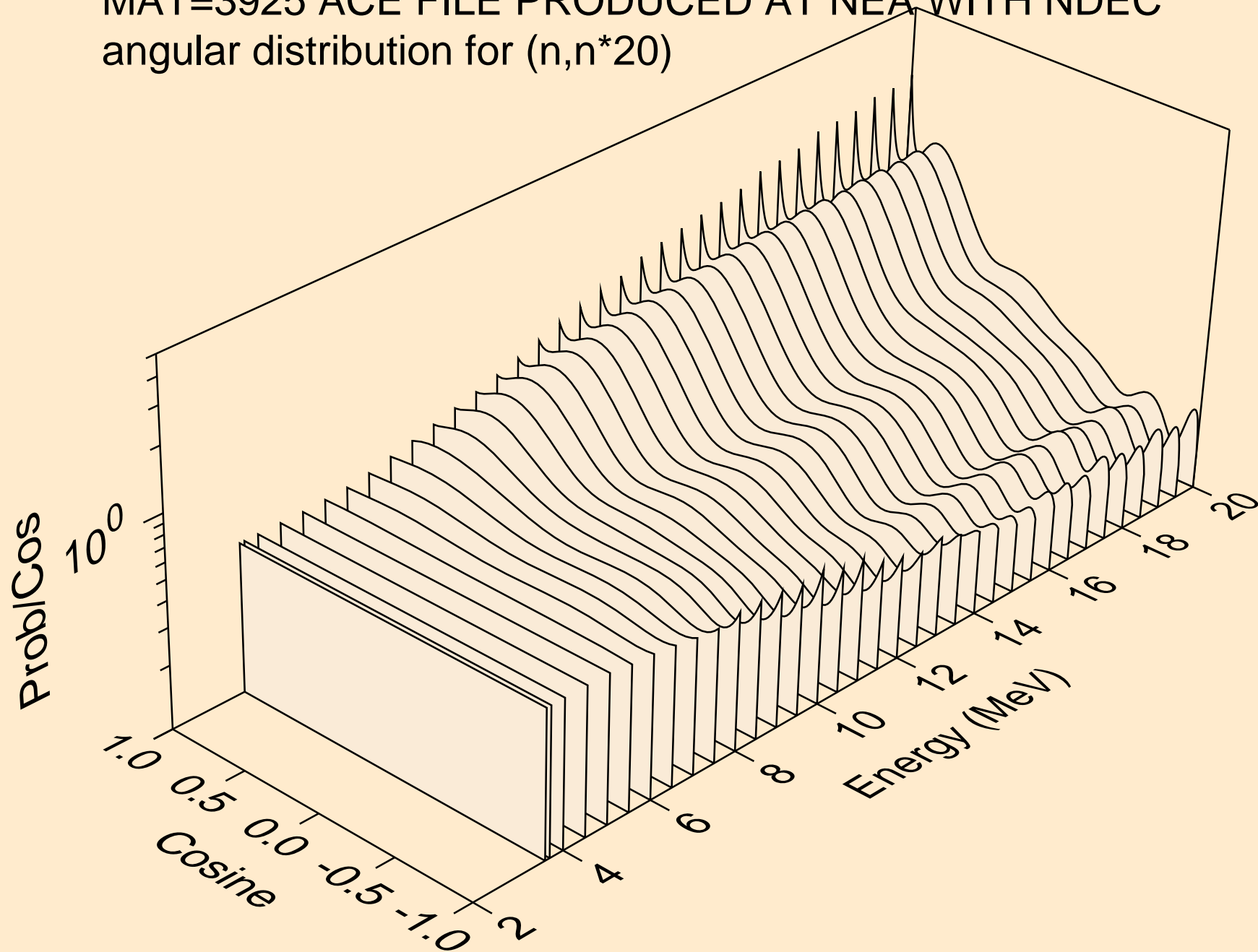

MAT=3925 ACE FILE PRODUCED AT NEA WITH NDEC  
angular distribution for (n,n\*21)

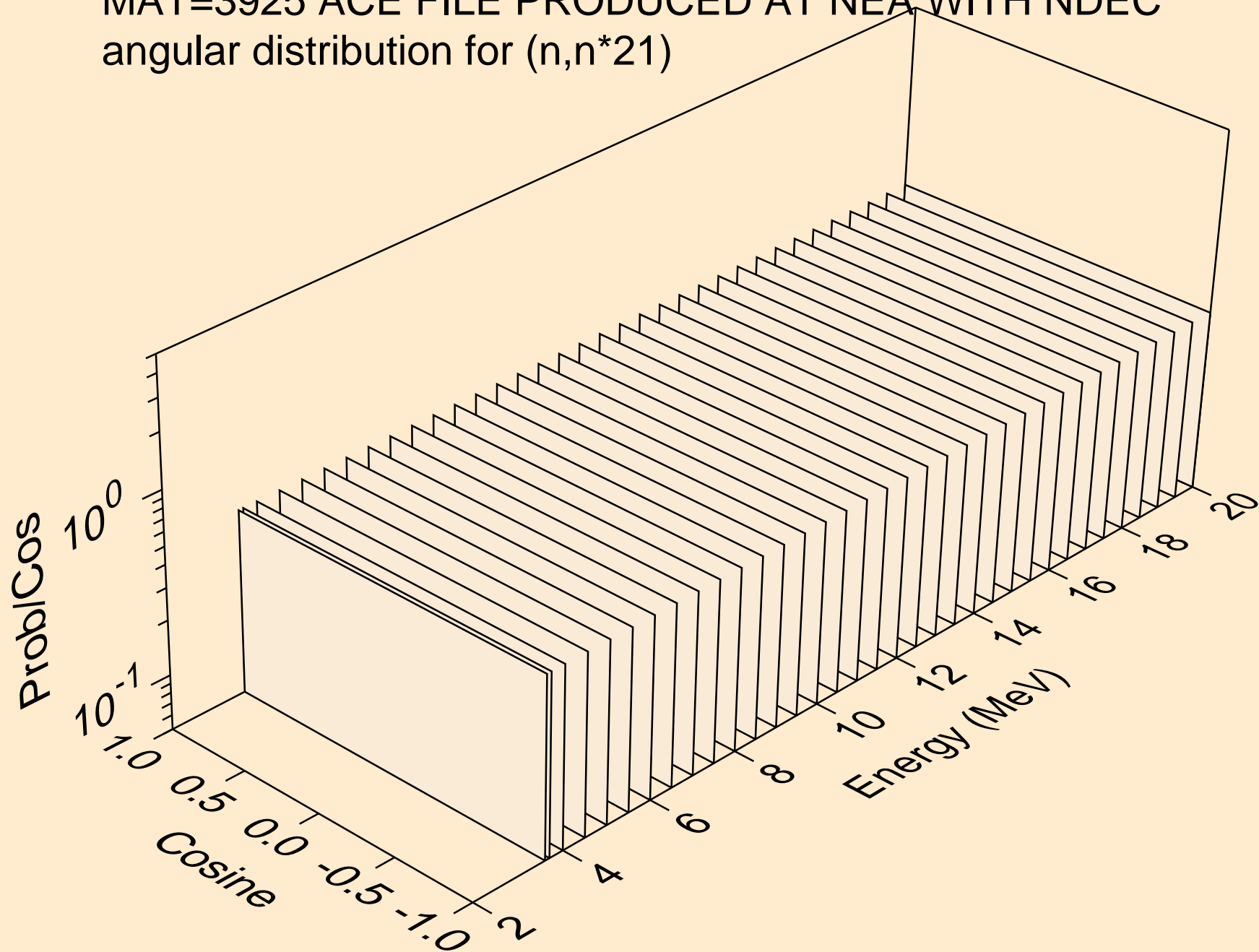

MAT=3925 ACE FILE PRODUCED AT NEA WITH NDEC  
angular distribution for (n,n\*22)

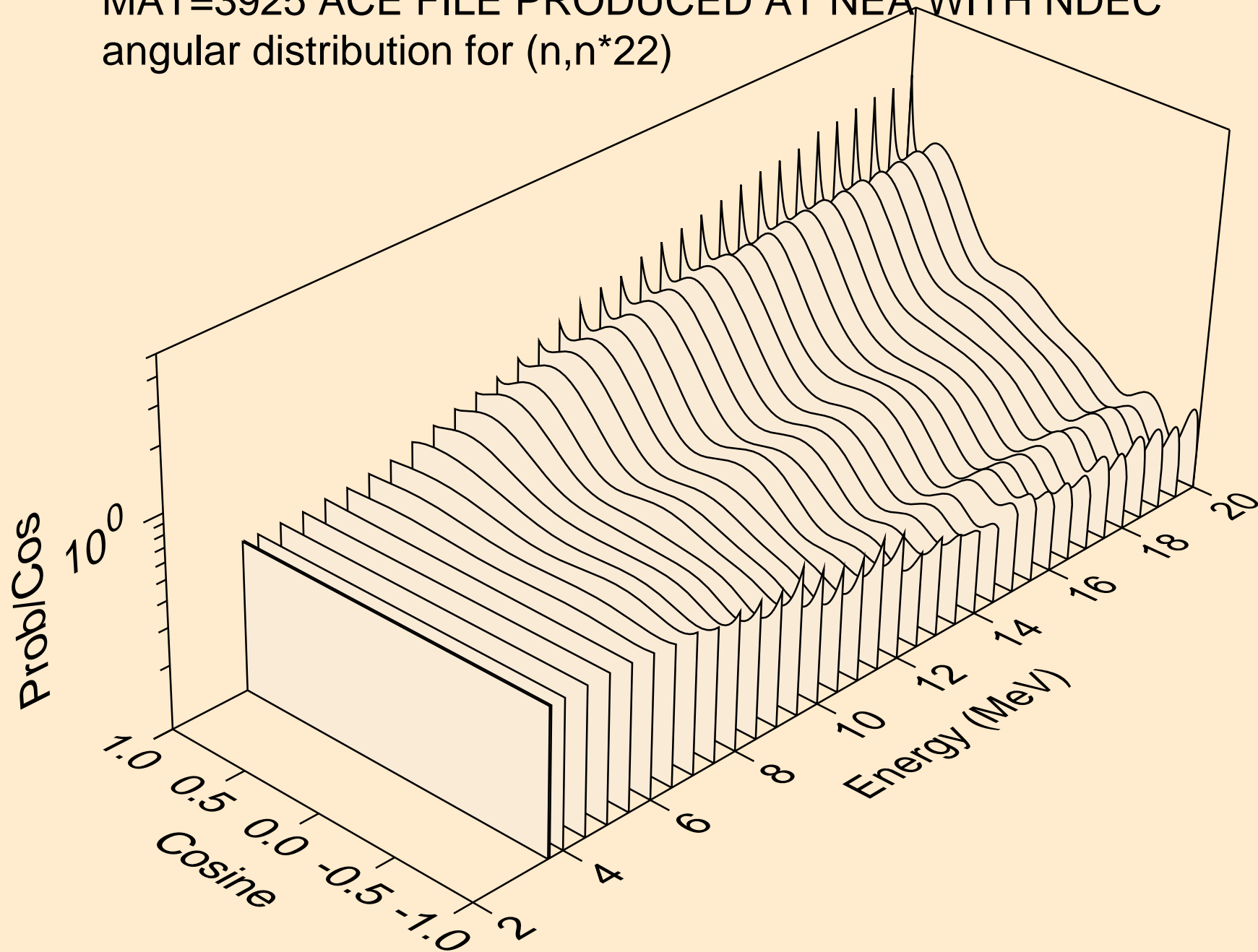



MAT=3925 ACE FILE PRODUCED AT NEA WITH NDEC  
angular distribution for (n,n\*23)

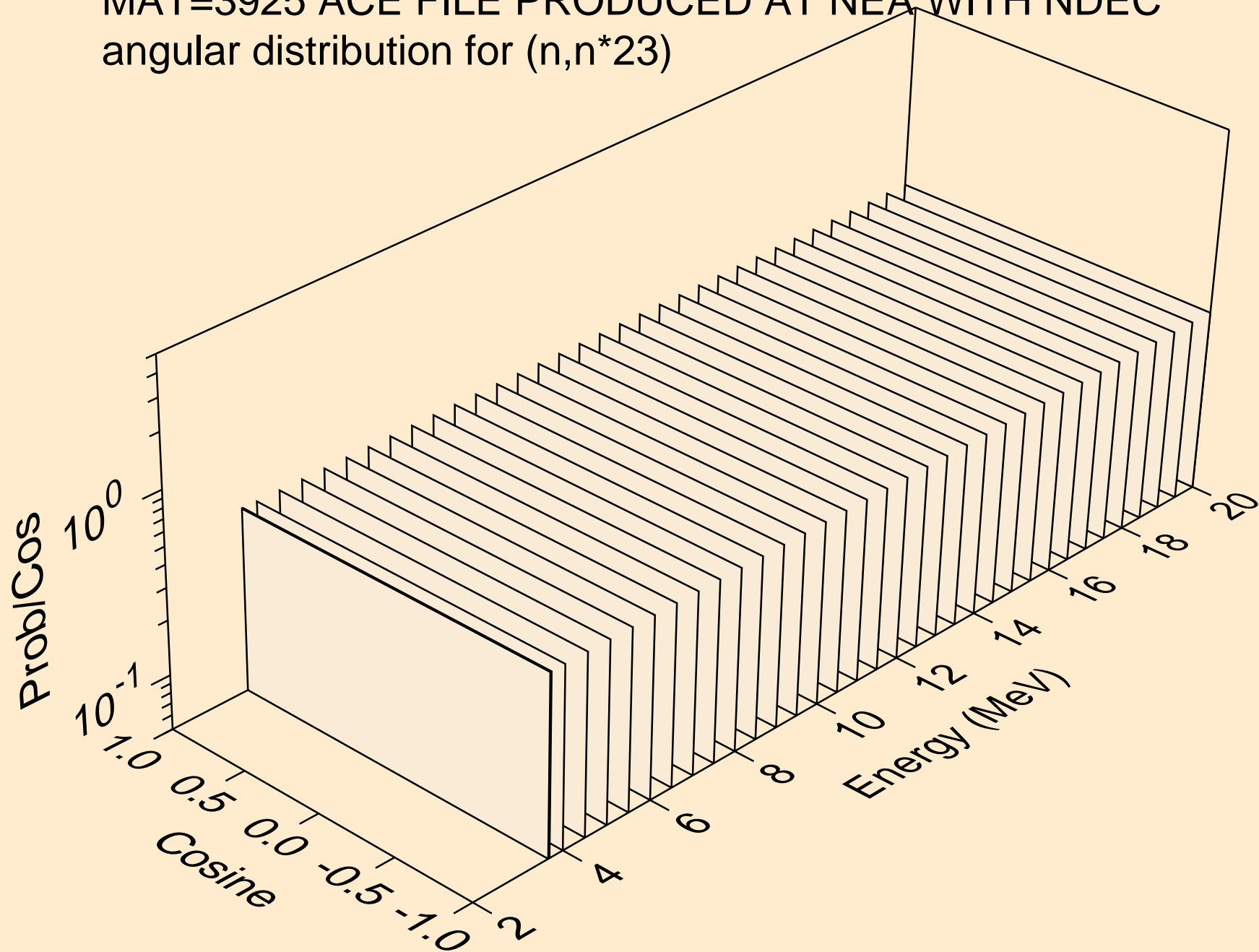

MAT=3925 ACE FILE PRODUCED AT NEA WITH NDEC  
angular distribution for (n,n\*24)

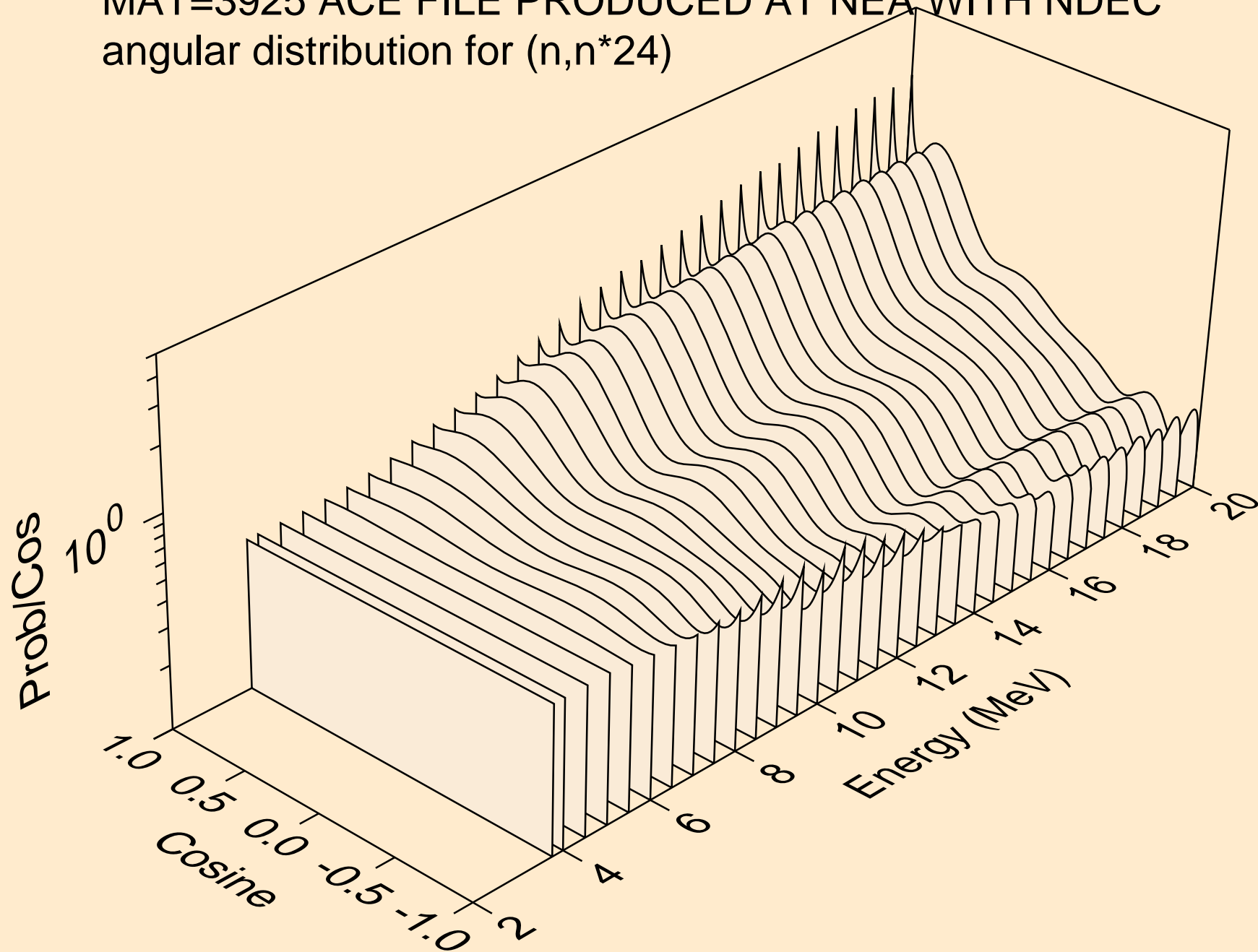

MAT=3925 ACE FILE PRODUCED AT NEA WITH NDEC  
angular distribution for (n,n\*25)

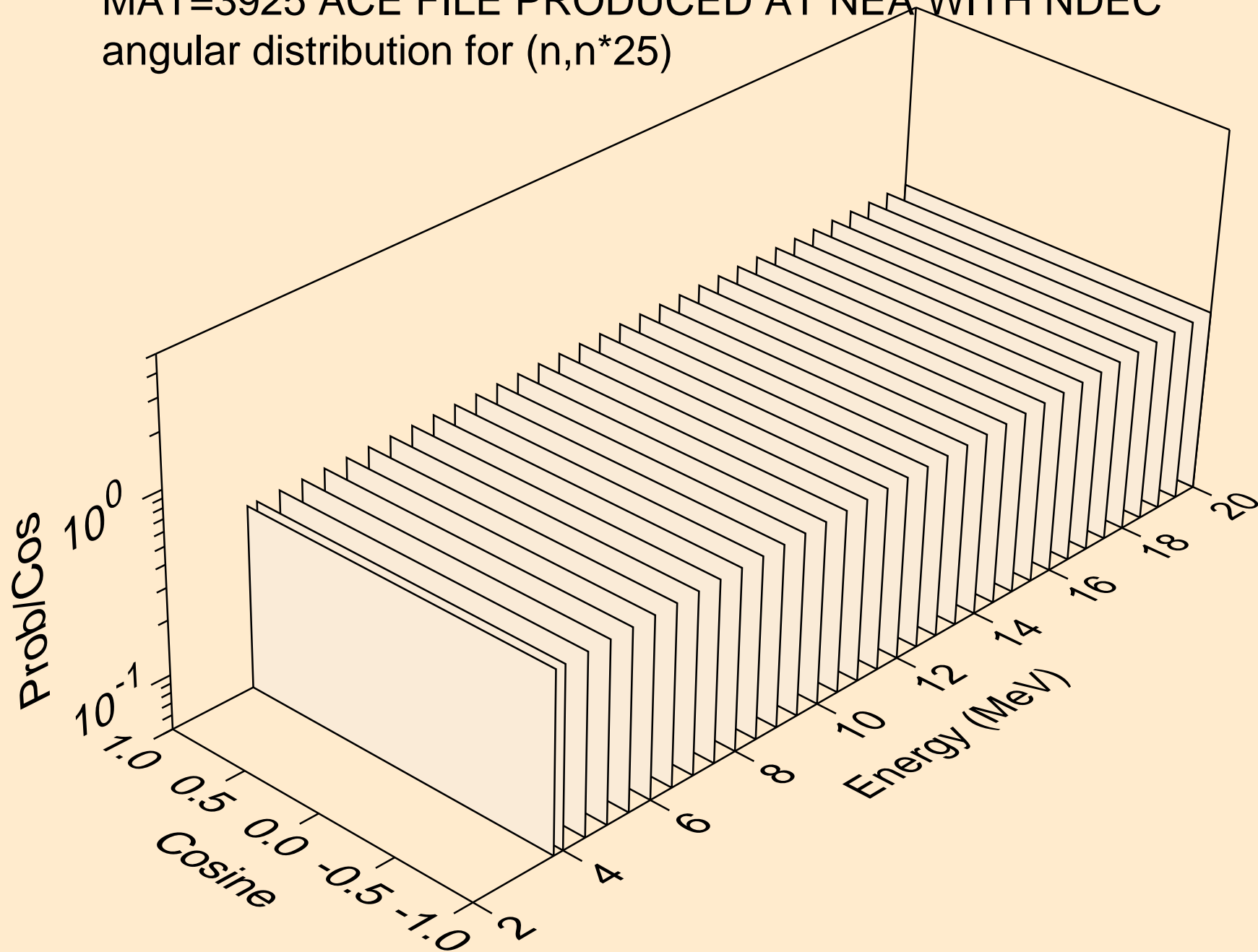

MAT=3925 ACE FILE PRODUCED AT NEA WITH NDEC  
angular distribution for (n,n\*26)

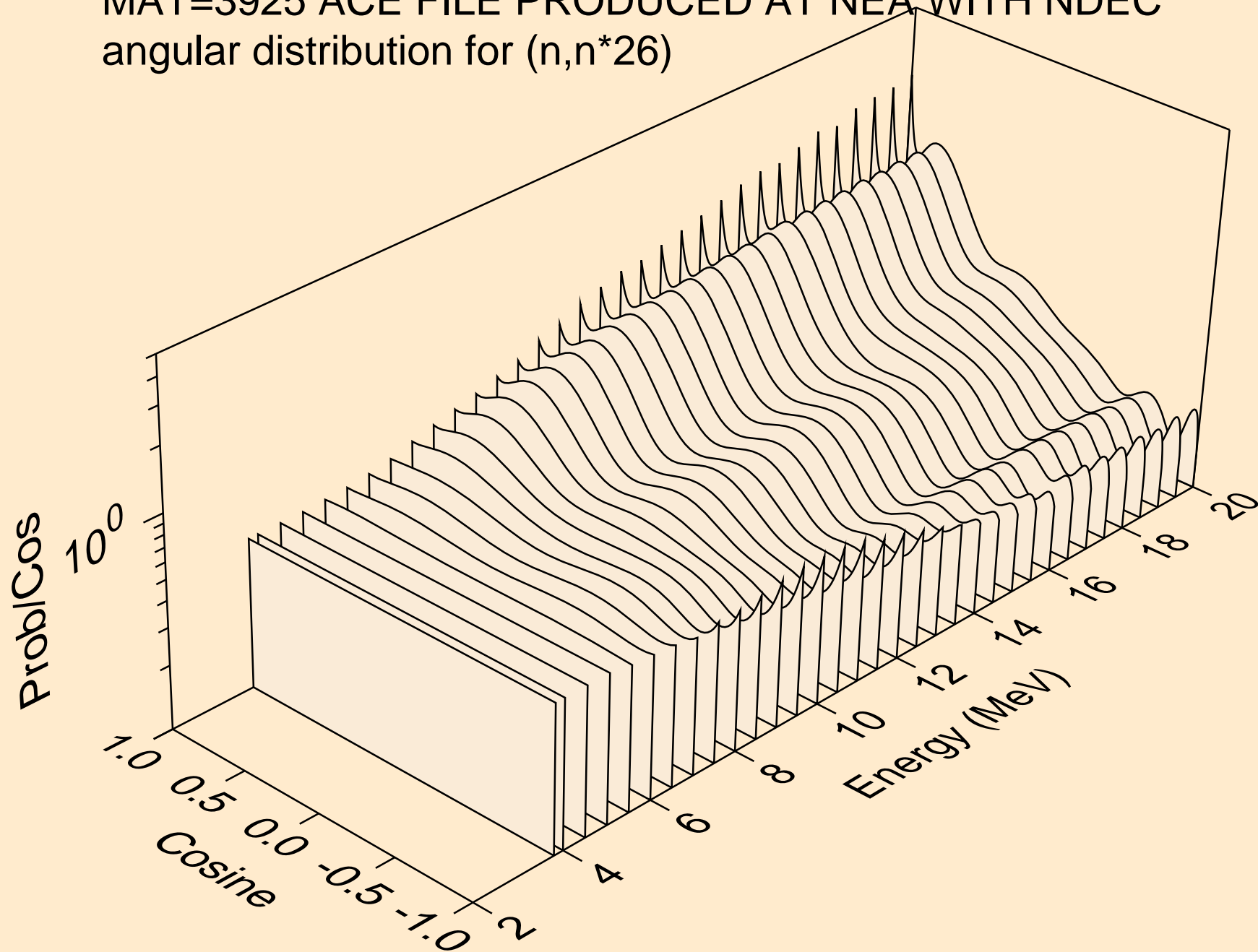

MAT=3925 ACE FILE PRODUCED AT NEA WITH NDEC  
angular distribution for (n,n\*27)

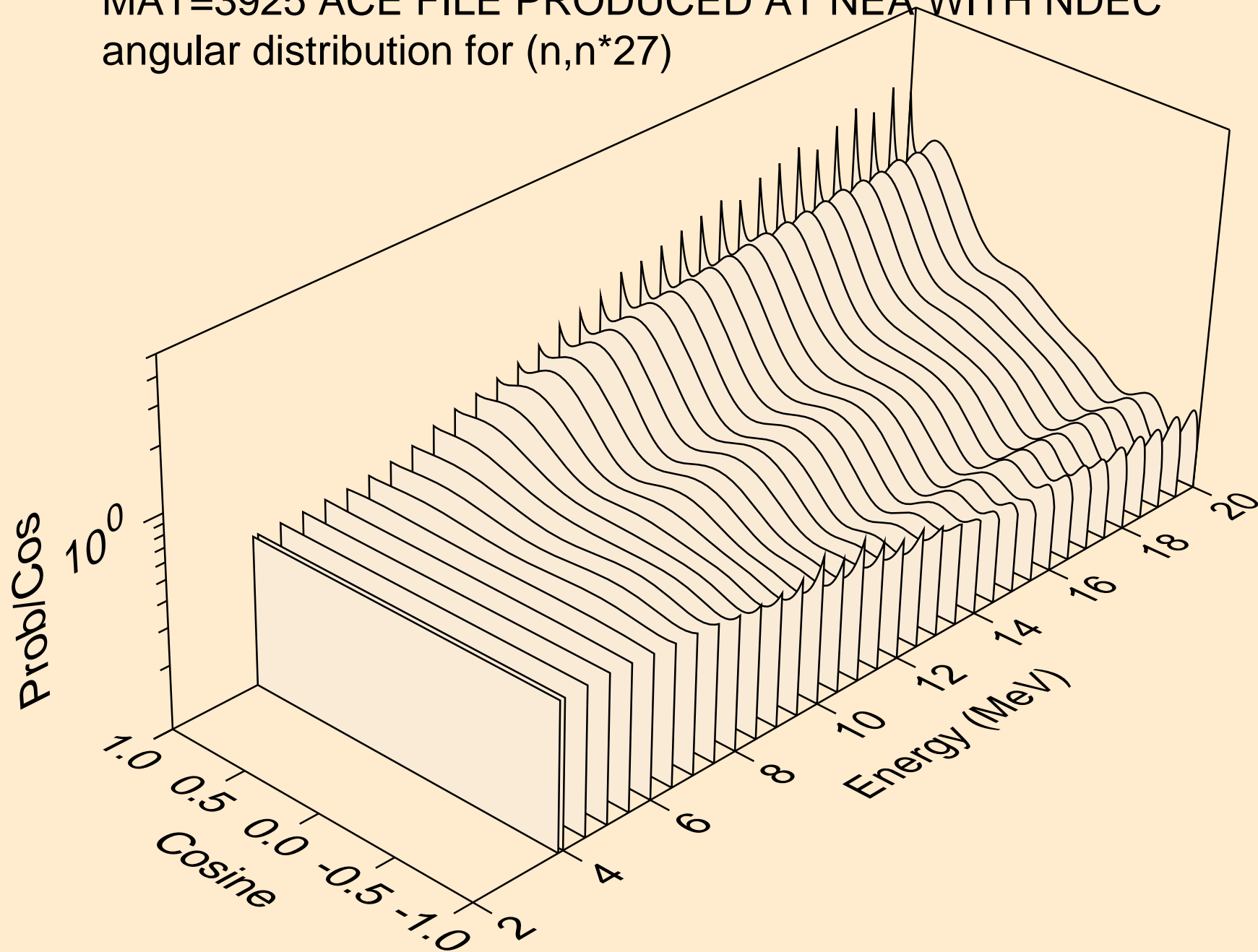

MAT=3925 ACE FILE PRODUCED AT NEA WITH NDEC  
angular distribution for (n,n\*28)

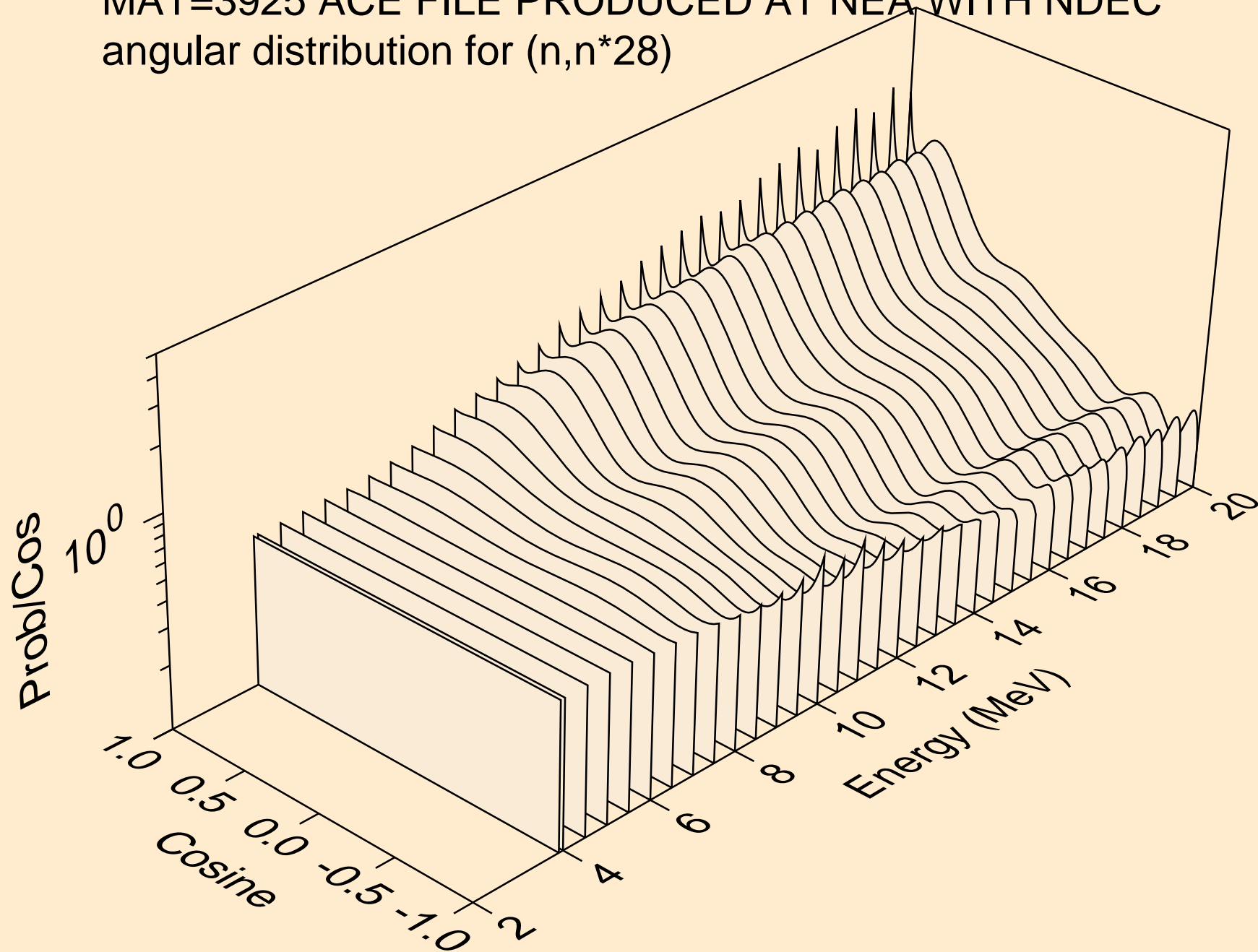

MAT=3925 ACE FILE PRODUCED AT NEA WITH NDEC  
angular distribution for (n,n\*29)

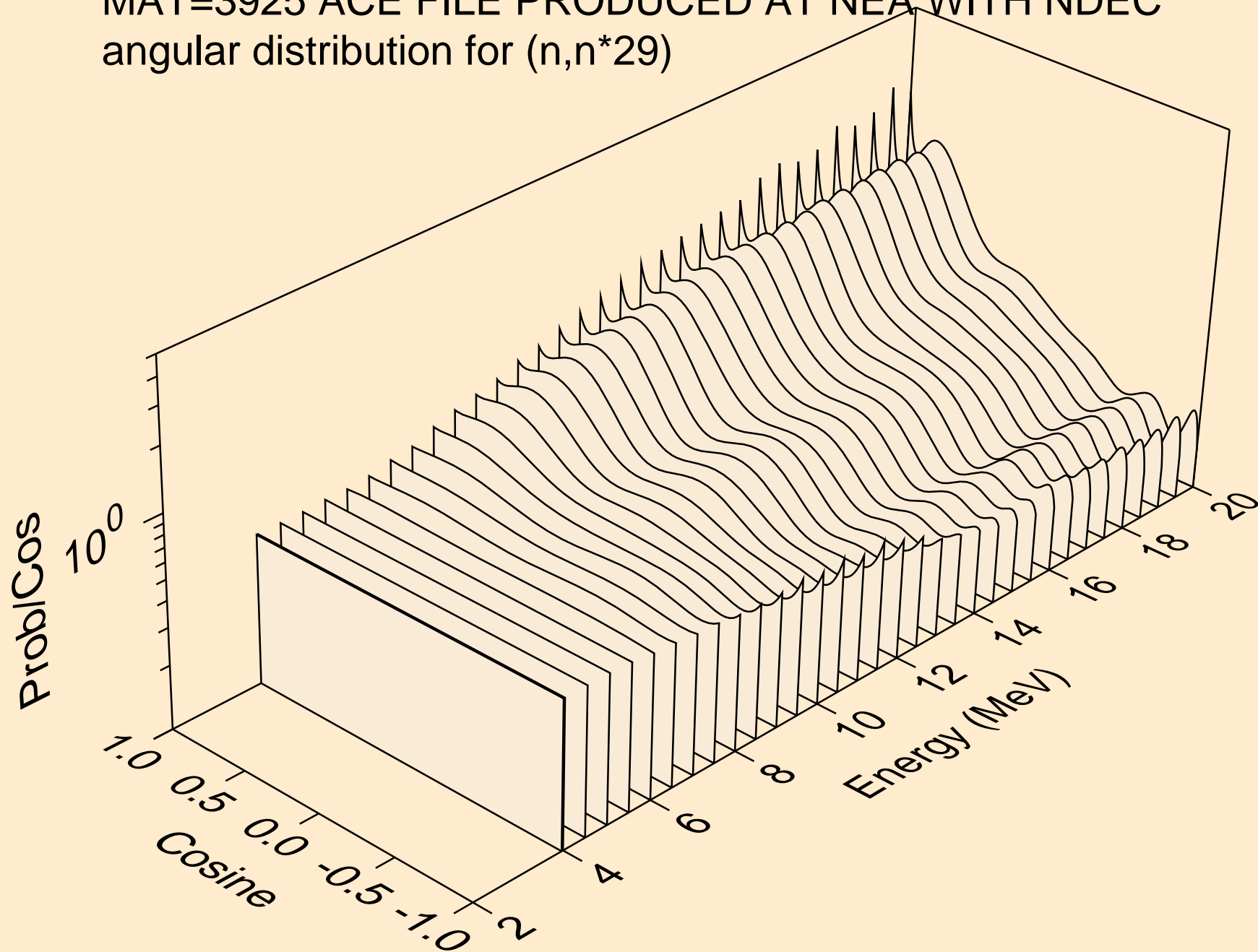

MAT=3925 ACE FILE PRODUCED AT NEA WITH NDEC  
angular distribution for (n,n\*30)

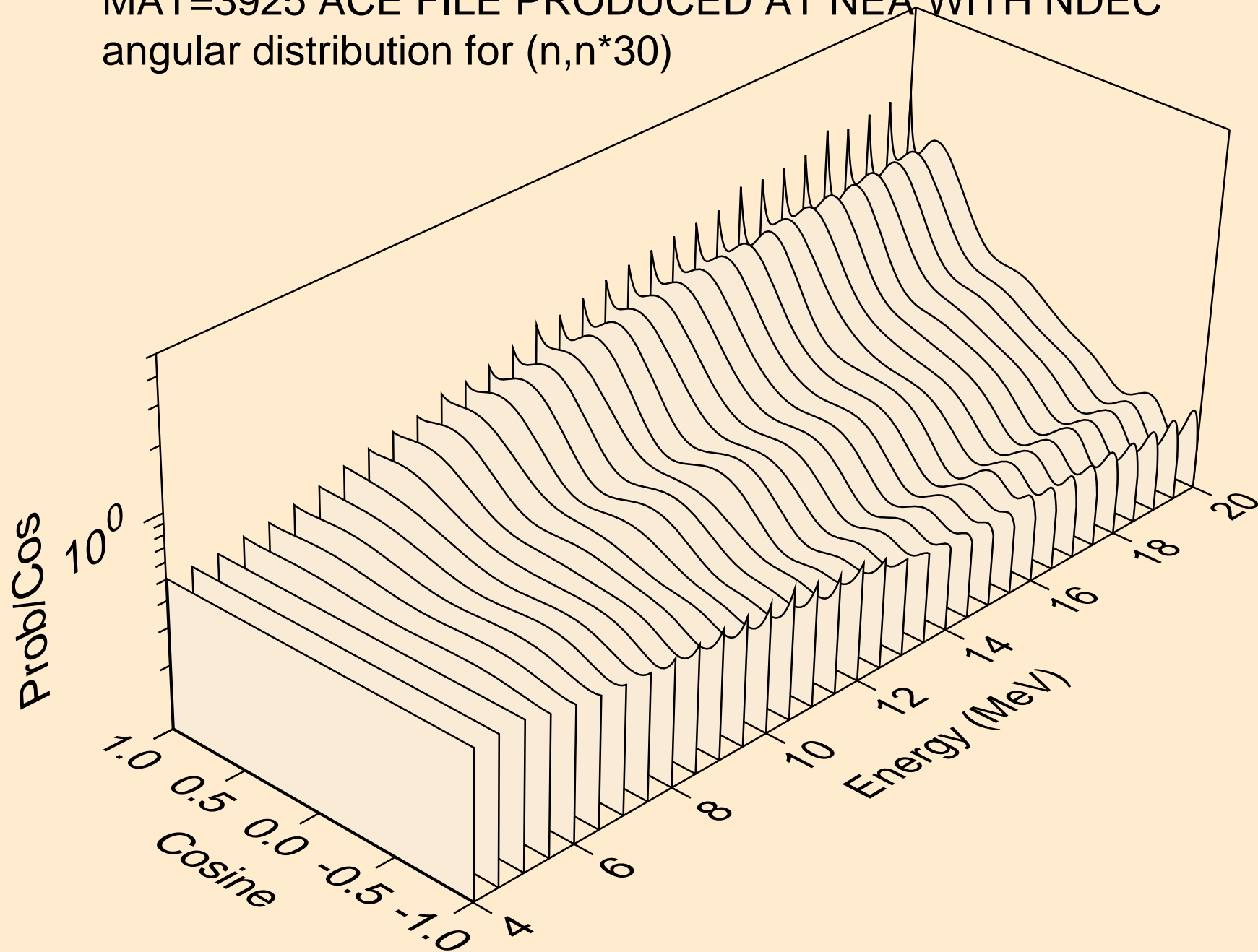



MAT=3925 ACE FILE PRODUCED AT NEA WITH NDEC  
angular distribution for (n,n\*31)

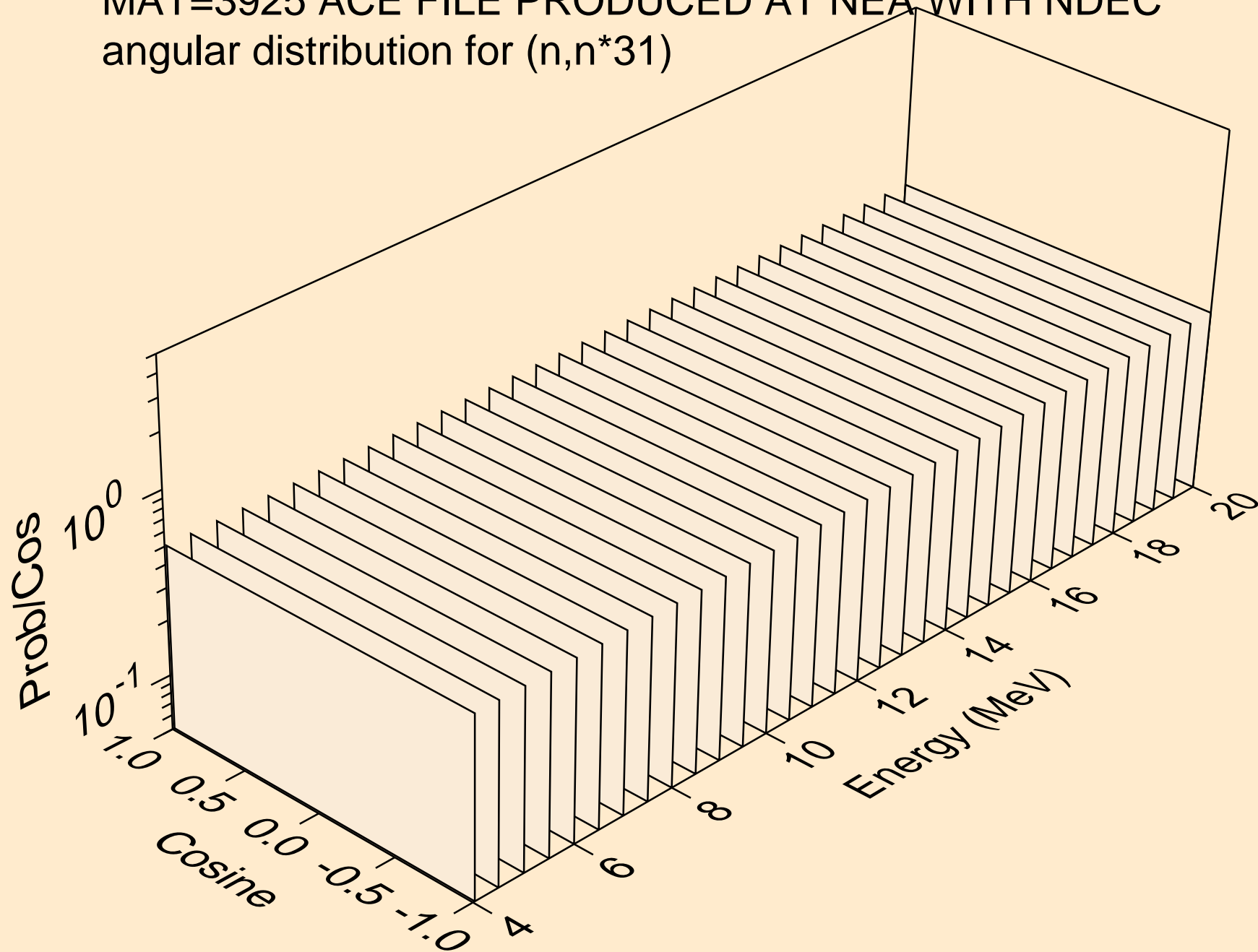

MAT=3925 ACE FILE PRODUCED AT NEA WITH NDEC  
angular distribution for (n,n\*32)

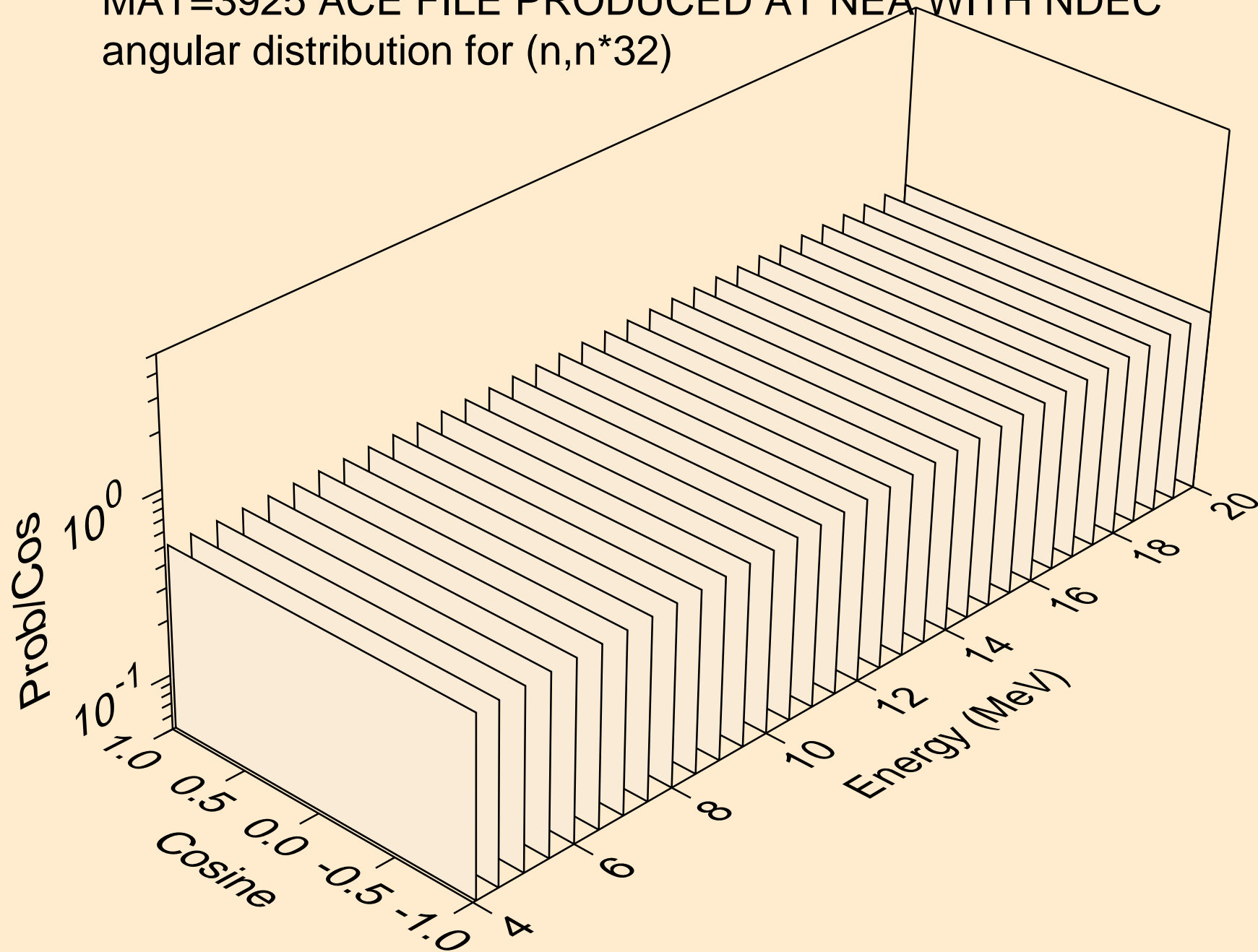

MAT=3925 ACE FILE PRODUCED AT NEA WITH NDEC  
angular distribution for (n,n\*33)

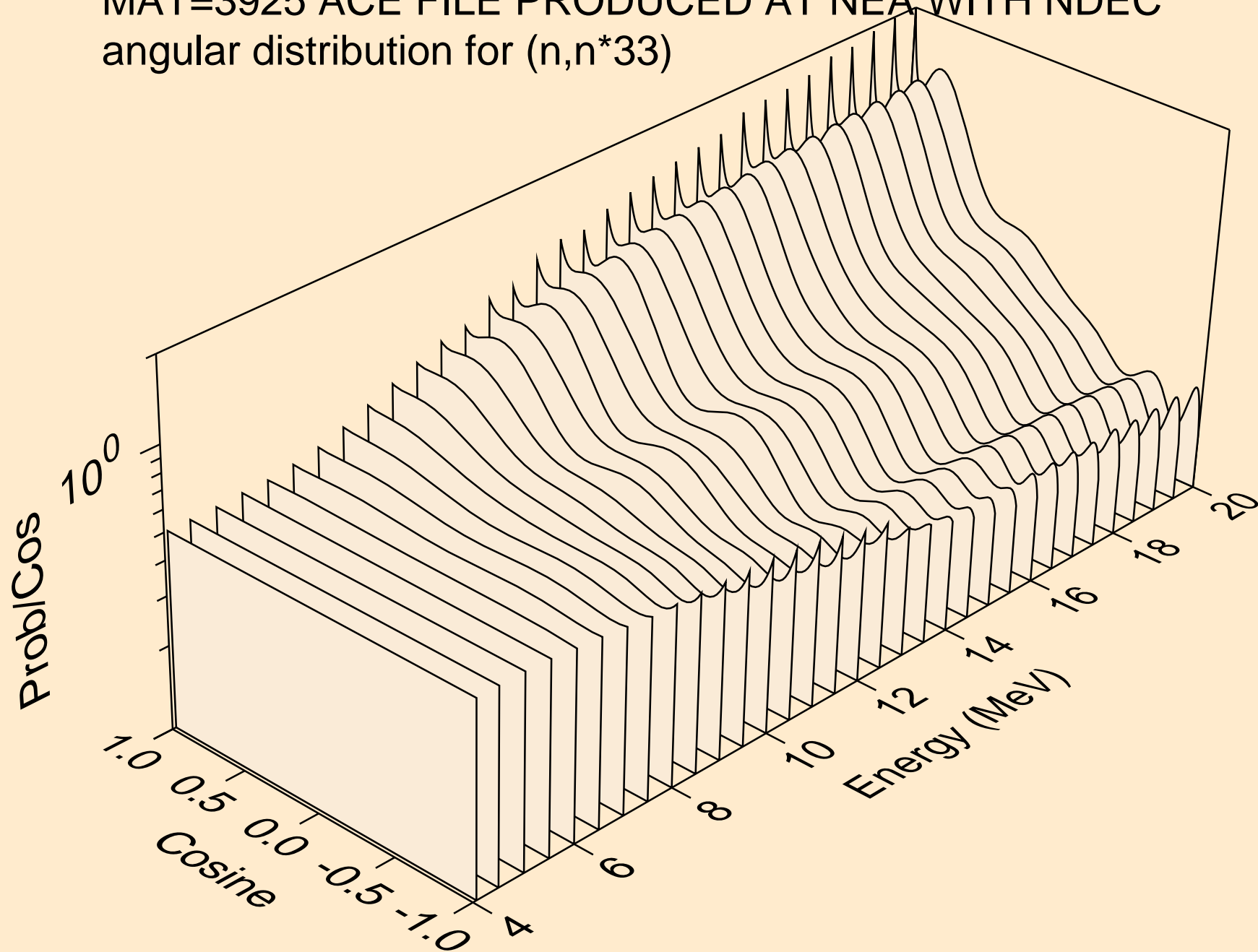

MAT=3925 ACE FILE PRODUCED AT NEA WITH NDEC  
Neutron emission for (n,2n)

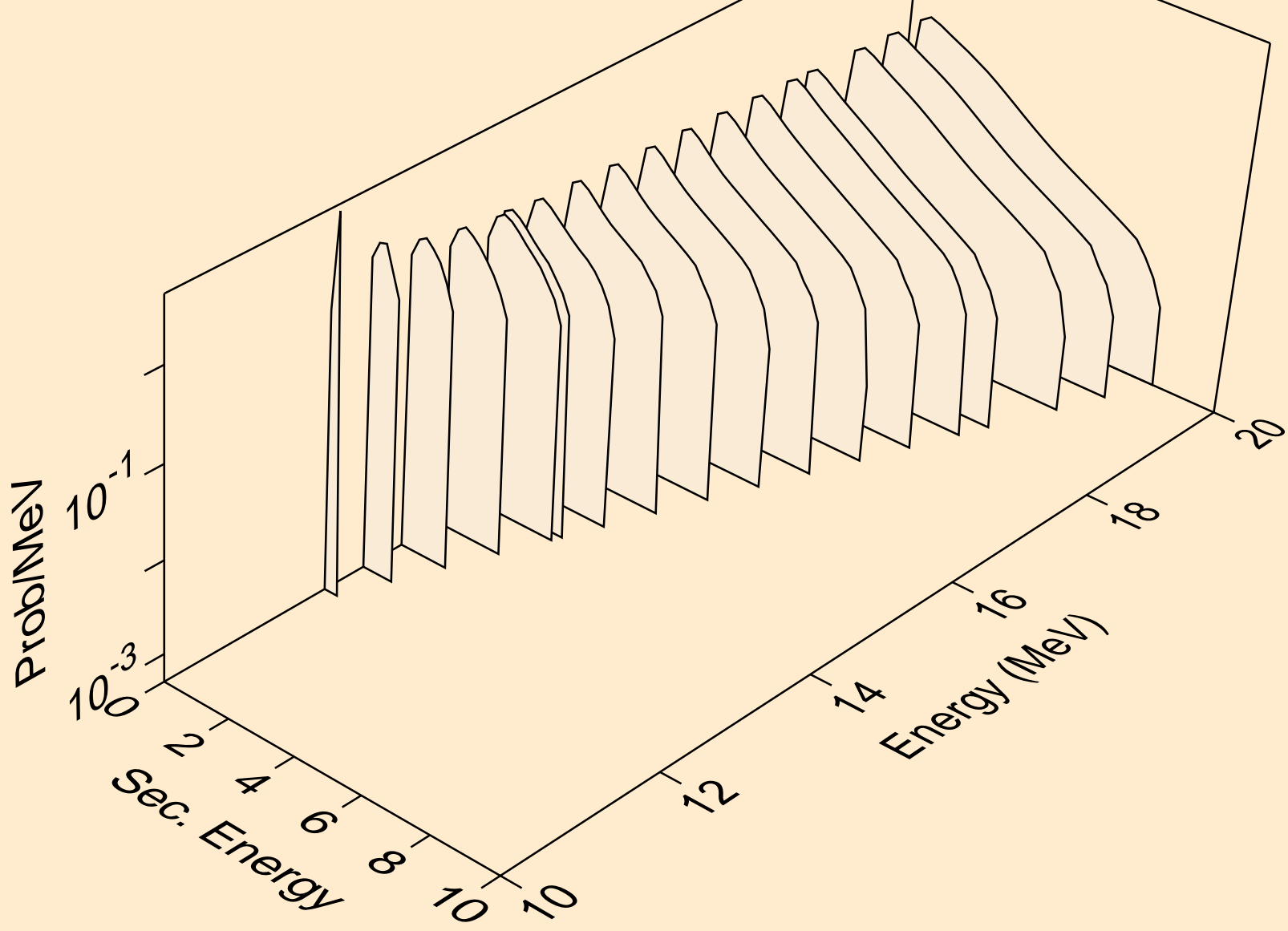

MAT=3925 ACE FILE PRODUCED AT NEA WITH NDEC  
Neutron emission for (n,n\*)a

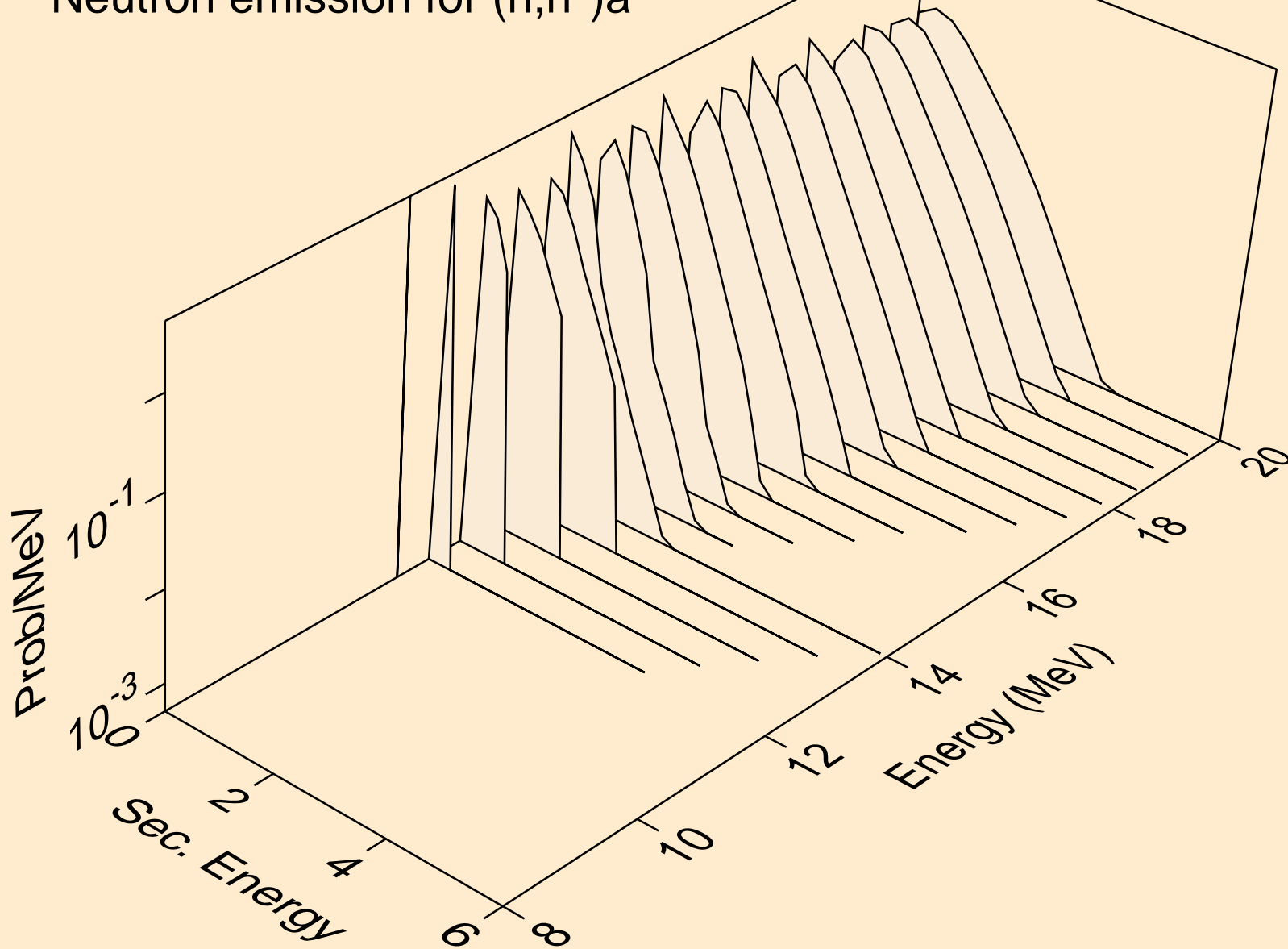

MAT=3925 ACE FILE PRODUCED AT NEA WITH NDEC  
Neutron emission for (n,n\*)p

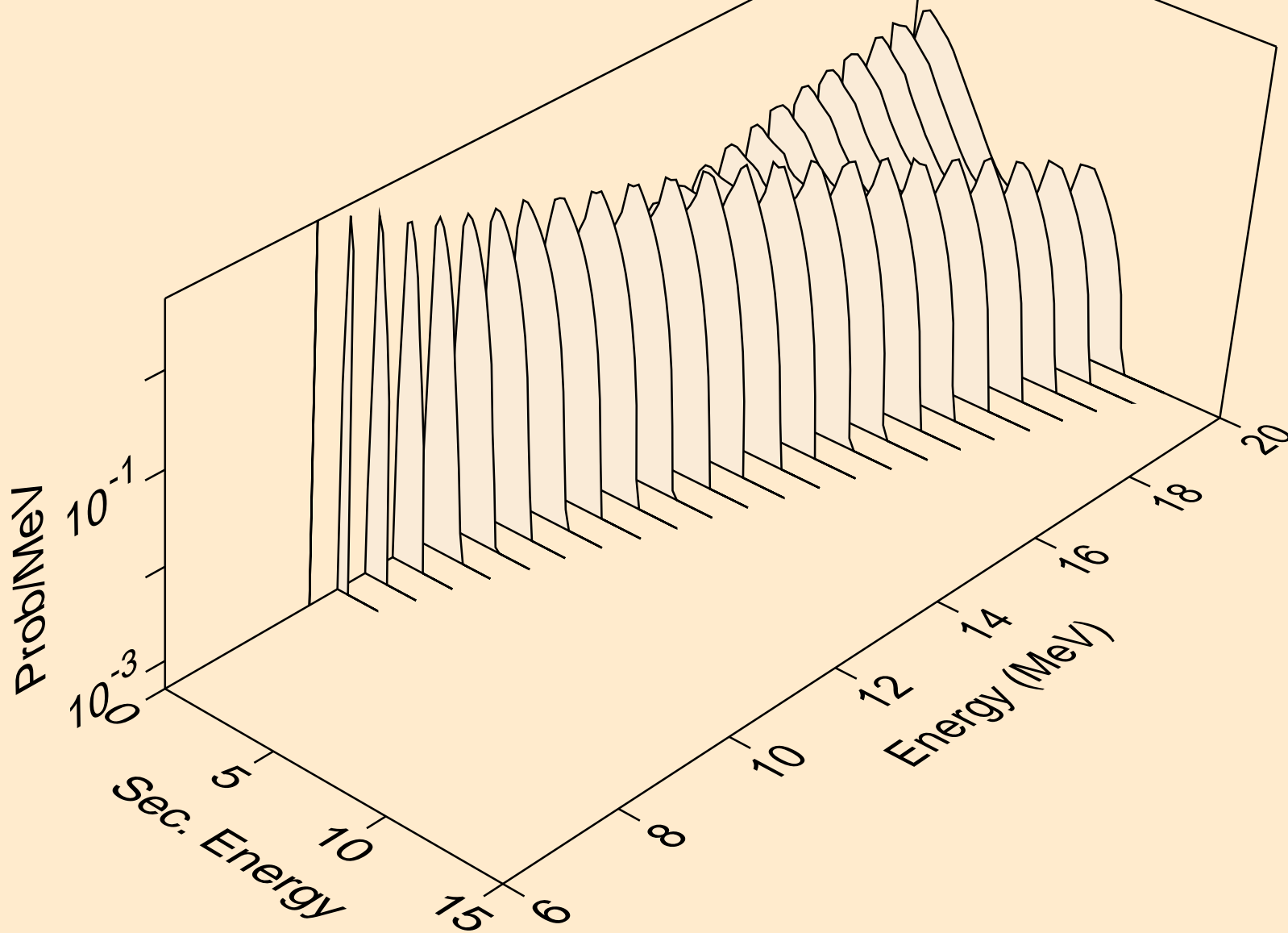

MAT=3925 ACE FILE PRODUCED AT NEA WITH NDEC  
Neutron emission for (n,2np)

|