

MAT=3649 ACE FILE PRODUCED AT NEA WITH NDEC  
Principal cross sections

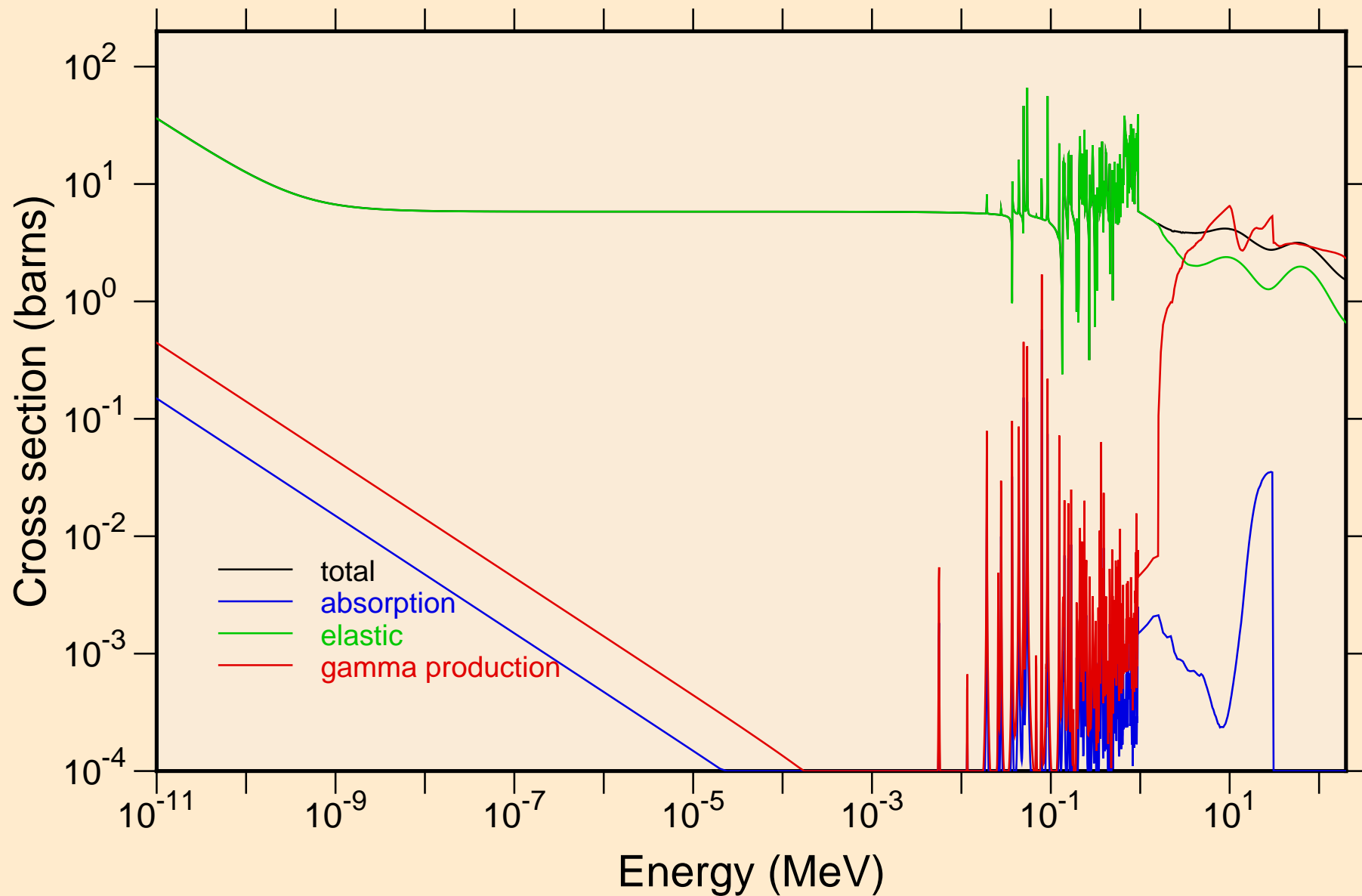

MAT=3649 ACE FILE PRODUCED AT NEA WITH NDEC  
resonance total cross section

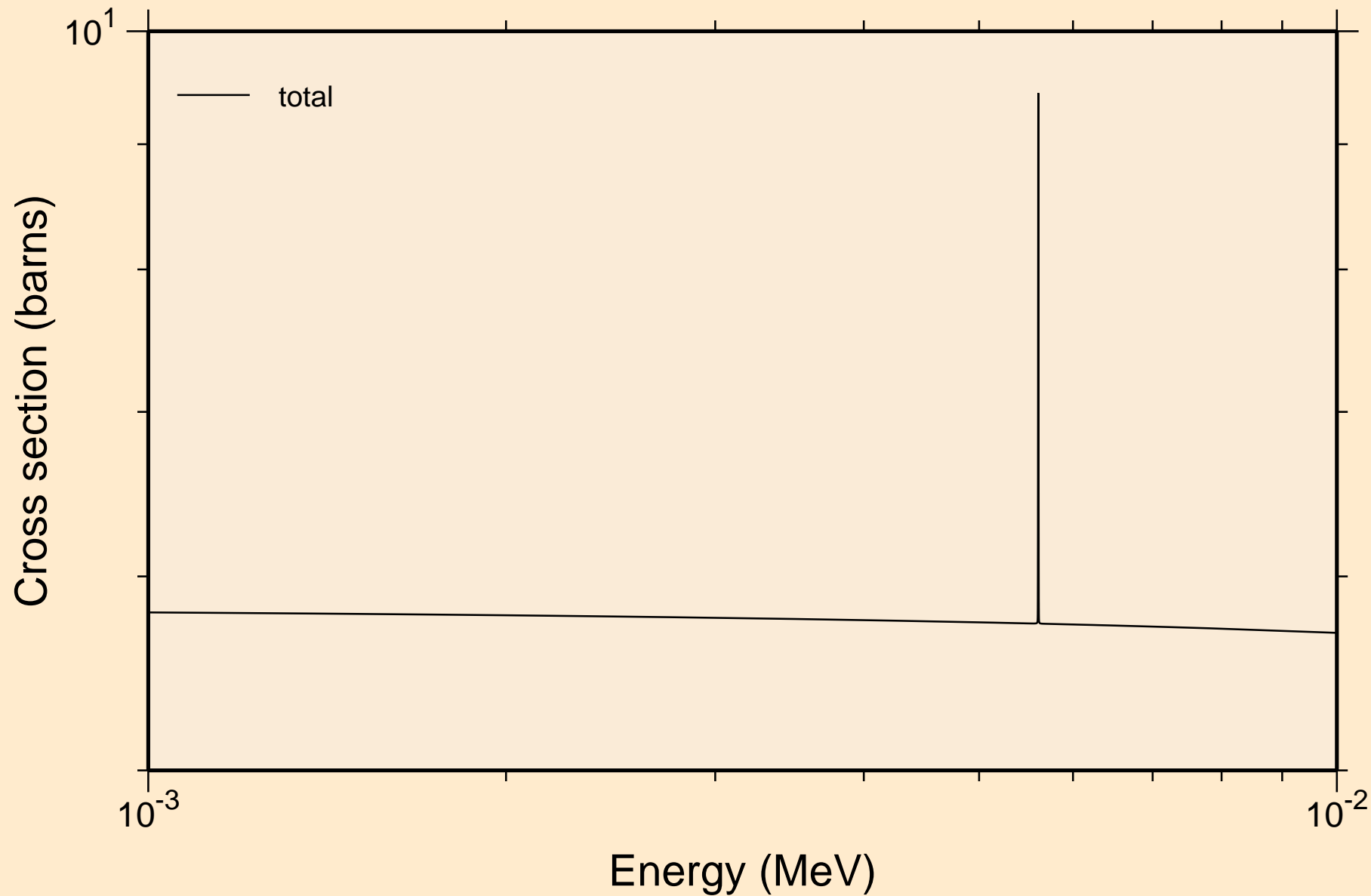

MAT=3649 ACE FILE PRODUCED AT NEA WITH NDEC  
resonance total cross section

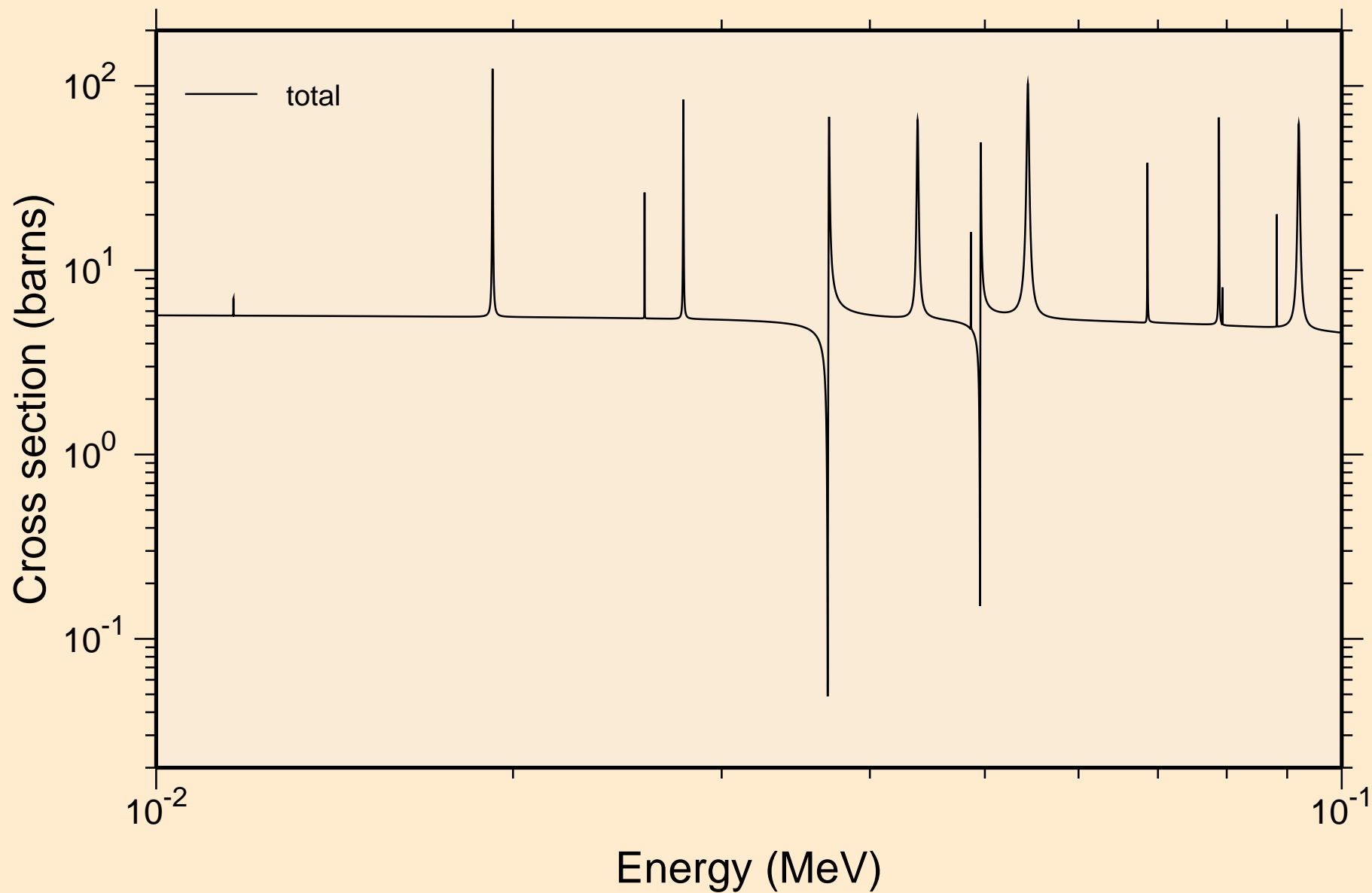

MAT=3649 ACE FILE PRODUCED AT NEA WITH NDEC  
resonance total cross section

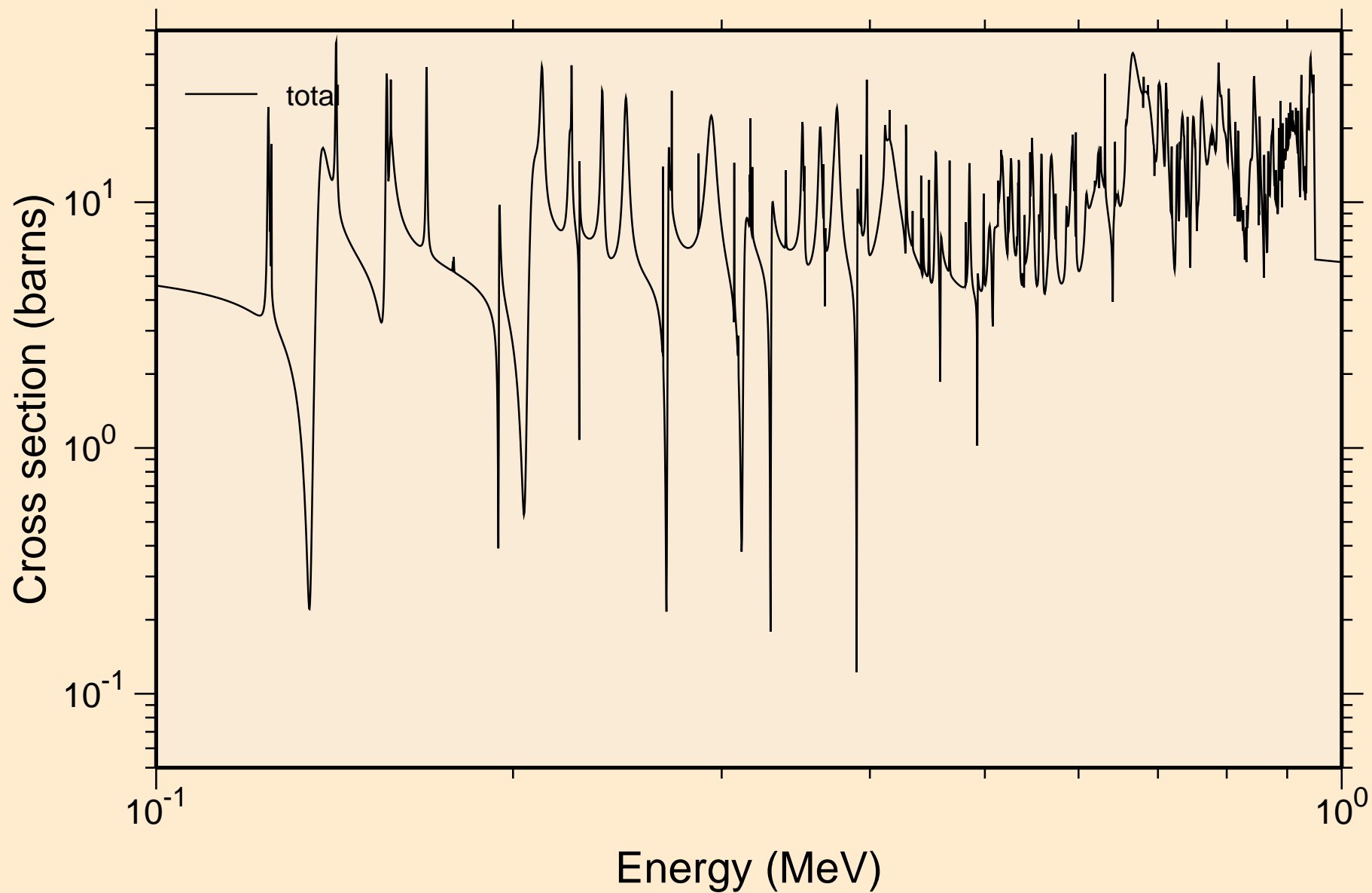

MAT=3649 ACE FILE PRODUCED AT NEA WITH NDEC  
resonance total cross section

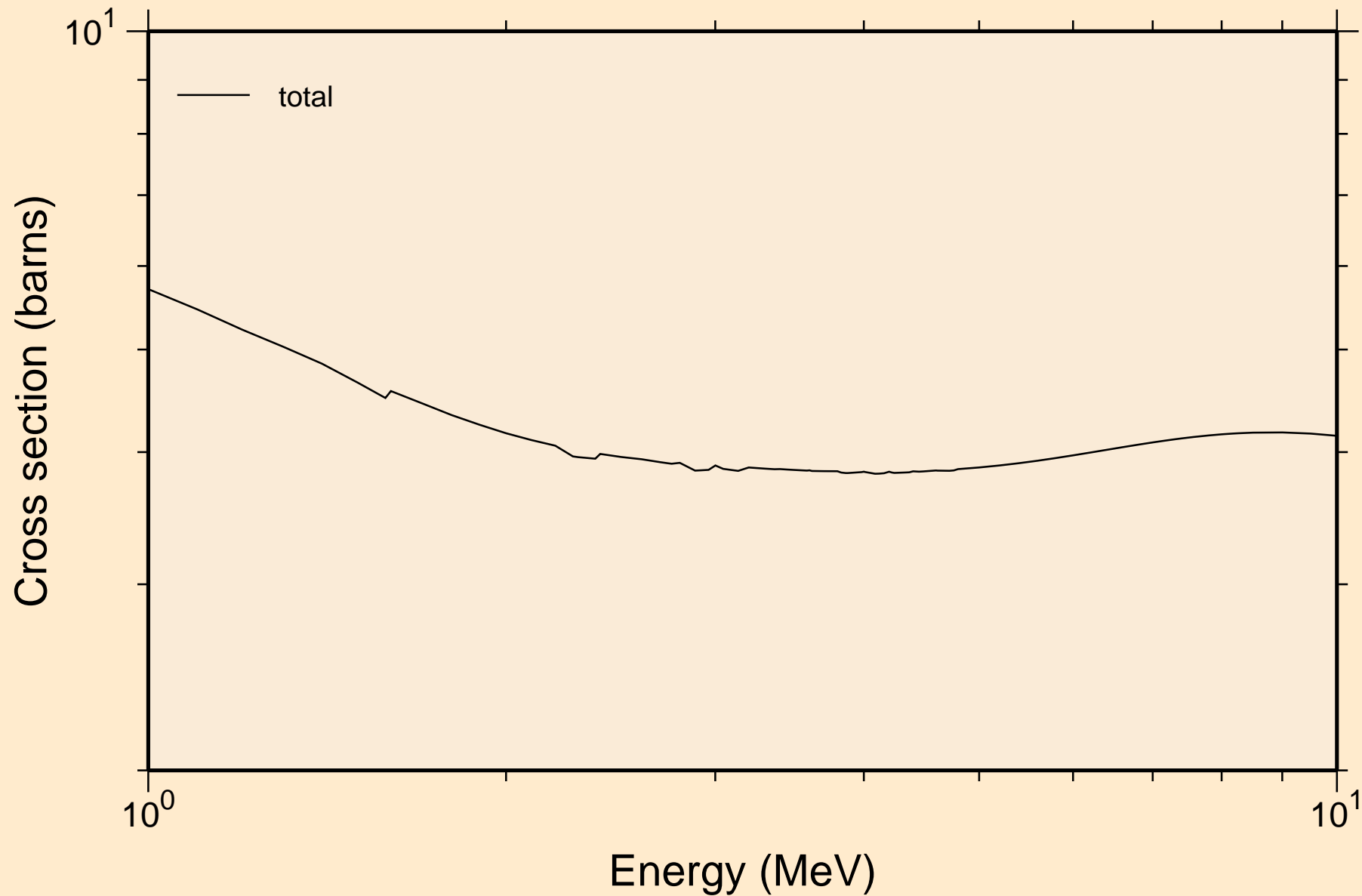

MAT=3649 ACE FILE PRODUCED AT NEA WITH NDEC  
resonance absorption cross sections

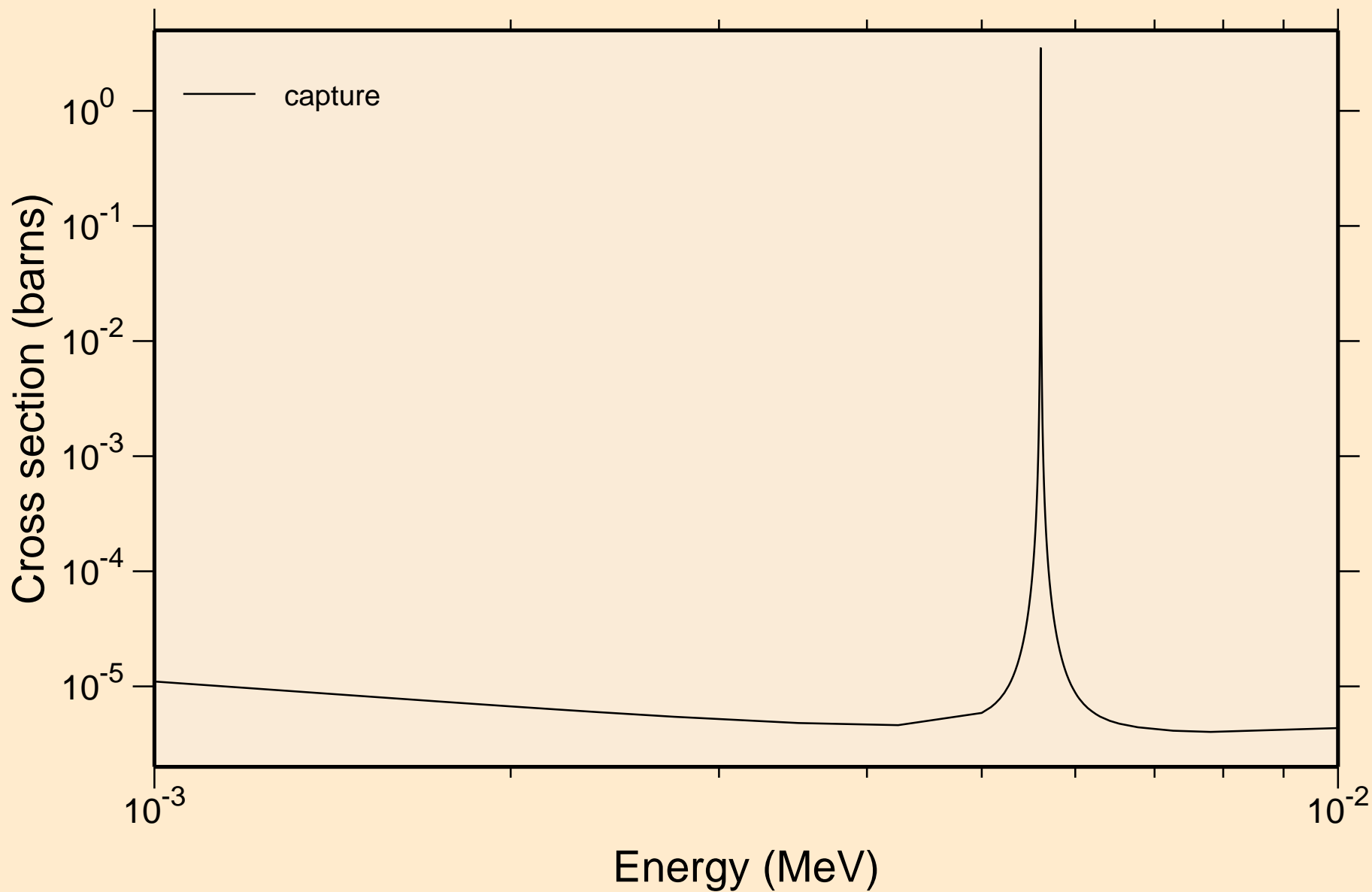

MAT=3649 ACE FILE PRODUCED AT NEA WITH NDEC  
resonance absorption cross sections

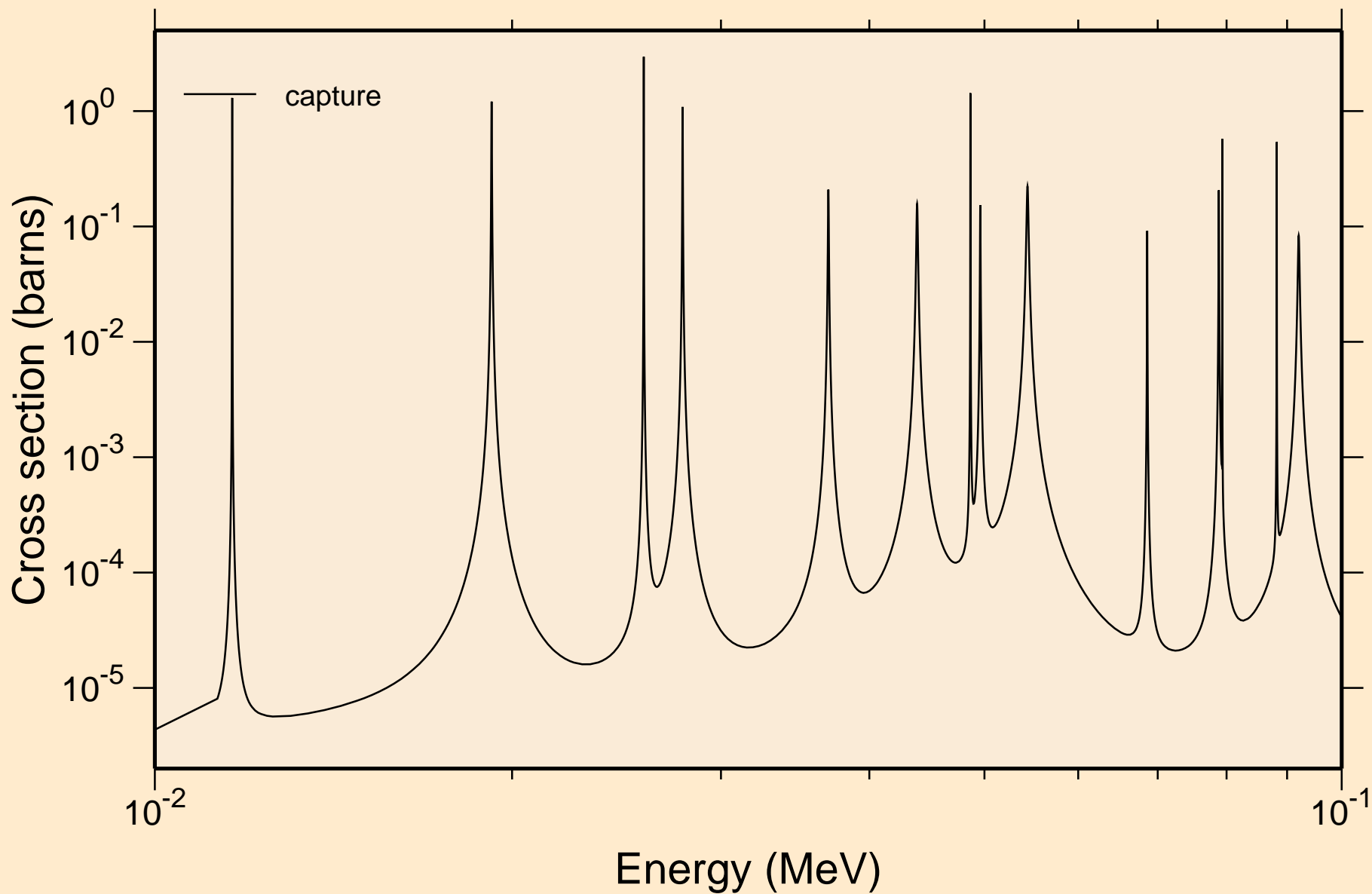

MAT=3649 ACE FILE PRODUCED AT NEA WITH NDEC  
resonance absorption cross sections

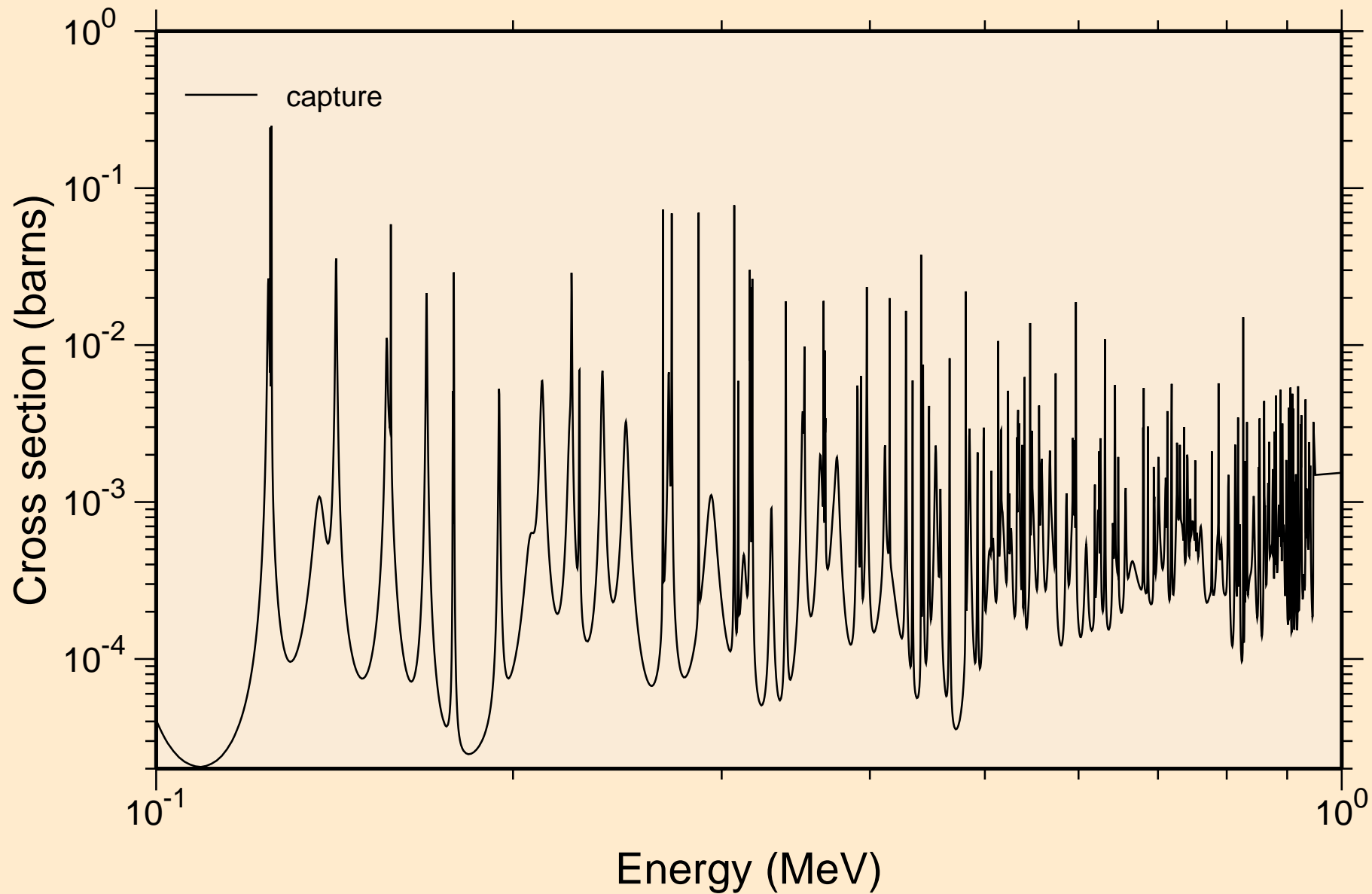

MAT=3649 ACE FILE PRODUCED AT NEA WITH NDEC  
resonance absorption cross sections

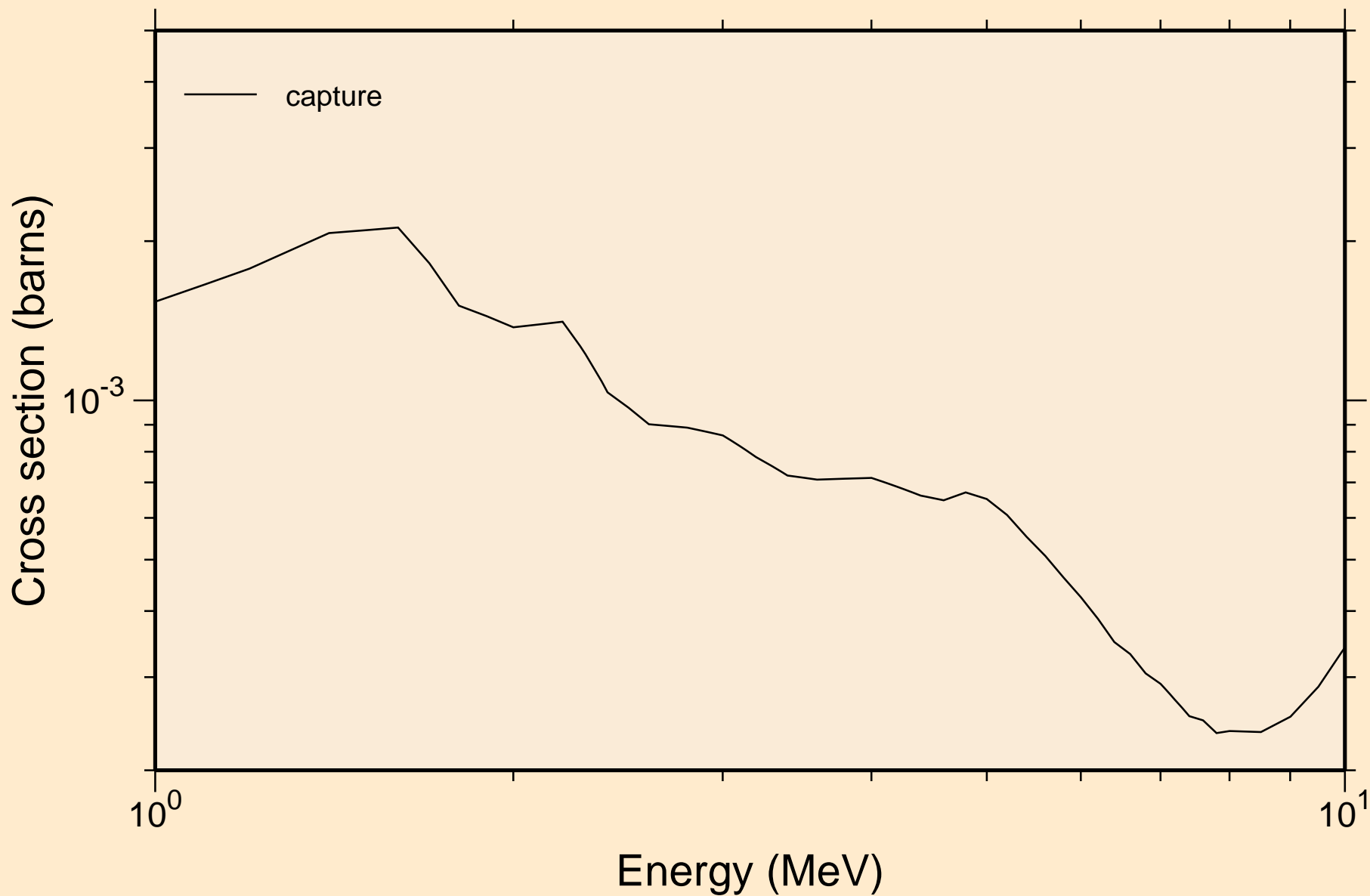

MAT=3649 ACE FILE PRODUCED AT NEA WITH NDEC  
Heating

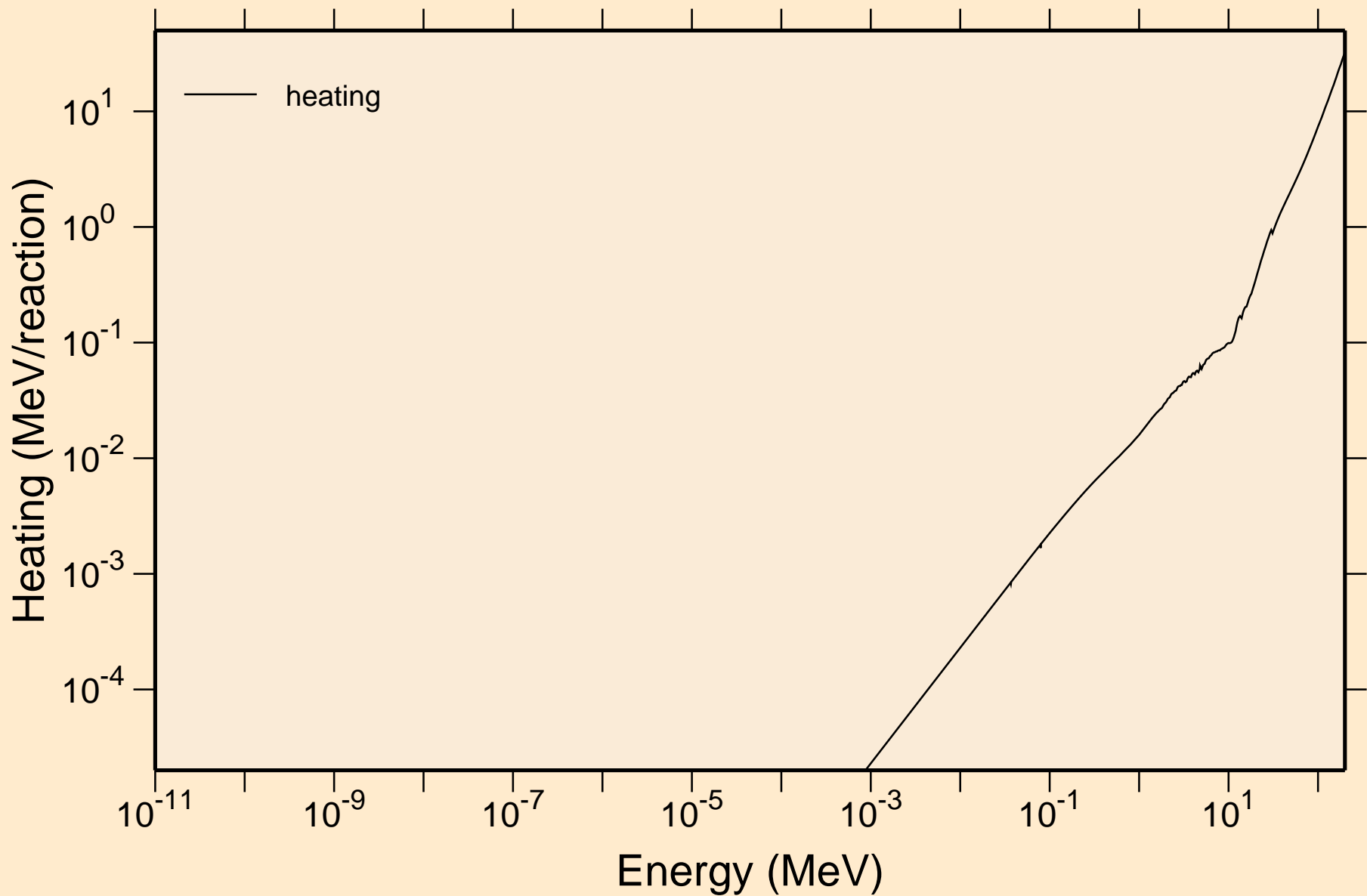

MAT=3649 ACE FILE PRODUCED AT NEA WITH NDEC  
Damage

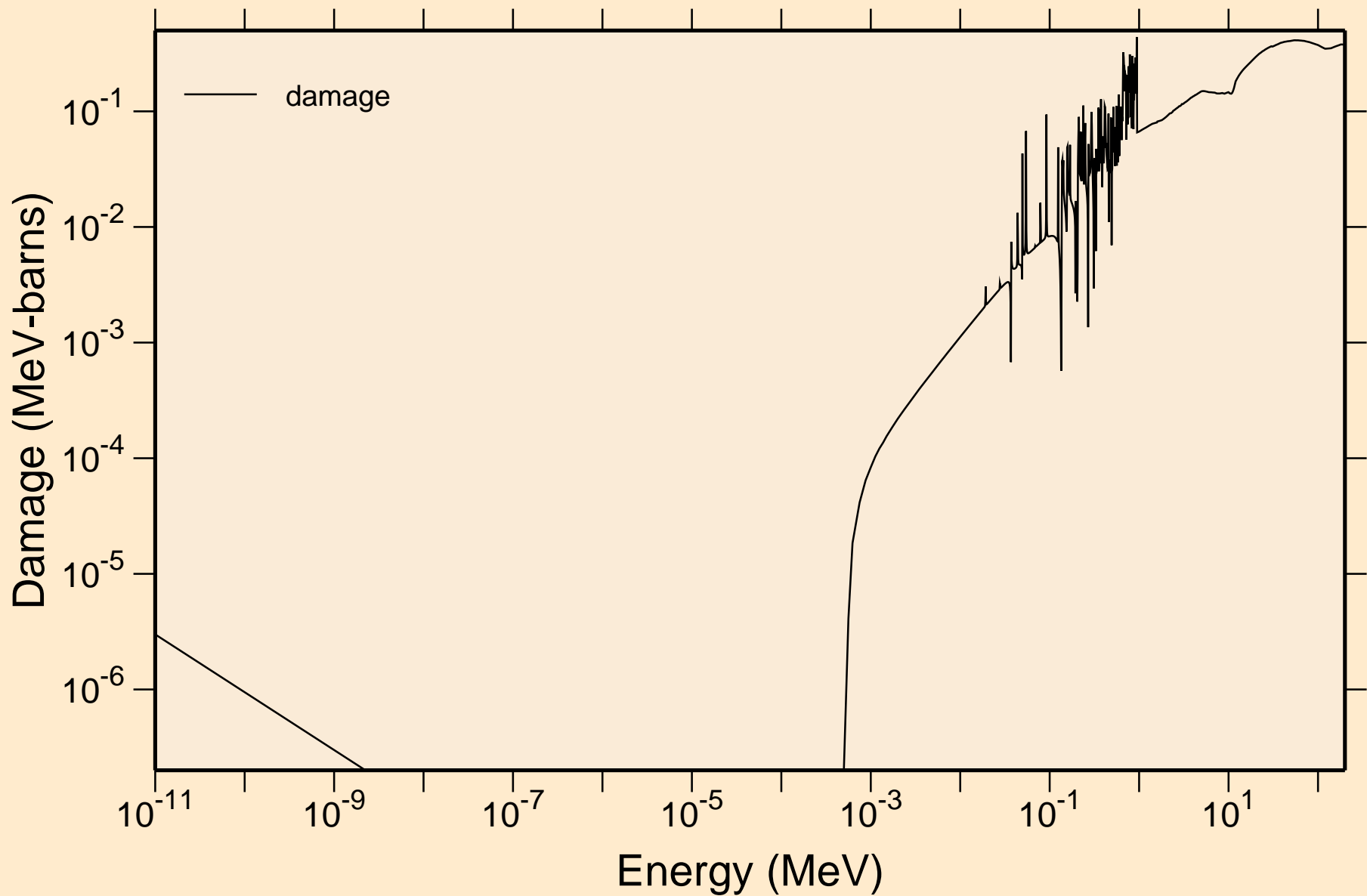

MAT=3649 ACE FILE PRODUCED AT NEA WITH NDEC  
Non-threshold reactions

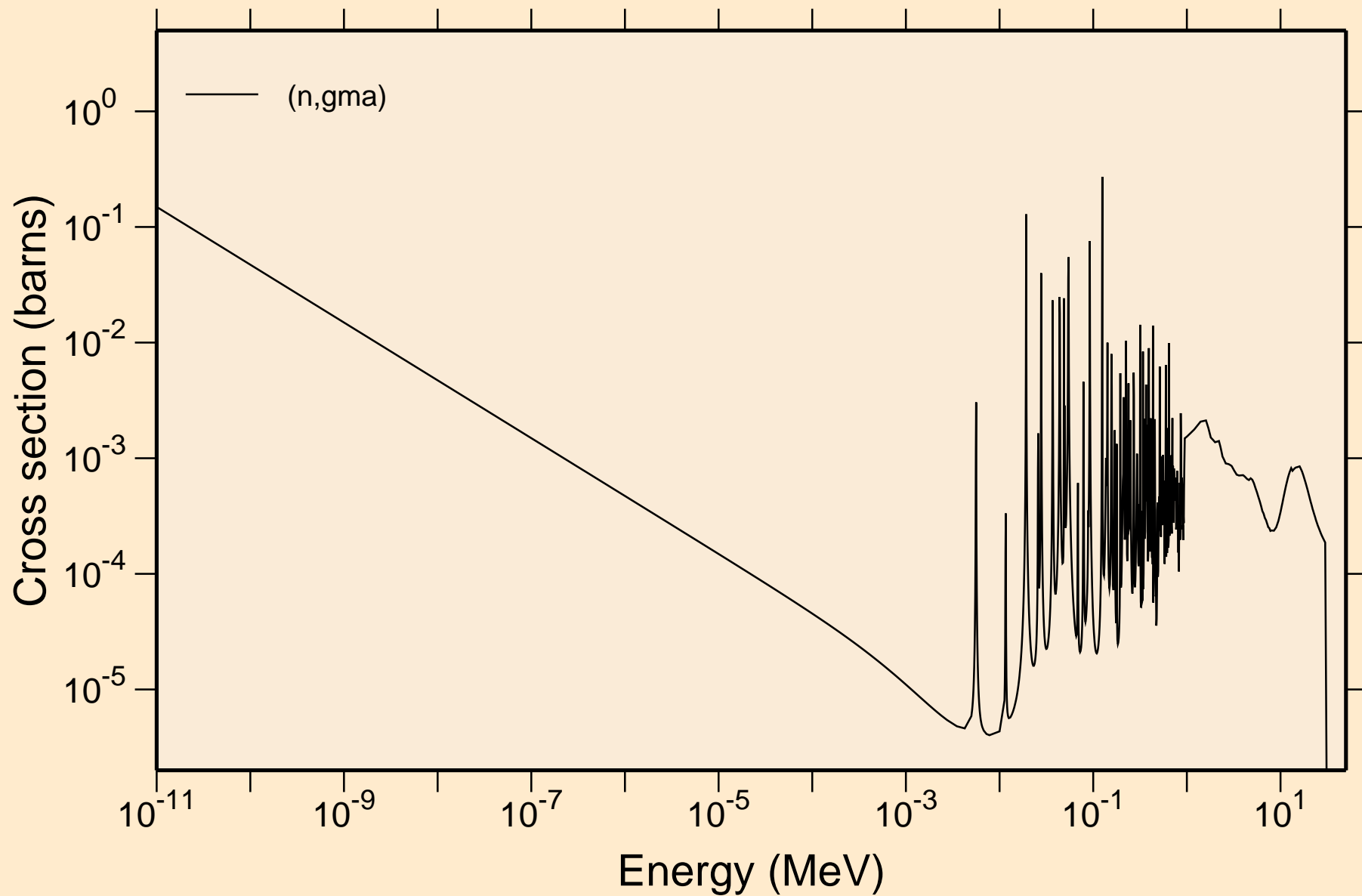

MAT=3649 ACE FILE PRODUCED AT NEA WITH NDEC

Principal cross sections

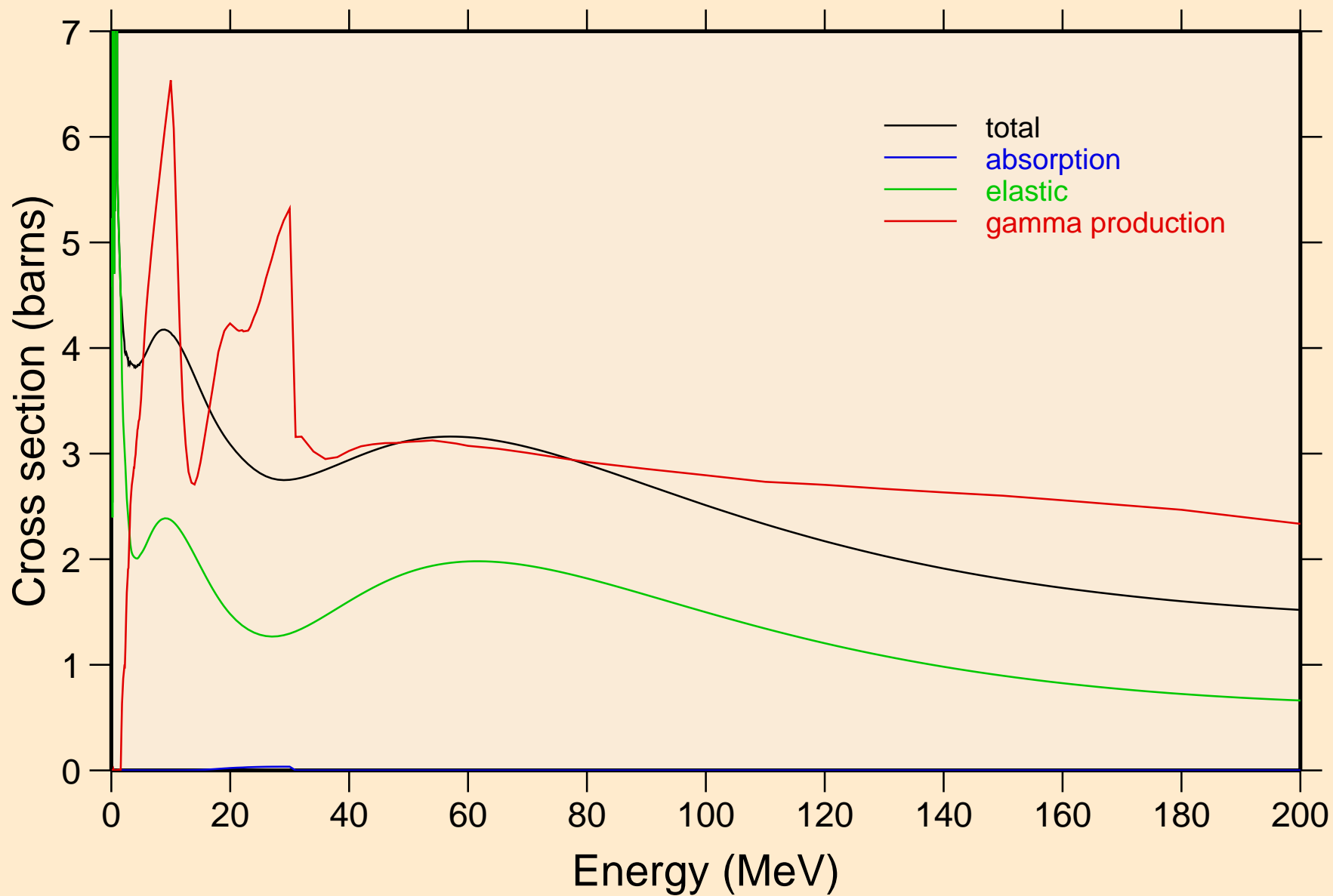

MAT=3649 ACE FILE PRODUCED AT NEA WITH NDEC  
Heating

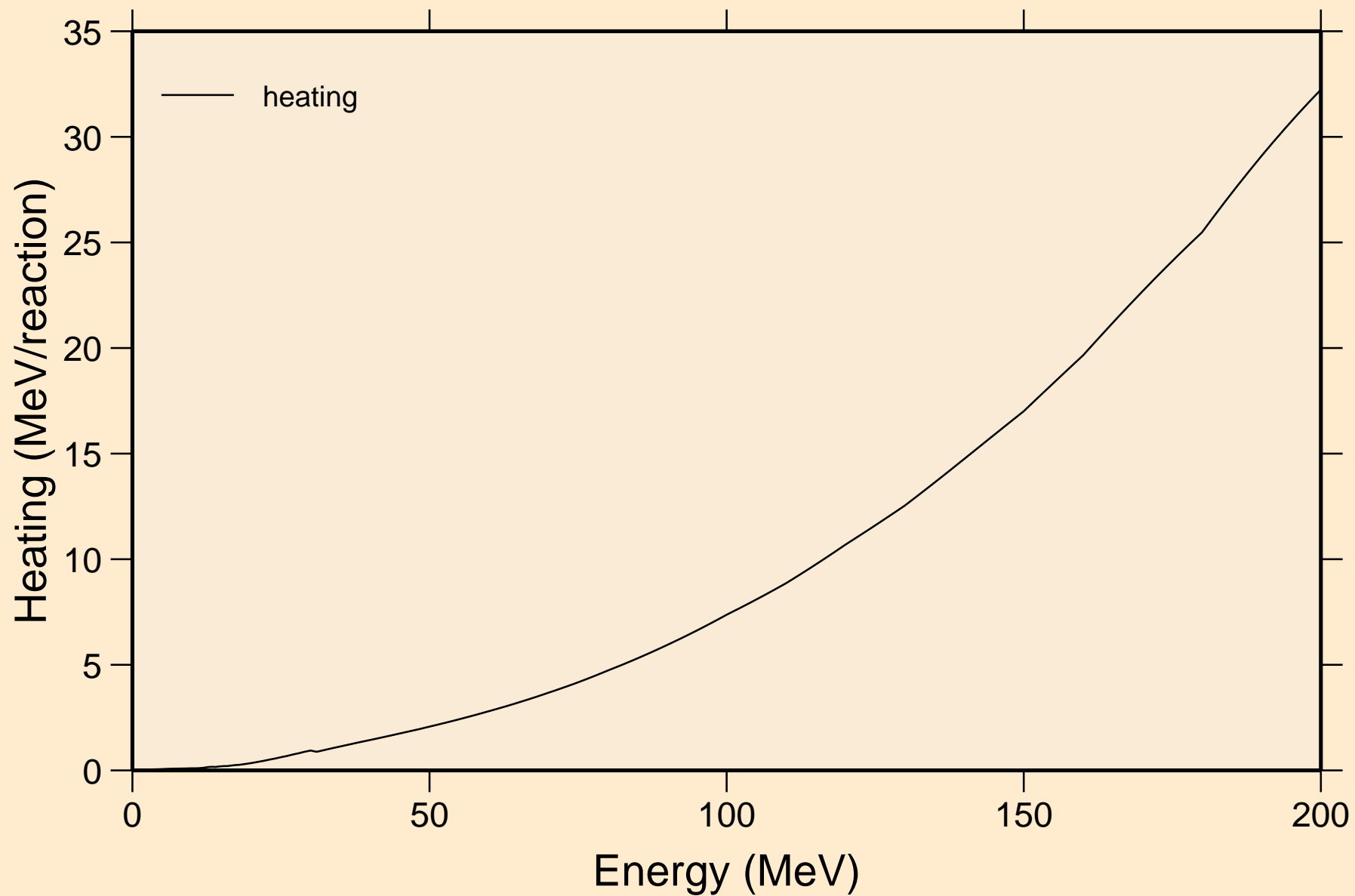

MAT=3649 ACE FILE PRODUCED AT NEA WITH NDEC  
Damage

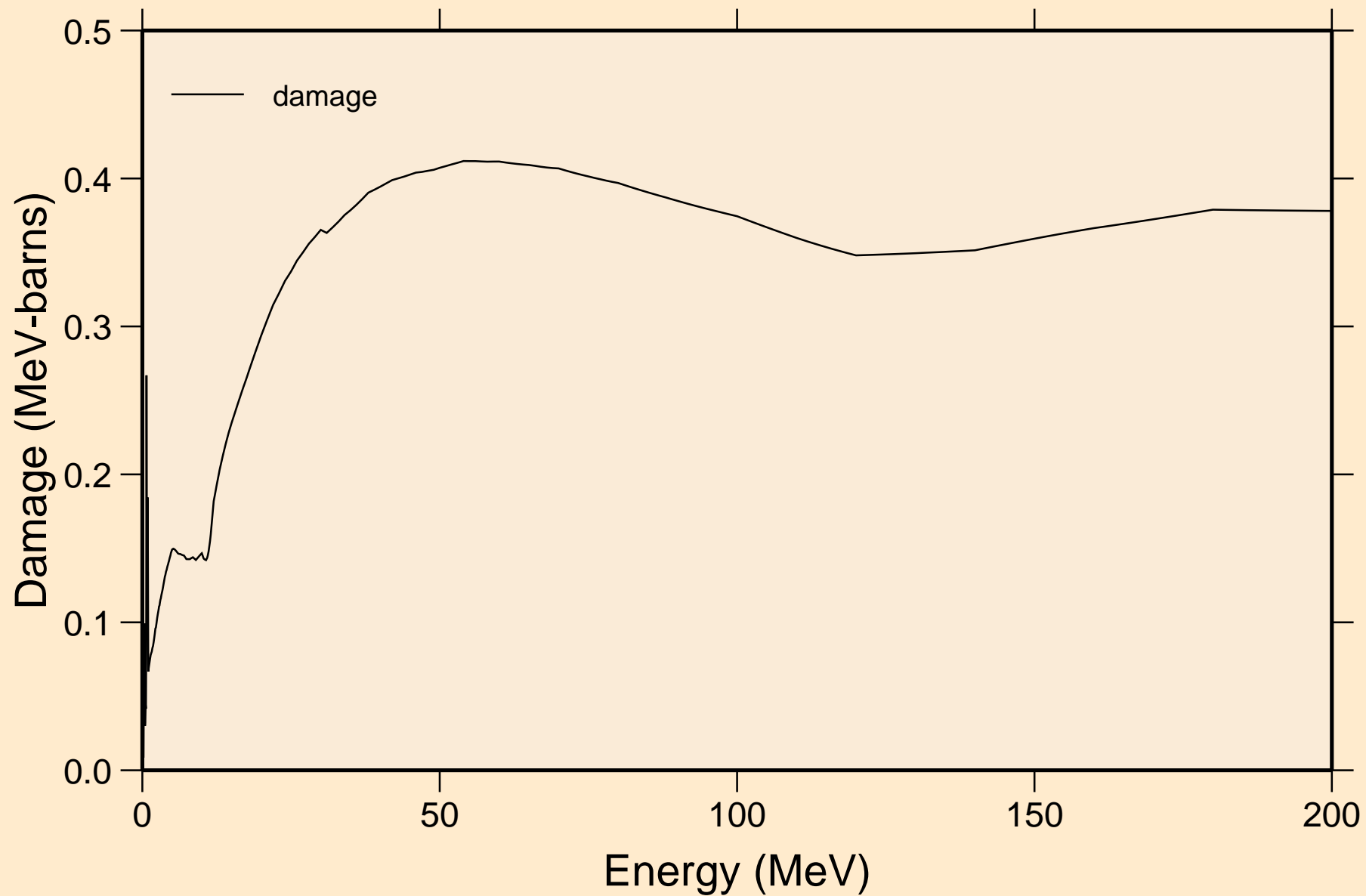

MAT=3649 ACE FILE PRODUCED AT NEA WITH NDEC  
Non-threshold reactions

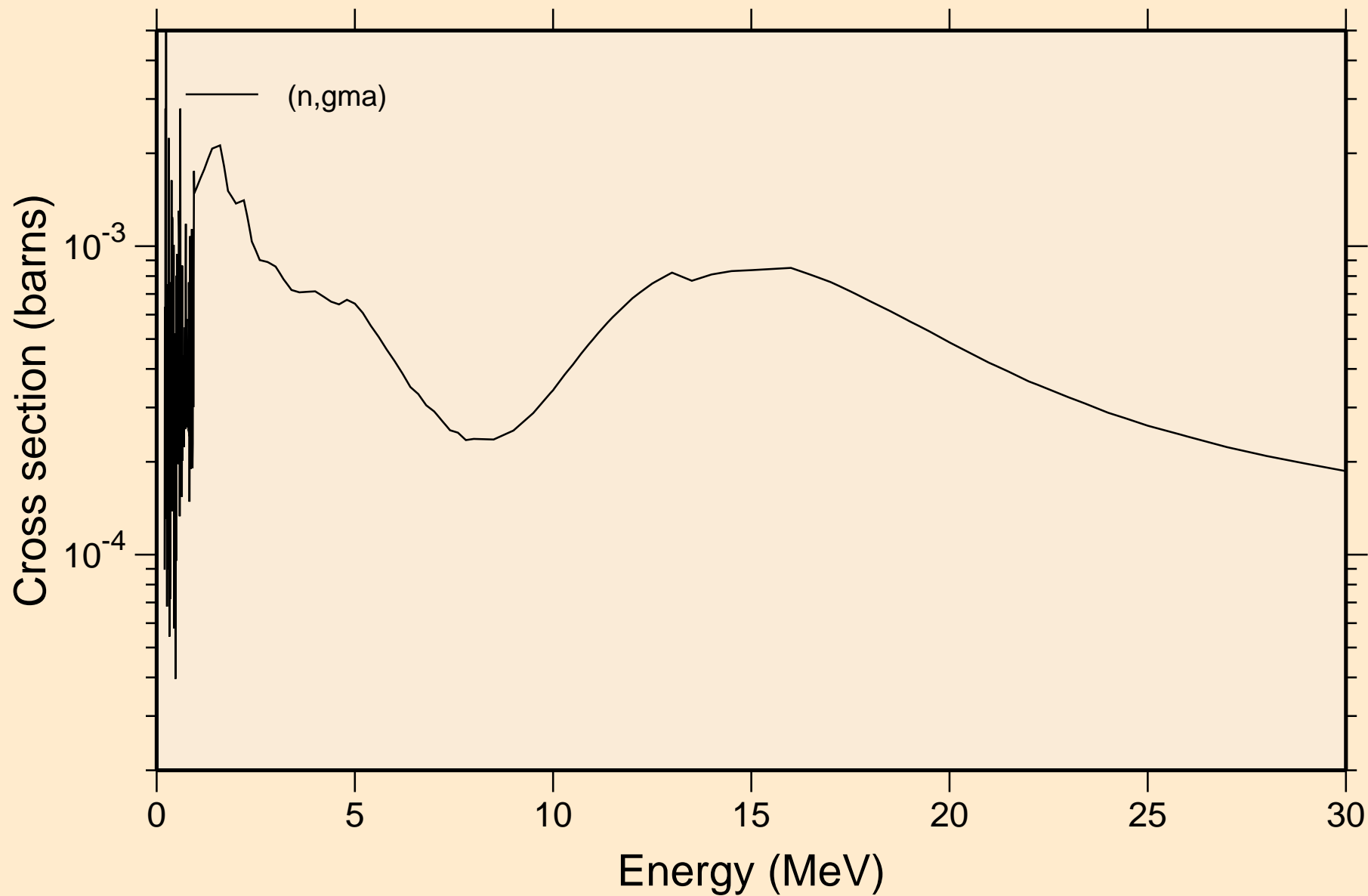

MAT=3649 ACE FILE PRODUCED AT NEA WITH NDEC  
Inelastic levels

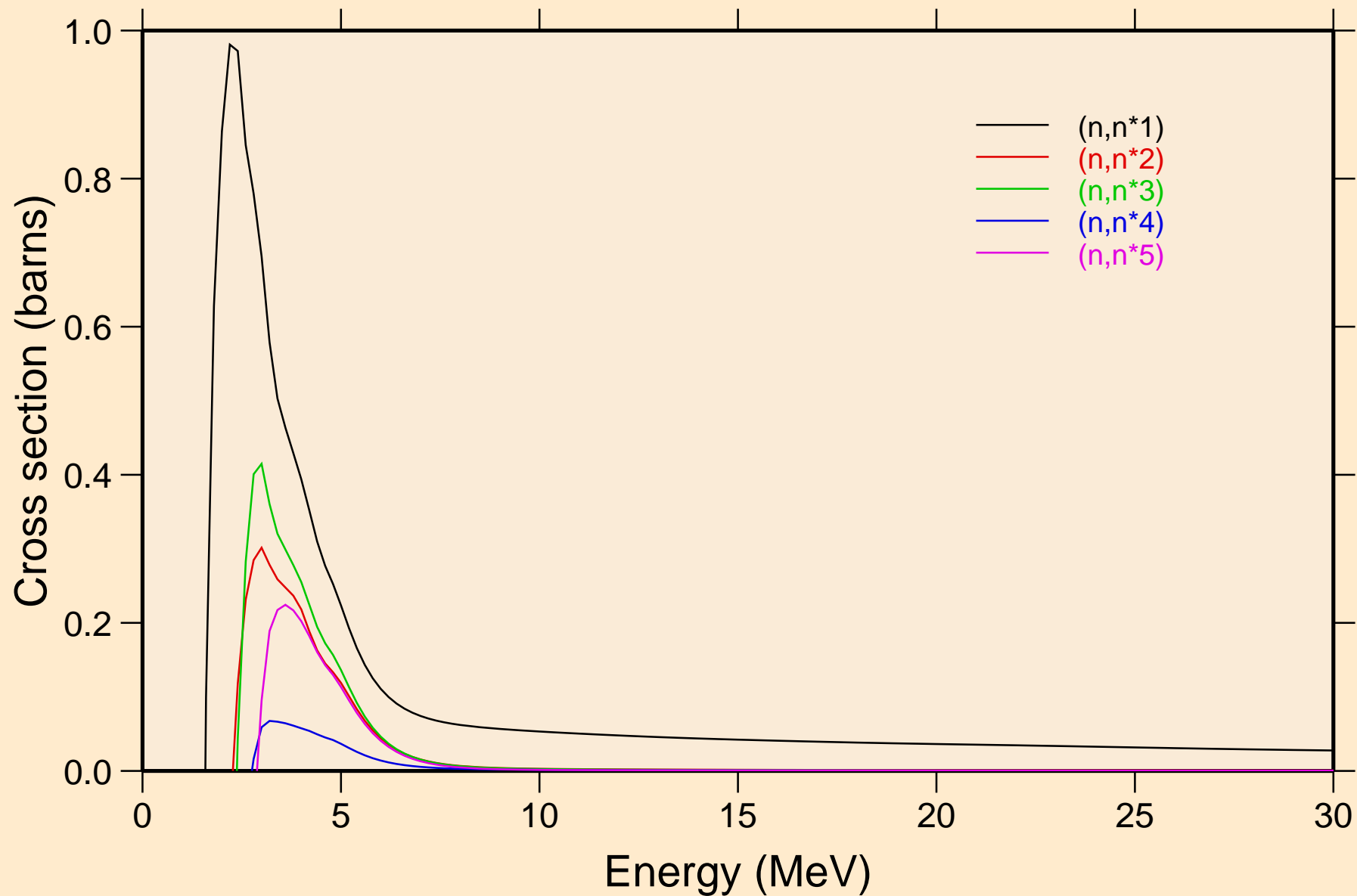

MAT=3649 ACE FILE PRODUCED AT NEA WITH NDEC  
Inelastic levels

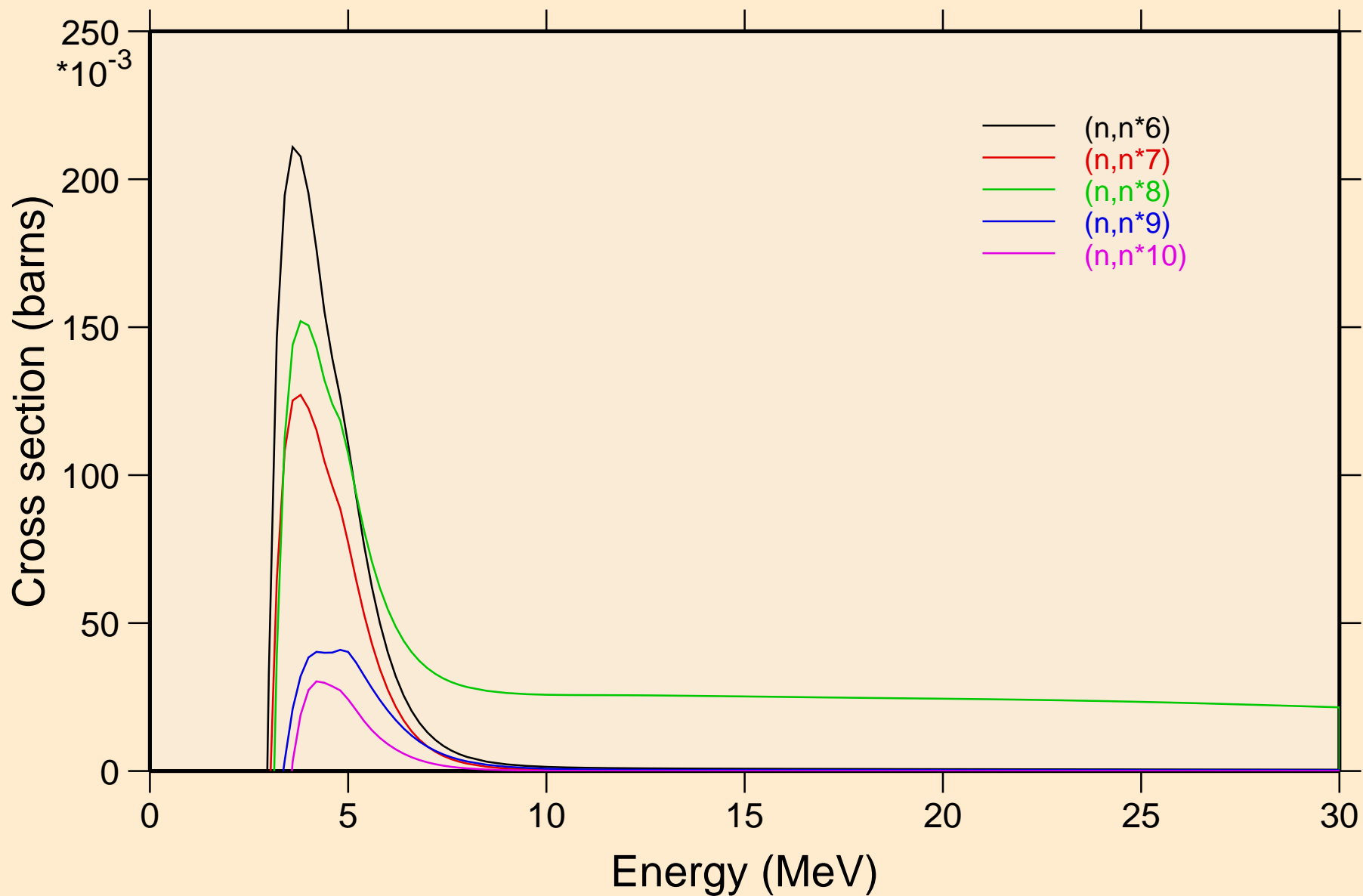

MAT=3649 ACE FILE PRODUCED AT NEA WITH NDEC  
Inelastic levels

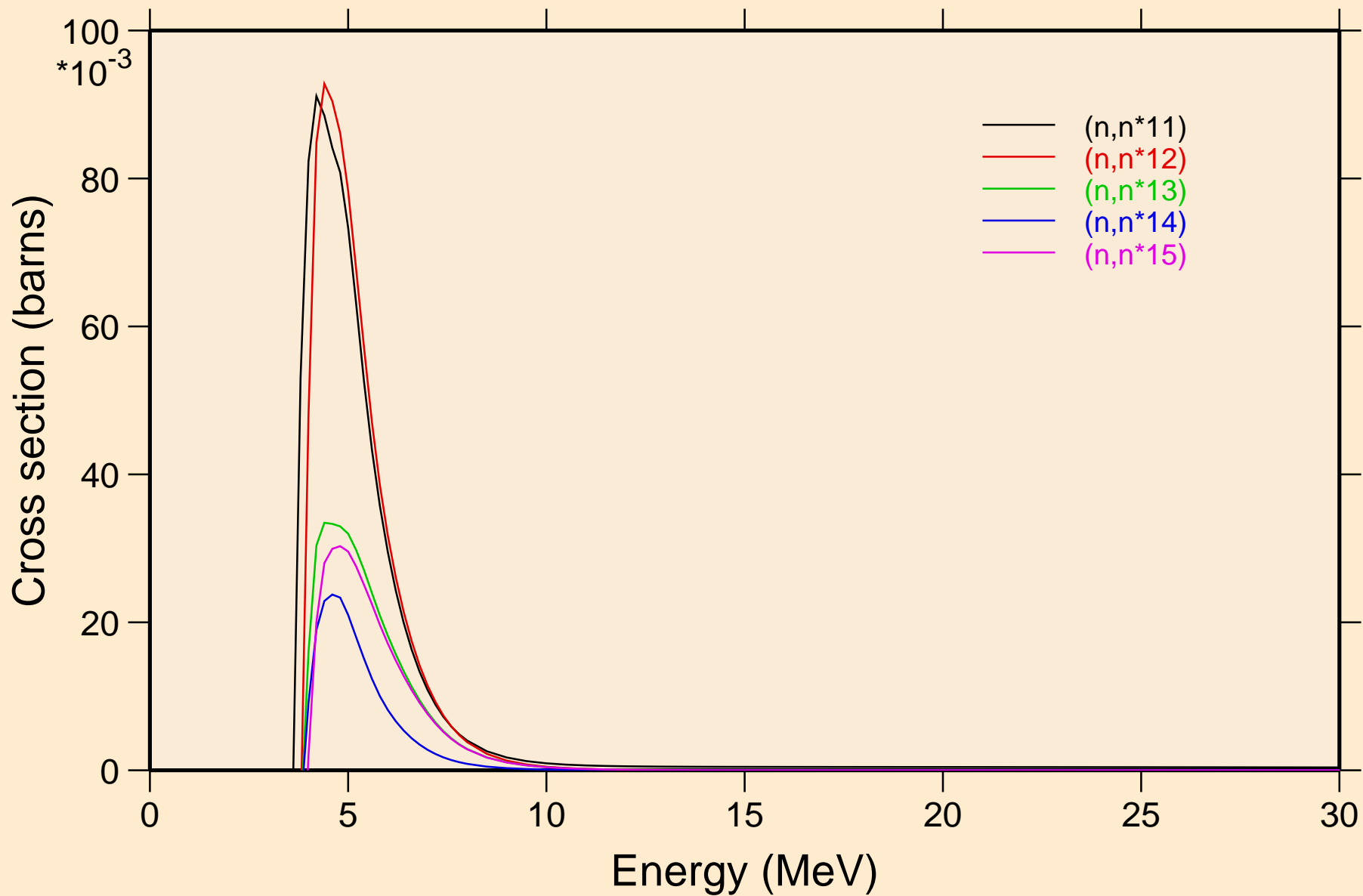

MAT=3649 ACE FILE PRODUCED AT NEA WITH NDEC  
Inelastic levels

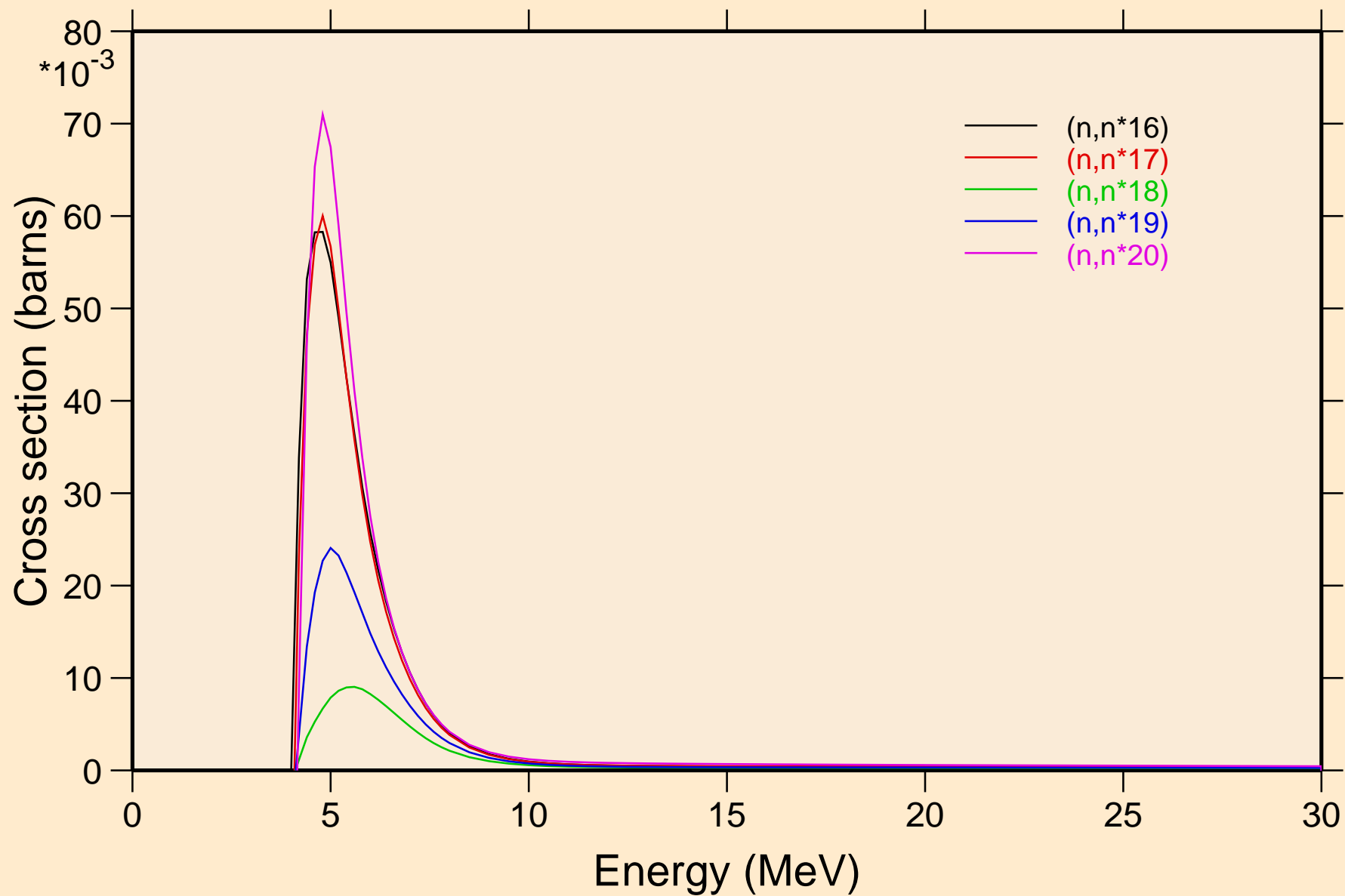

MAT=3649 ACE FILE PRODUCED AT NEA WITH NDEC  
Inelastic levels

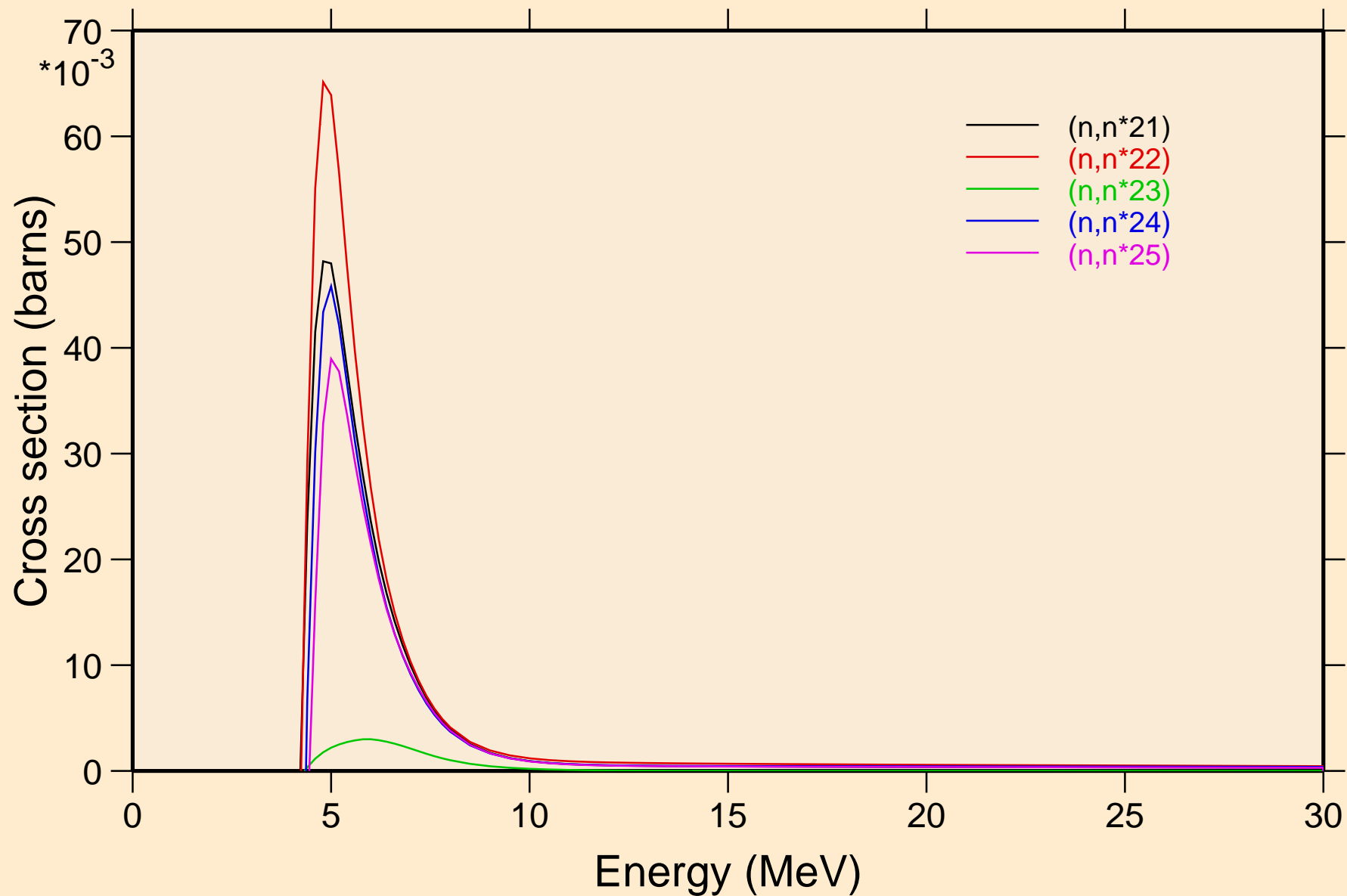

MAT=3649 ACE FILE PRODUCED AT NEA WITH NDEC  
Inelastic levels

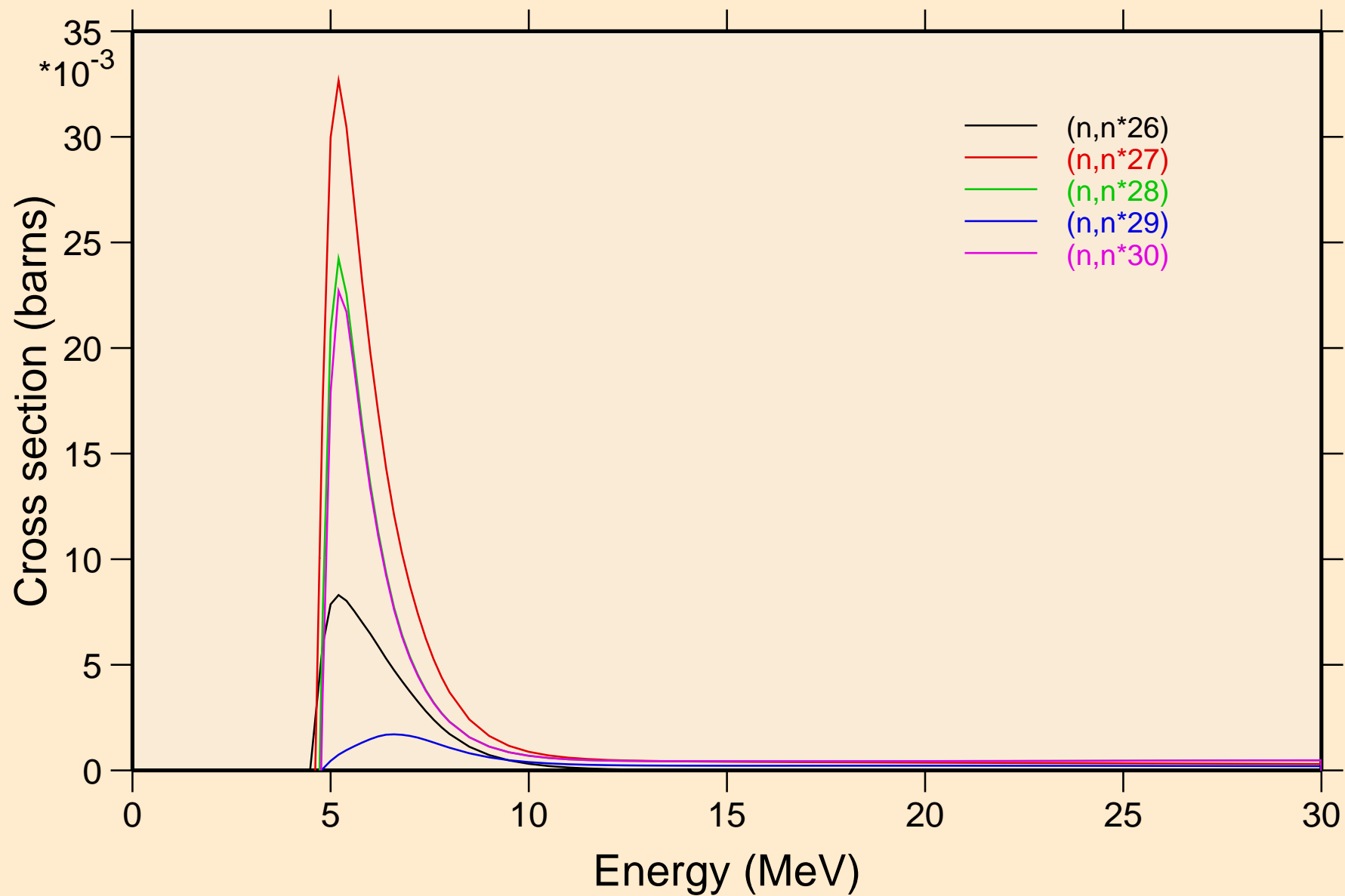

MAT=3649 ACE FILE PRODUCED AT NEA WITH NDEC  
Threshold reactions

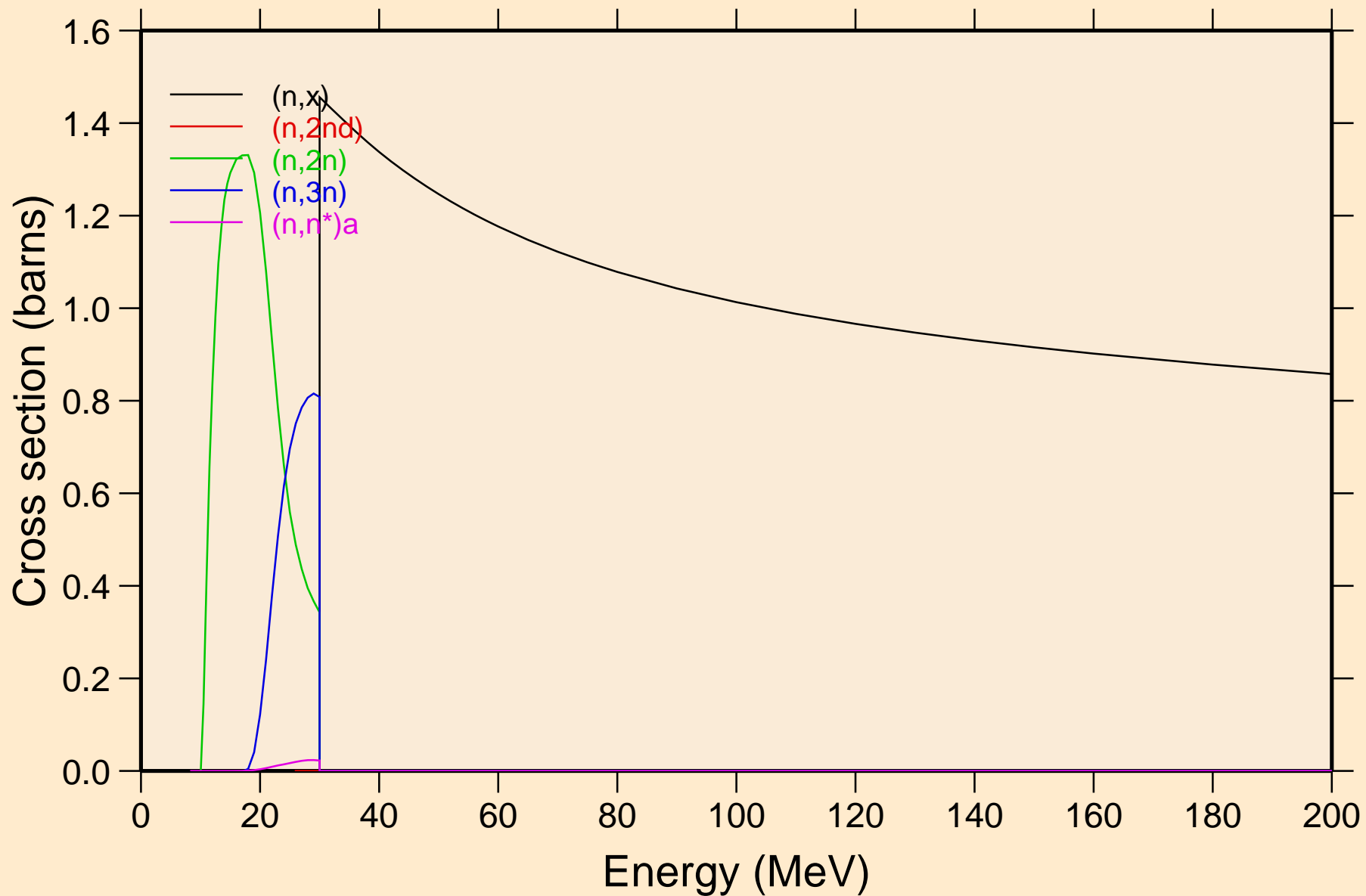

MAT=3649 ACE FILE PRODUCED AT NEA WITH NDEC  
Threshold reactions

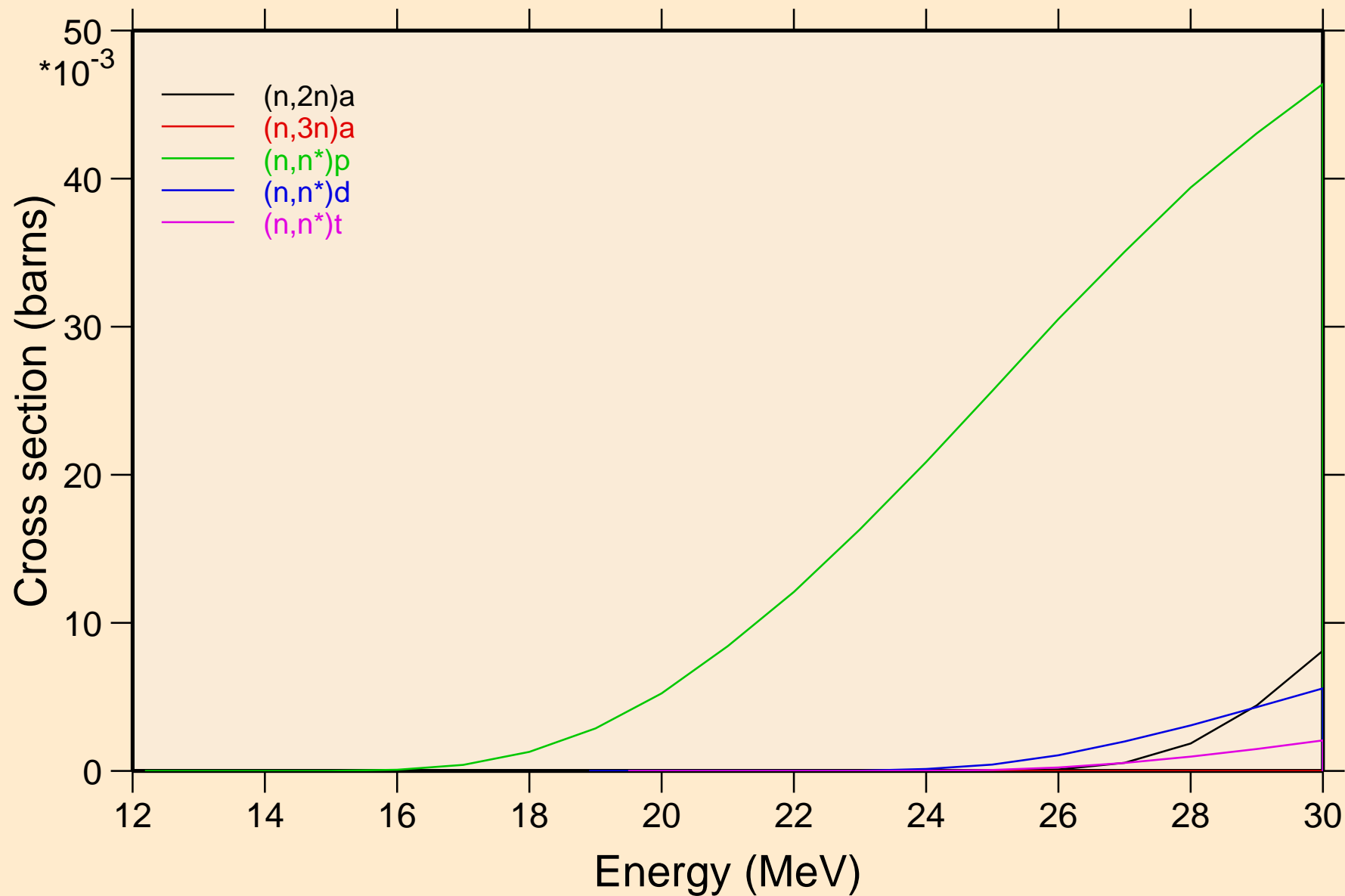

MAT=3649 ACE FILE PRODUCED AT NEA WITH NDEC  
Threshold reactions

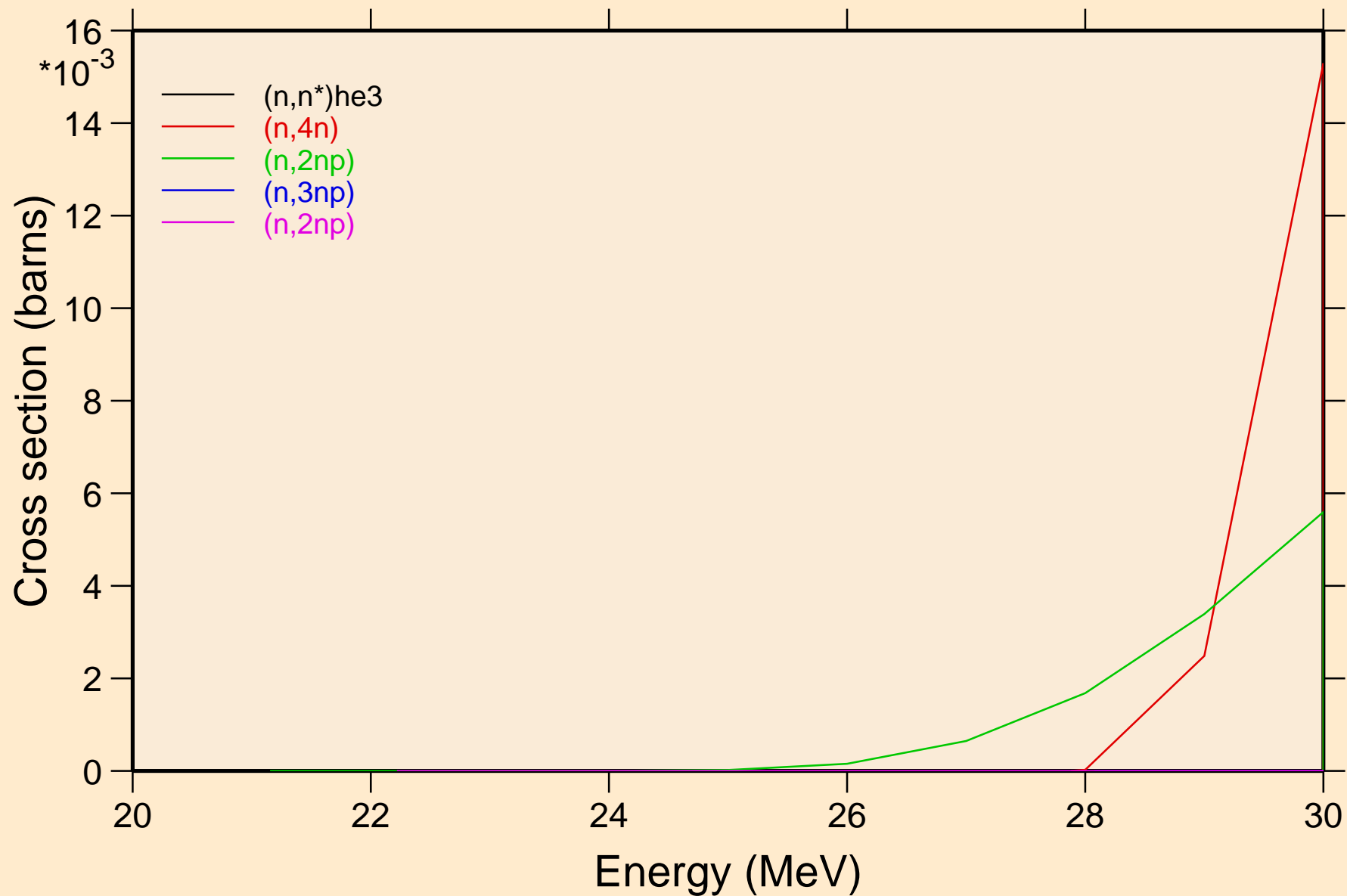

MAT=3649 ACE FILE PRODUCED AT NEA WITH NDEC  
Threshold reactions

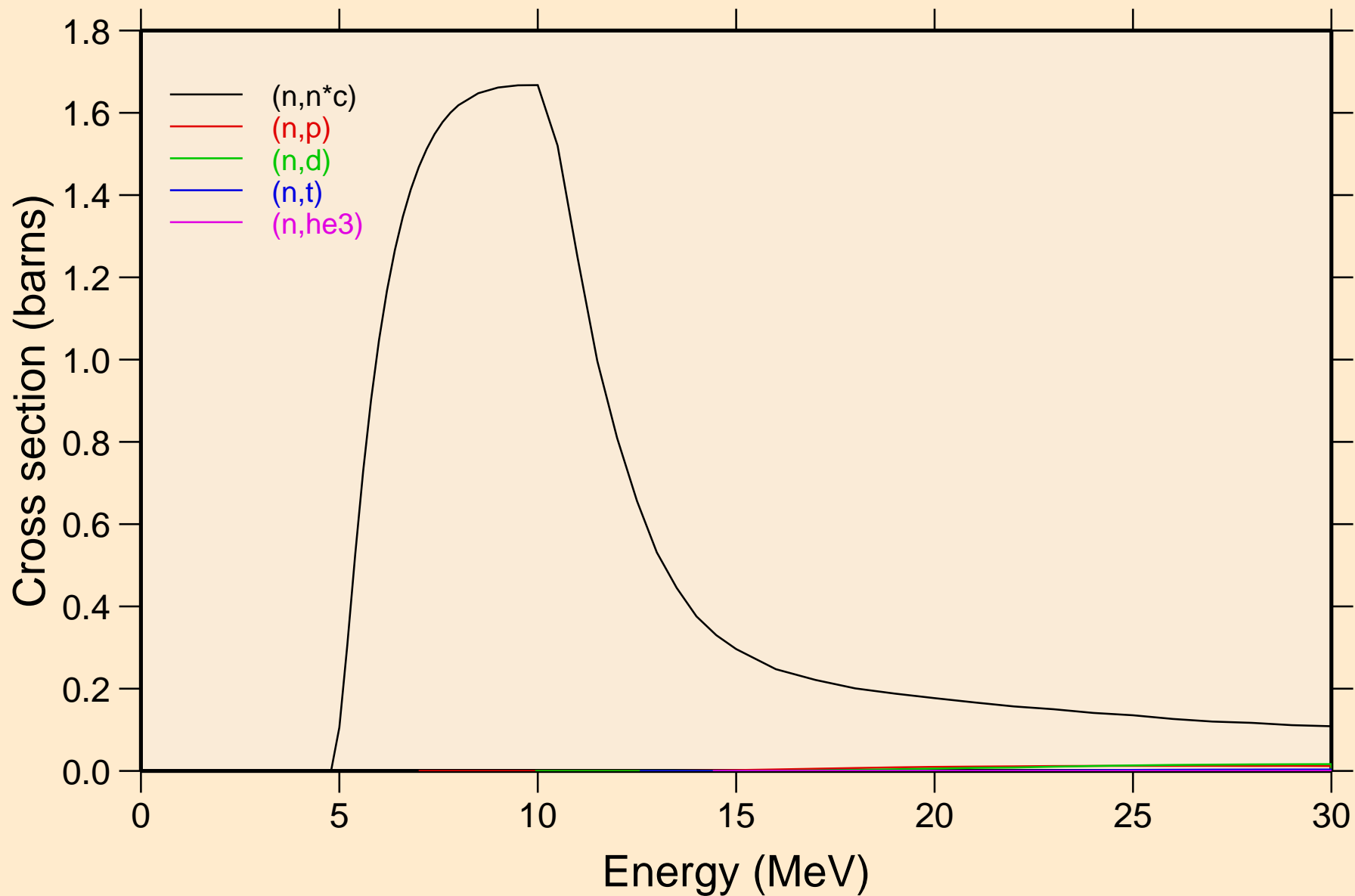

MAT=3649 ACE FILE PRODUCED AT NEA WITH NDEC  
Threshold reactions

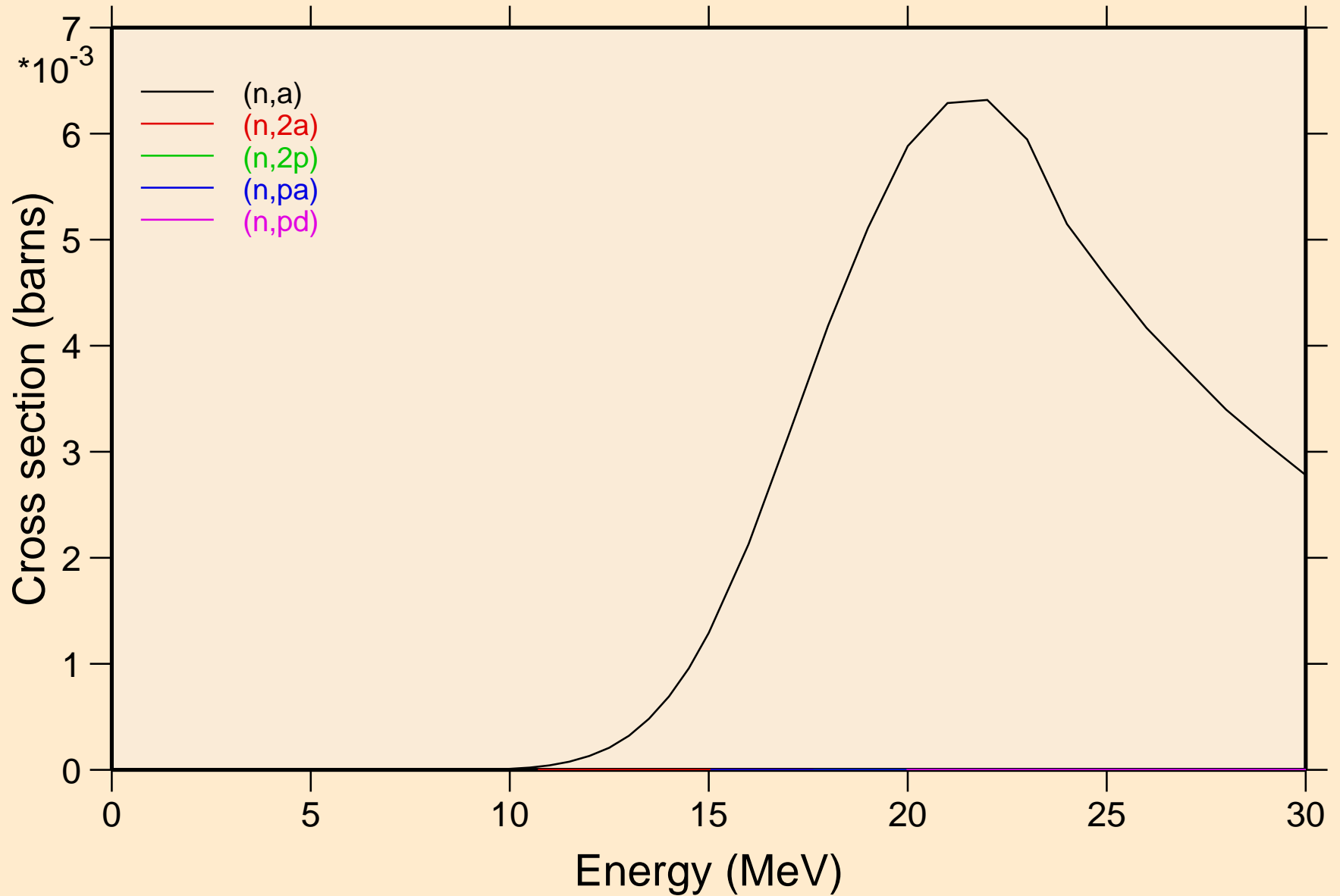

MAT=3649 ACE FILE PRODUCED AT NEA WITH NDEC  
Threshold reactions

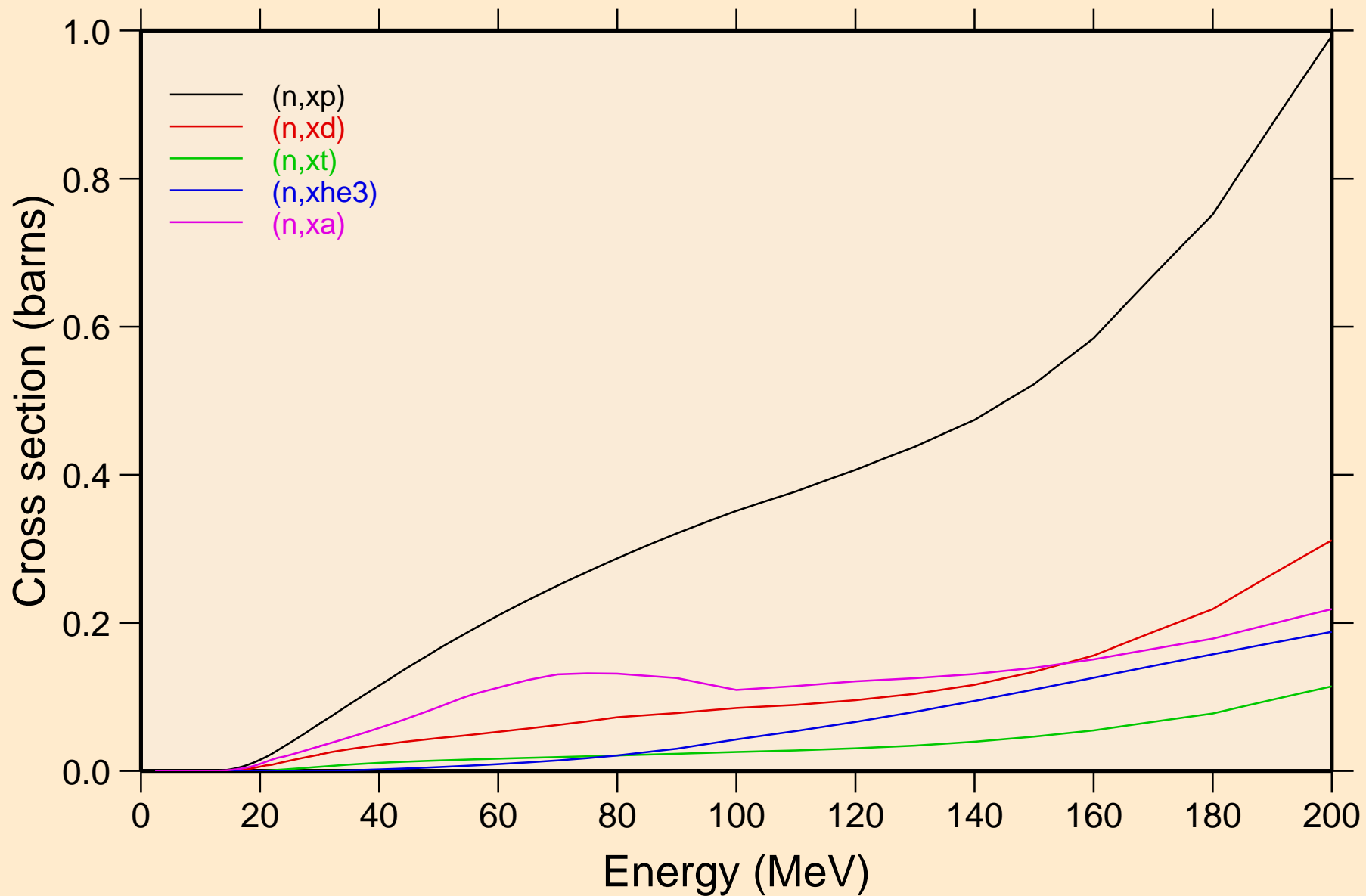

MAT=3649 ACE FILE PRODUCED AT NEA WITH NDEC  
angular distribution for elastic

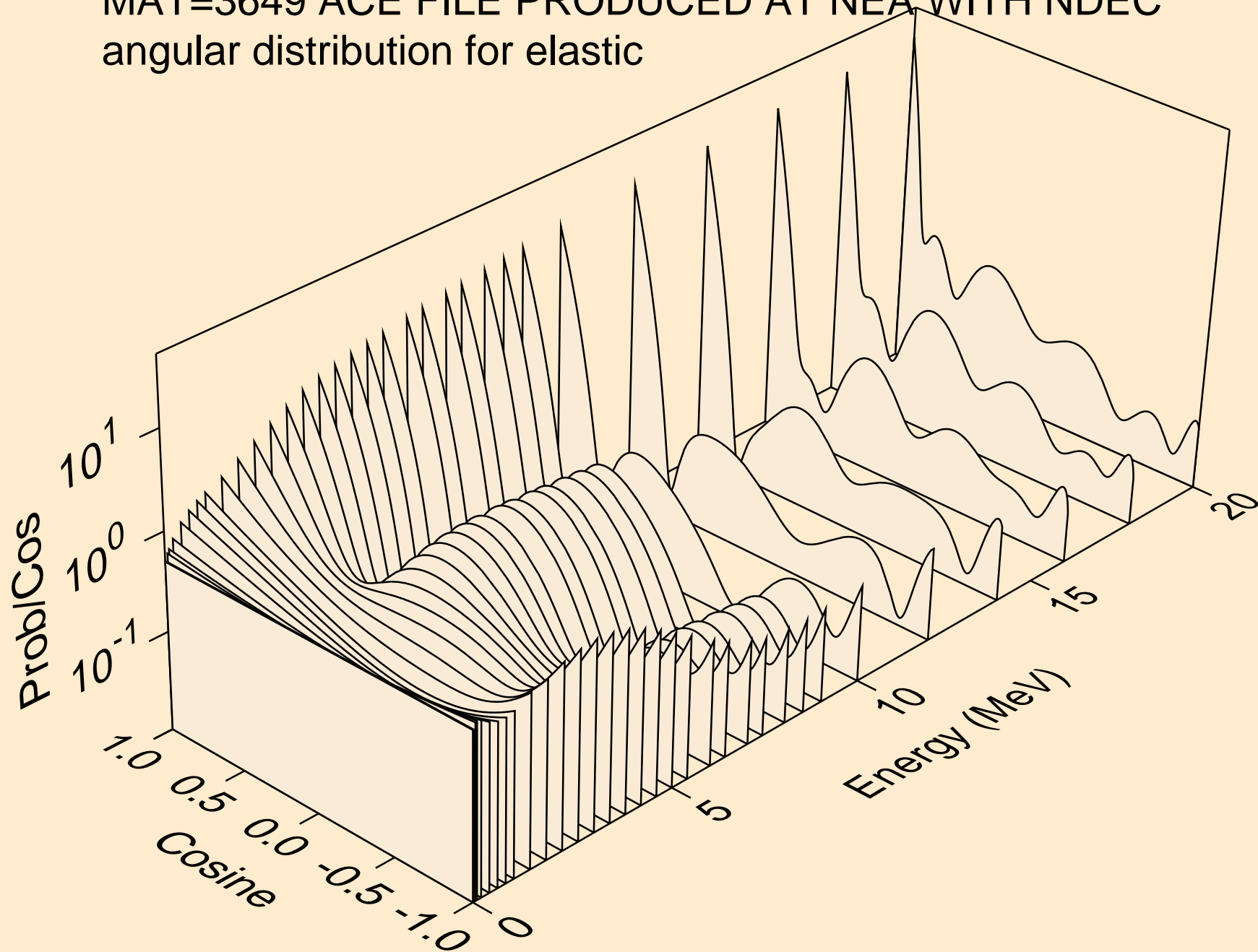

MAT=3649 ACE FILE PRODUCED AT NEA WITH NDEC  
angular distribution for elastic

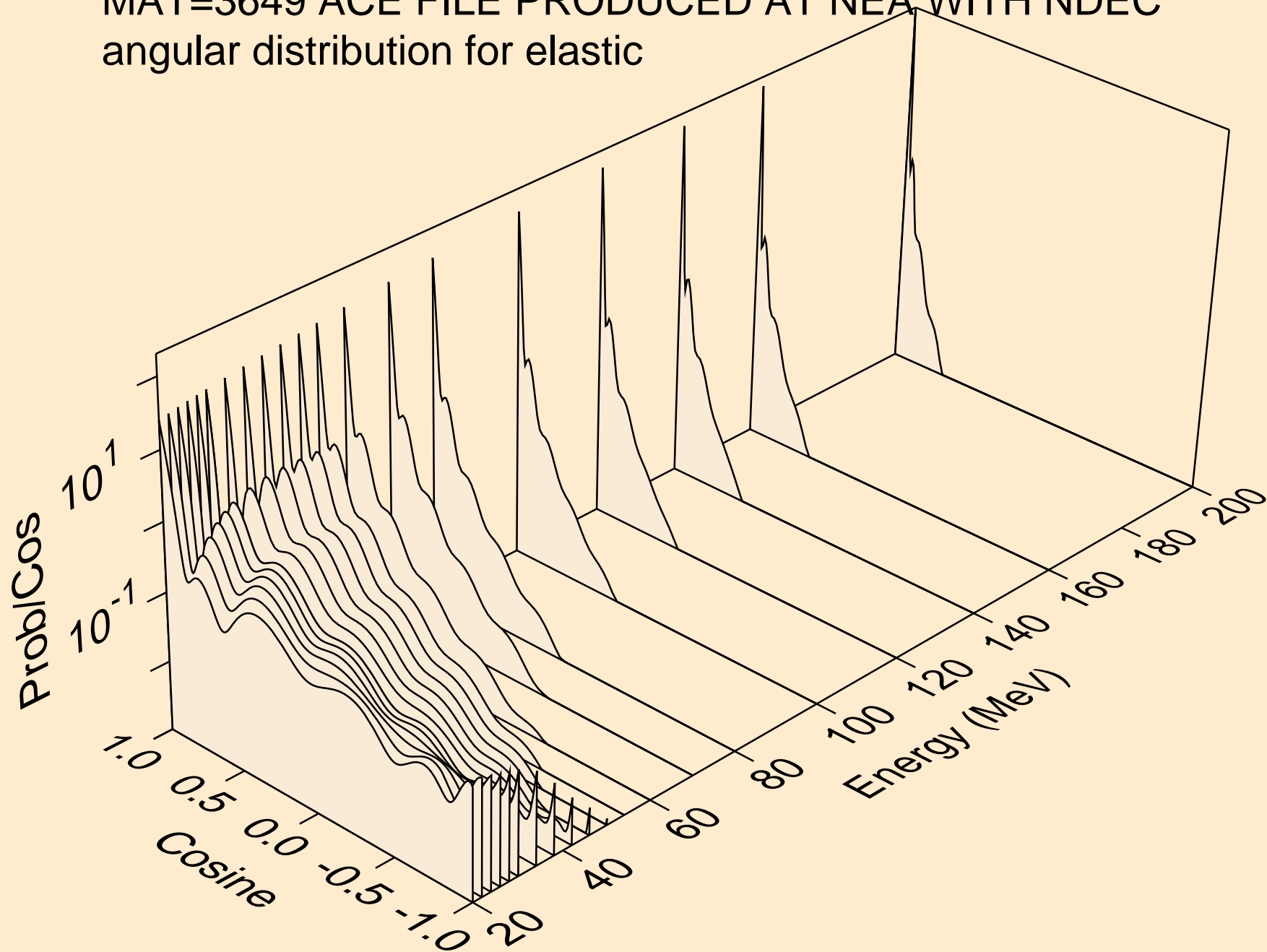

MAT=3649 ACE FILE PRODUCED AT NEA WITH NDEC  
angular distribution for (n,n\*1)

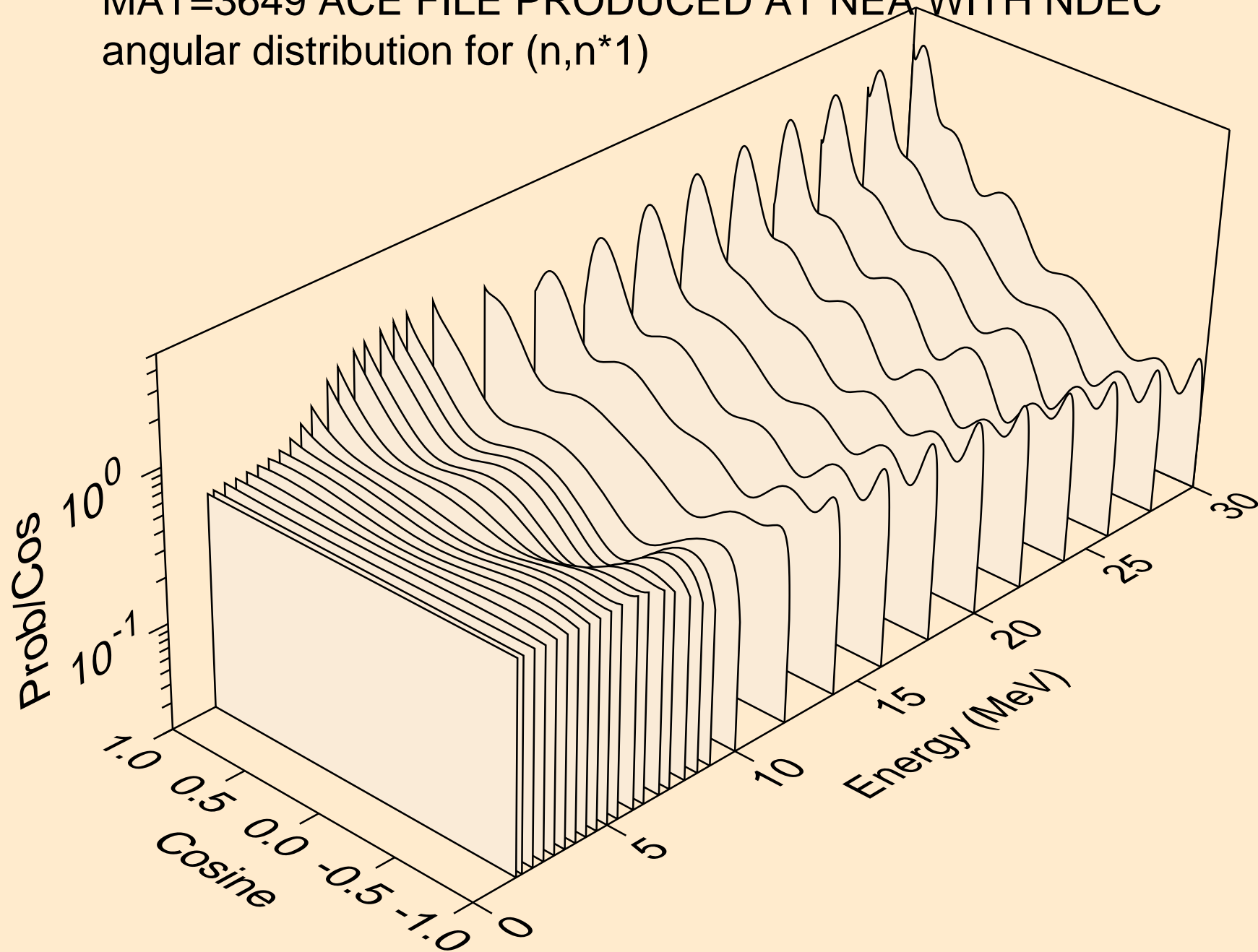

MAT=3649 ACE FILE PRODUCED AT NEA WITH NDEC  
angular distribution for (n,n\*2)

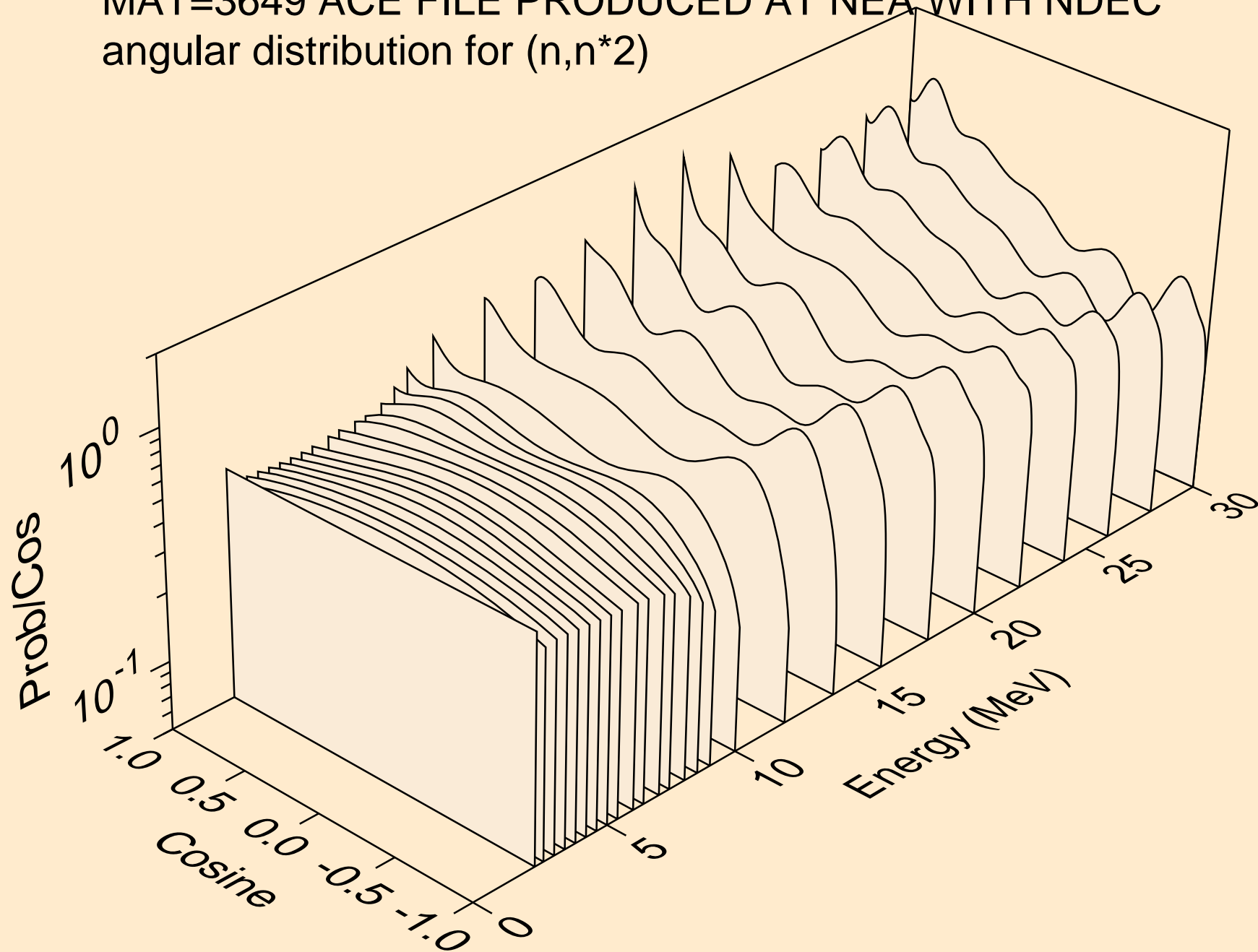

MAT=3649 ACE FILE PRODUCED AT NEA WITH NDEC  
angular distribution for (n,n\*3)

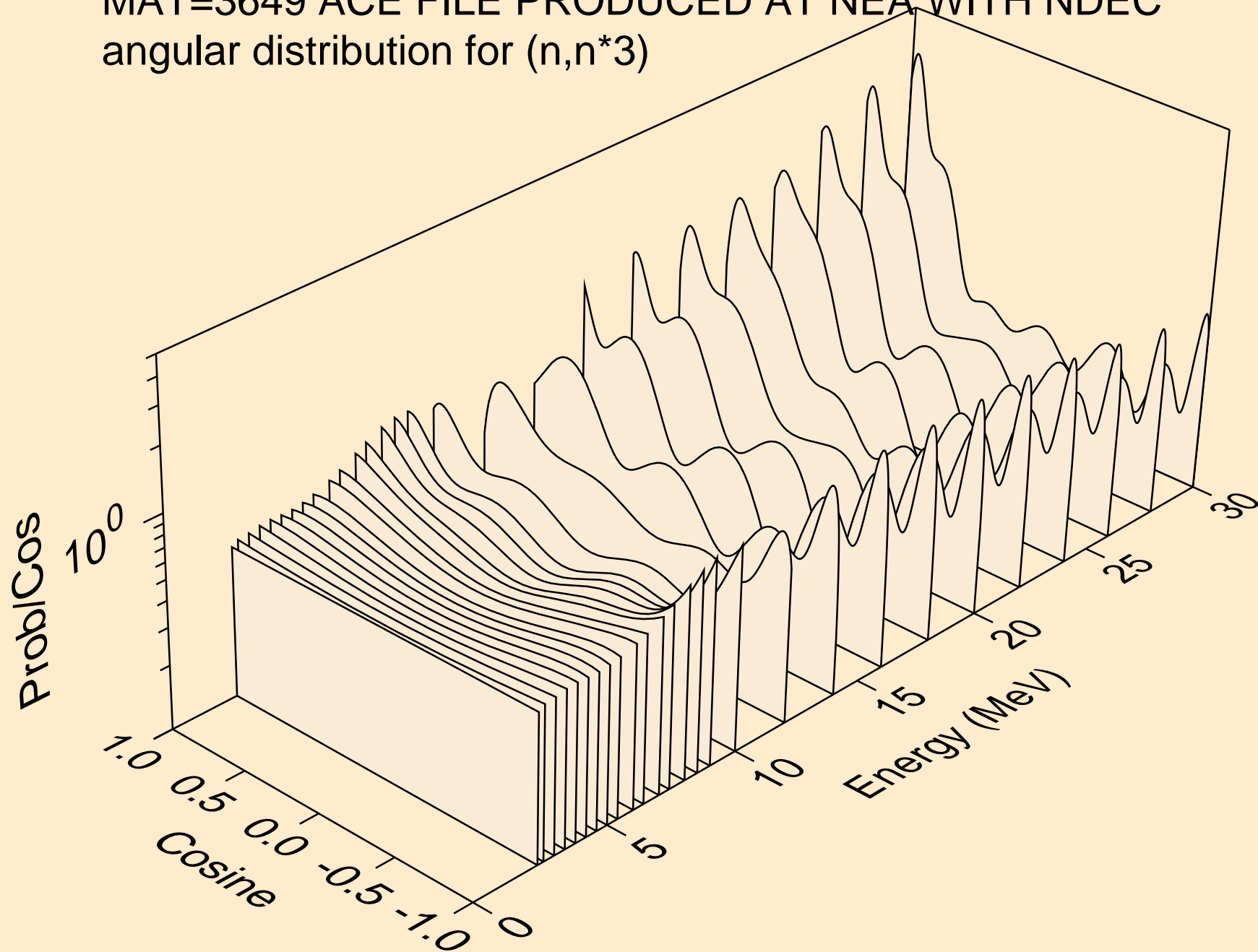

MAT=3649 ACE FILE PRODUCED AT NEA WITH NDEC  
angular distribution for (n,n\*4)

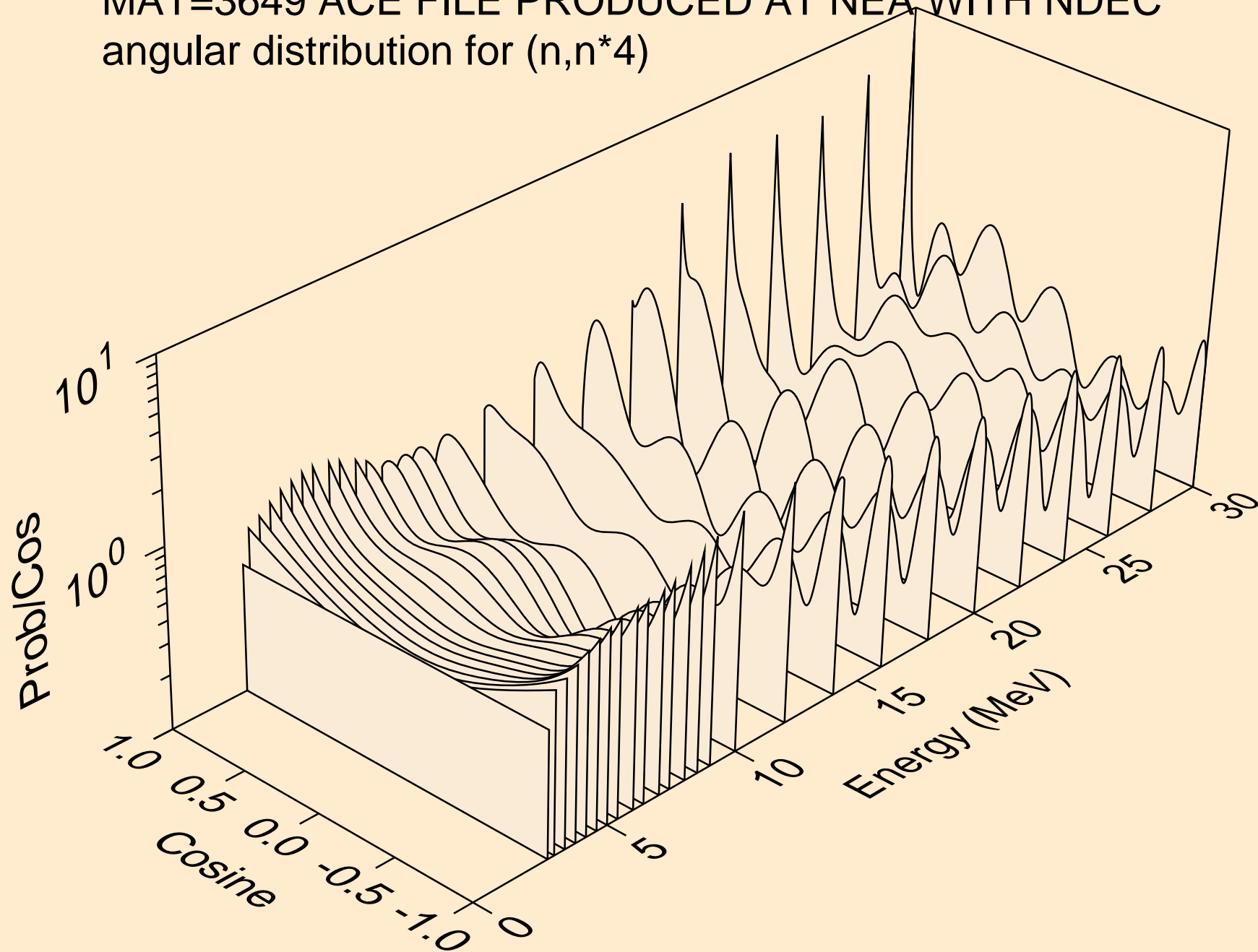

MAT=3649 ACE FILE PRODUCED AT NEA WITH NDEC  
angular distribution for (n,n\*5)

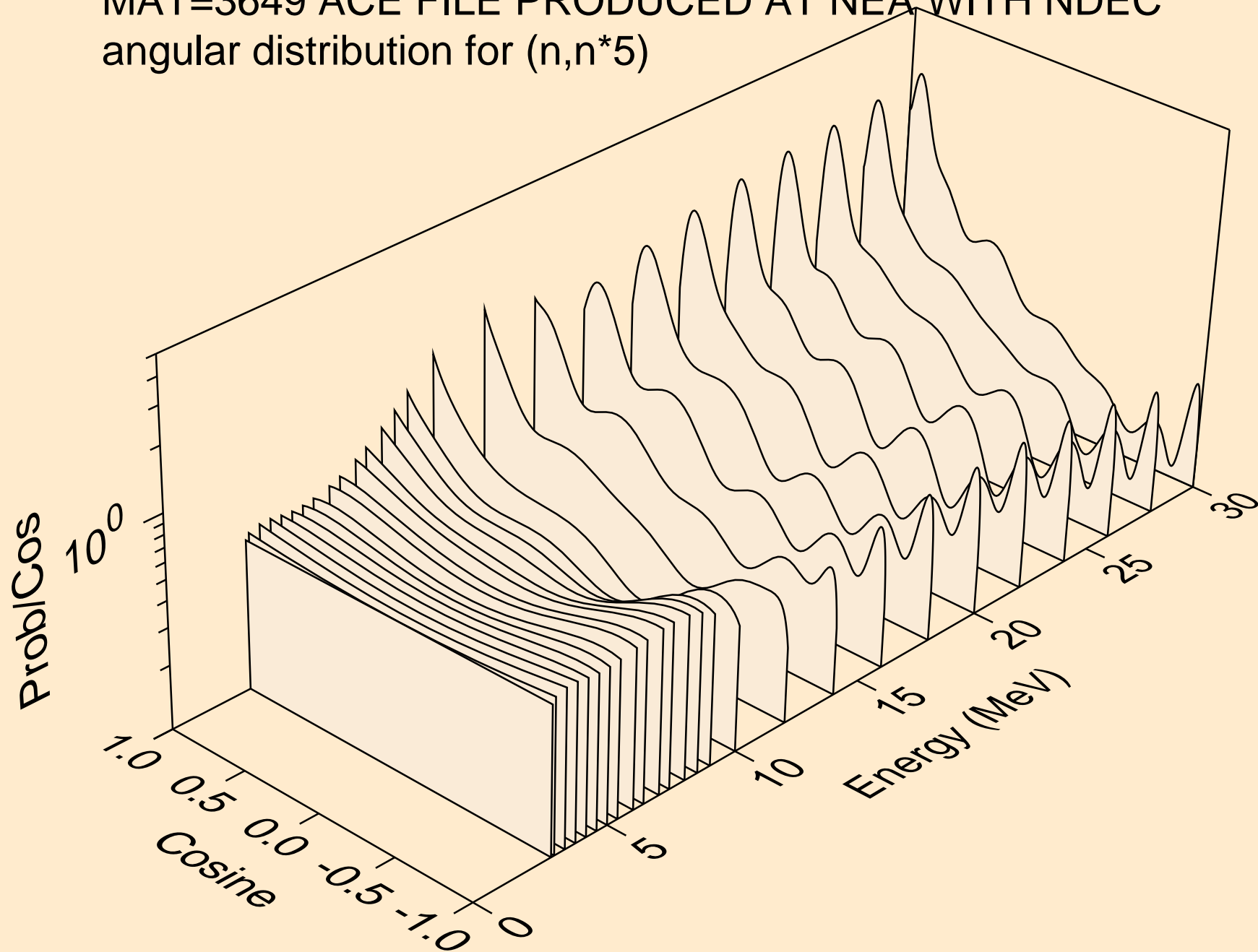

MAT=3649 ACE FILE PRODUCED AT NEA WITH NDEC  
angular distribution for (n,n\*6)

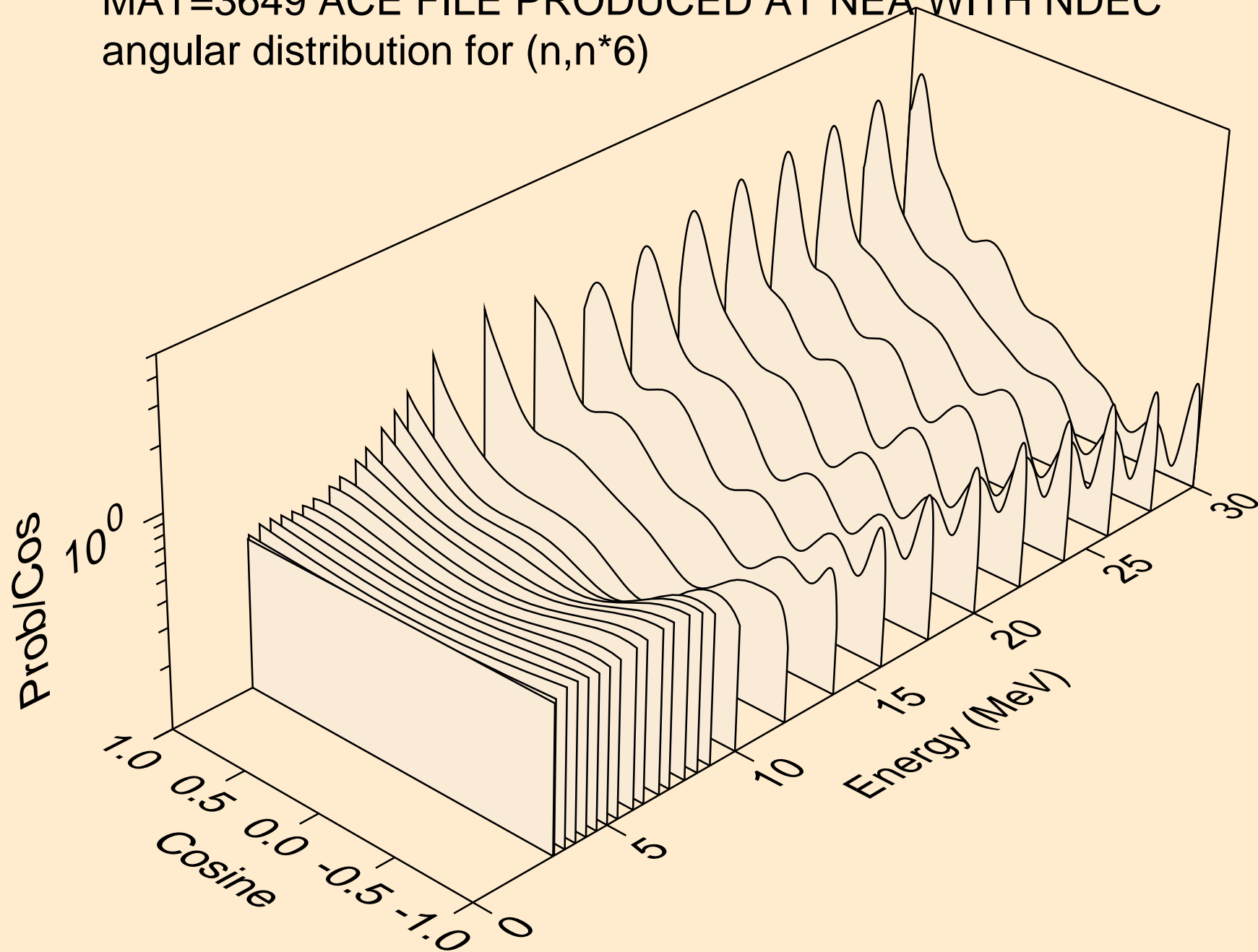

MAT=3649 ACE FILE PRODUCED AT NEA WITH NDEC  
angular distribution for (n,n\*7)

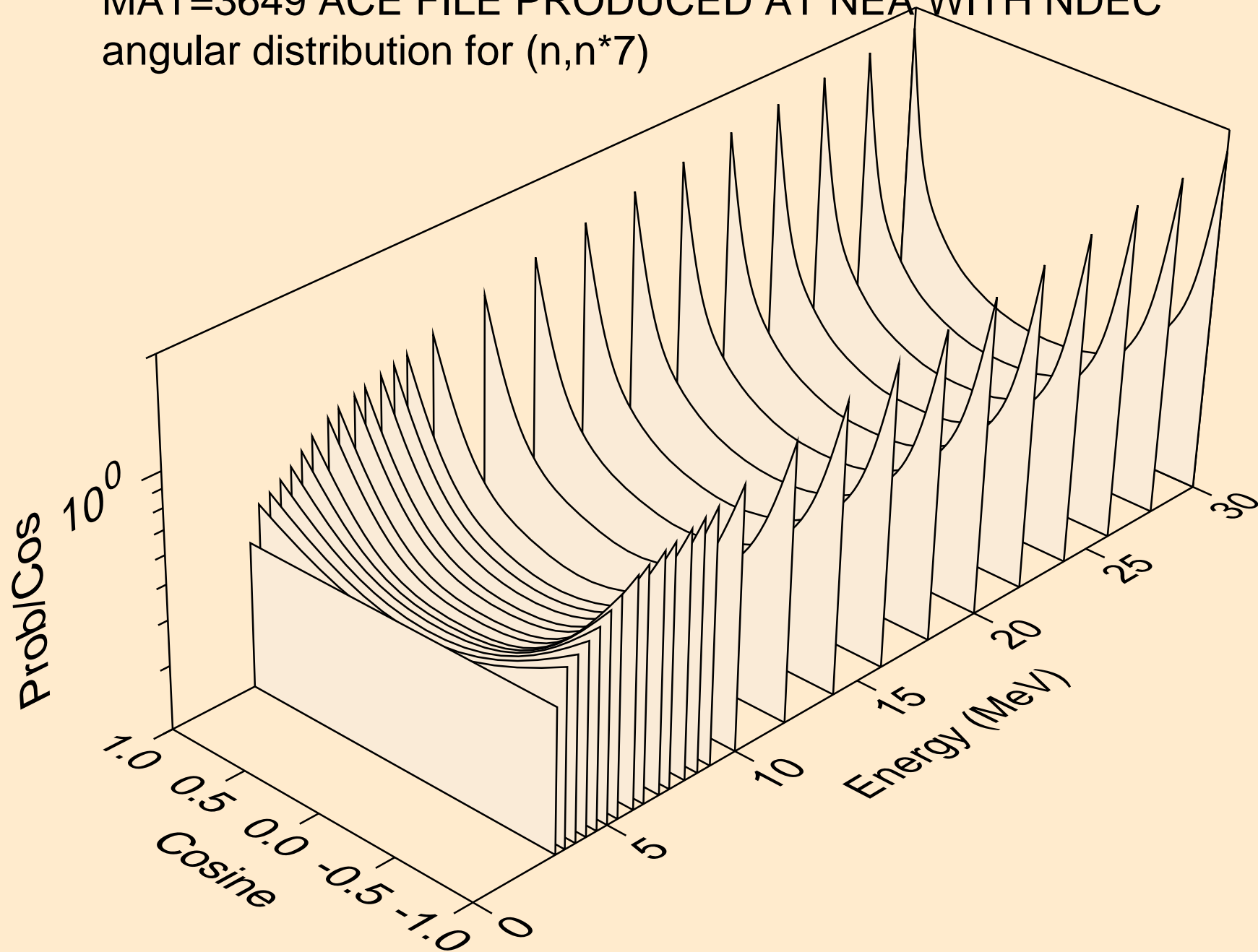

MAT=3649 ACE FILE PRODUCED AT NEA WITH NDEC  
angular distribution for (n,n\*8)

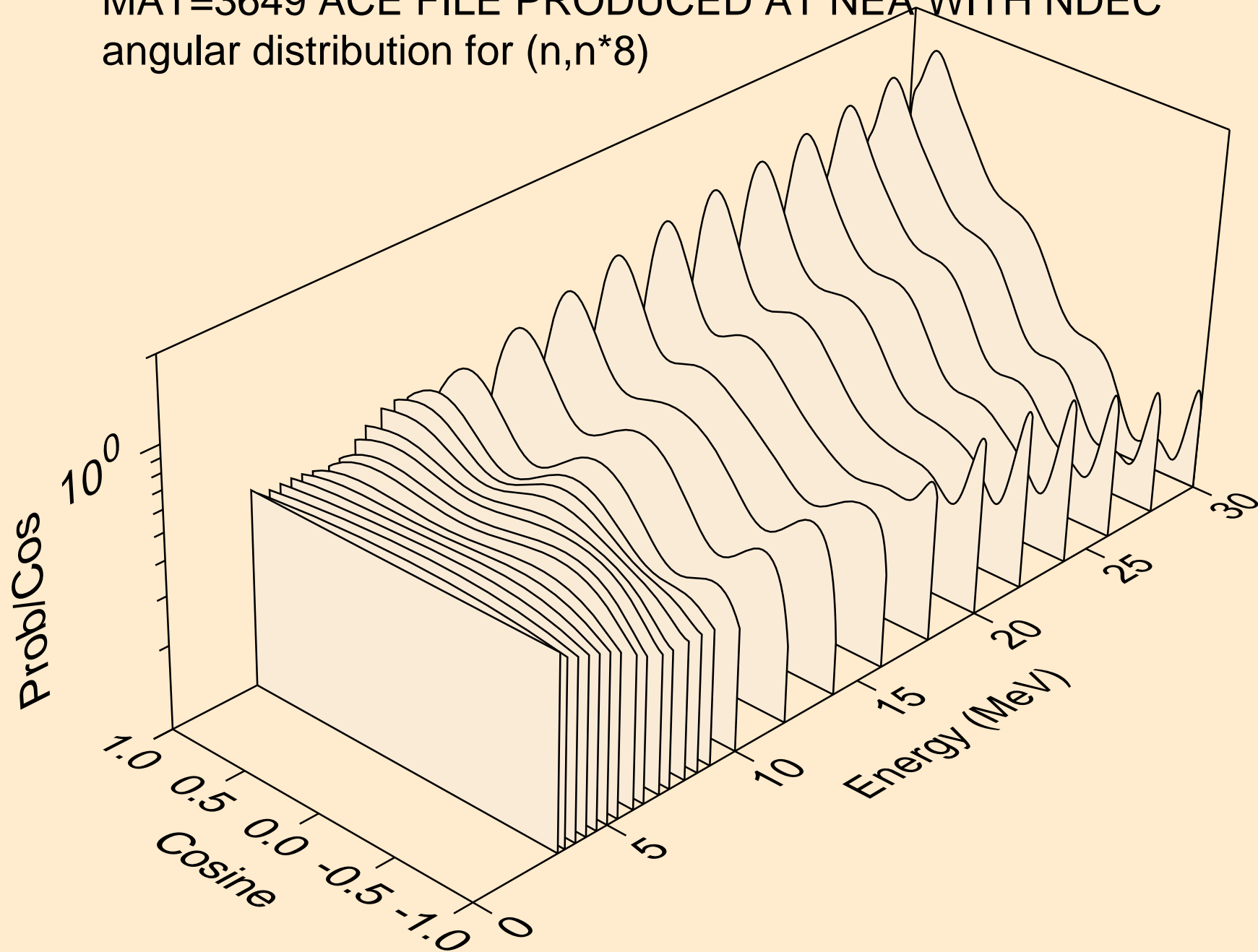

MAT=3649 ACE FILE PRODUCED AT NEA WITH NDEC  
angular distribution for (n,n\*9)

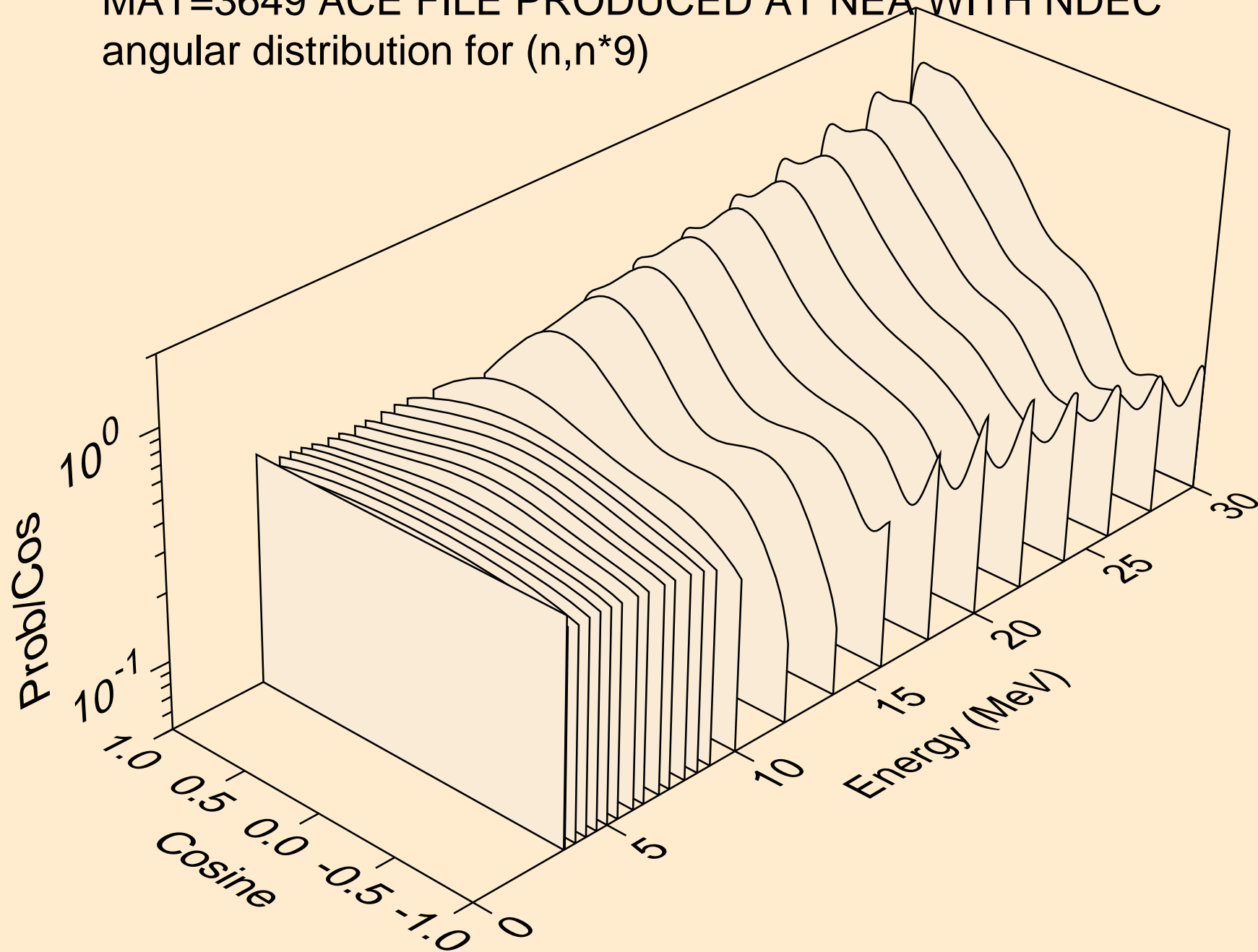

MAT=3649 ACE FILE PRODUCED AT NEA WITH NDEC  
angular distribution for (n,n\*10)

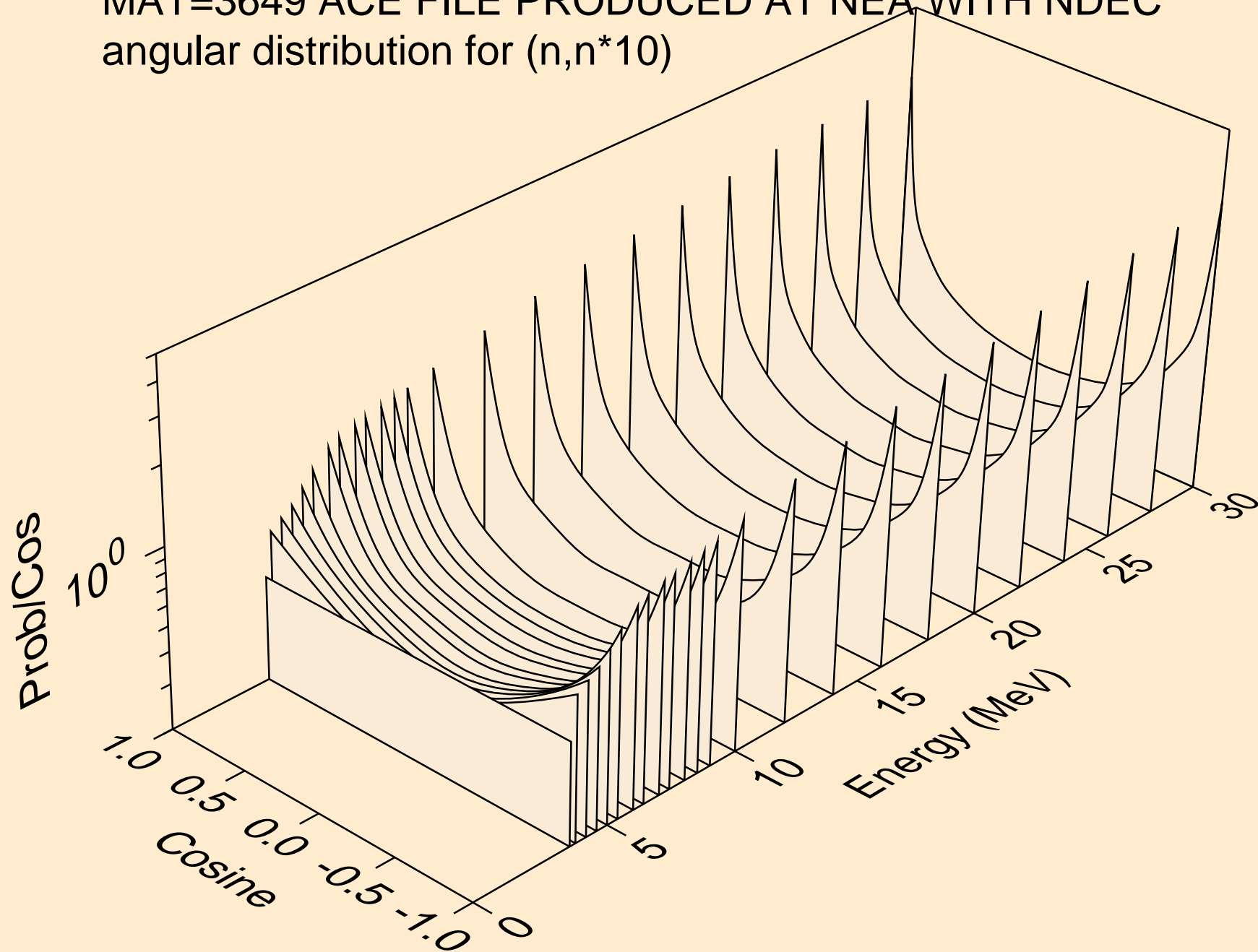

MAT=3649 ACE FILE PRODUCED AT NEA WITH NDEC  
angular distribution for (n,n\*11)

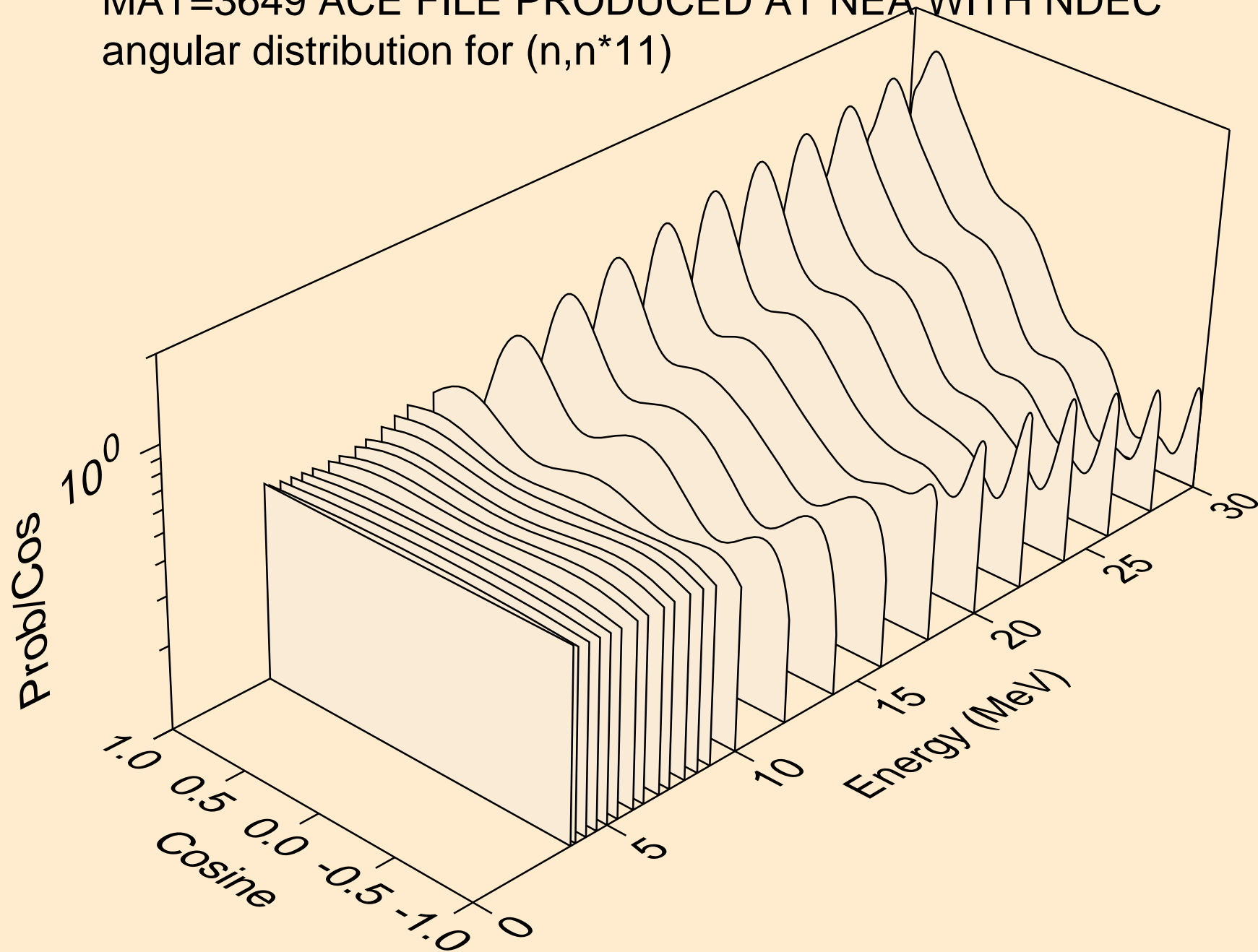

MAT=3649 ACE FILE PRODUCED AT NEA WITH NDEC  
angular distribution for (n,n\*12)

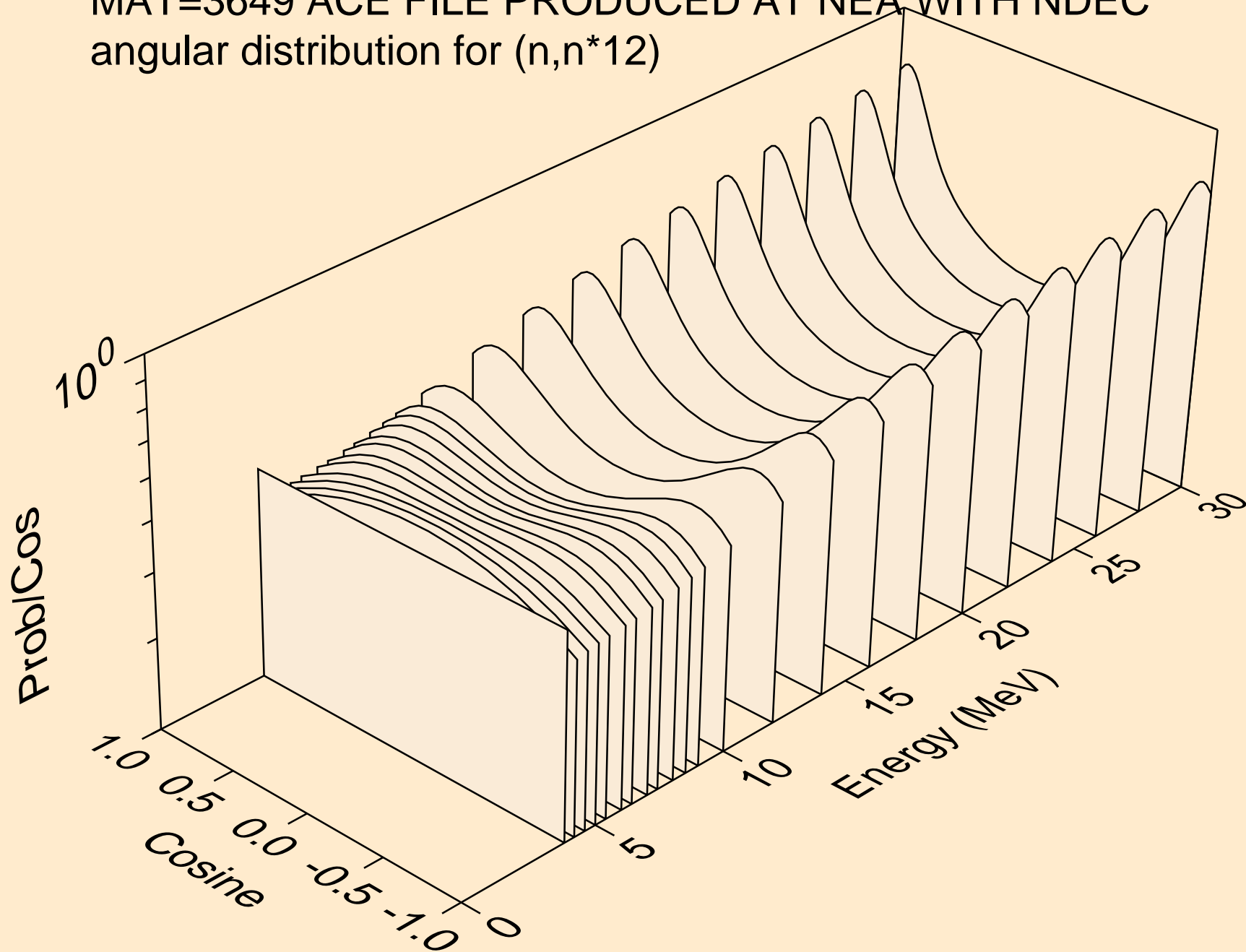

MAT=3649 ACE FILE PRODUCED AT NEA WITH NDEC  
angular distribution for (n,n\*13)

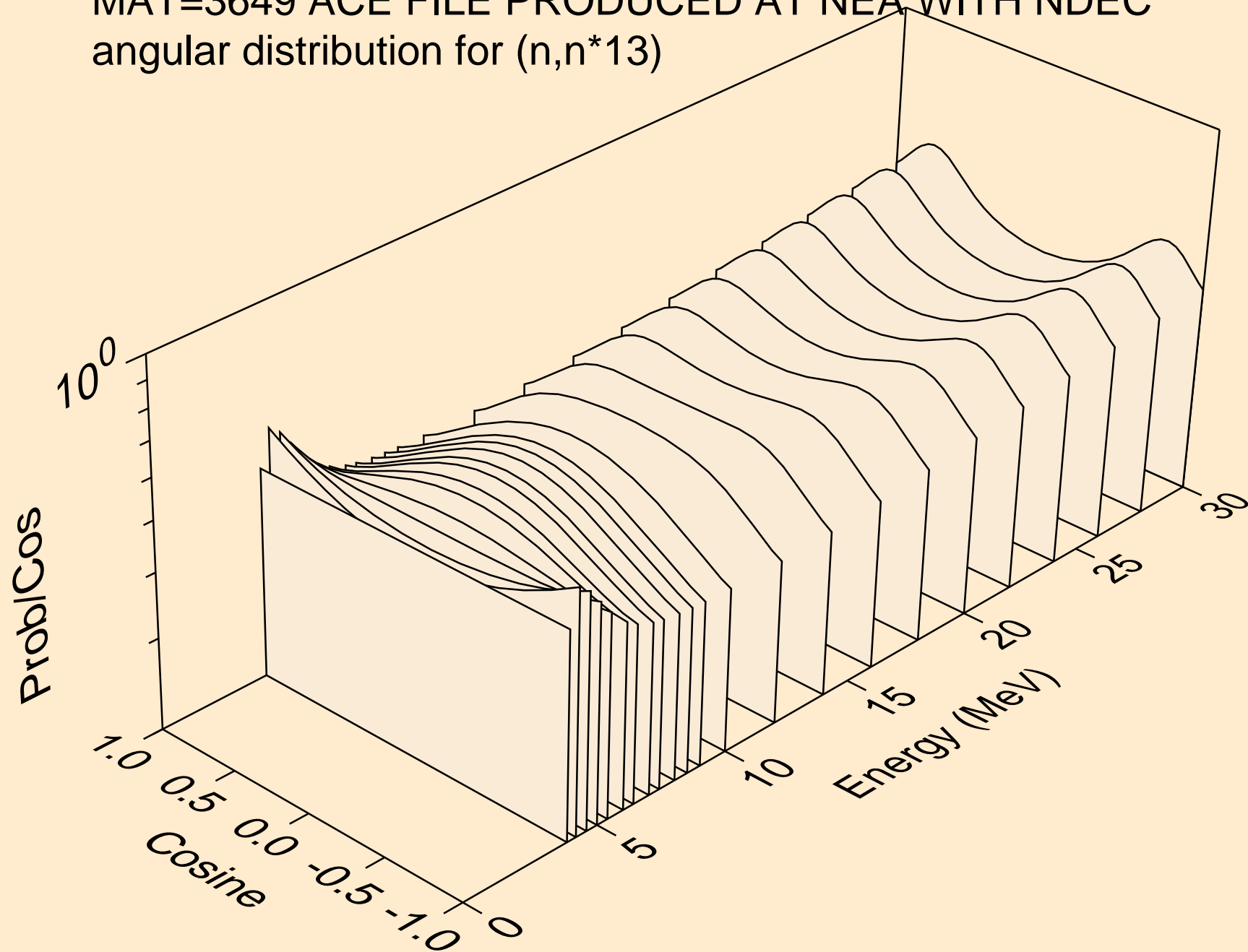

MAT=3649 ACE FILE PRODUCED AT NEA WITH NDEC  
angular distribution for (n,n\*14)

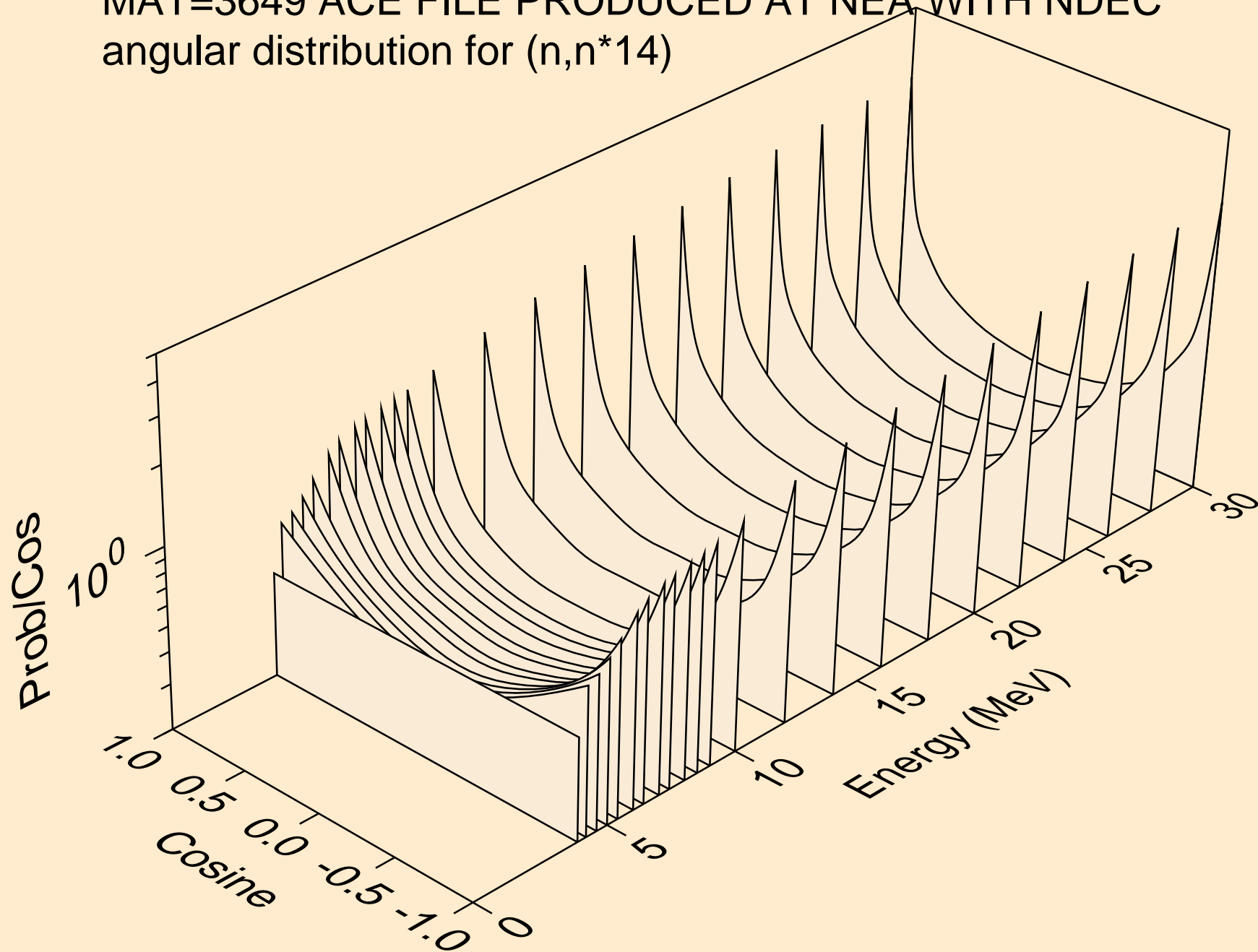

MAT=3649 ACE FILE PRODUCED AT NEA WITH NDEC  
angular distribution for (n,n\*15)

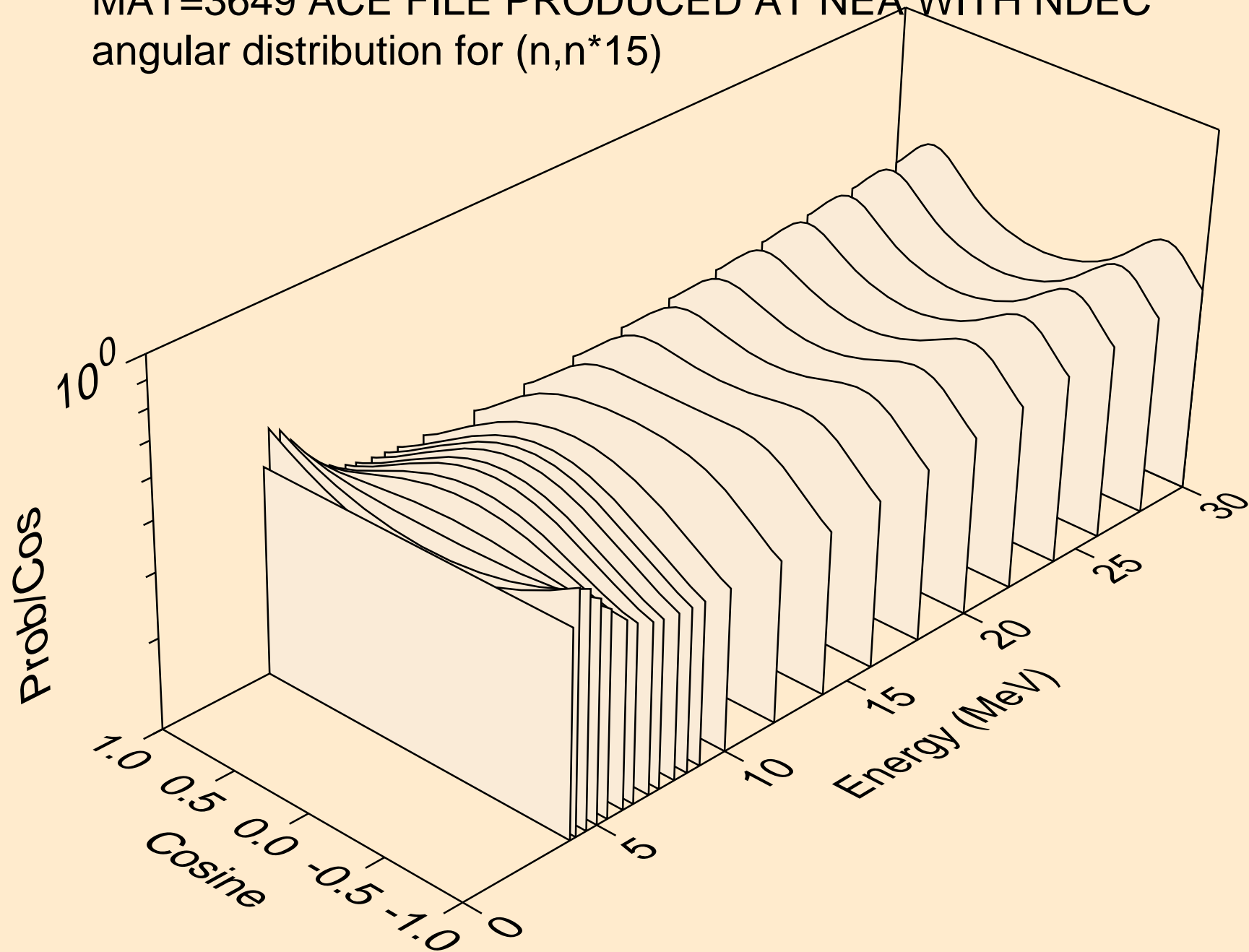

MAT=3649 ACE FILE PRODUCED AT NEA WITH NDEC  
angular distribution for (n,n\*16)

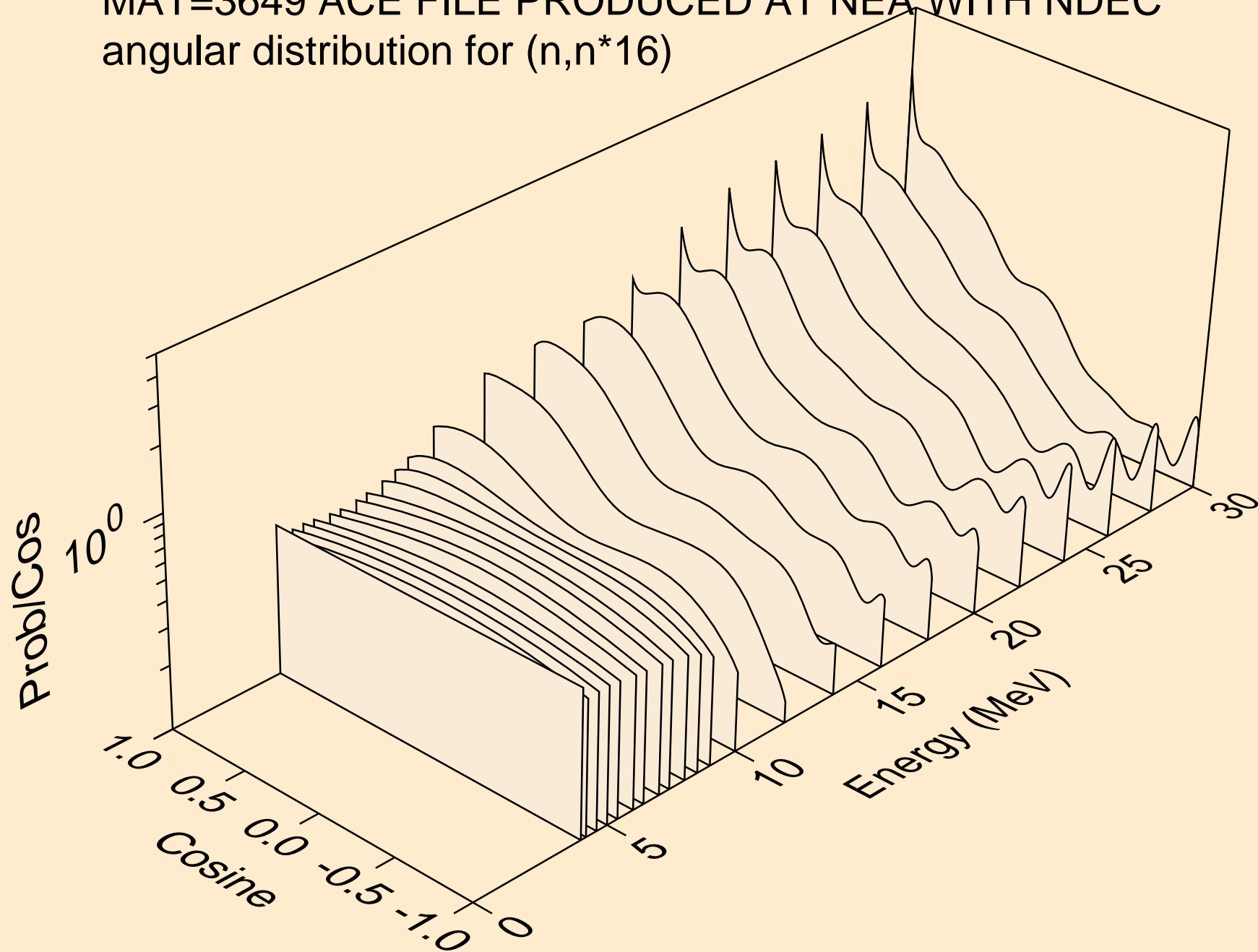

MAT=3649 ACE FILE PRODUCED AT NEA WITH NDEC  
angular distribution for (n,n\*17)

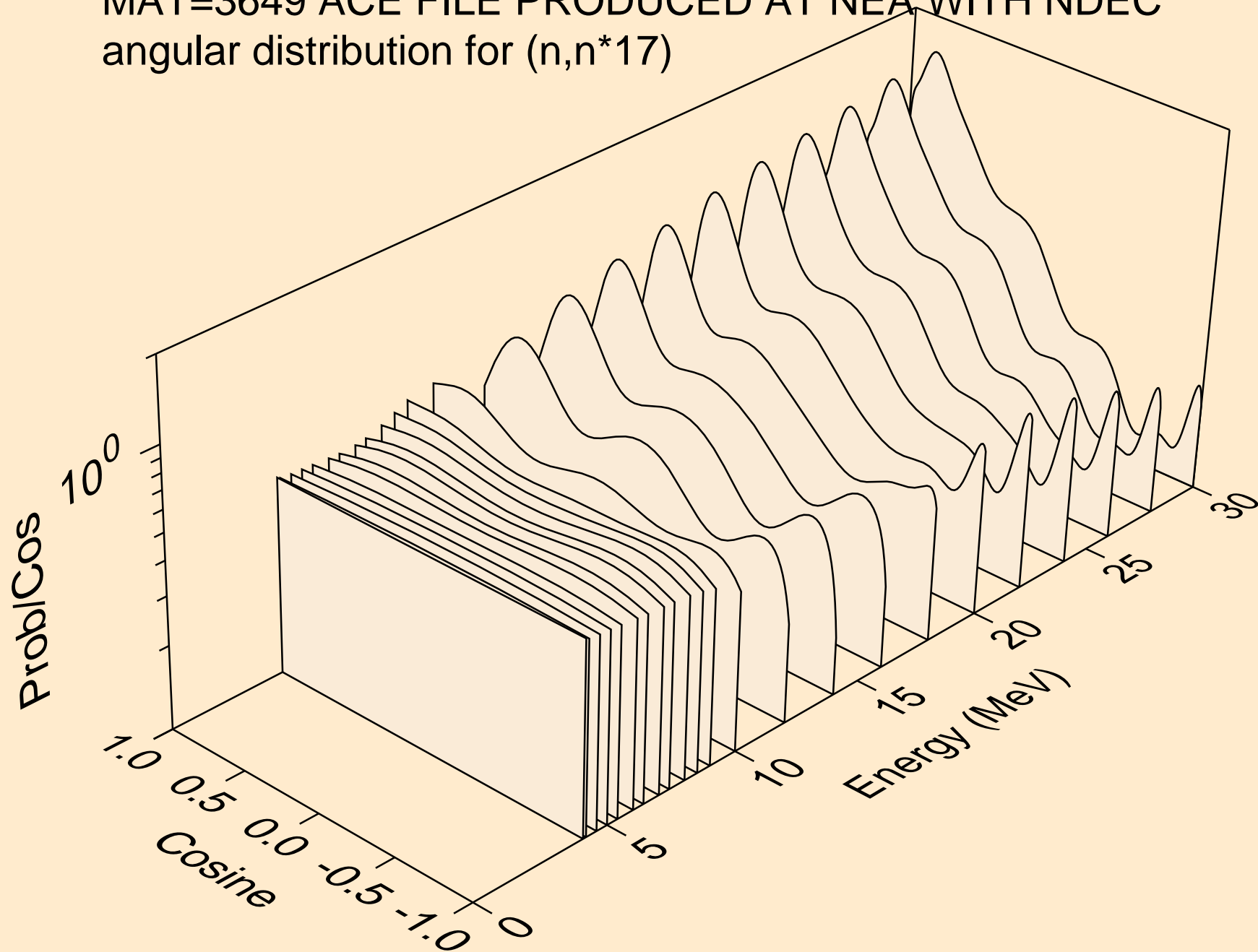

MAT=3649 ACE FILE PRODUCED AT NEA WITH NDEC  
angular distribution for (n,n\*18)

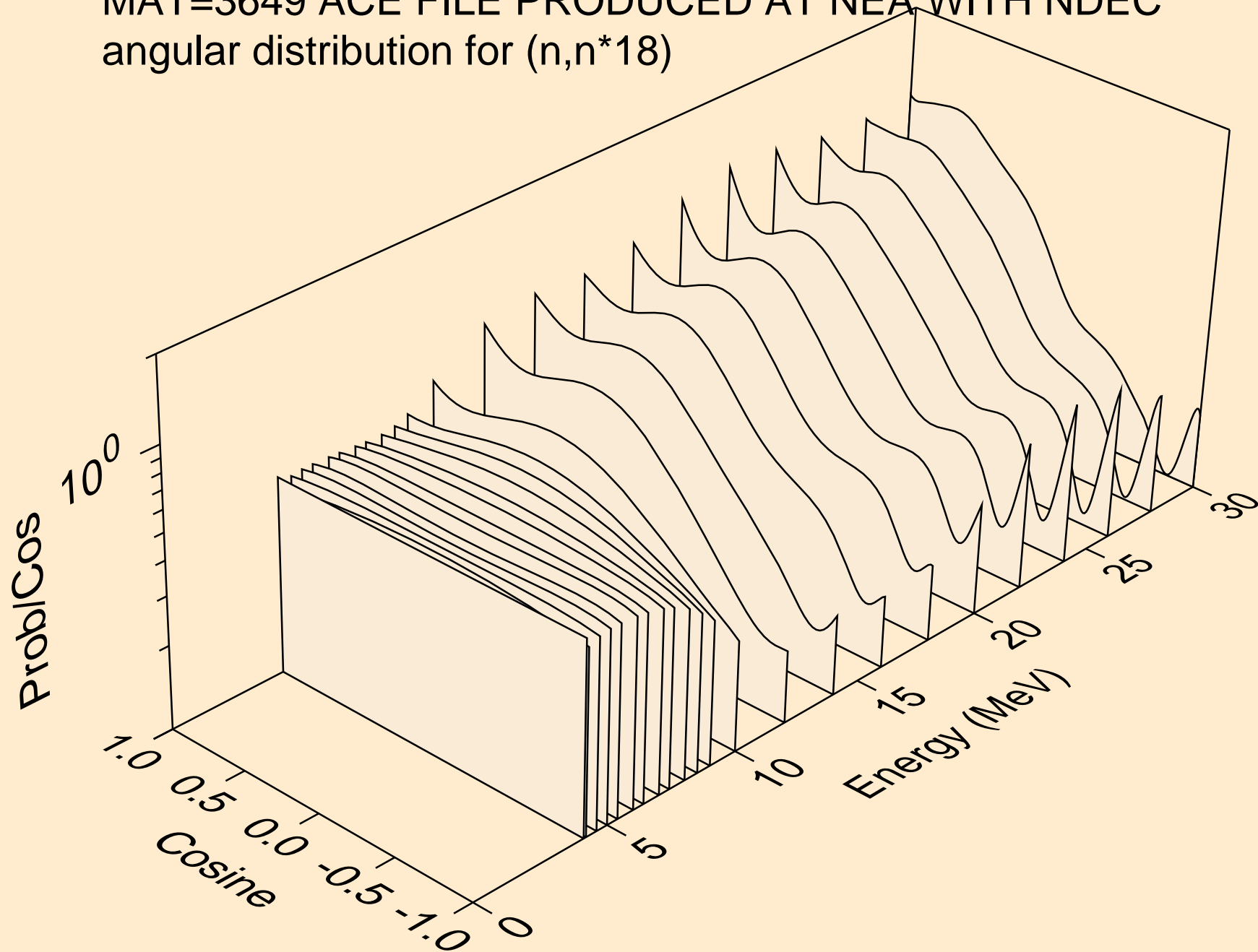

MAT=3649 ACE FILE PRODUCED AT NEA WITH NDEC  
angular distribution for (n,n\*19)

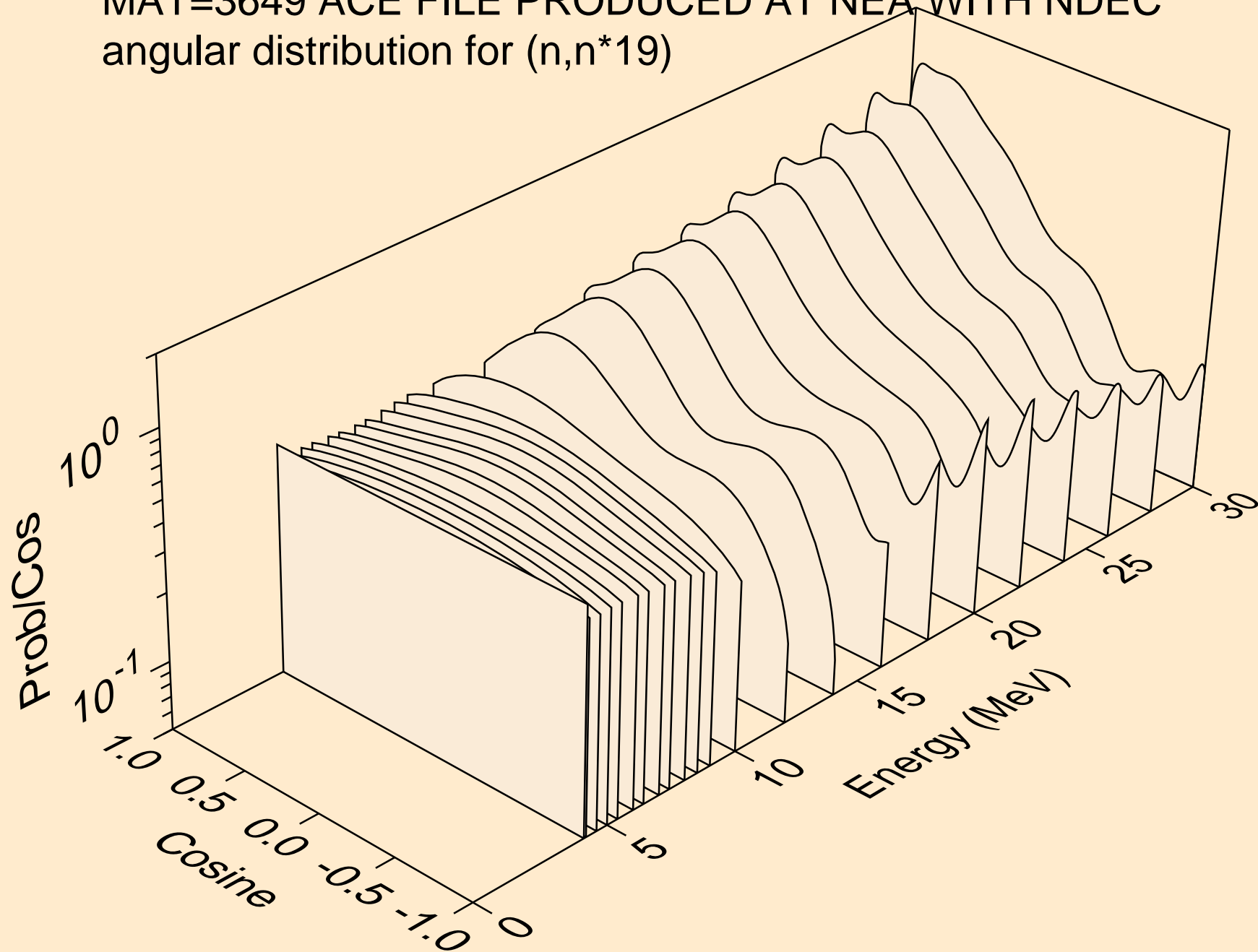

MAT=3649 ACE FILE PRODUCED AT NEA WITH NDEC  
angular distribution for (n,n\*20)

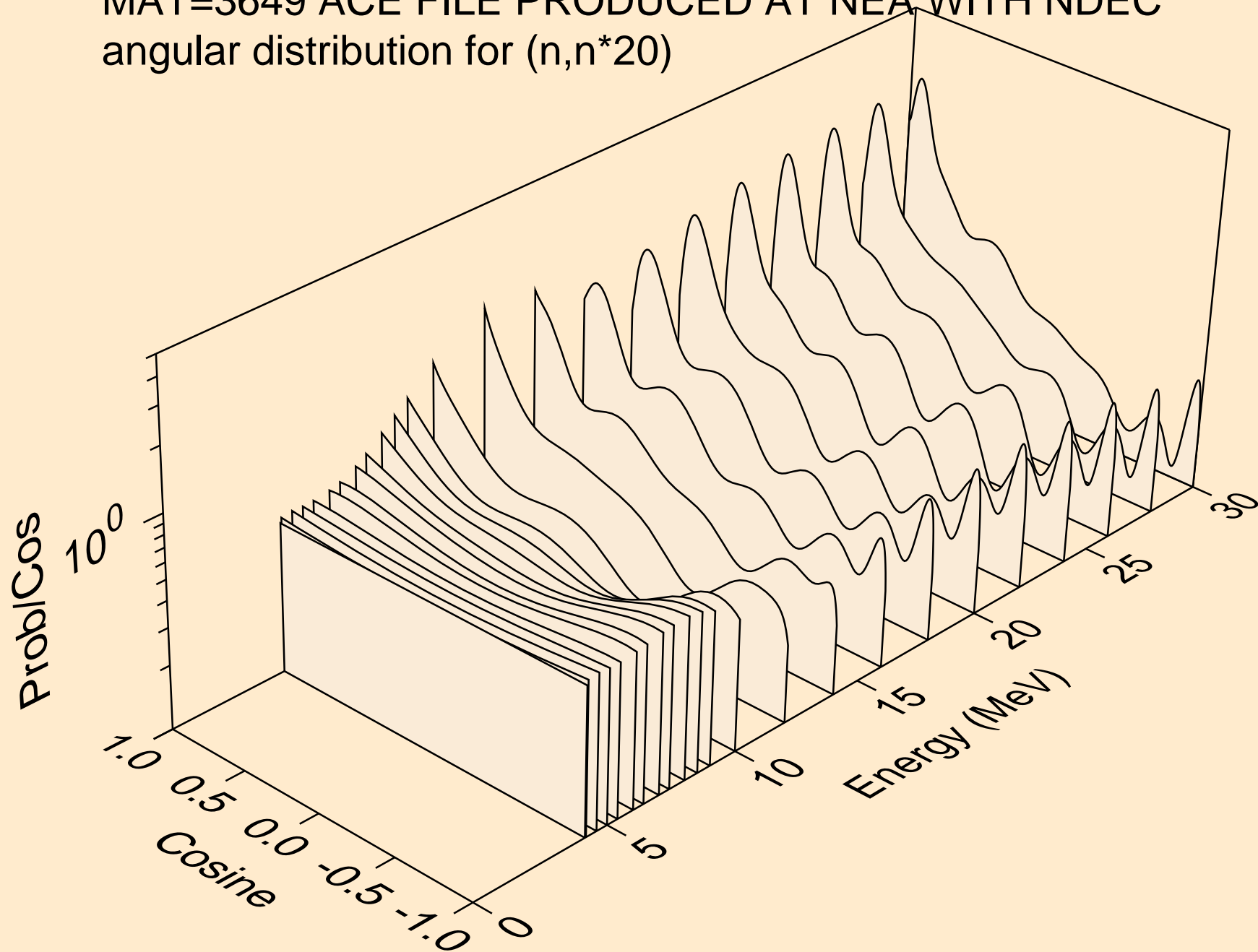

MAT=3649 ACE FILE PRODUCED AT NEA WITH NDEC  
angular distribution for (n,n\*21)

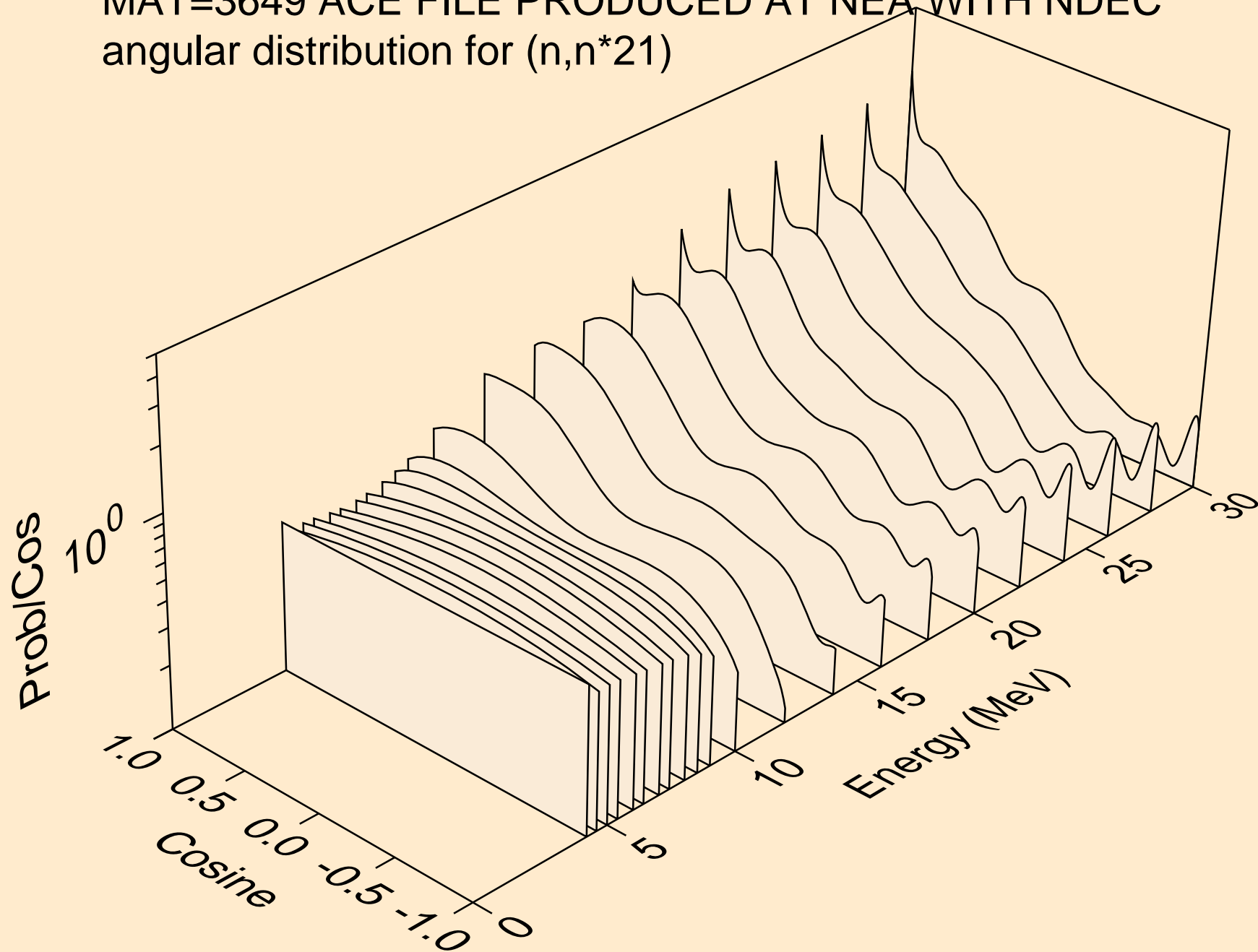

MAT=3649 ACE FILE PRODUCED AT NEA WITH NDEC  
angular distribution for (n,n\*22)

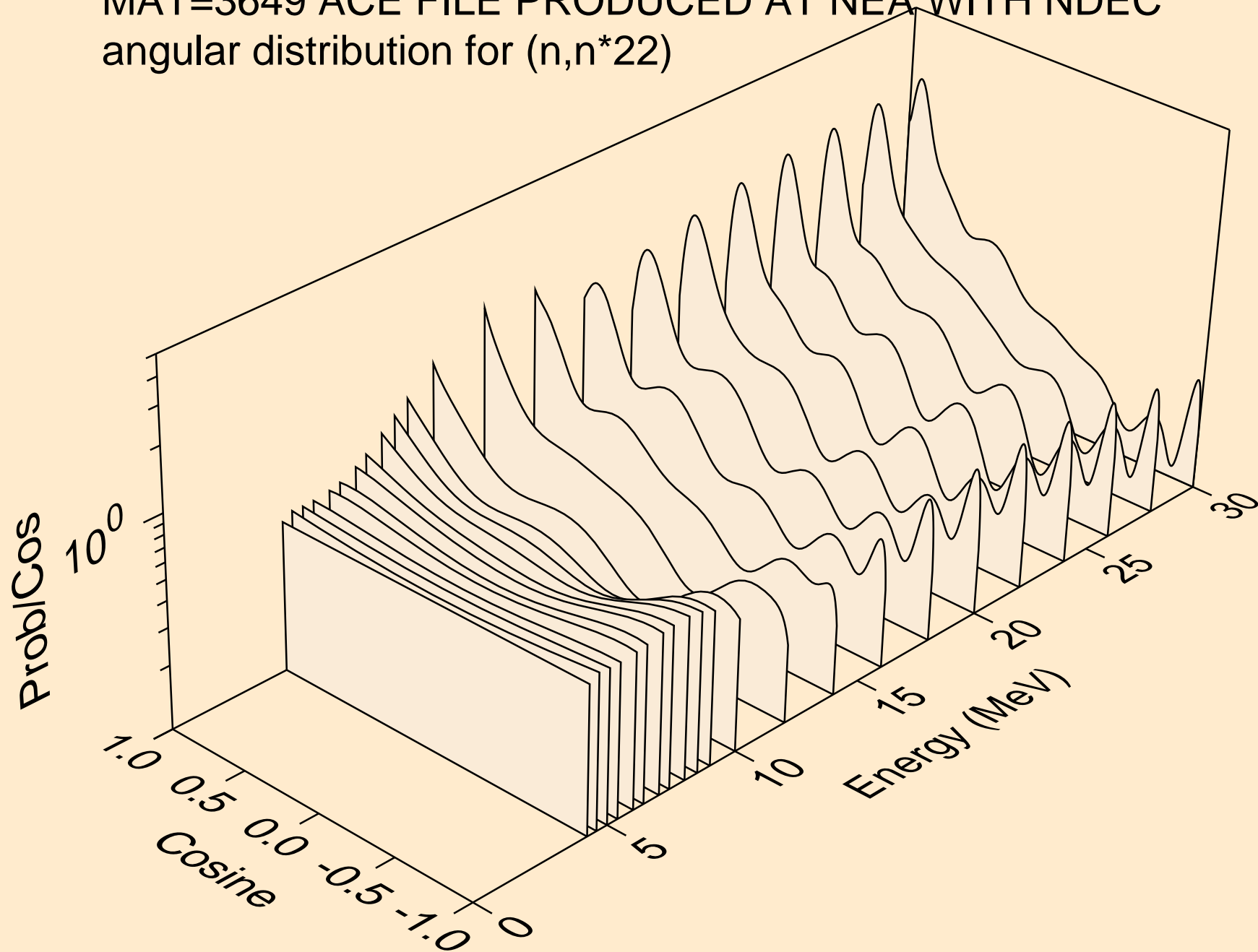

MAT=3649 ACE FILE PRODUCED AT NEA WITH NDEC  
angular distribution for (n,n\*23)

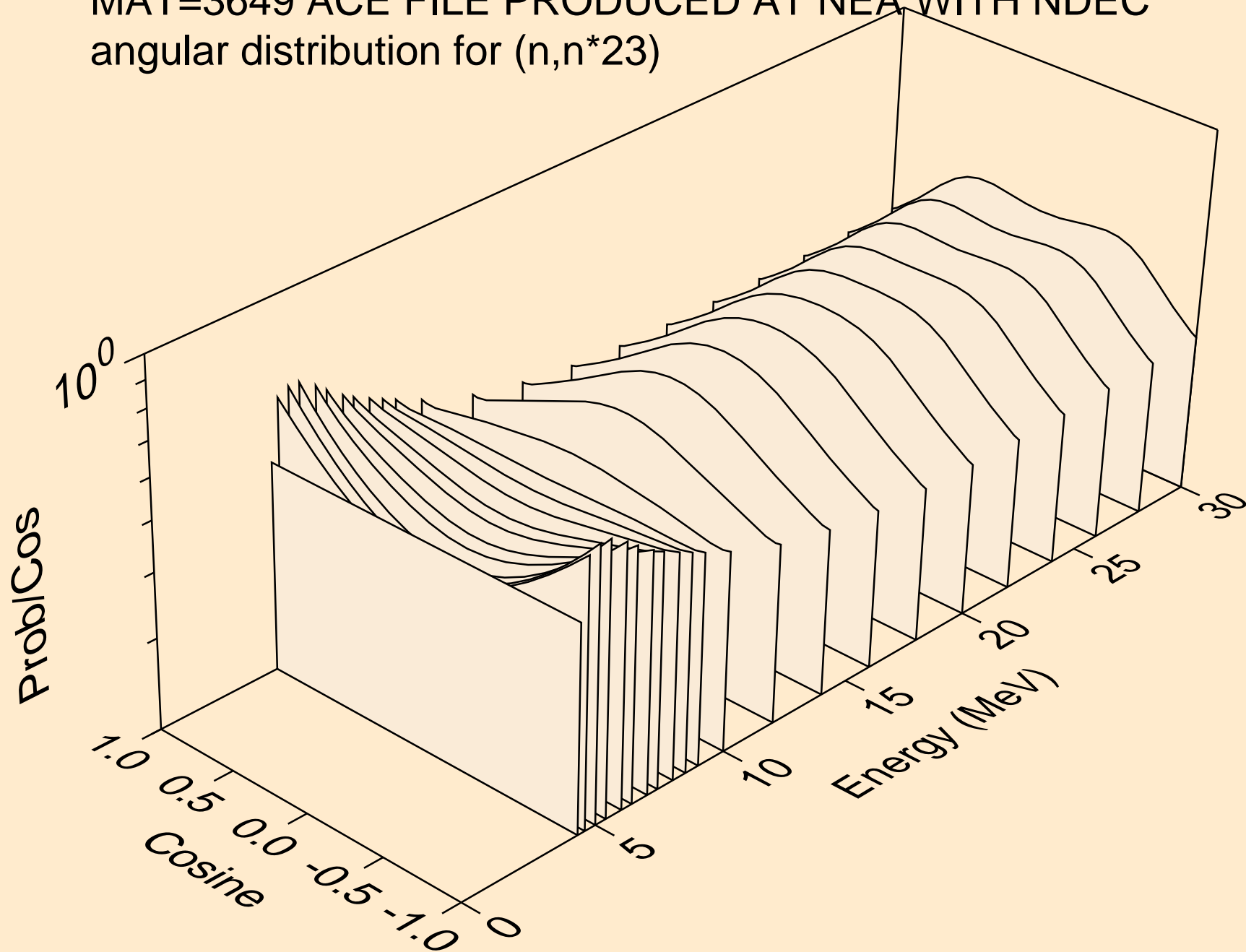

MAT=3649 ACE FILE PRODUCED AT NEA WITH NDEC  
angular distribution for (n,n\*24)

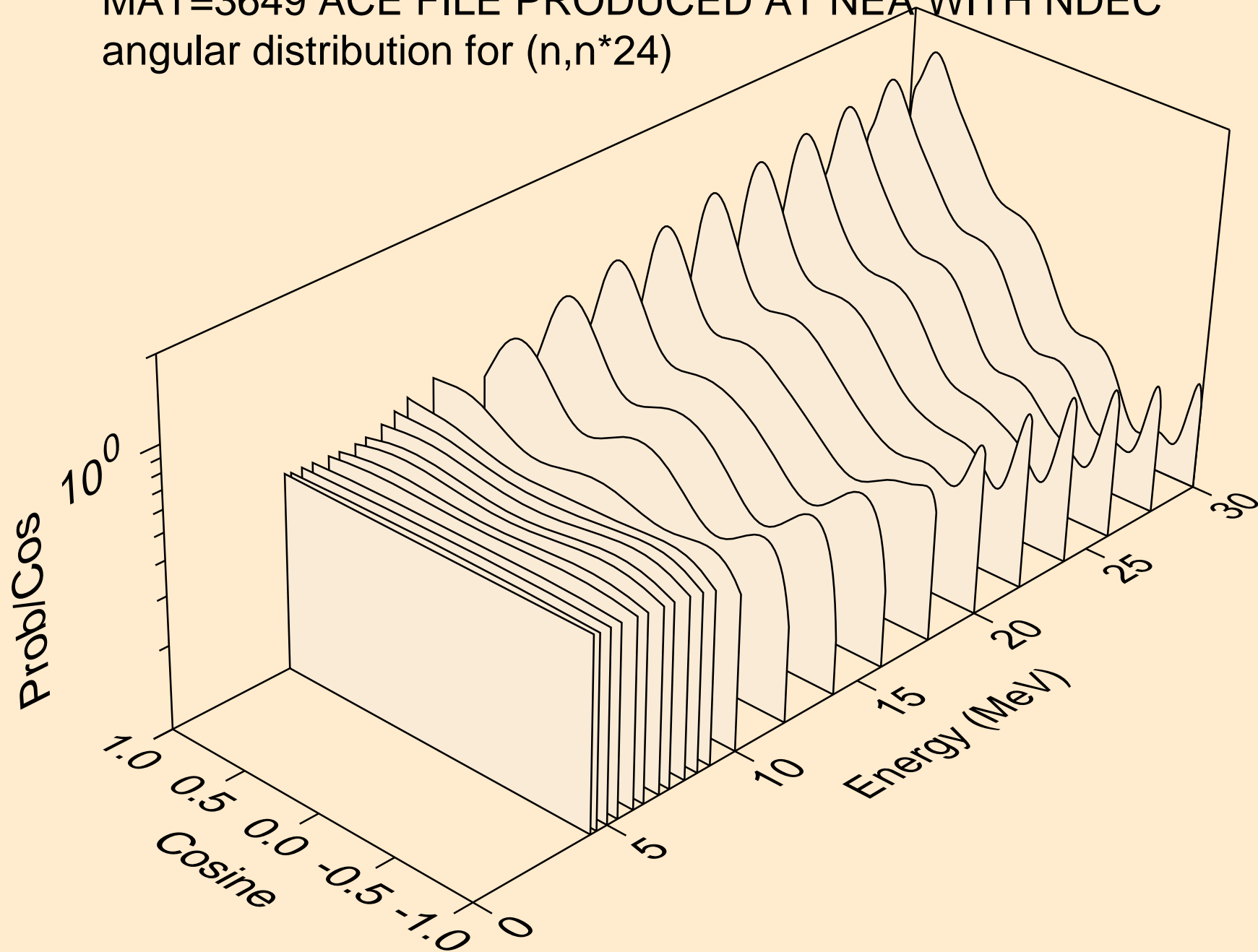

MAT=3649 ACE FILE PRODUCED AT NEA WITH NDEC  
angular distribution for (n,n\*25)

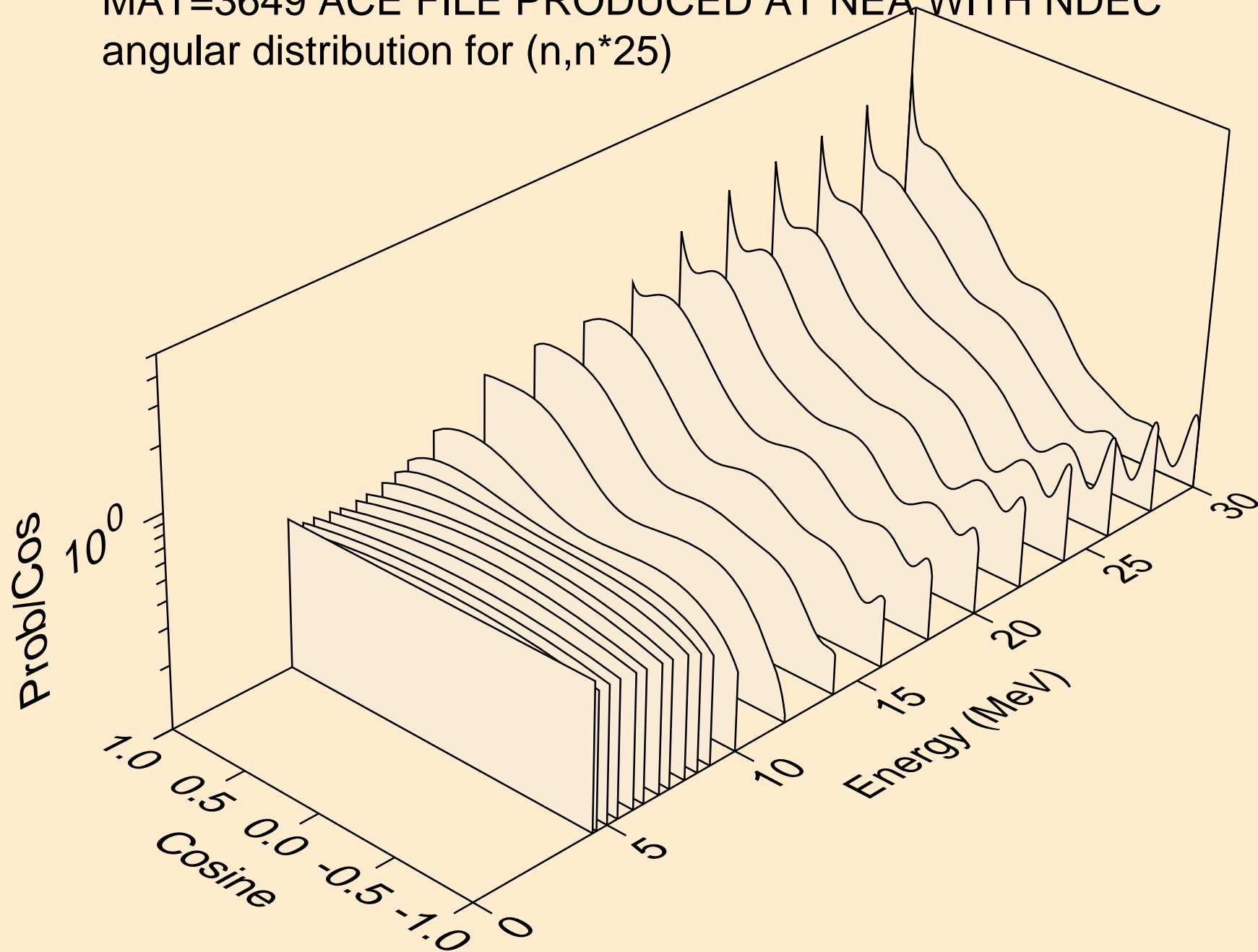

MAT=3649 ACE FILE PRODUCED AT NEA WITH NDEC  
angular distribution for (n,n\*26)

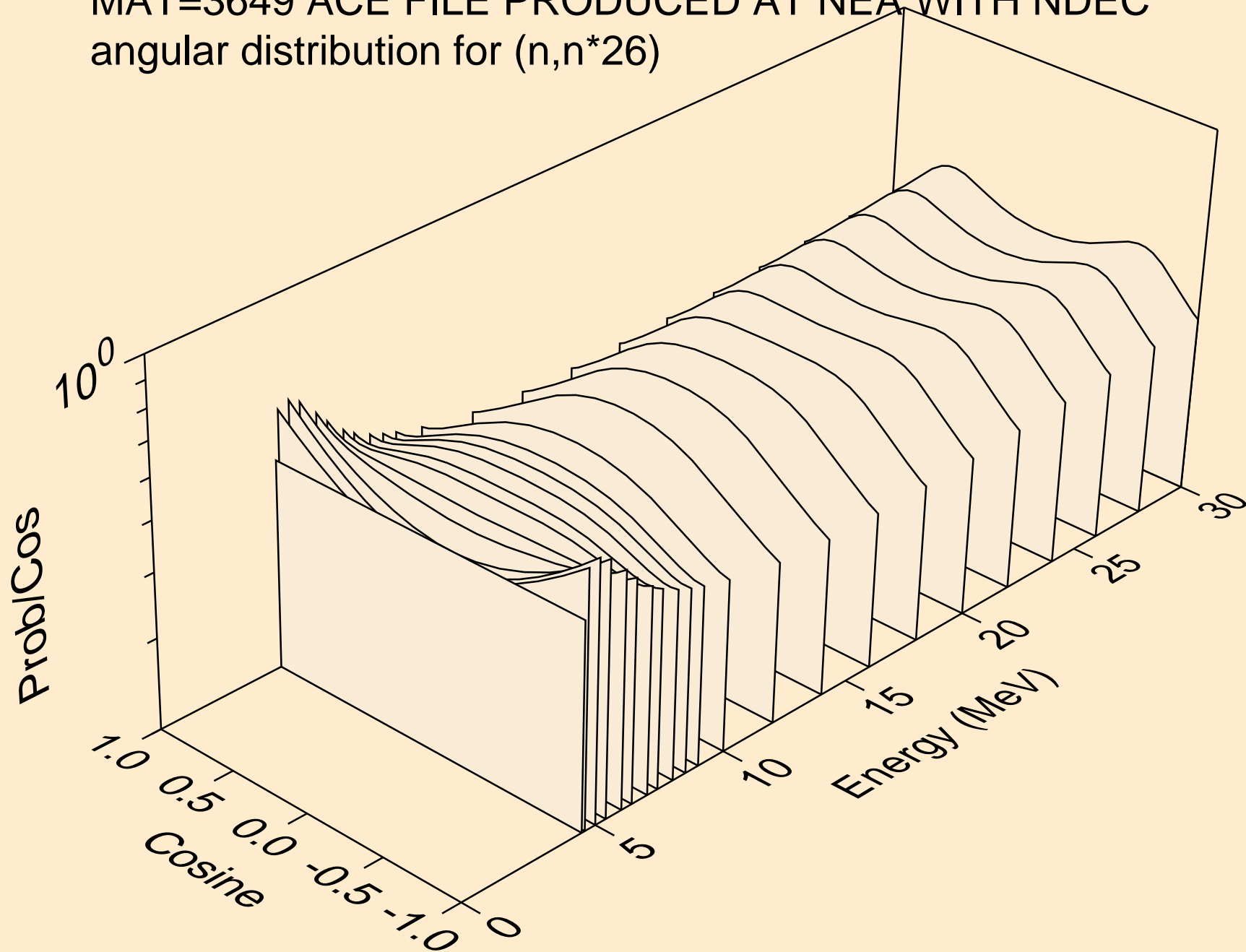

MAT=3649 ACE FILE PRODUCED AT NEA WITH NDEC  
angular distribution for (n,n\*27)

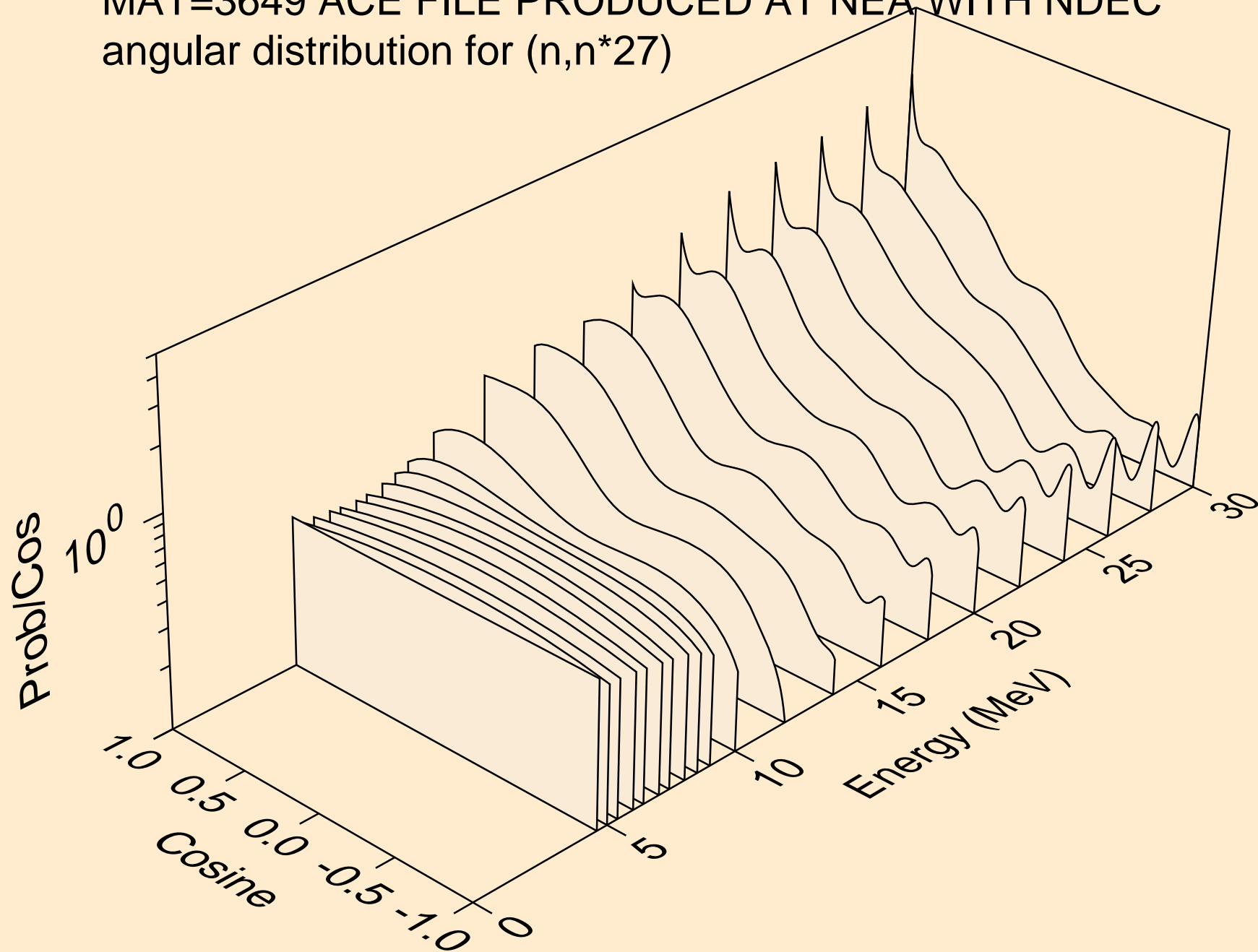

MAT=3649 ACE FILE PRODUCED AT NEA WITH NDEC  
angular distribution for (n,n\*28)

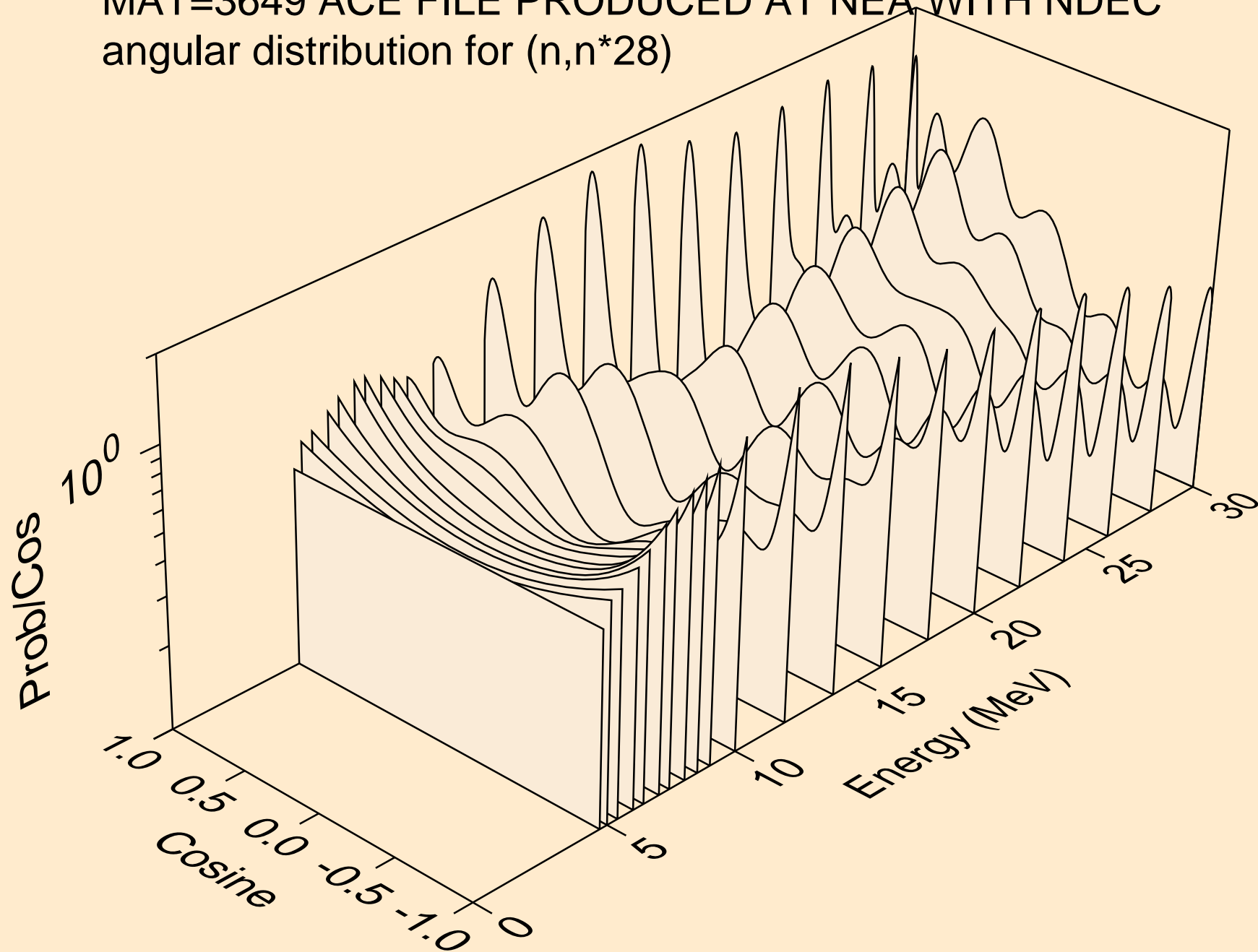

MAT=3649 ACE FILE PRODUCED AT NEA WITH NDEC  
angular distribution for (n,n\*29)

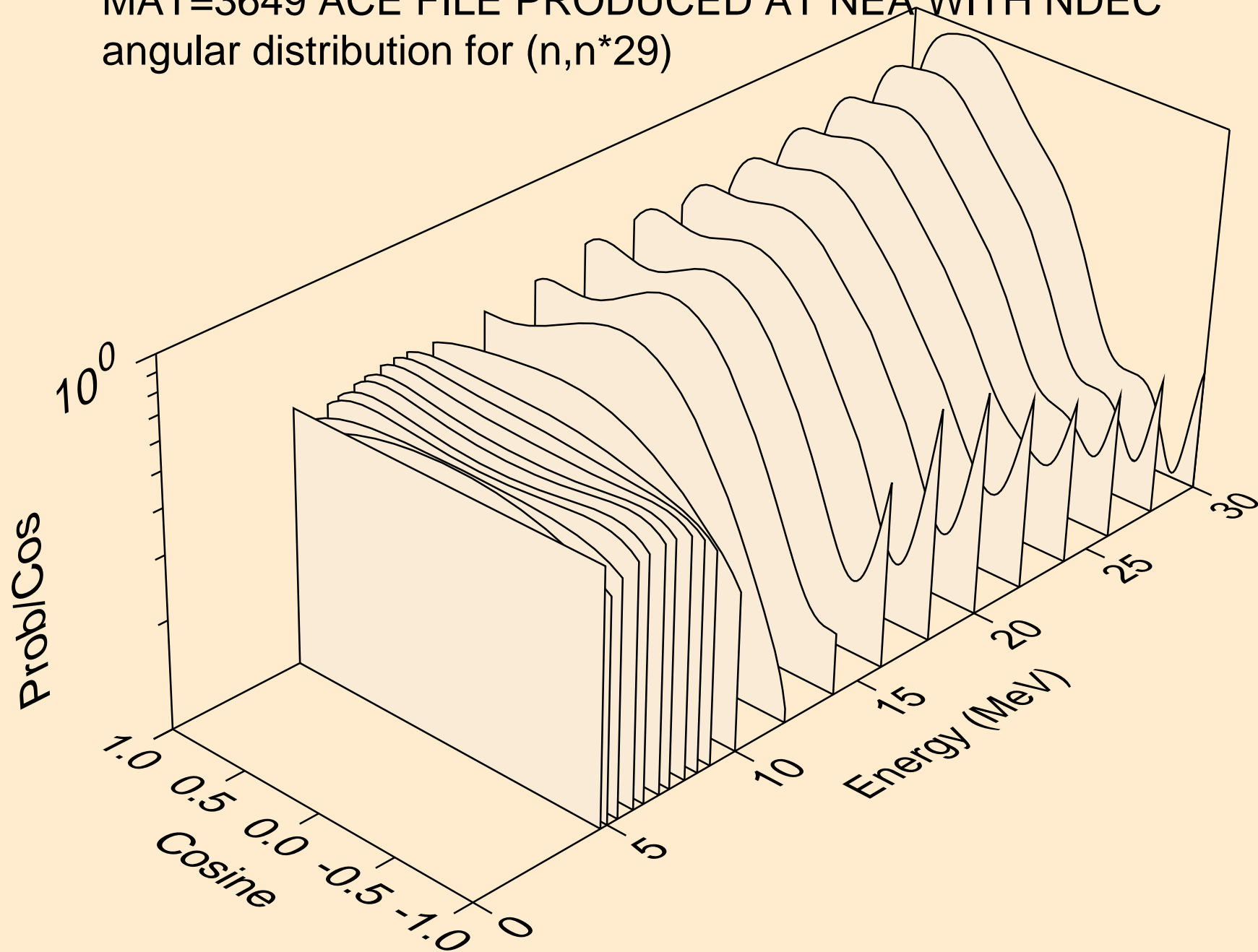

MAT=3649 ACE FILE PRODUCED AT NEA WITH NDEC  
angular distribution for (n,n\*30)

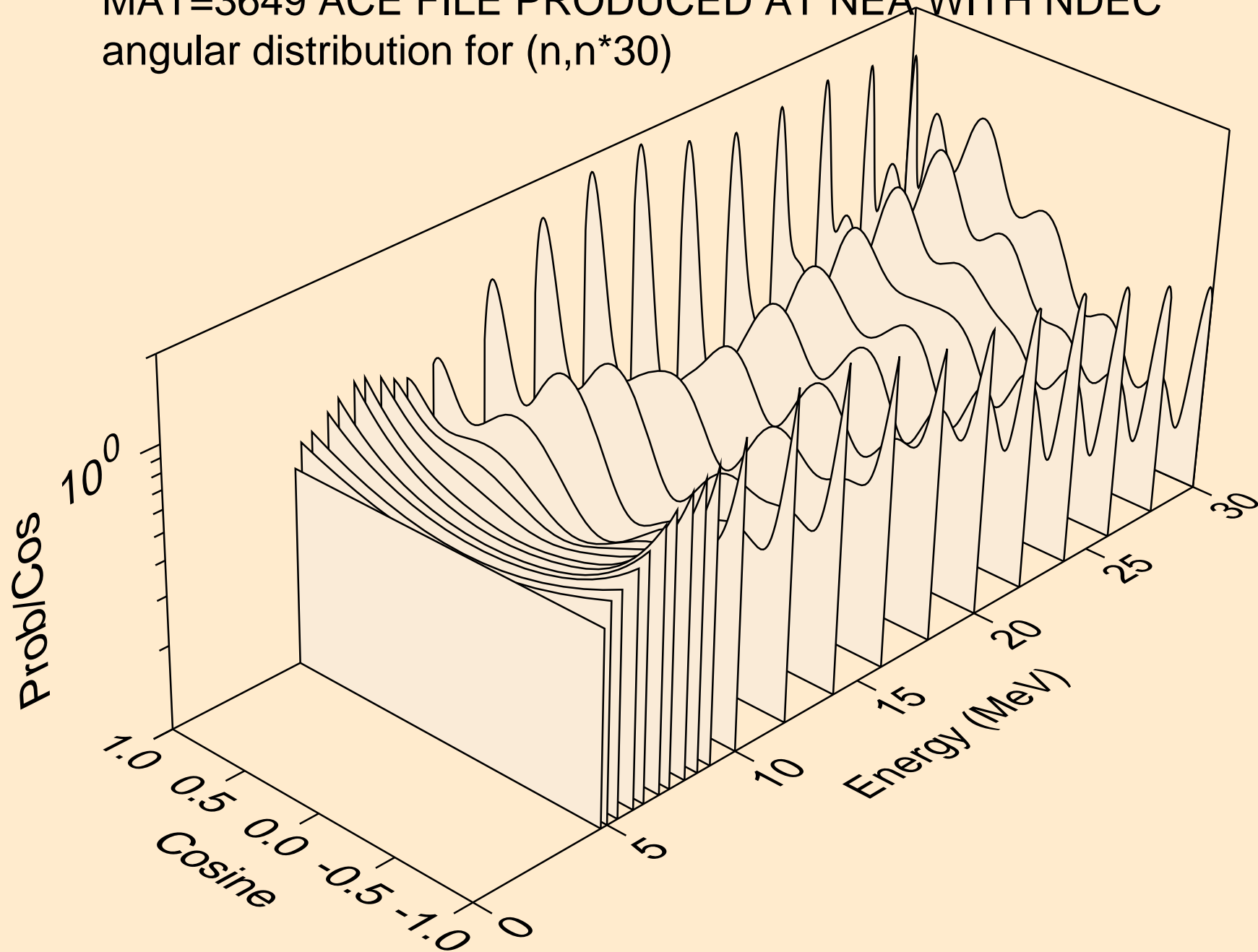

MAT=3649 ACE FILE PRODUCED AT NEA WITH NDEC  
Neutron emission for (n,x)

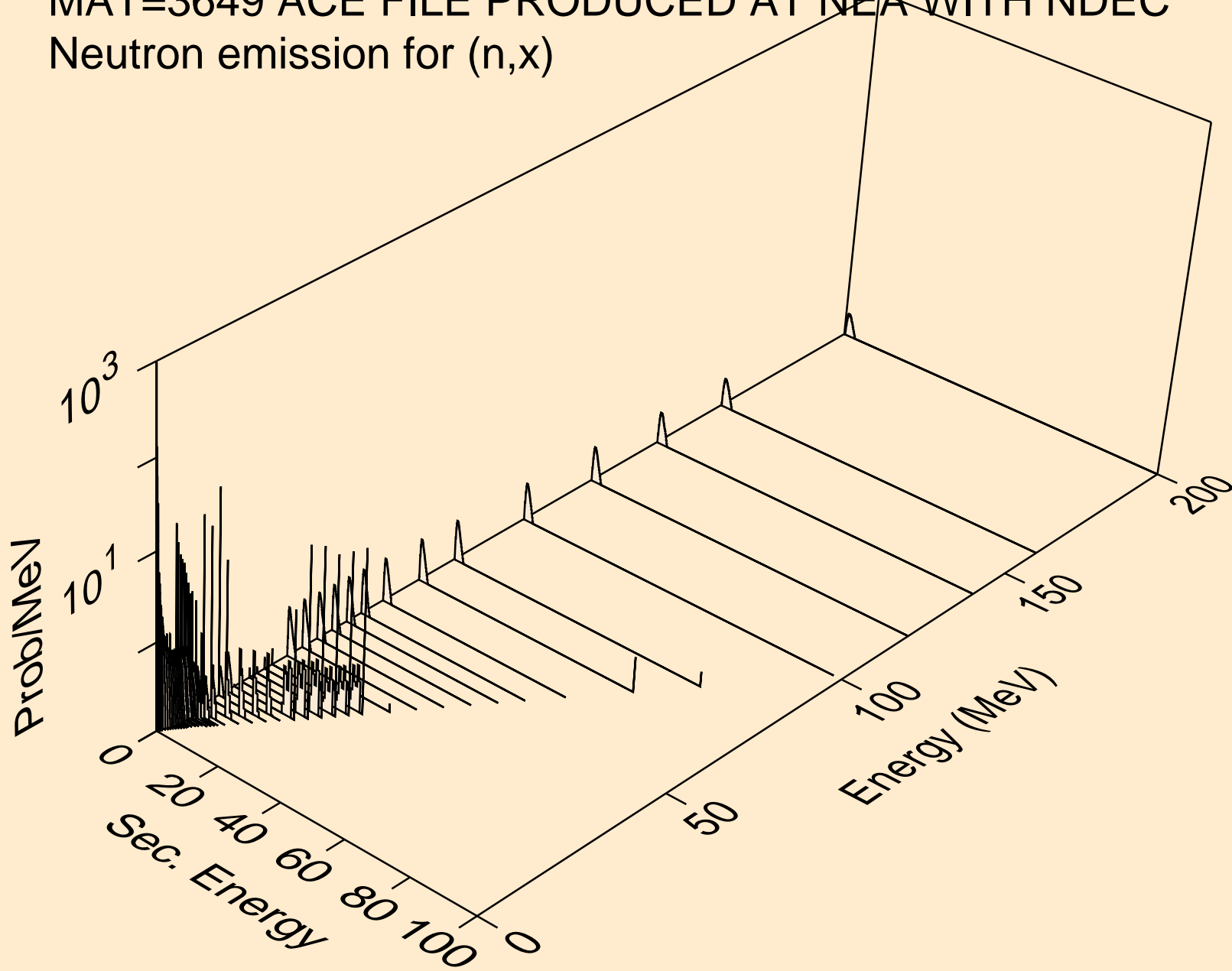

MAT=3649 ACE FILE PRODUCED AT NEA WITH NDEC  
Neutron emission for (n,2nd)

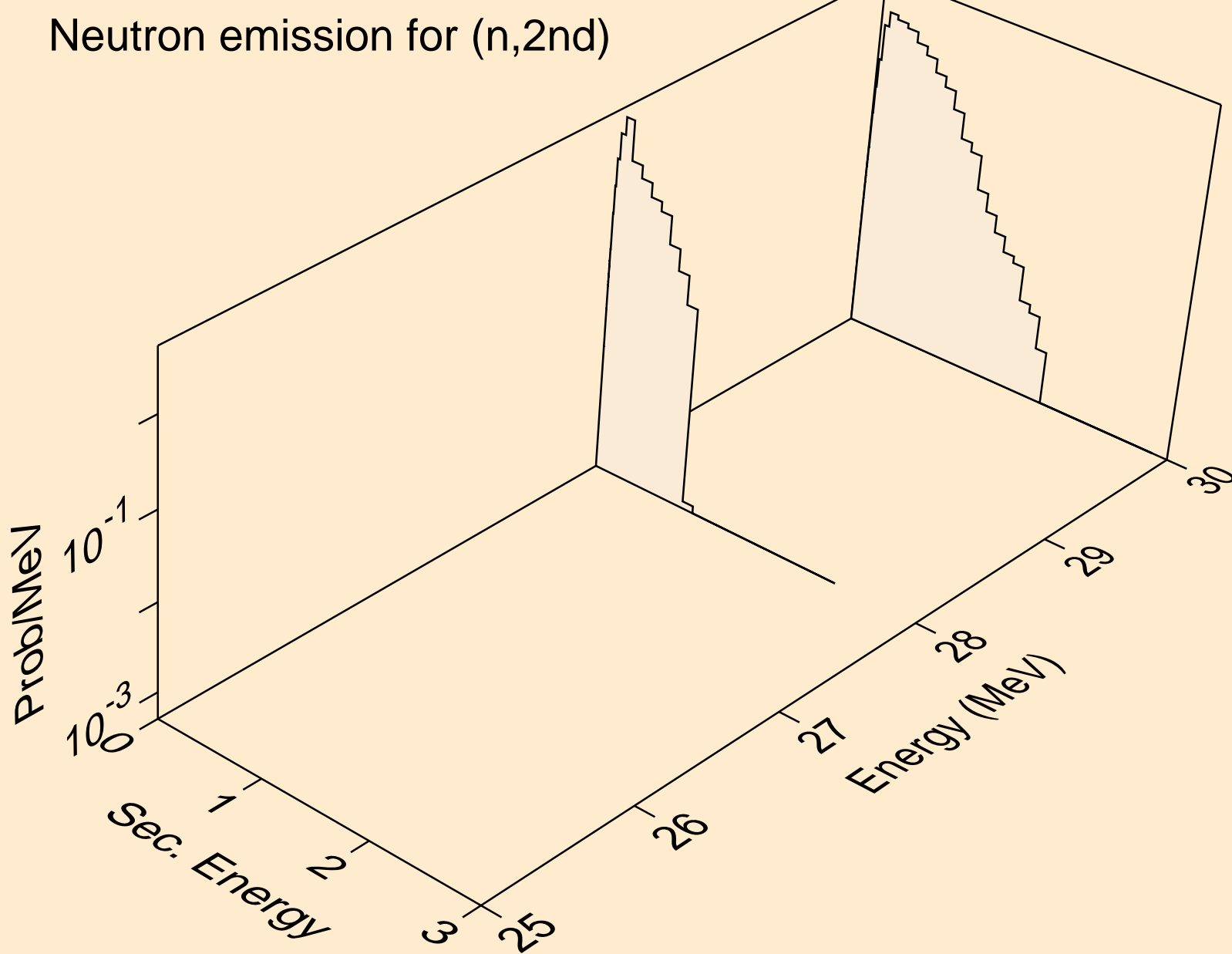

MAT=3649 ACE FILE PRODUCED AT NEA WITH NDEC  
Neutron emission for (n,2n)

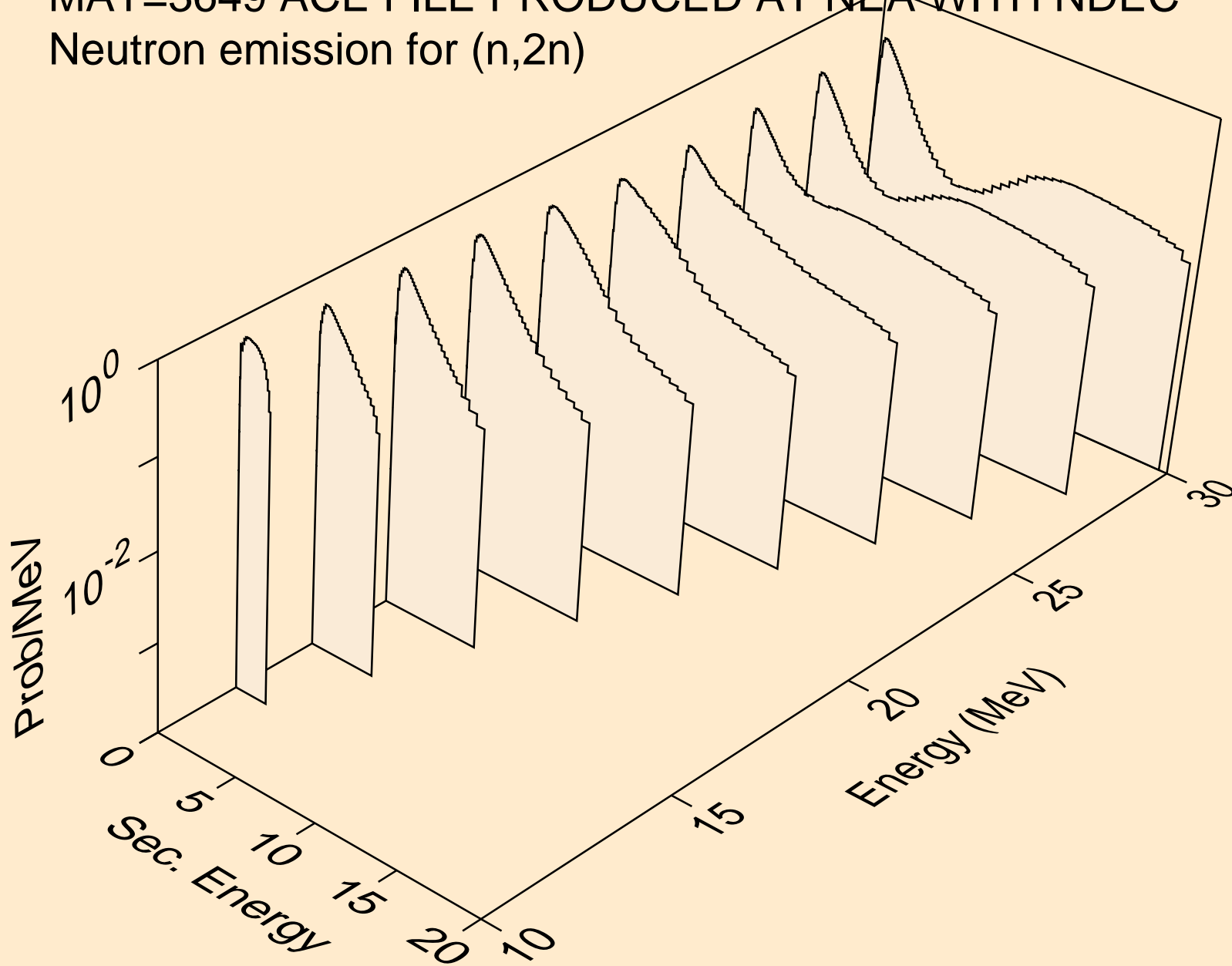

MAT=3649 ACE FILE PRODUCED AT NEA WITH NDEC  
Neutron emission for (n,3n)

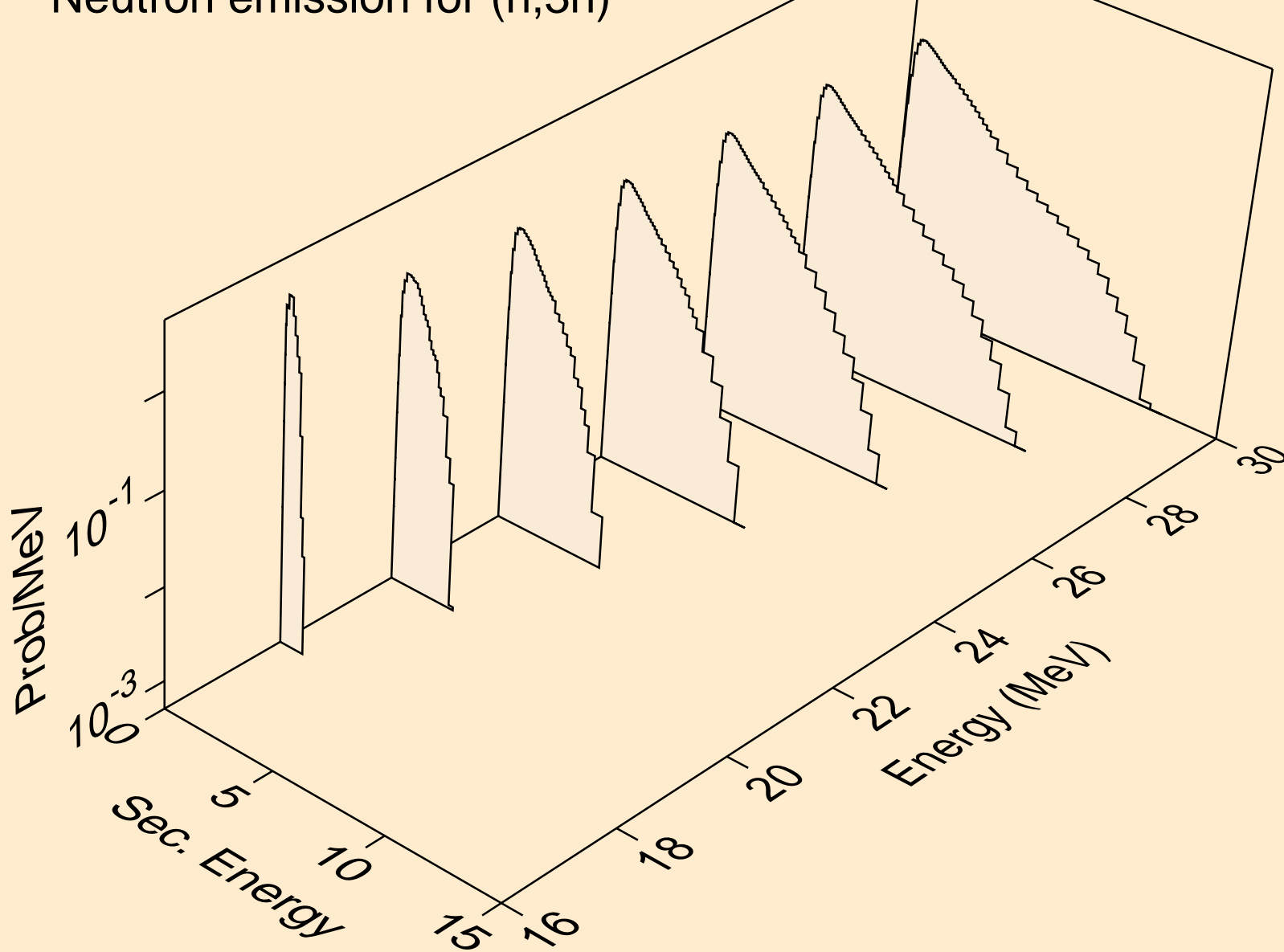

MAT=3649 ACE FILE PRODUCED AT NEA WITH NDEC  
Neutron emission for (n,n\*)a

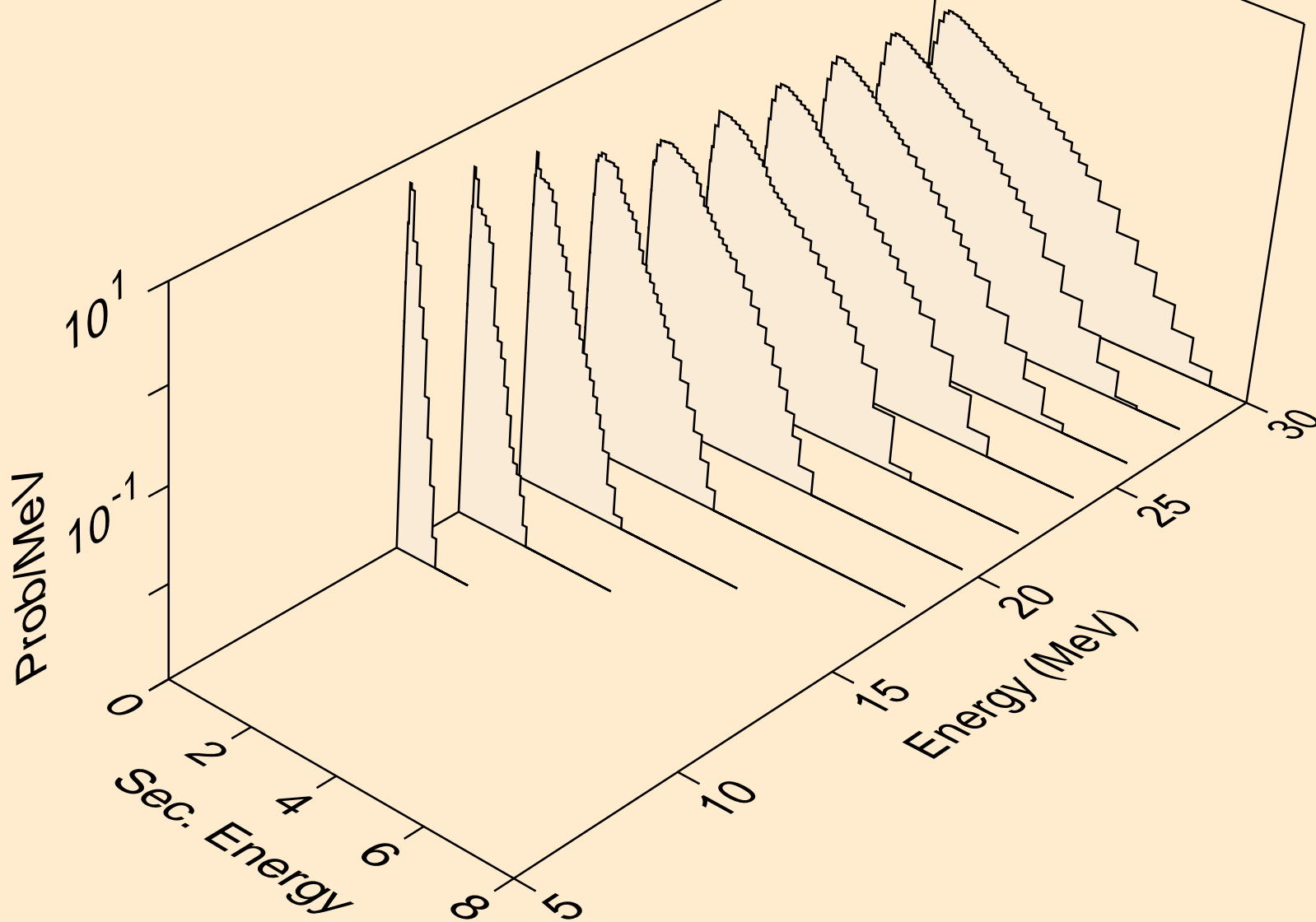

MAT=3649 ACE FILE PRODUCED AT NEA WITH NDEC  
Neutron emission for (n,2n)a

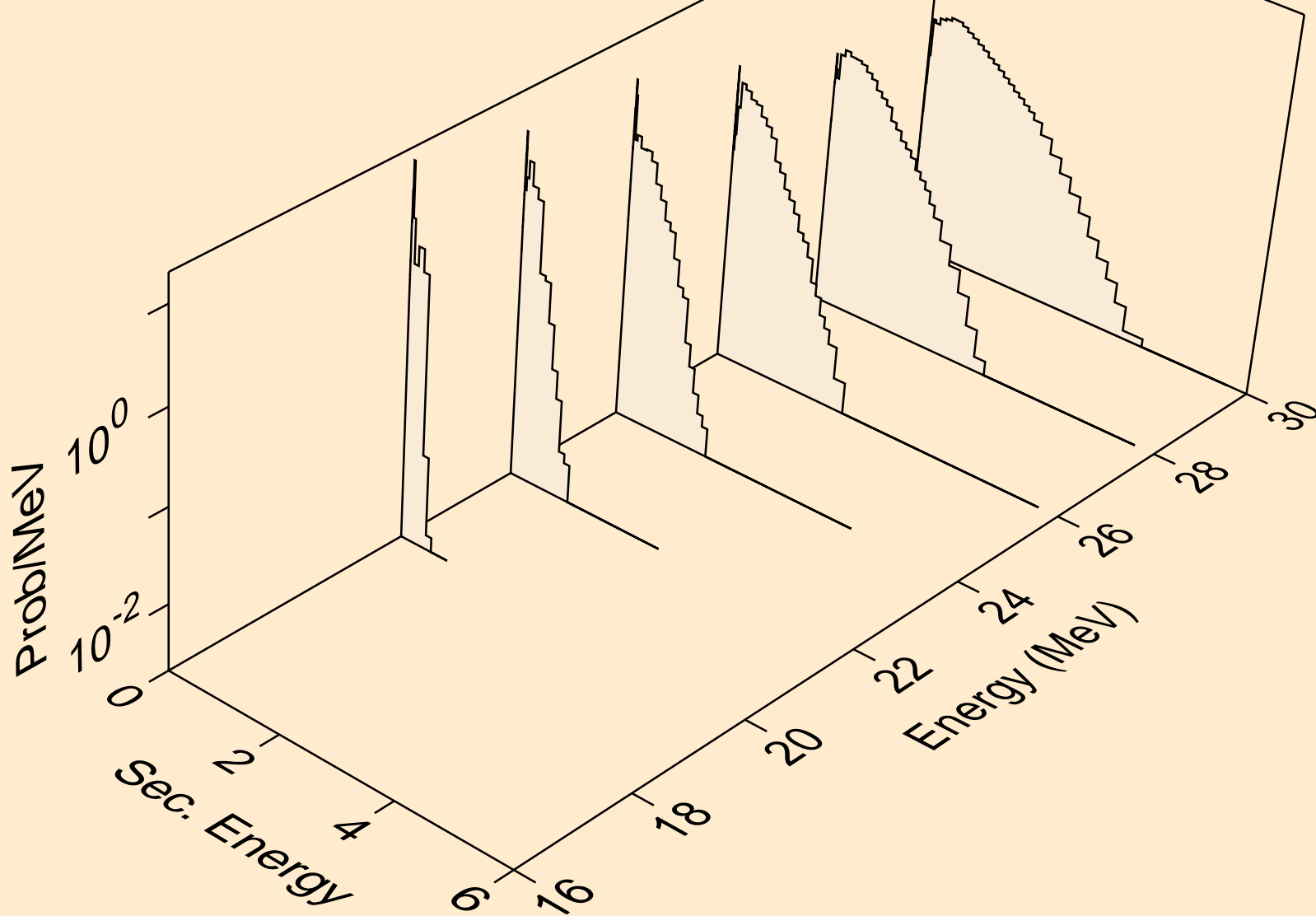

MAT=3649 ACE FILE PRODUCED AT NEA WITH NDEC  
Neutron emission for (n,3n)a

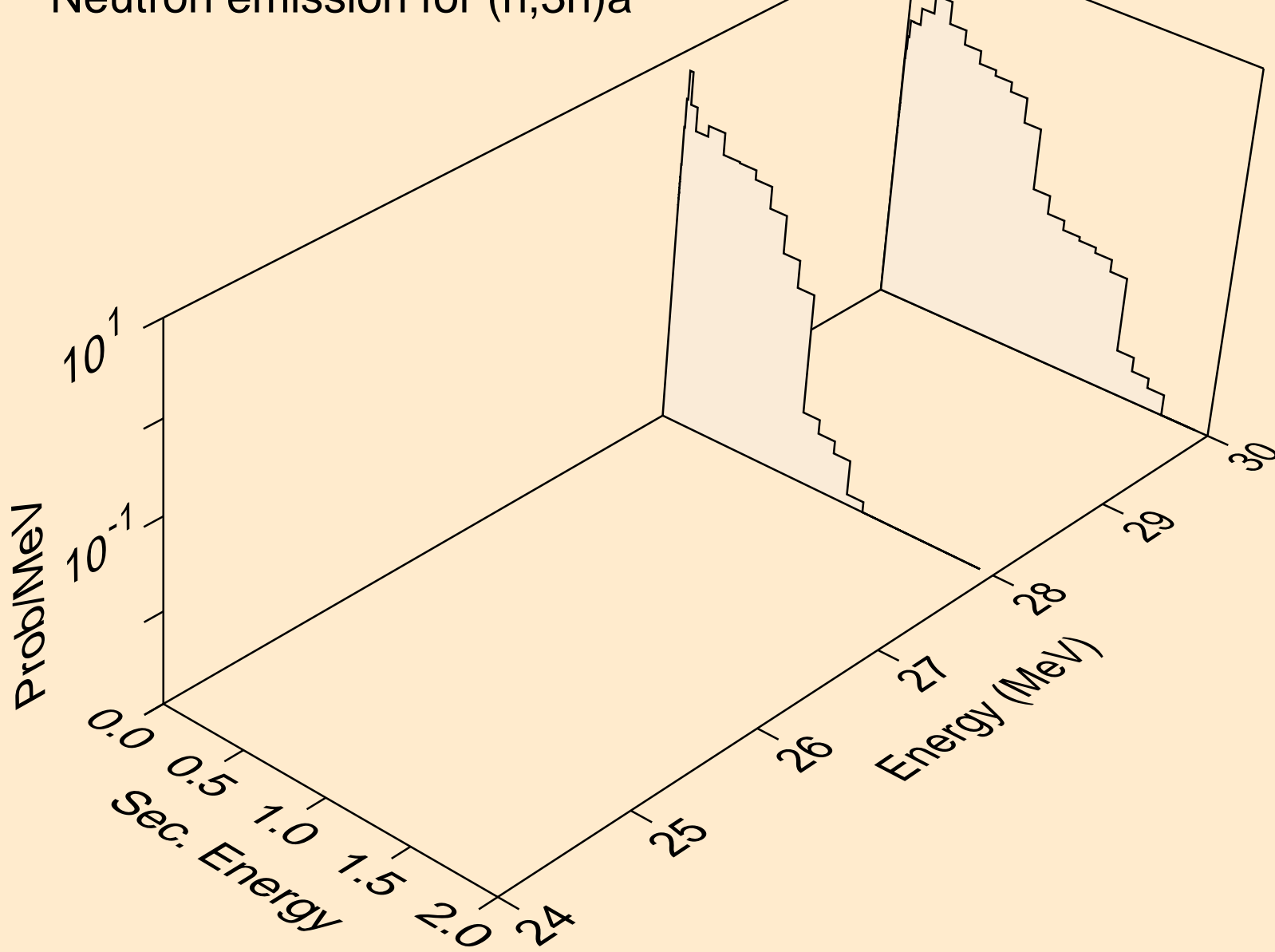

MAT=3649 ACE FILE PRODUCED AT NEA WITH NDEC  
Neutron emission for (n,n\*)p

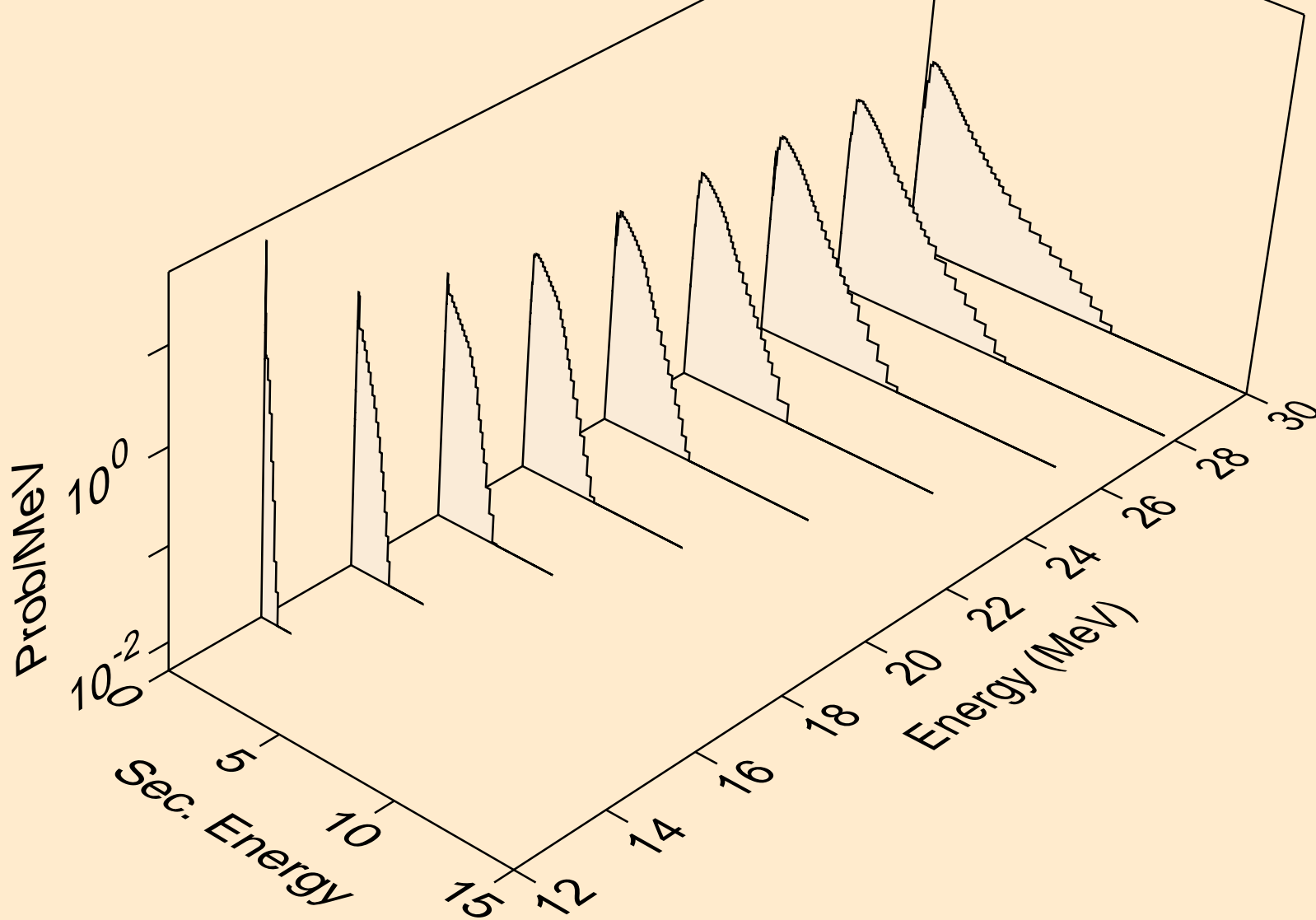

MAT=3649 ACE FILE PRODUCED AT NEA WITH NDEC  
Neutron emission for (n,n\*)d

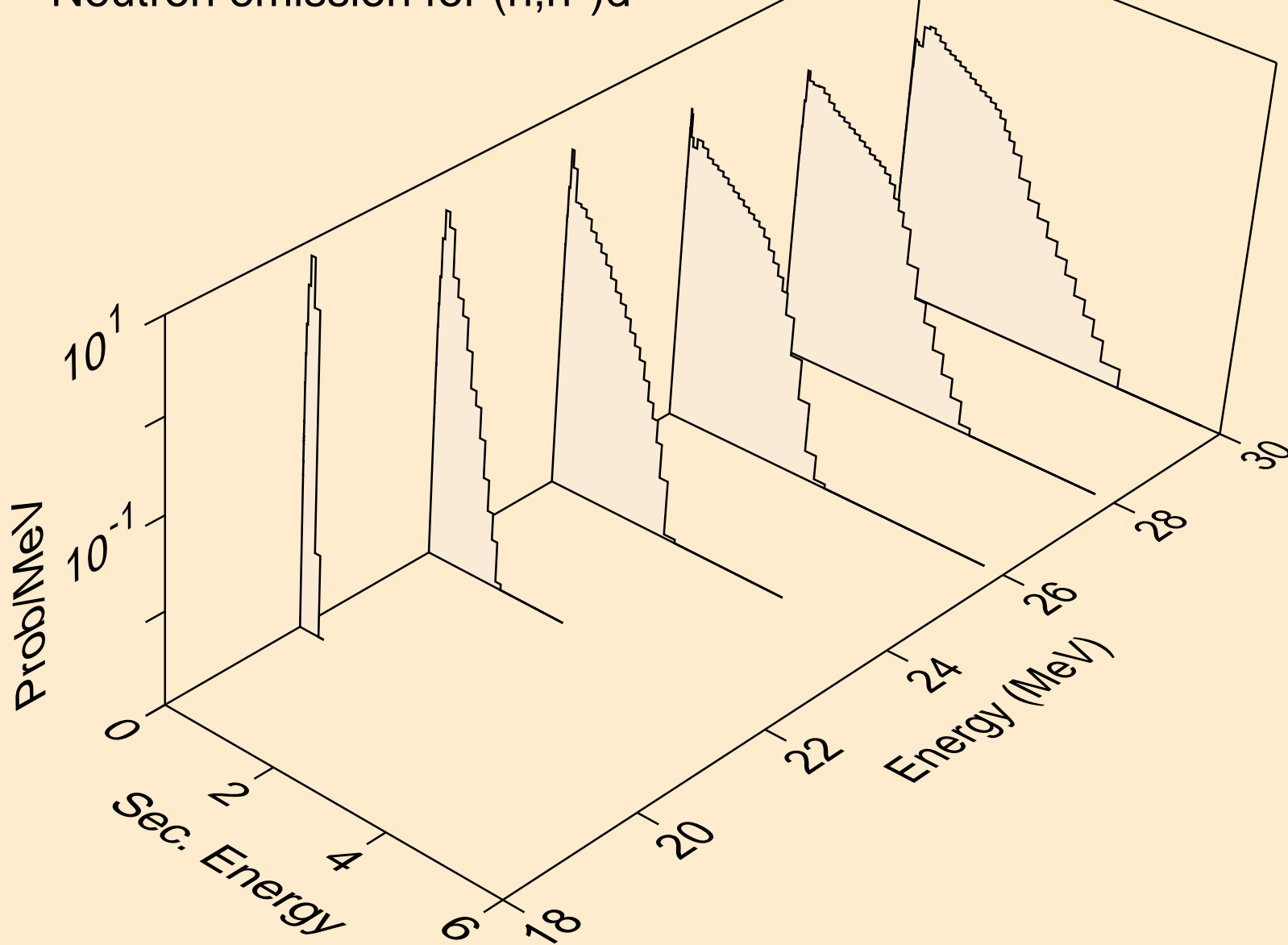

MAT=3649 ACE FILE PRODUCED AT NEA WITH NDEC  
Neutron emission for (n,n\*)t

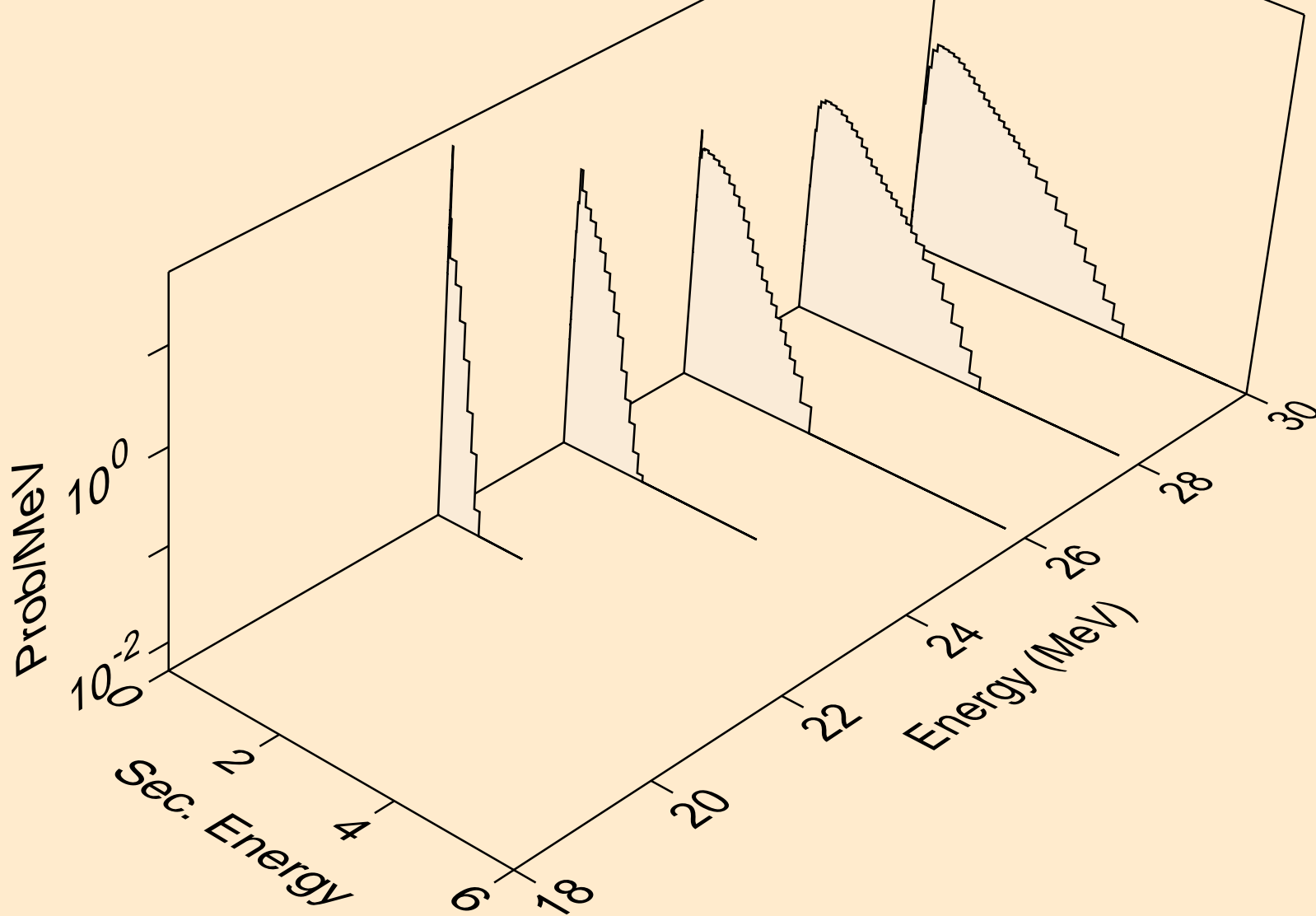

MAT=3649 ACE FILE PRODUCED AT NEA WITH NDEC  
Neutron emission for (n,n\*)he3

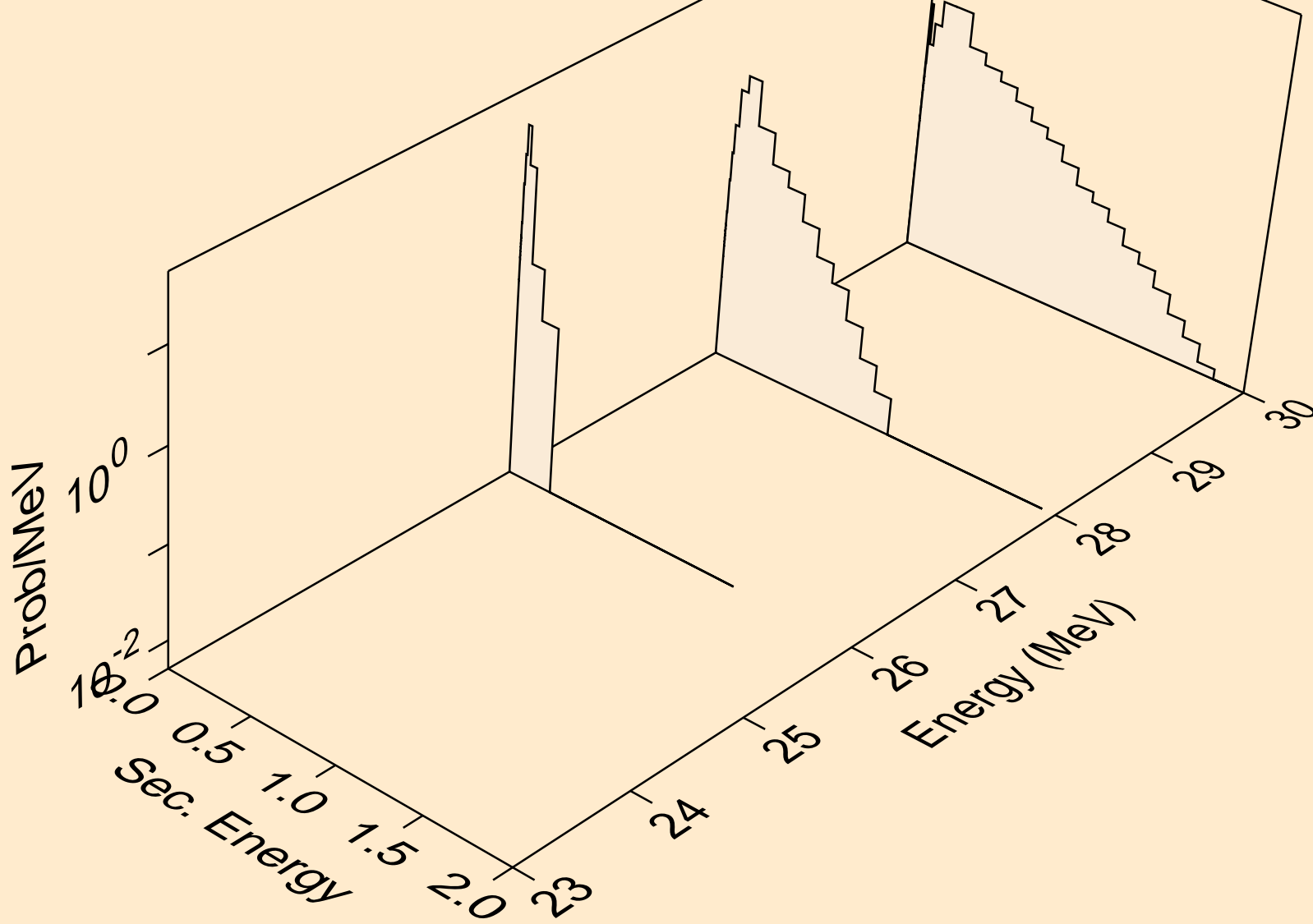

MAT=3649 ACE FILE PRODUCED AT NEA WITH NDEC  
Neutron emission for (n,4n)

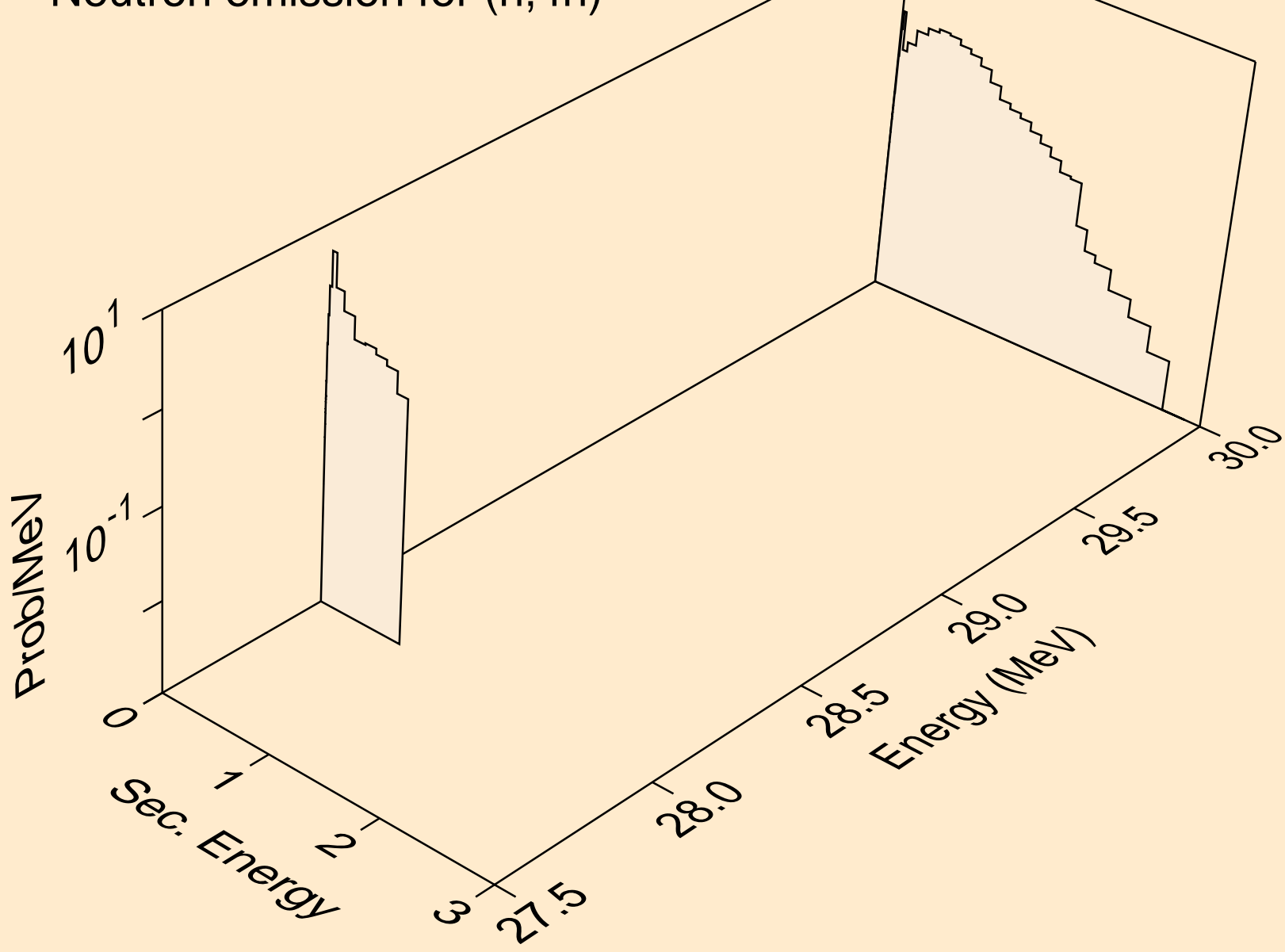

MAT=3649 ACE FILE PRODUCED AT NEA WITH NDEC  
Neutron emission for (n,2np)

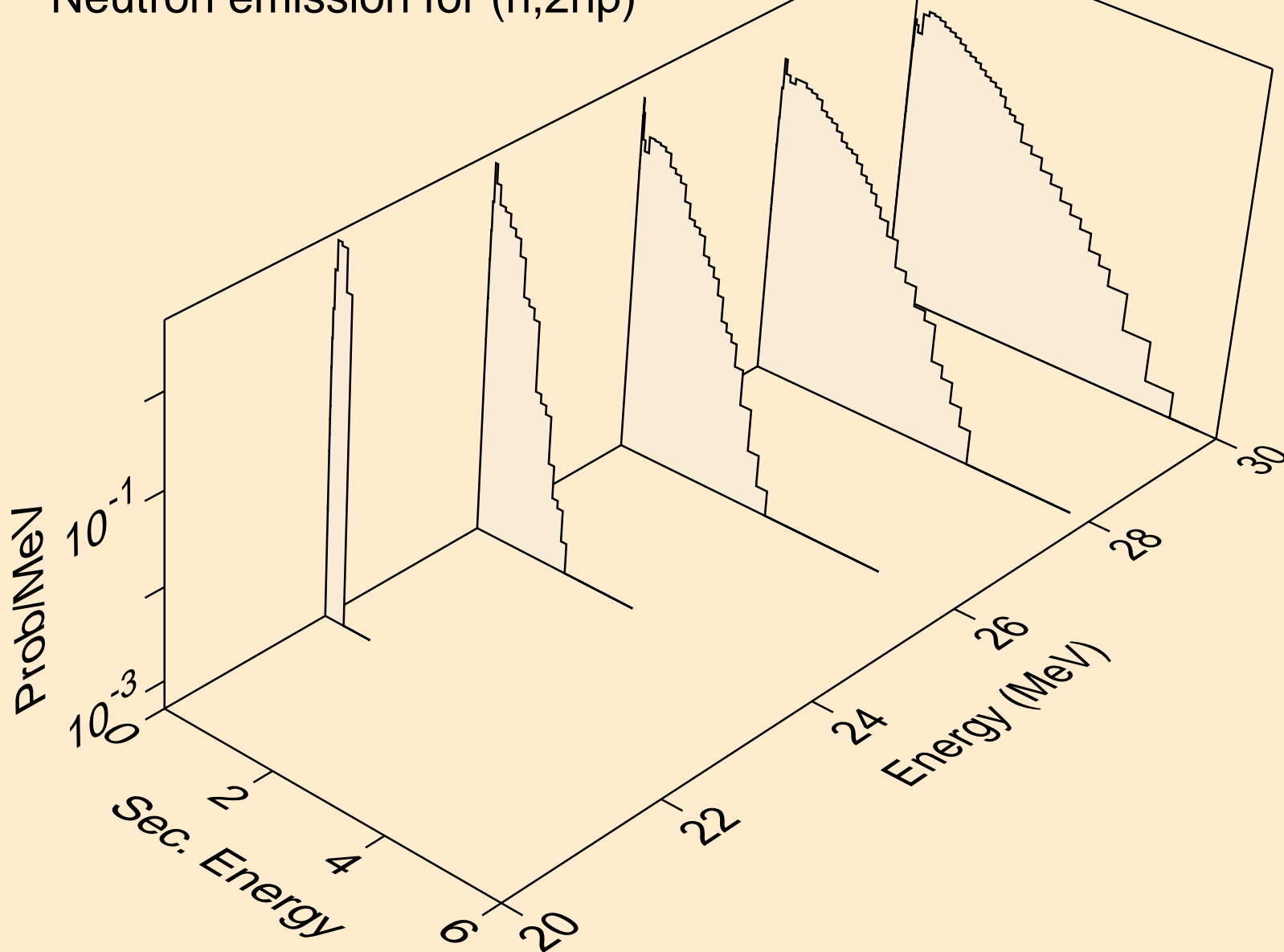

MAT=3649 ACE FILE PRODUCED AT NEA WITH NDEC  
Neutron emission for (n,3np)

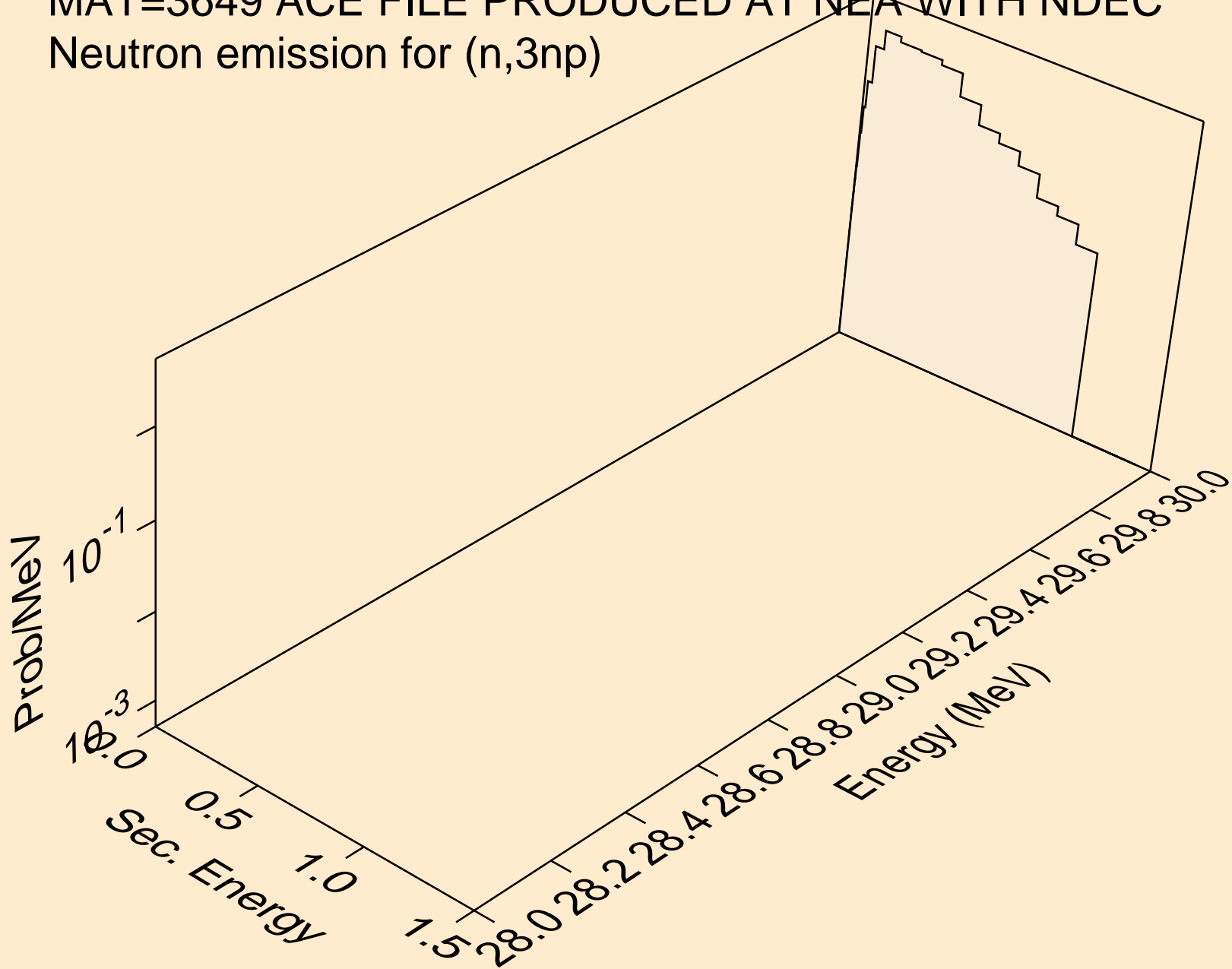

MAT=3649 ACE FILE PRODUCED AT NEA WITH NDEC  
Neutron emission for (n,2np)

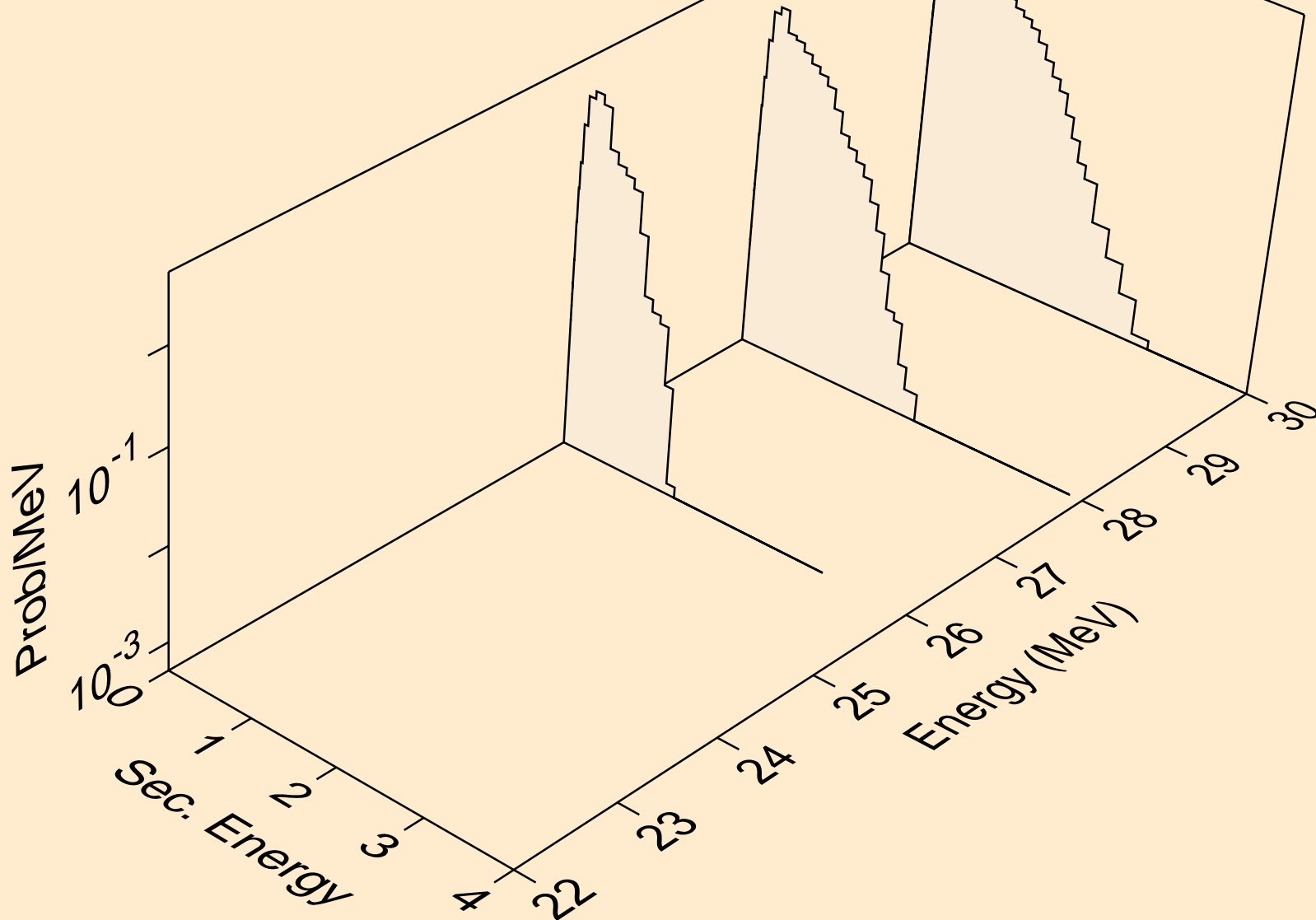

MAT=3649 ACE FILE PRODUCED AT NEA WITH NDEC  
Neutron emission for (n,n\*c)

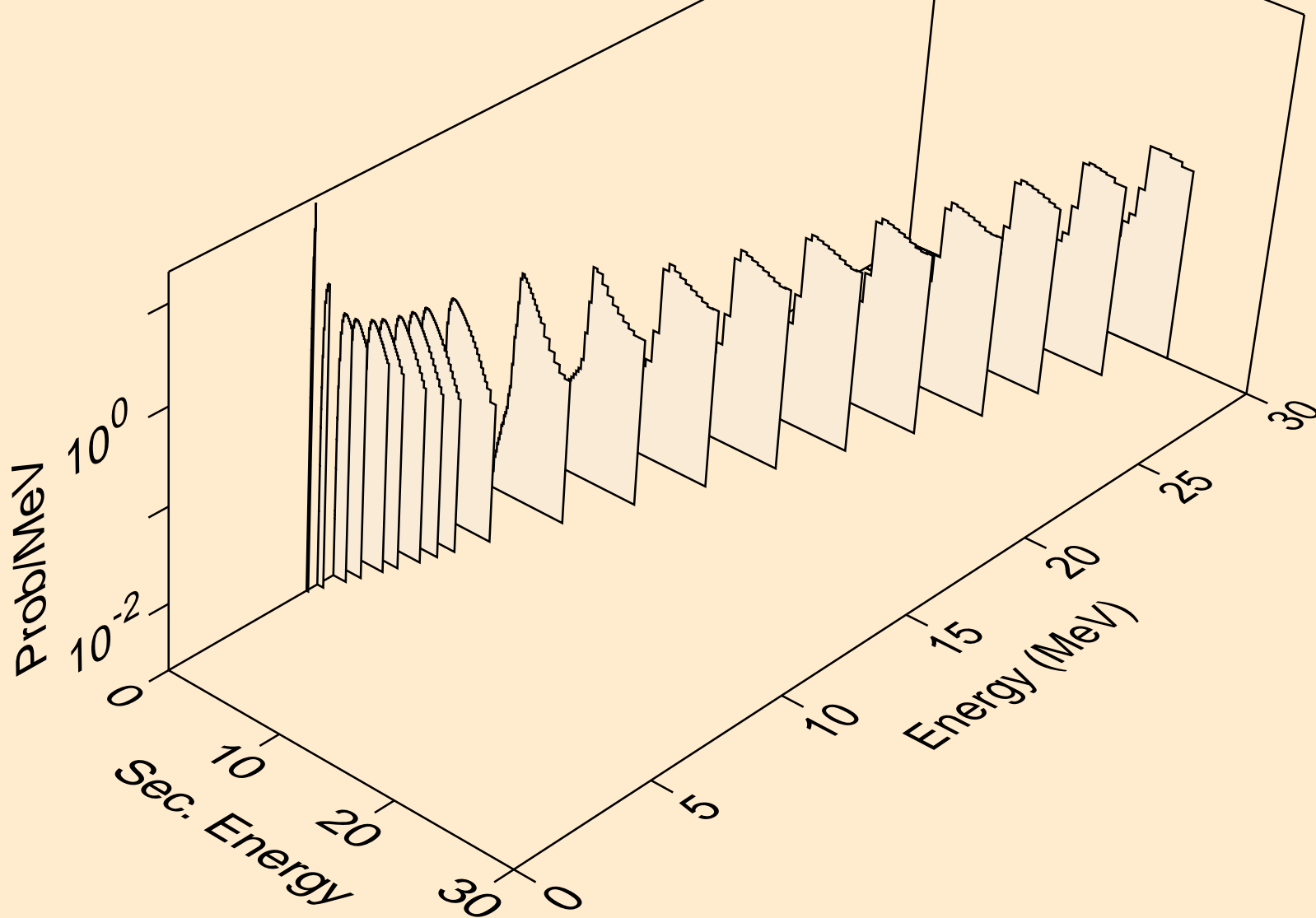

MAT=3649 ACE FILE PRODUCED AT NEA WITH NDEC  
Photon emission for (n,x)

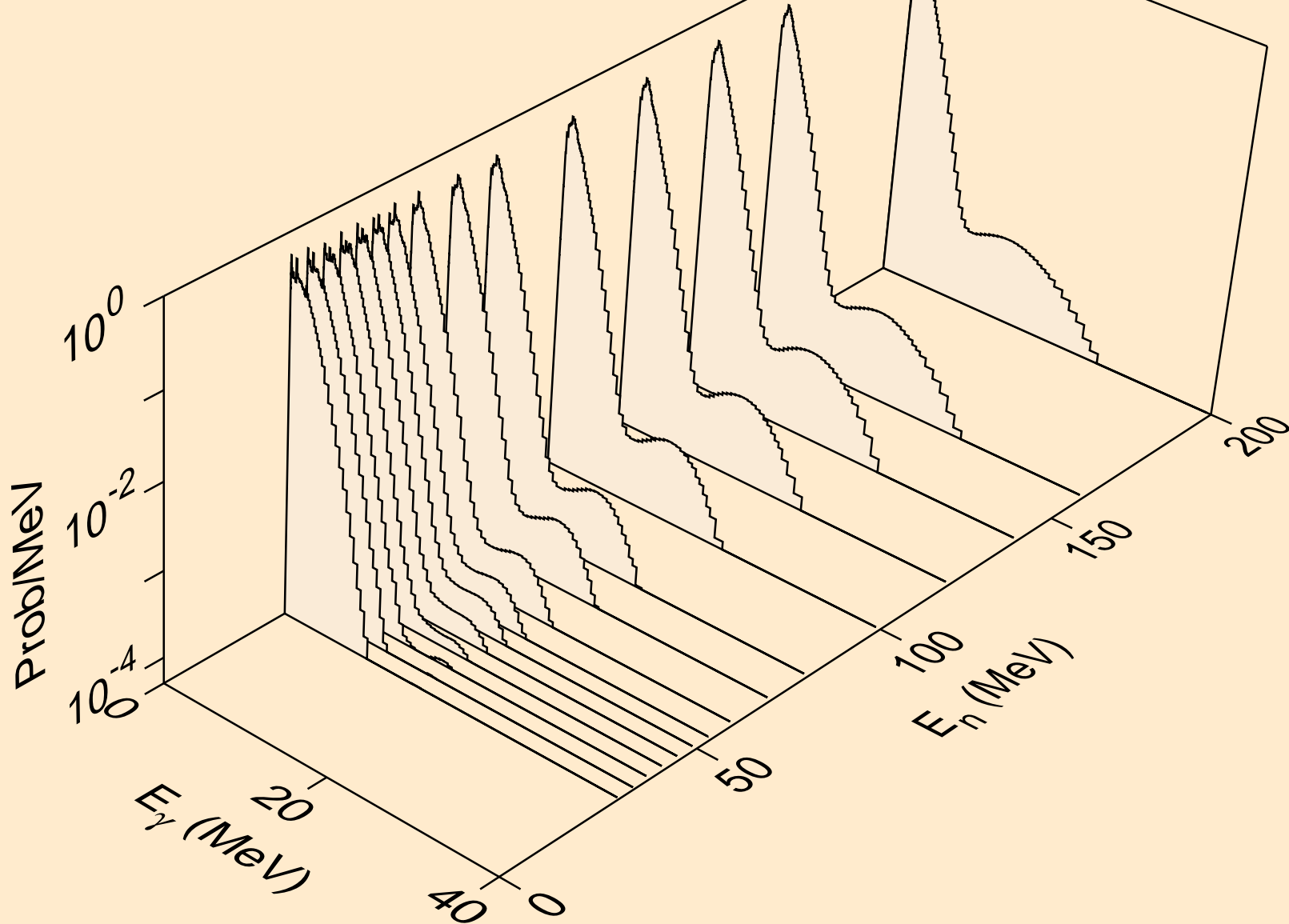

MAT=3649 ACE FILE PRODUCED AT NEA WITH NDEC  
Photon emission for (n,2nd)

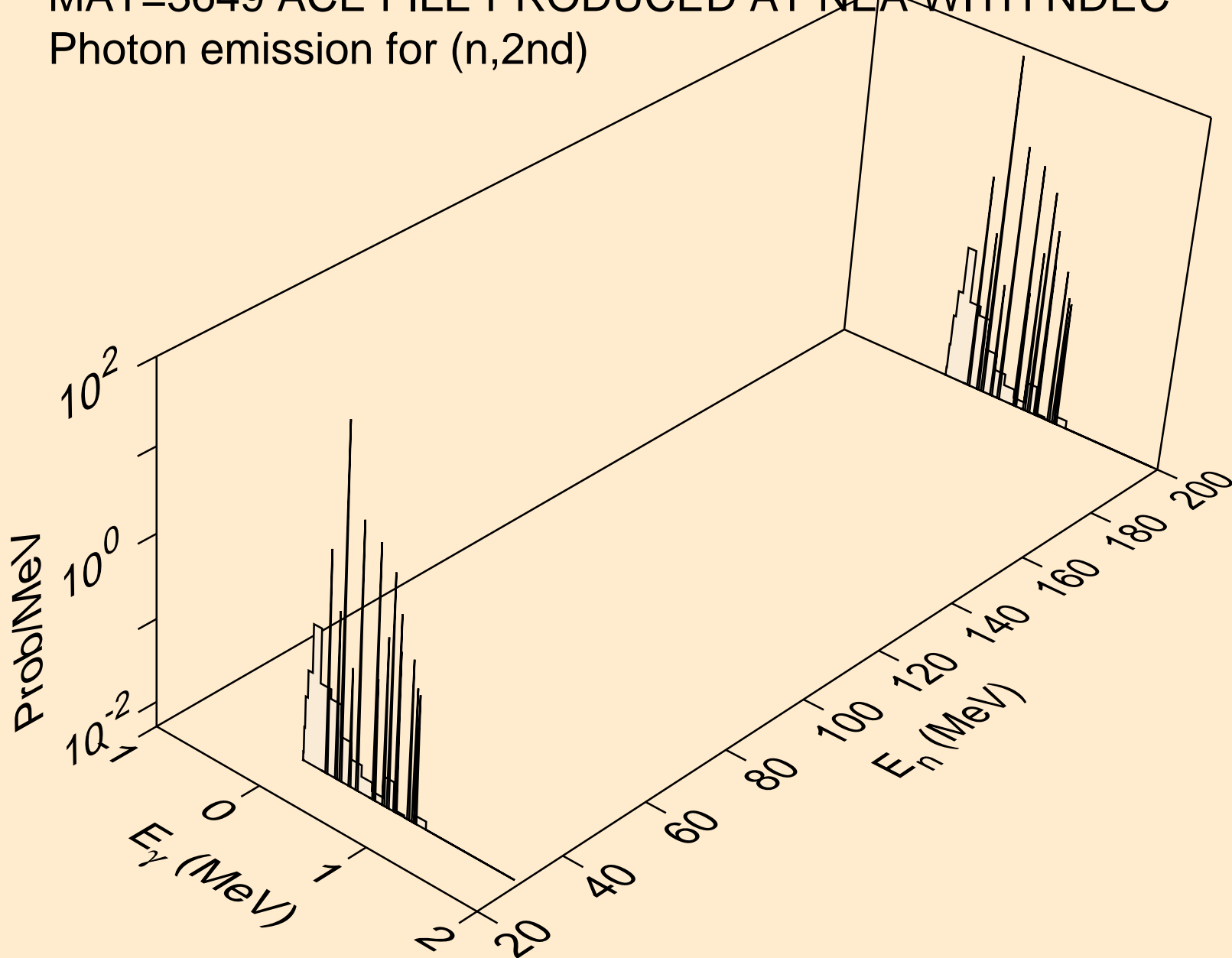

MAT=3649 ACE FILE PRODUCED AT NEA WITH NDEC  
Photon emission for (n,2n)

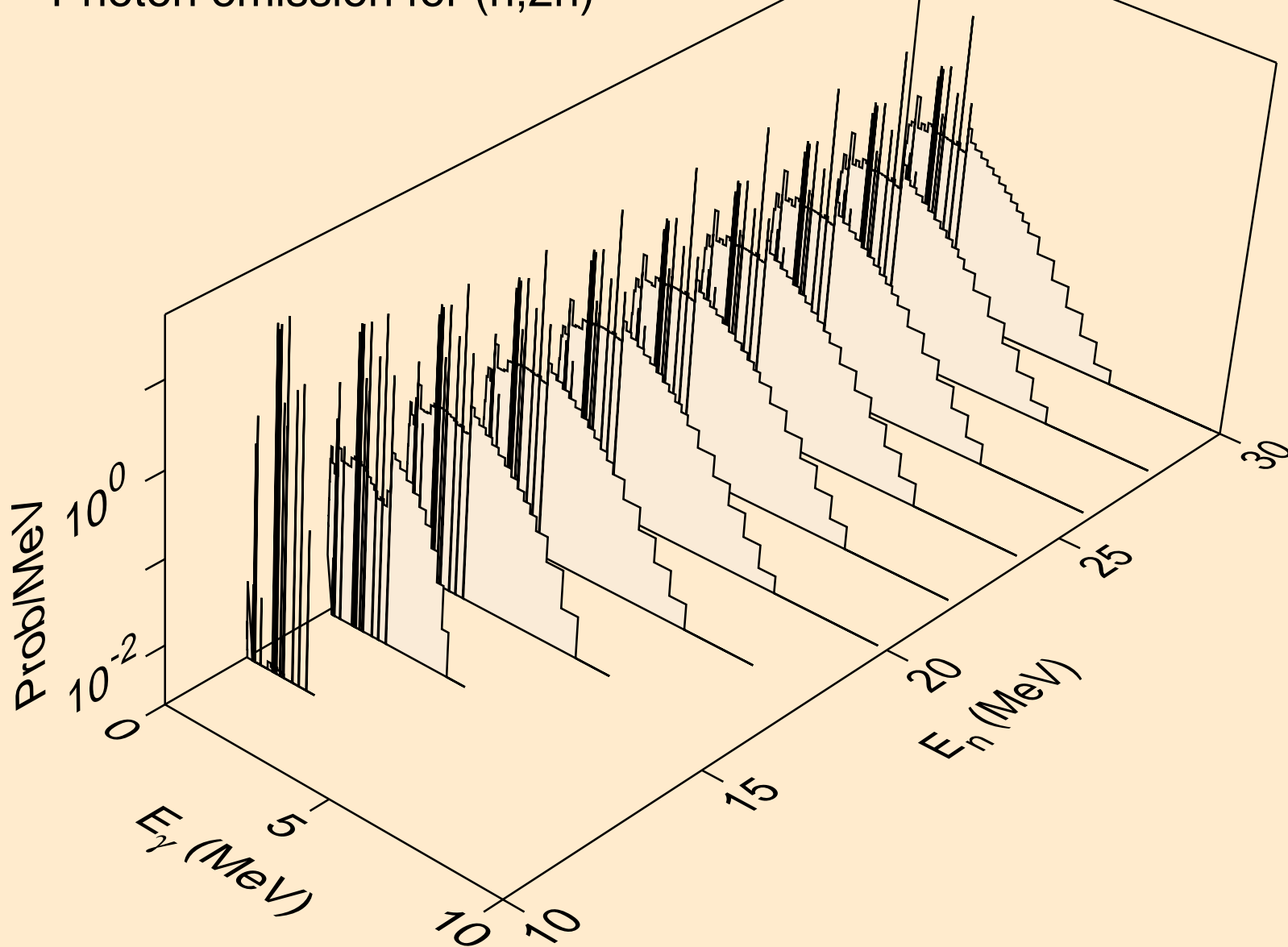

MAT=3649 ACE FILE PRODUCED AT NEA WITH NDEC  
Photon emission for (n,3n)

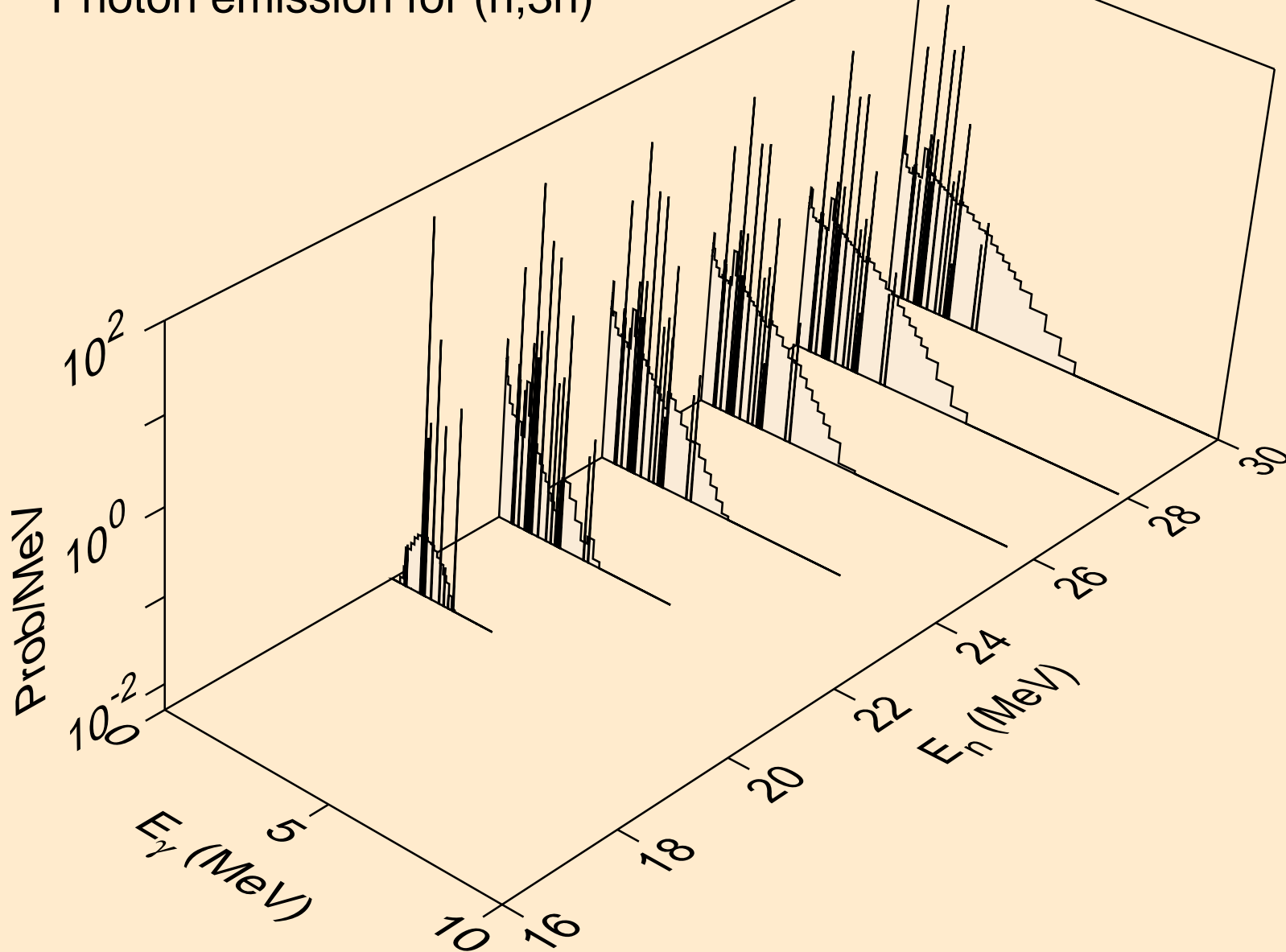

MAT=3649 ACE FILE PRODUCED AT NEA WITH NDEC  
Photon emission for (n,n\*)a

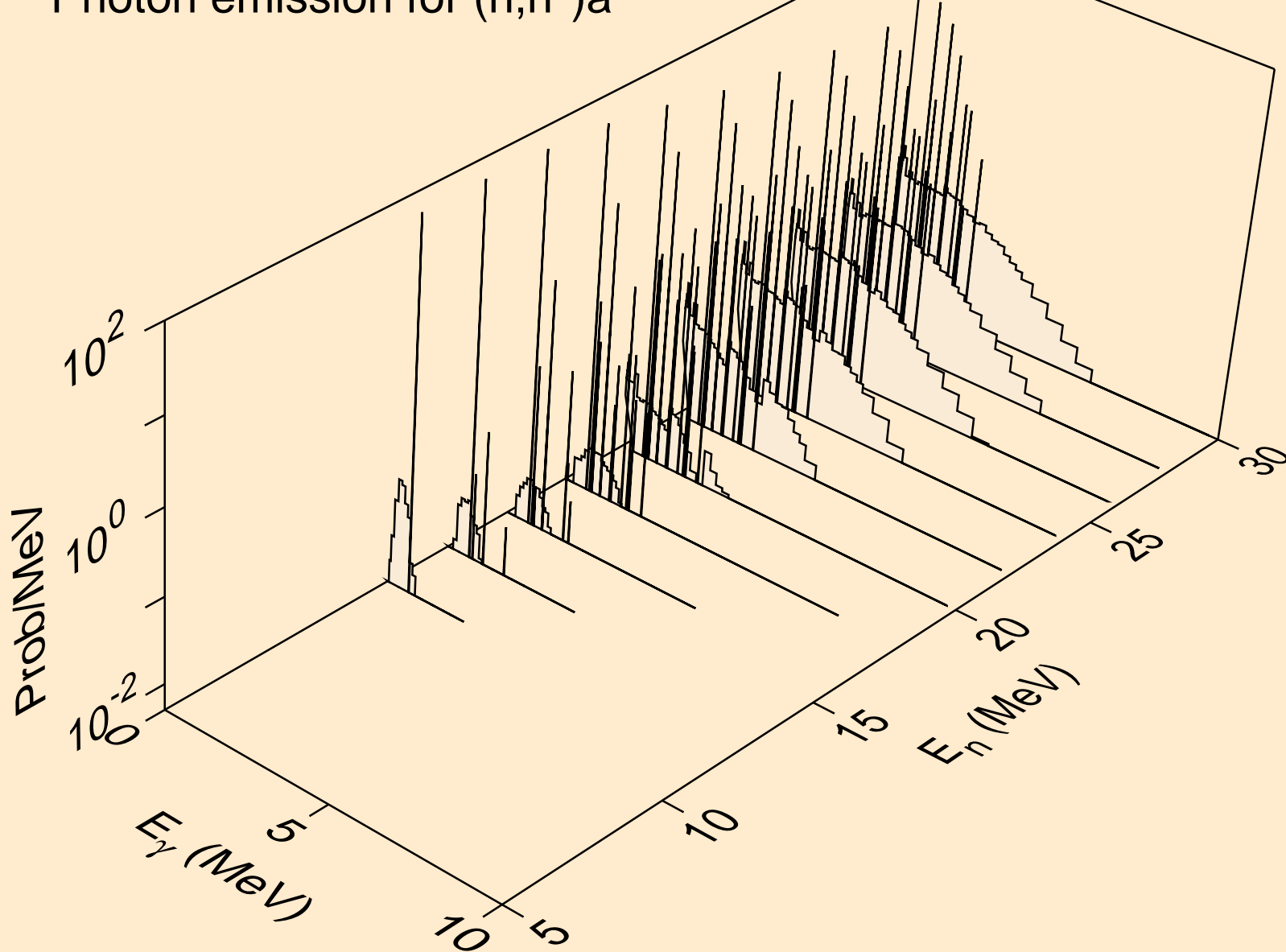

MAT=3649 ACE FILE PRODUCED AT NEA WITH NDEC  
Photon emission for (n,2n)a

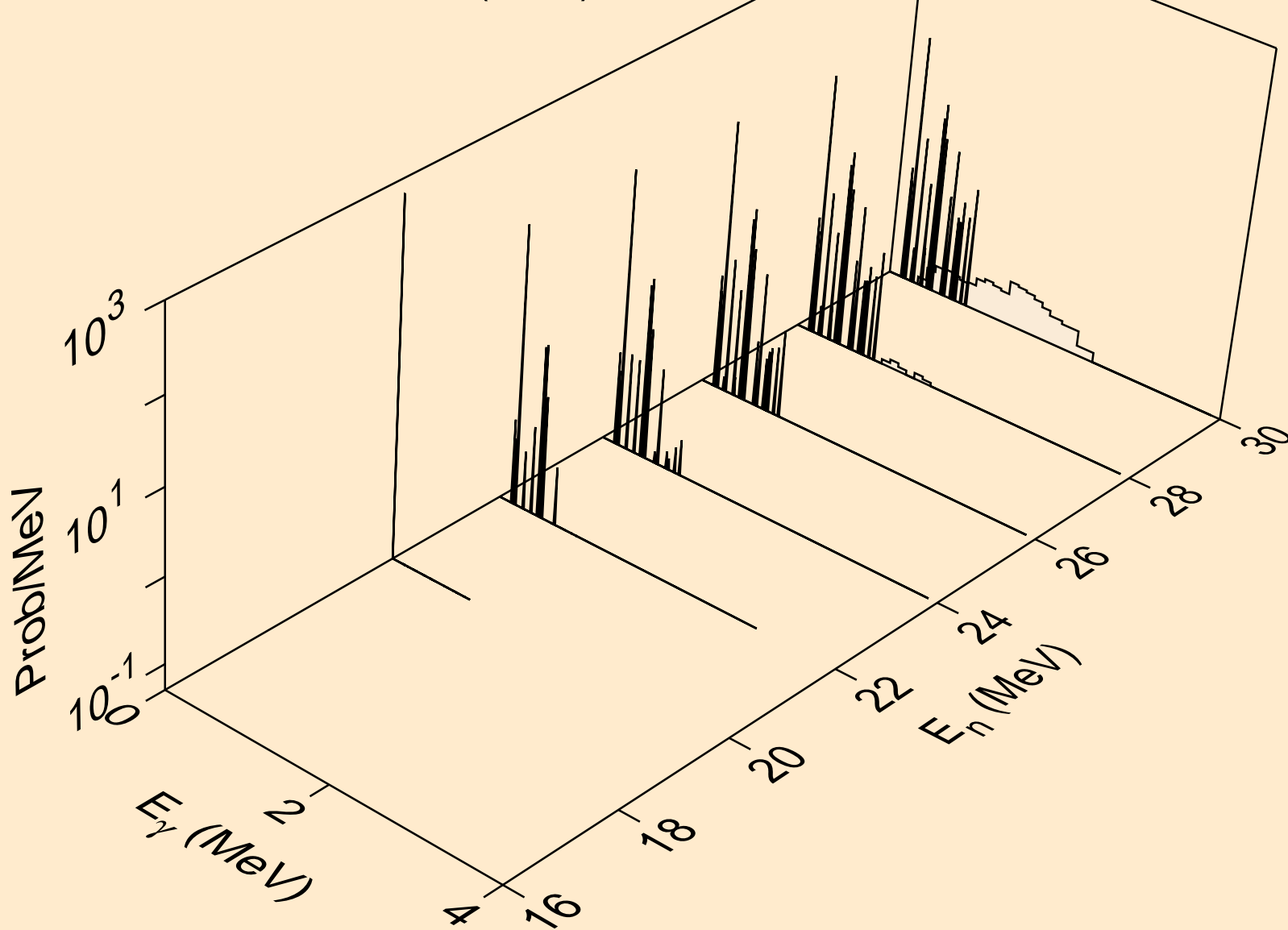

MAT=3649 ACE FILE PRODUCED AT NEA WITH NDEC  
Photon emission for (n,3n)a

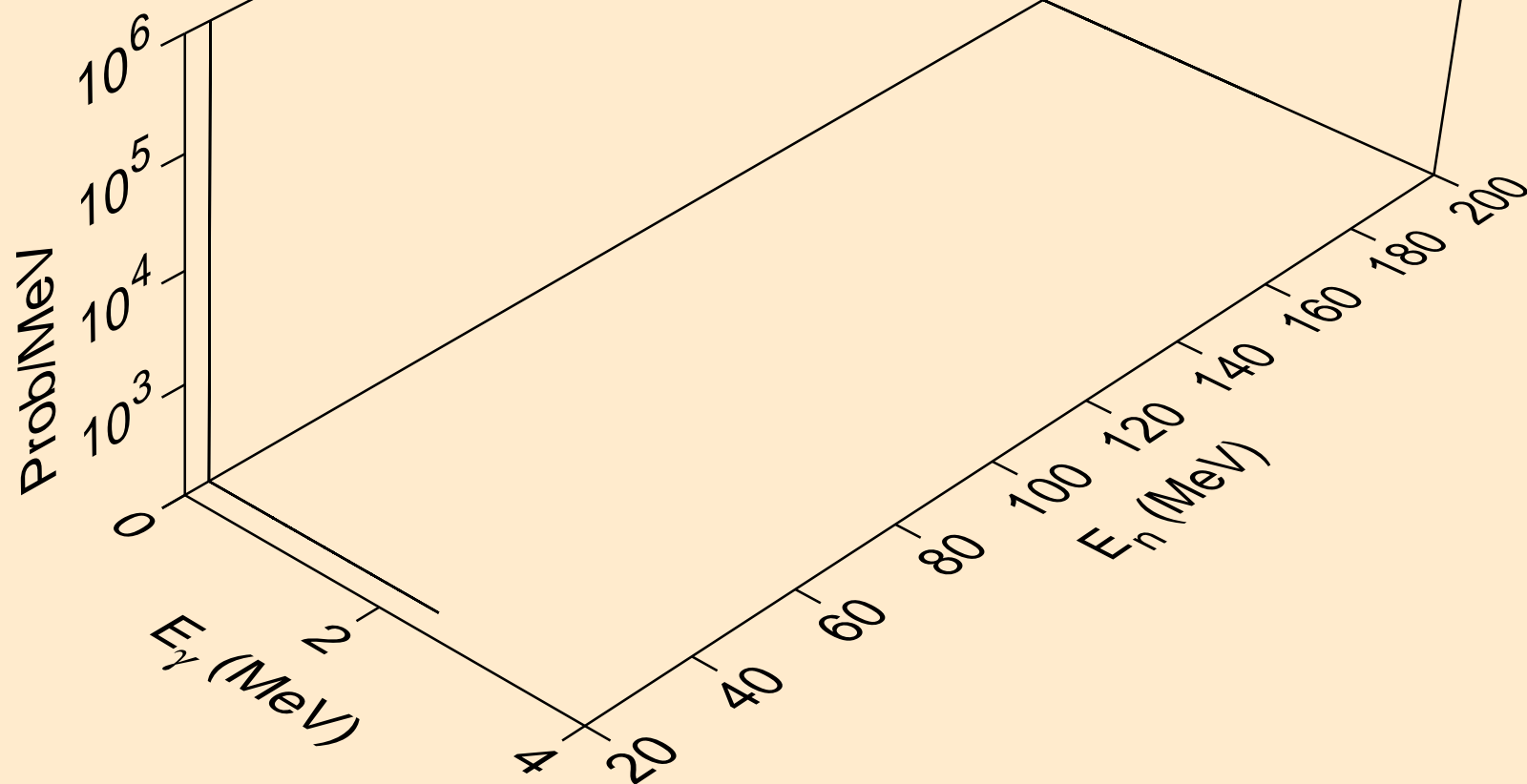

MAT=3649 ACE FILE PRODUCED AT NEA WITH NDEC  
Photon emission for (n,n\*)p

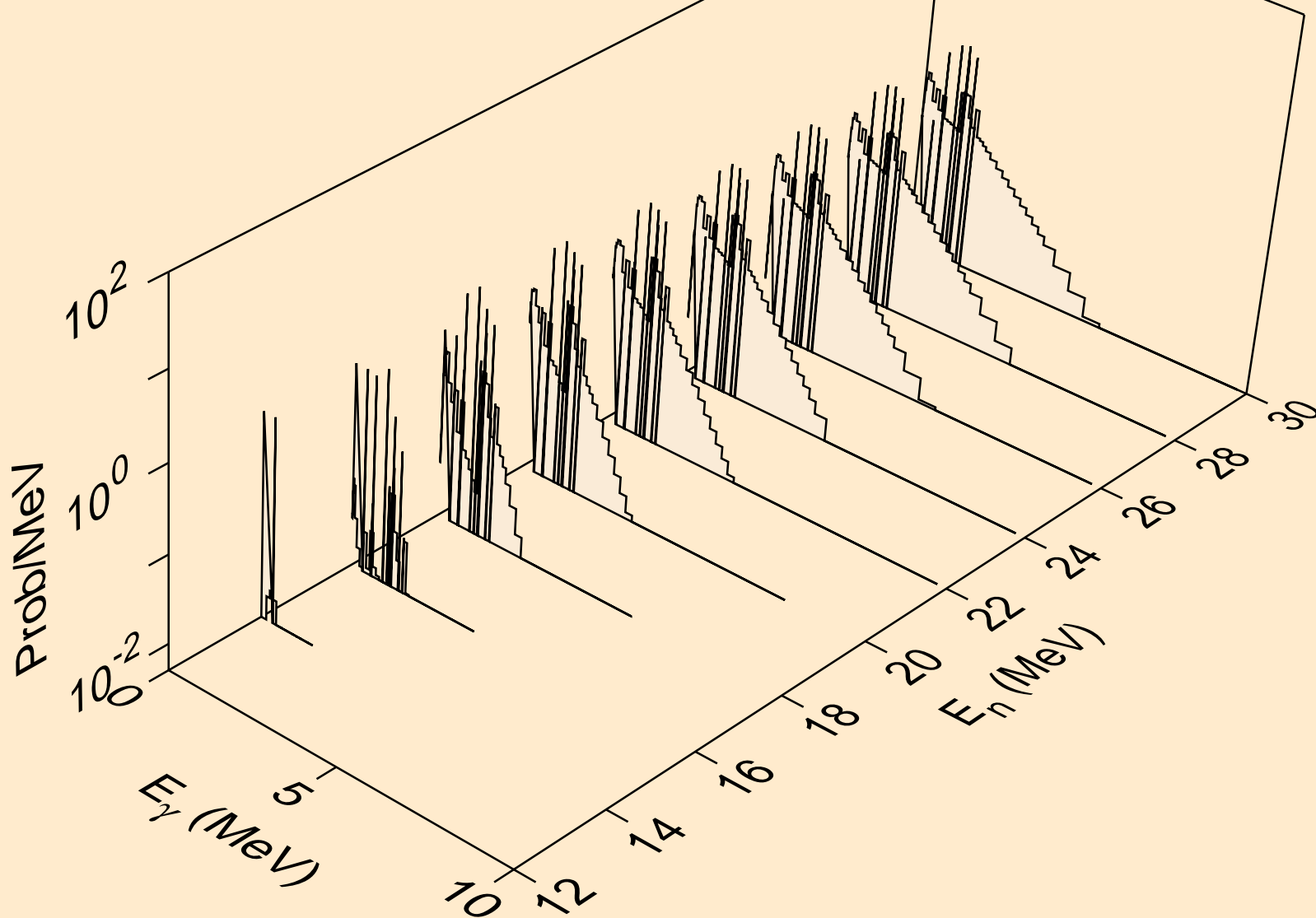

MAT=3649 ACE FILE PRODUCED AT NEA WITH NDEC  
Photon emission for (n,n\*)d

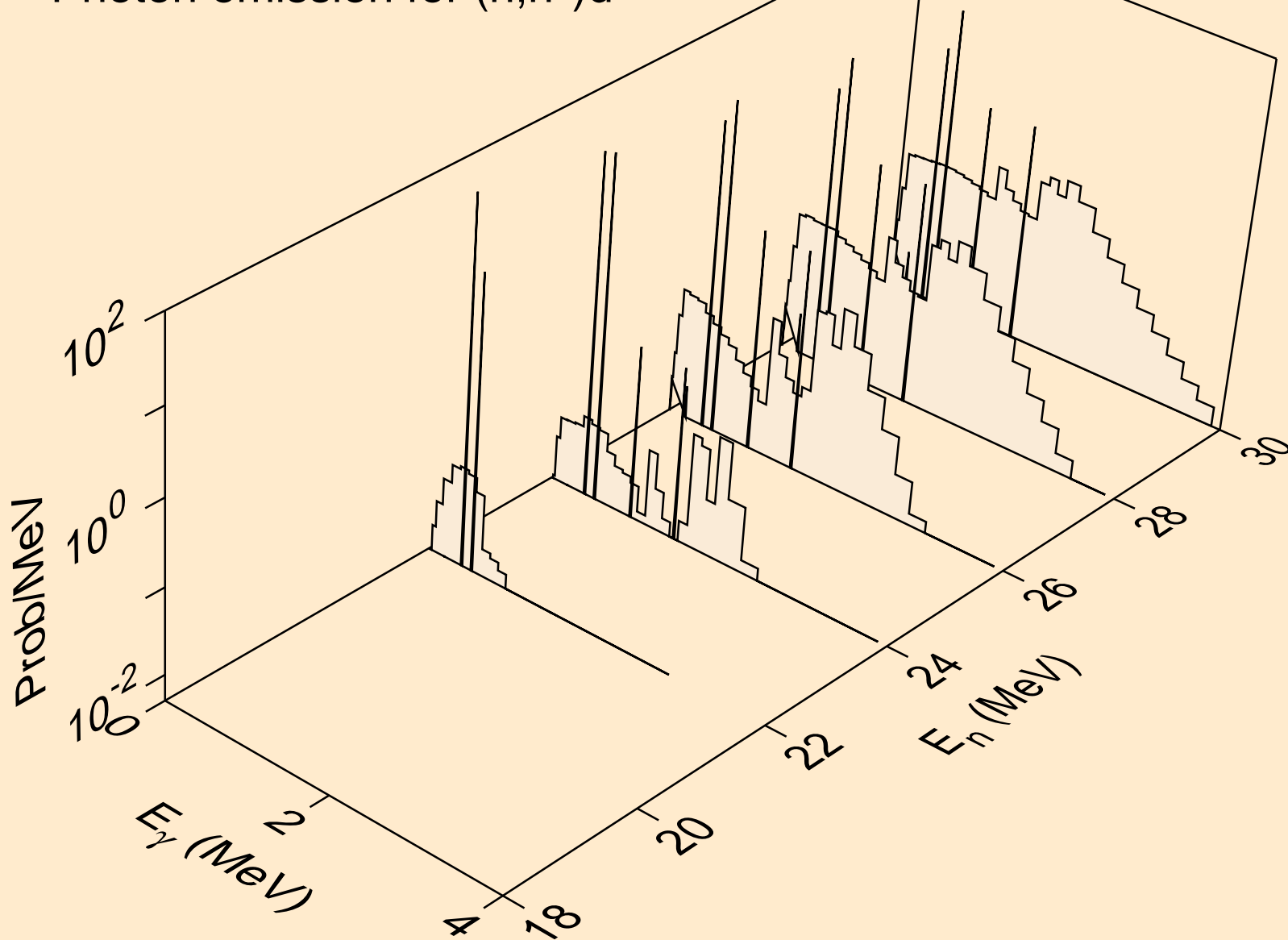

MAT=3649 ACE FILE PRODUCED AT NEA WITH NDEC  
Photon emission for (n,n\*)t

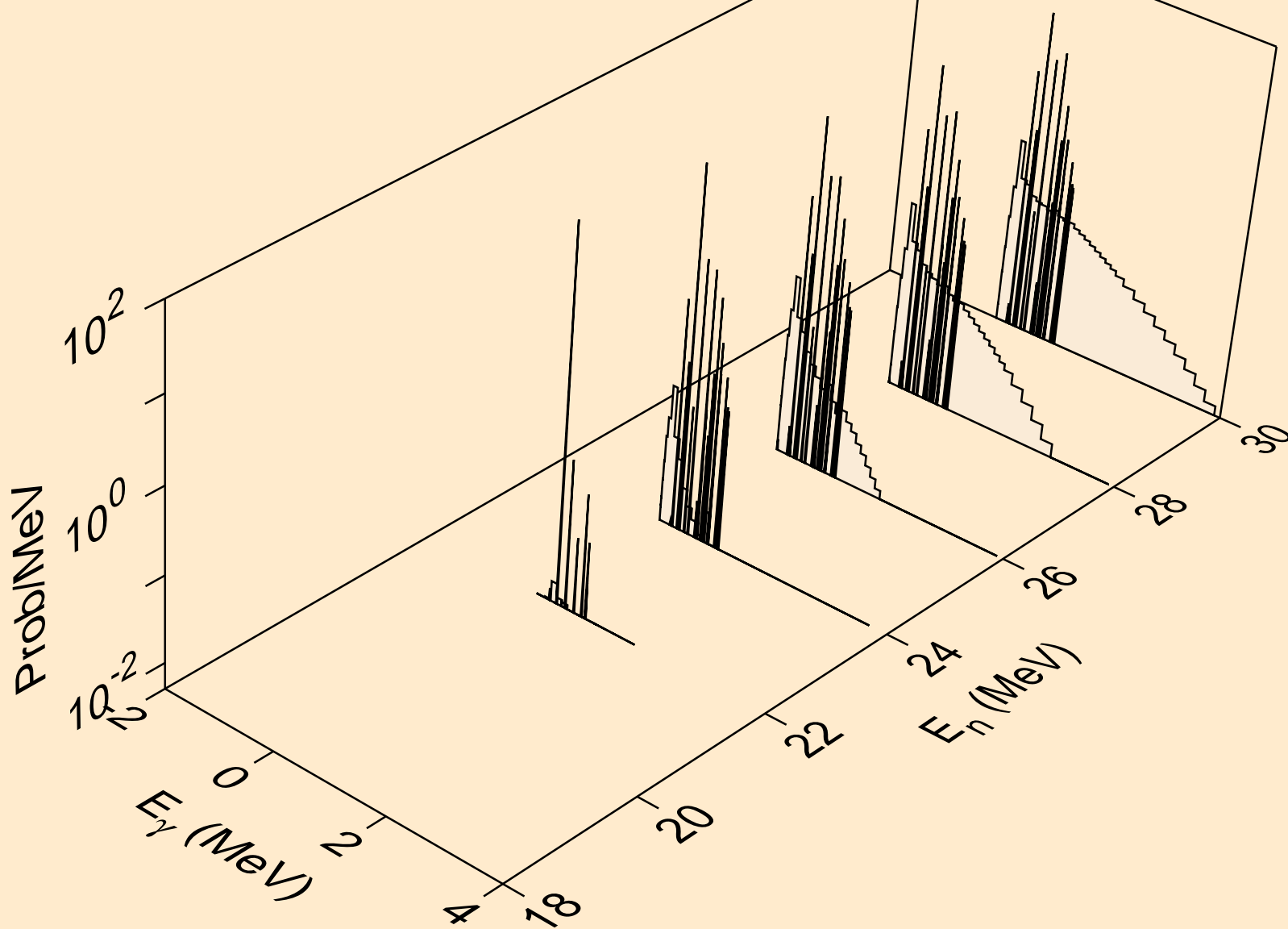

MAT=3649 ACE FILE PRODUCED AT NEA WITH NDEC  
Photon emission for (n,n\*)he3

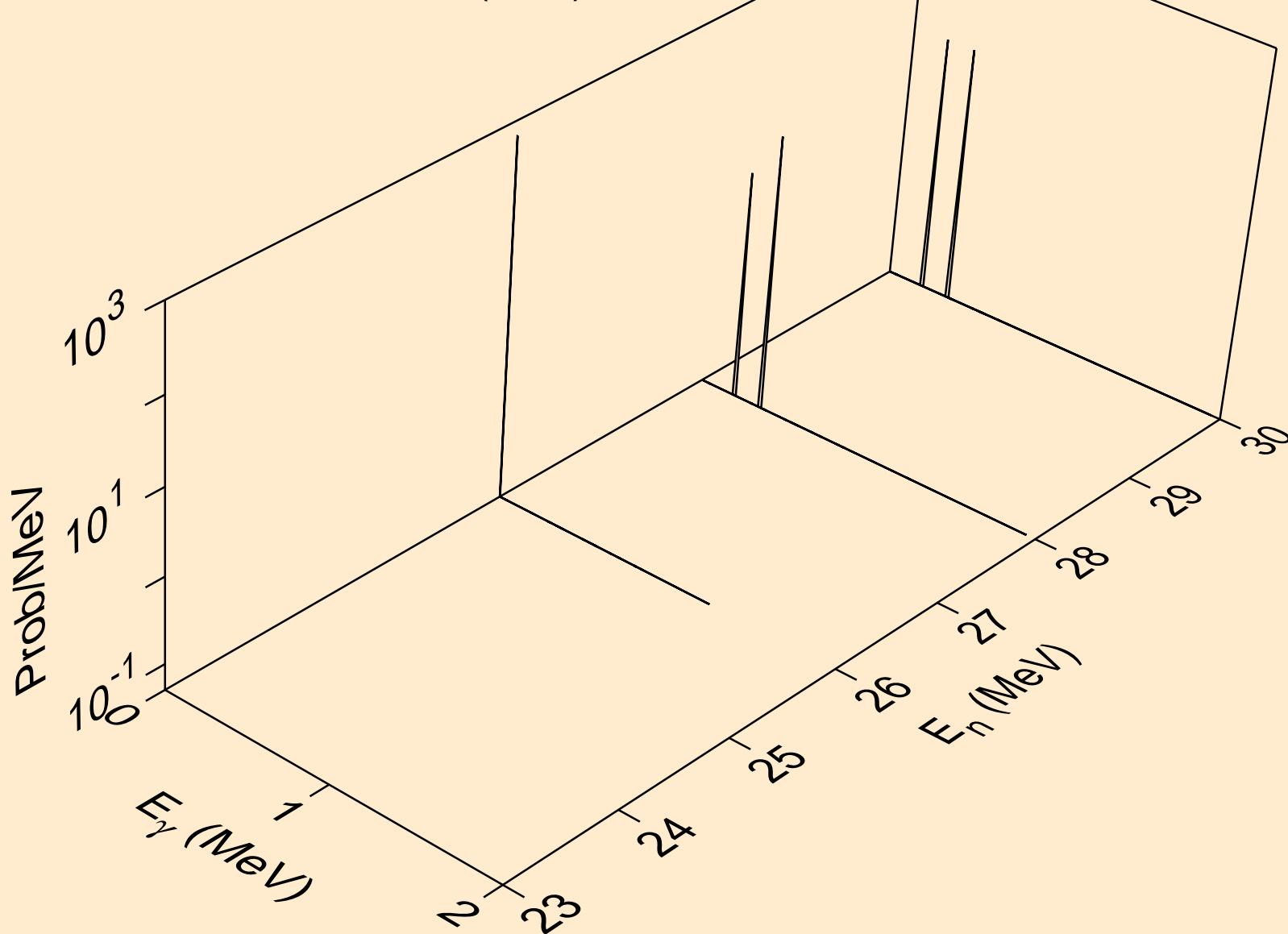

MAT=3649 ACE FILE PRODUCED AT NEA WITH NDEC  
Photon emission for (n,4n)

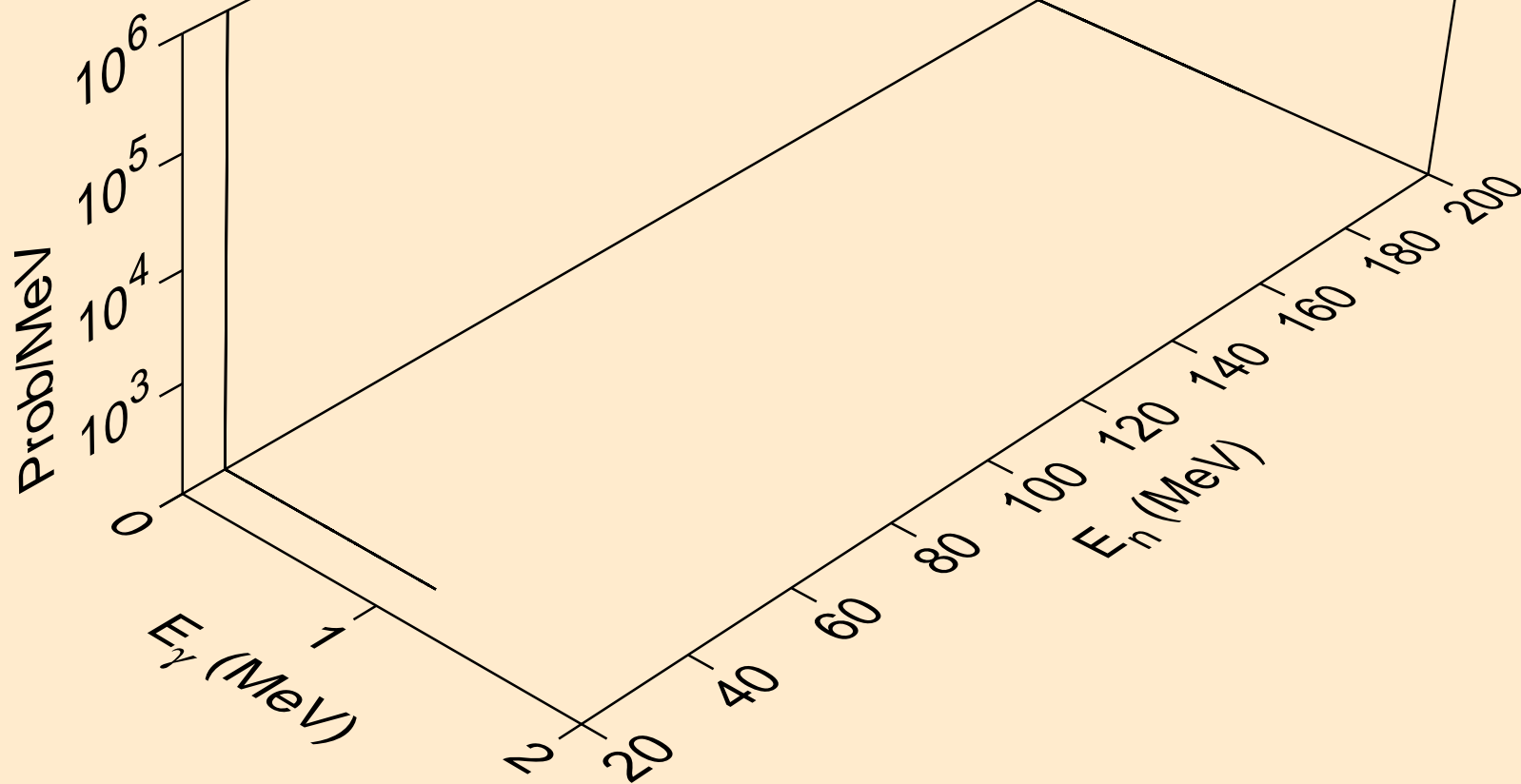

MAT=3649 ACE FILE PRODUCED AT NEA WITH NDEC  
Photon emission for (n,2np)

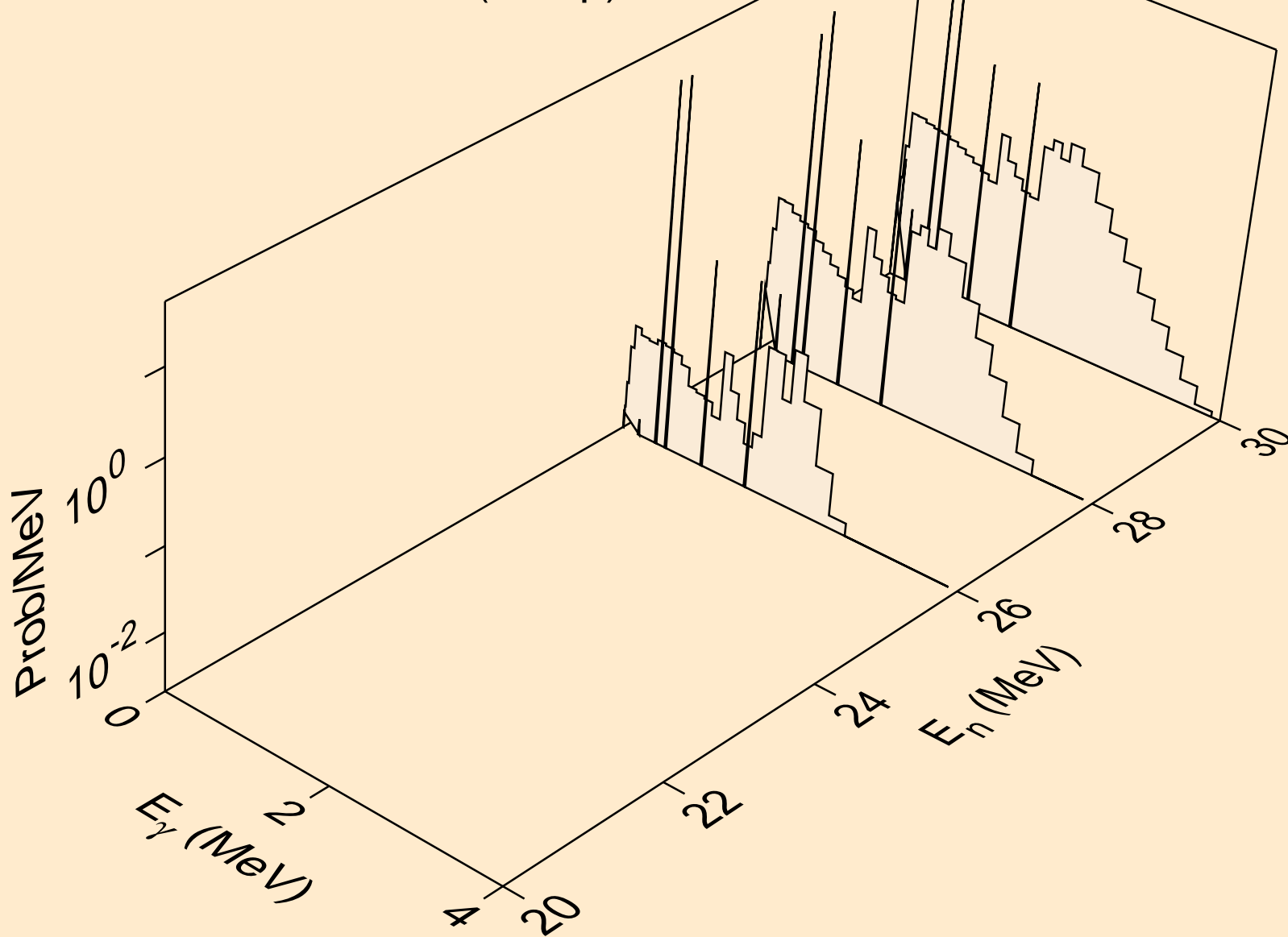

MAT=3649 ACE FILE PRODUCED AT NEA WITH NDEC  
Photon emission for (n,3np)

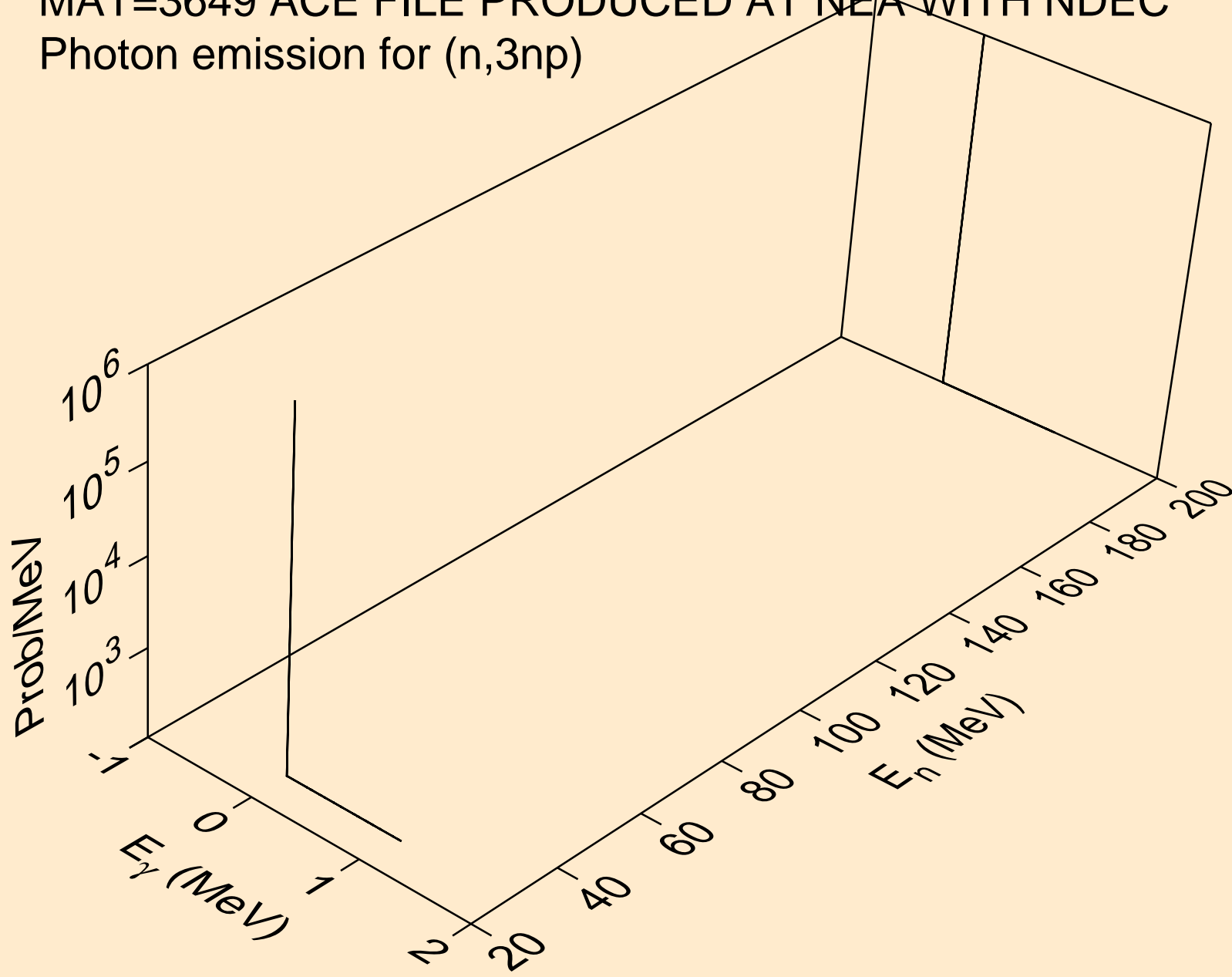

MAT=3649 ACE FILE PRODUCED AT NEA WITH NDEC  
Photon emission for (n,2np)

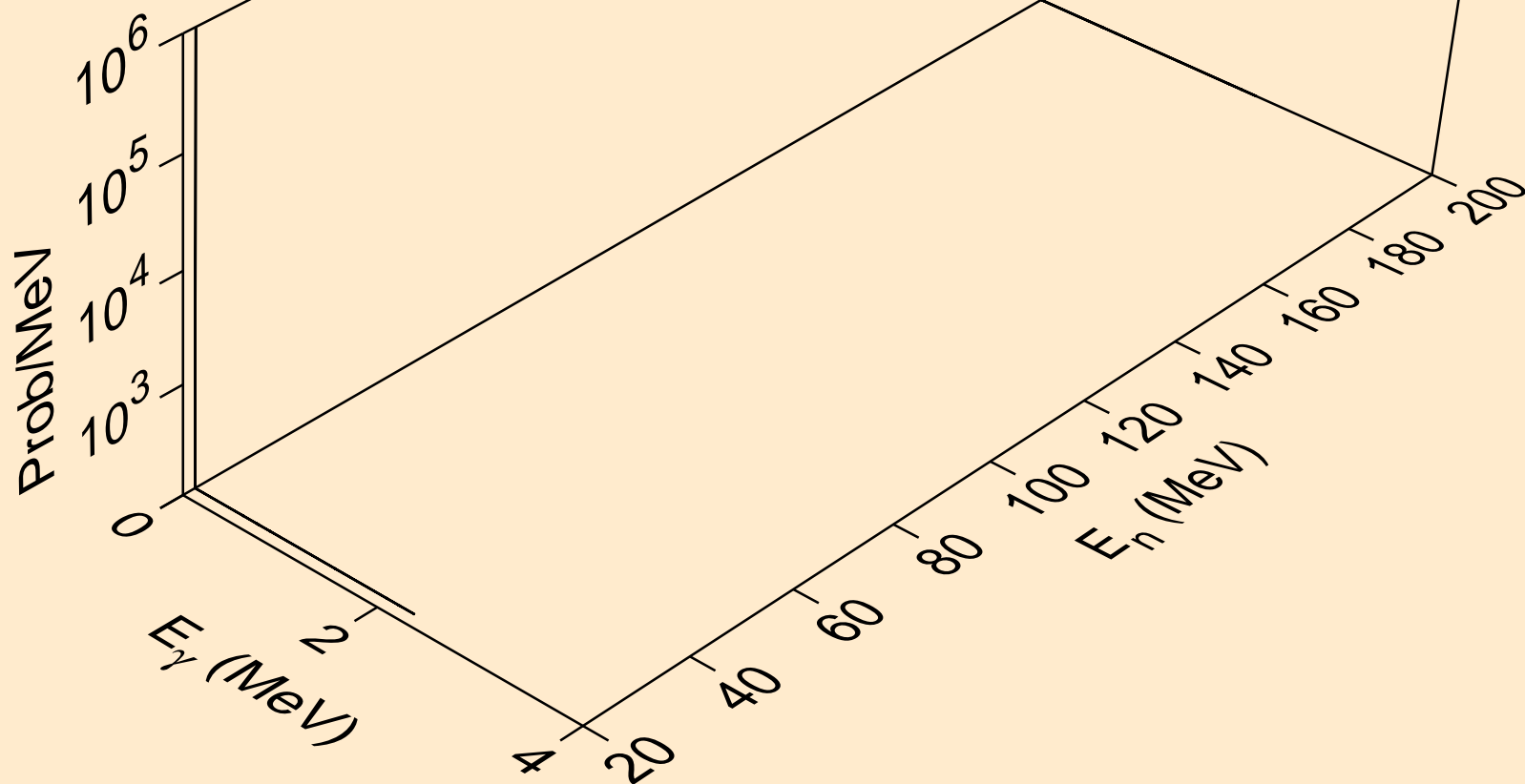

MAT=3649 ACE FILE PRODUCED AT NEA WITH NDEC  
Photon emission for (n,n\*c)

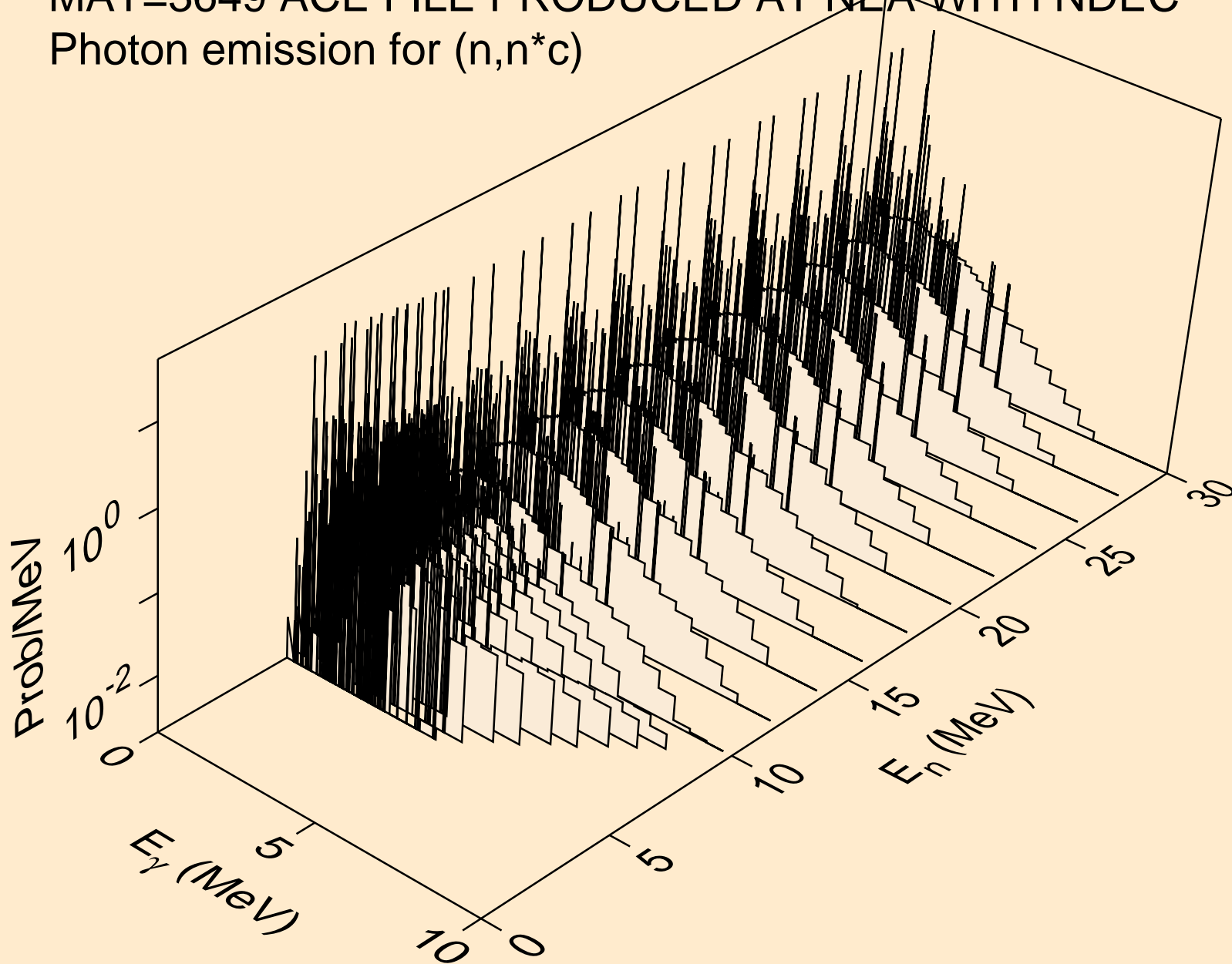

MAT=3649 ACE FILE PRODUCED AT NEA WITH NDEC  
Photon emission for (n,gma)

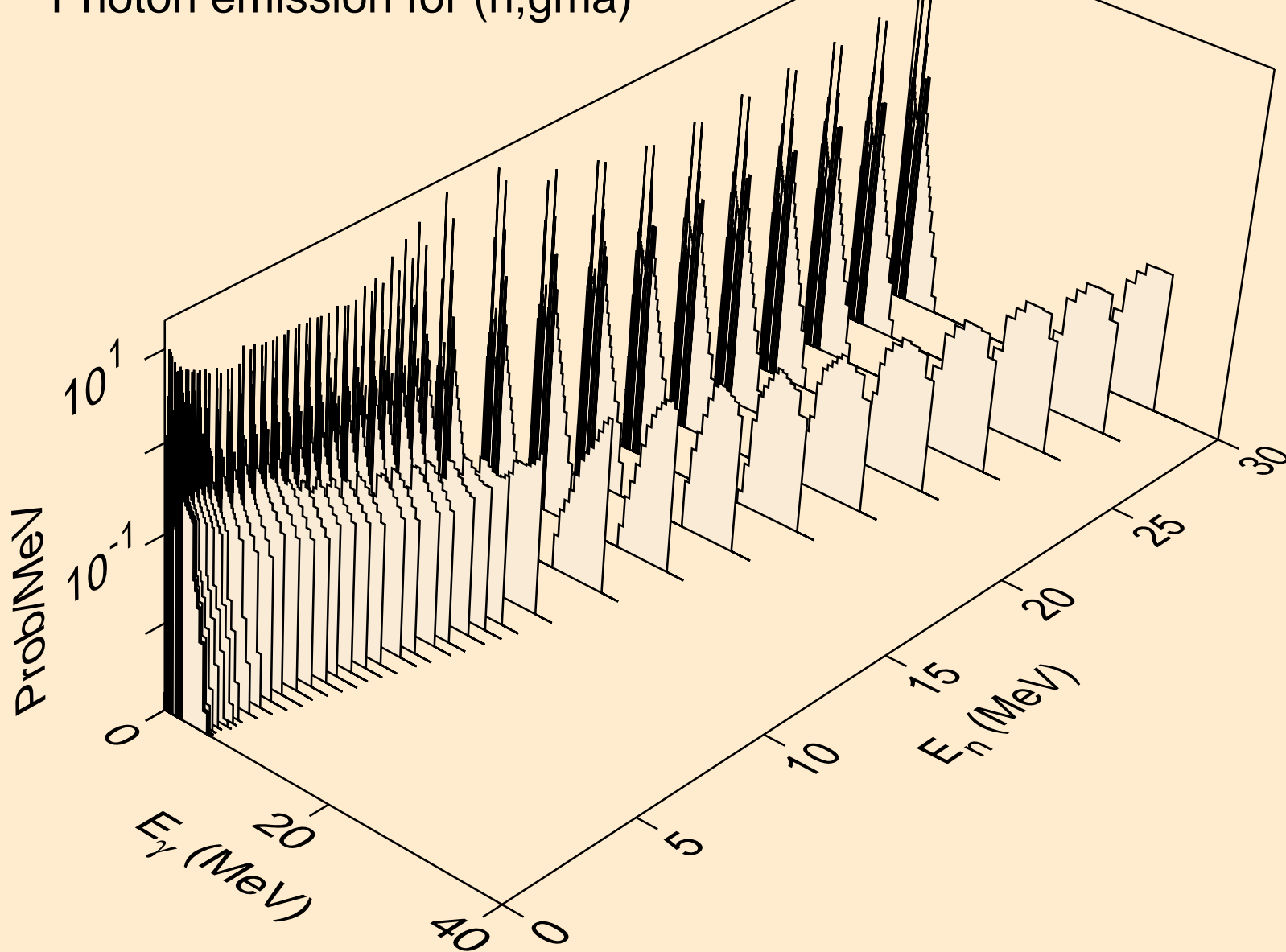

MAT=3649 ACE FILE PRODUCED AT NEA WITH NDEC  
Photon emission for (n,p)

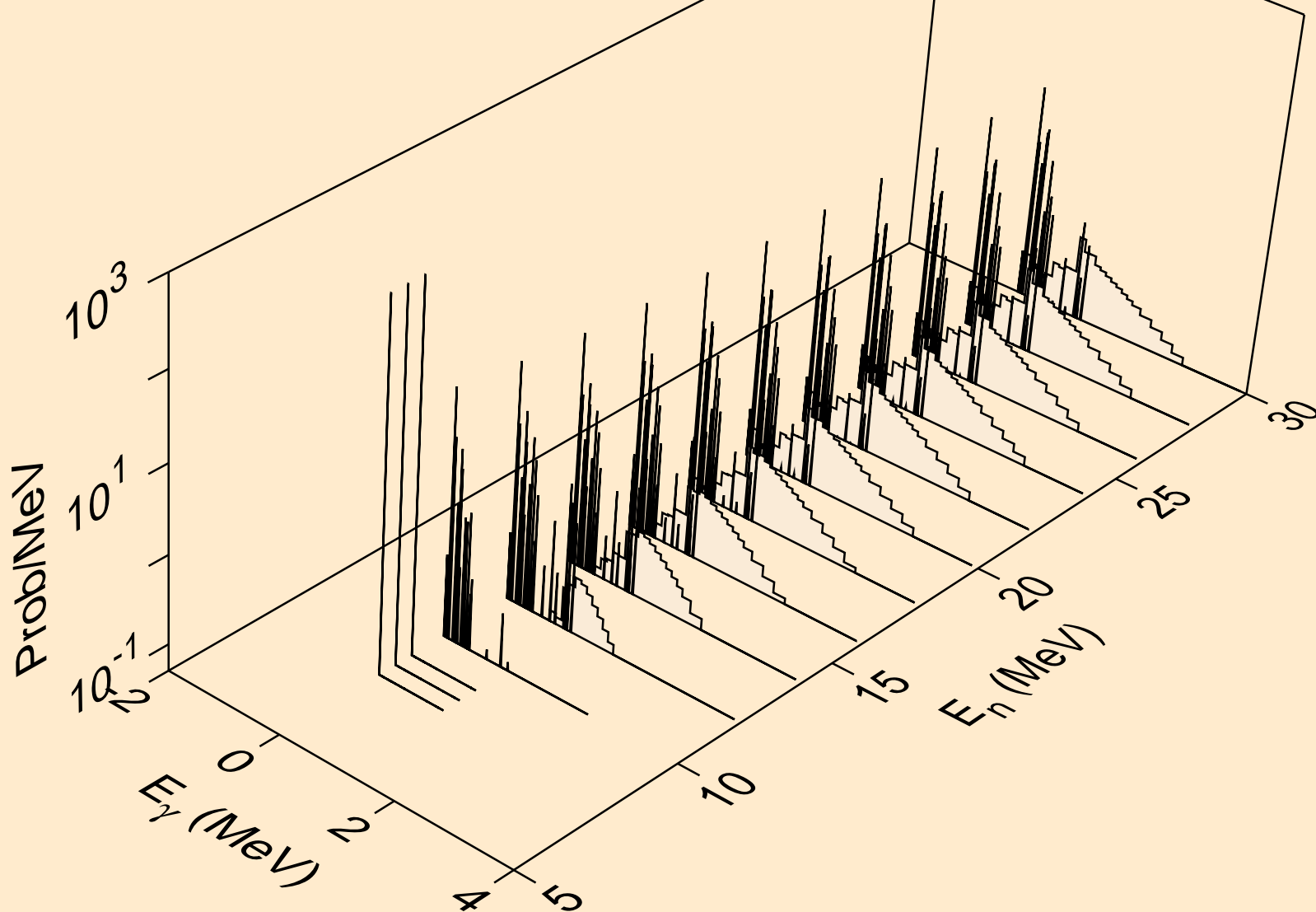

MAT=3649 ACE FILE PRODUCED AT NEA WITH NDEC  
Photon emission for (n,d)

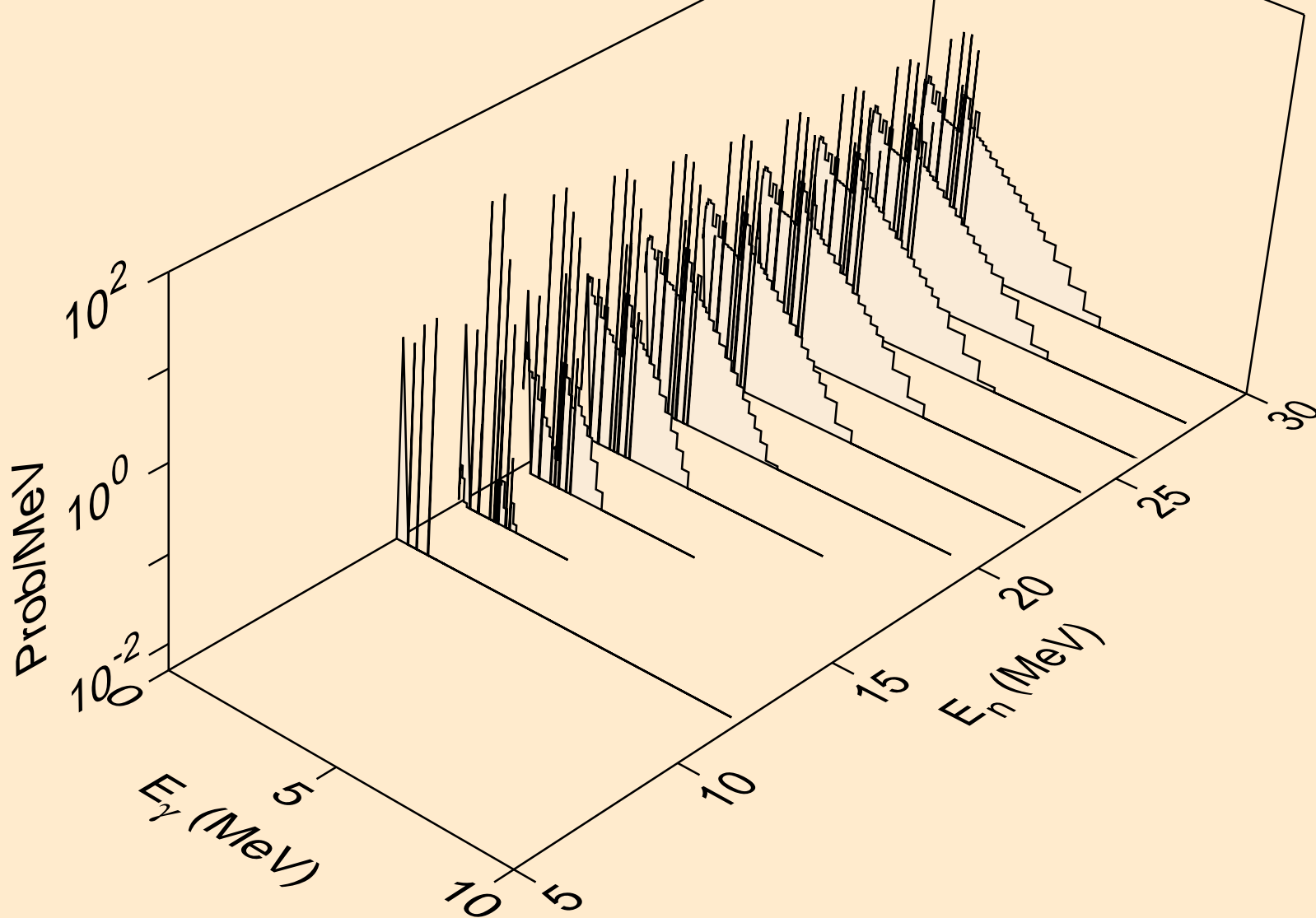

MAT=3649 ACE FILE PRODUCED AT NEA WITH NDEC  
Photon emission for (n,t)

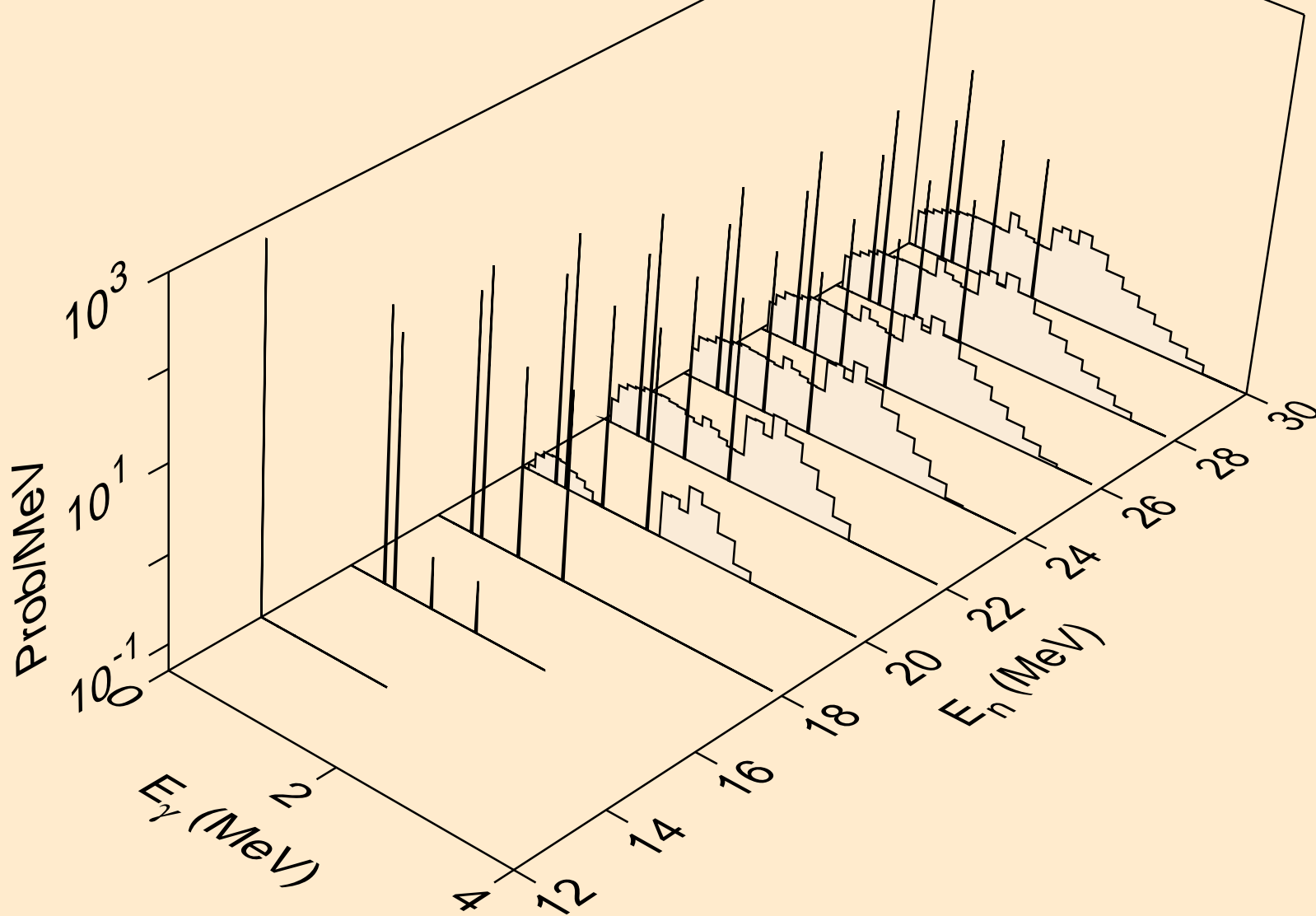

MAT=3649 ACE FILE PRODUCED AT NEA WITH NDEC  
Photon emission for (n,he3)

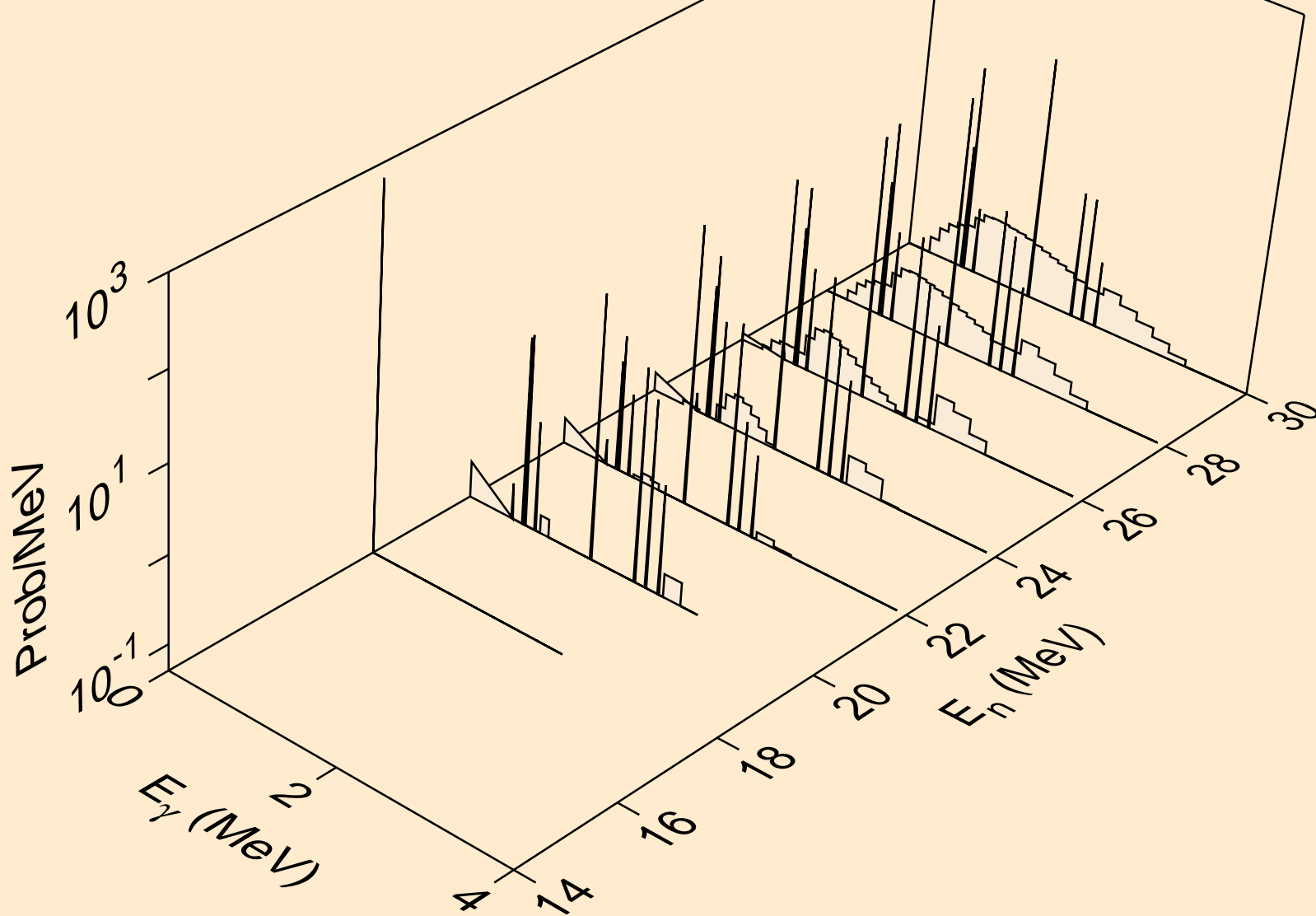

MAT=3649 ACE FILE PRODUCED AT NEA WITH NDEC  
Photon emission for (n,a)

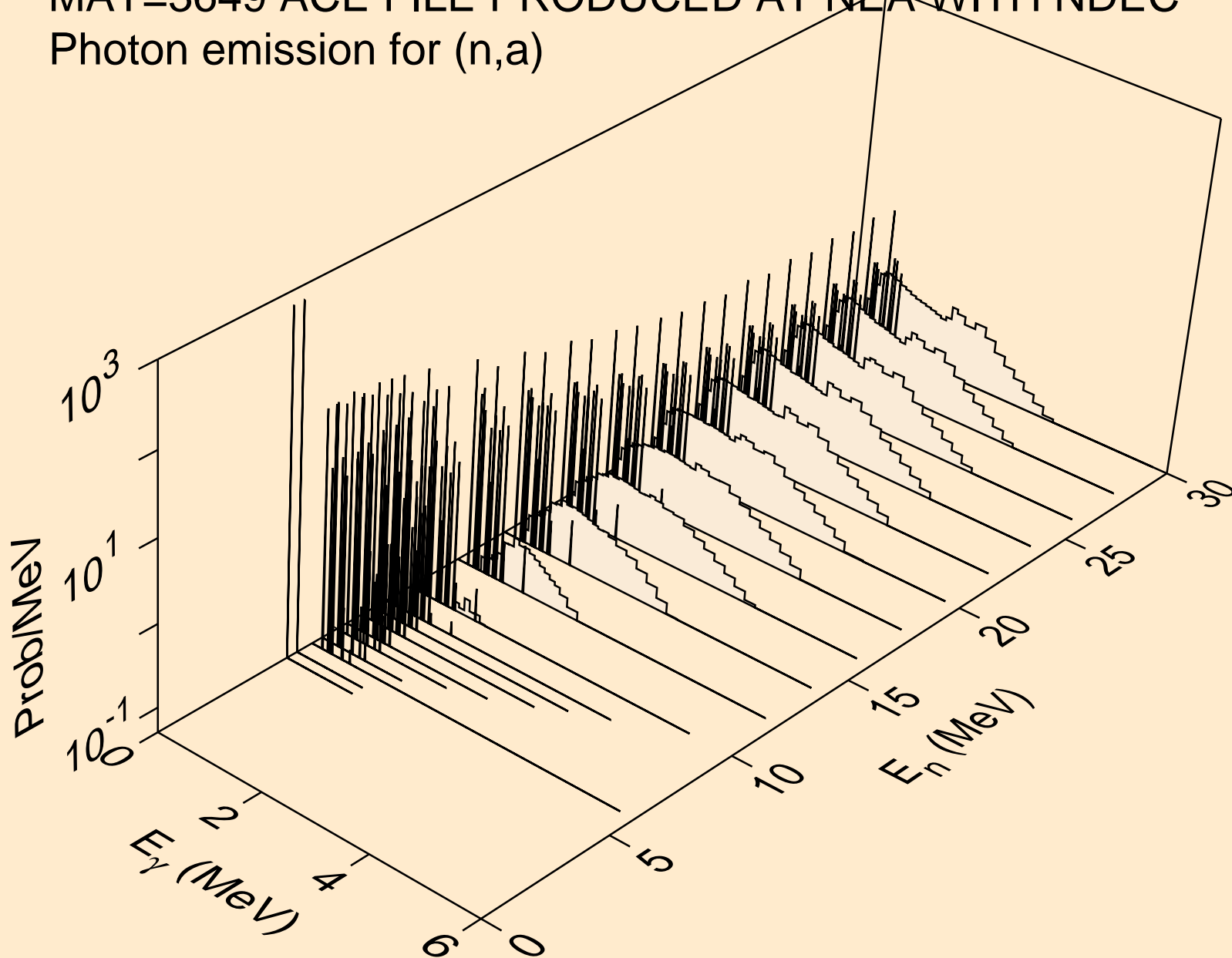

MAT=3649 ACE FILE PRODUCED AT NEA WITH NDEC  
Photon emission for (n,2a)

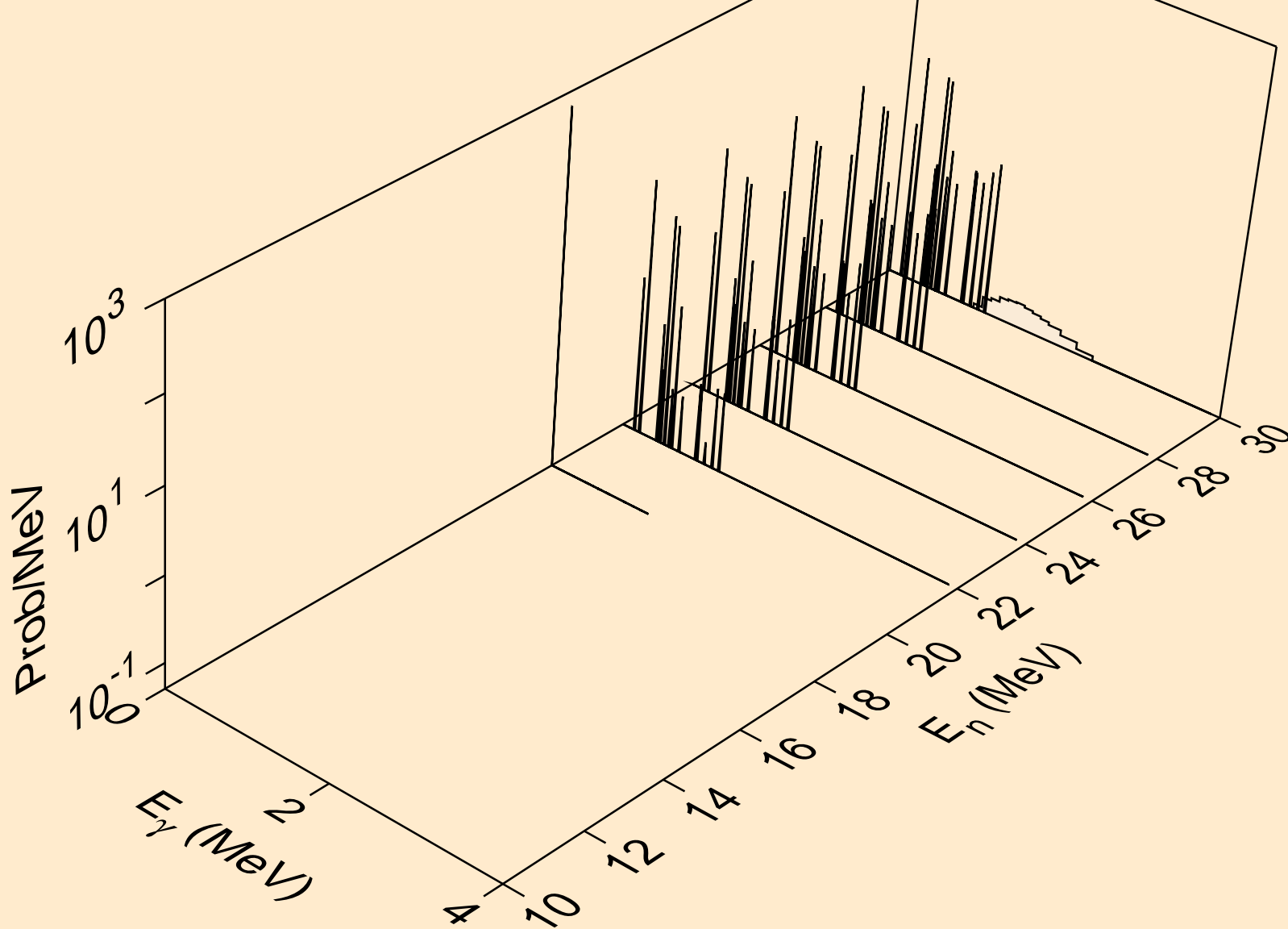

MAT=3649 ACE FILE PRODUCED AT NEA WITH NDEC  
Photon emission for (n,2p)

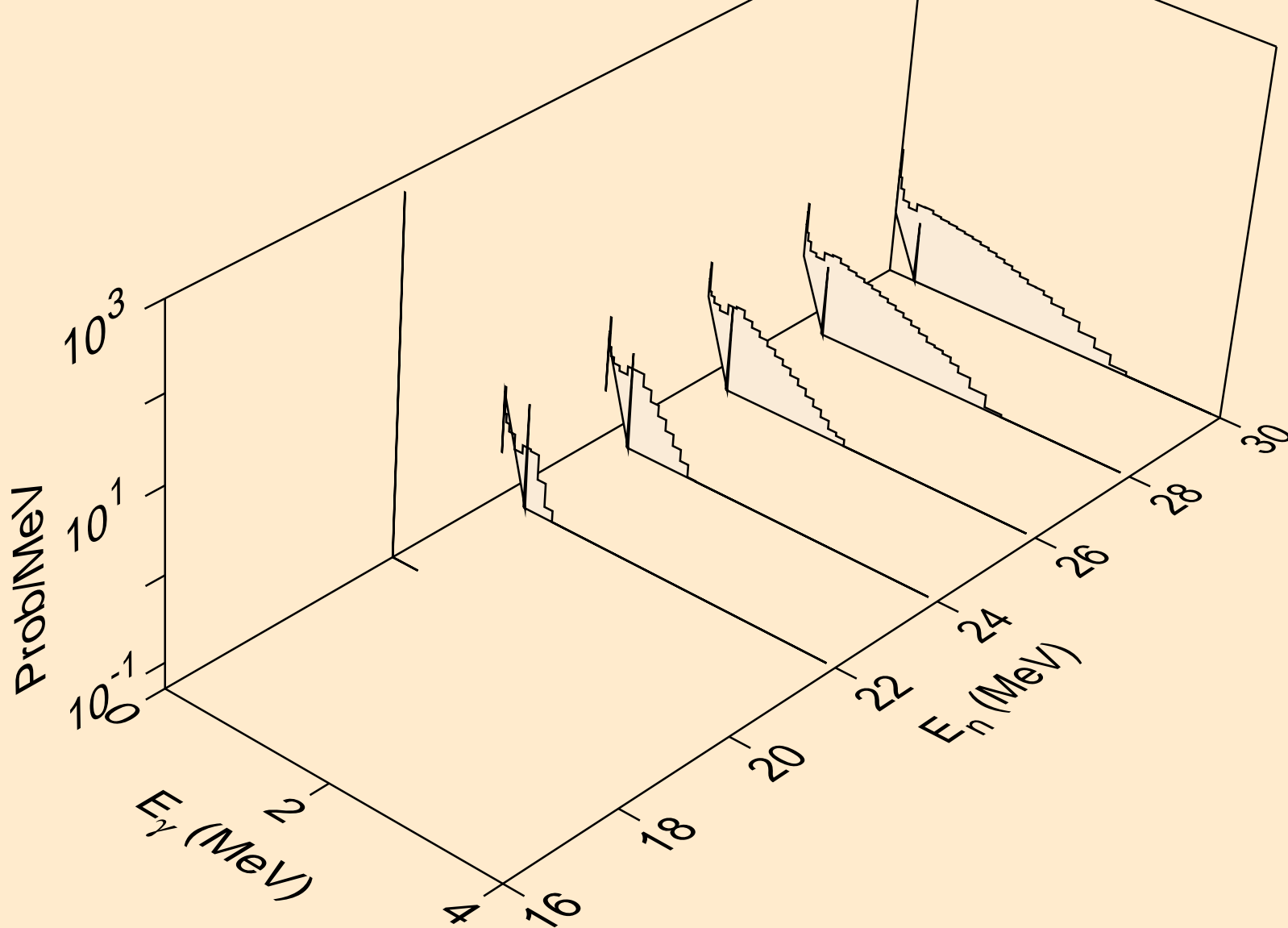

MAT=3649 ACE FILE PRODUCED AT NEA WITH NDEC  
Photon emission for (n,pa)

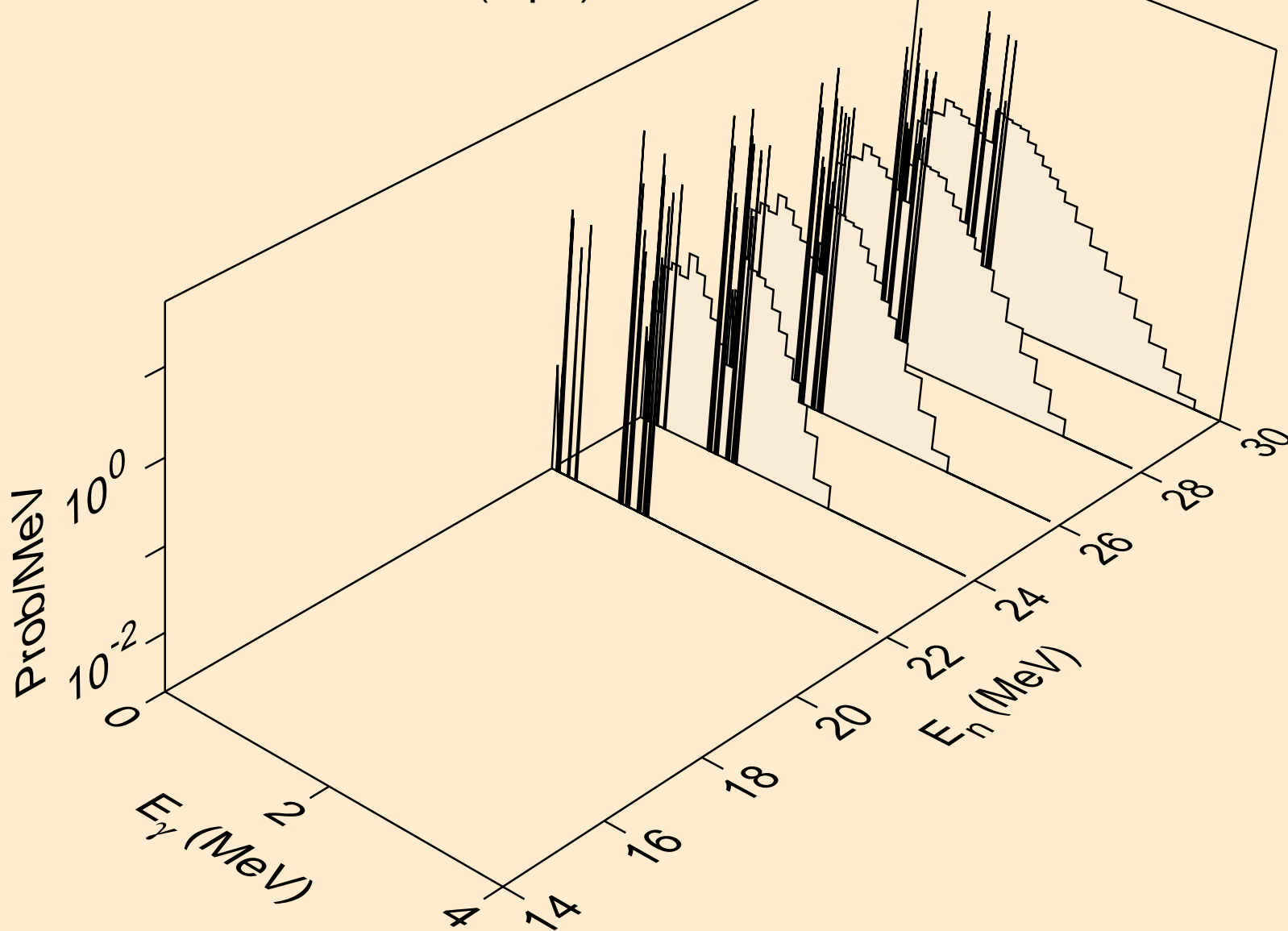

MAT=3649 ACE FILE PRODUCED AT NEA WITH NDEC  
Photon emission for (n,pd)

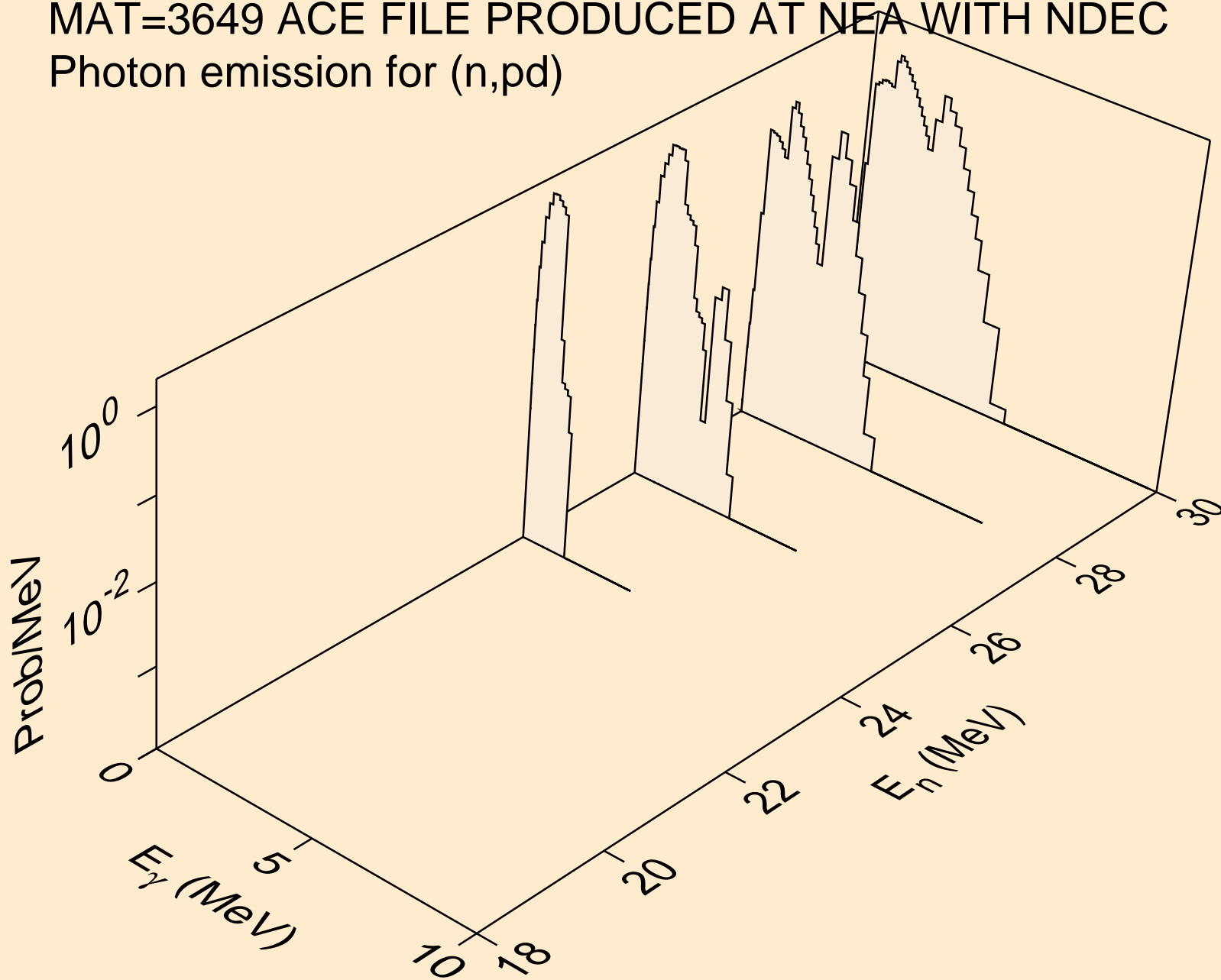

MAT=3649 ACE FILE PRODUCED AT NEA WITH NDEC  
thermal capture photon spectrum

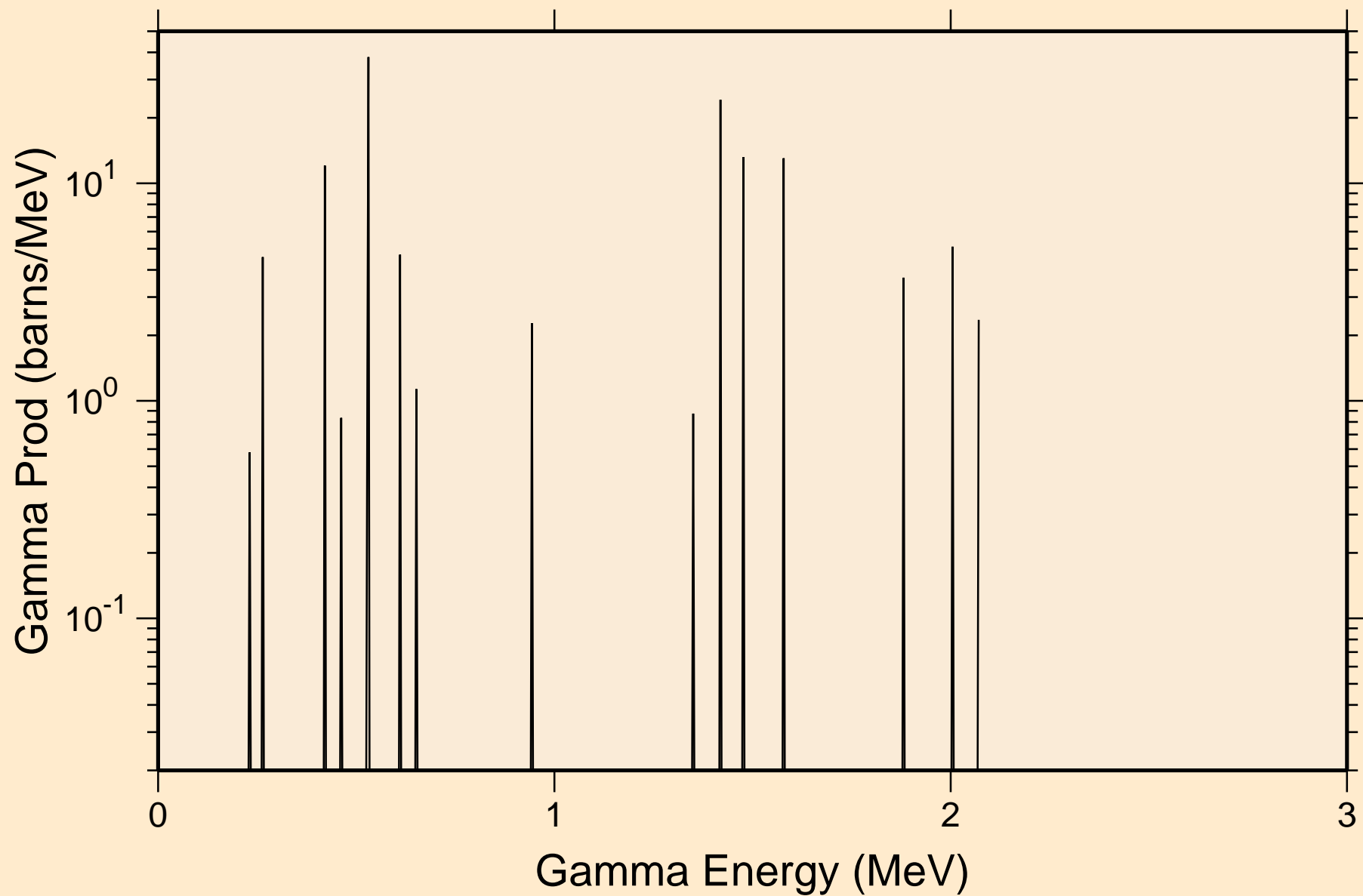

MAT=3649 ACE FILE PRODUCED AT NEA WITH NDEC  
14 MeV photon spectrum

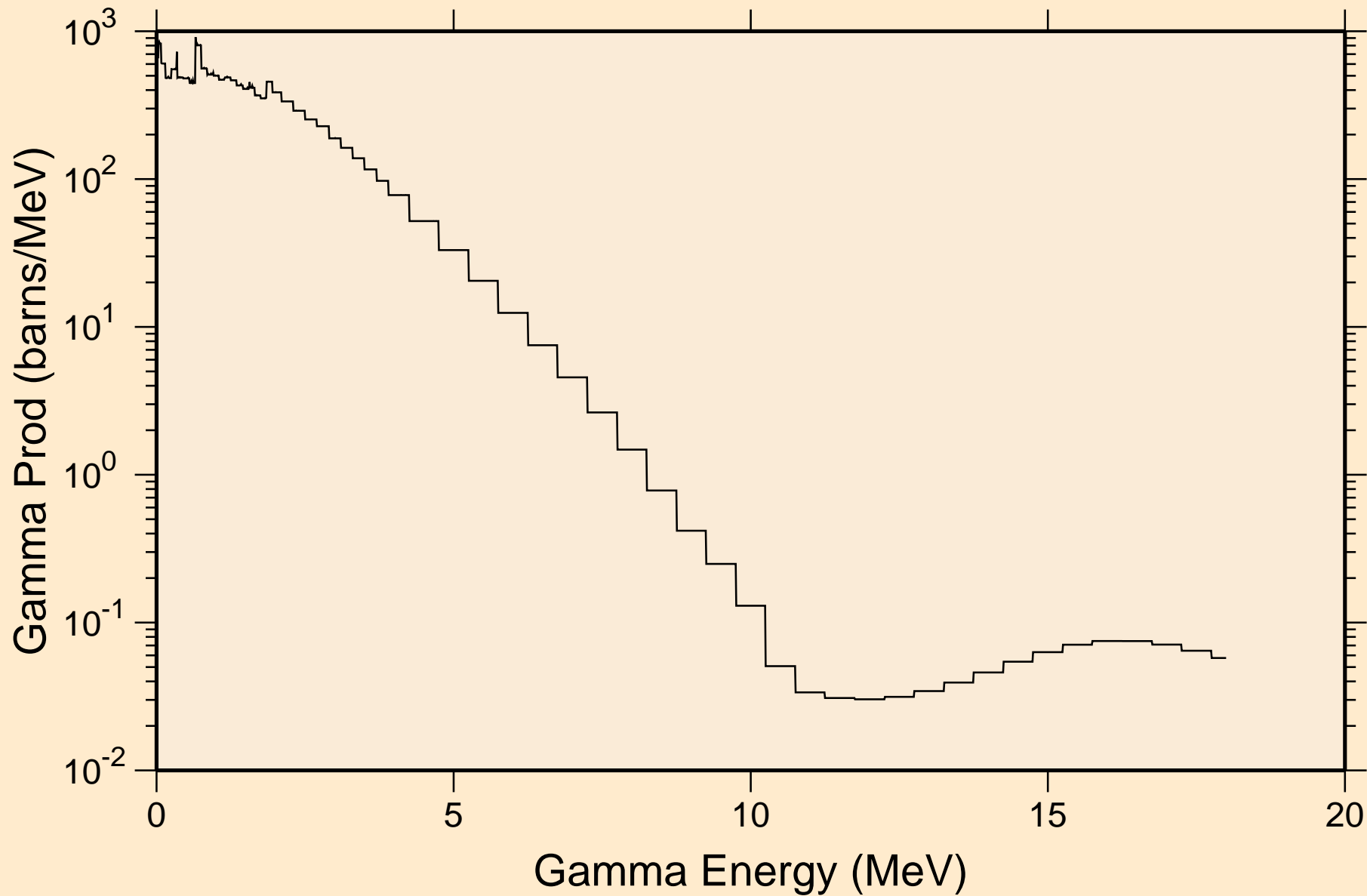

MAT=3649 ACE FILE PRODUCED AT NEA WITH NDEC  
Particle heating contributions

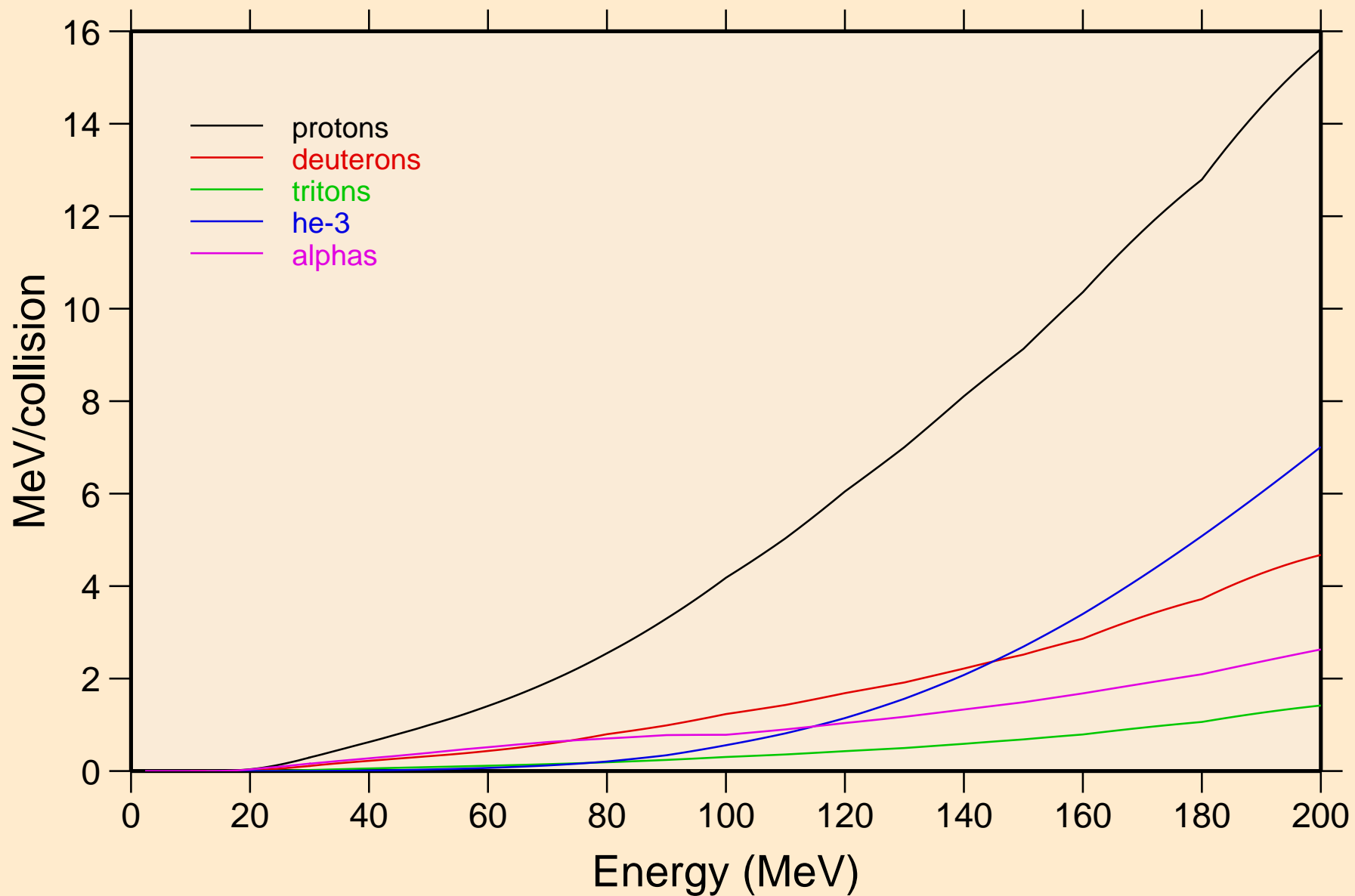

MAT=3649 ACE FILE PRODUCED AT NEA WITH NDEC  
Recoil Heating

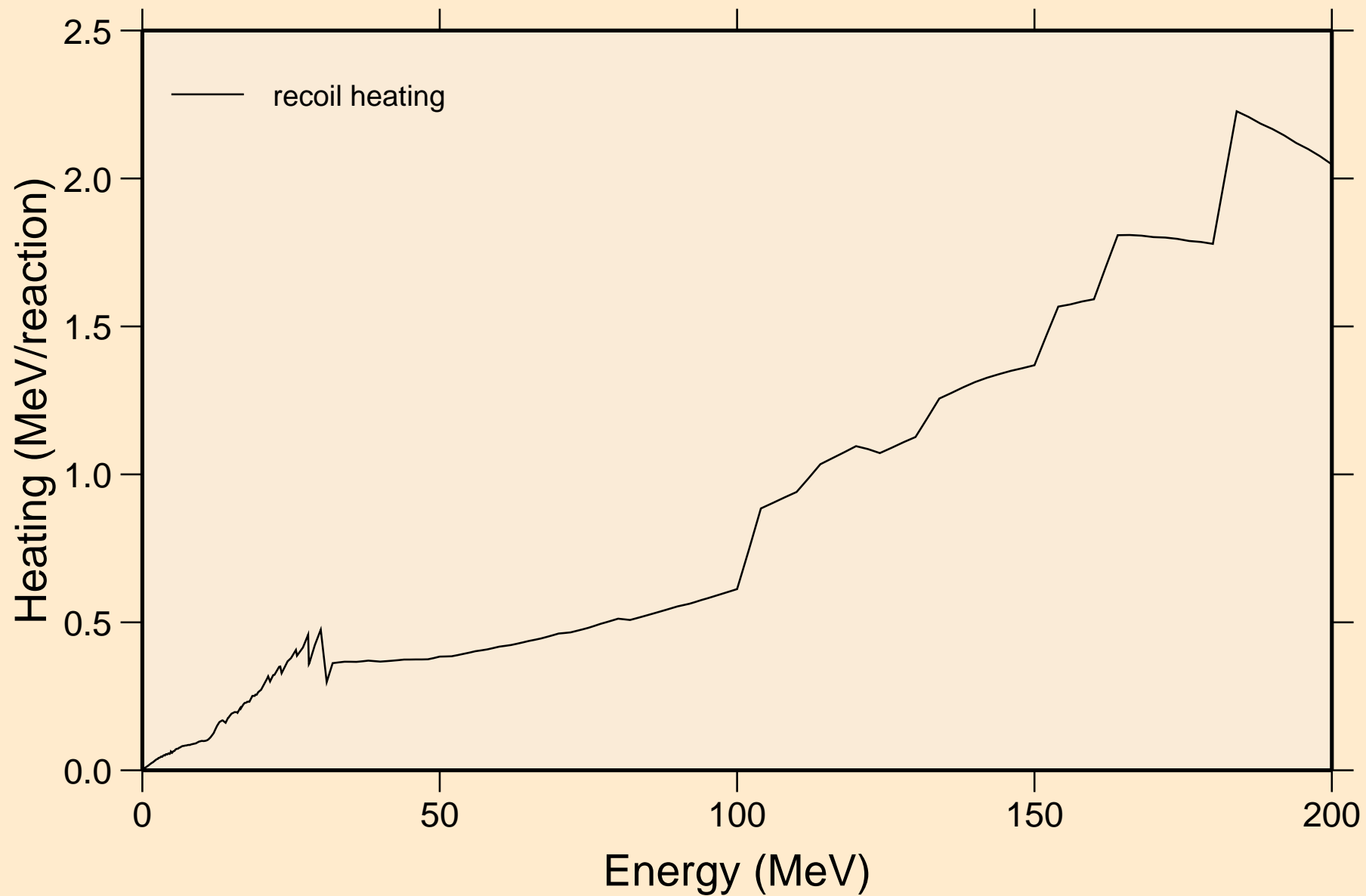

MAT=3649 ACE FILE PRODUCED AT NEA WITH NDEC  
Particle production cross sections

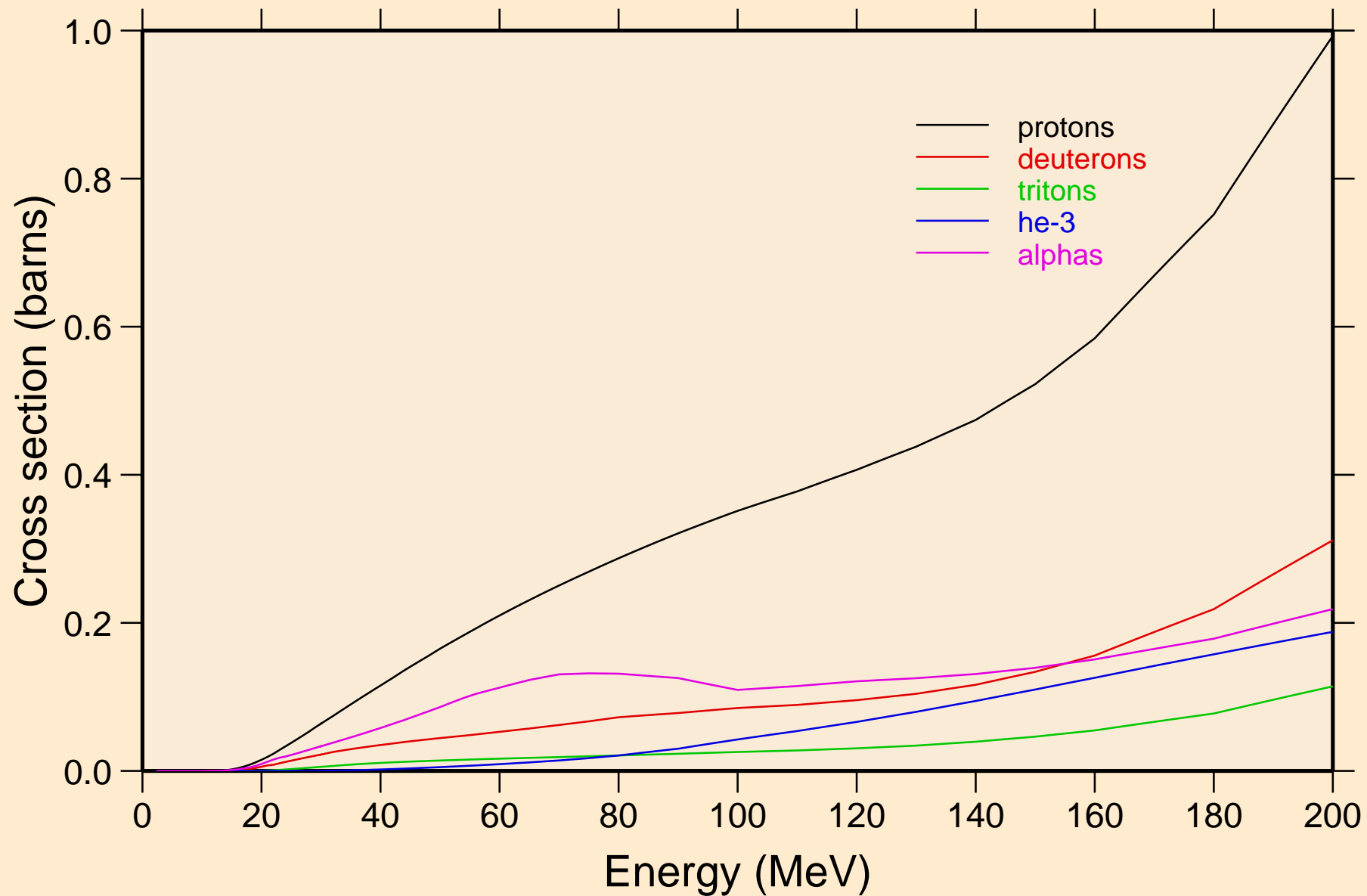

MAT=3649 ACE FILE PRODUCED AT NEA WITH NDEC  
protons from (n,x)

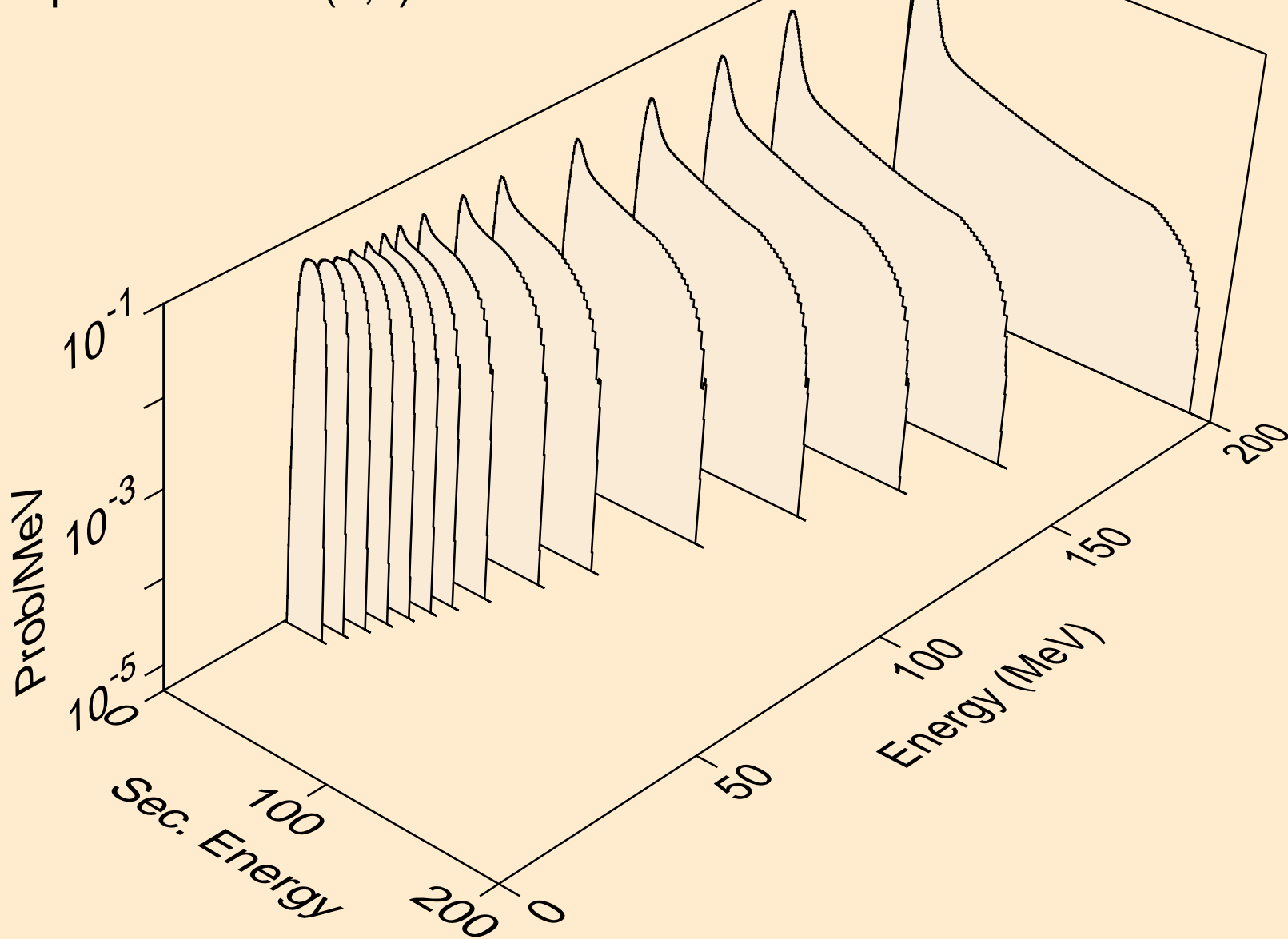

MAT=3649 ACE FILE PRODUCED AT NEA WITH NDEC  
protons from (n,n\*)p

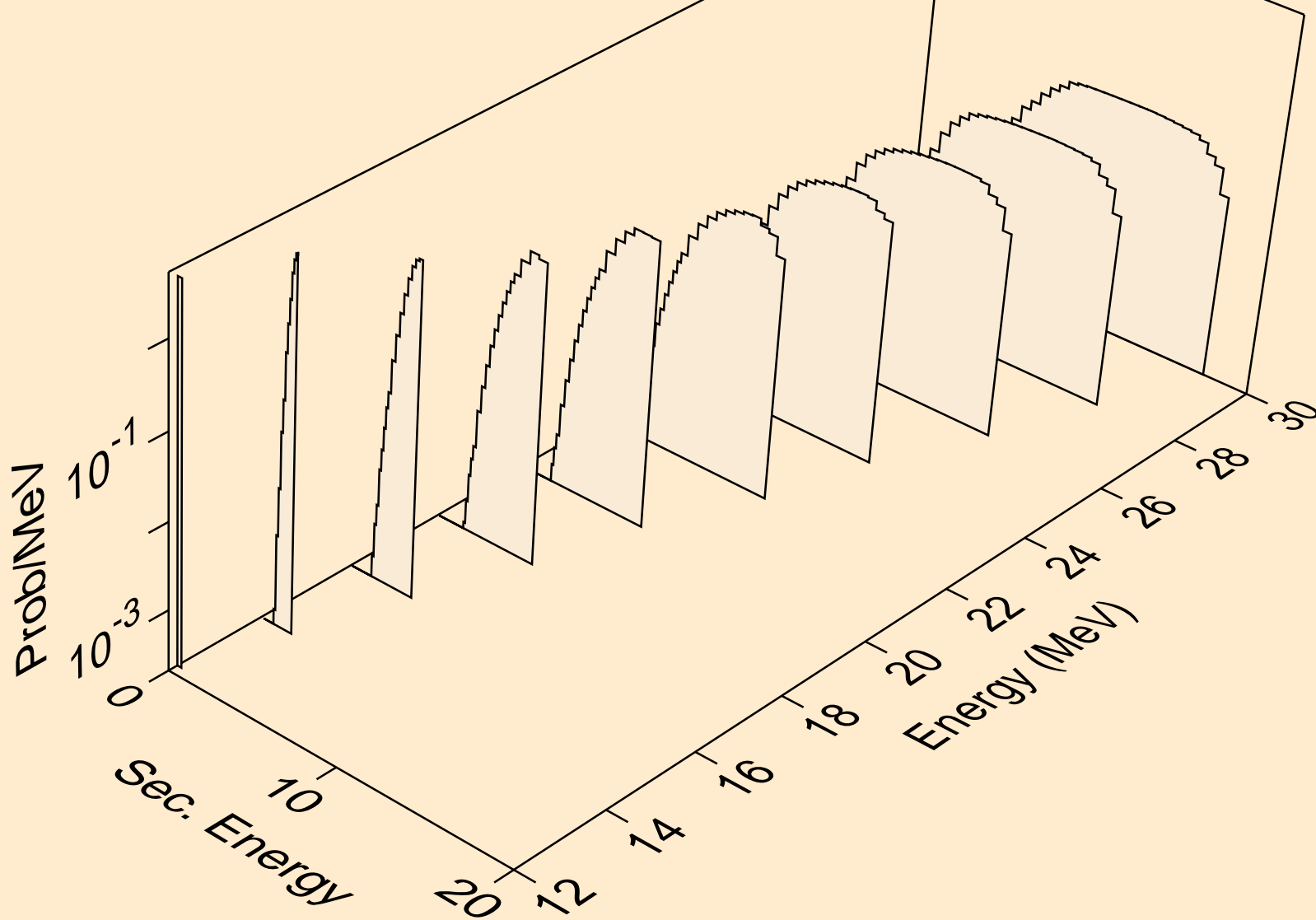

MAT=3649 ACE FILE PRODUCED AT NEA WITH NDEC  
protons from (n,2np)

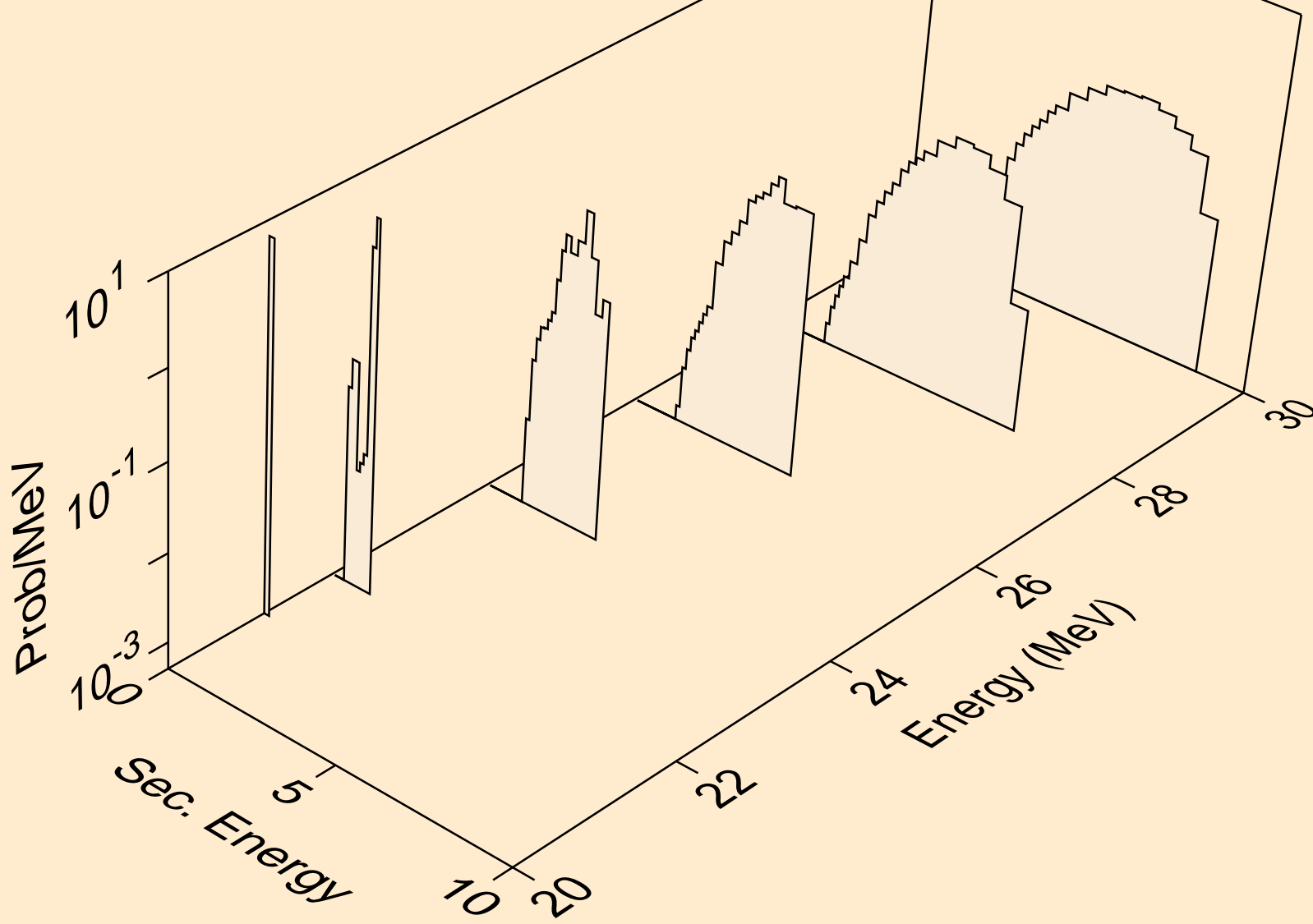

MAT=3649 ACE FILE PRODUCED AT NEA WITH NDEC  
protons from (n,3np)

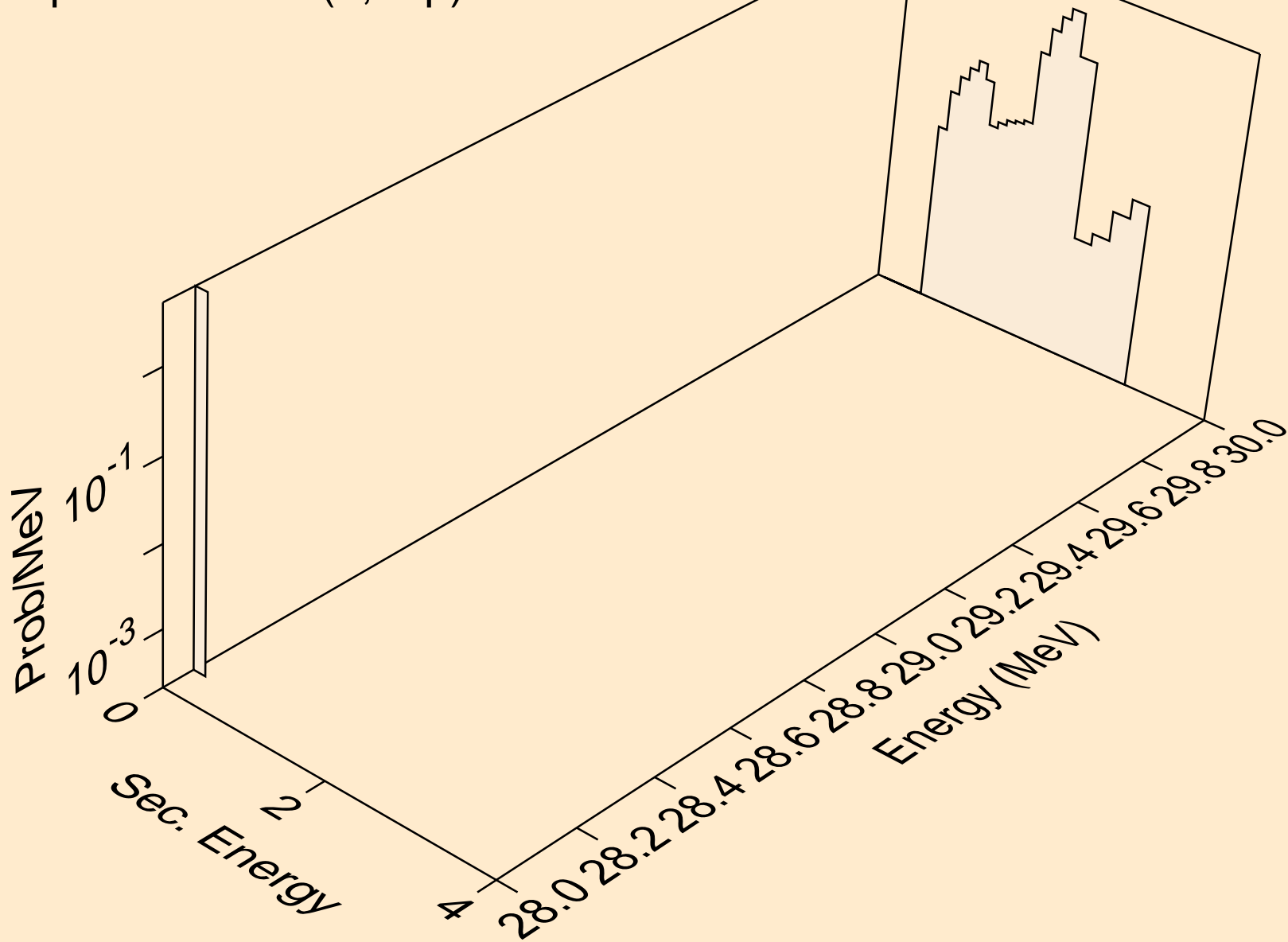

MAT=3649 ACE FILE PRODUCED AT NEA WITH NDEC  
protons from (n,2np)

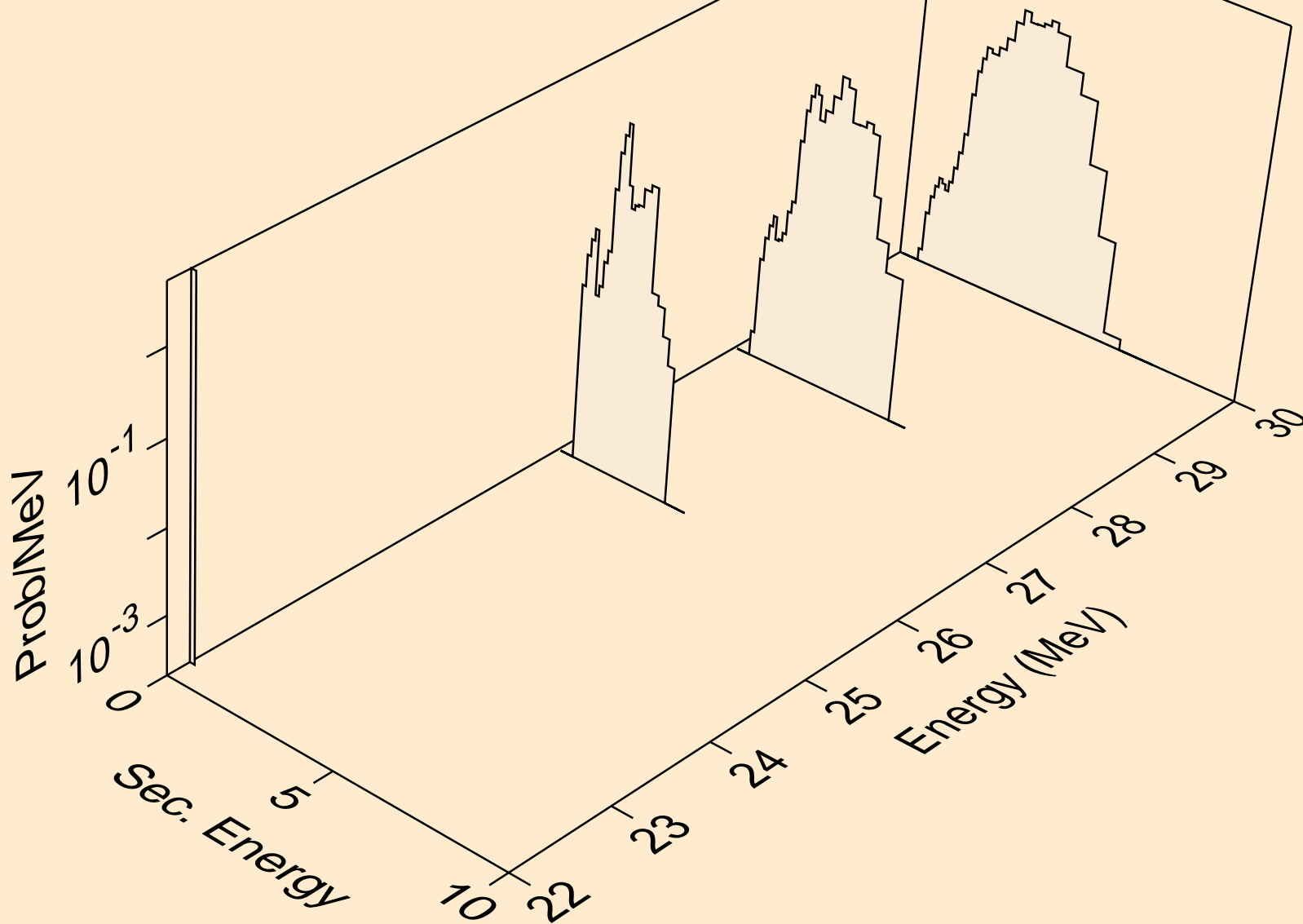

MAT=3649 ACE FILE PRODUCED AT NEA WITH NDEC  
protons from (n,p)

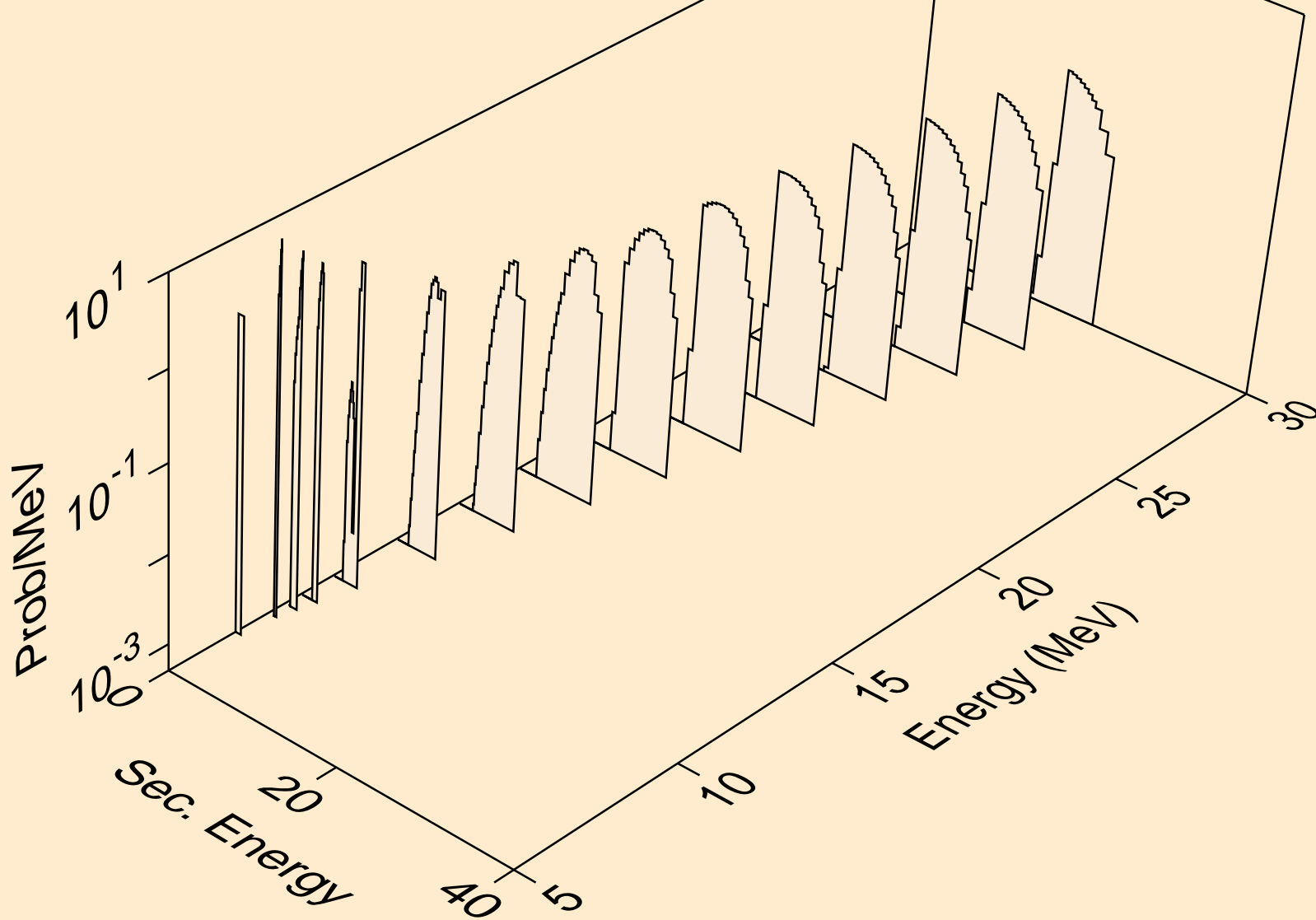

MAT=3649 ACE FILE PRODUCED AT NEA WITH NDEC  
protons from (n,2p)

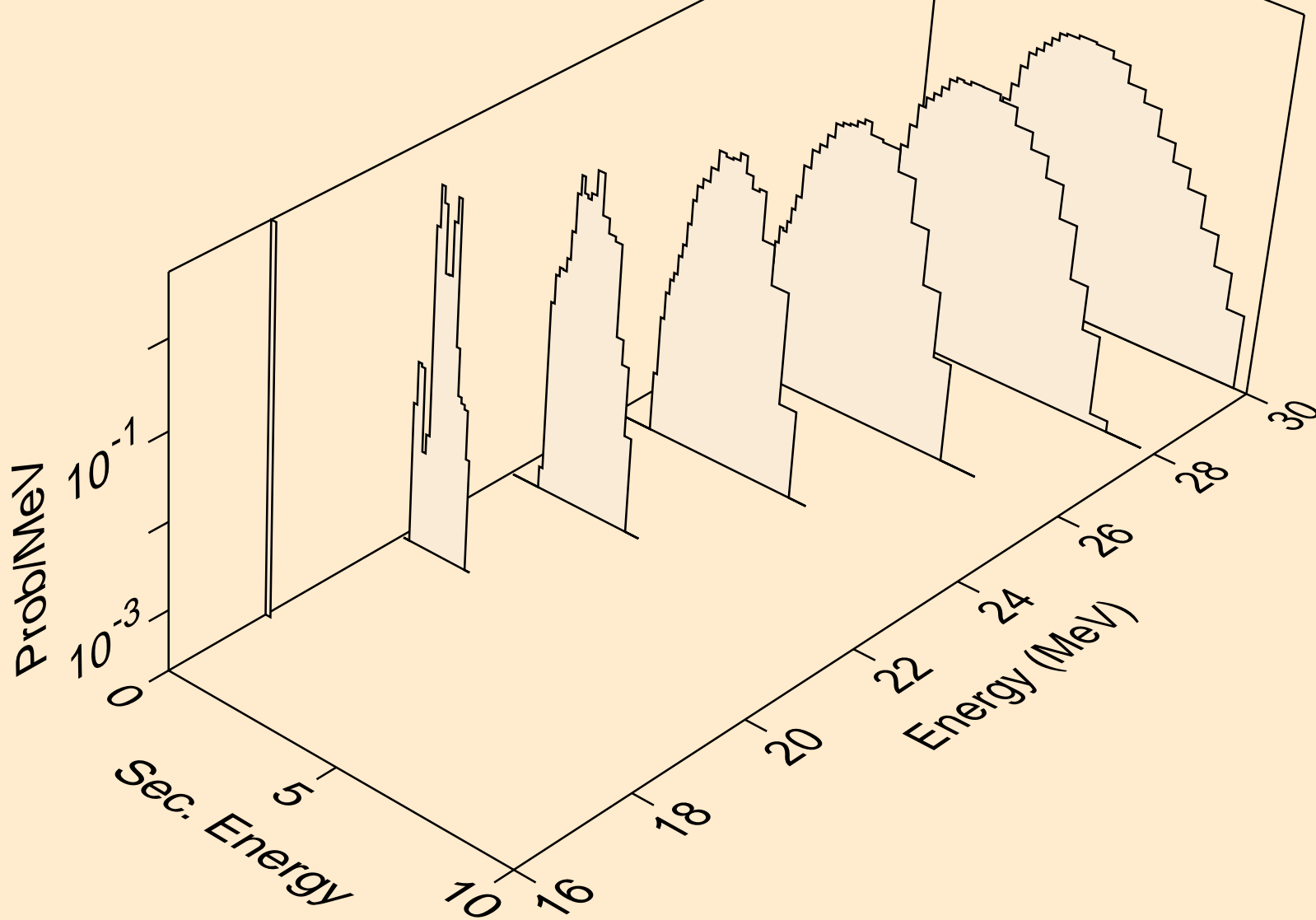

MAT=3649 ACE FILE PRODUCED AT NEA WITH NDEC  
protons from (n,pa)

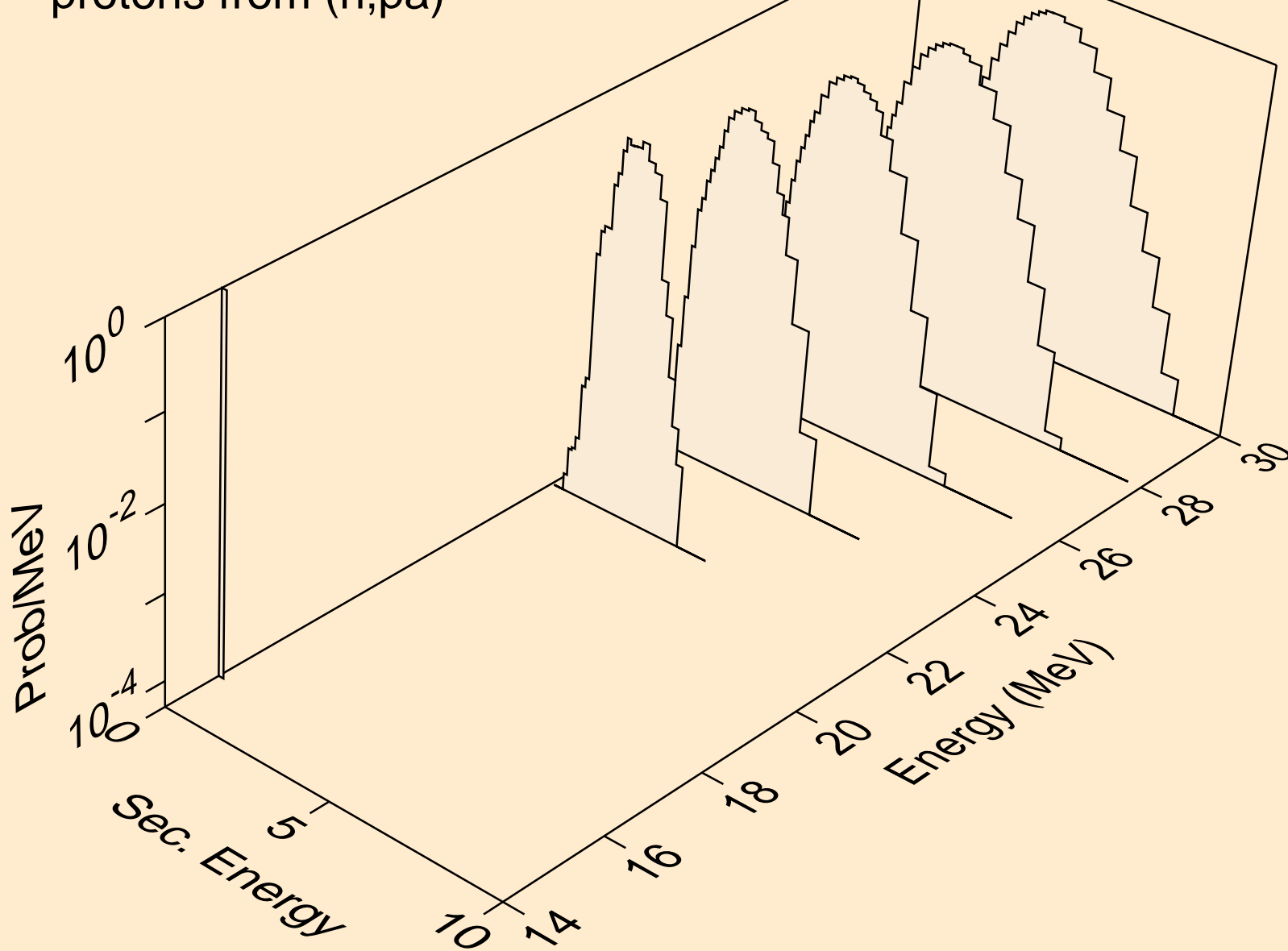

MAT=3649 ACE FILE PRODUCED AT NEA WITH NDEC  
protons from (n,pd)

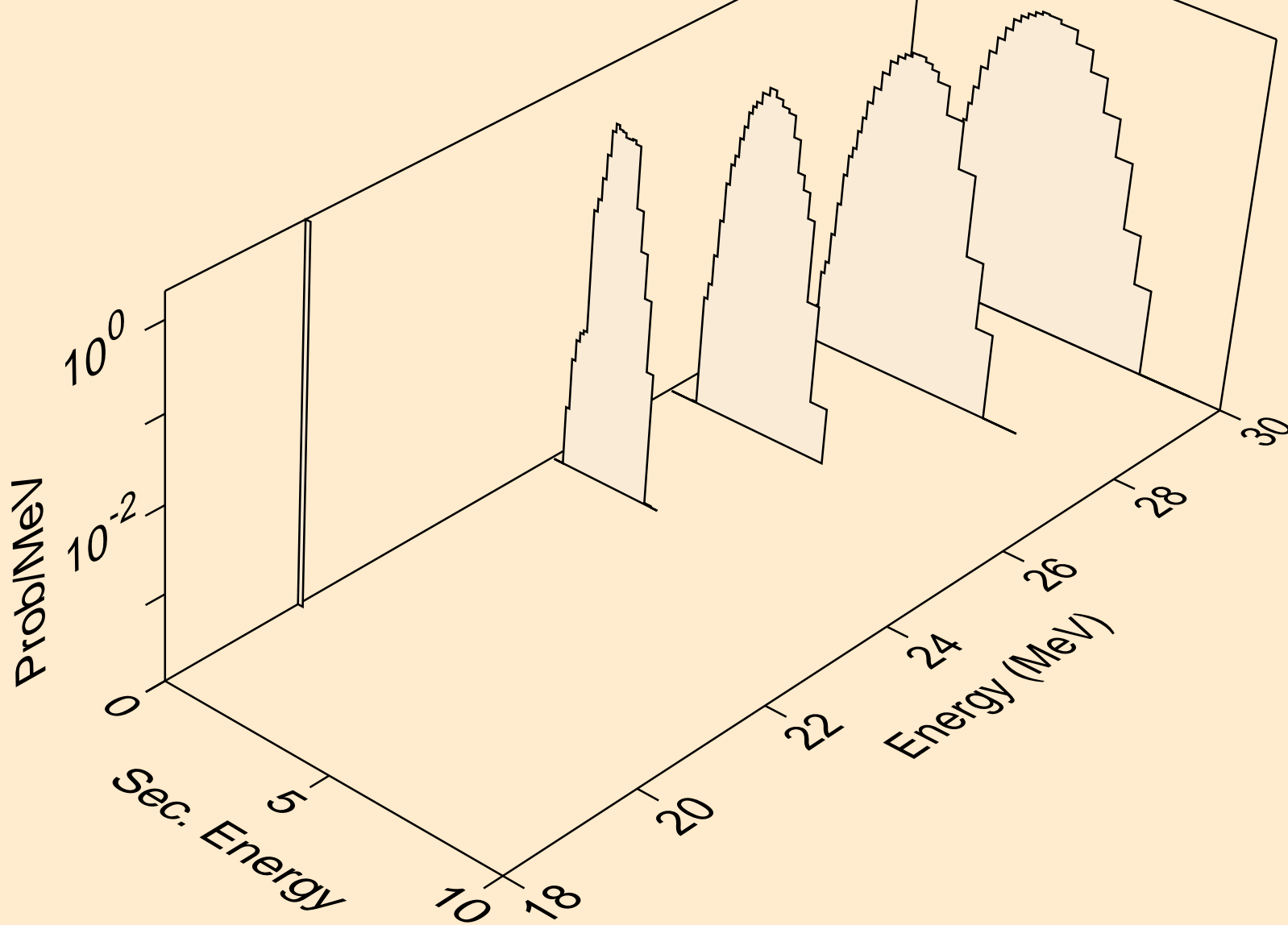

MAT=3649 ACE FILE PRODUCED AT NEA WITH NDEC  
deuterons from (n,x)

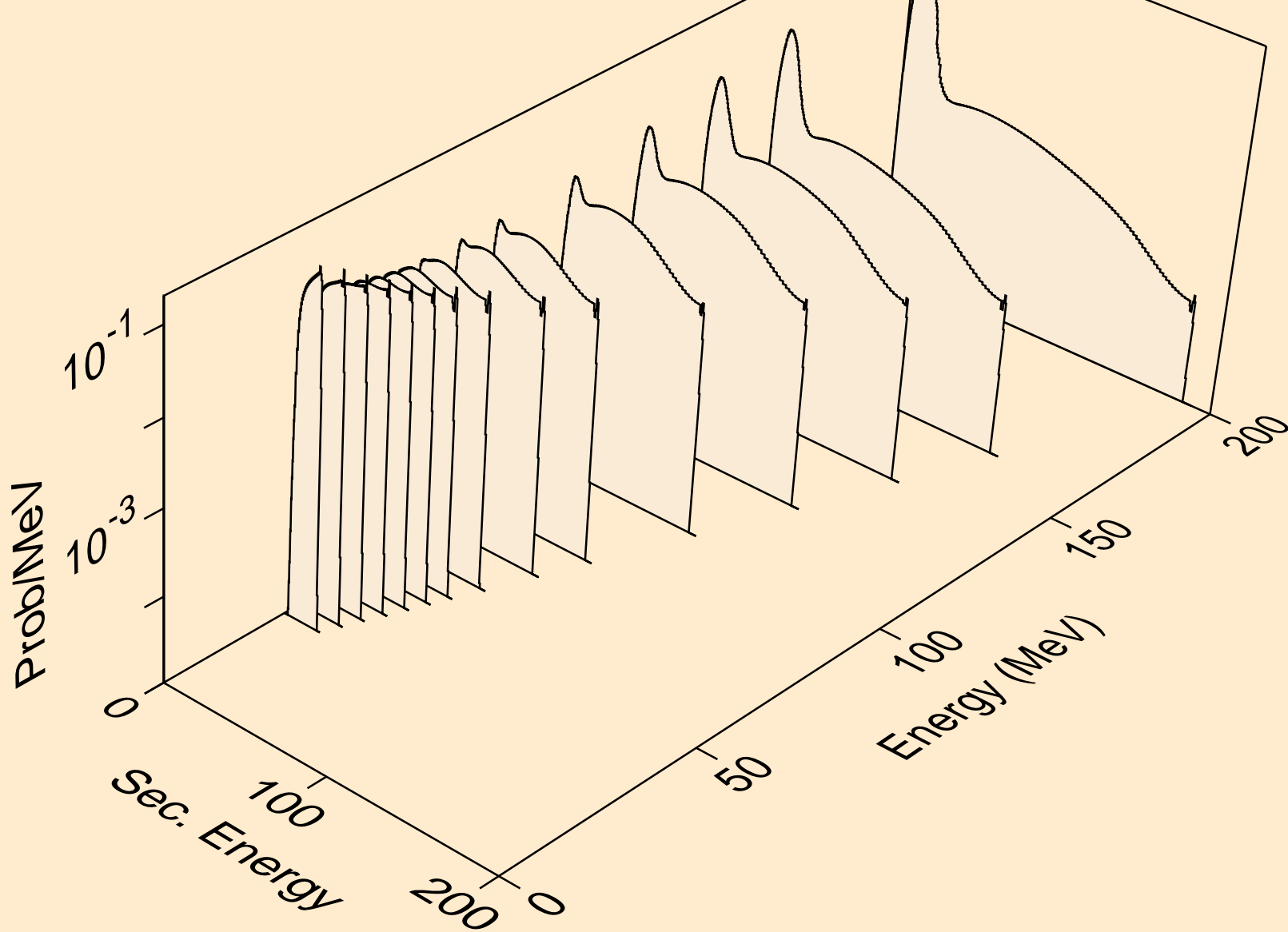

MAT=3649 ACE FILE PRODUCED AT NEA WITH NDEC  
deuterons from (n,2nd)

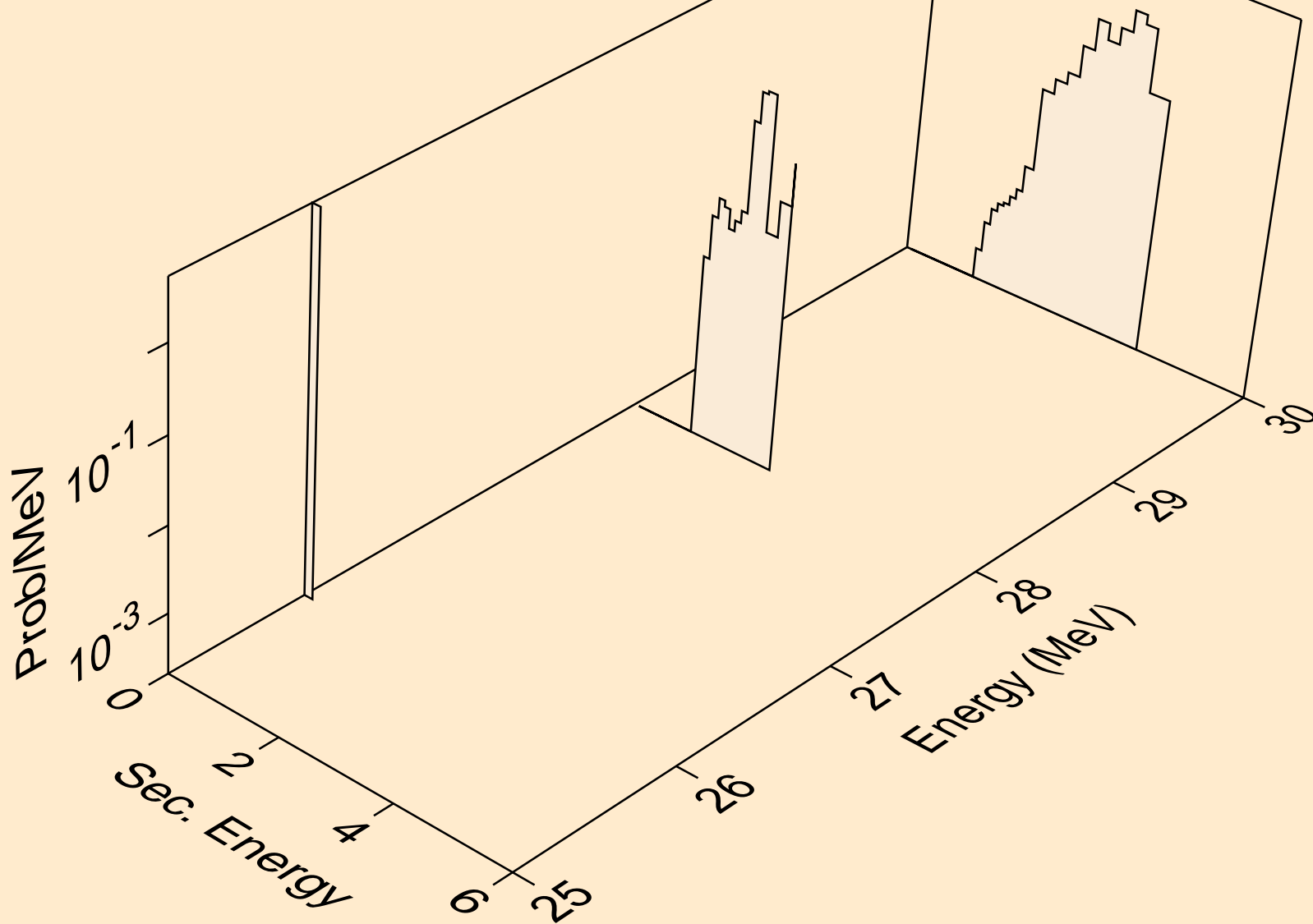

MAT=3649 ACE FILE PRODUCED AT NEA WITH NDEC  
deuterons from (n,n\*)d

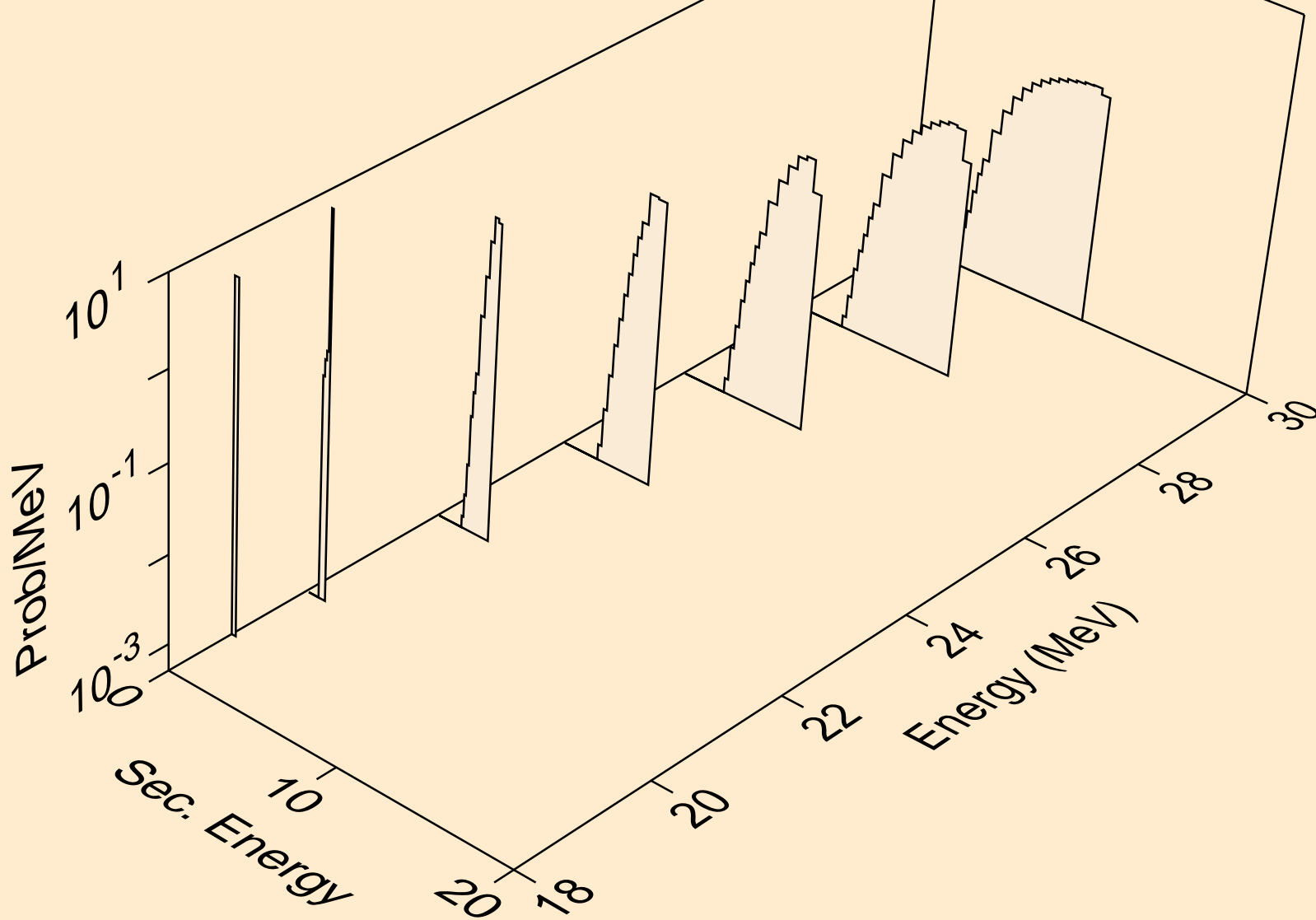

MAT=3649 ACE FILE PRODUCED AT NEA WITH NDEC  
deuterons from (n,d)

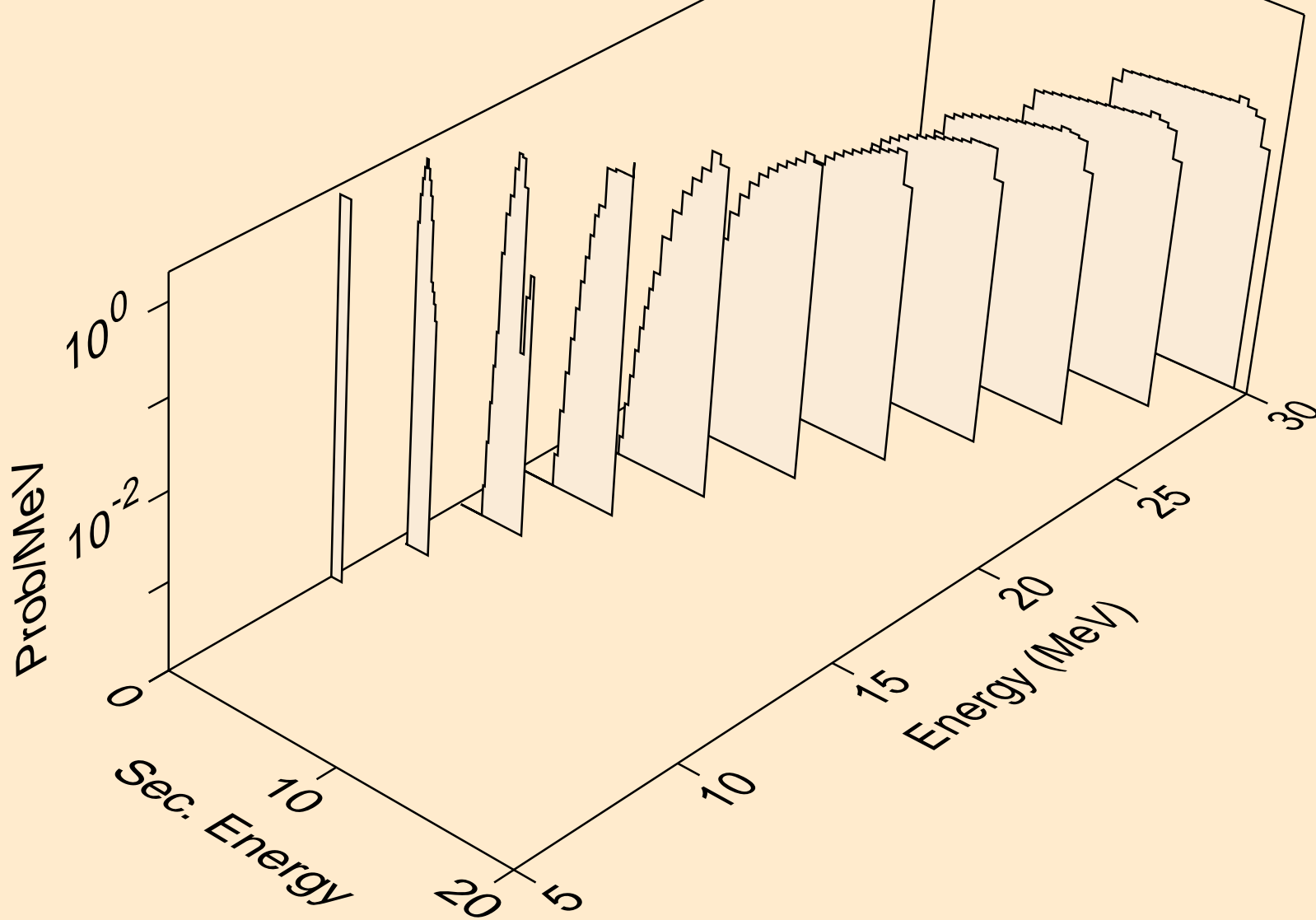

MAT=3649 ACE FILE PRODUCED AT NEA WITH NDEC  
deuterons from (n,pd)

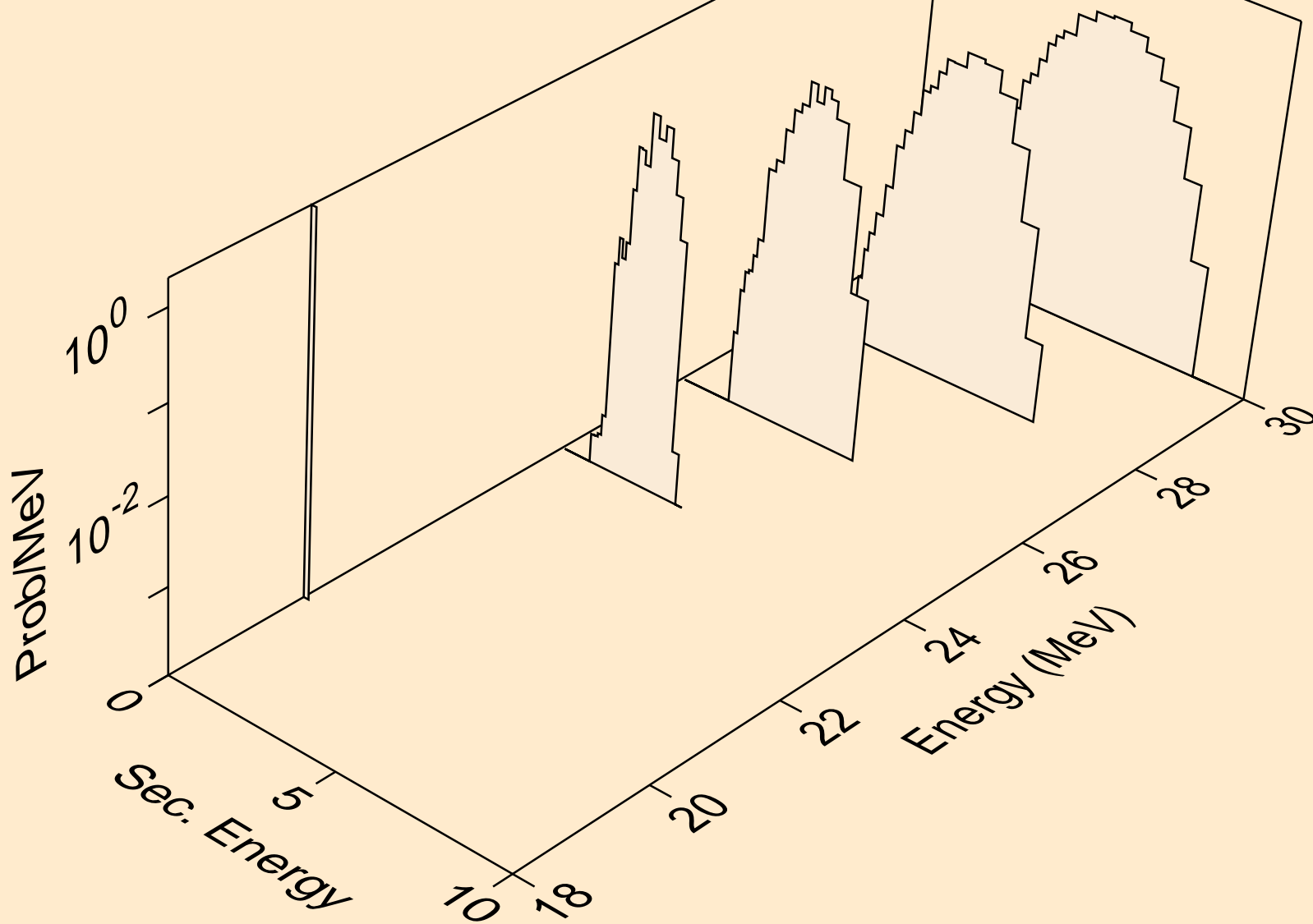

MAT=3649 ACE FILE PRODUCED AT NEA WITH NDEC  
tritons from (n,x)

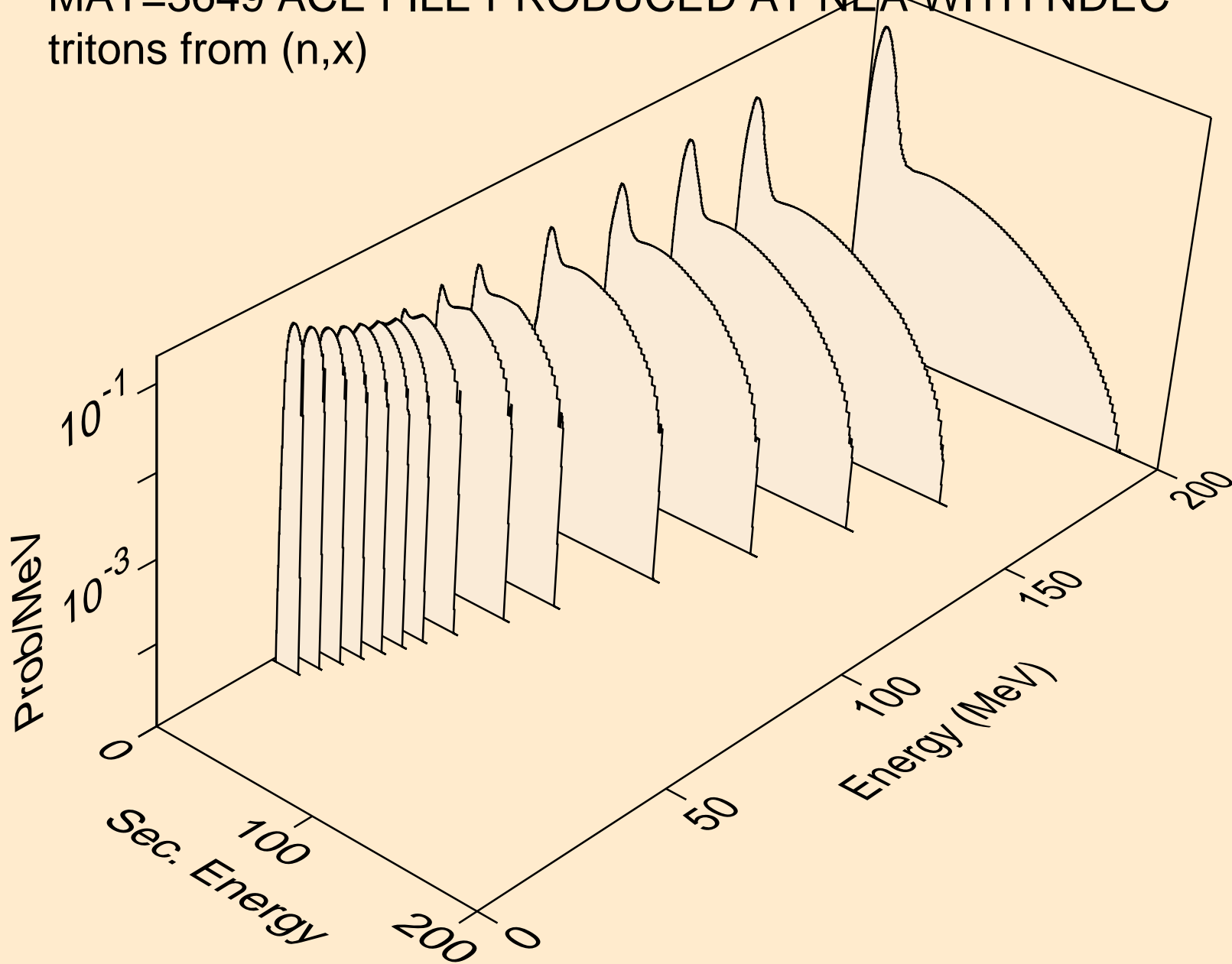

MAT=3649 ACE FILE PRODUCED AT NEA WITH NDEC  
tritons from (n,n\*)t

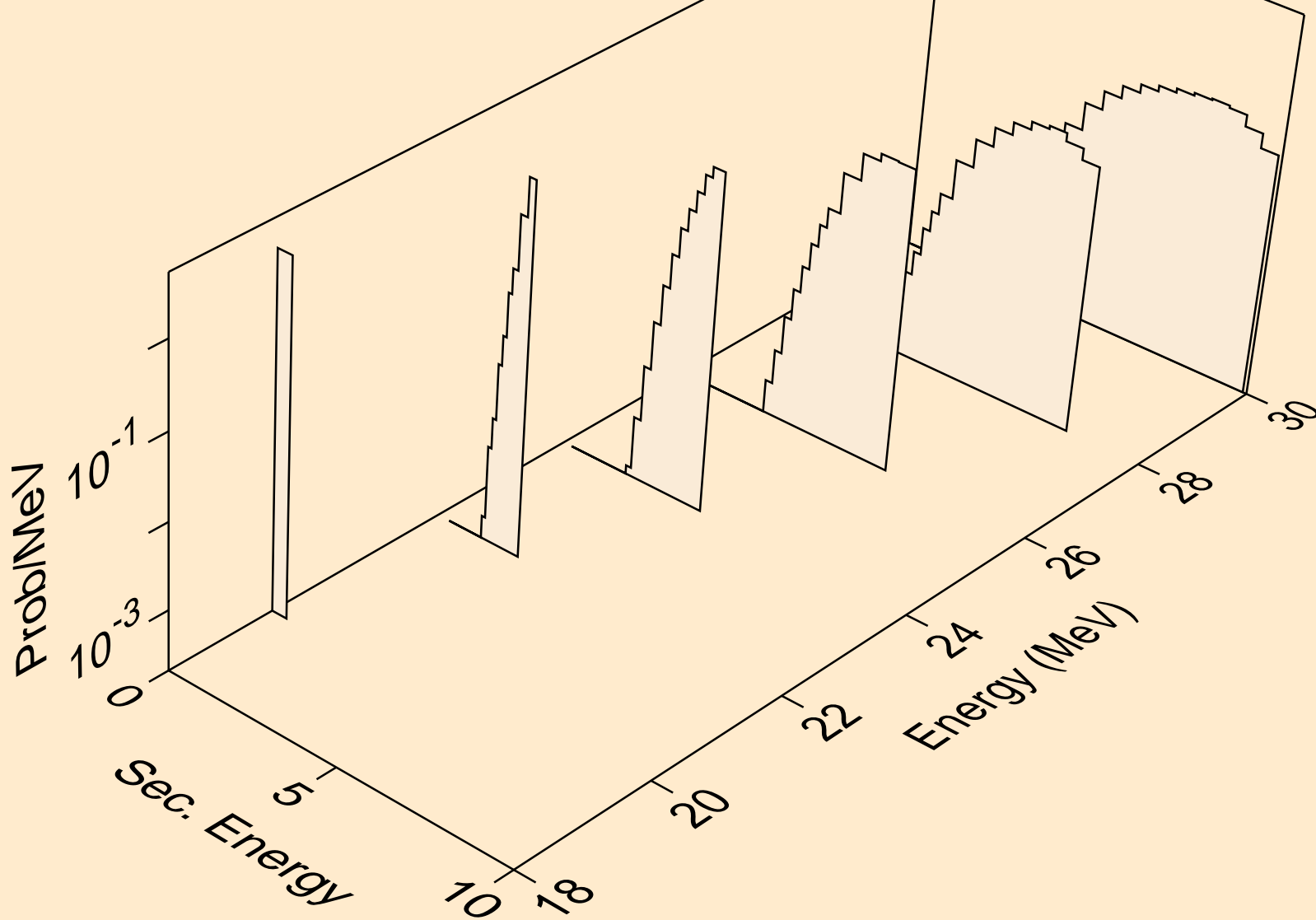

MAT=3649 ACE FILE PRODUCED AT NEA WITH NDEC  
tritons from (n,t)

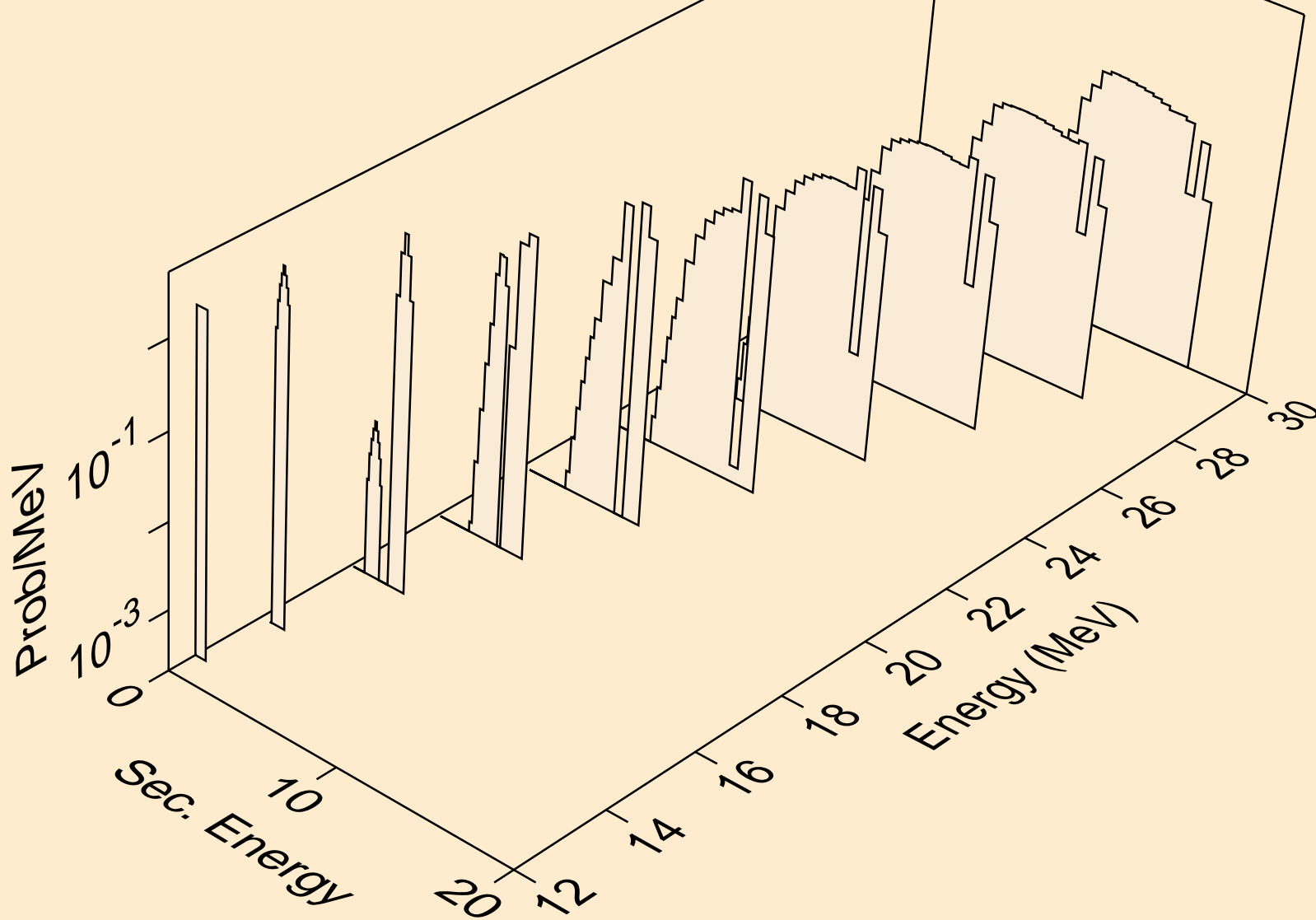

MAT=3649 ACE FILE PRODUCED AT NEA WITH NDEC  
he3s from (n,x)

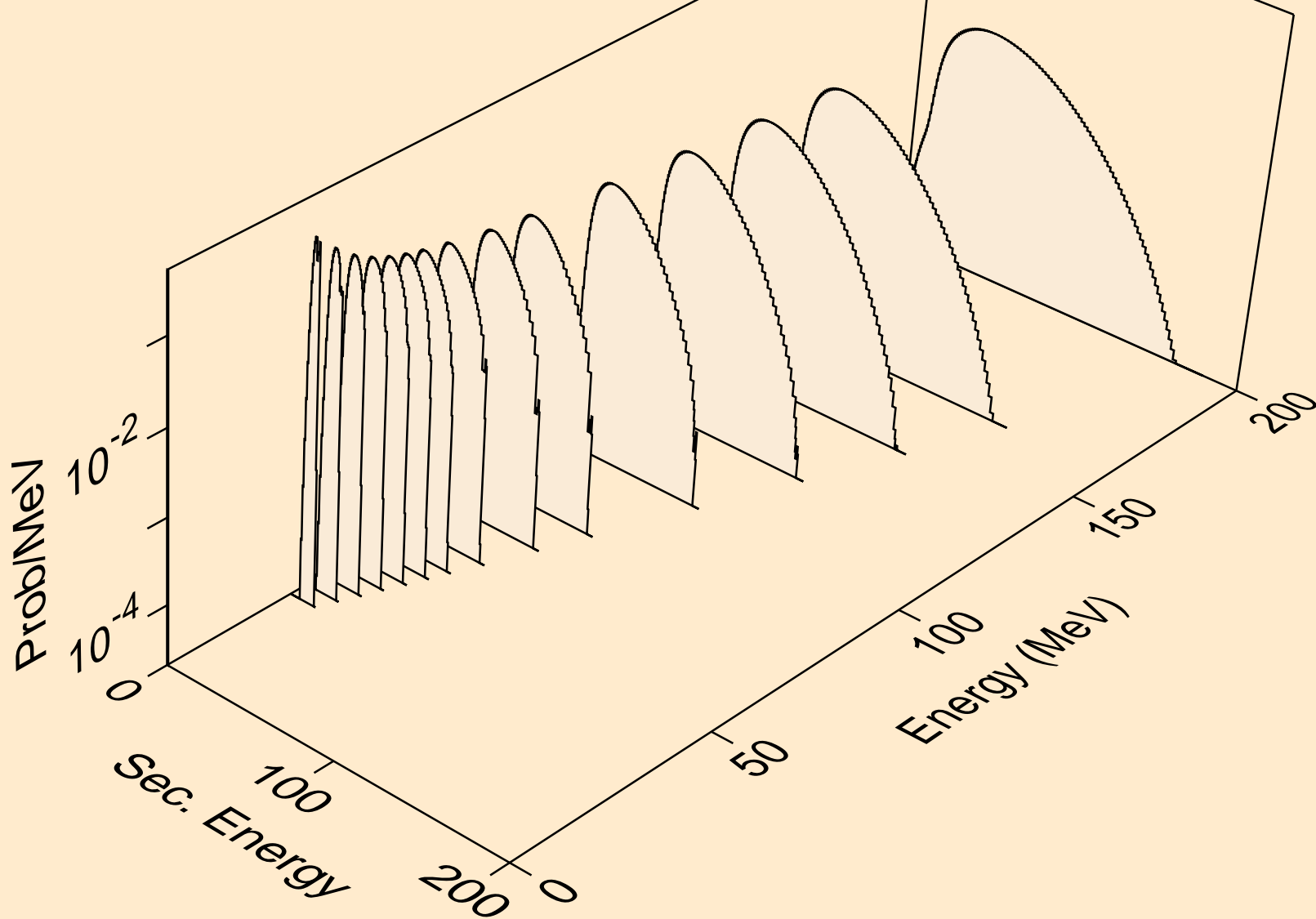

MAT=3649 ACE FILE PRODUCED AT NEA WITH NDEC  
he3s from (n,n\*)he3

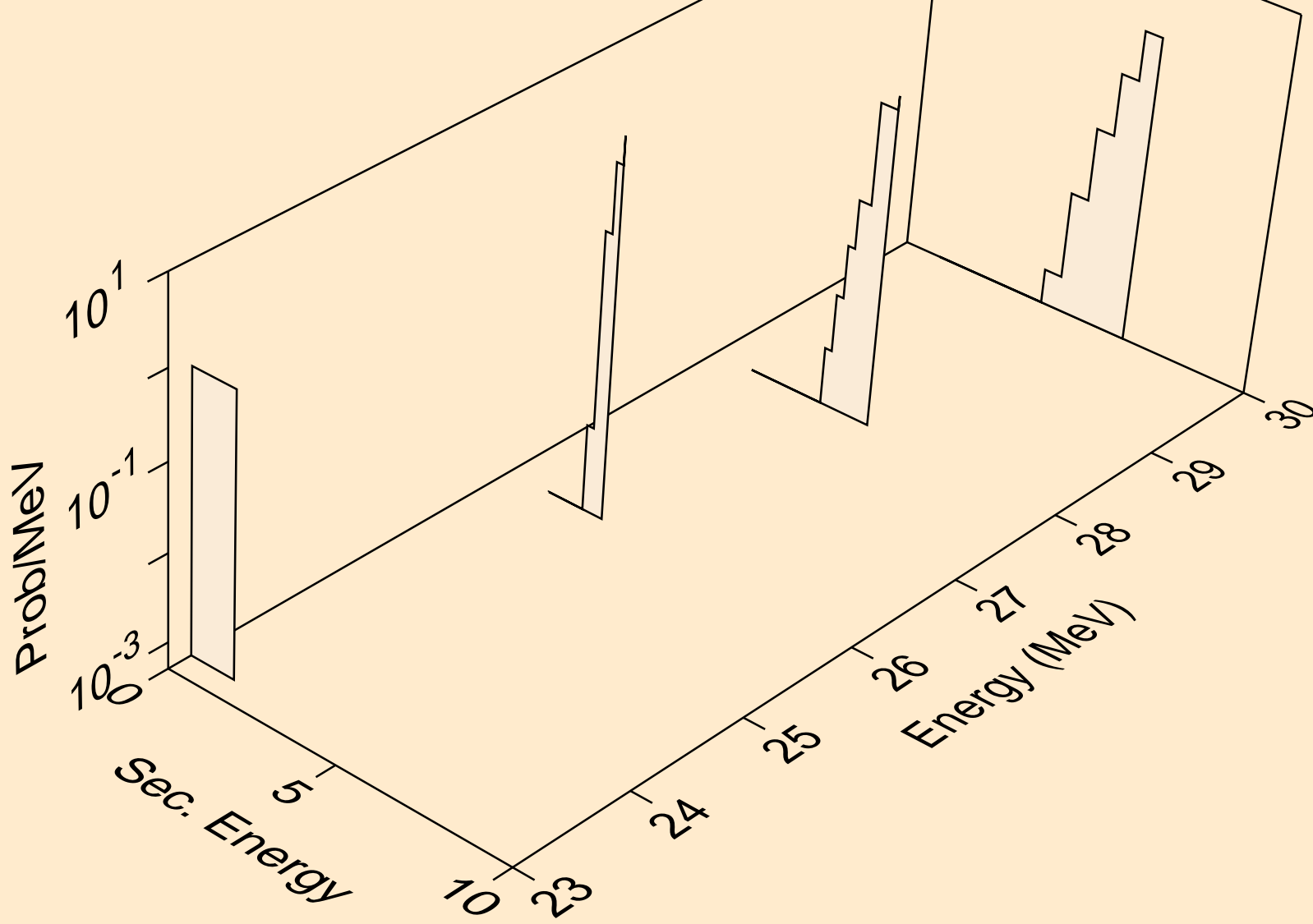

MAT=3649 ACE FILE PRODUCED AT NEA WITH NDEC  
he3s from (n,he3)

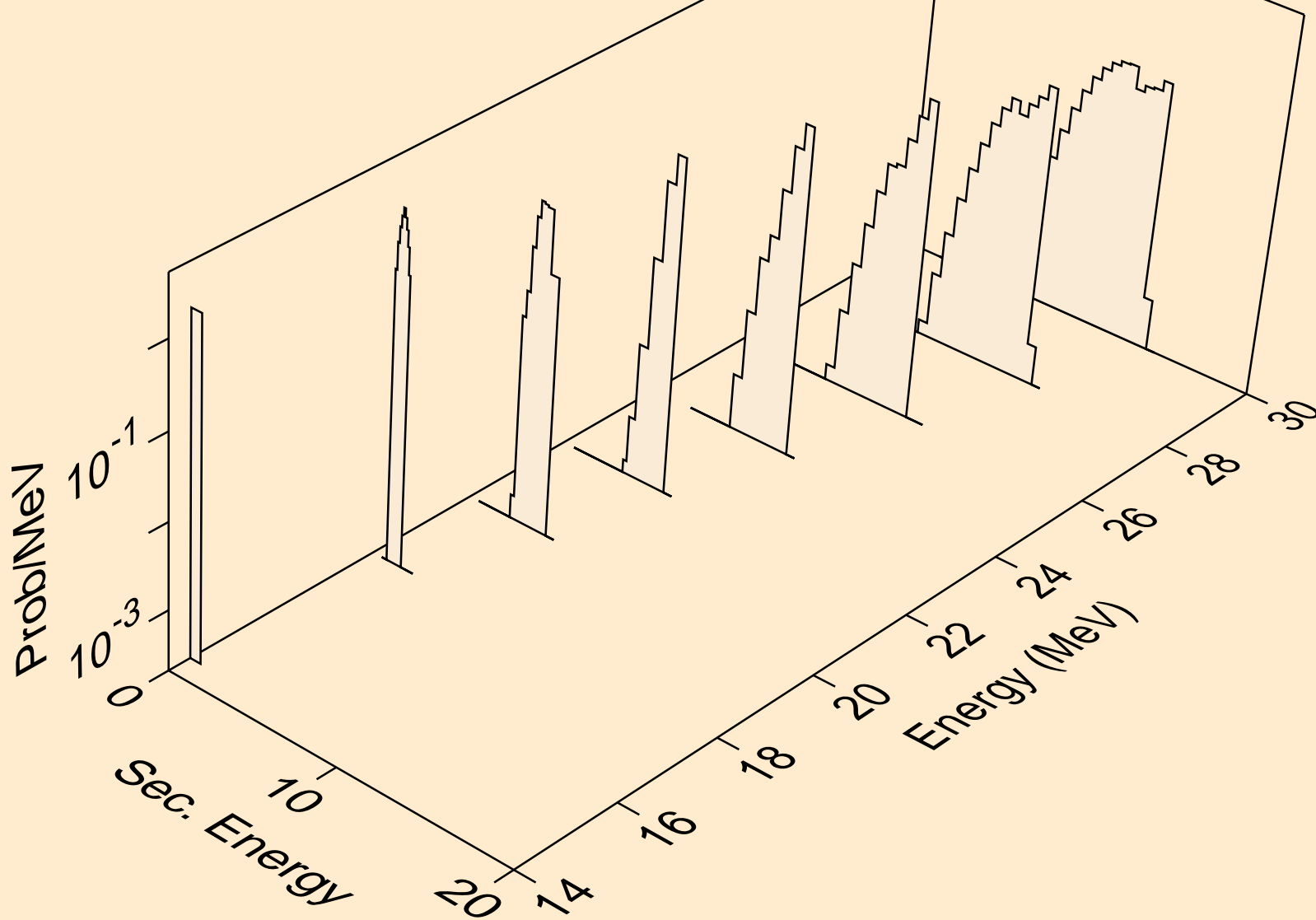

MAT=3649 ACE FILE PRODUCED AT NEA WITH NDEC  
alphas from (n,x)

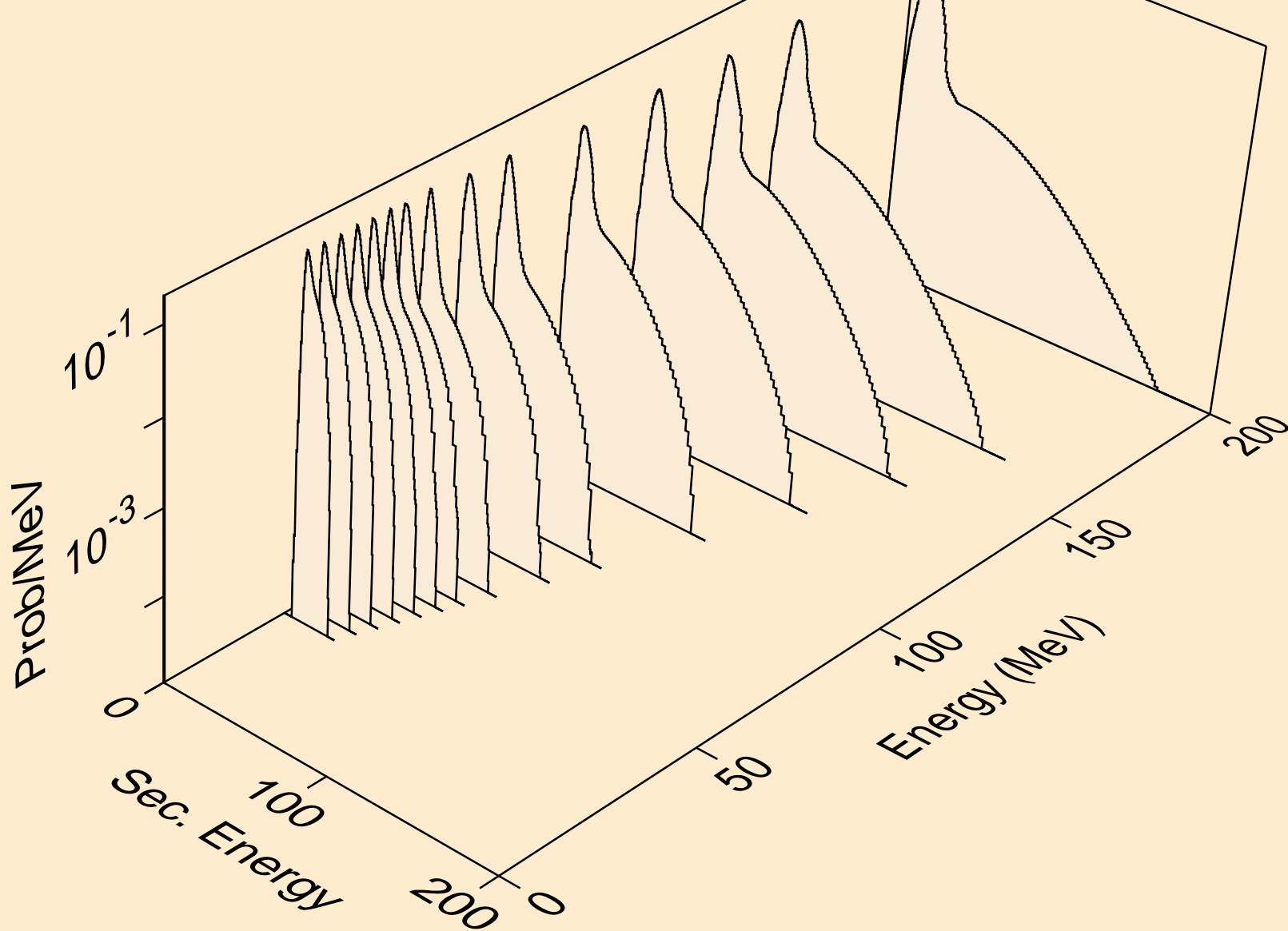

MAT=3649 ACE FILE PRODUCED AT NEA WITH NDEC  
alphas from (n,n\*)a

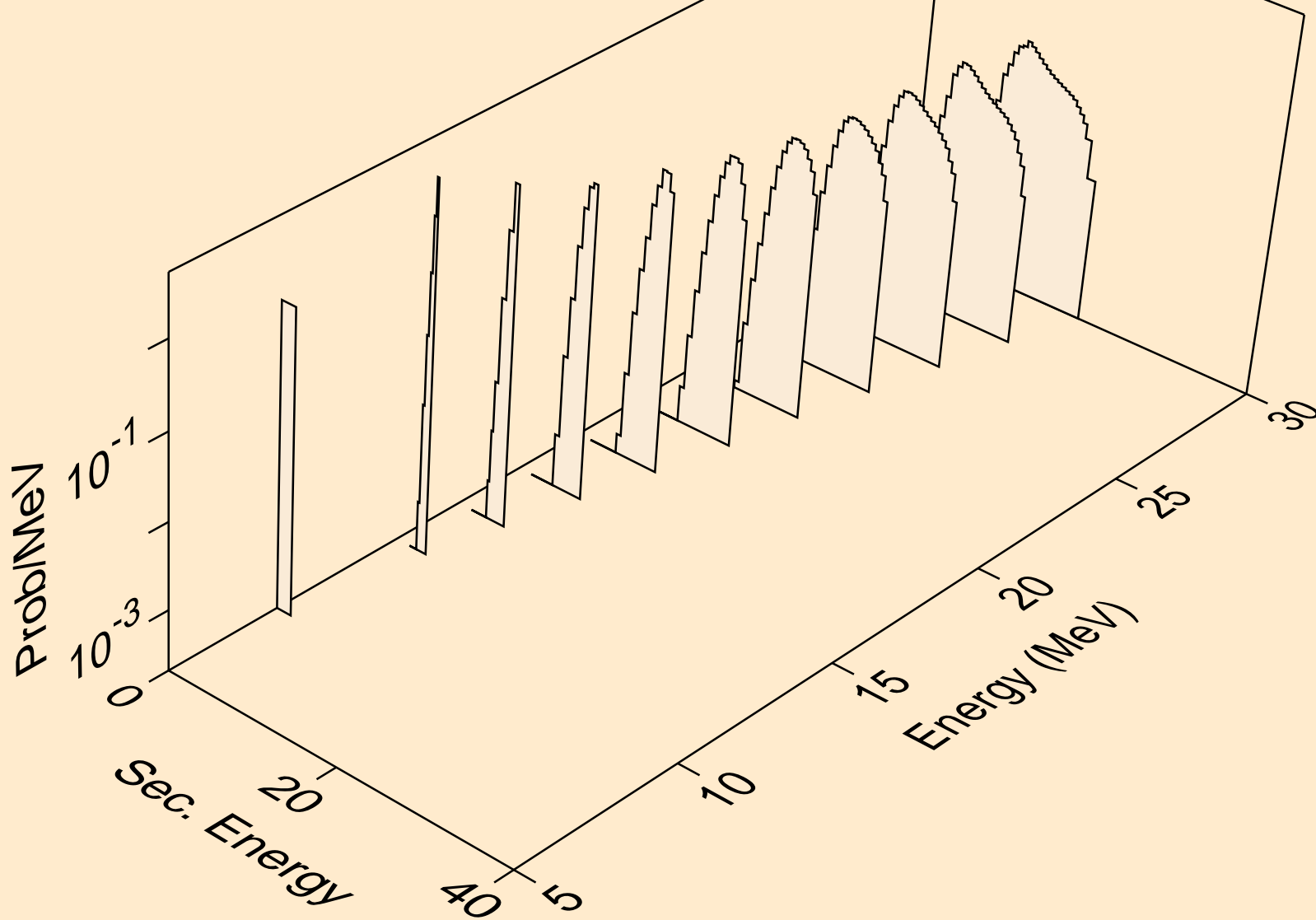

MAT=3649 ACE FILE PRODUCED AT NEA WITH NDEC  
alphas from (n,2n)a

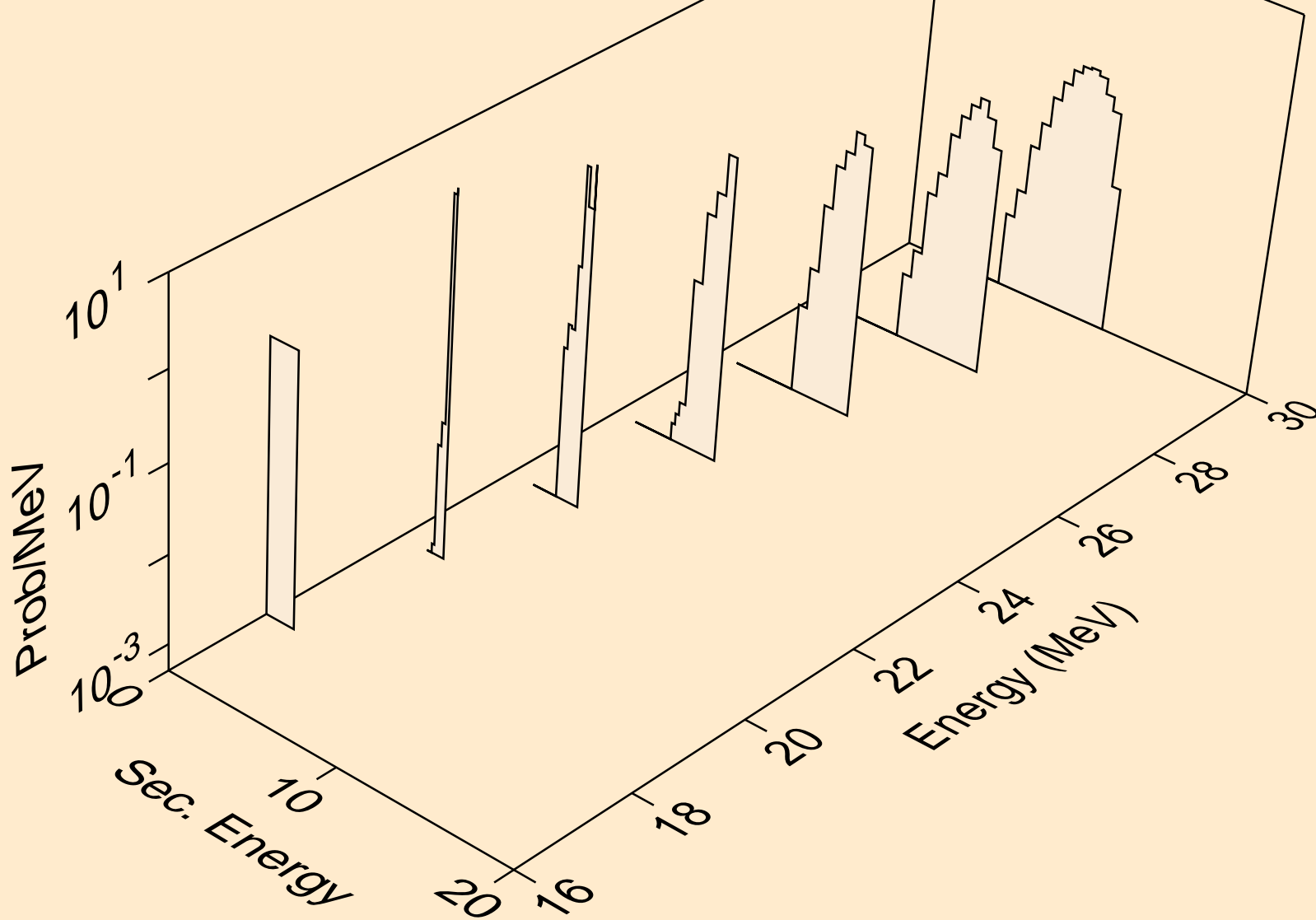

MAT=3649 ACE FILE PRODUCED AT NEA WITH NDEC  
alphas from (n,3n)a

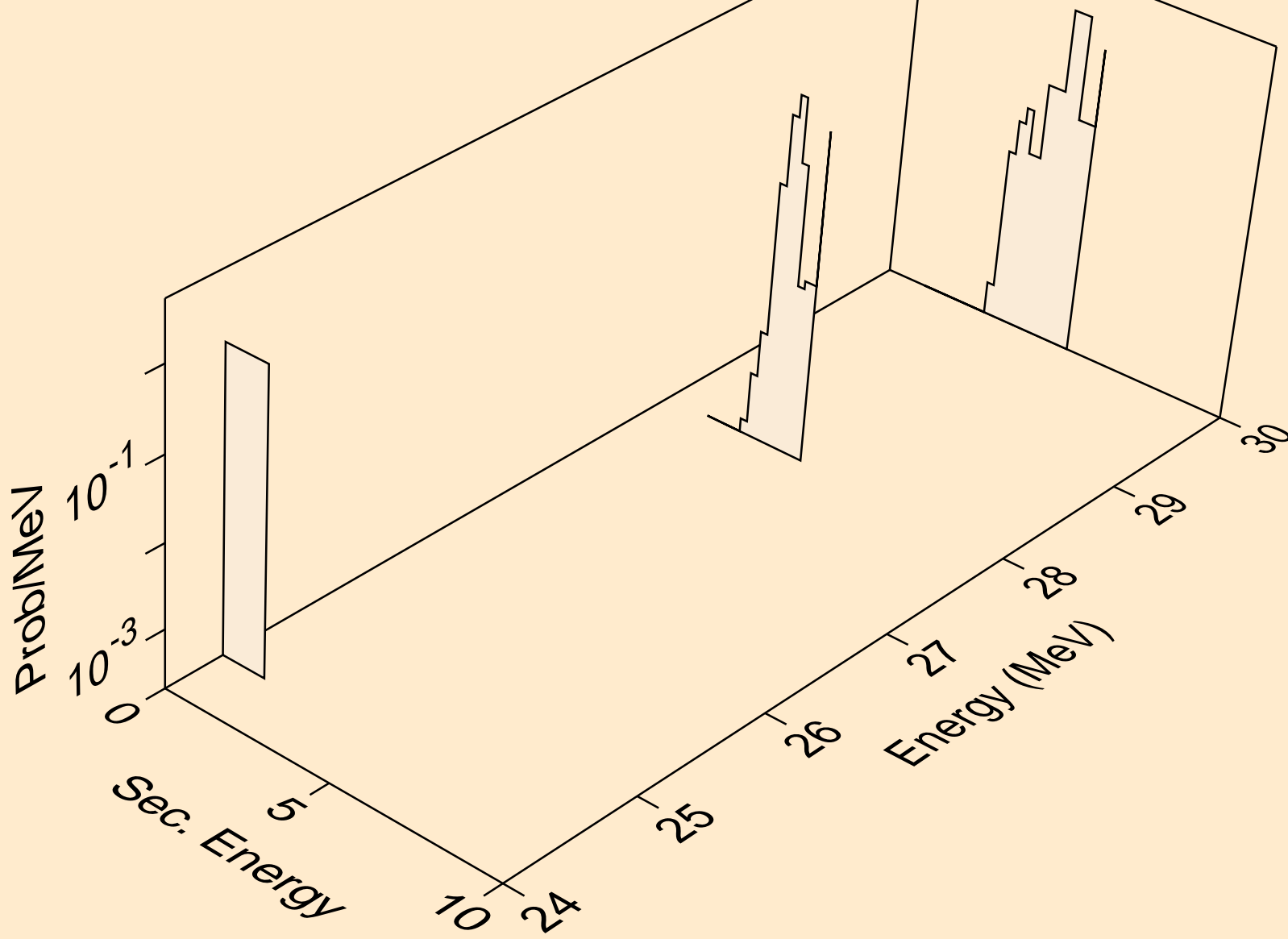

MAT=3649 ACE FILE PRODUCED AT NEA WITH NDEC  
alphas from (n,a)

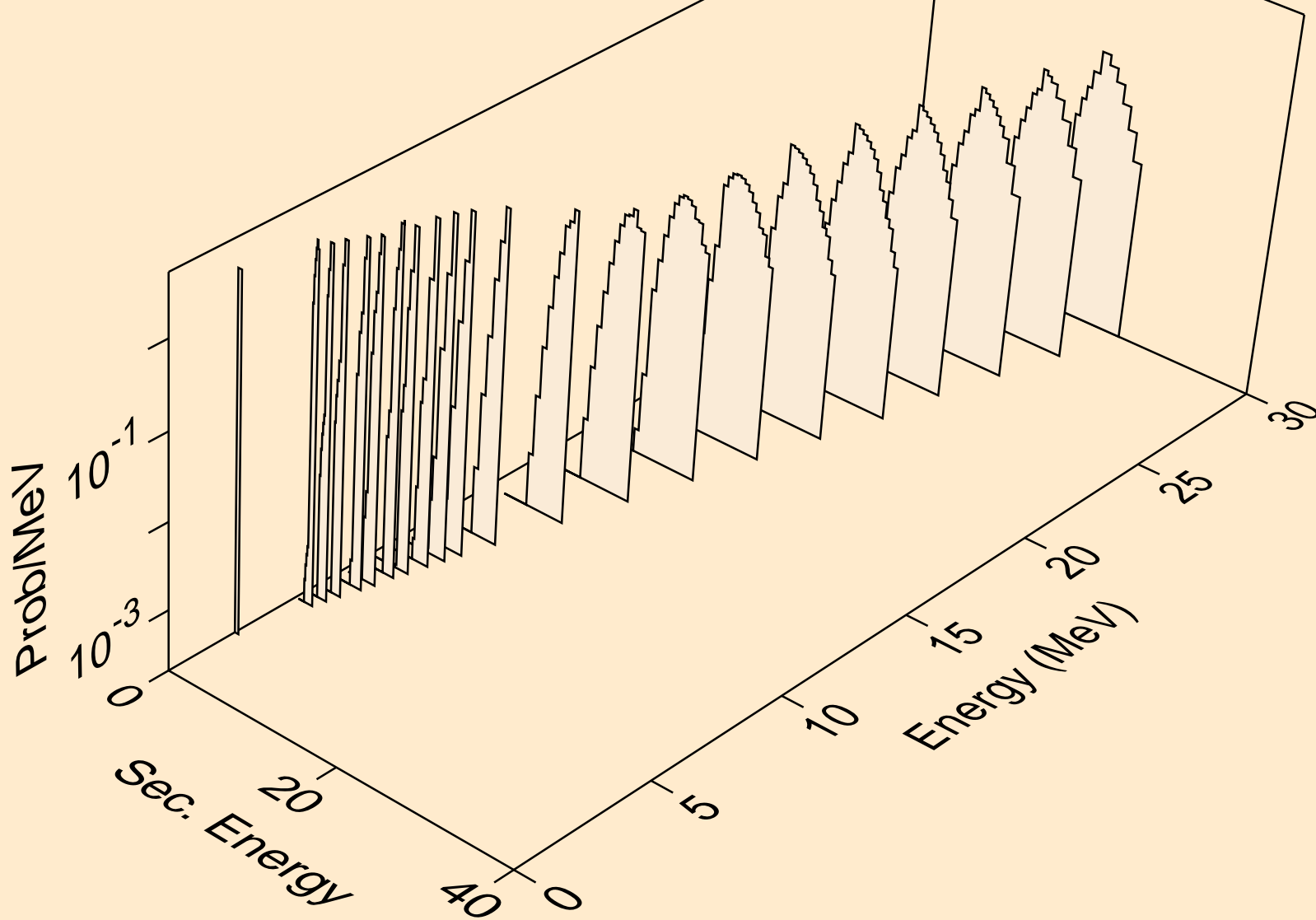

MAT=3649 ACE FILE PRODUCED AT NEA WITH NDEC  
alphas from (n,2a)

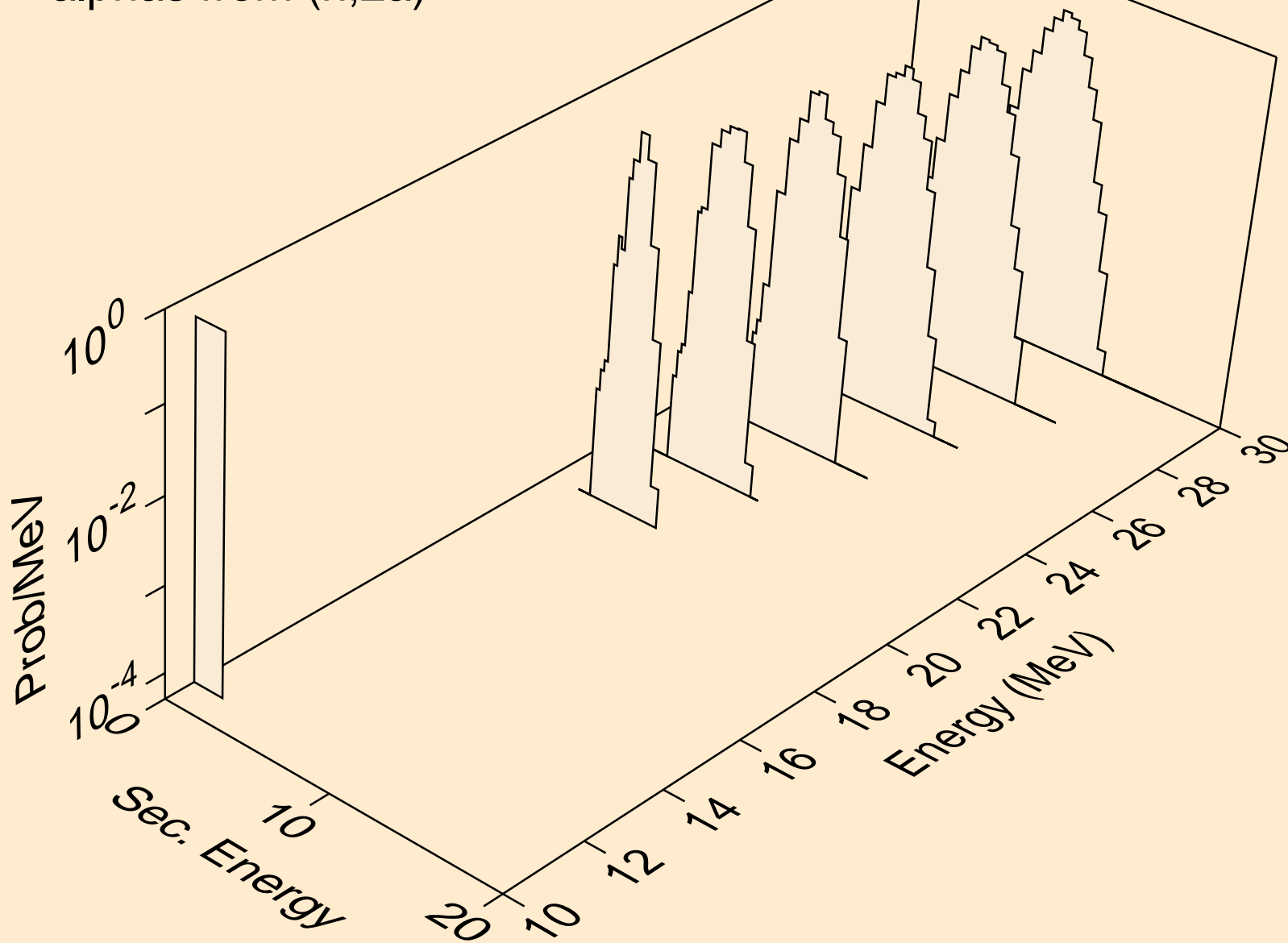

MAT=3649 ACE FILE PRODUCED AT NEA WITH NDEC  
alphas from (n,pa)

