

MAT=2637 ACE FILE PRODUCED AT NEA WITH NDEC  
Principal cross sections

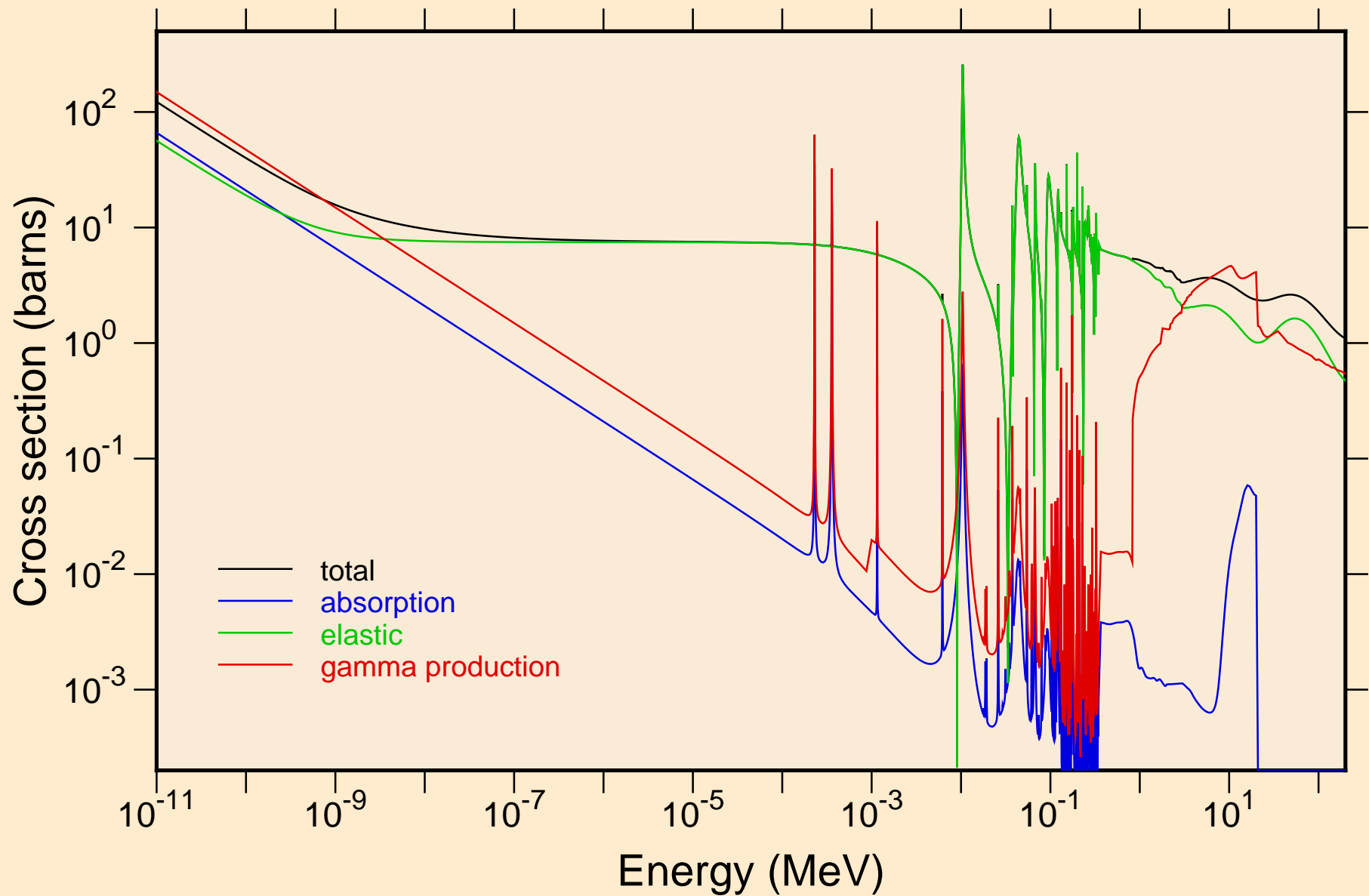

MAT=2637 ACE FILE PRODUCED AT NEA WITH NDEC  
resonance total cross section

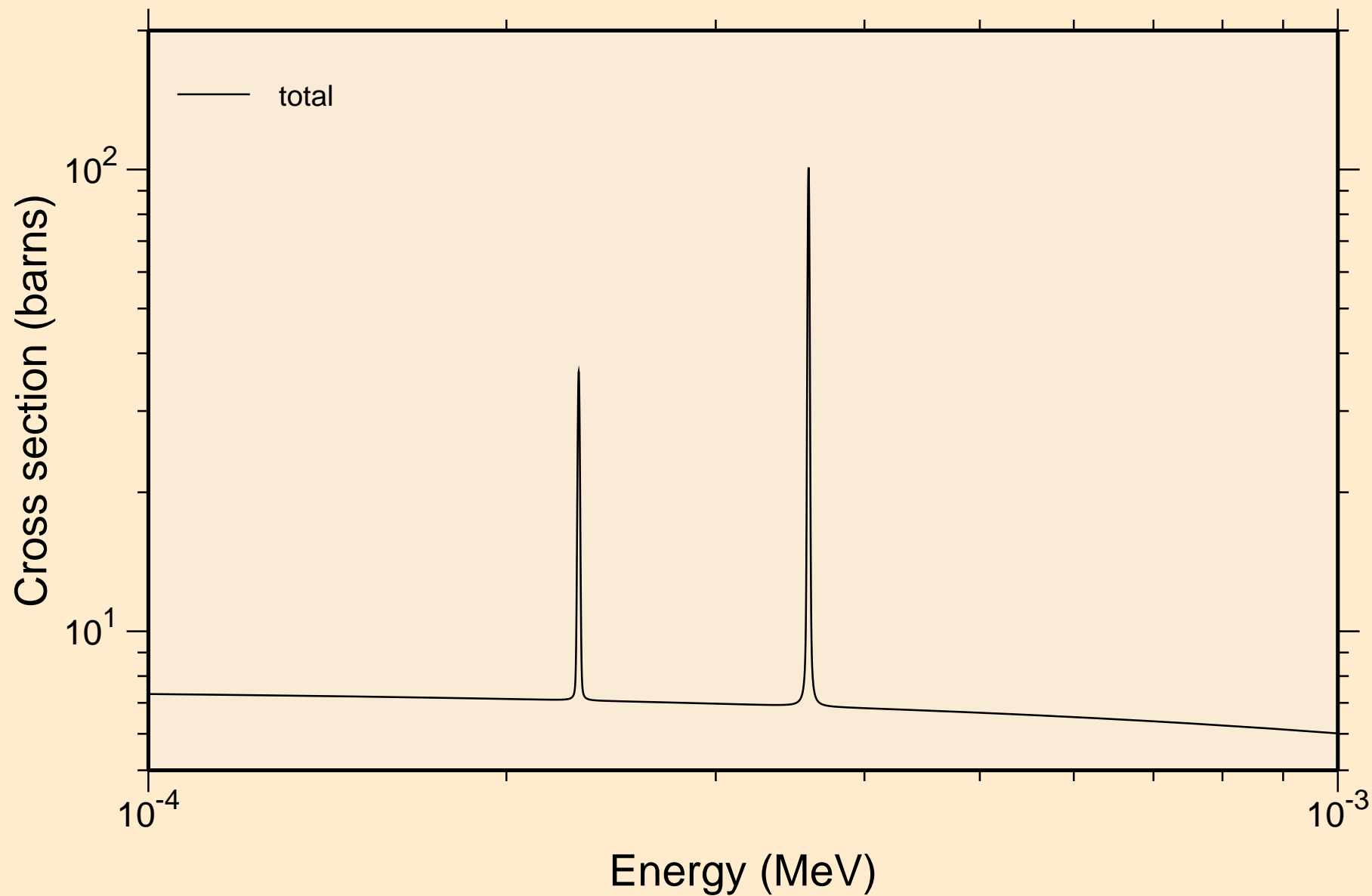

MAT=2637 ACE FILE PRODUCED AT NEA WITH NDEC  
resonance total cross section

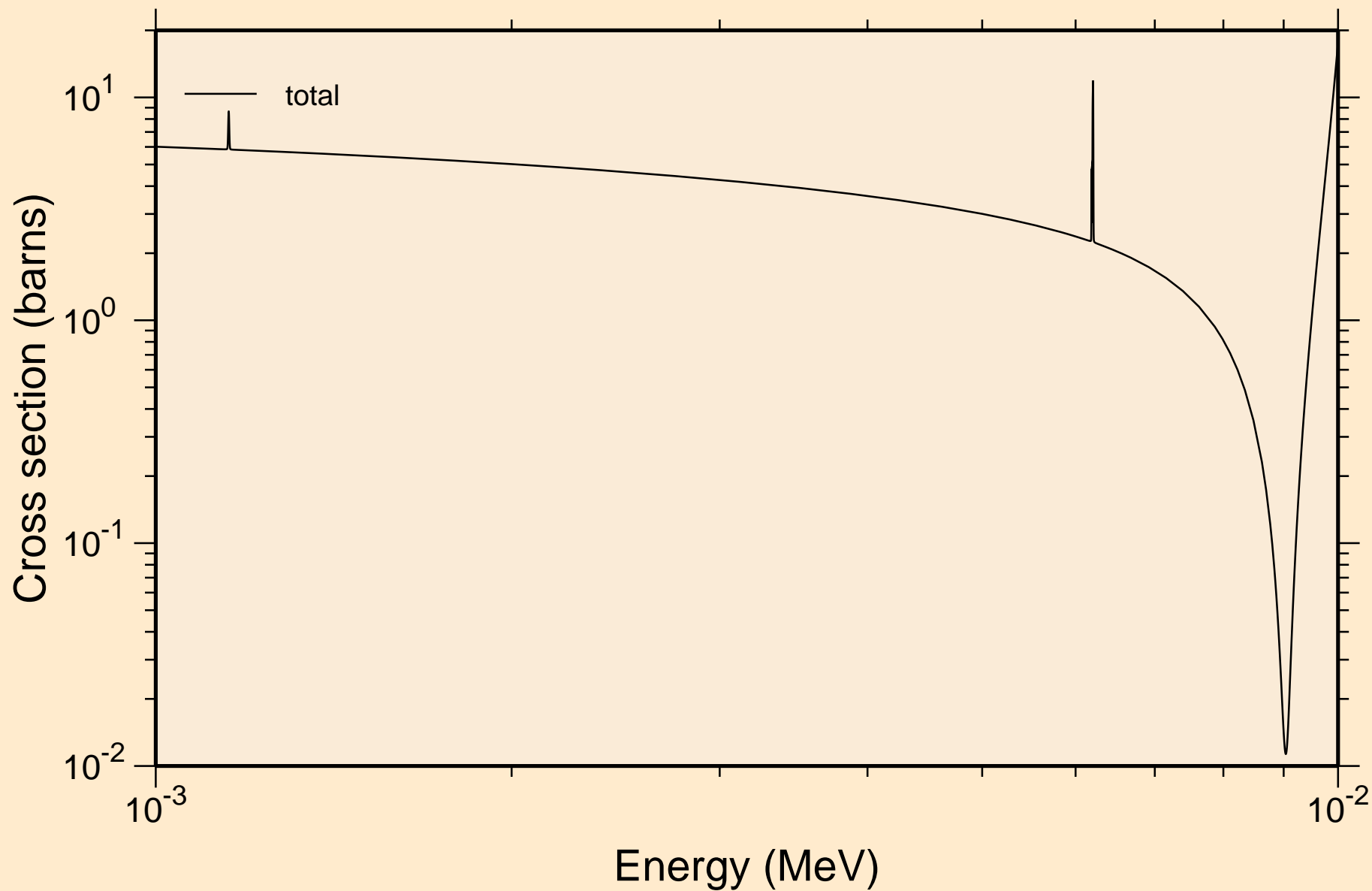

MAT=2637 ACE FILE PRODUCED AT NEA WITH NDEC  
resonance total cross section

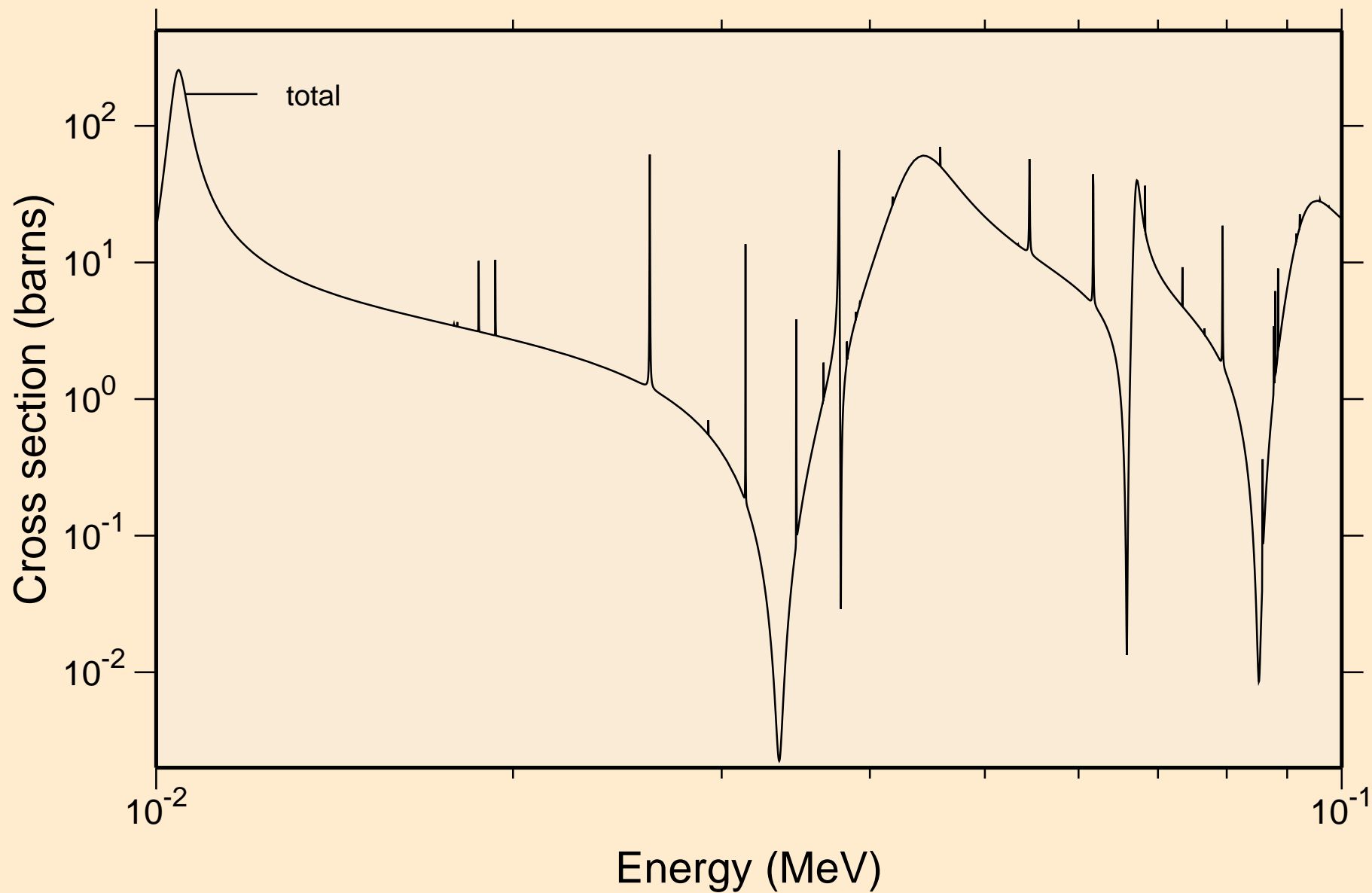

MAT=2637 ACE FILE PRODUCED AT NEA WITH NDEC  
resonance total cross section

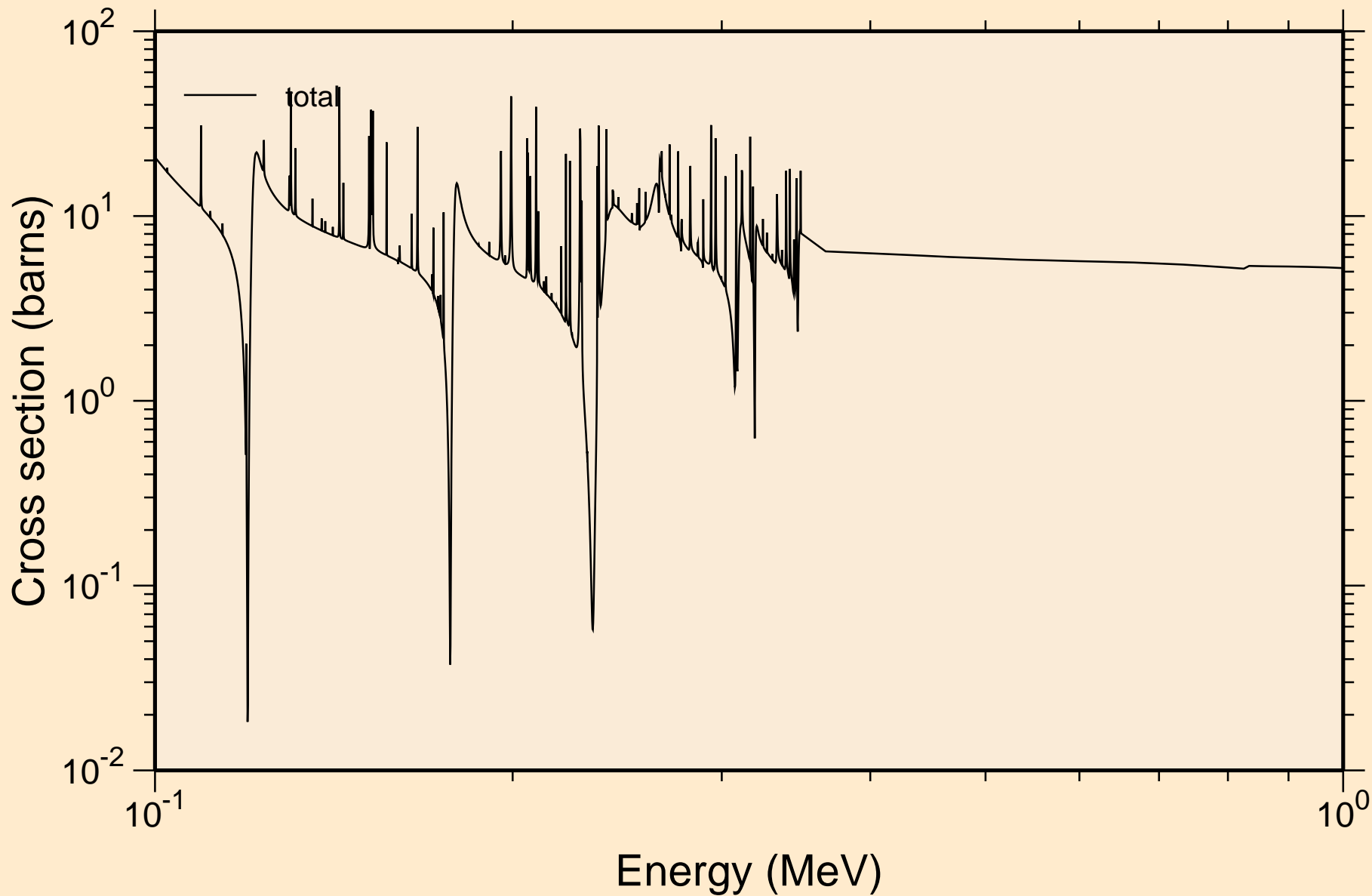

MAT=2637 ACE FILE PRODUCED AT NEA WITH NDEC  
resonance total cross section

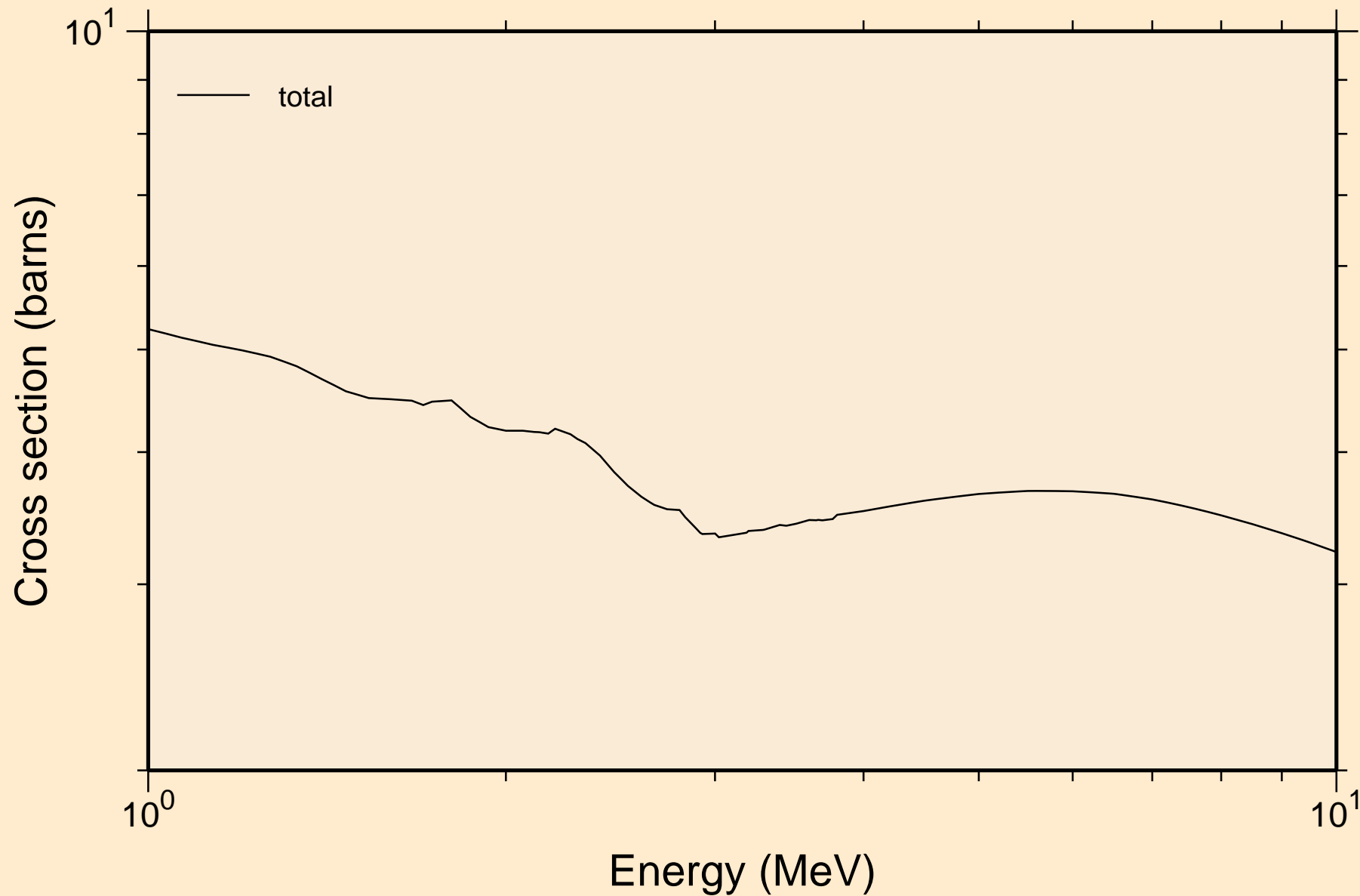

MAT=2637 ACE FILE PRODUCED AT NEA WITH NDEC  
resonance absorption cross sections

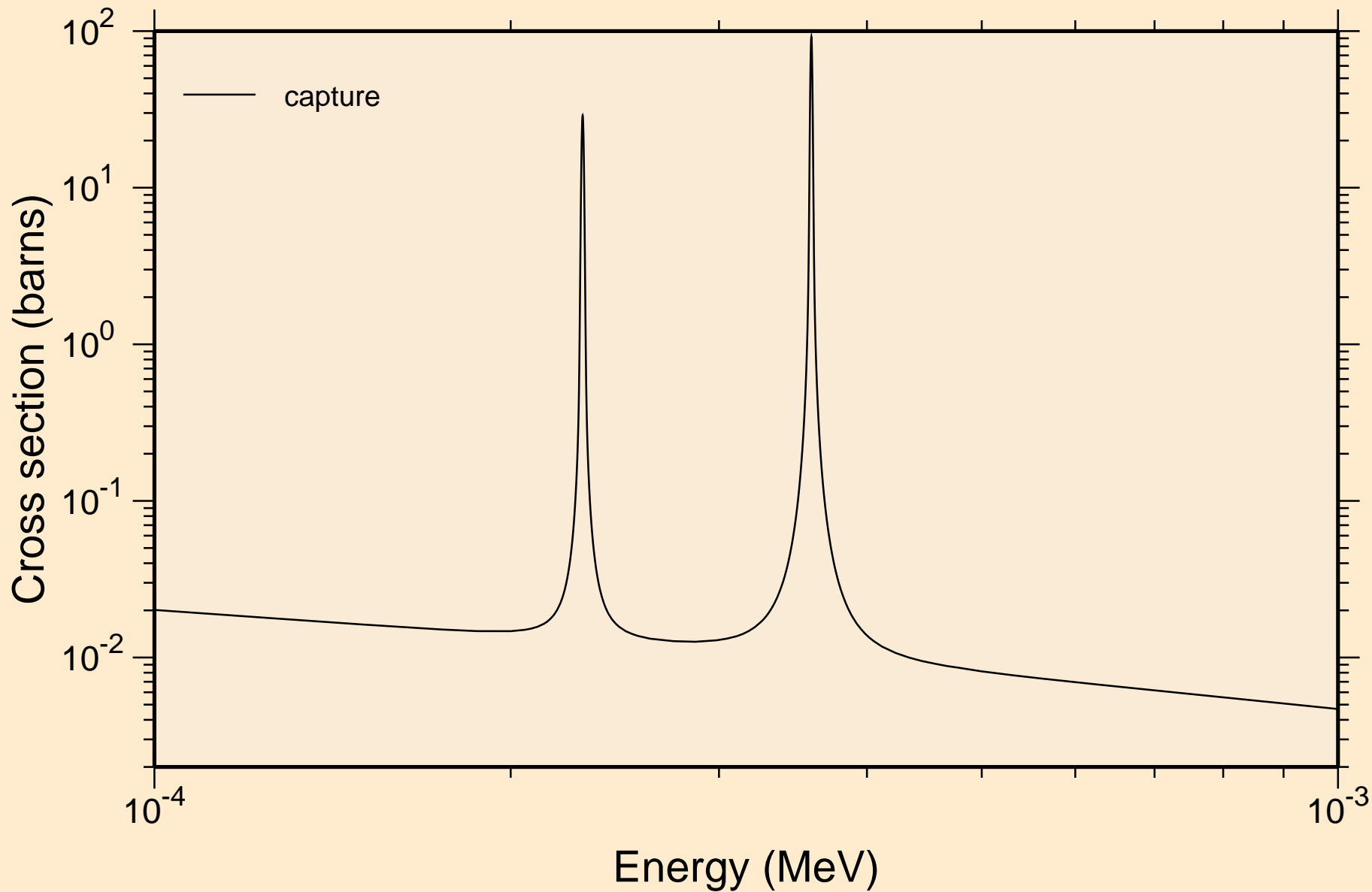

MAT=2637 ACE FILE PRODUCED AT NEA WITH NDEC  
resonance absorption cross sections

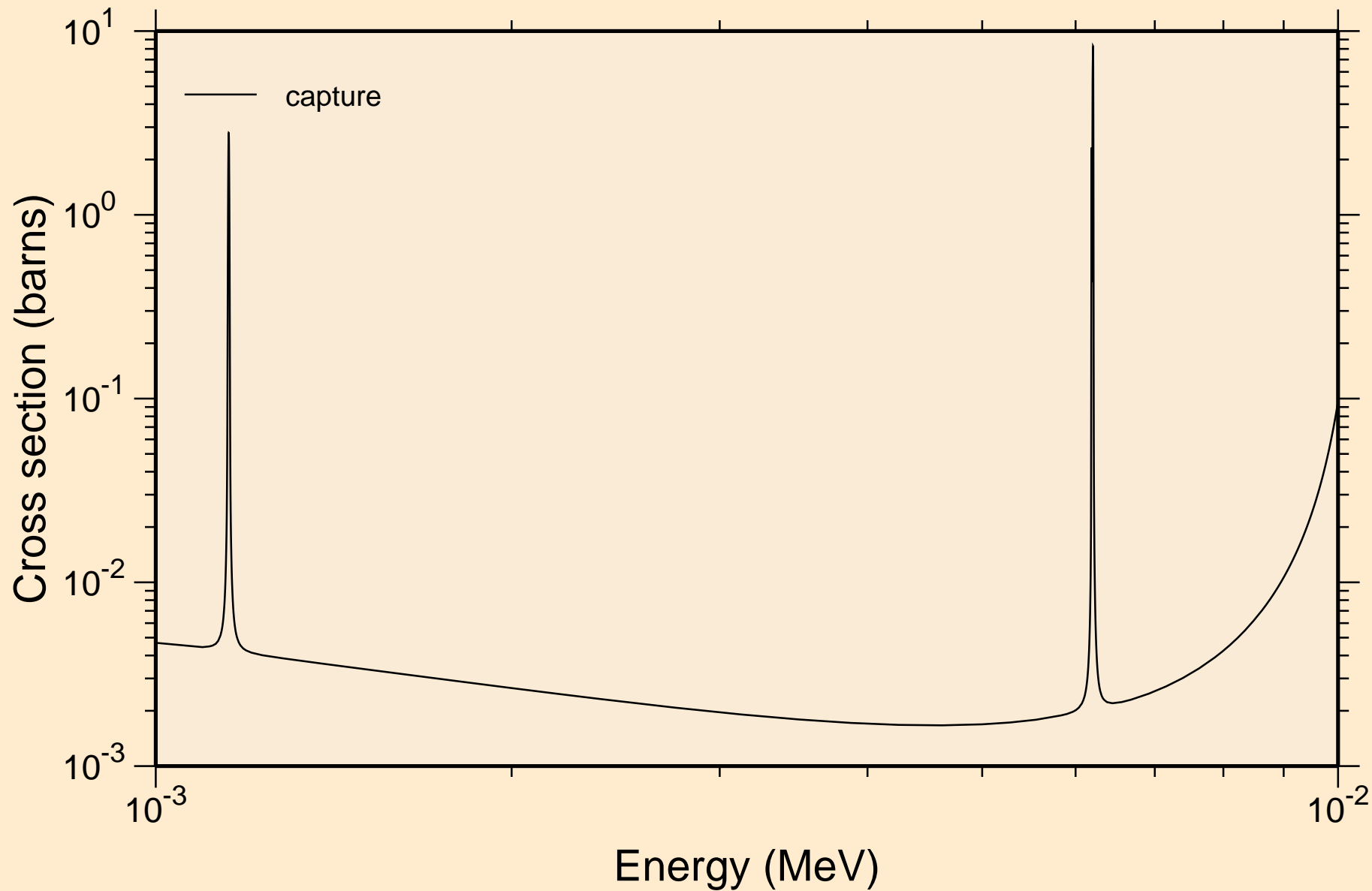



MAT=2637 ACE FILE PRODUCED AT NEA WITH NDEC  
resonance absorption cross sections

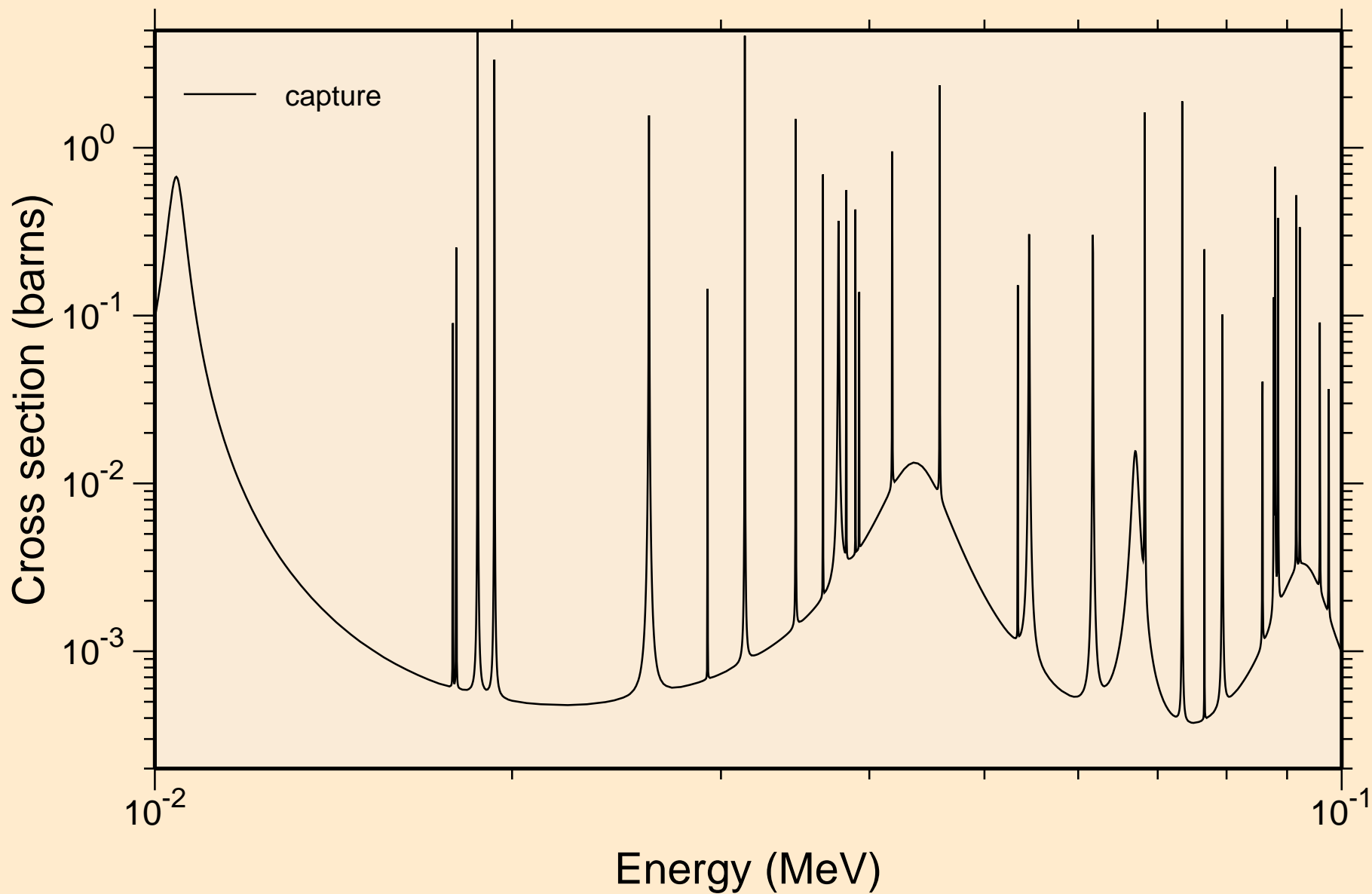

MAT=2637 ACE FILE PRODUCED AT NEA WITH NDEC  
resonance absorption cross sections

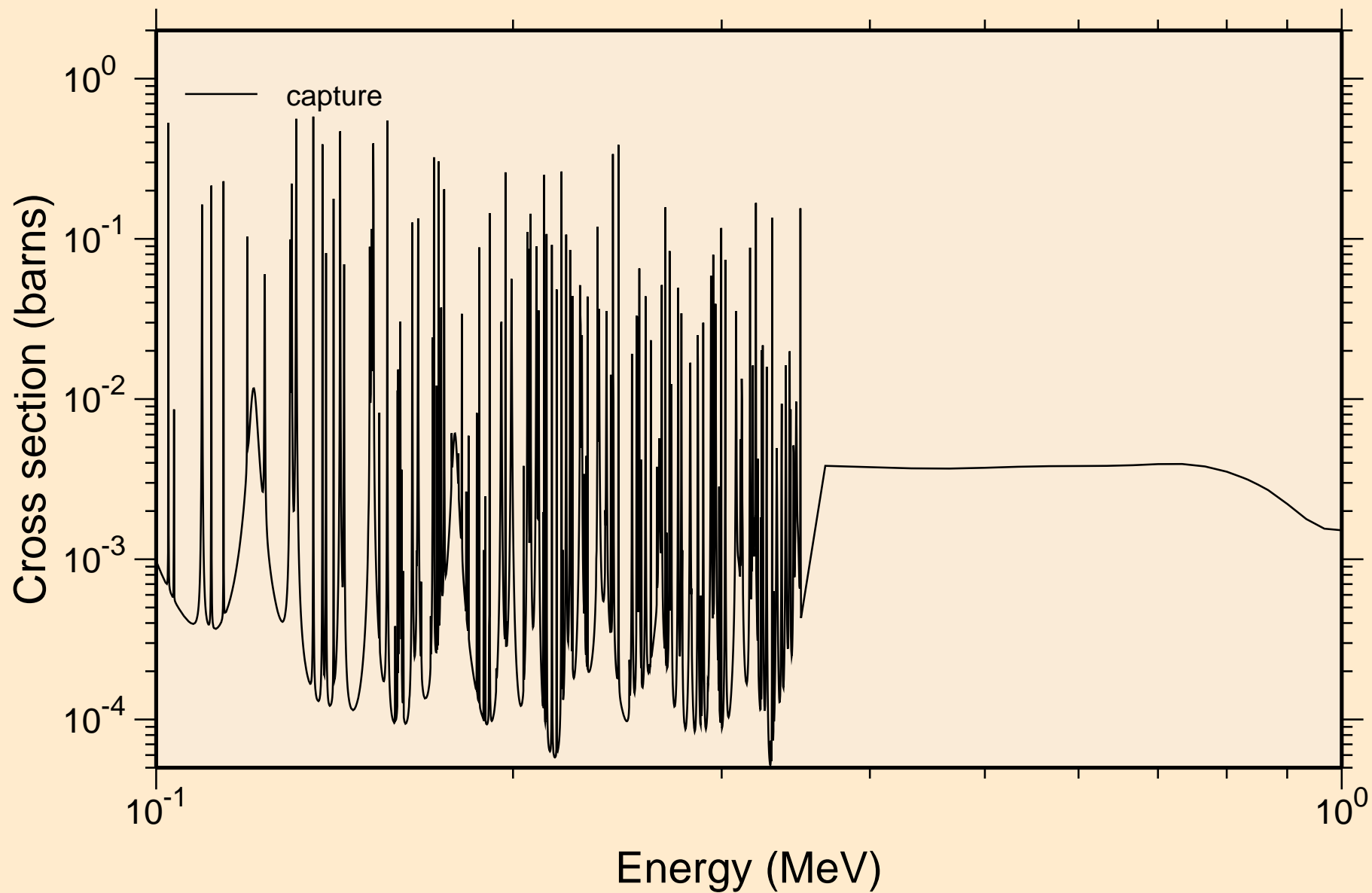

MAT=2637 ACE FILE PRODUCED AT NEA WITH NDEC  
resonance absorption cross sections

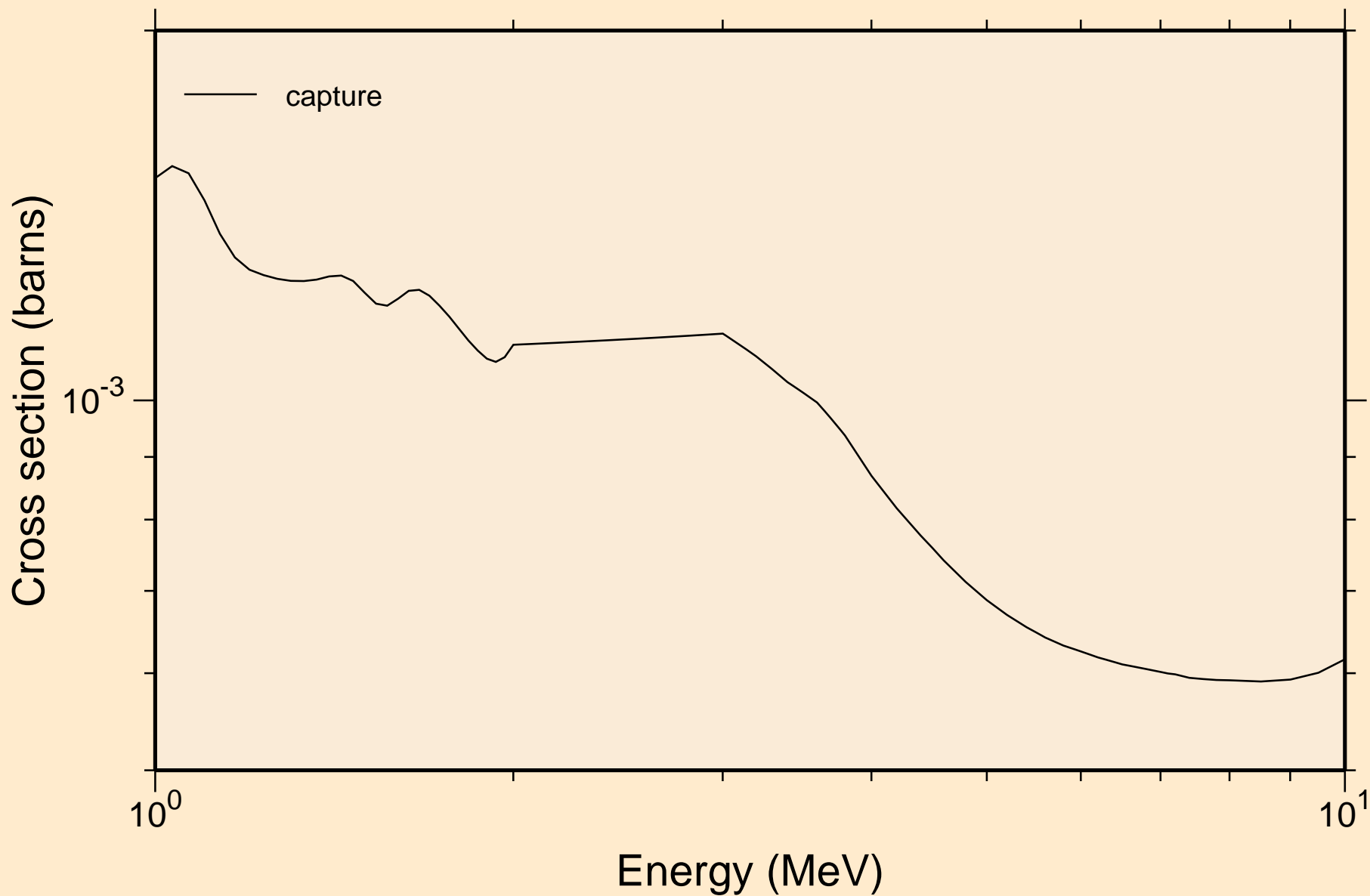

MAT=2637 ACE FILE PRODUCED AT NEA WITH NDEC  
UR total cross section

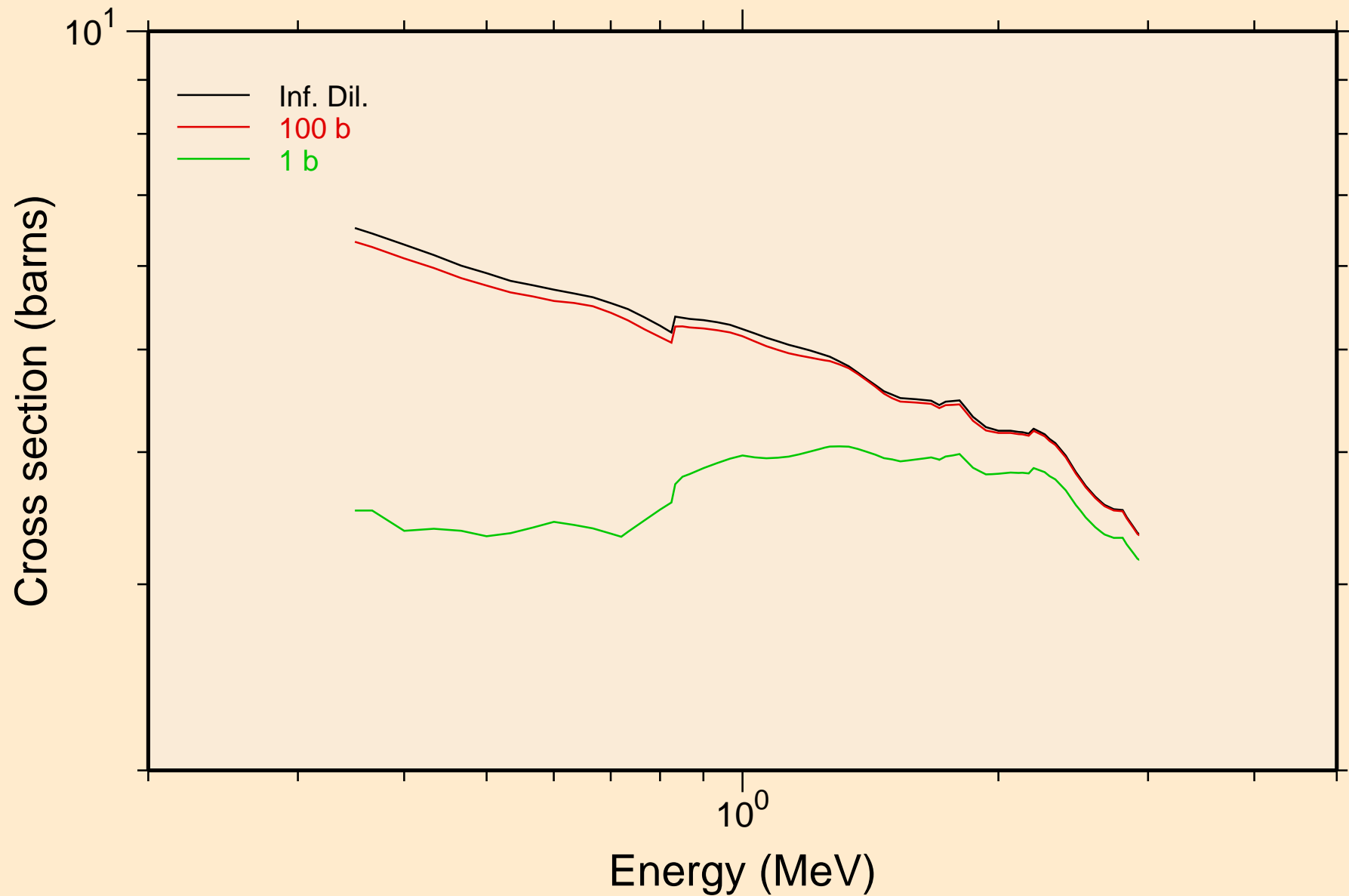

MAT=2637 ACE FILE PRODUCED AT NEA WITH NDEC  
UR elastic cross section

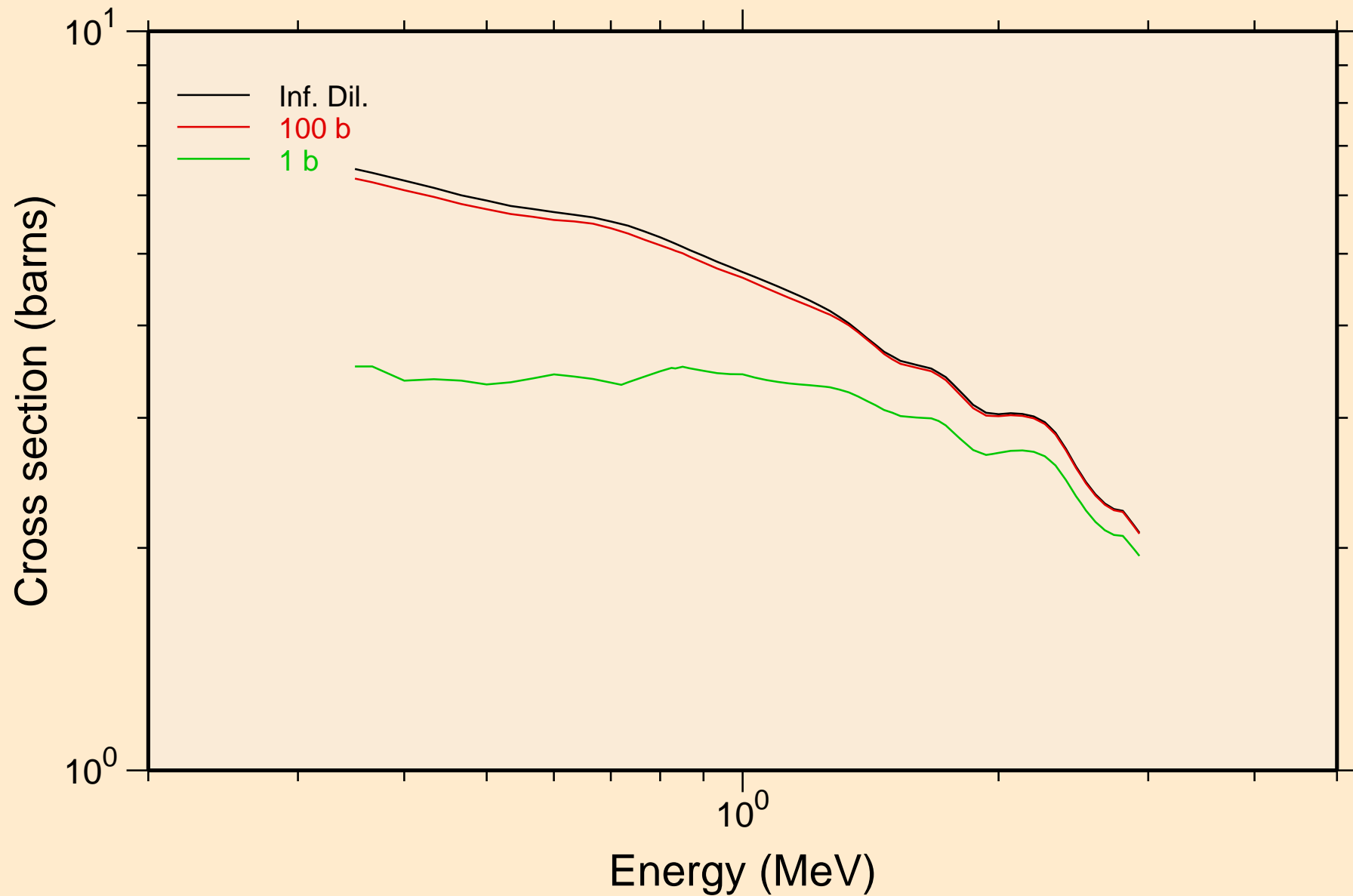

MAT=2637 ACE FILE PRODUCED AT NEA WITH NDEC  
UR capture cross section

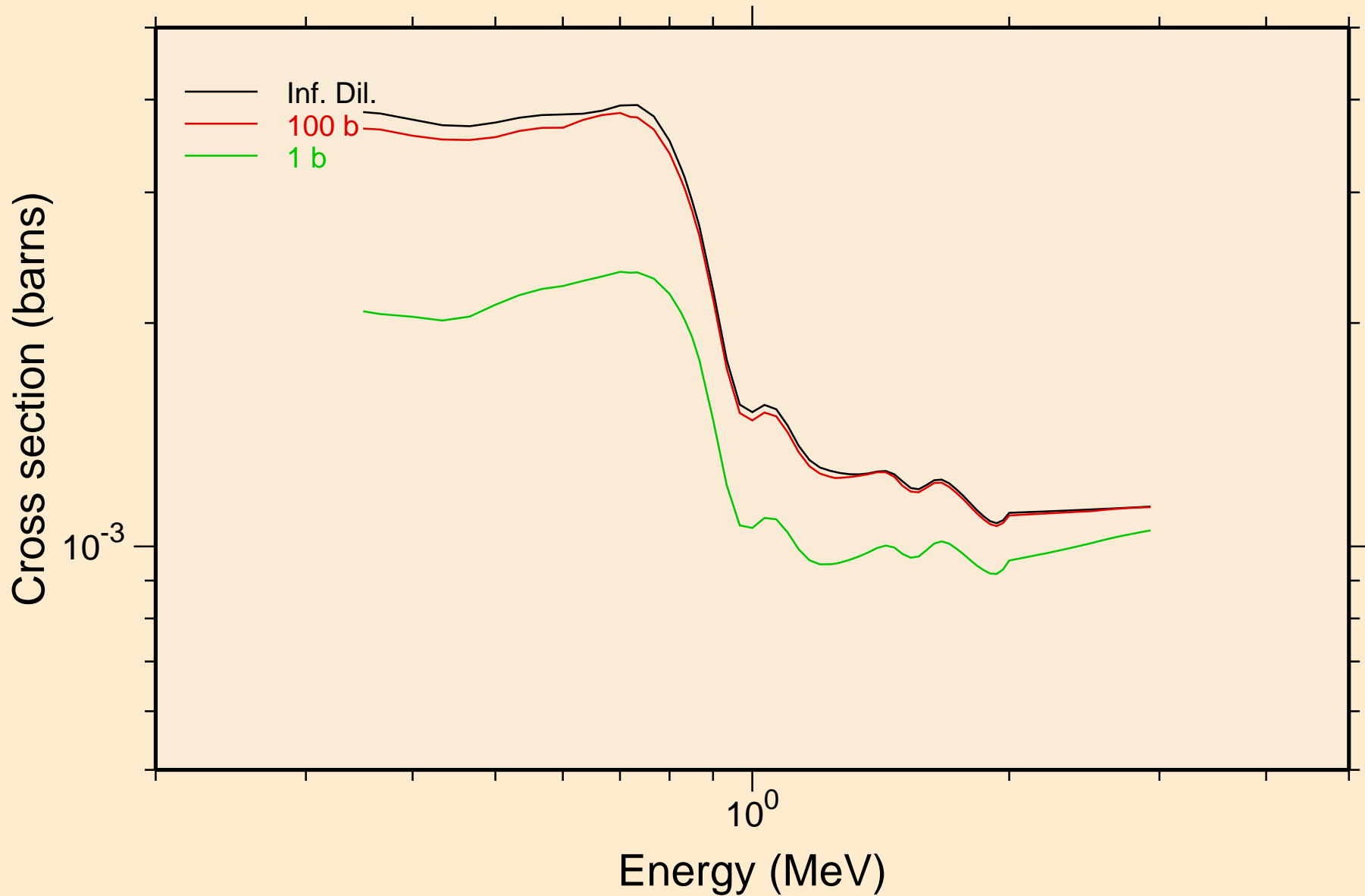

MAT=2637 ACE FILE PRODUCED AT NEA WITH NDEC  
Heating

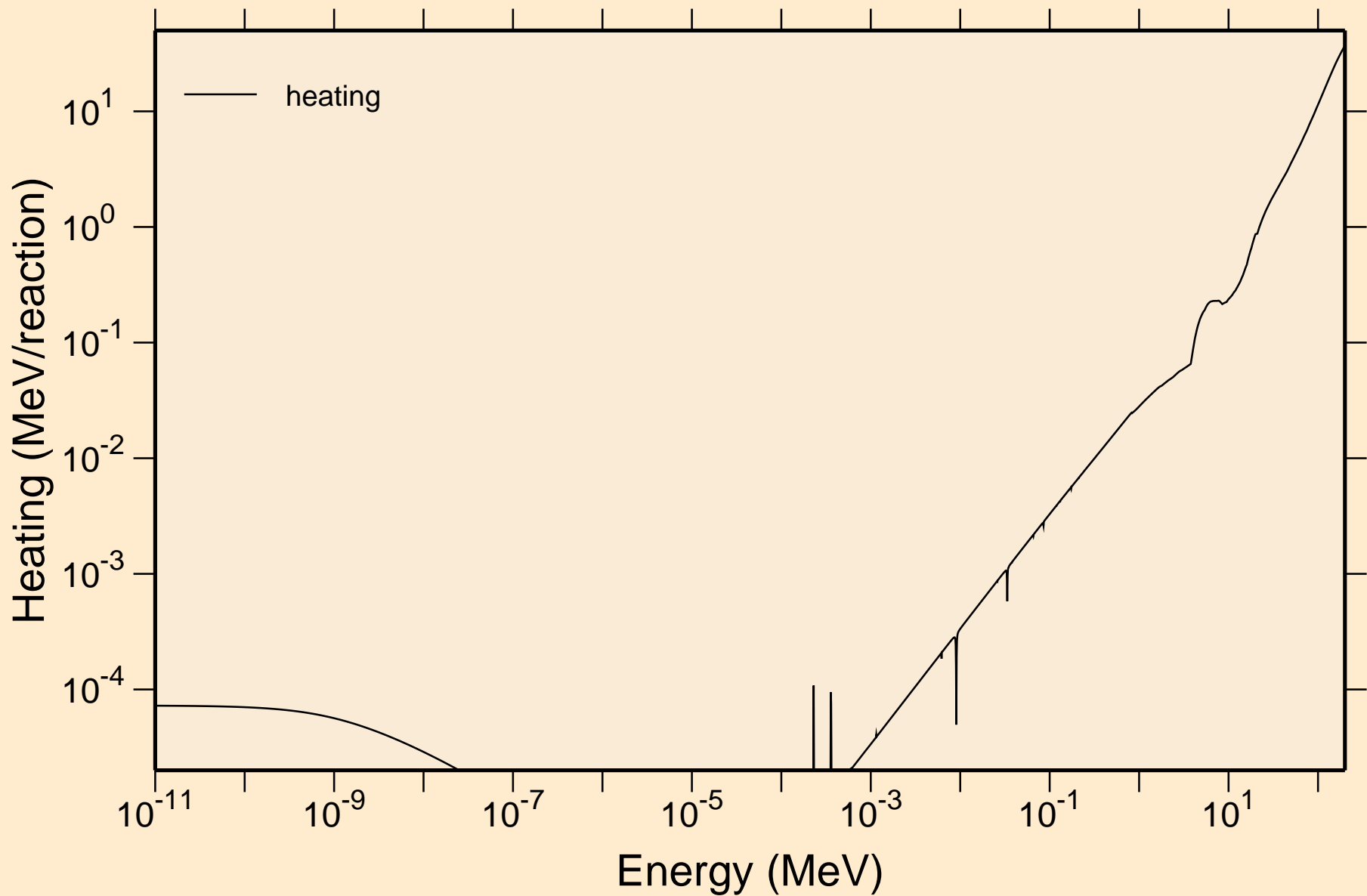

MAT=2637 ACE FILE PRODUCED AT NEA WITH NDEC  
Damage

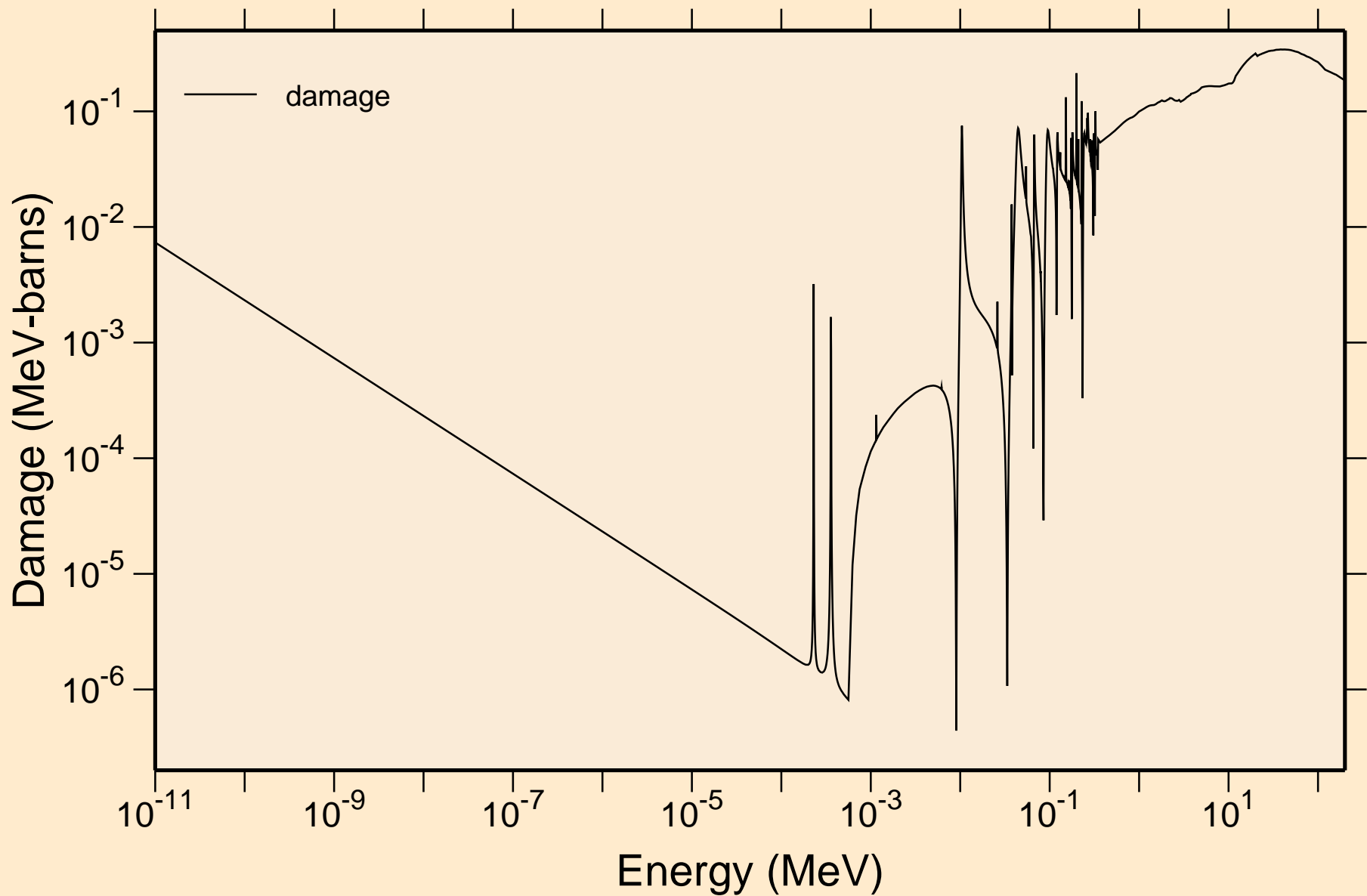



MAT=2637 ACE FILE PRODUCED AT NEA WITH NDEC  
Non-threshold reactions

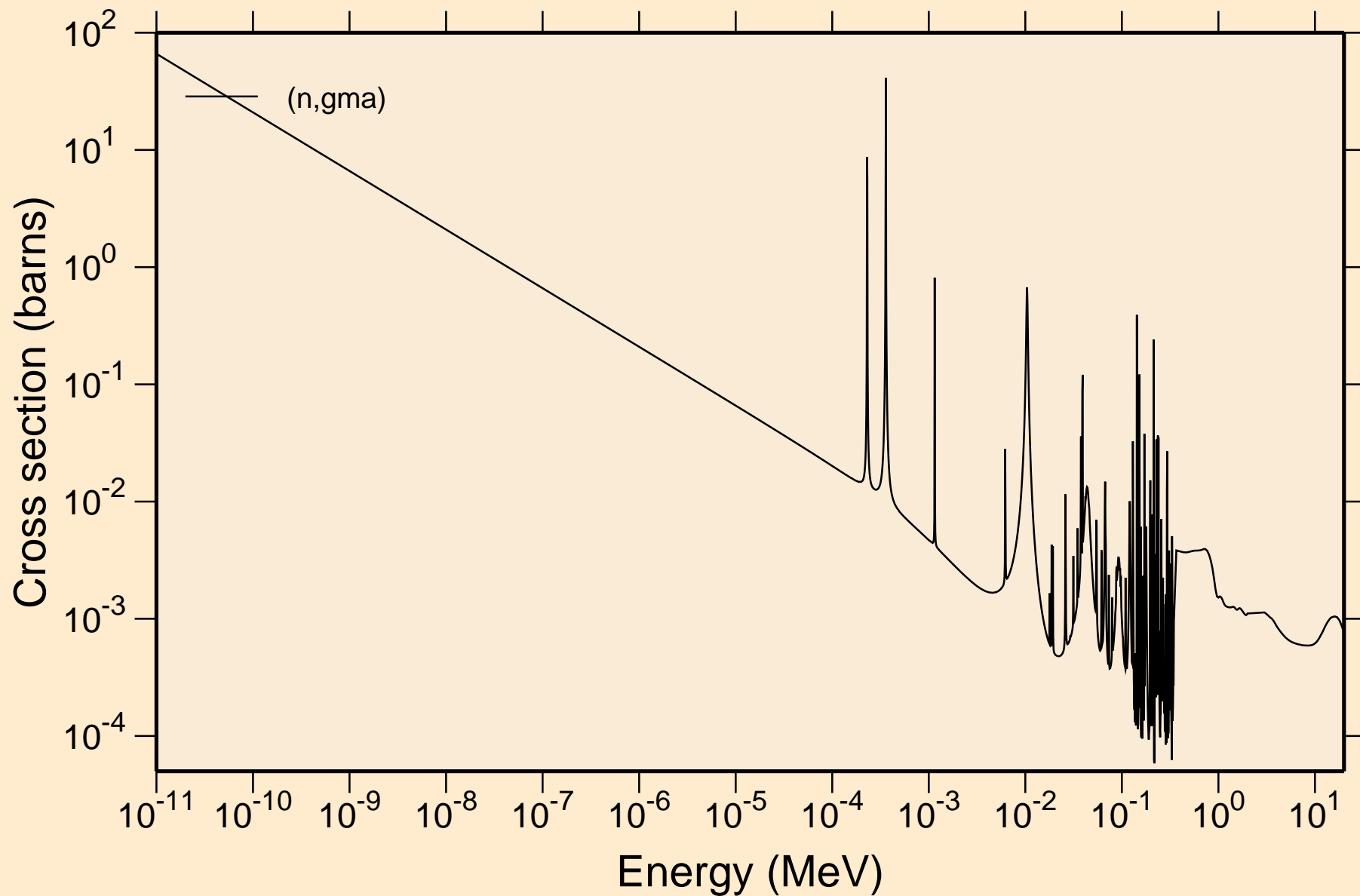

MAT=2637 ACE FILE PRODUCED AT NEA WITH NDEC

Principal cross sections

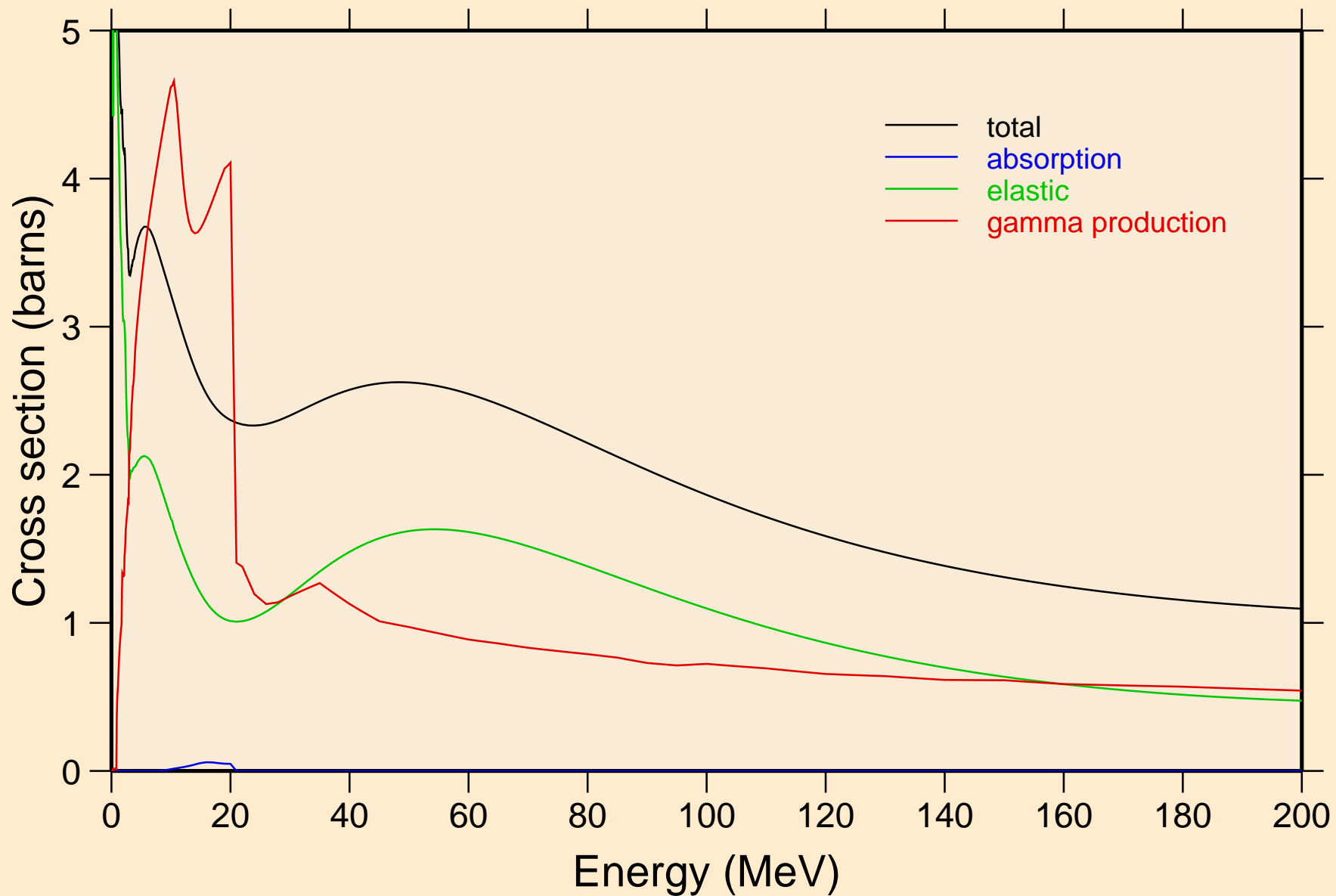

MAT=2637 ACE FILE PRODUCED AT NEA WITH NDEC  
Heating

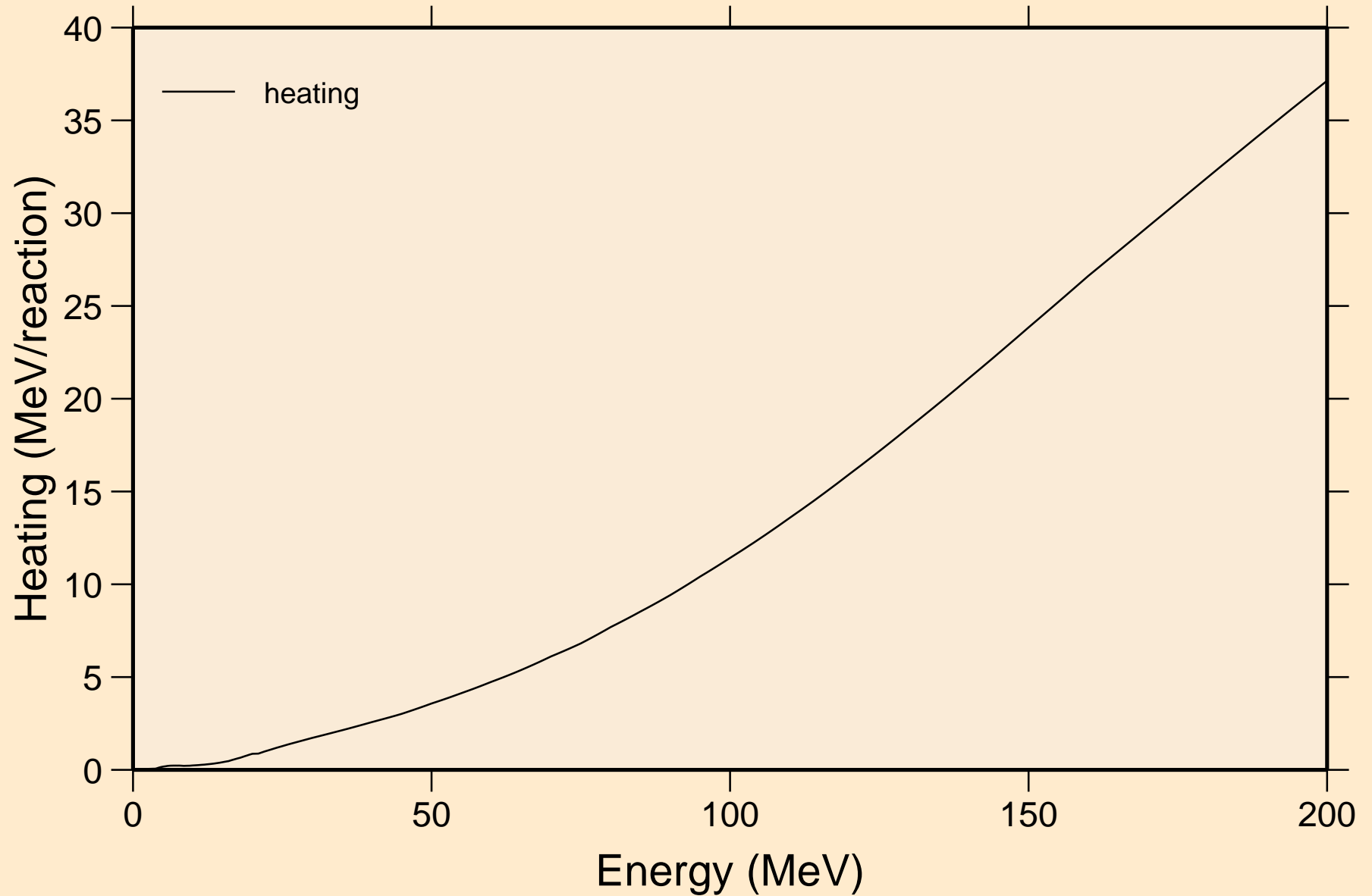

MAT=2637 ACE FILE PRODUCED AT NEA WITH NDEC  
Damage

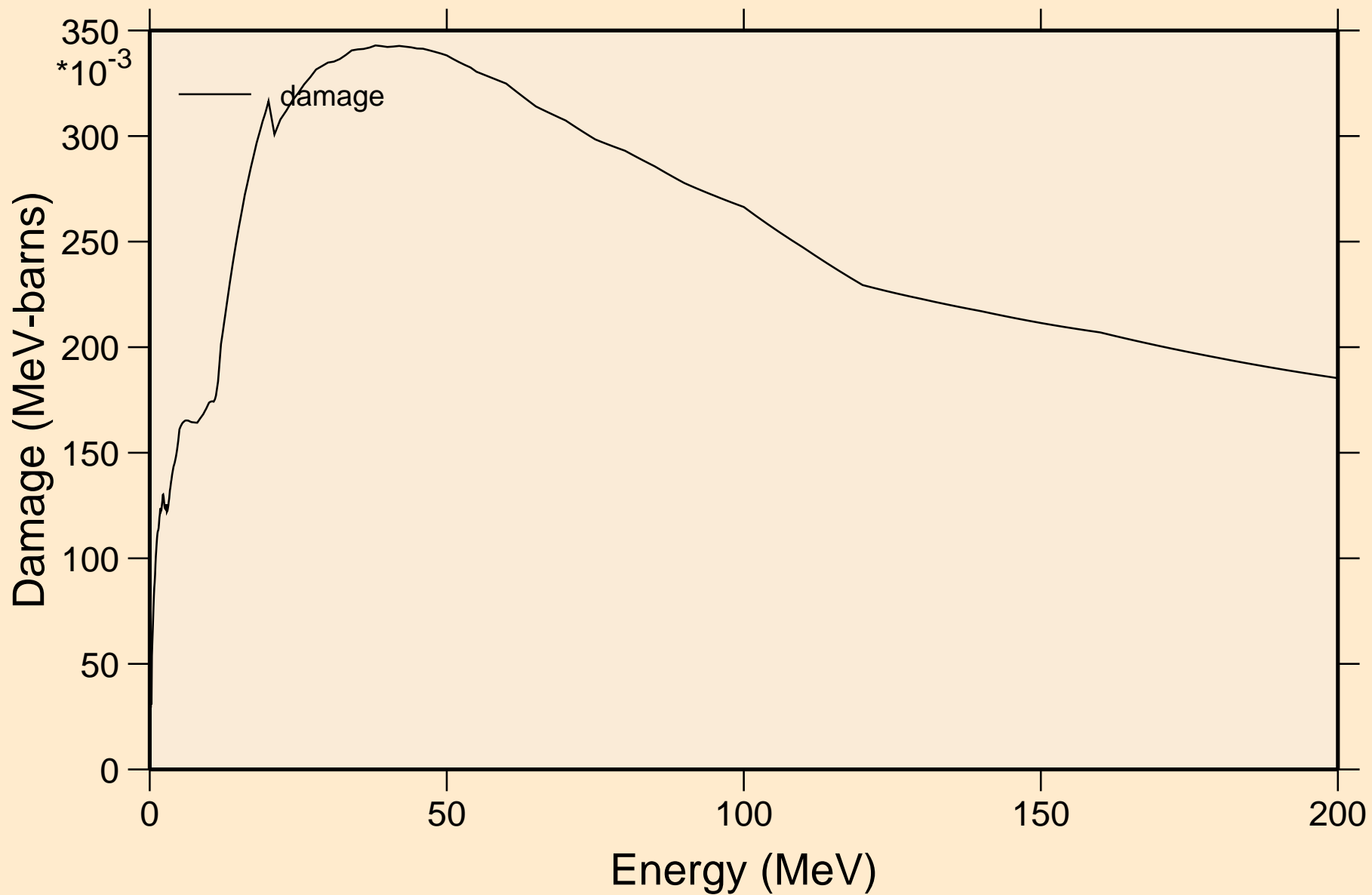

MAT=2637 ACE FILE PRODUCED AT NEA WITH NDEC  
Non-threshold reactions

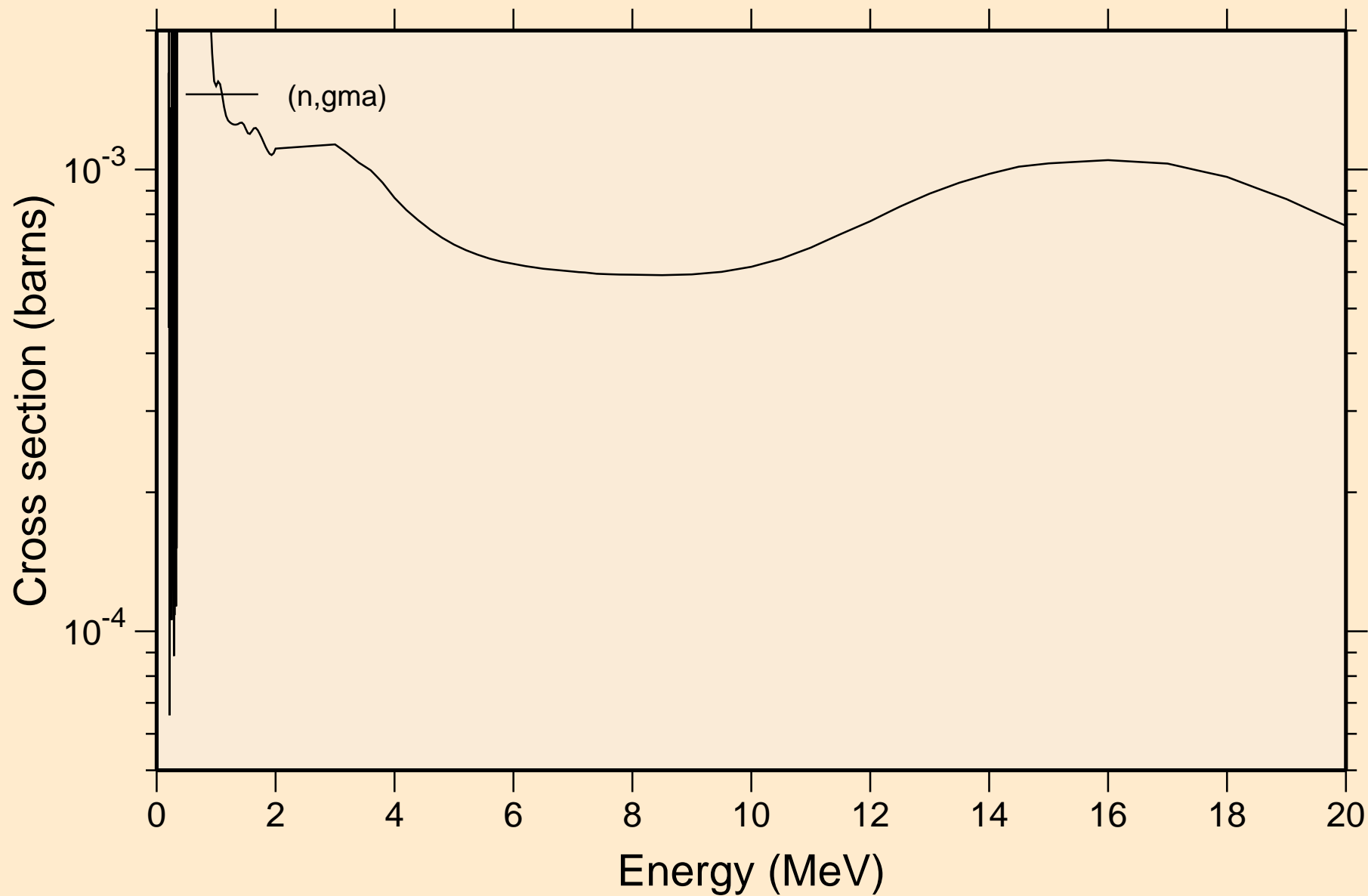

MAT=2637 ACE FILE PRODUCED AT NEA WITH NDEC  
Inelastic levels

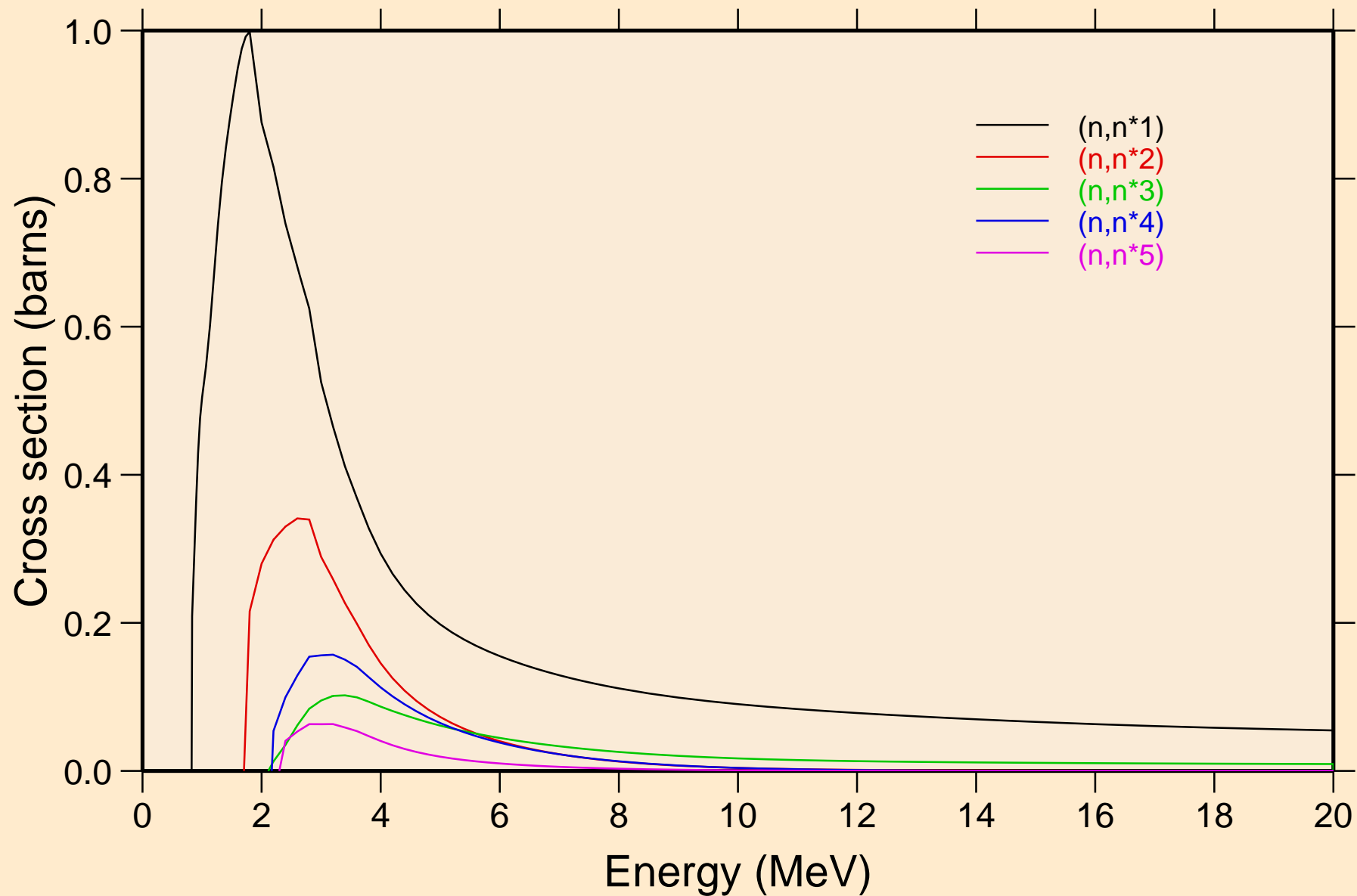

MAT=2637 ACE FILE PRODUCED AT NEA WITH NDEC  
Inelastic levels

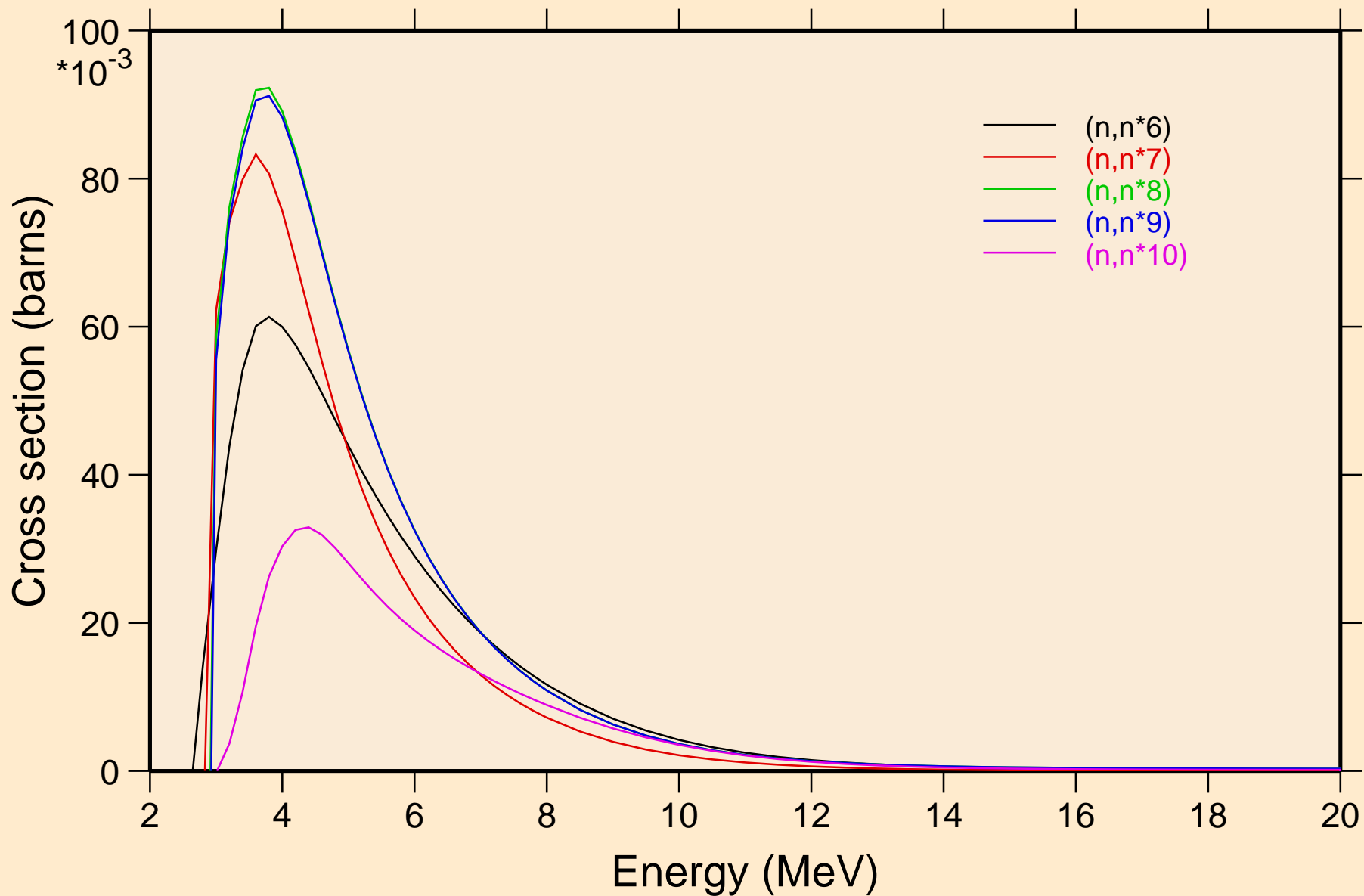

MAT=2637 ACE FILE PRODUCED AT NEA WITH NDEC  
Inelastic levels

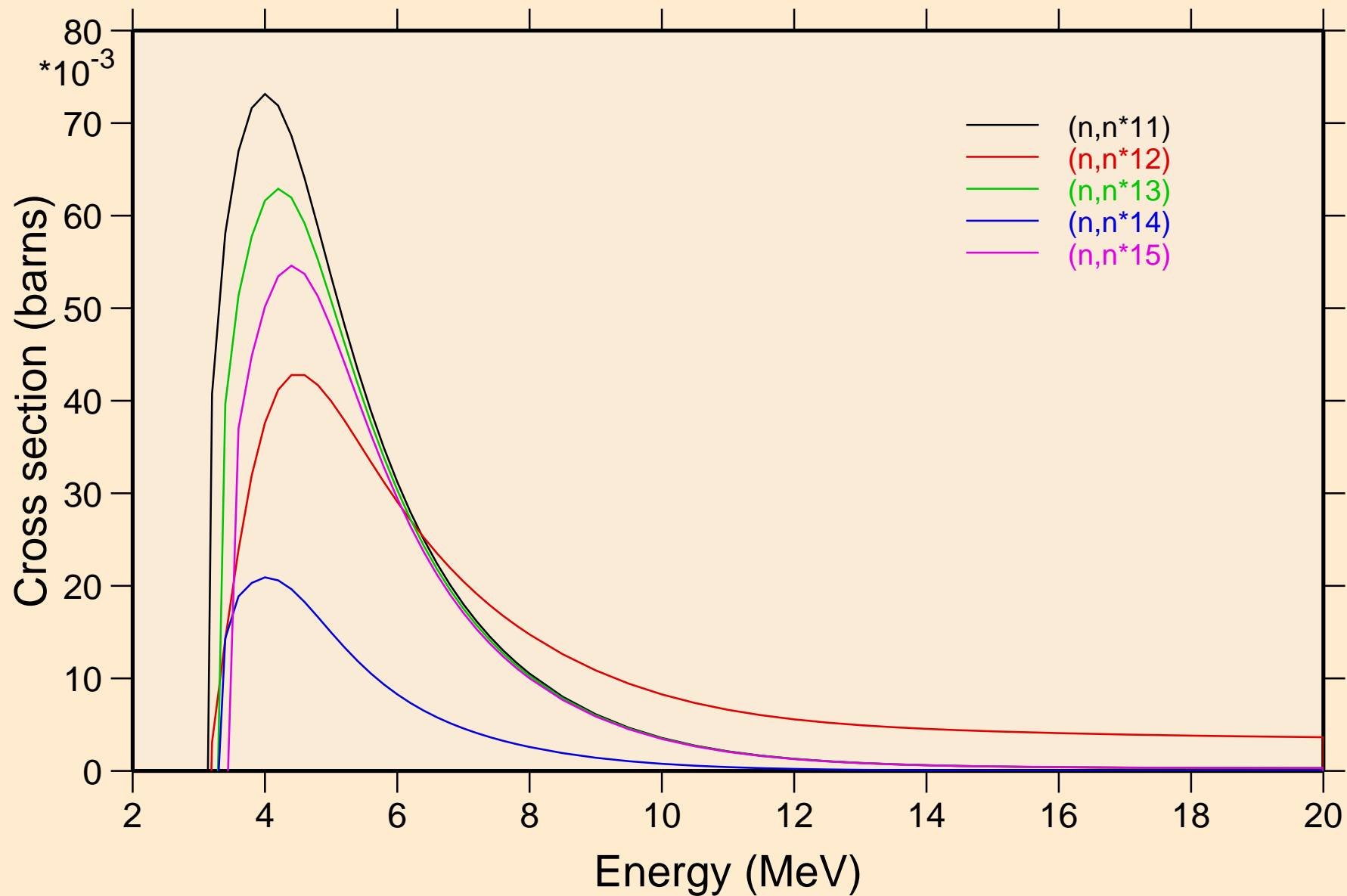



MAT=2637 ACE FILE PRODUCED AT NEA WITH NDEC  
Inelastic levels

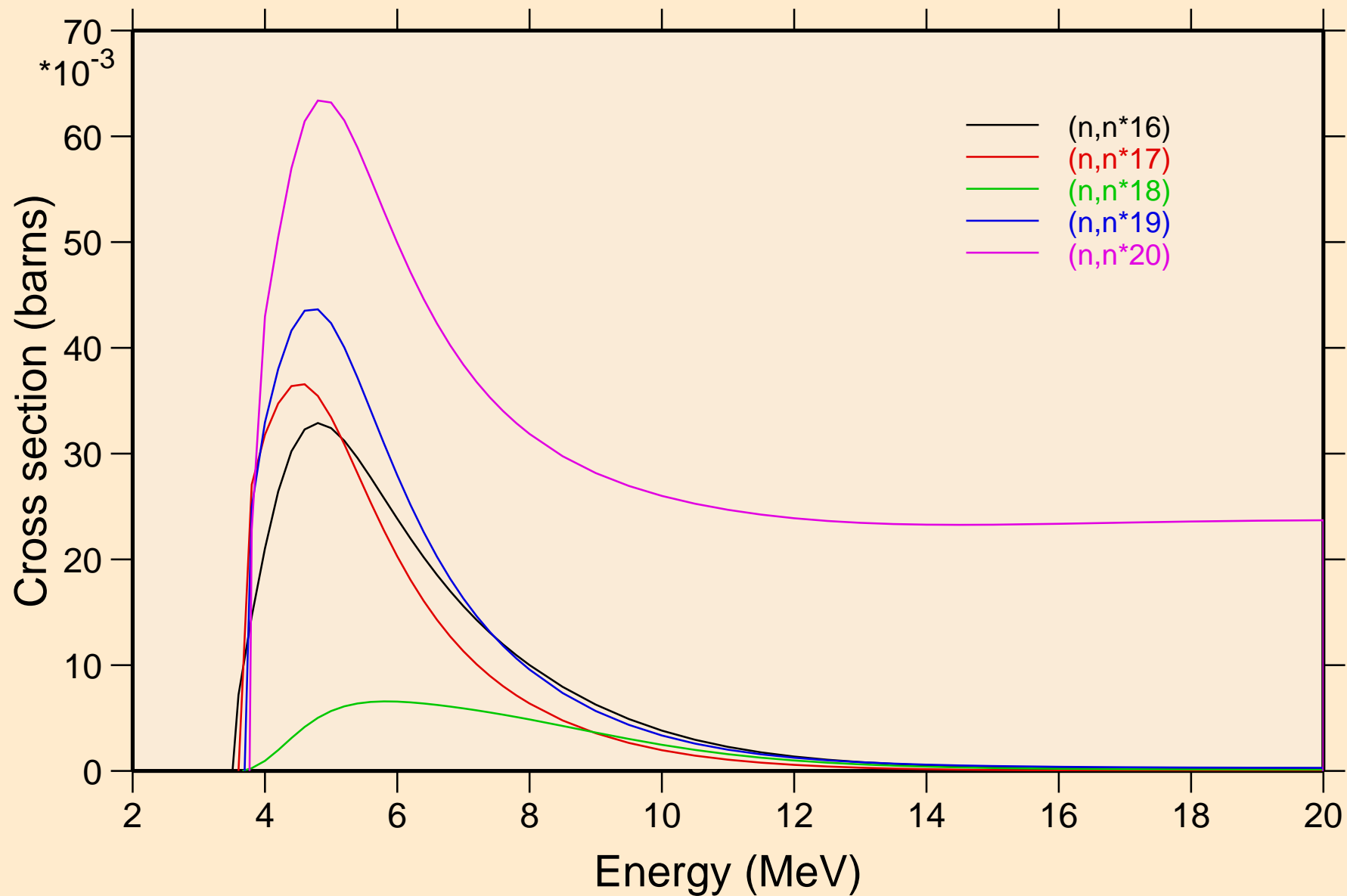

MAT=2637 ACE FILE PRODUCED AT NEA WITH NDEC  
Threshold reactions

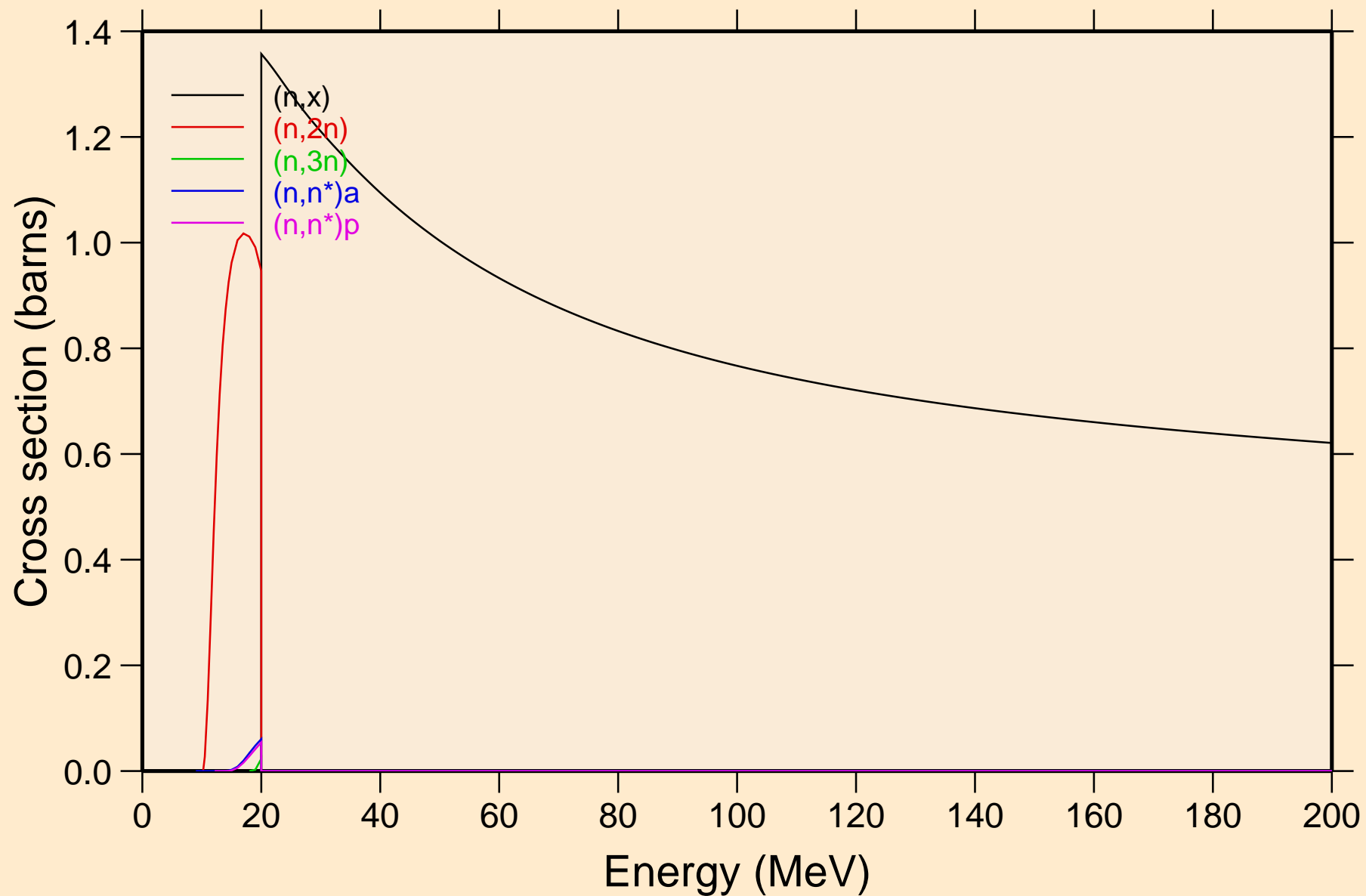

MAT=2637 ACE FILE PRODUCED AT NEA WITH NDEC  
Threshold reactions

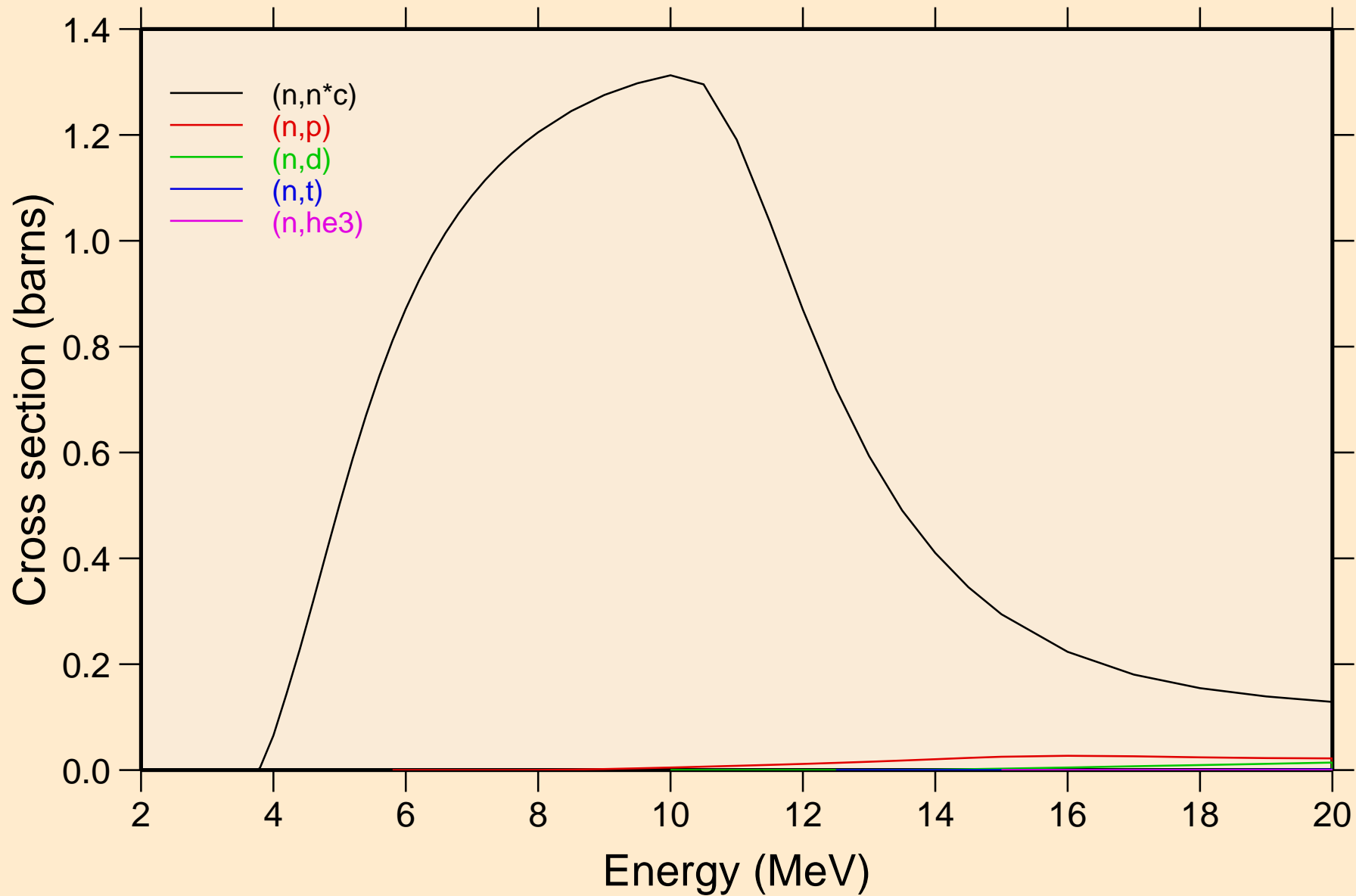

MAT=2637 ACE FILE PRODUCED AT NEA WITH NDEC  
Threshold reactions

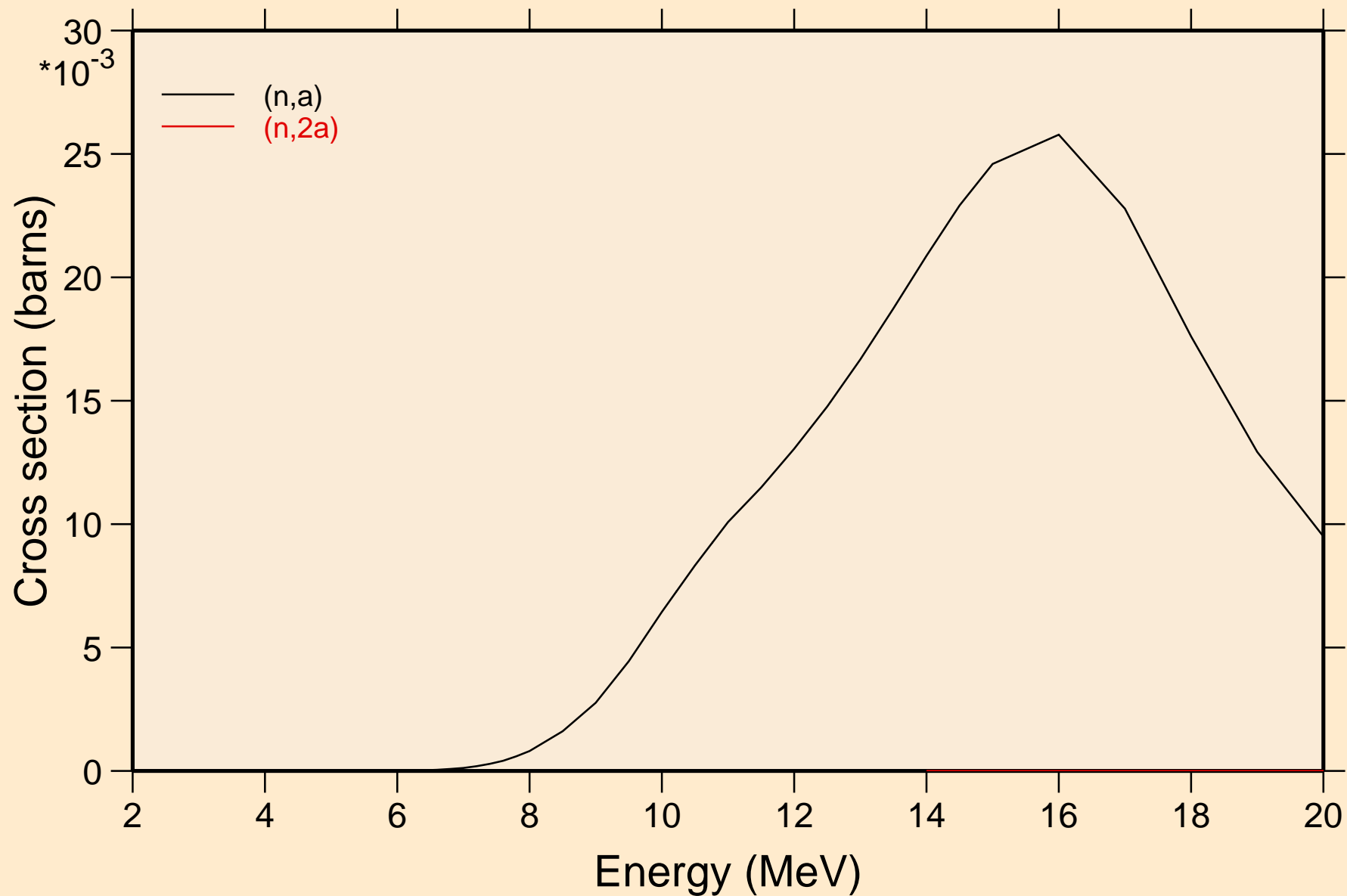

MAT=2637 ACE FILE PRODUCED AT NEA WITH NDEC  
Threshold reactions

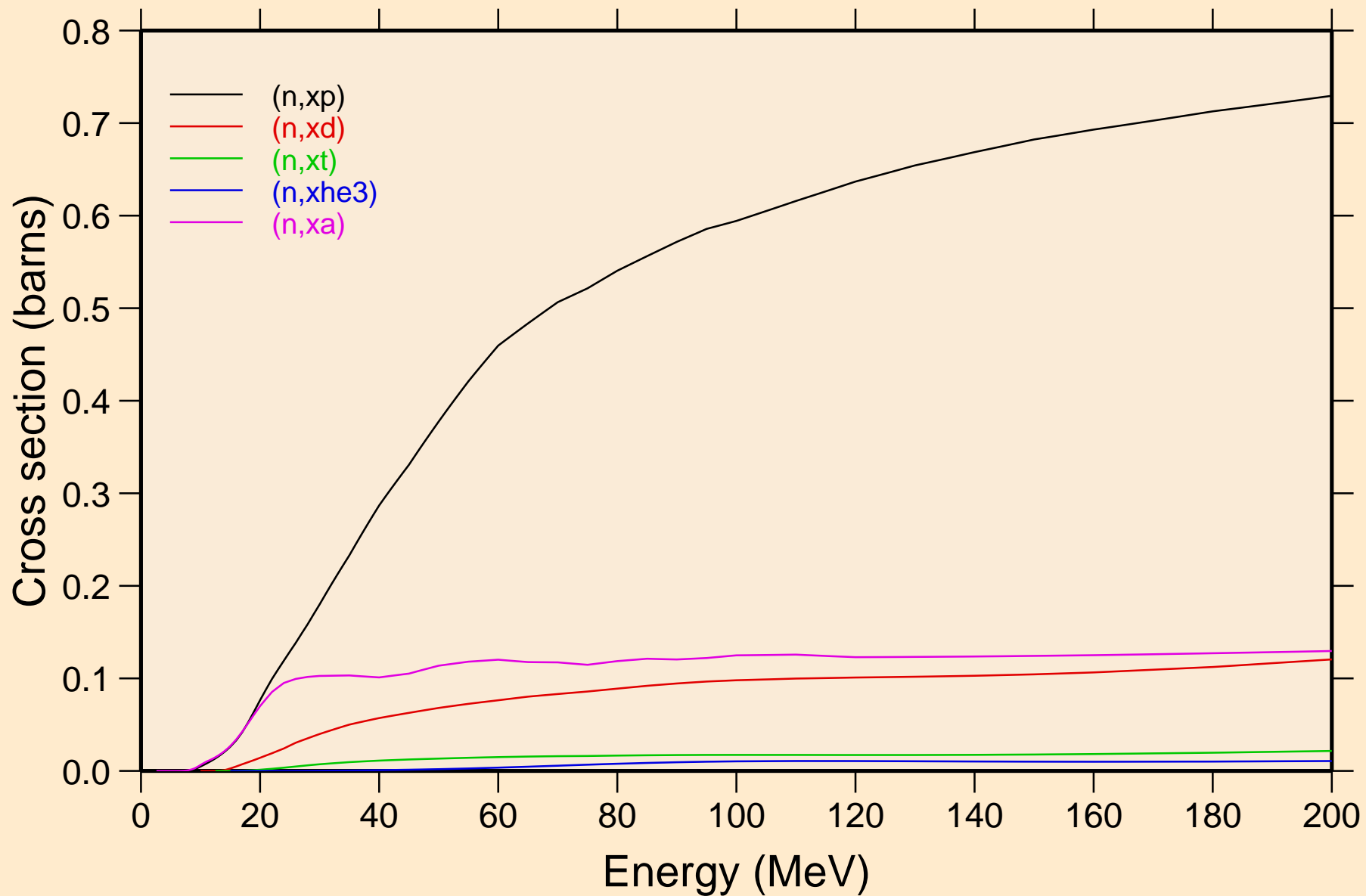

MAT=2637 ACE FILE PRODUCED AT NEA WITH NDEC  
Threshold reactions

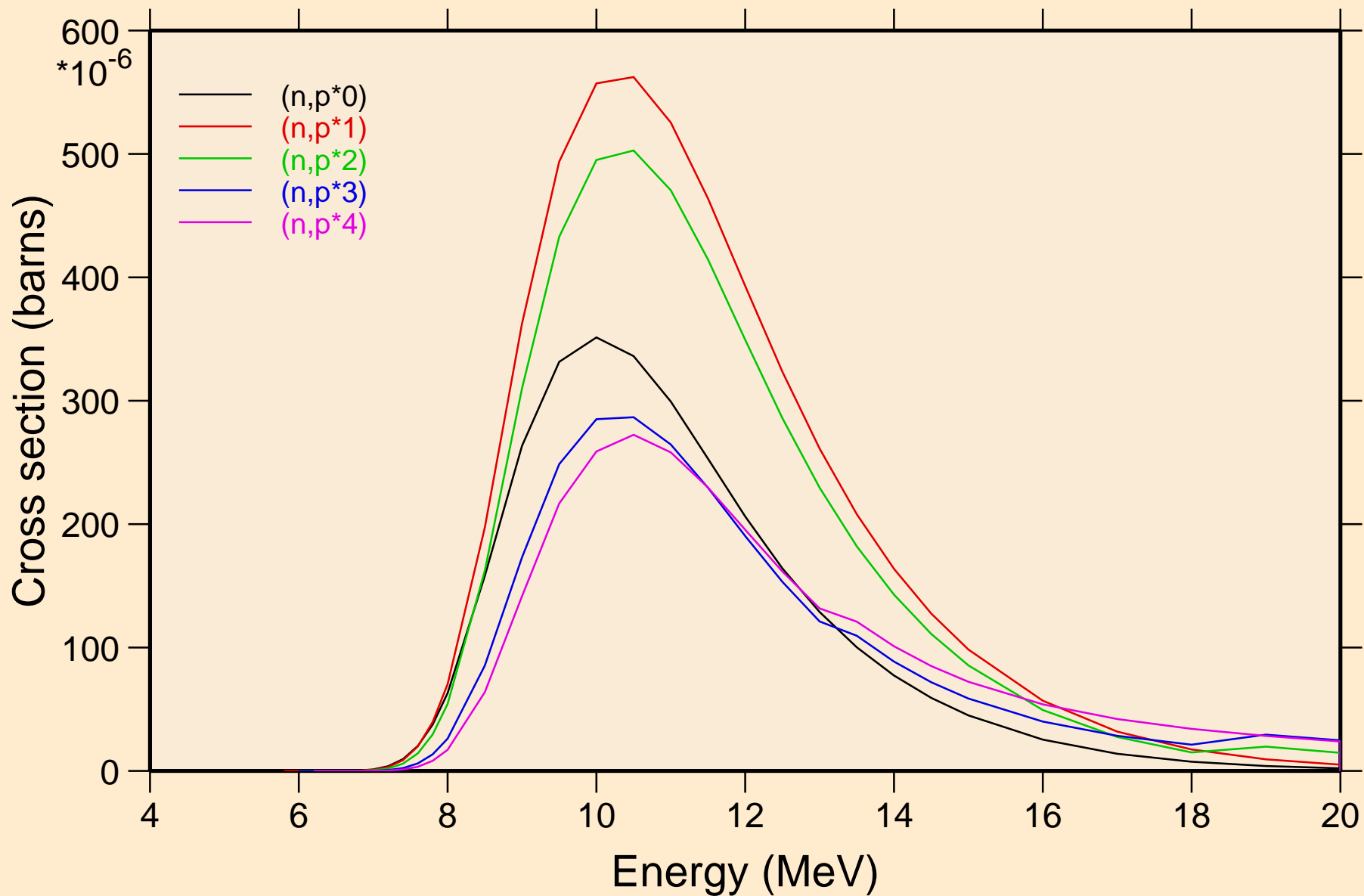

MAT=2637 ACE FILE PRODUCED AT NEA WITH NDEC  
Threshold reactions

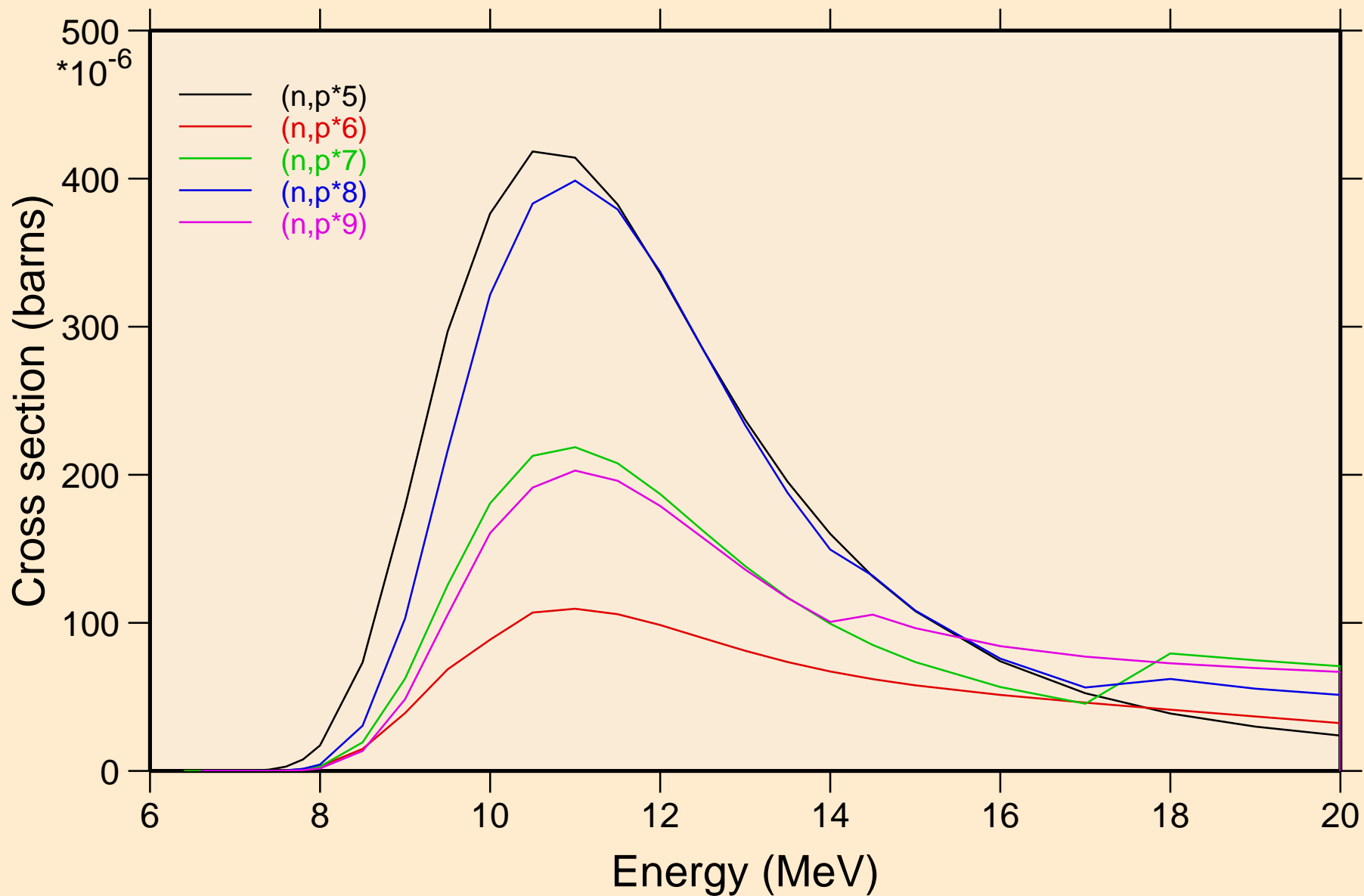

MAT=2637 ACE FILE PRODUCED AT NEA WITH NDEC  
Threshold reactions

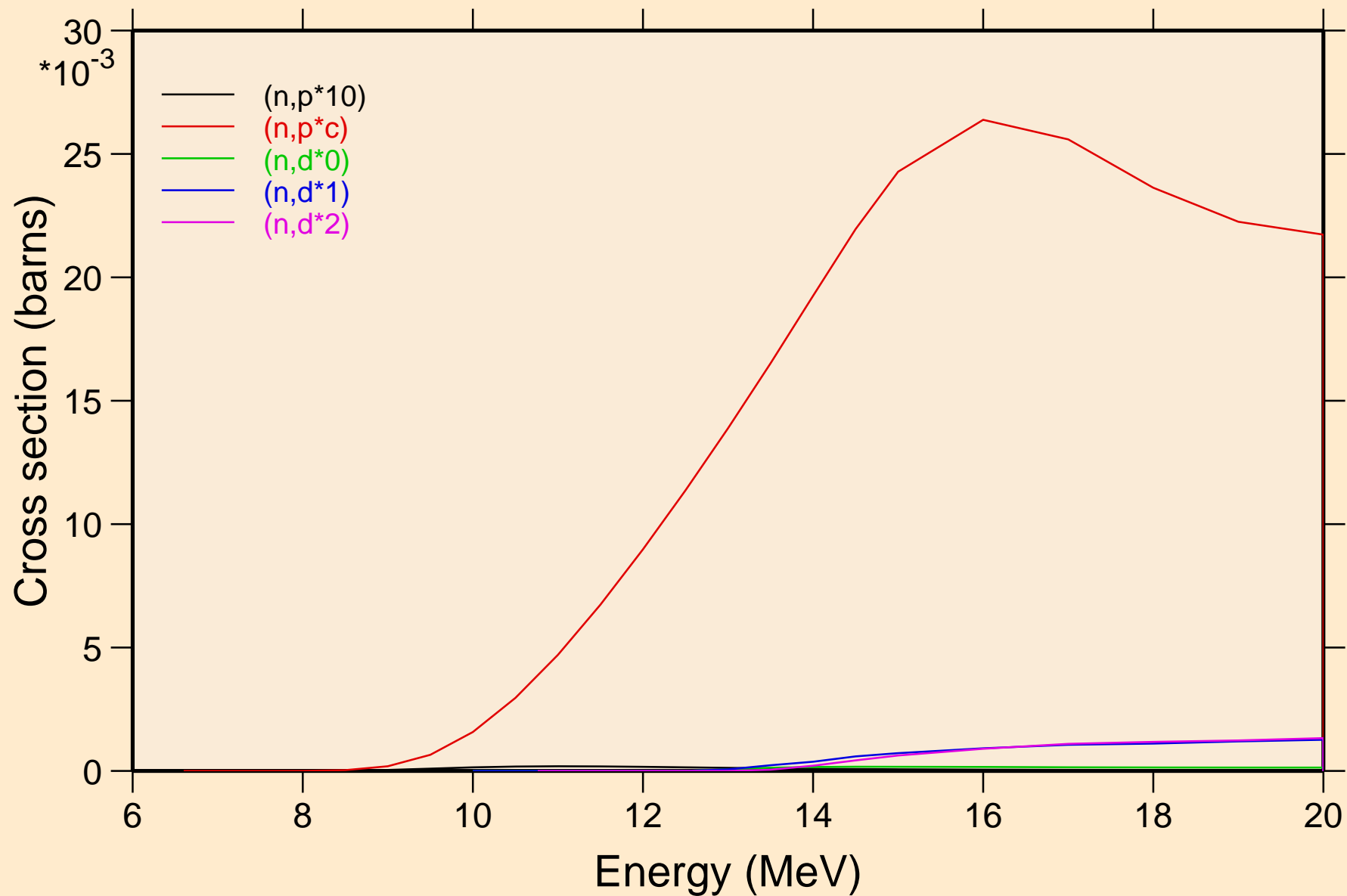



MAT=2637 ACE FILE PRODUCED AT NEA WITH NDEC  
Threshold reactions

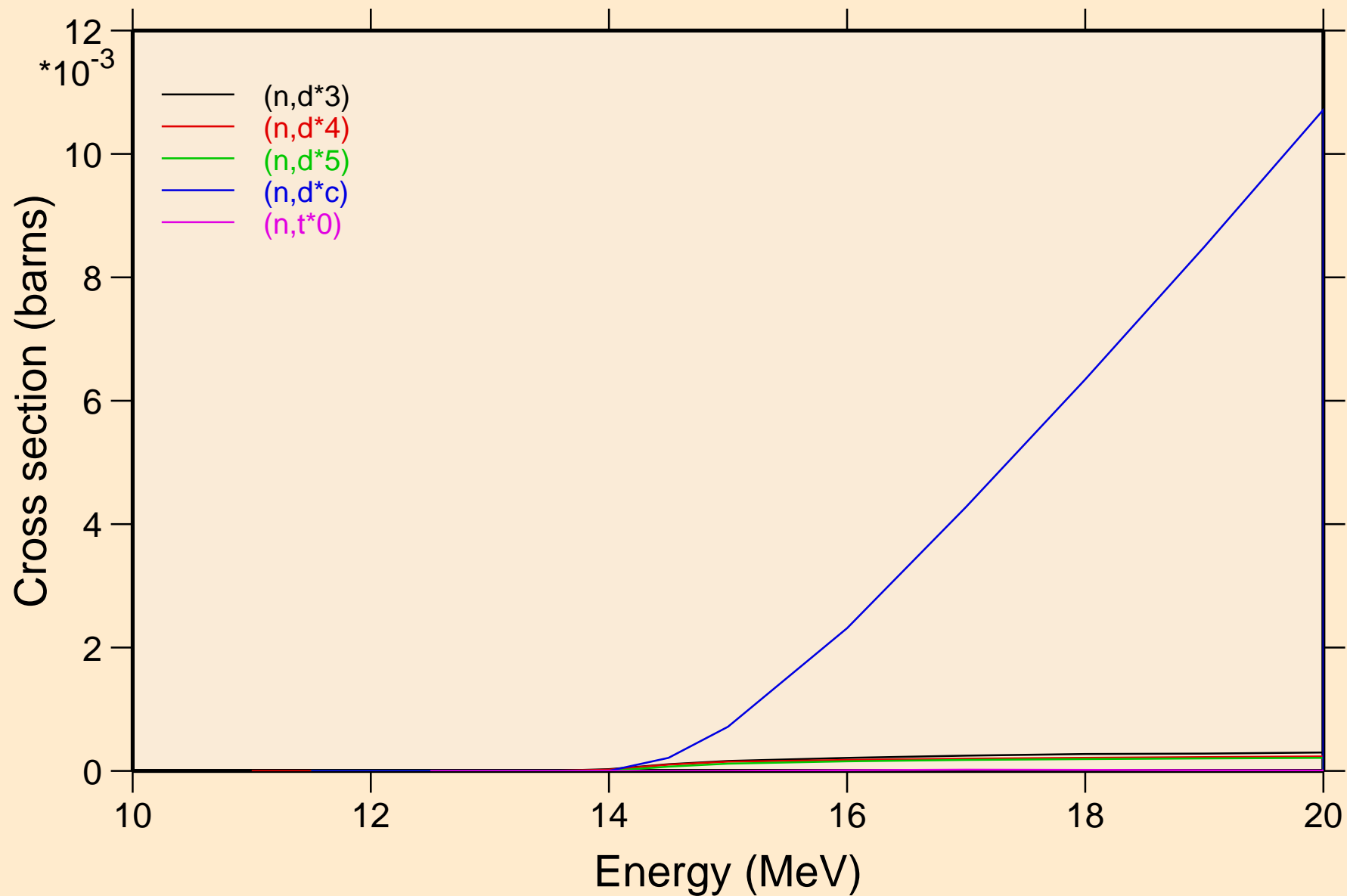

MAT=2637 ACE FILE PRODUCED AT NEA WITH NDEC  
Threshold reactions

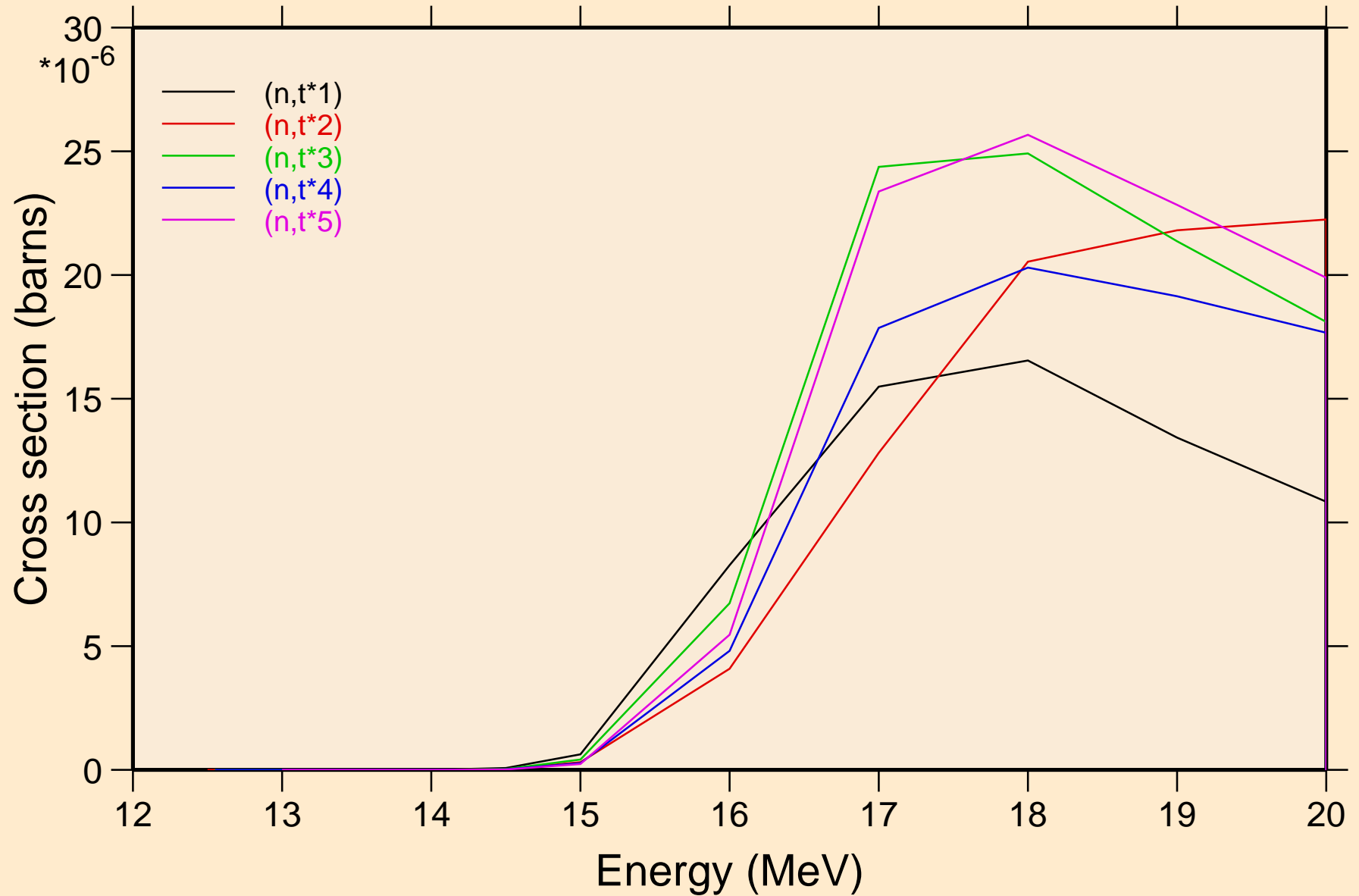

MAT=2637 ACE FILE PRODUCED AT NEA WITH NDEC  
Threshold reactions

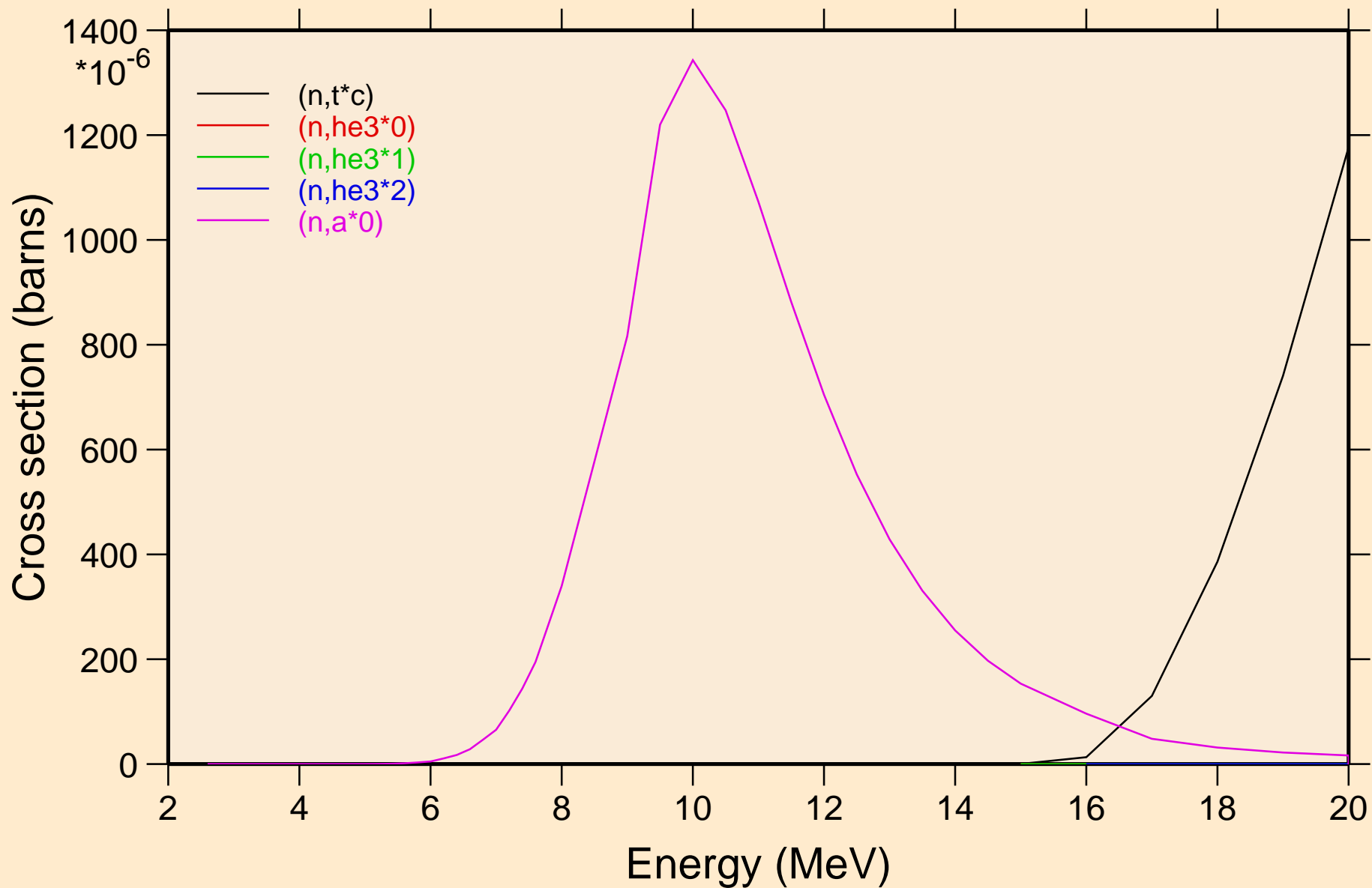

MAT=2637 ACE FILE PRODUCED AT NEA WITH NDEC  
Threshold reactions

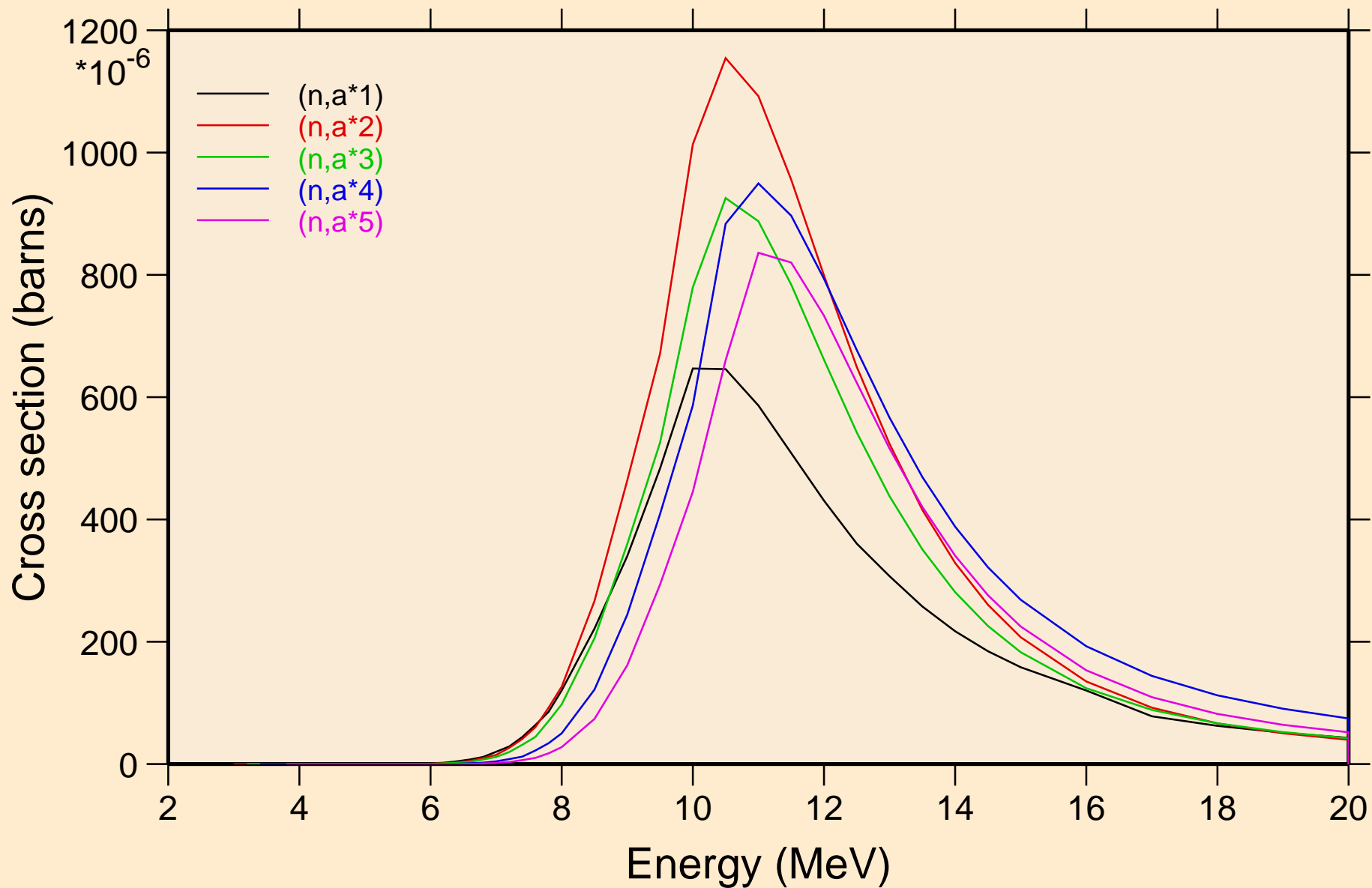

MAT=2637 ACE FILE PRODUCED AT NEA WITH NDEC  
Threshold reactions

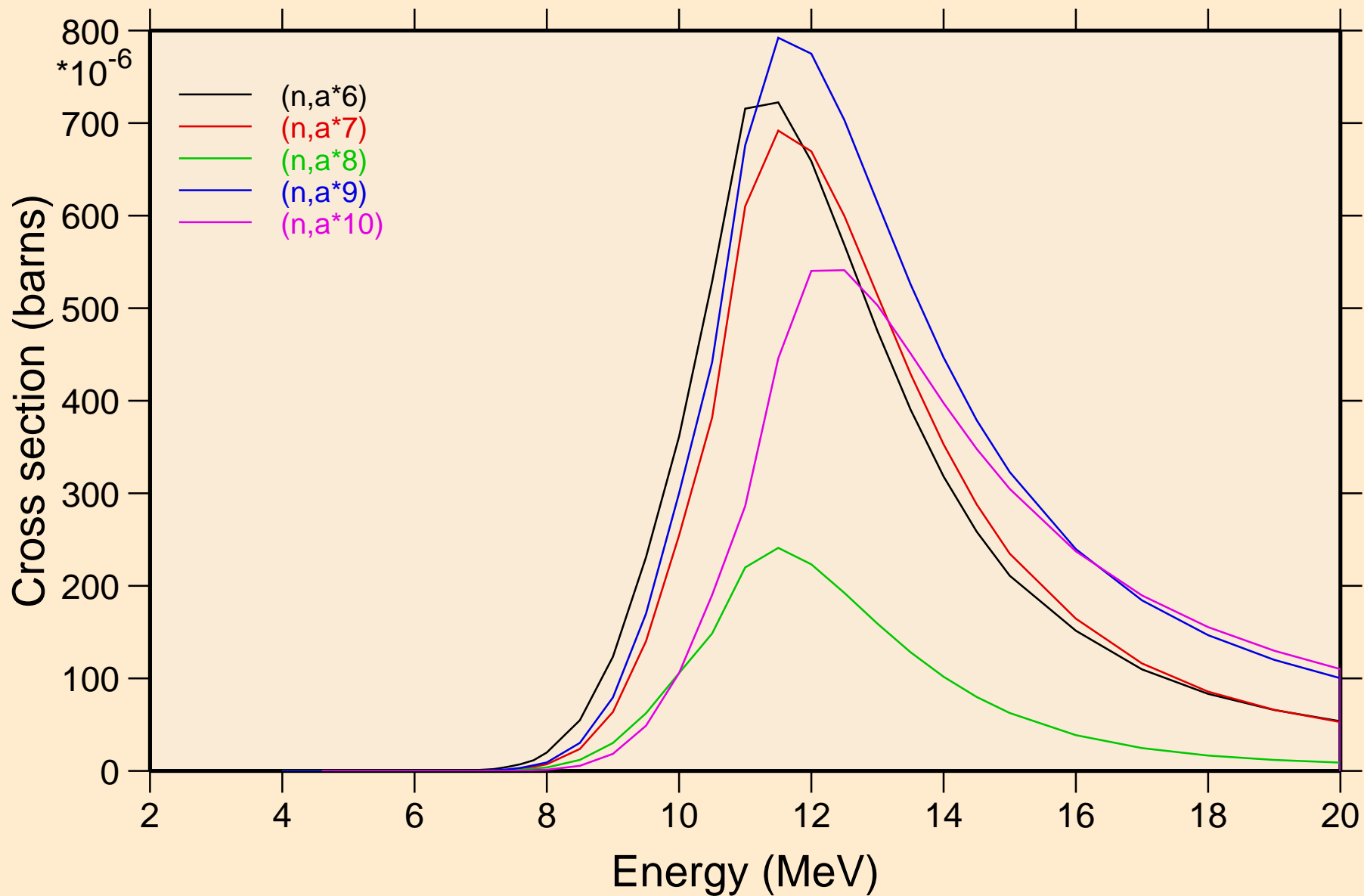

MAT=2637 ACE FILE PRODUCED AT NEA WITH NDEC  
Threshold reactions

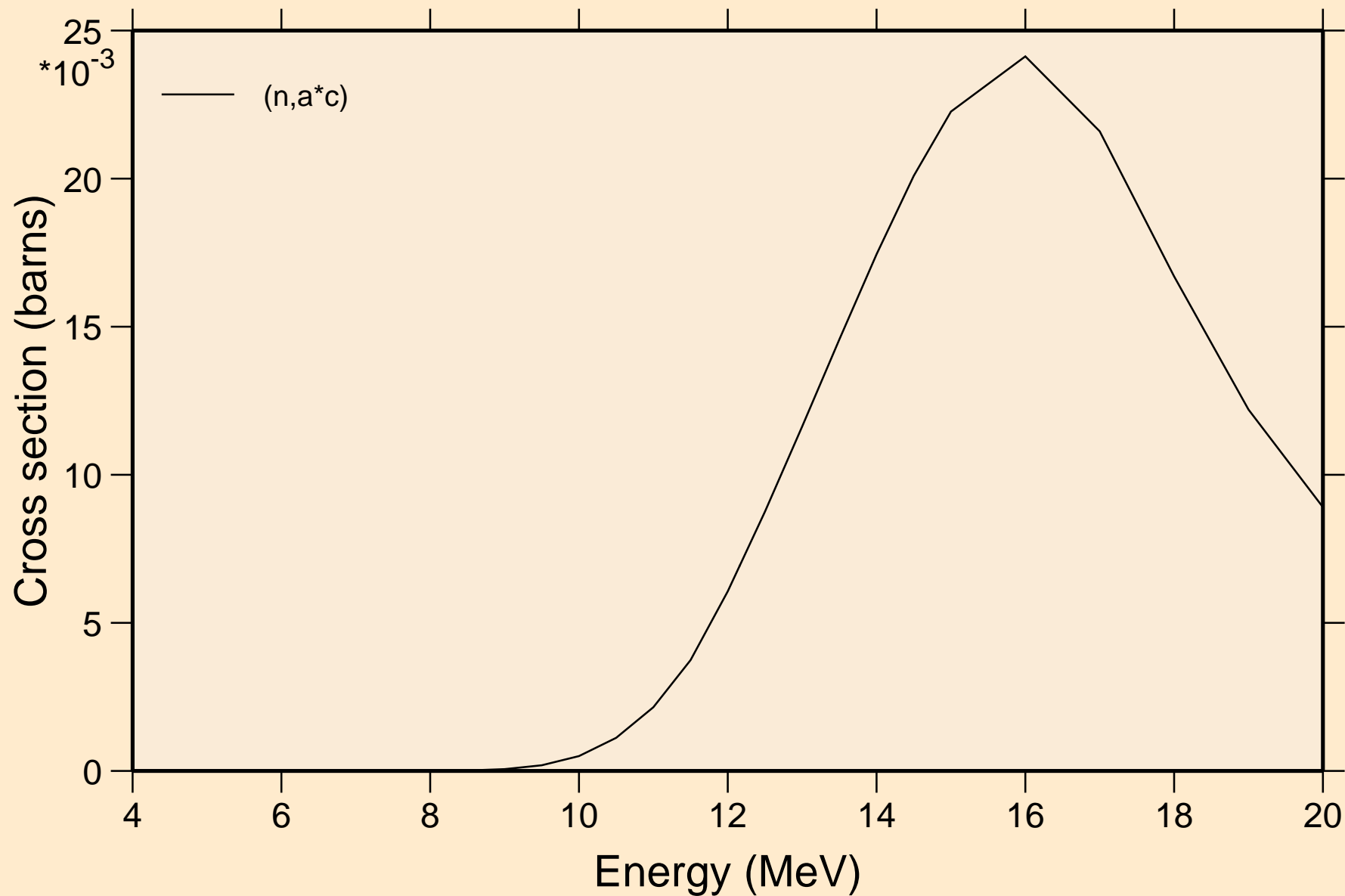

MAT=2637 ACE FILE PRODUCED AT NEA WITH NDEC  
angular distribution for elastic

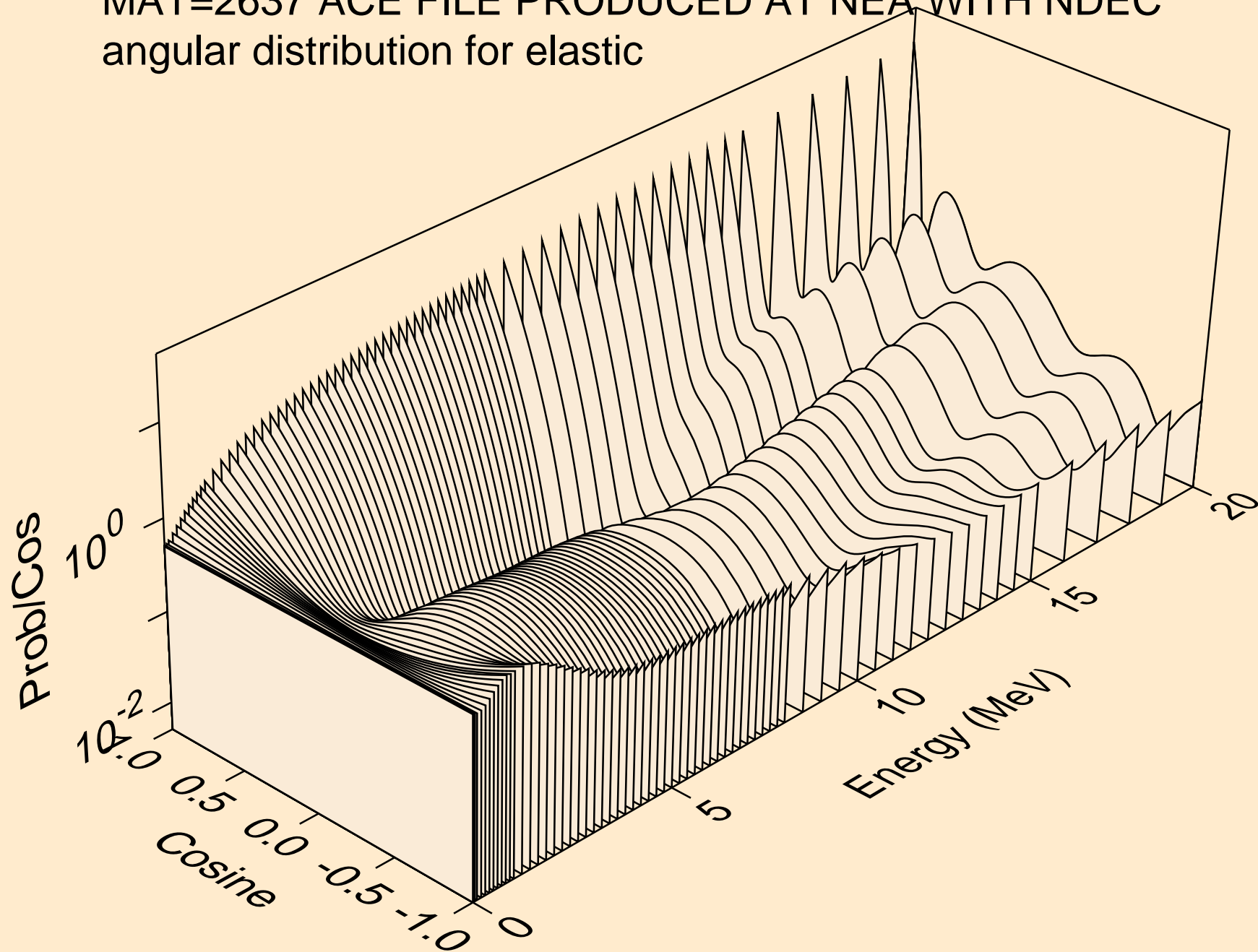

MAT=2637 ACE FILE PRODUCED AT NEA WITH NDEC  
angular distribution for elastic

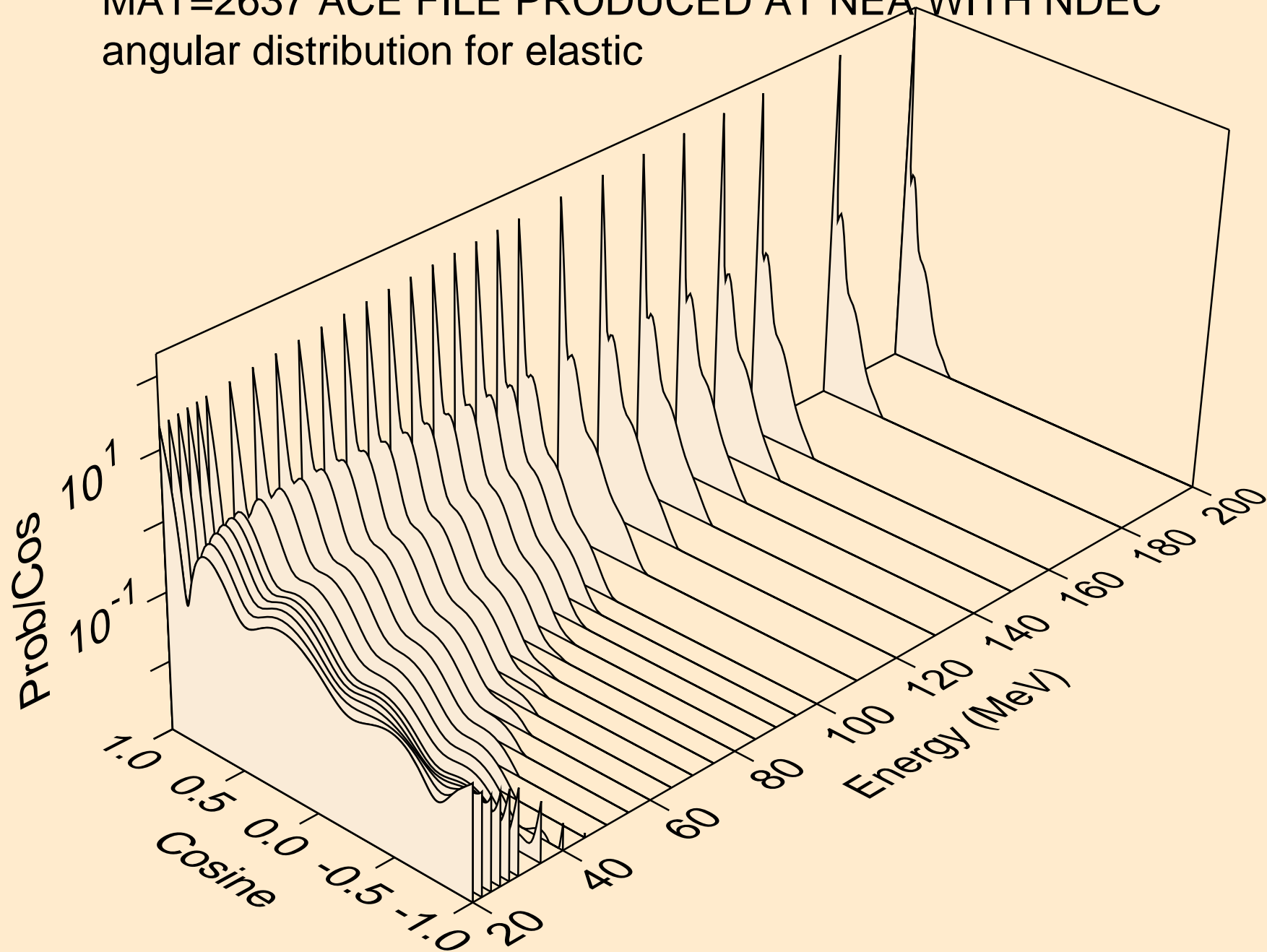



MAT=2637 ACE FILE PRODUCED AT NEA WITH NDEC  
angular distribution for (n,n\*1)

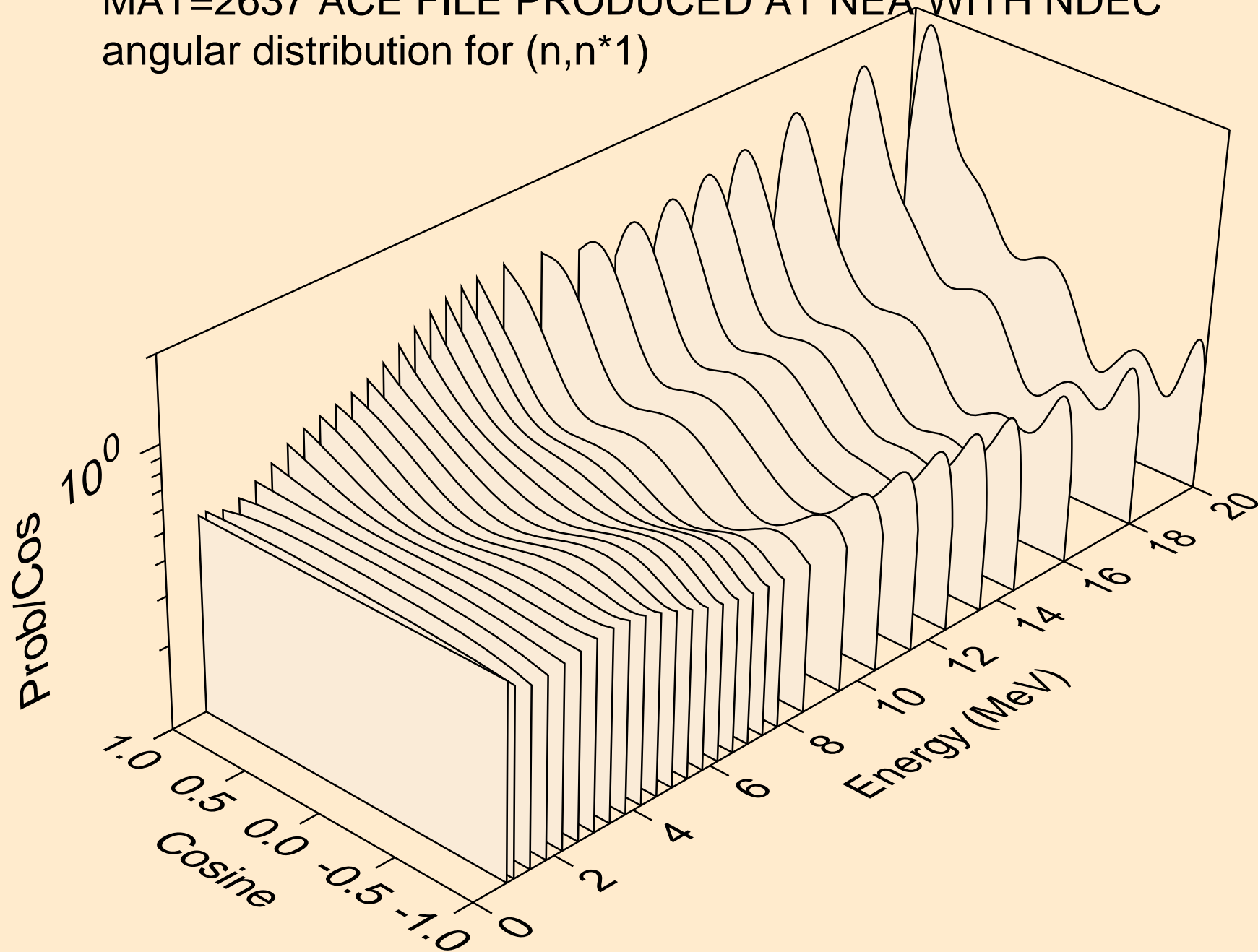

MAT=2637 ACE FILE PRODUCED AT NEA WITH NDEC  
angular distribution for (n,n\*2)

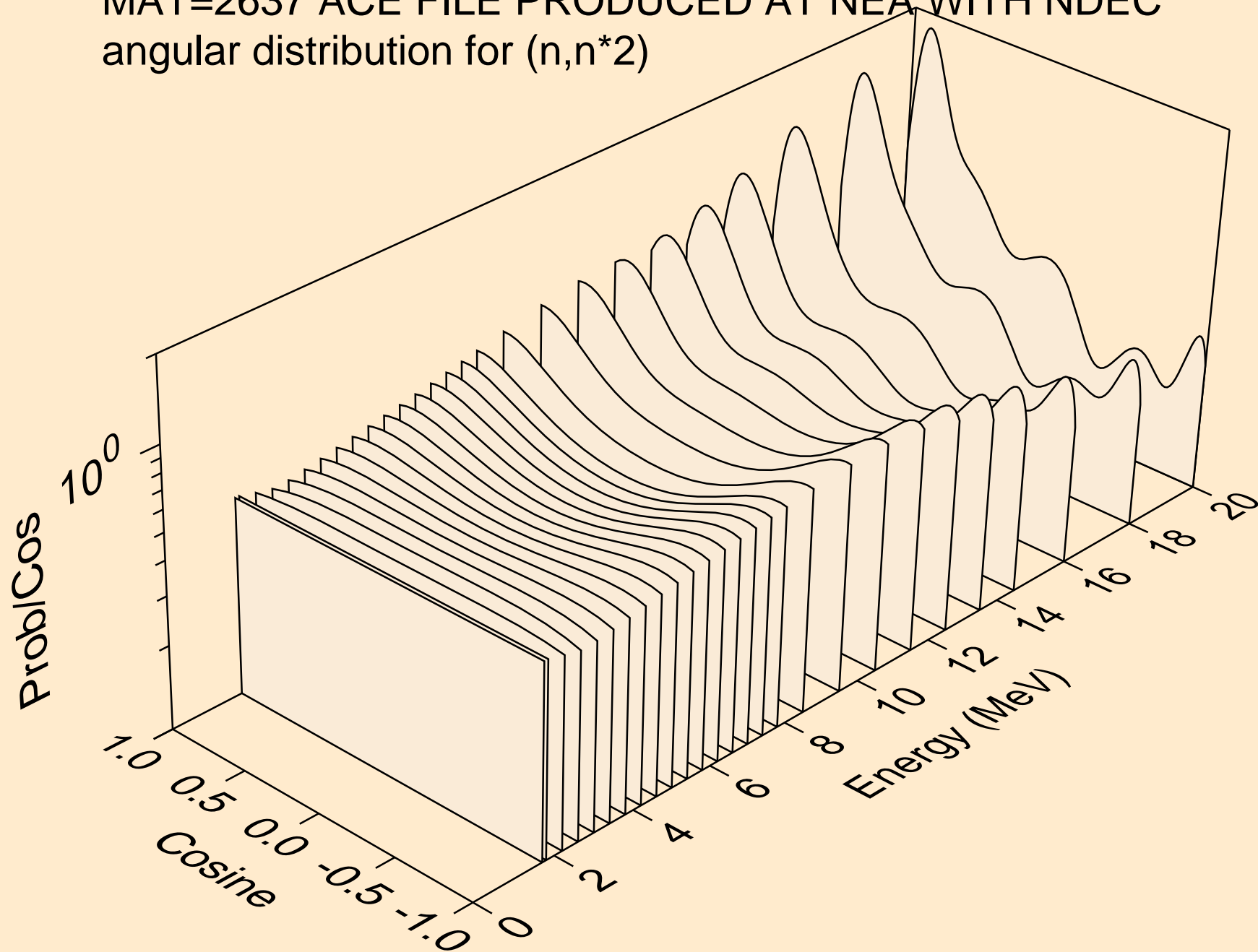

MAT=2637 ACE FILE PRODUCED AT NEA WITH NDEC  
angular distribution for (n,n\*3)

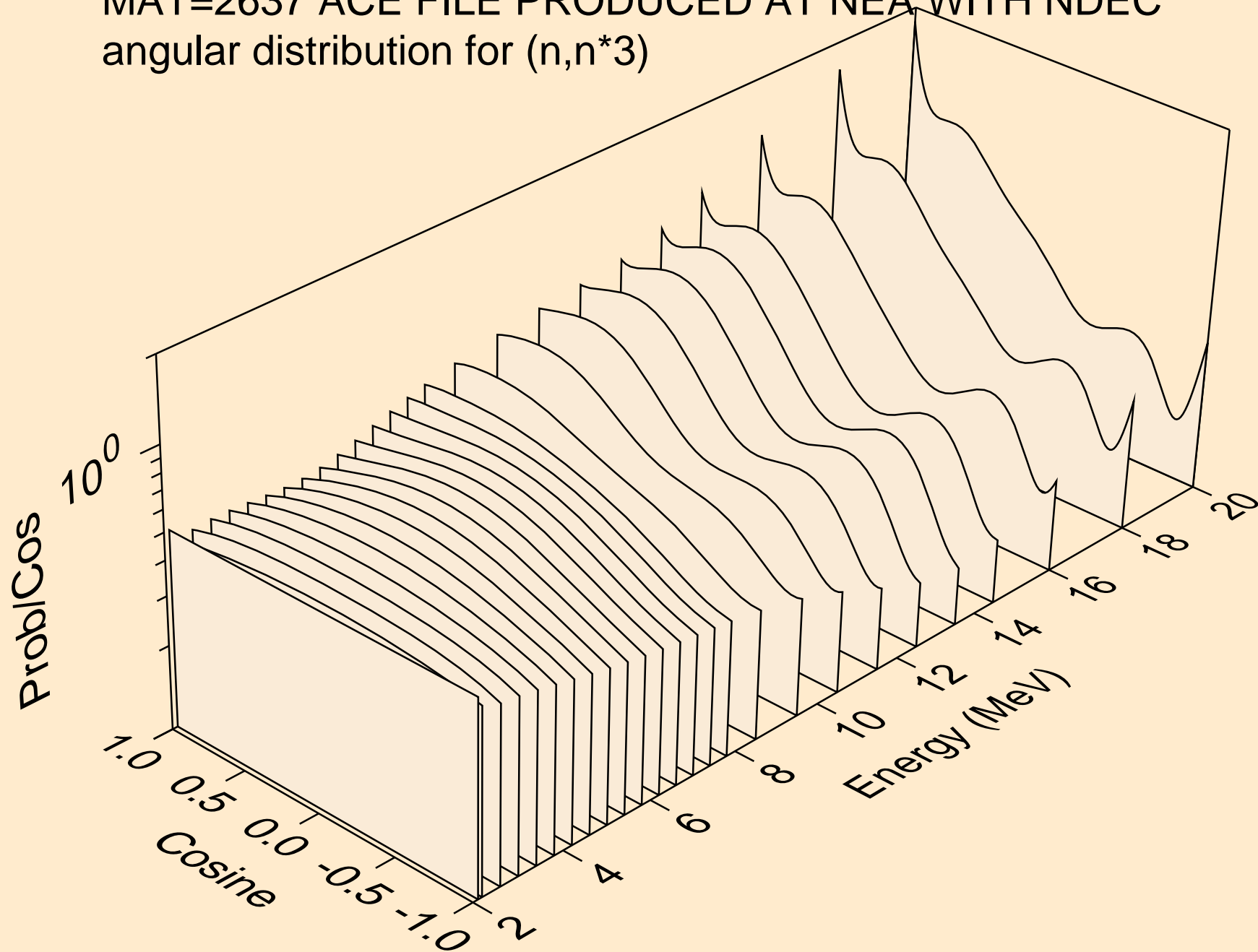

MAT=2637 ACE FILE PRODUCED AT NEA WITH NDEC  
angular distribution for (n,n\*4)

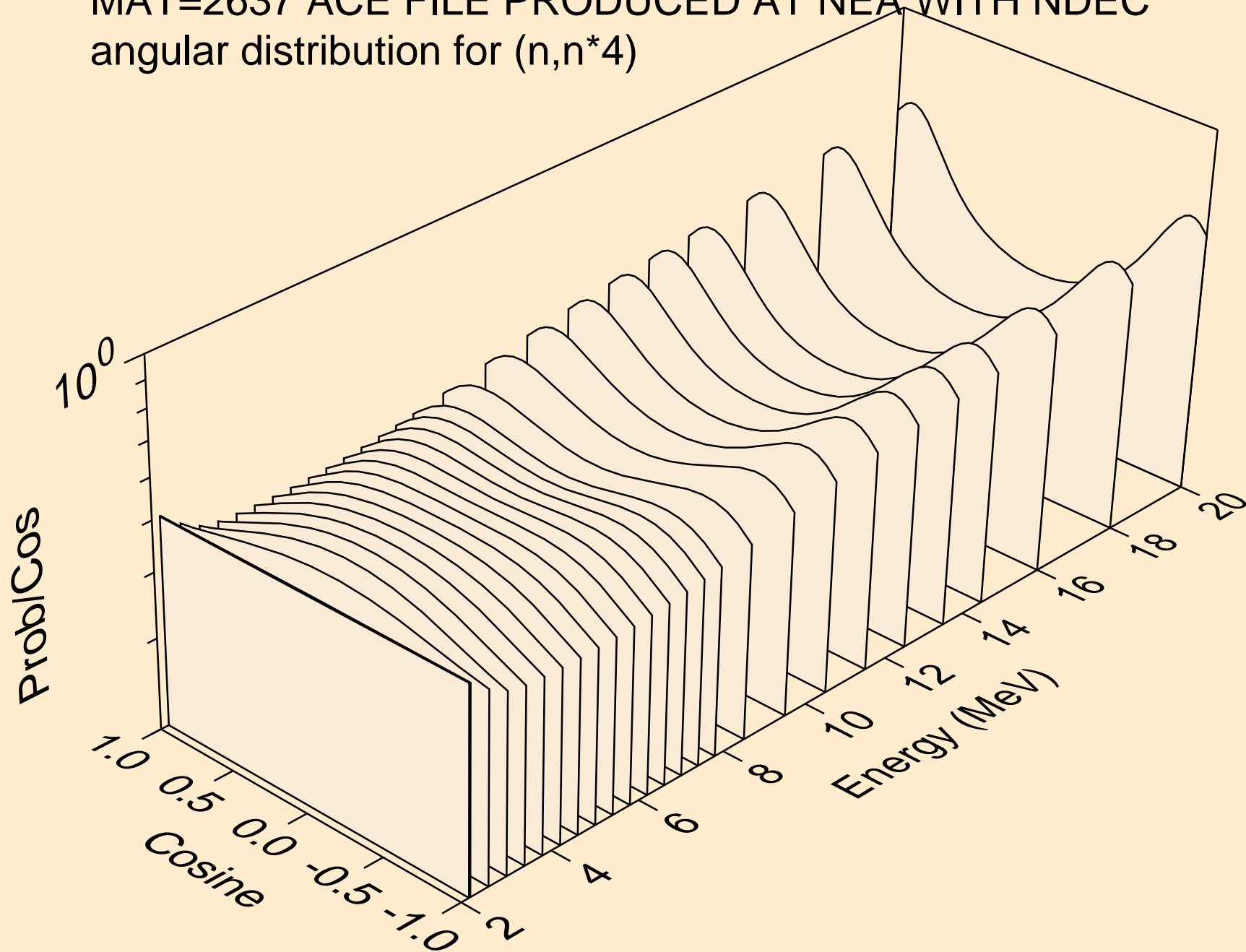

MAT=2637 ACE FILE PRODUCED AT NEA WITH NDEC  
angular distribution for (n,n\*5)

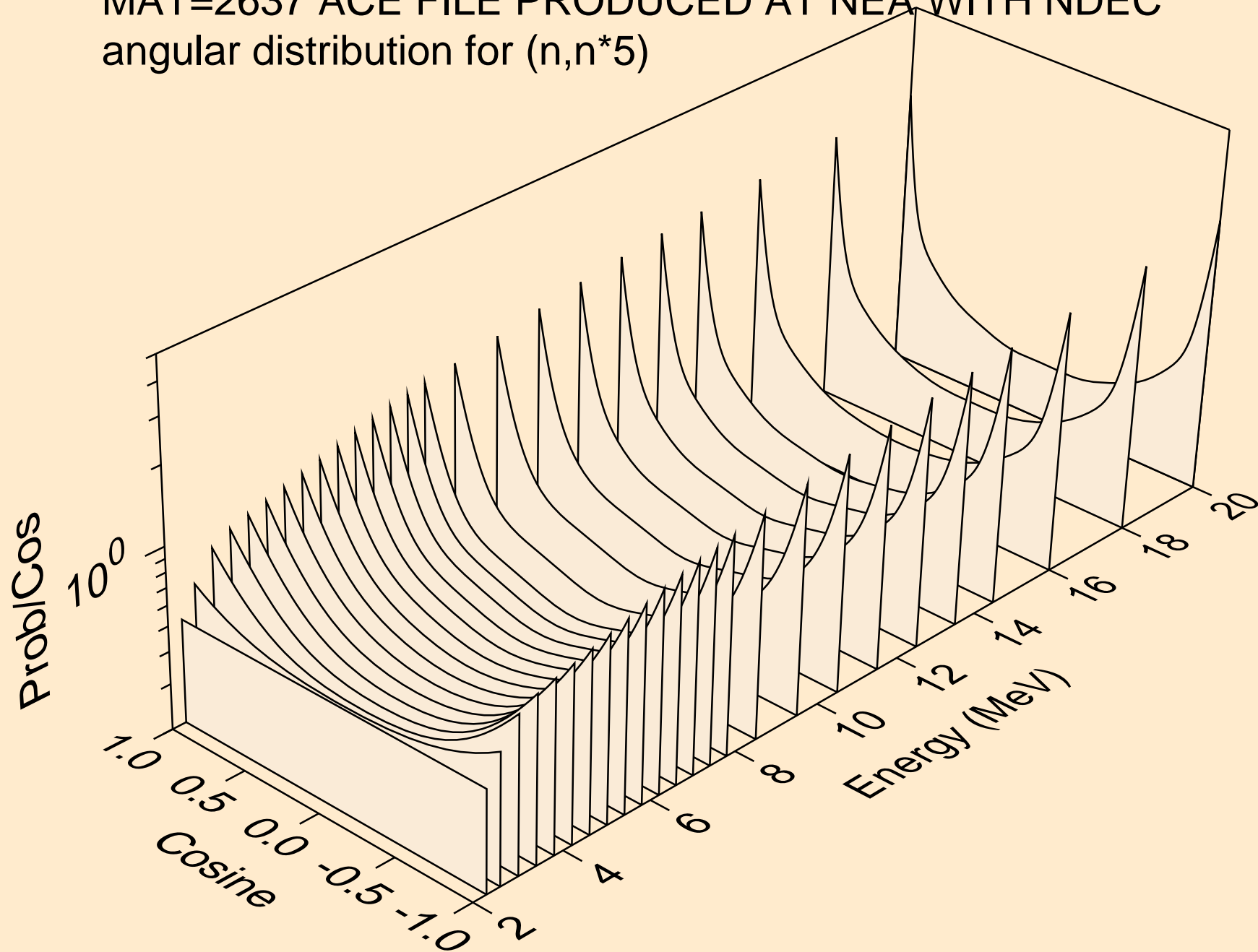

MAT=2637 ACE FILE PRODUCED AT NEA WITH NDEC  
angular distribution for (n,n\*6)

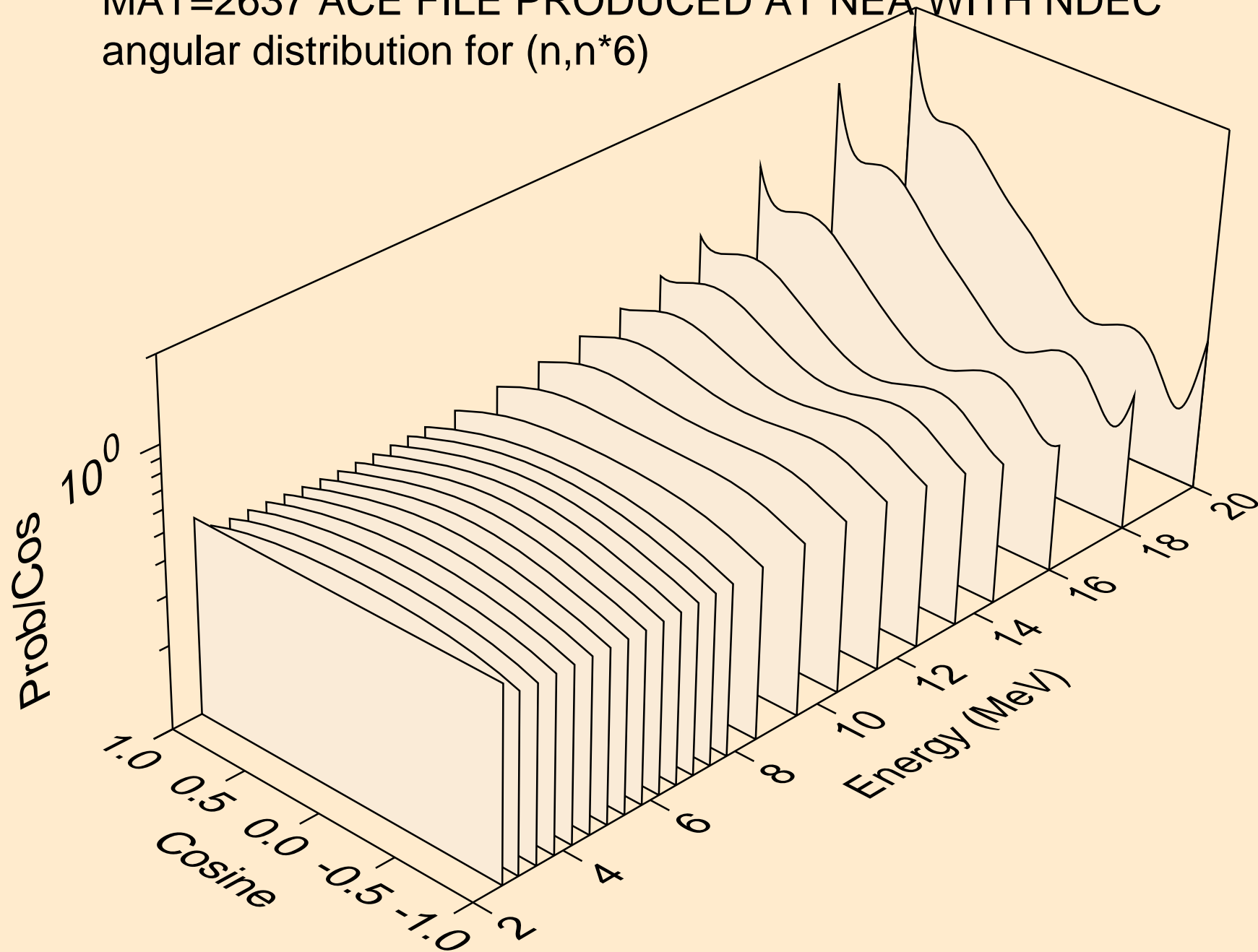

MAT=2637 ACE FILE PRODUCED AT NEA WITH NDEC  
angular distribution for (n,n\*7)

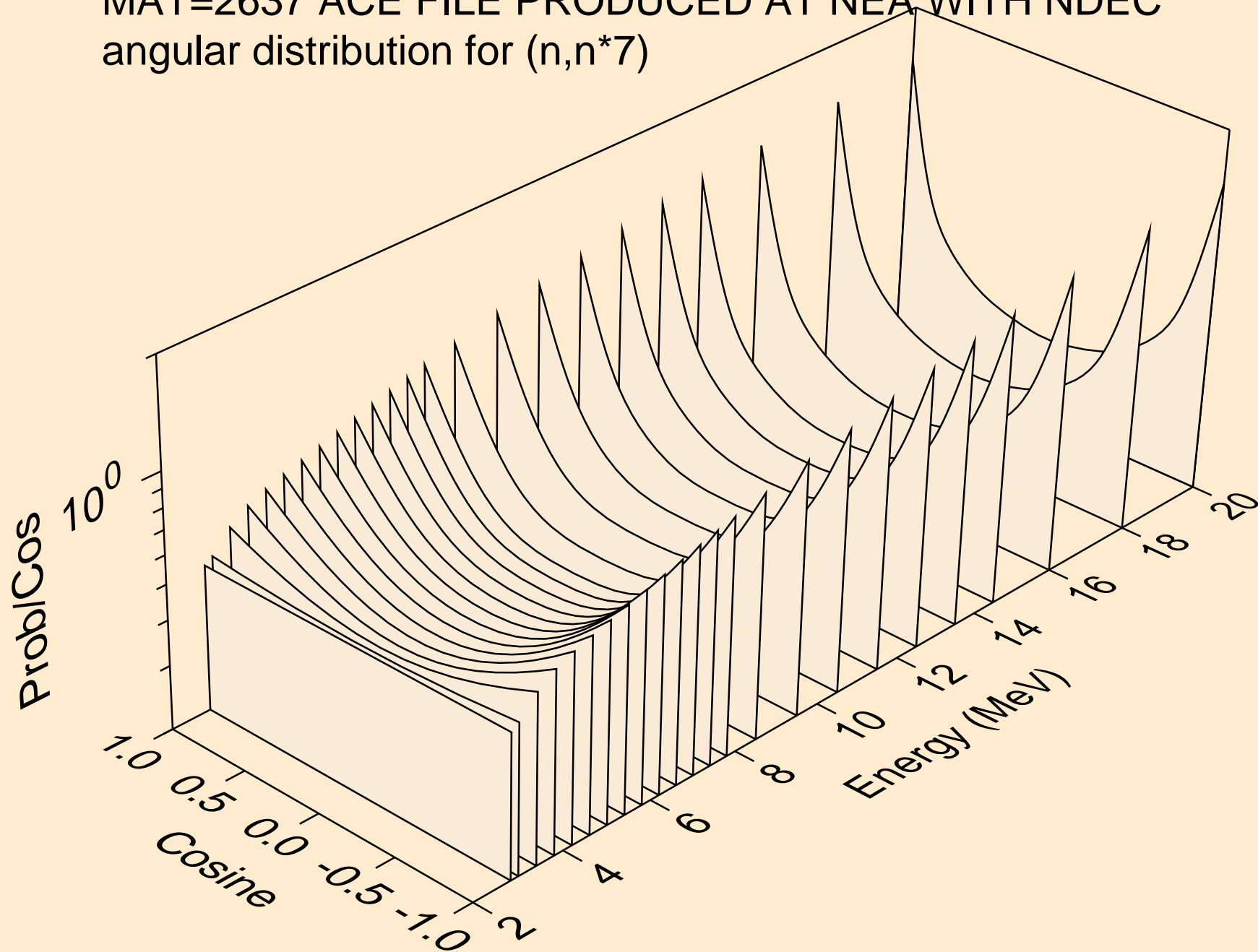

MAT=2637 ACE FILE PRODUCED AT NEA WITH NDEC  
angular distribution for (n,n\*8)

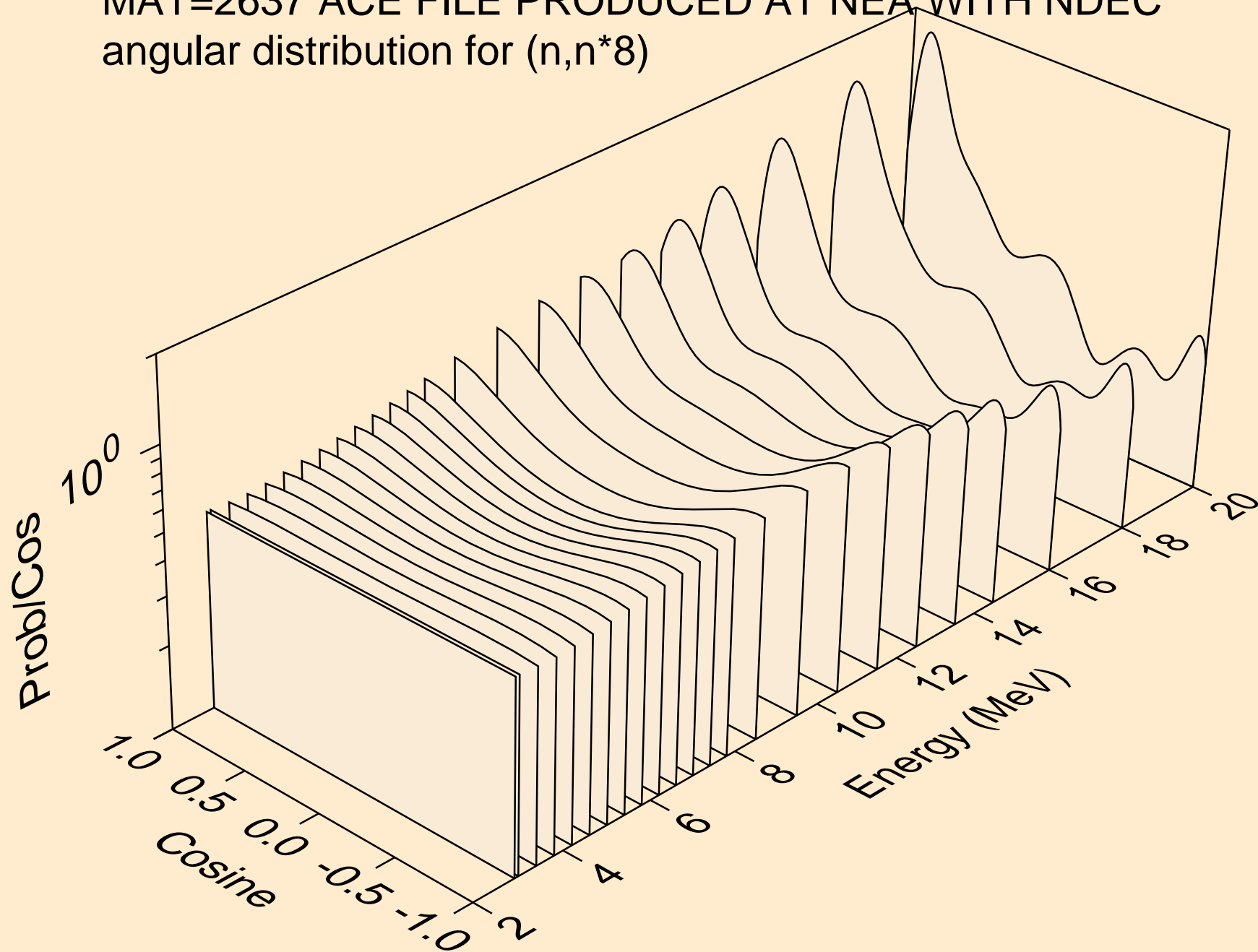



MAT=2637 ACE FILE PRODUCED AT NEA WITH NDEC  
angular distribution for (n,n\*9)

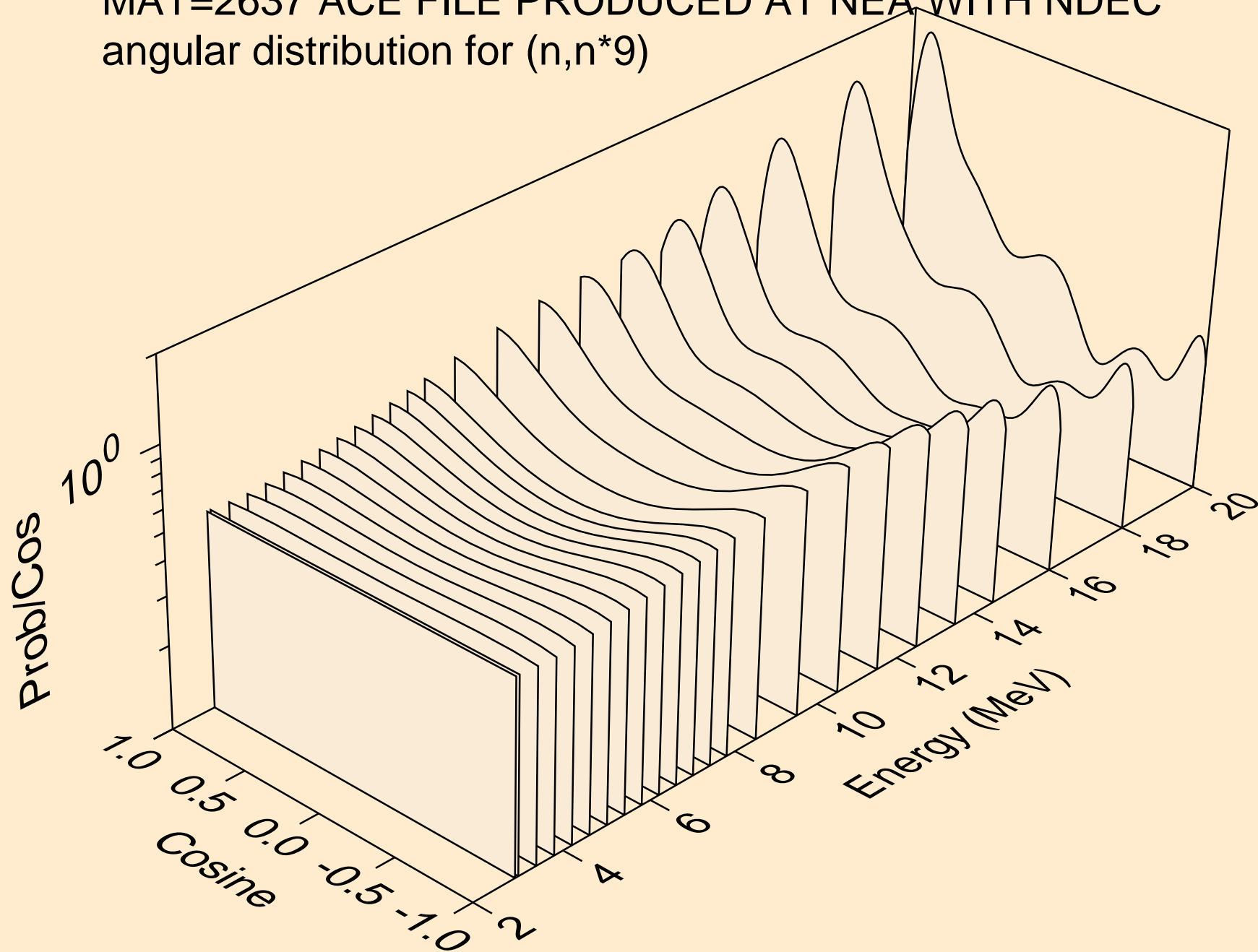

MAT=2637 ACE FILE PRODUCED AT NEA WITH NDEC  
angular distribution for (n,n\*10)

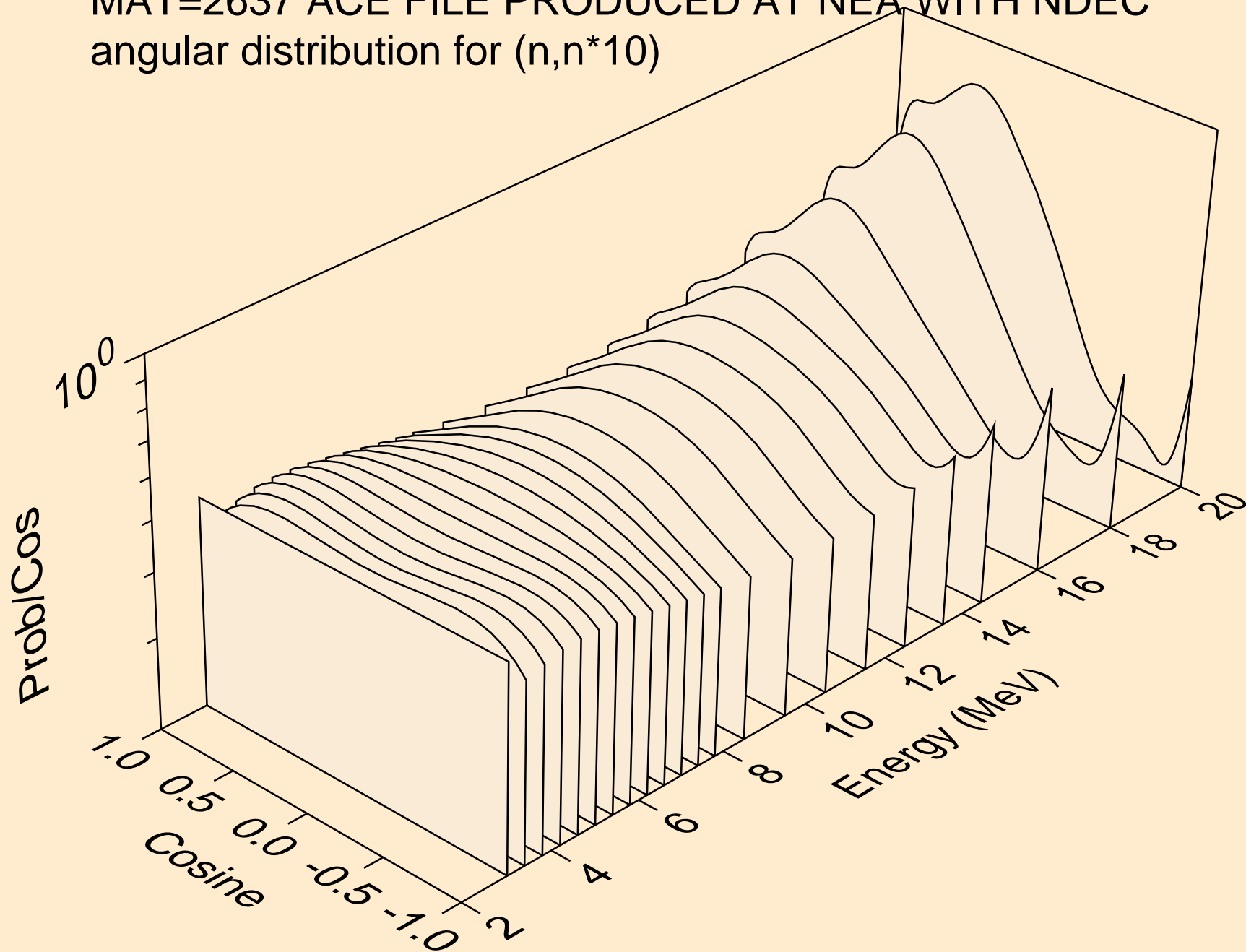

MAT=2637 ACE FILE PRODUCED AT NEA WITH NDEC  
angular distribution for (n,n\*11)

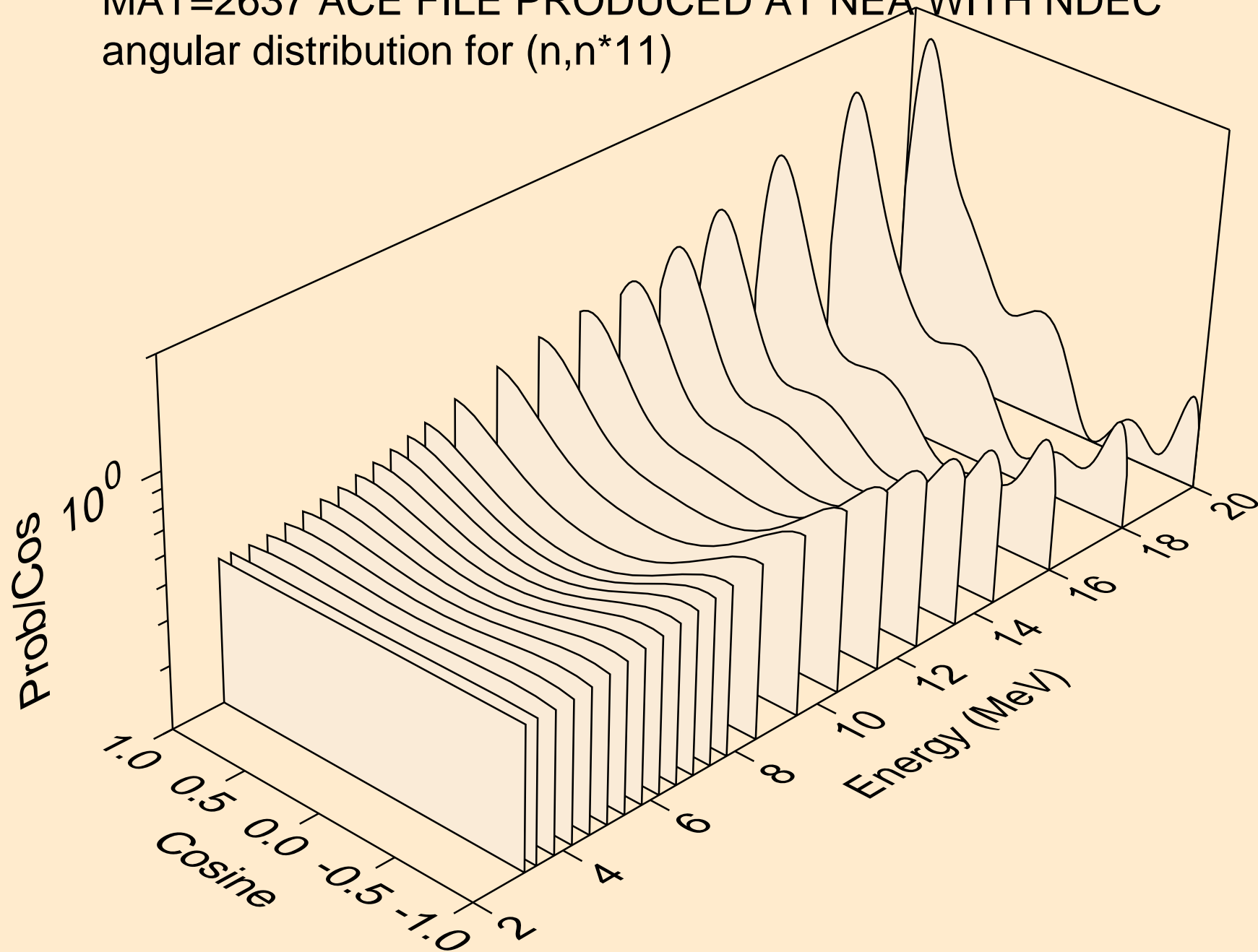

MAT=2637 ACE FILE PRODUCED AT NEA WITH NDEC  
angular distribution for (n,n\*12)

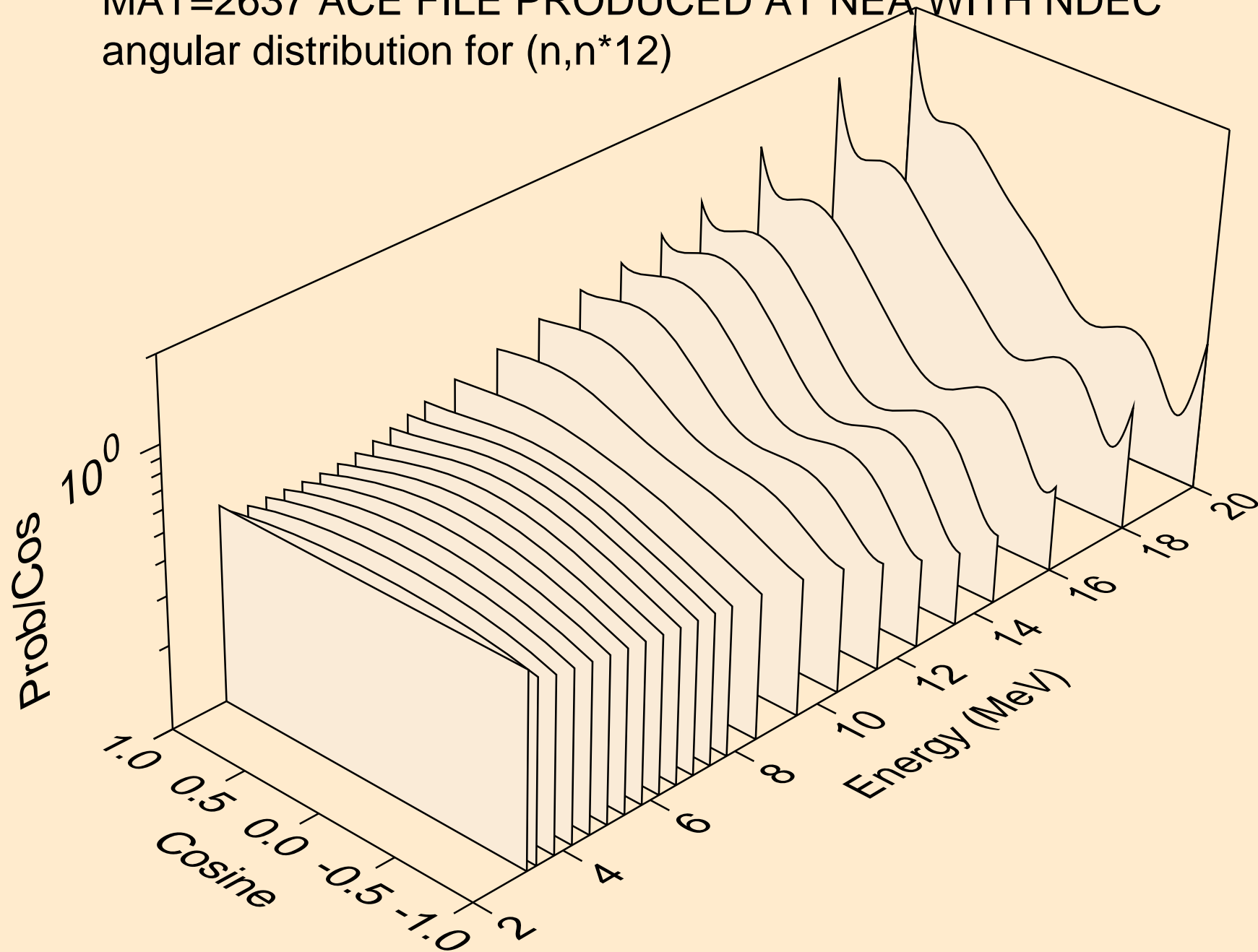

MAT=2637 ACE FILE PRODUCED AT NEA WITH NDEC  
angular distribution for (n,n\*13)

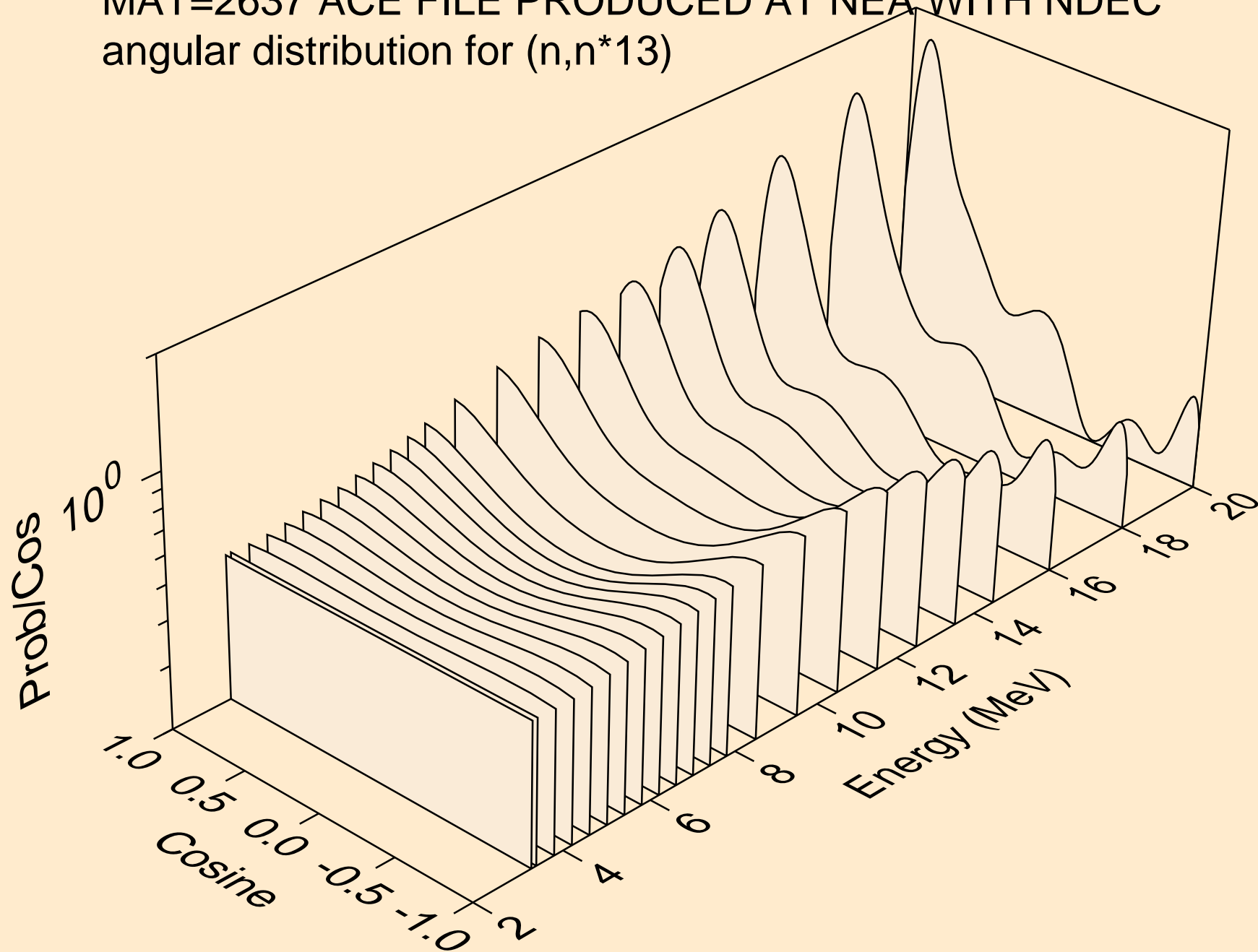

MAT=2637 ACE FILE PRODUCED AT NEA WITH NDEC  
angular distribution for (n,n\*14)

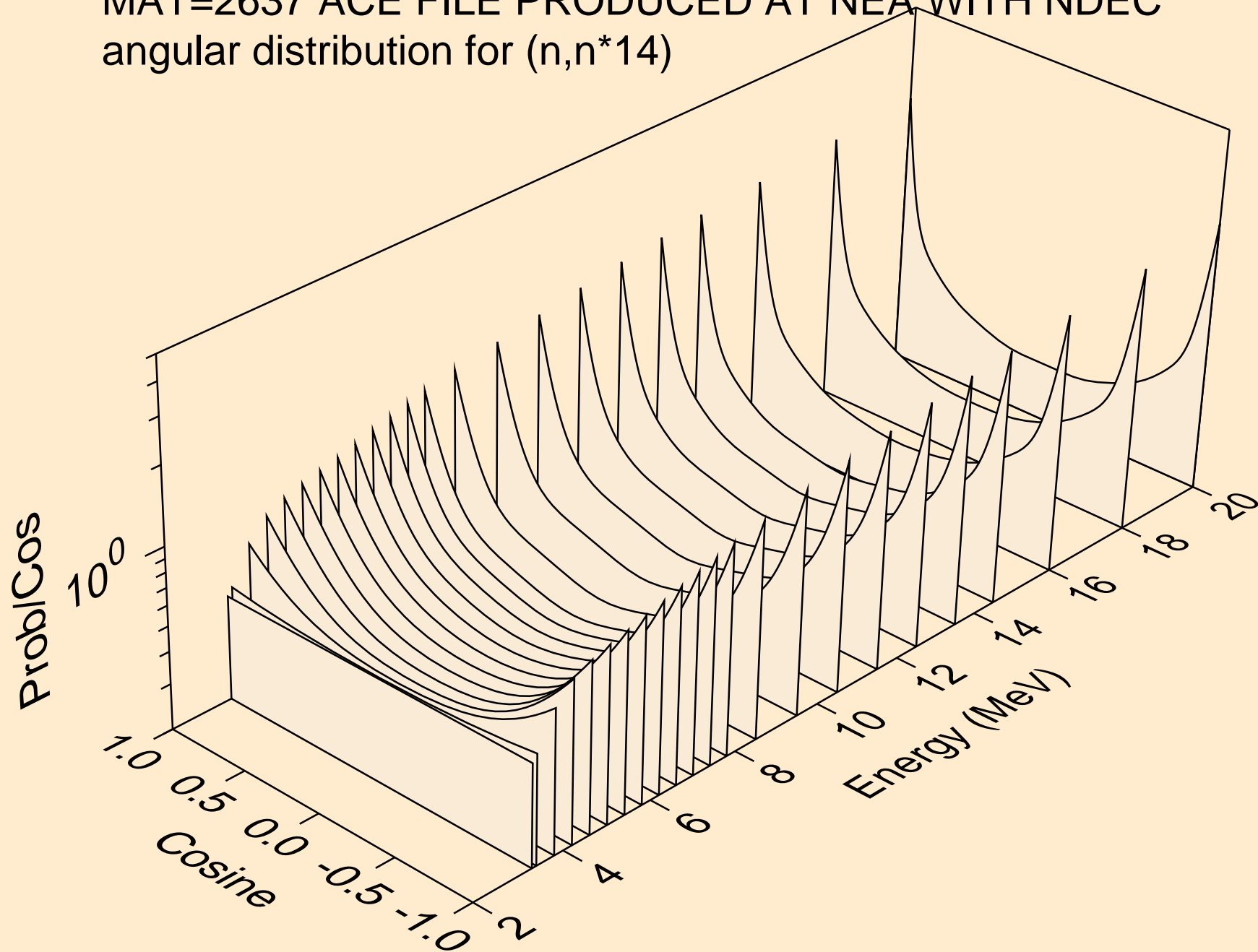

MAT=2637 ACE FILE PRODUCED AT NEA WITH NDEC  
angular distribution for (n,n\*15)

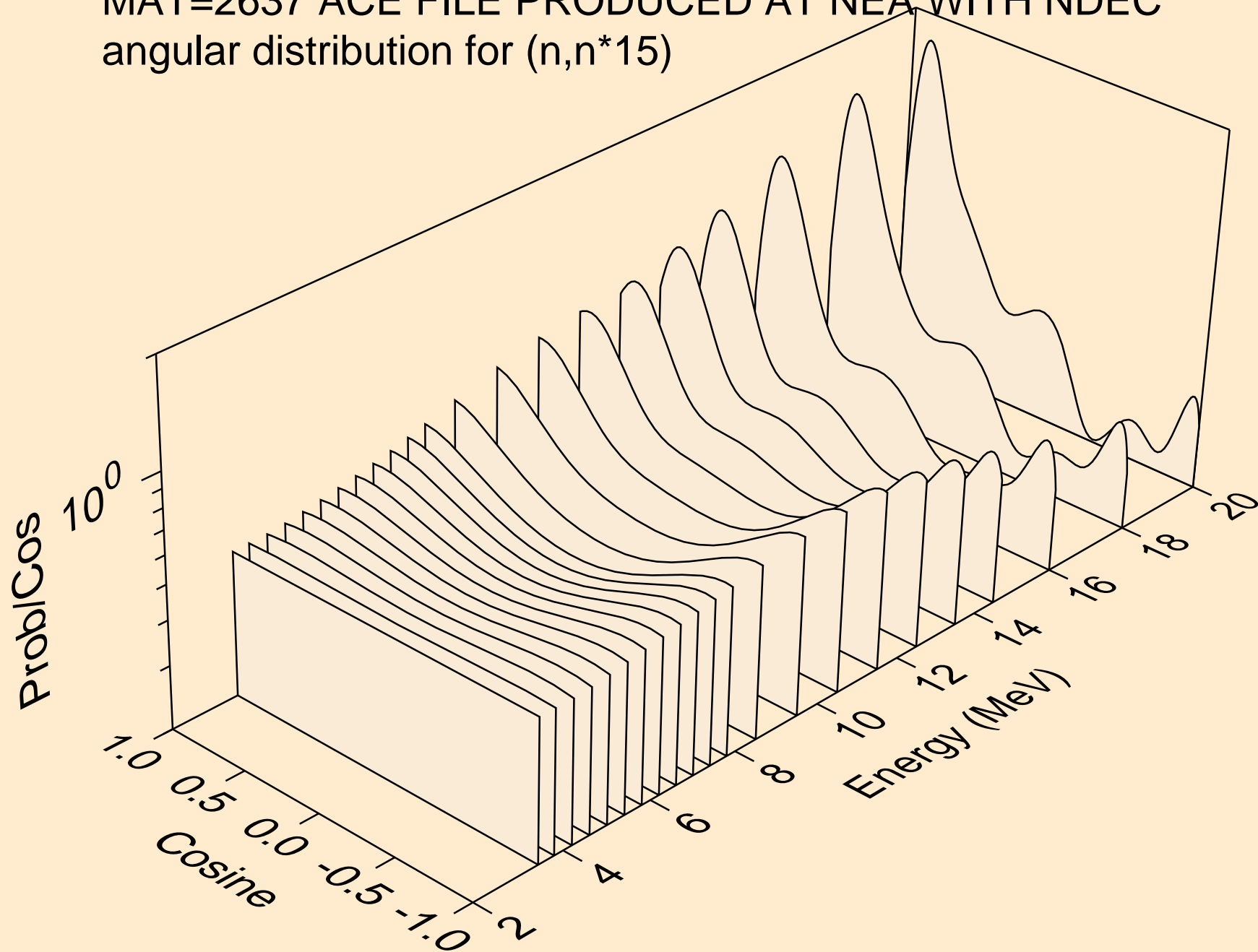

MAT=2637 ACE FILE PRODUCED AT NEA WITH NDEC  
angular distribution for (n,n\*16)

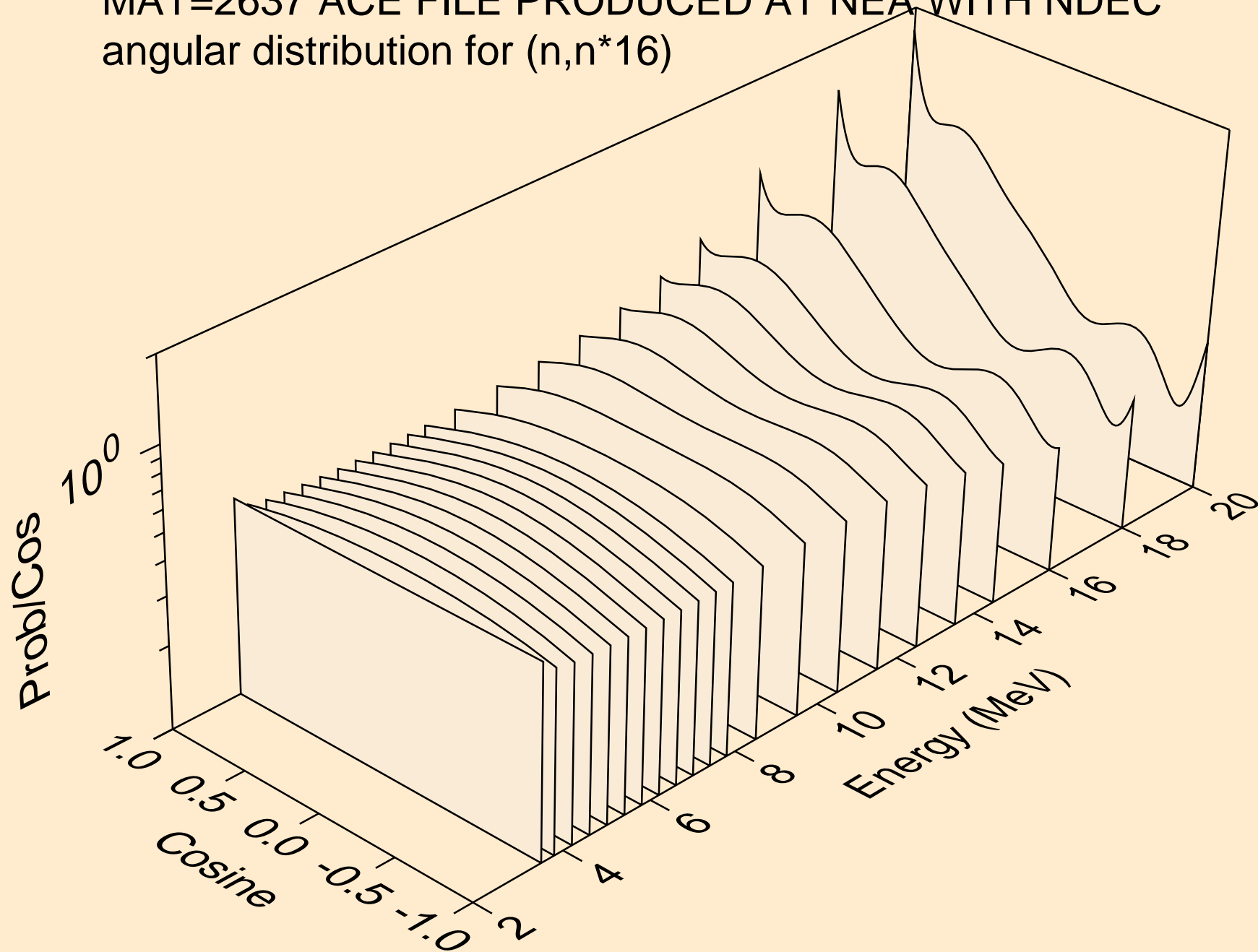



MAT=2637 ACE FILE PRODUCED AT NEA WITH NDEC  
angular distribution for (n,n\*17)

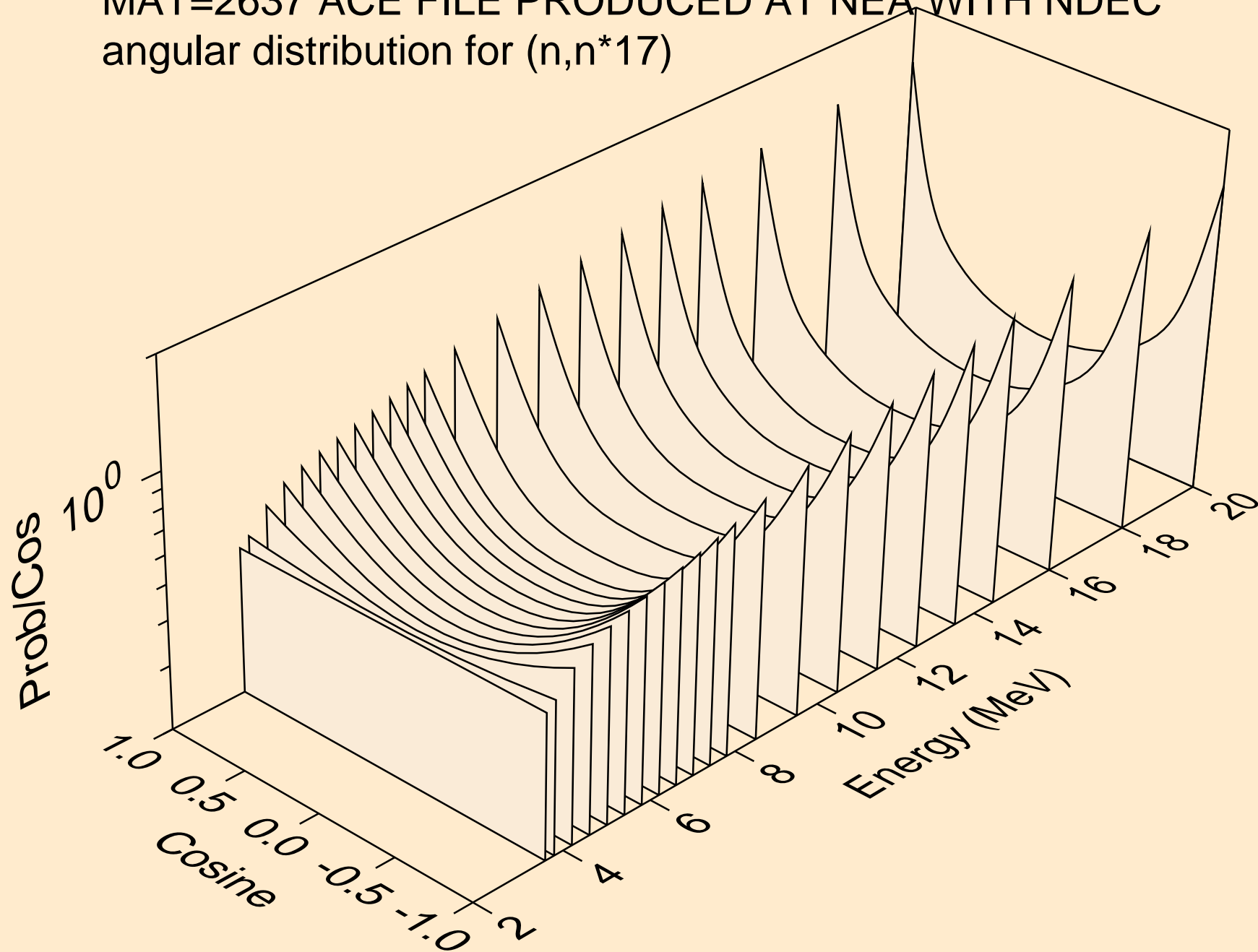

MAT=2637 ACE FILE PRODUCED AT NEA WITH NDEC  
angular distribution for (n,n\*18)

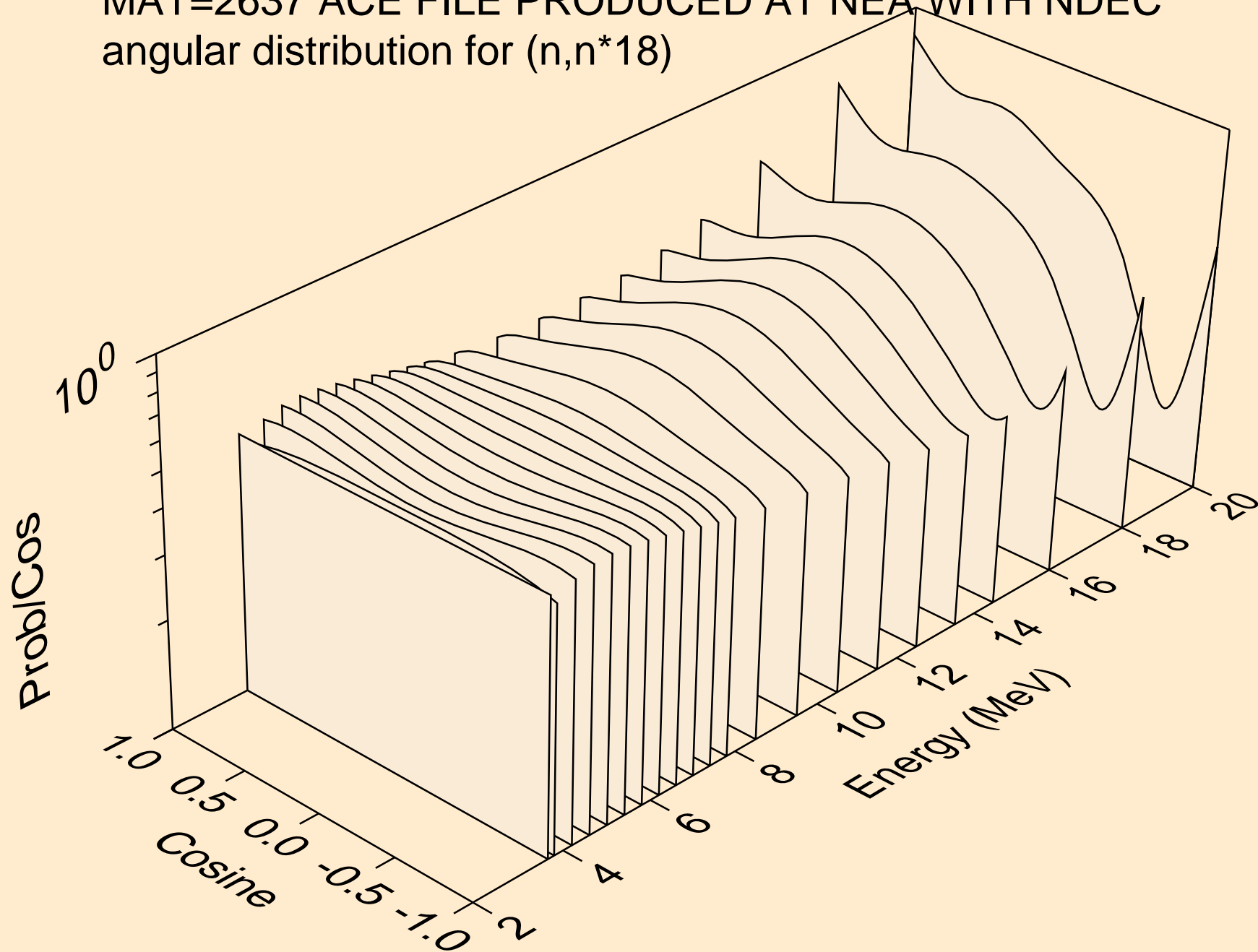

MAT=2637 ACE FILE PRODUCED AT NEA WITH NDEC  
angular distribution for (n,n\*19)

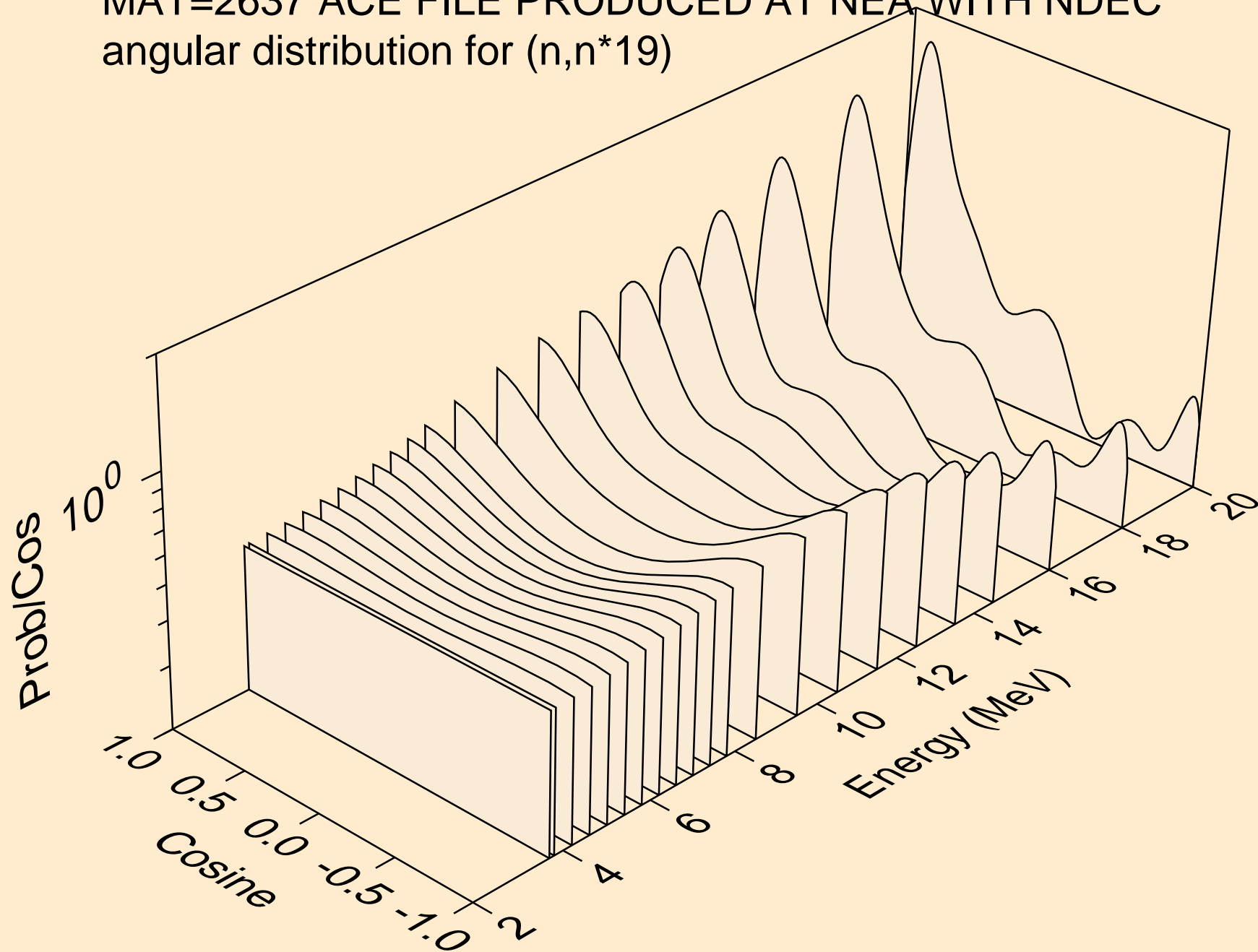

MAT=2637 ACE FILE PRODUCED AT NEA WITH NDEC  
angular distribution for (n,n\*20)

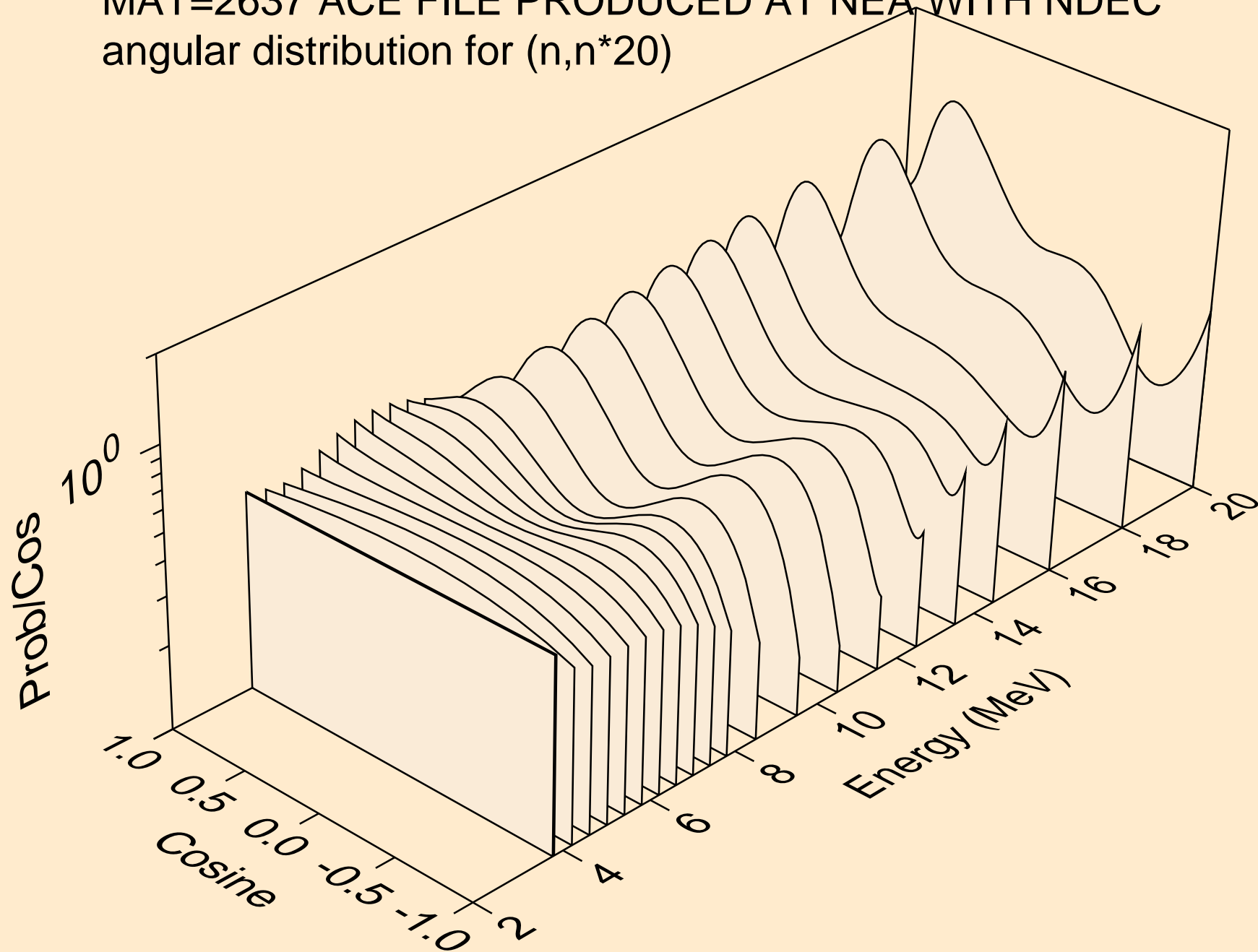

MAT=2637 ACE FILE PRODUCED AT NEA WITH NDEC  
Neutron emission for (n,x)

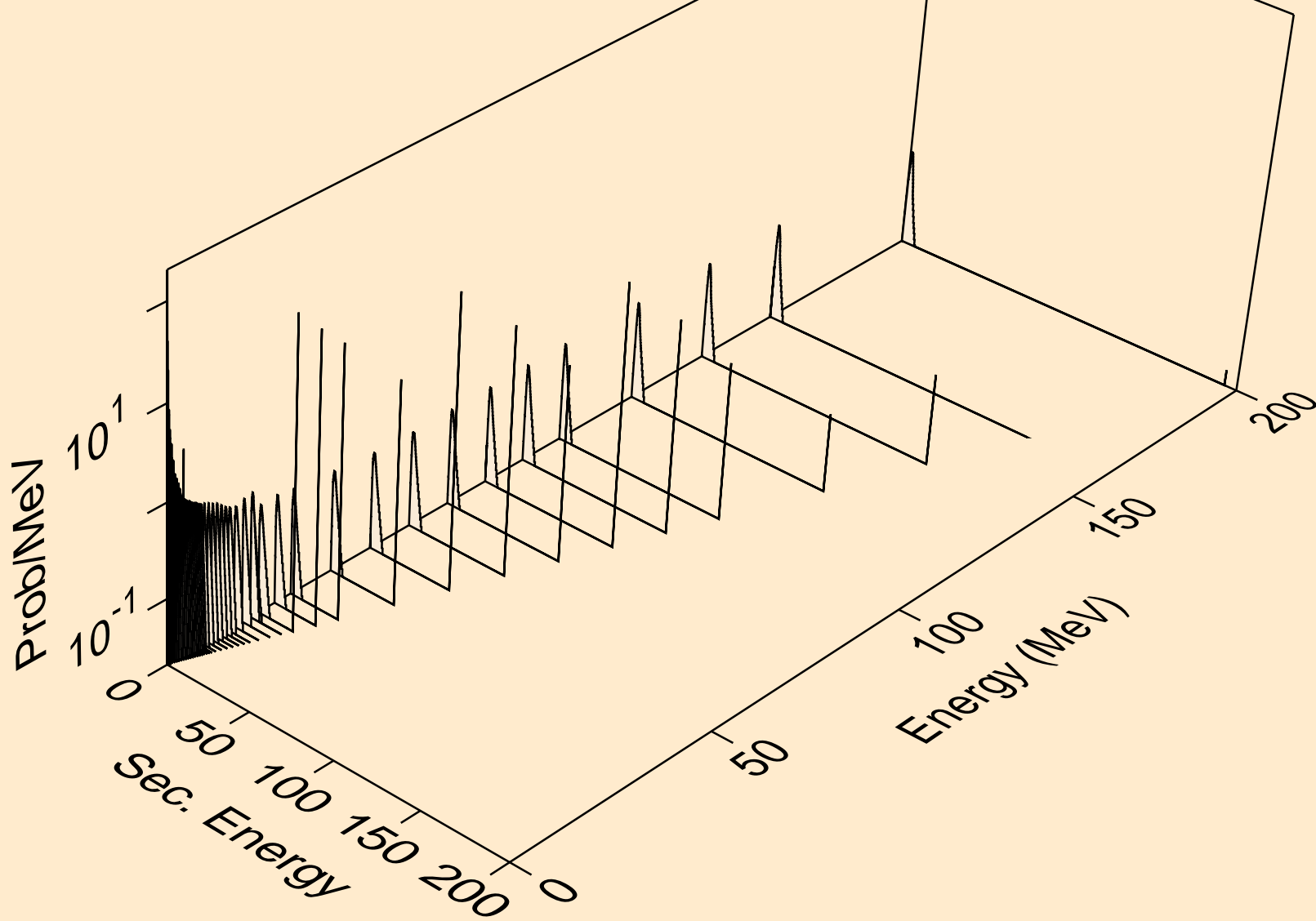

MAT=2637 ACE FILE PRODUCED AT NEA WITH NDEC  
Neutron emission for (n,2n)

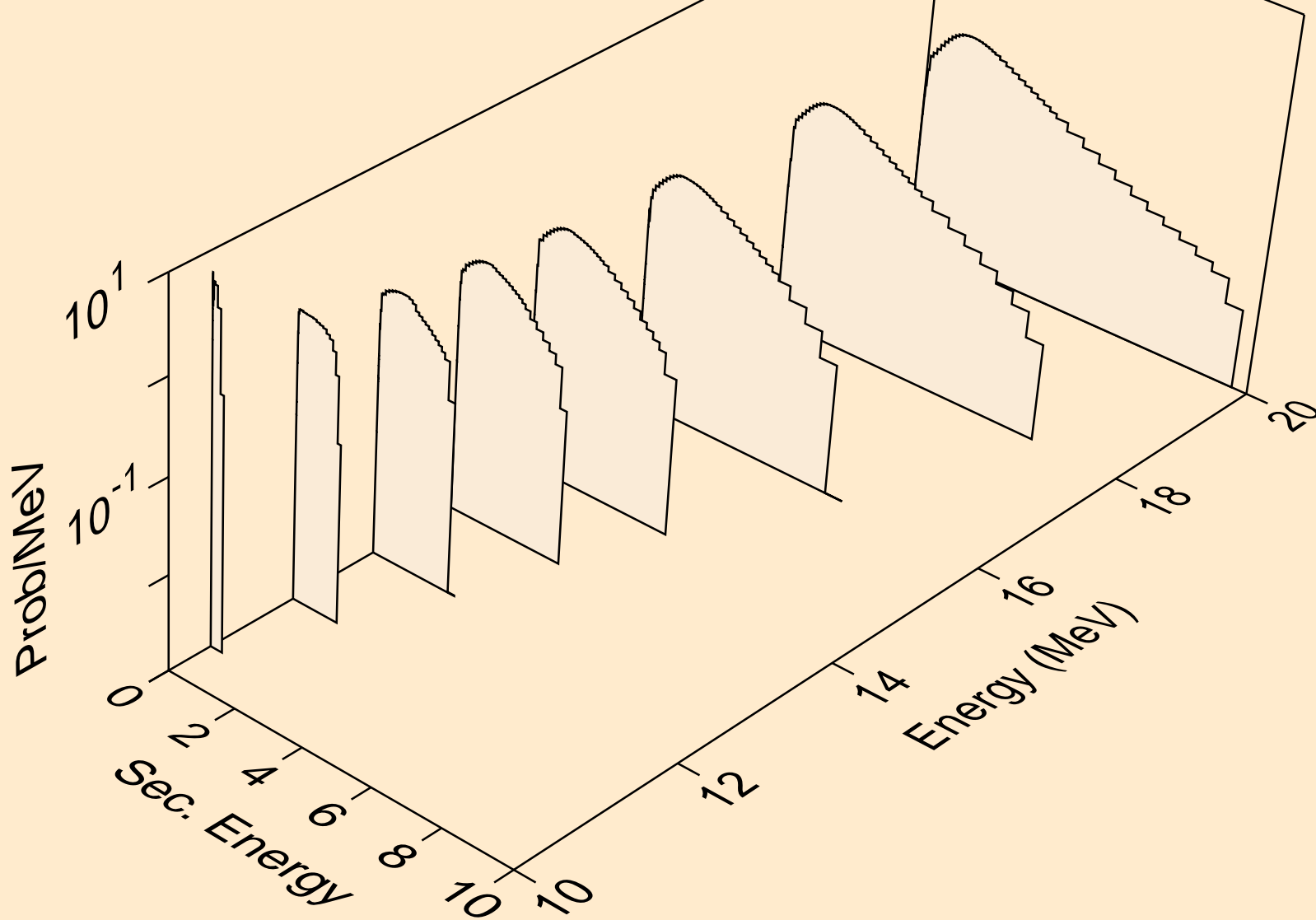

MAT=2637 ACE FILE PRODUCED AT NEA WITH NDEC  
Neutron emission for (n,3n)

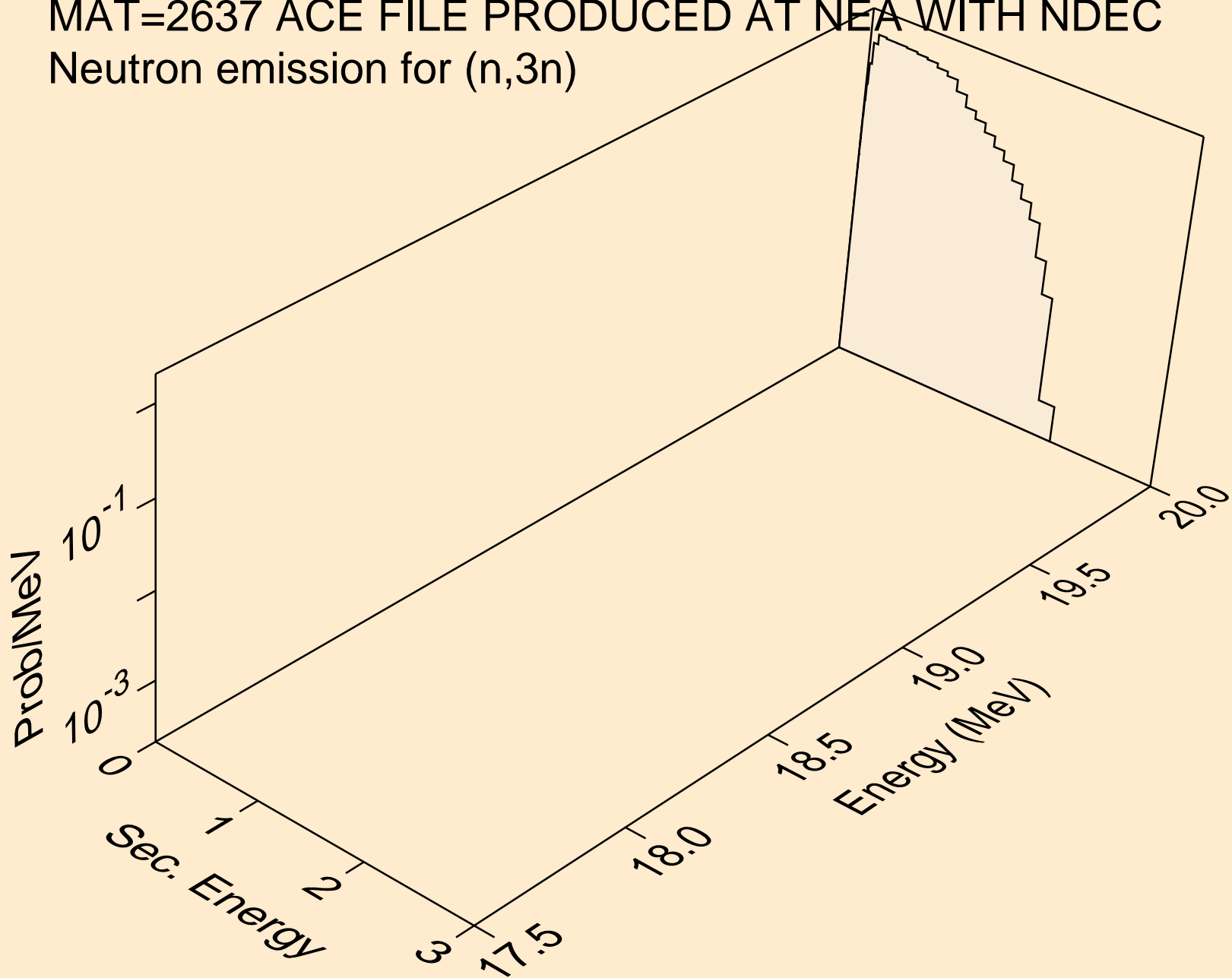

MAT=2637 ACE FILE PRODUCED AT NEA WITH NDEC  
Neutron emission for (n,n\*)a

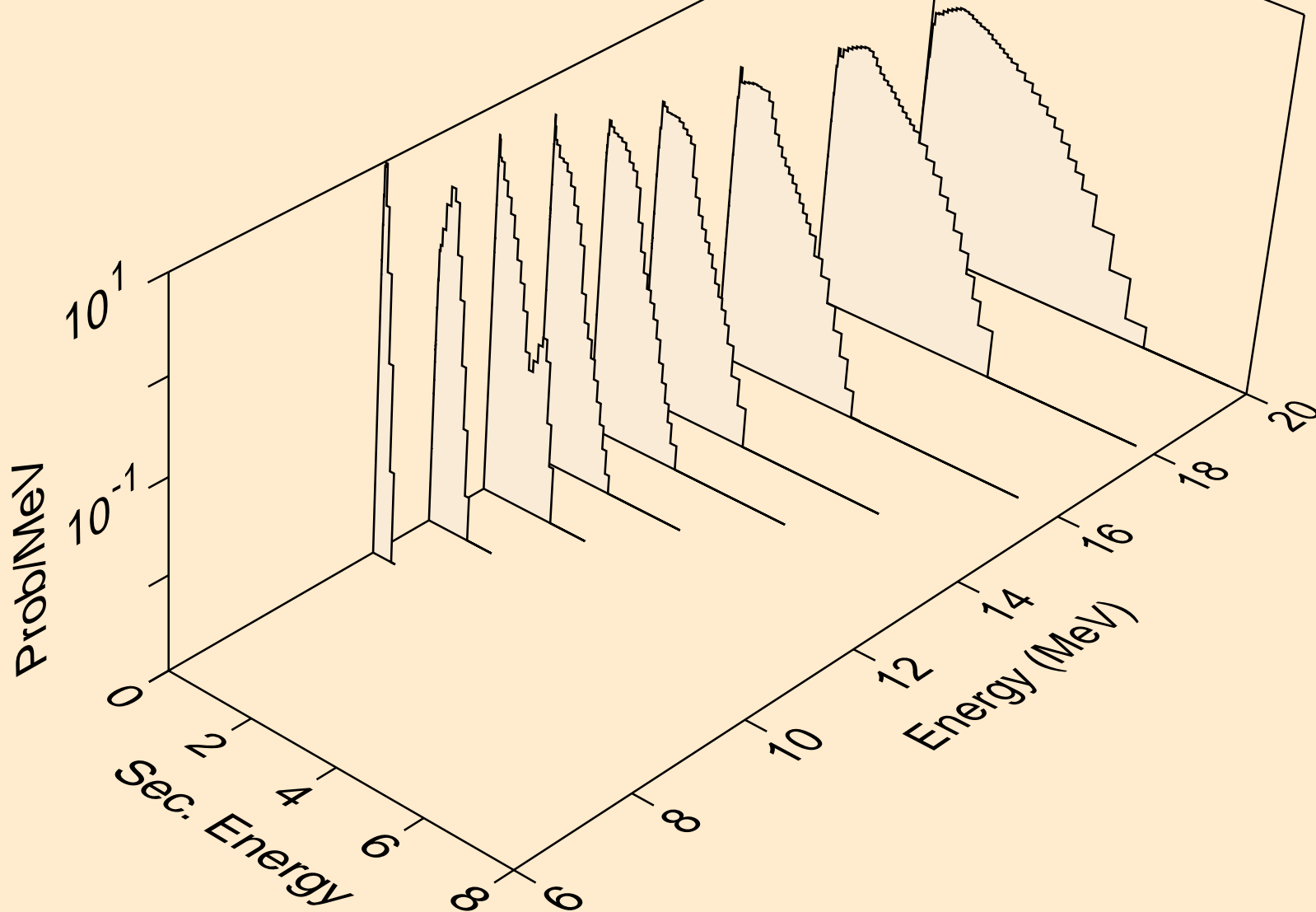



MAT=2637 ACE FILE PRODUCED AT NEA WITH NDEC  
Neutron emission for (n,n\*)p

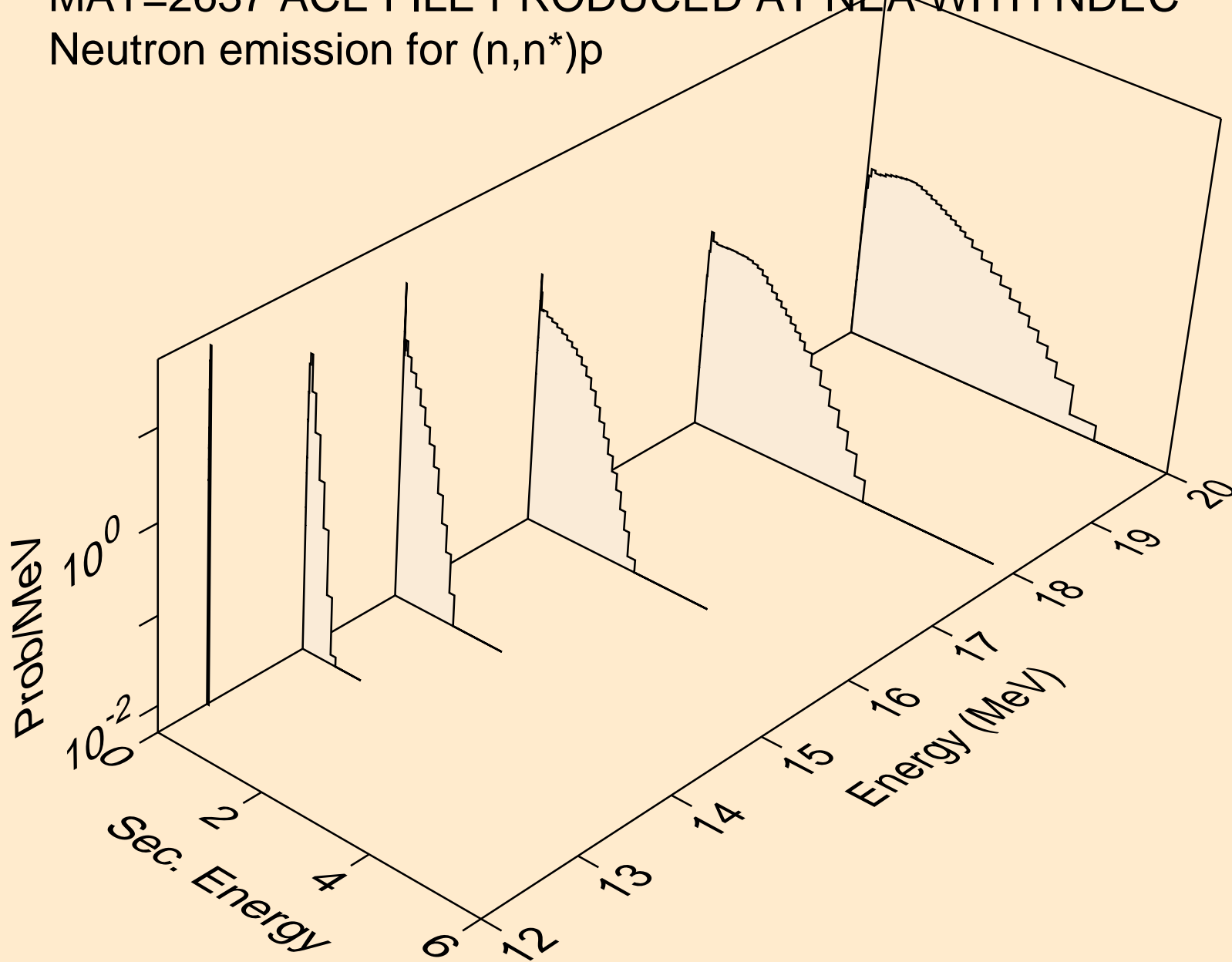

MAT=2637 ACE FILE PRODUCED AT NEA WITH NDEC  
Neutron emission for (n,n\*c)

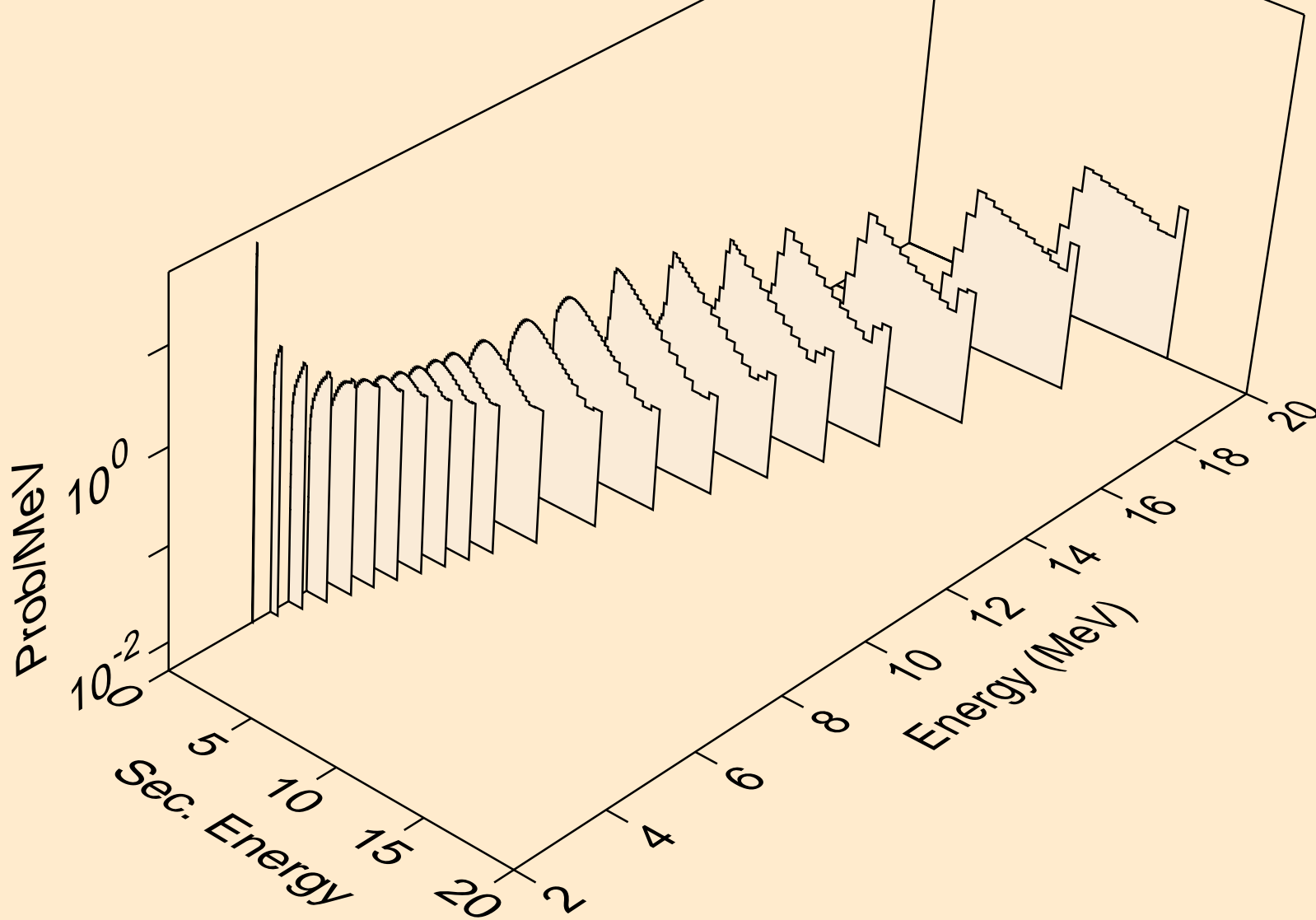

MAT=2637 ACE FILE PRODUCED AT NEA WITH NDEC  
Photon emission for (n,x)

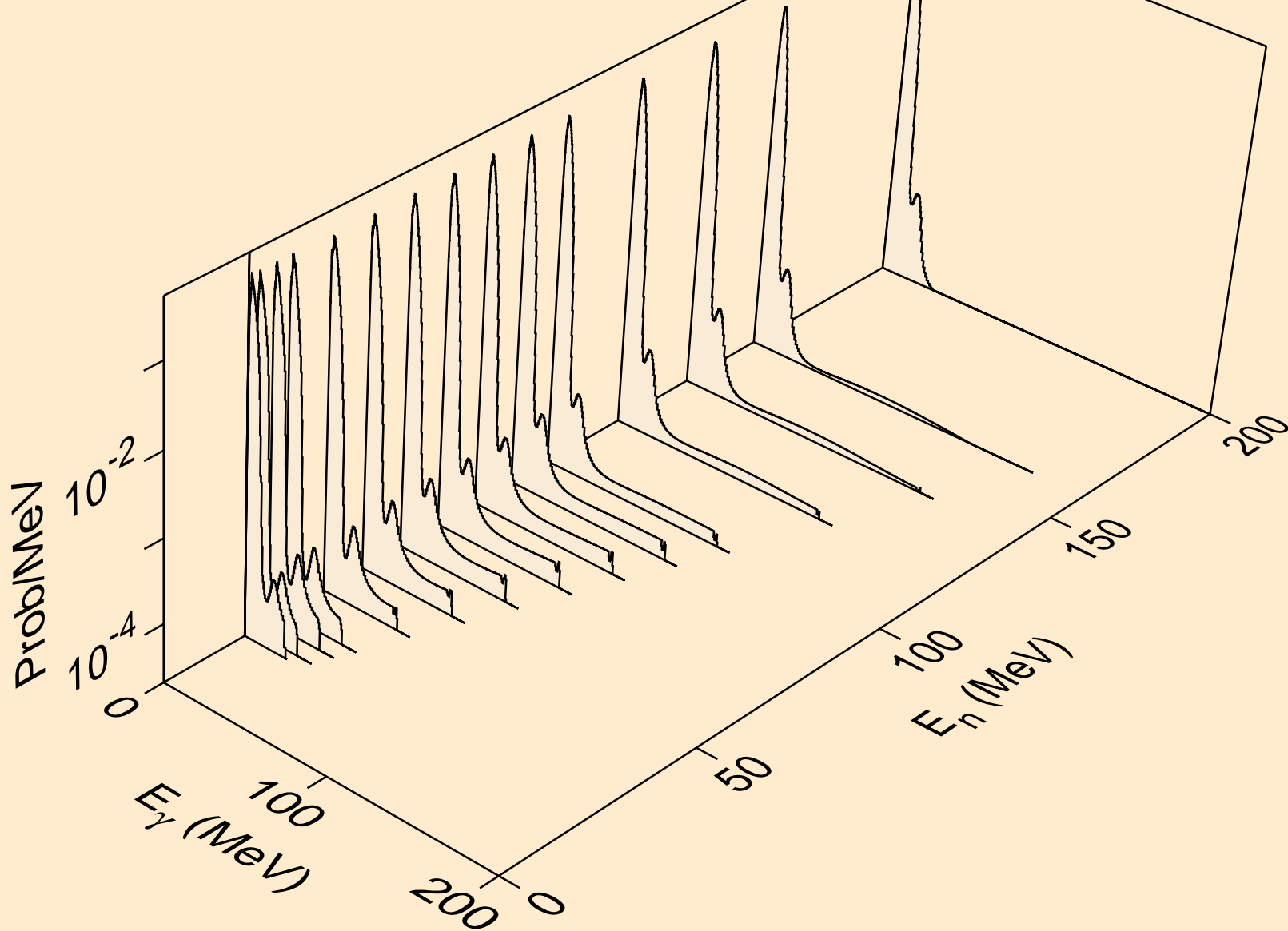

MAT=2637 ACE FILE PRODUCED AT NEA WITH NDEC  
Photon emission for (n,2n)

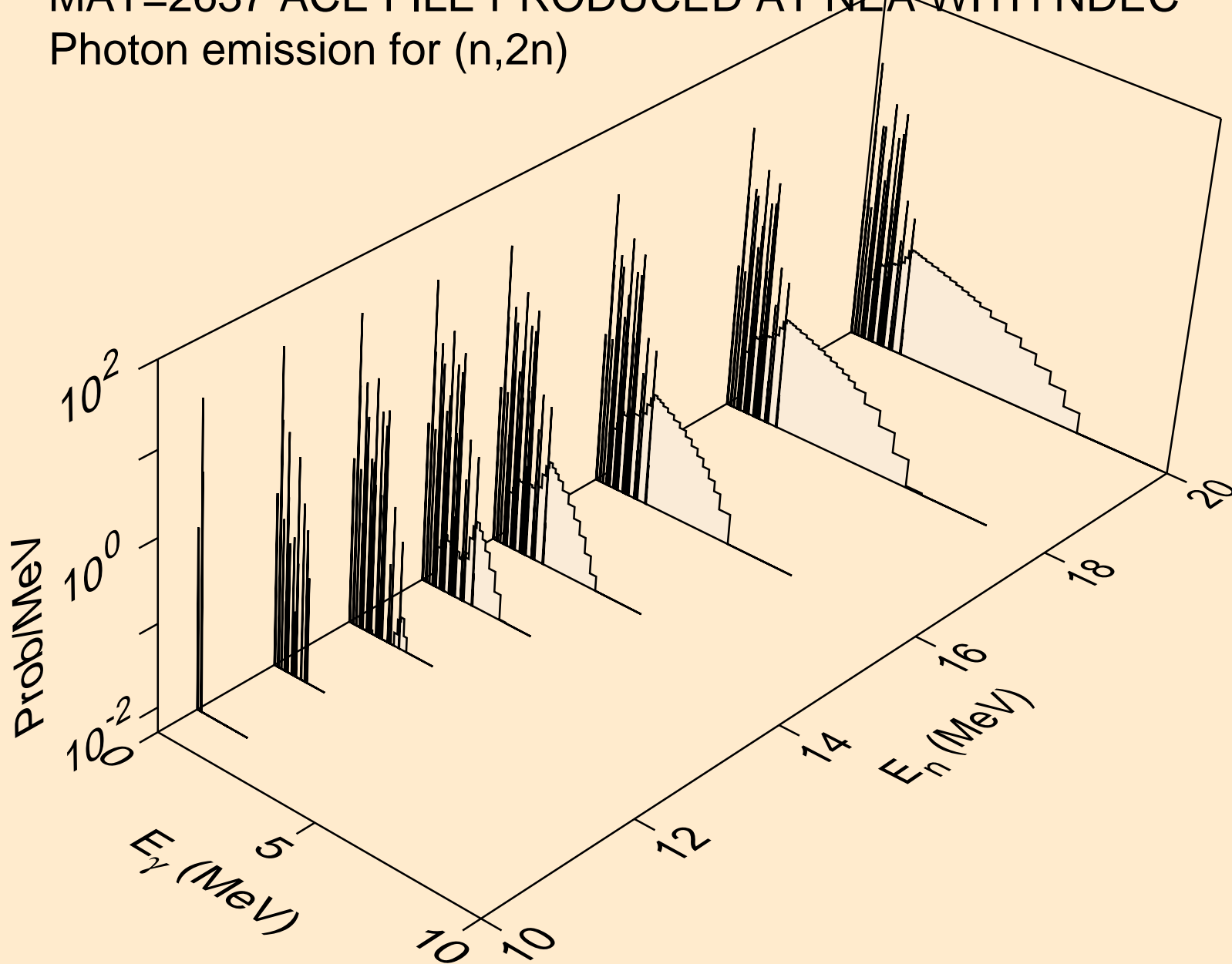

MAT=2637 ACE FILE PRODUCED AT NEA WITH NDEC  
Photon emission for (n,3n)

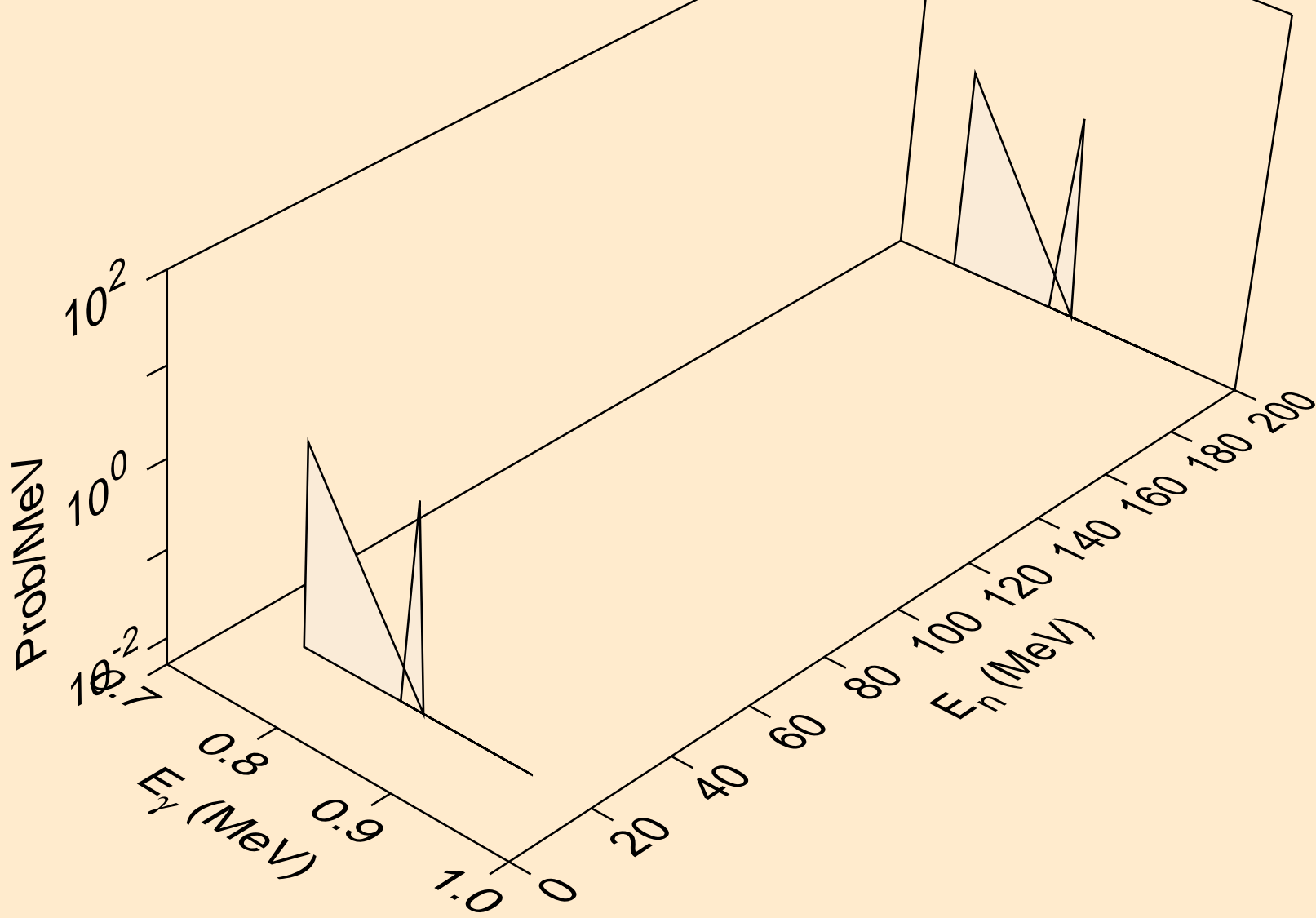

MAT=2637 ACE FILE PRODUCED AT NEA WITH NDEC  
Photon emission for (n,n\*)a

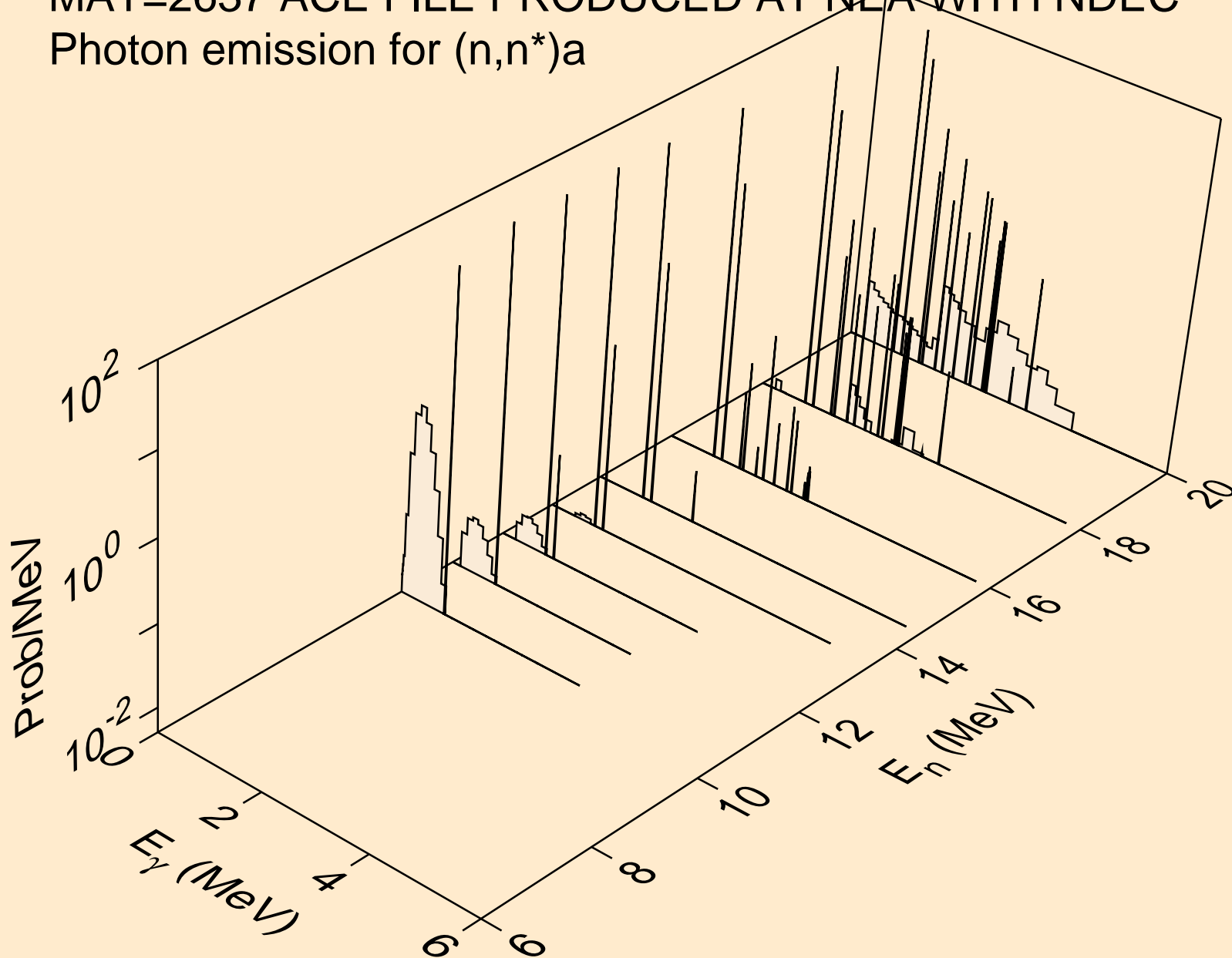

MAT=2637 ACE FILE PRODUCED AT NEA WITH NDEC  
Photon emission for (n,n\*)p

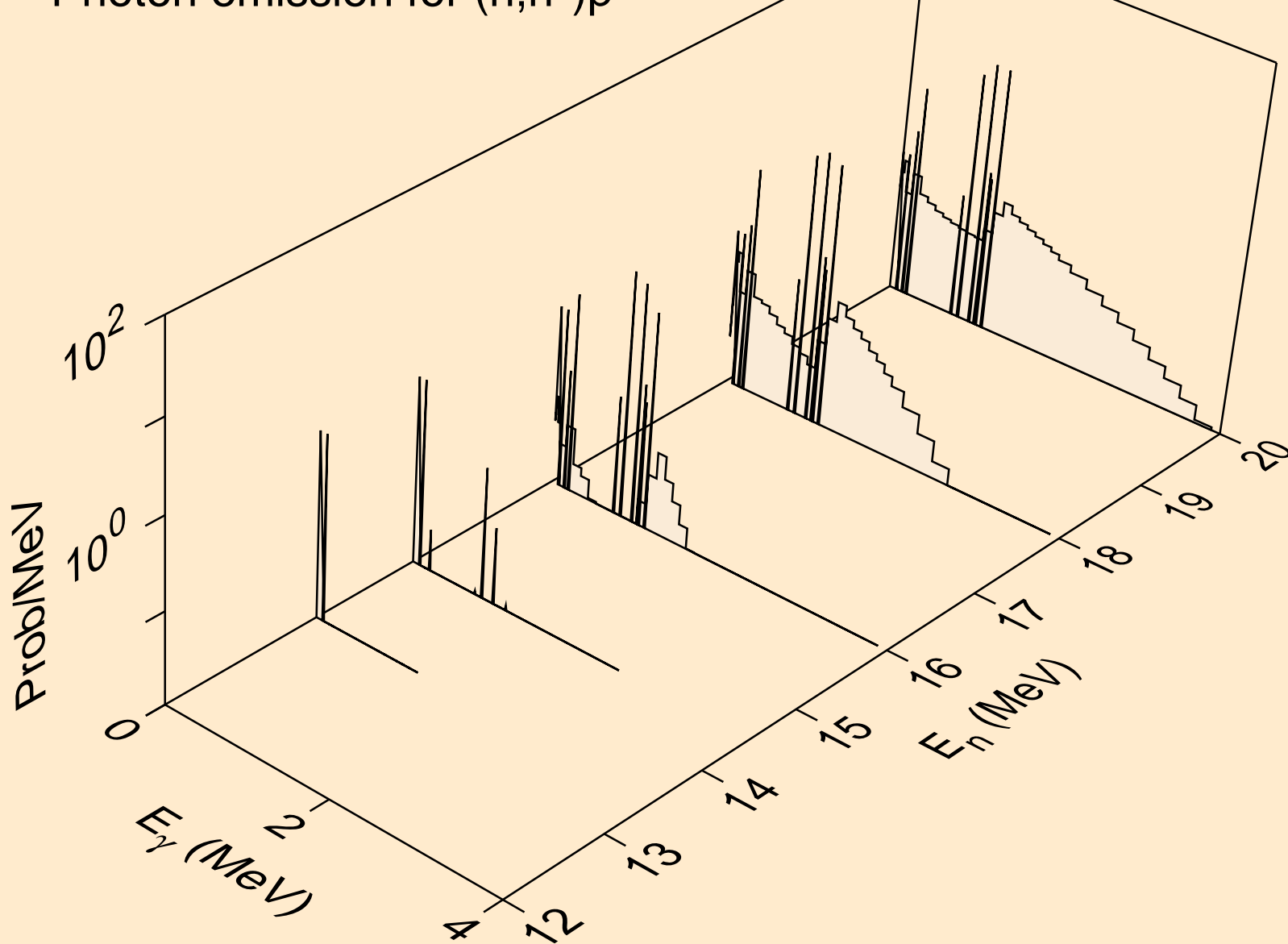

MAT=2637 ACE FILE PRODUCED AT NEA WITH NDEC  
Photon emission for (n,n\*1)

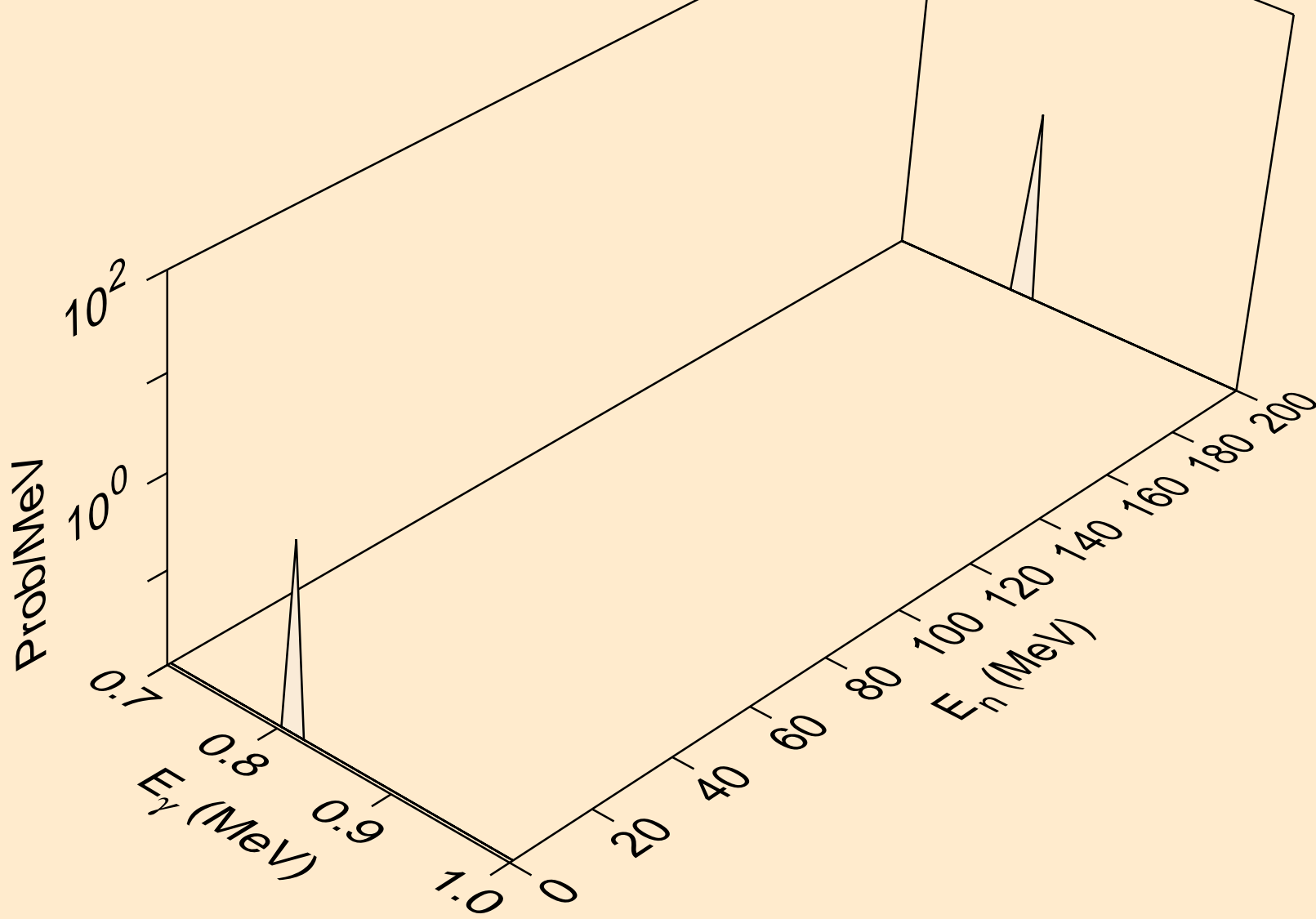



MAT=2637 ACE FILE PRODUCED AT NEA WITH NDEC  
Photon emission for (n,n\*2)

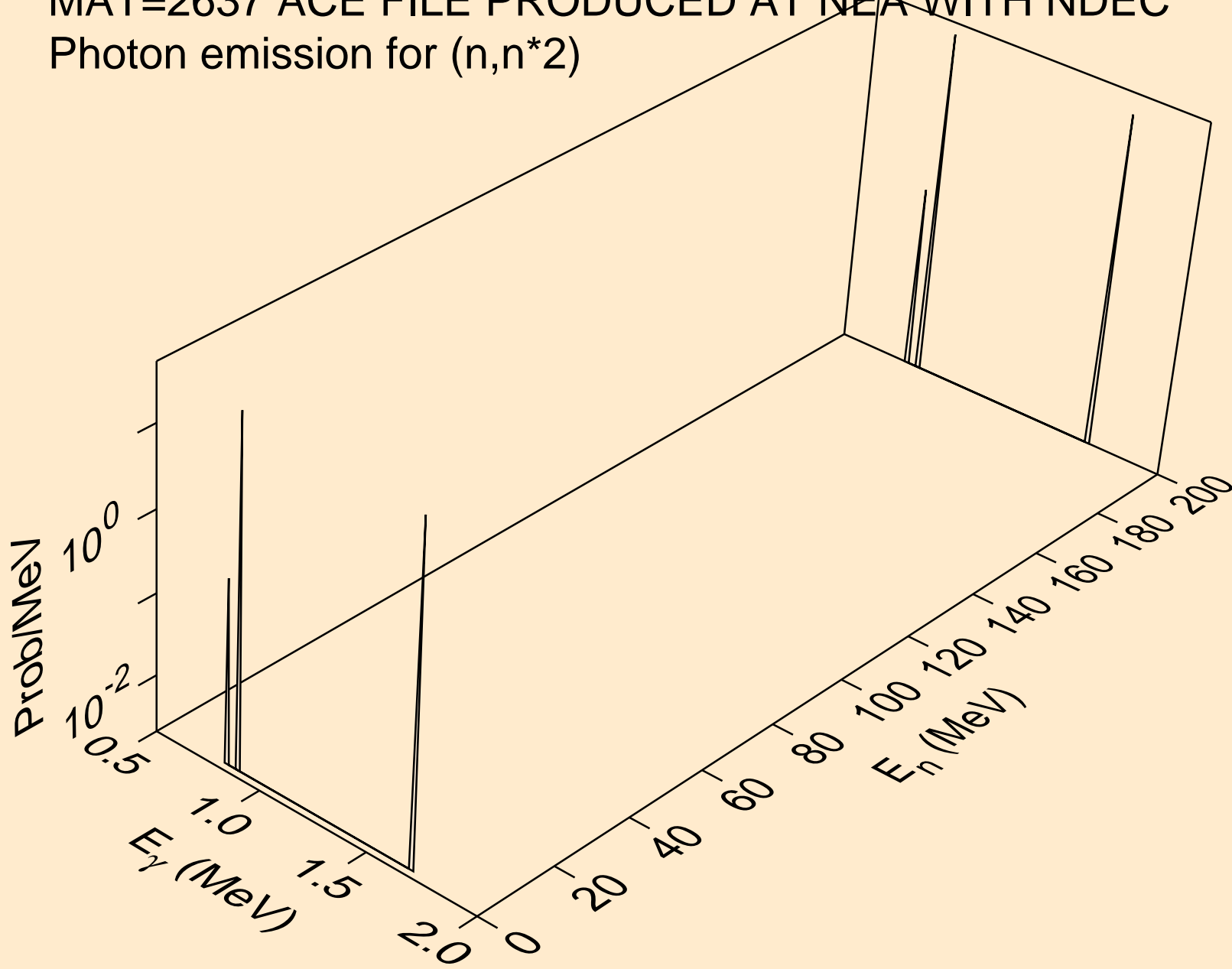

MAT=2637 ACE FILE PRODUCED AT NEA WITH NDEC  
Photon emission for (n,n\*3)

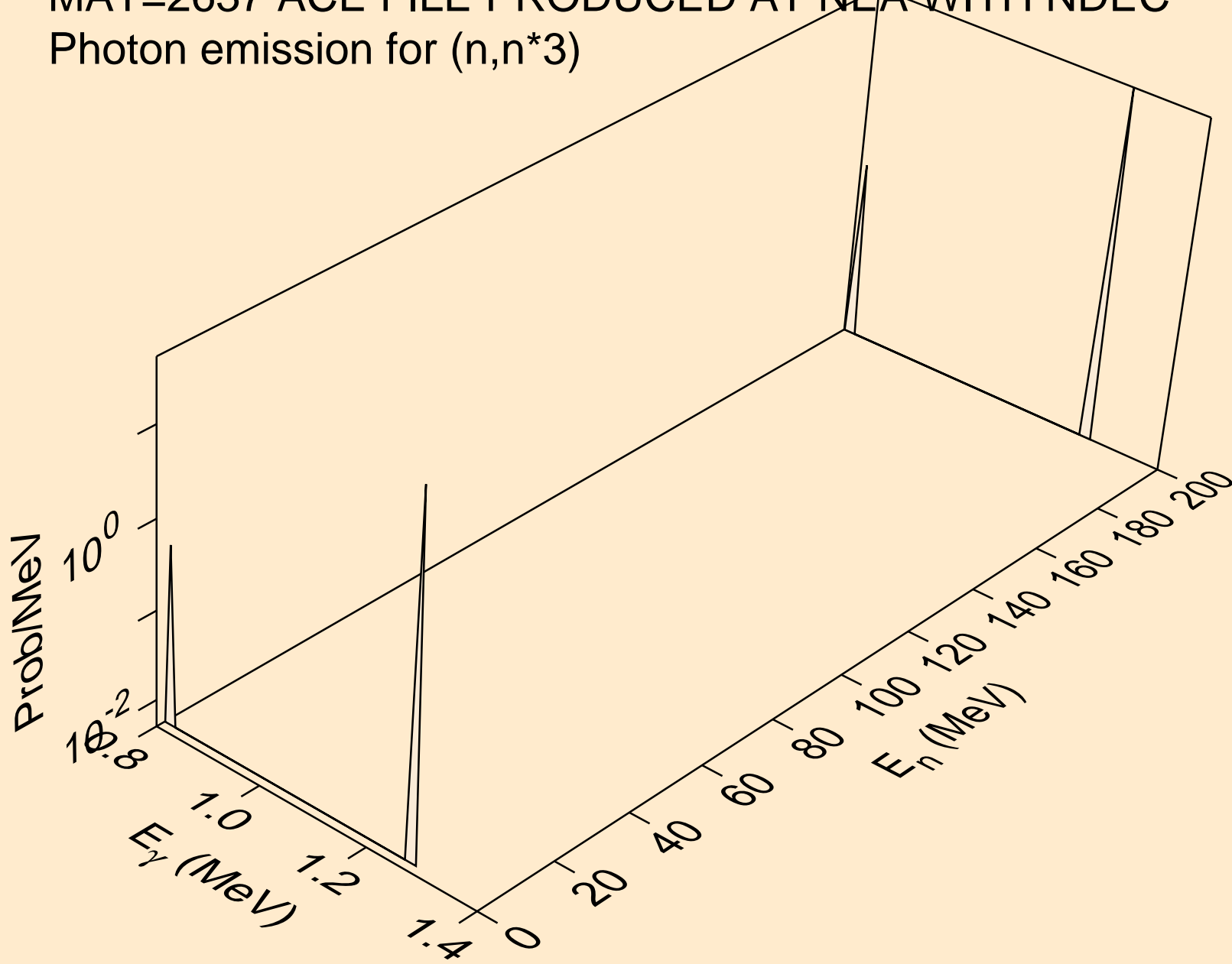

MAT=2637 ACE FILE PRODUCED AT NEA WITH NDEC  
Photon emission for (n,n\*4)

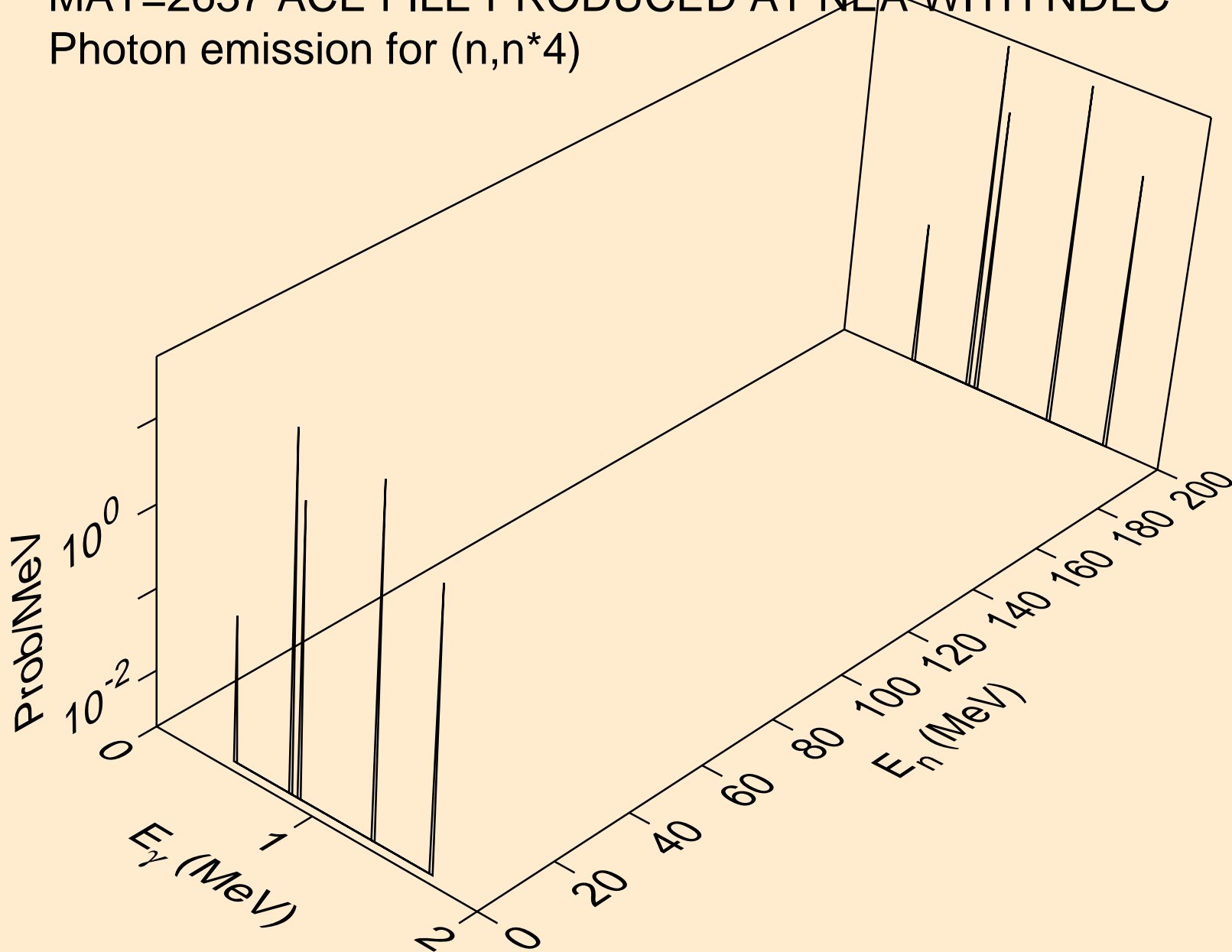

MAT=2637 ACE FILE PRODUCED AT NEA WITH NDEC  
Photon emission for (n,n\*5)

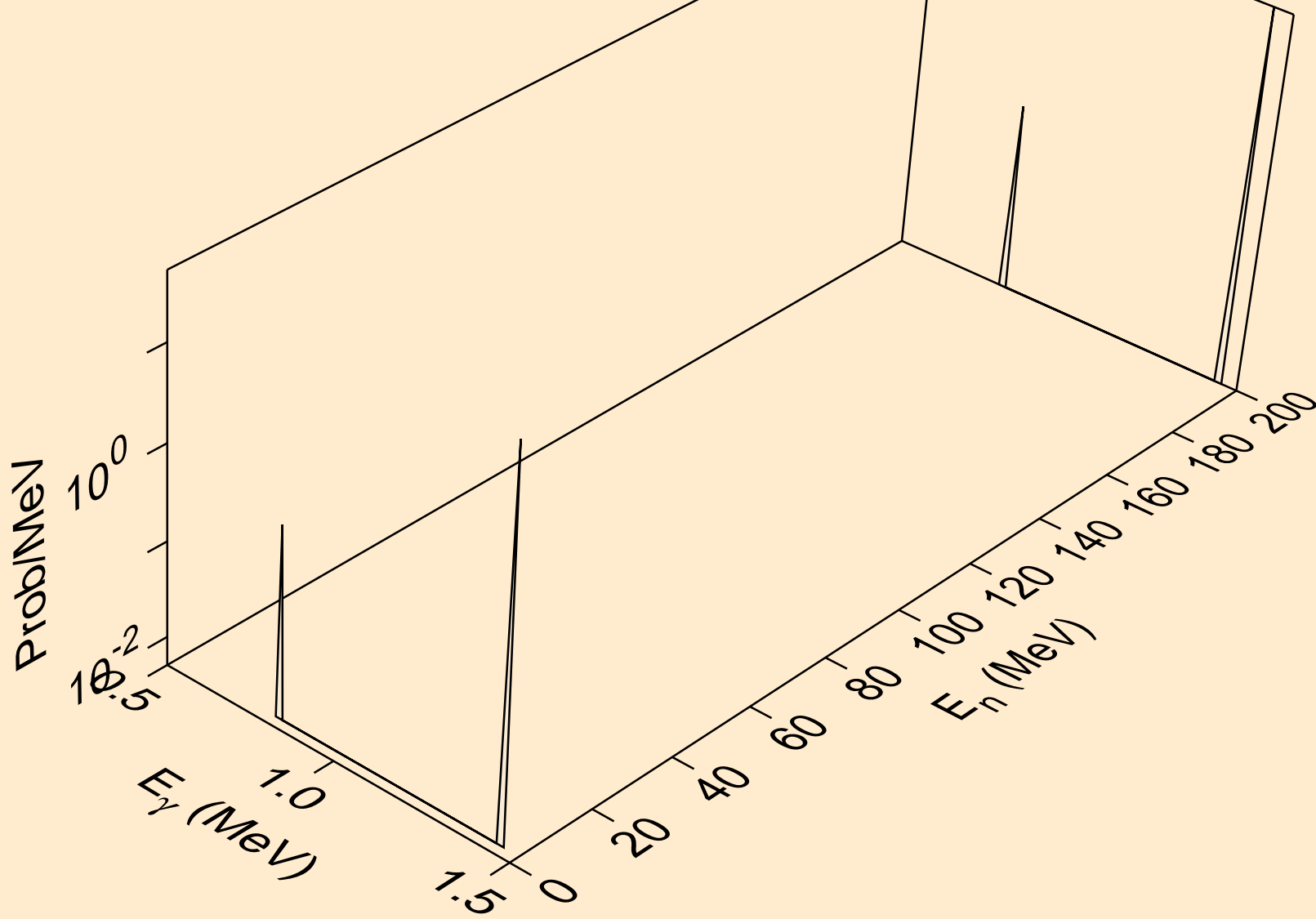

MAT=2637 ACE FILE PRODUCED AT NEA WITH NDEC  
Photon emission for (n,n\*6)

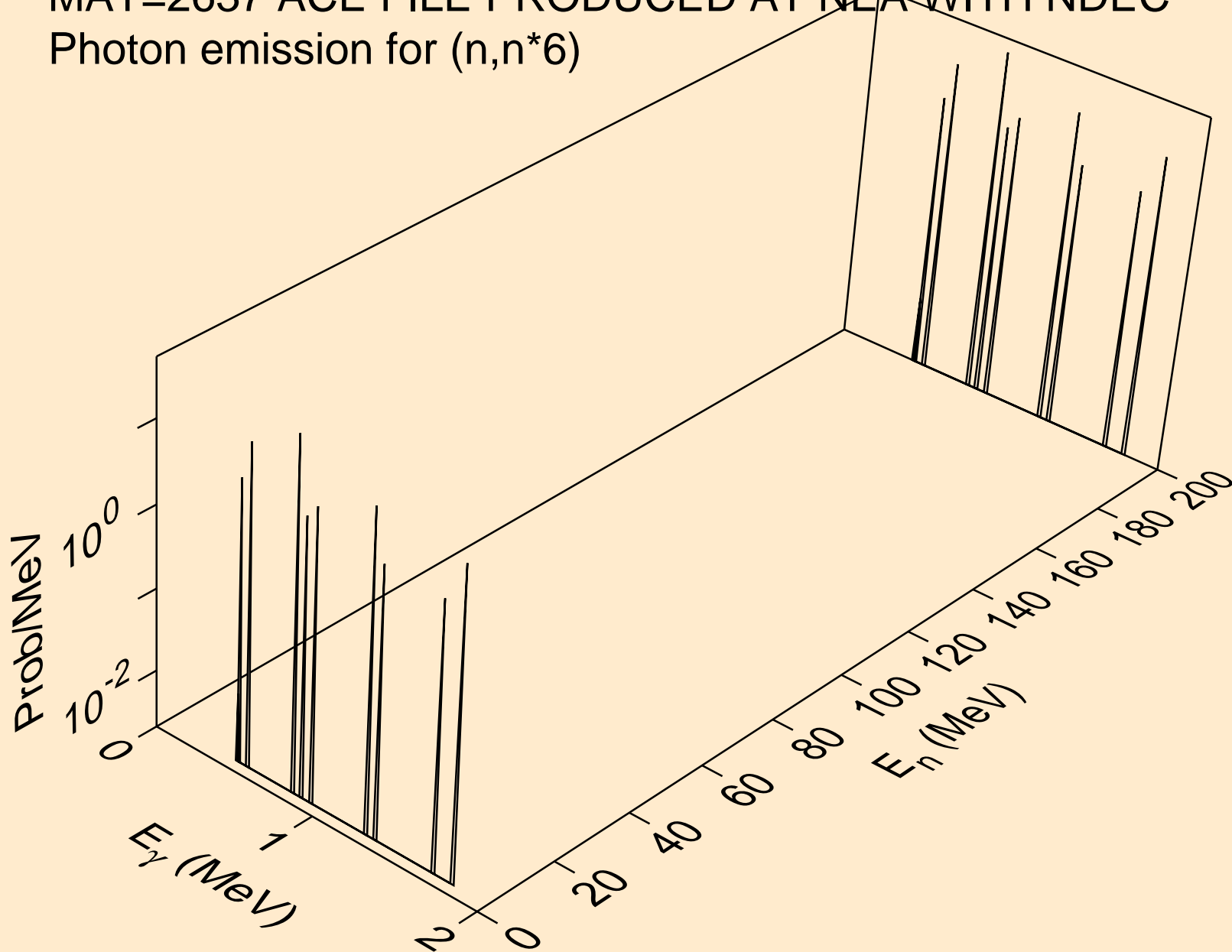

MAT=2637 ACE FILE PRODUCED AT NEA WITH NDEC  
Photon emission for (n,n\*7)

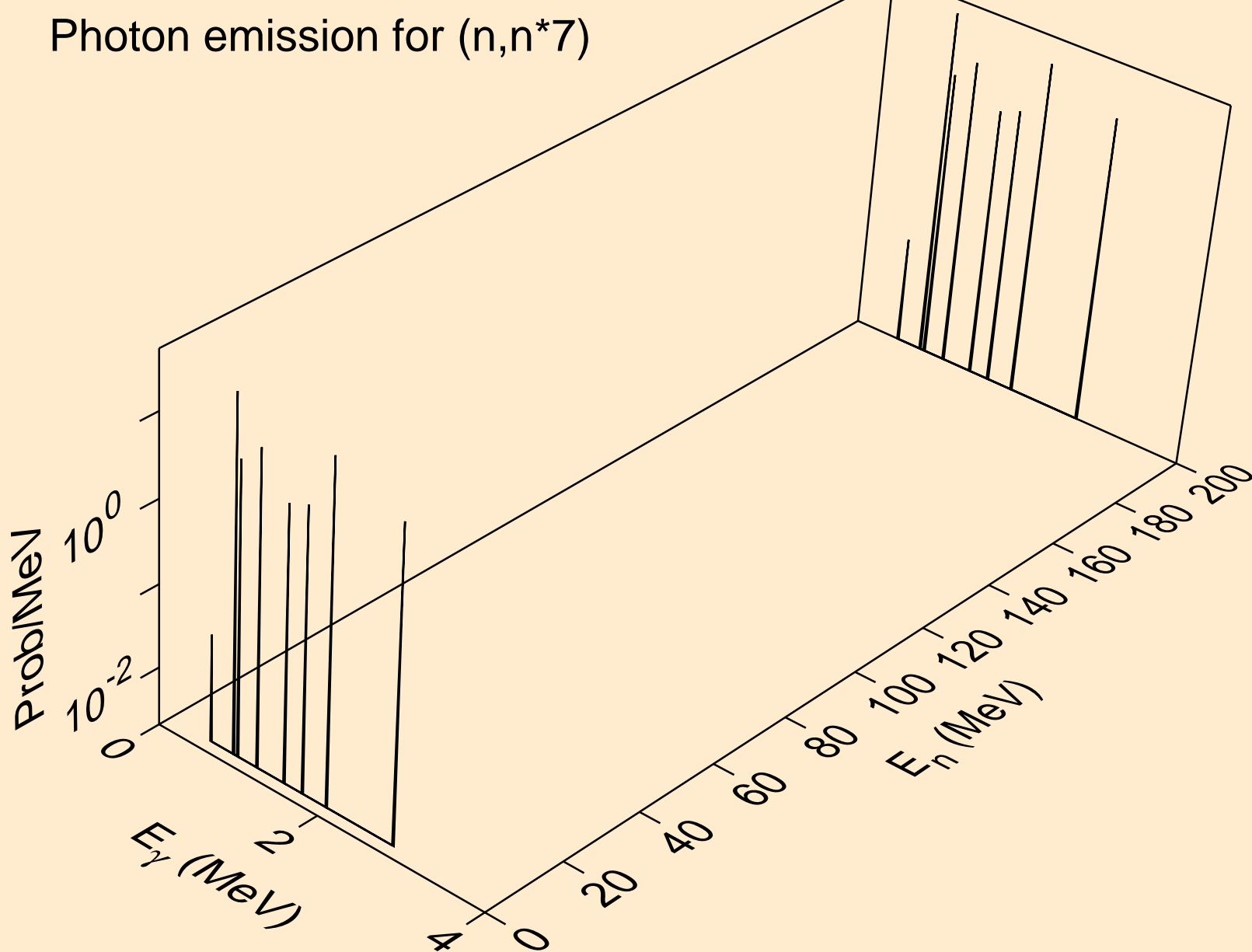

MAT=2637 ACE FILE PRODUCED AT NEA WITH NDEC  
Photon emission for (n,n\*8)

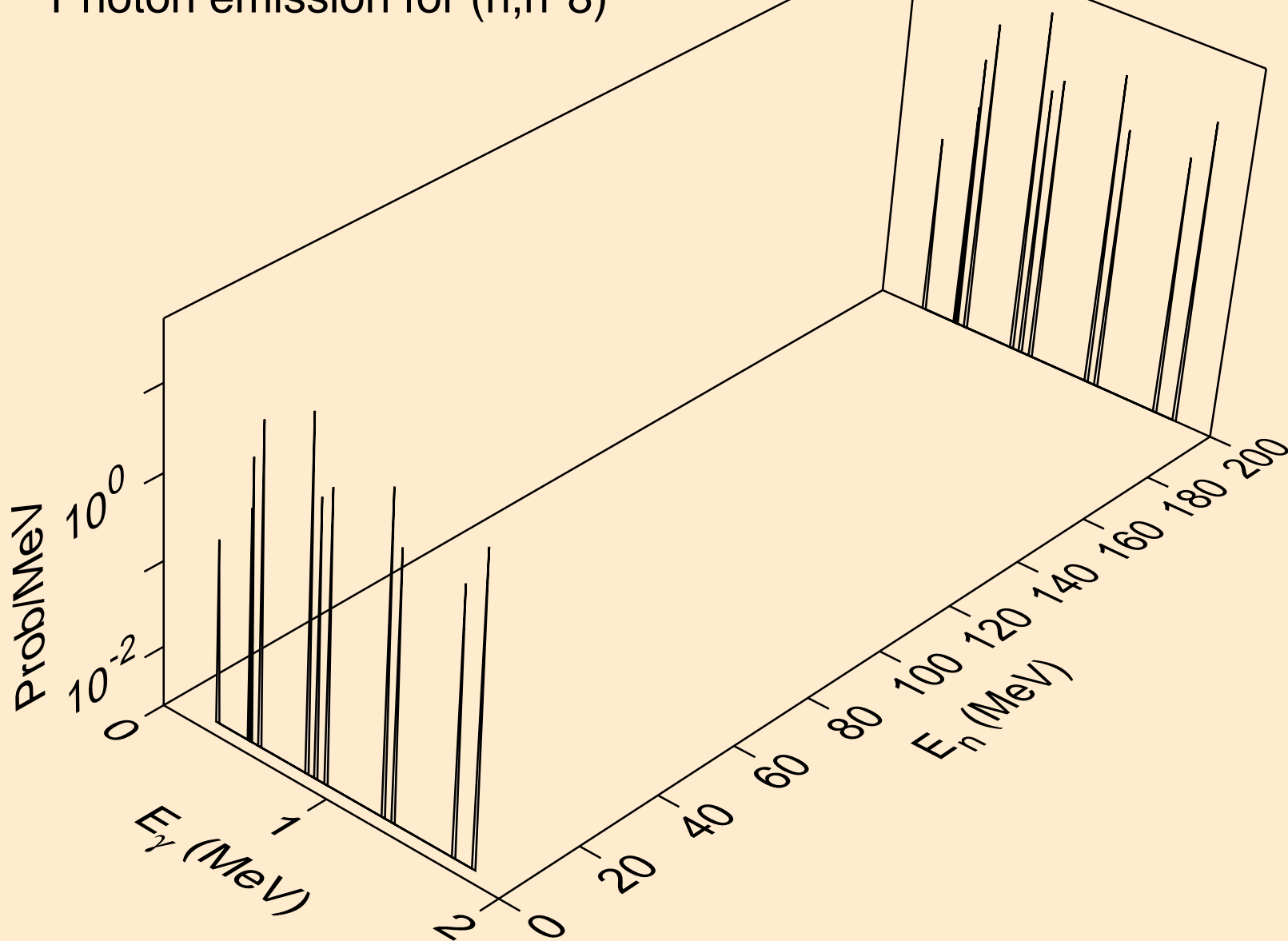

MAT=2637 ACE FILE PRODUCED AT NEA WITH NDEC  
Photon emission for (n,n\*9)

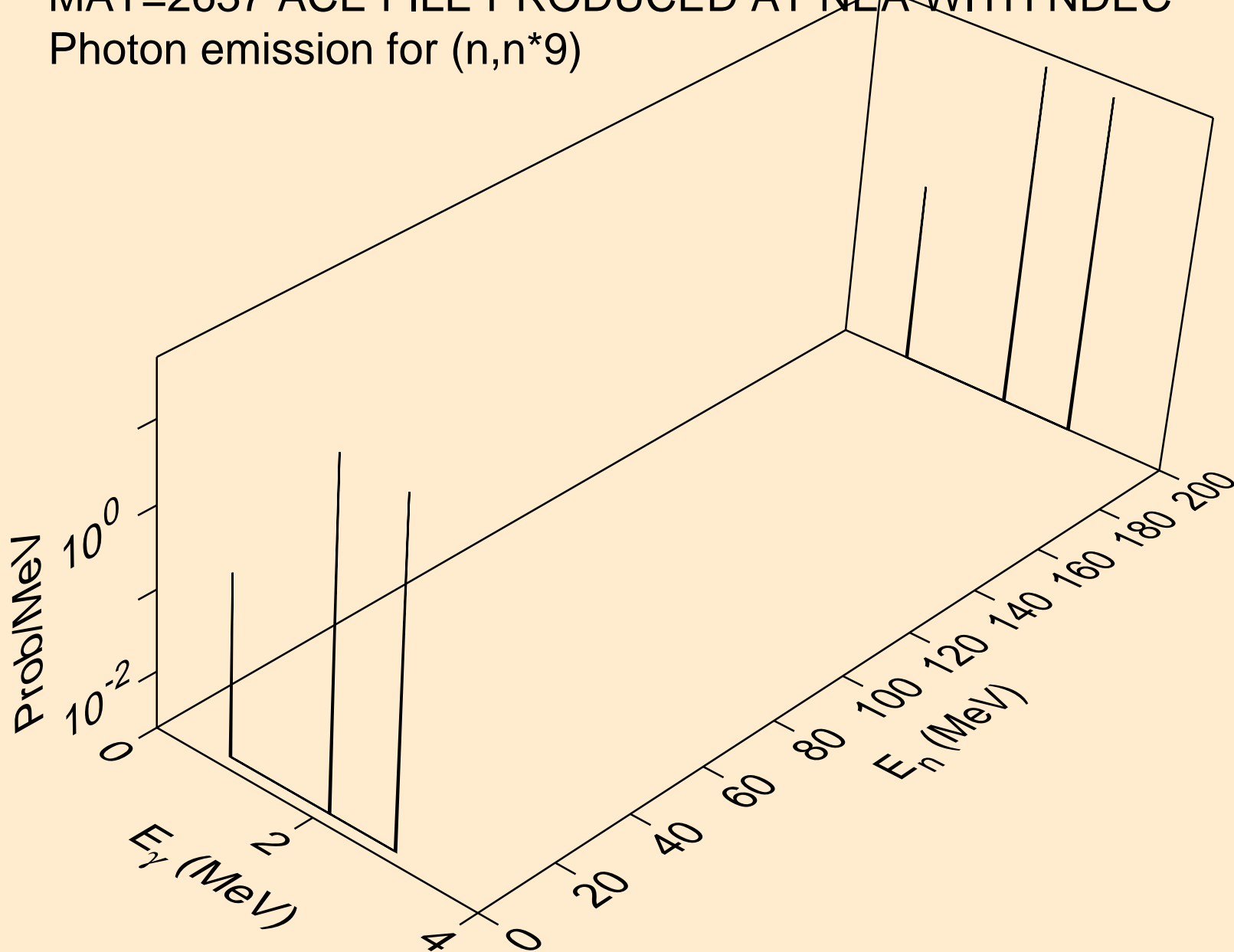



MAT=2637 ACE FILE PRODUCED AT NEA WITH NDEC  
Photon emission for (n,n\*10)

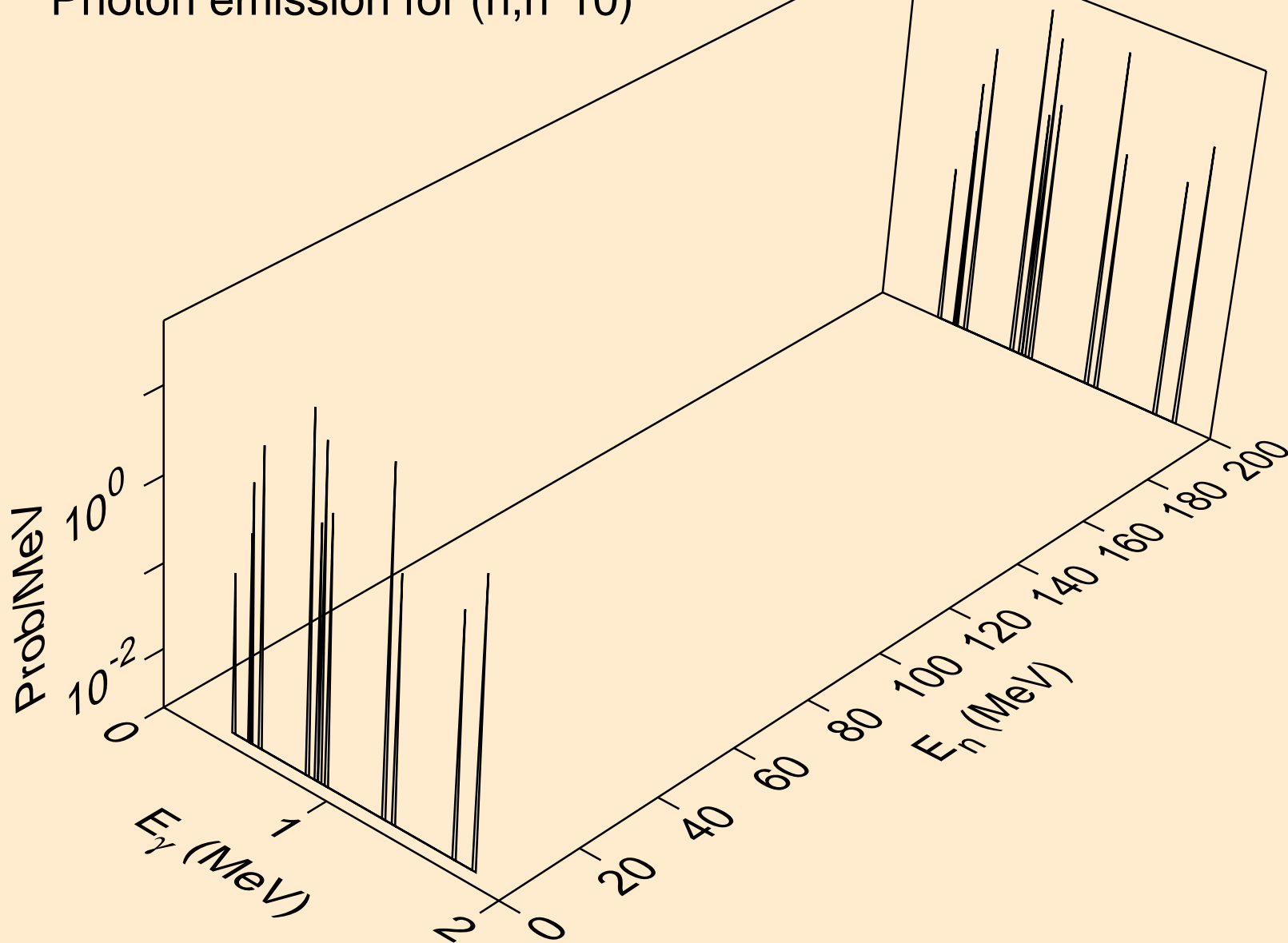

MAT=2637 ACE FILE PRODUCED AT NEA WITH NDEC  
Photon emission for (n,n\*11)

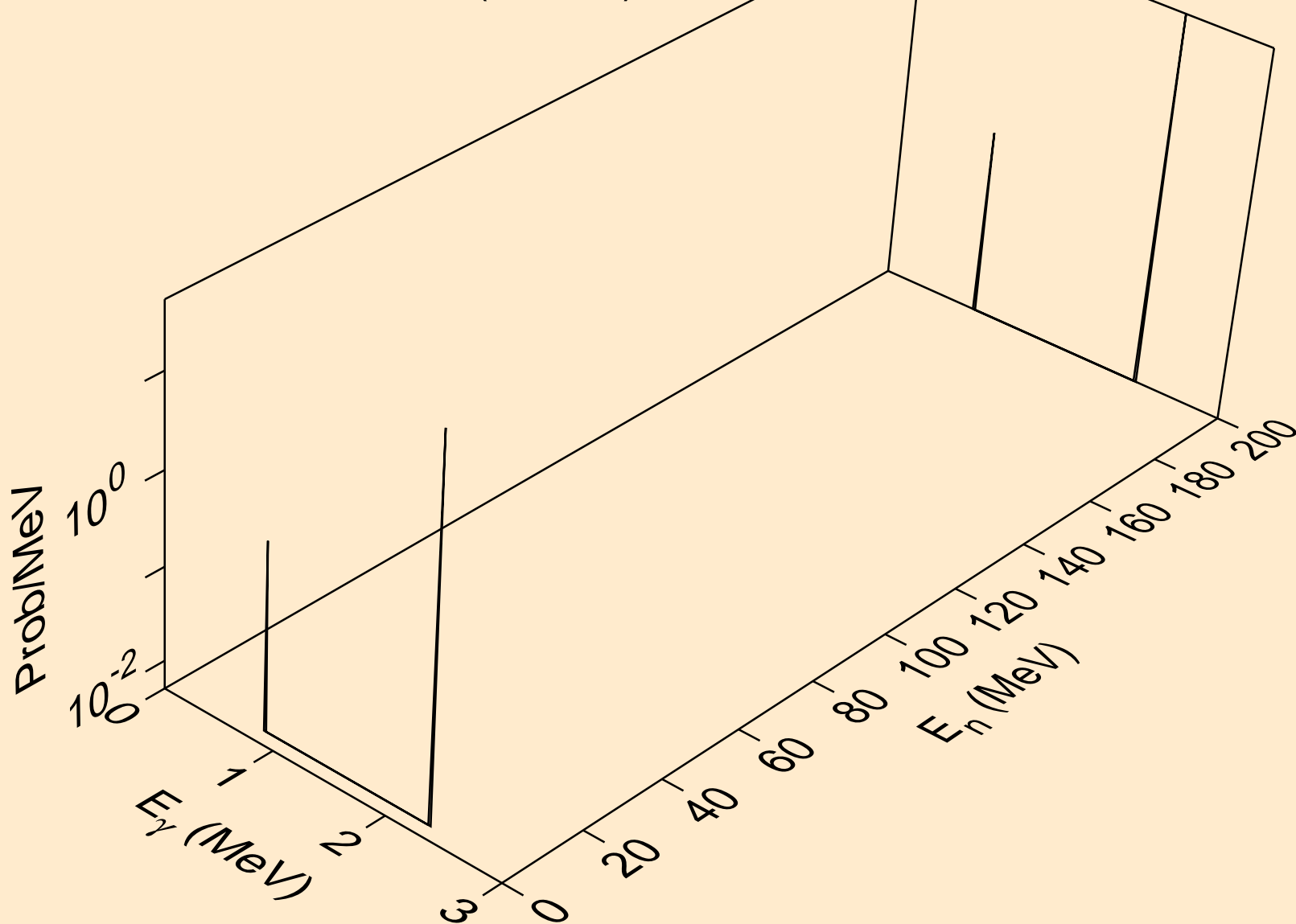

MAT=2637 ACE FILE PRODUCED AT NEA WITH NDEC  
Photon emission for (n,n\*12)

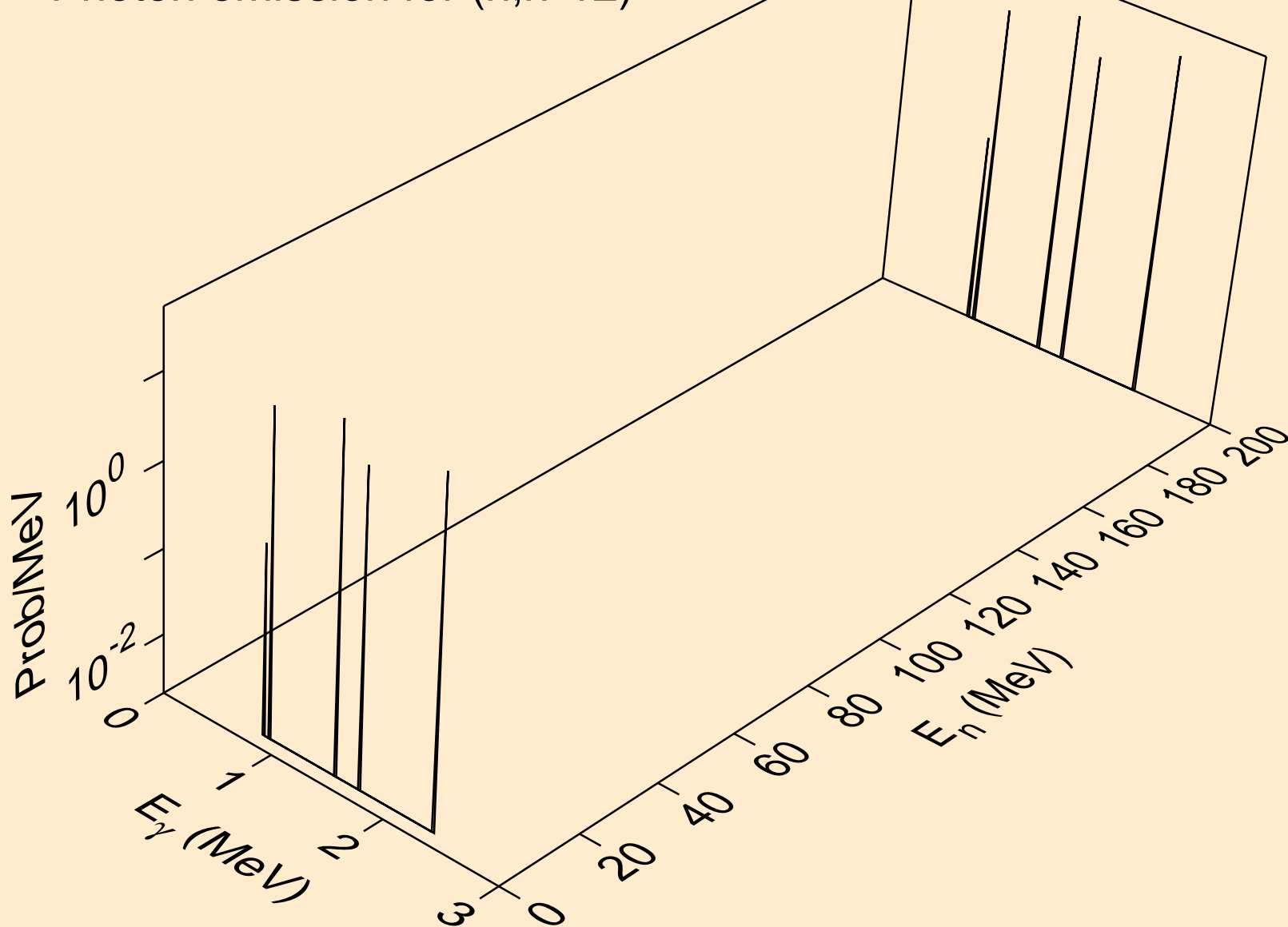

MAT=2637 ACE FILE PRODUCED AT NEA WITH NDEC  
Photon emission for (n,n\*13)

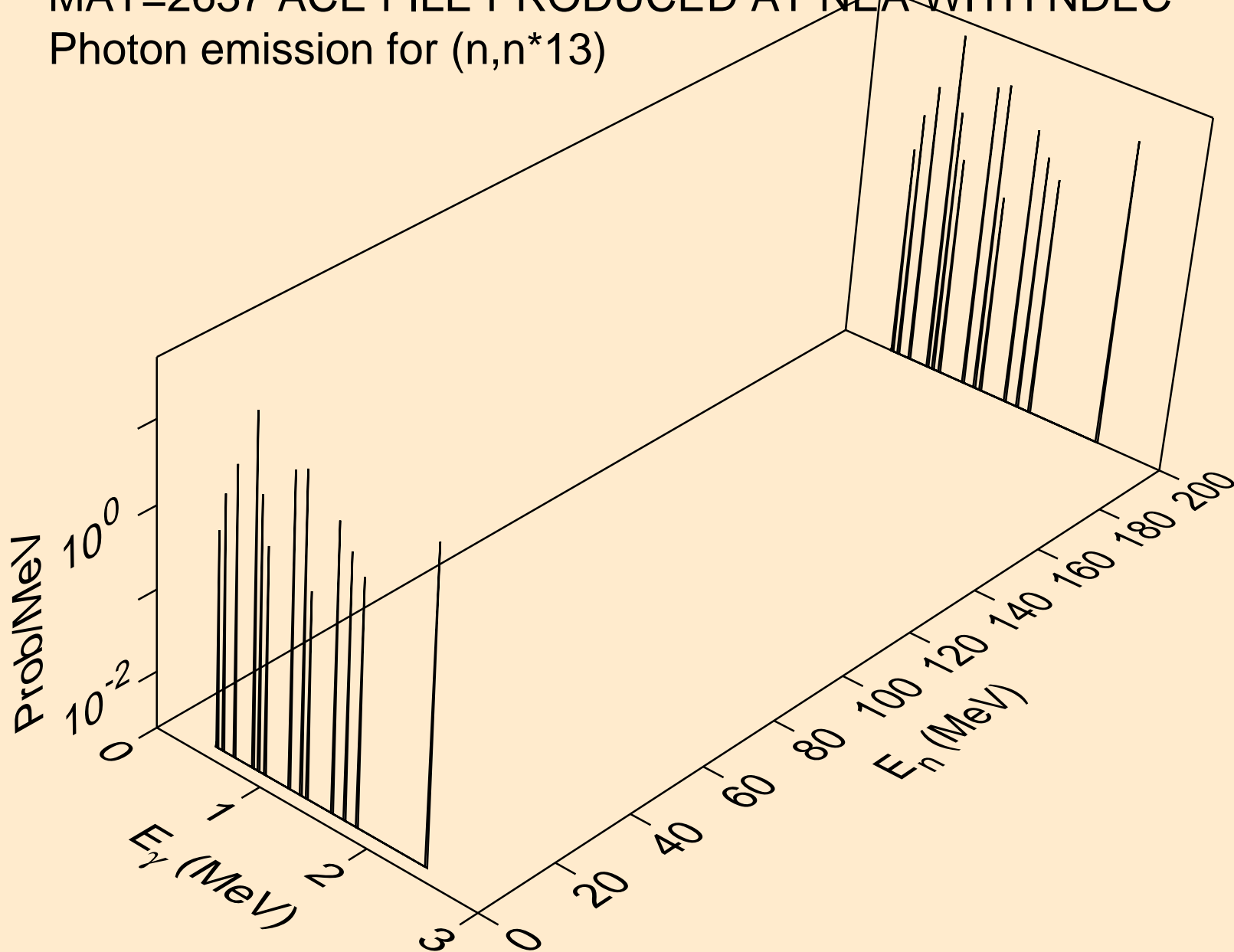

MAT=2637 ACE FILE PRODUCED AT NEA WITH NDEC  
Photon emission for (n,n\*14)

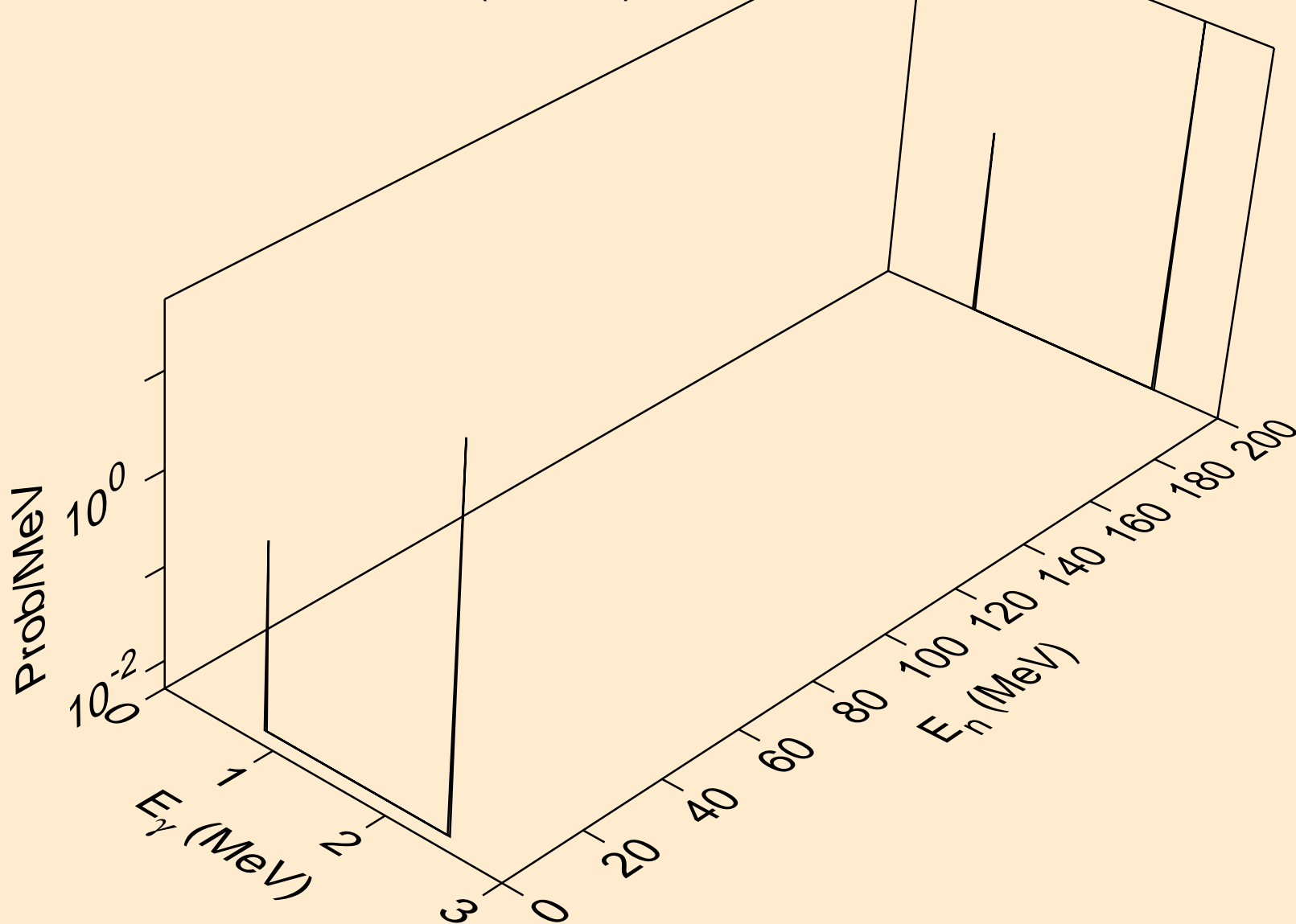

MAT=2637 ACE FILE PRODUCED AT NEA WITH NDEC  
Photon emission for (n,n\*15)

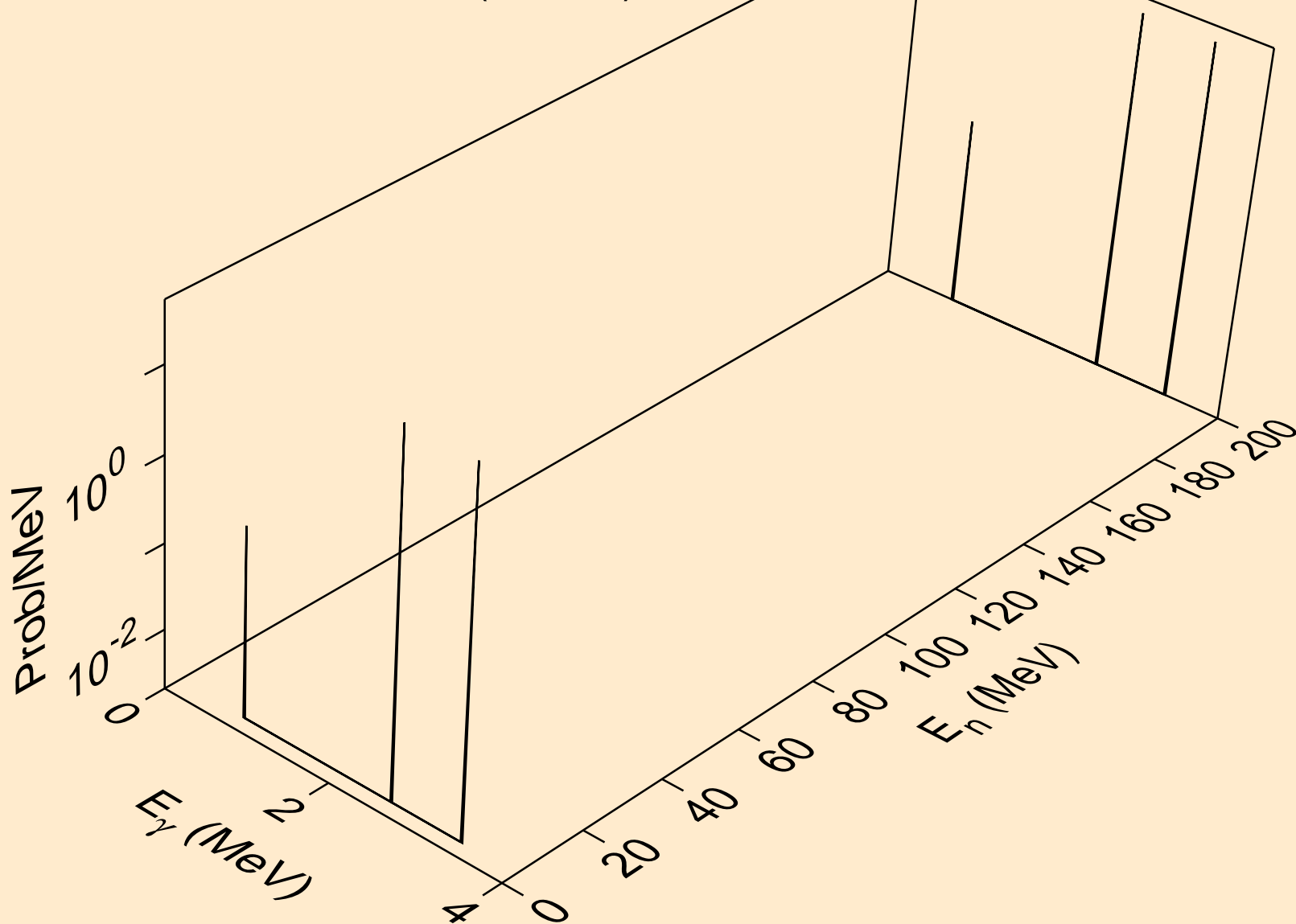

MAT=2637 ACE FILE PRODUCED AT NEA WITH NDEC  
Photon emission for (n,n\*16)

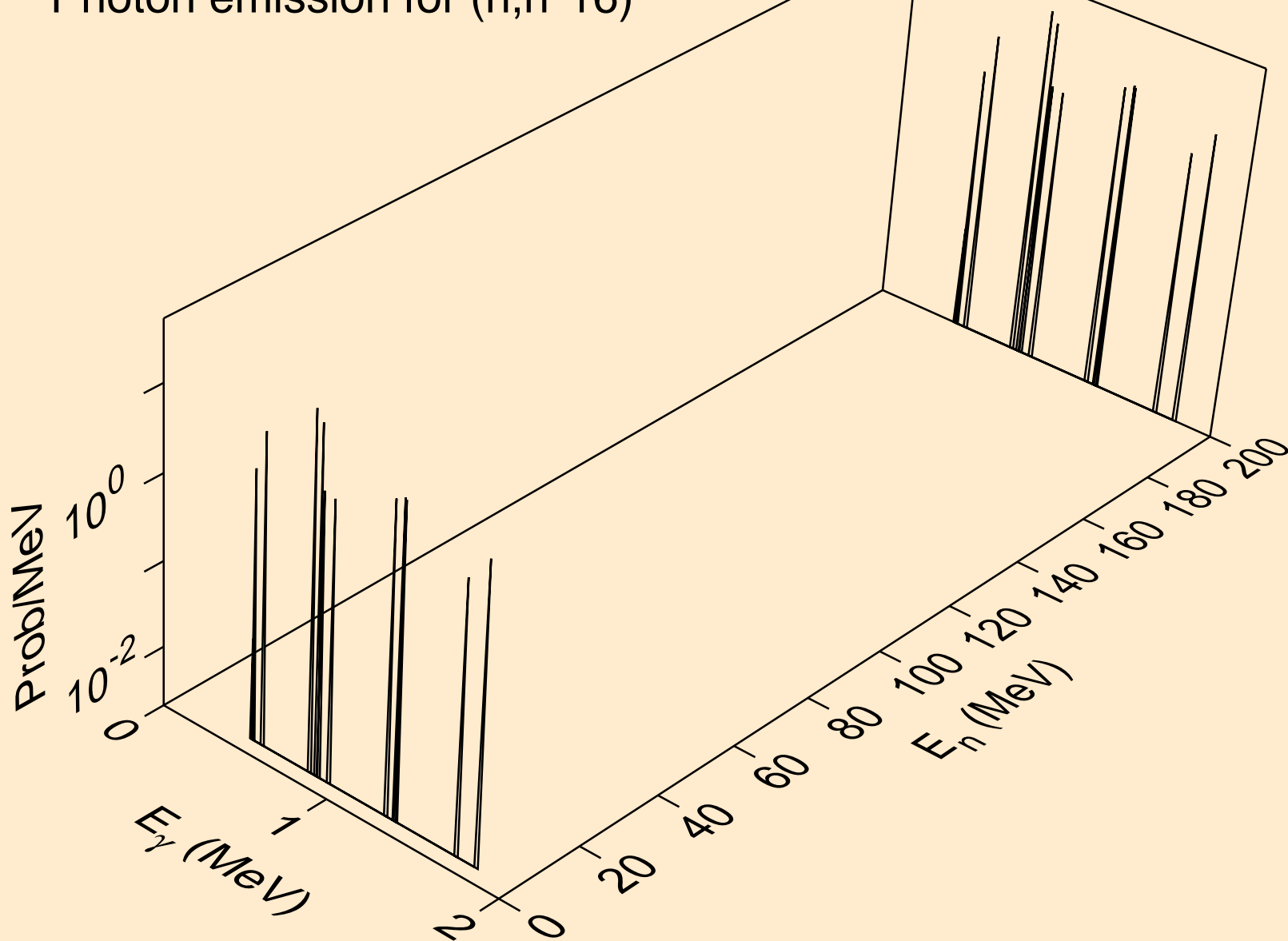

MAT=2637 ACE FILE PRODUCED AT NEA WITH NDEC  
Photon emission for (n,n\*17)

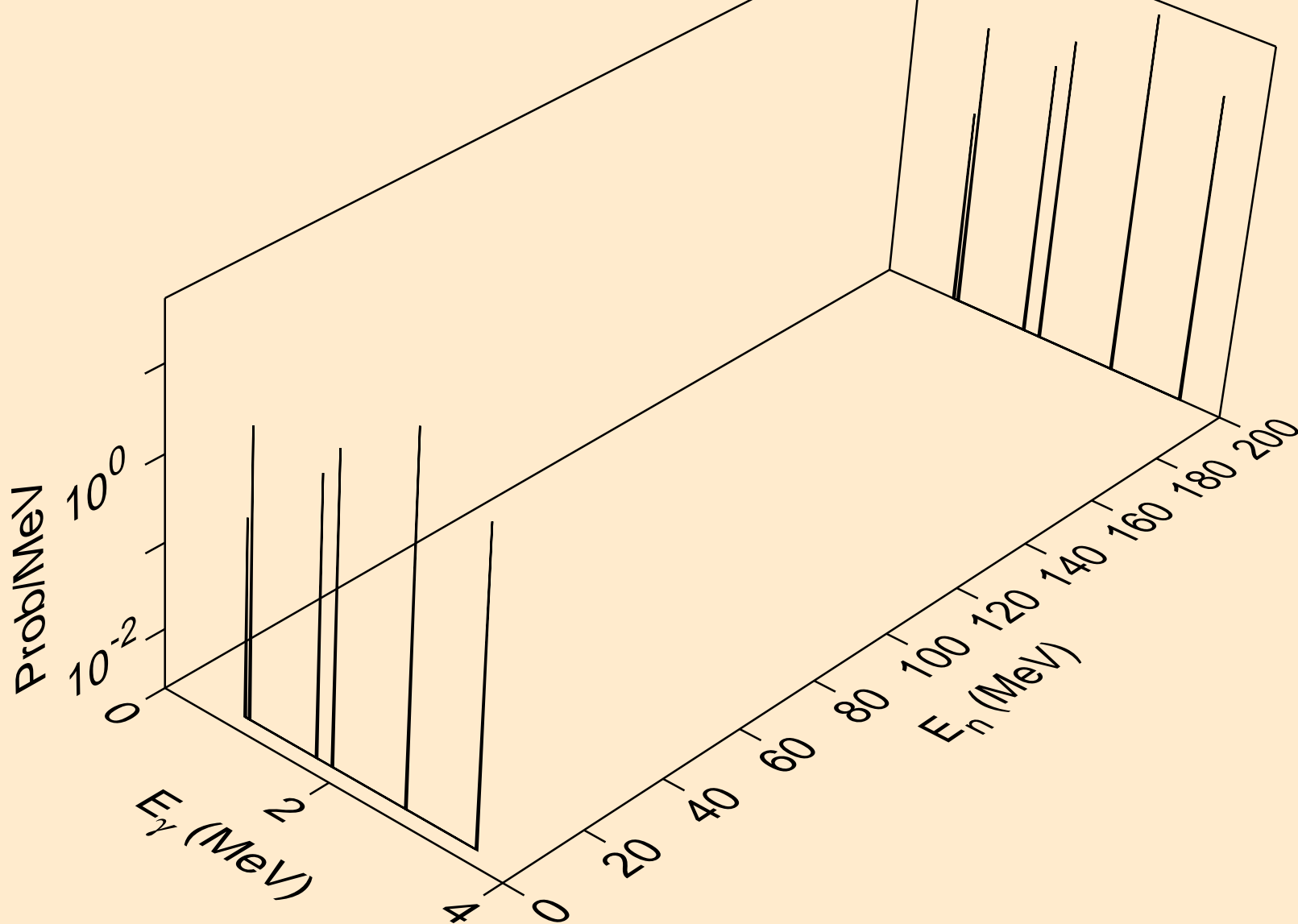



MAT=2637 ACE FILE PRODUCED AT NEA WITH NDEC  
Photon emission for (n,n\*18)

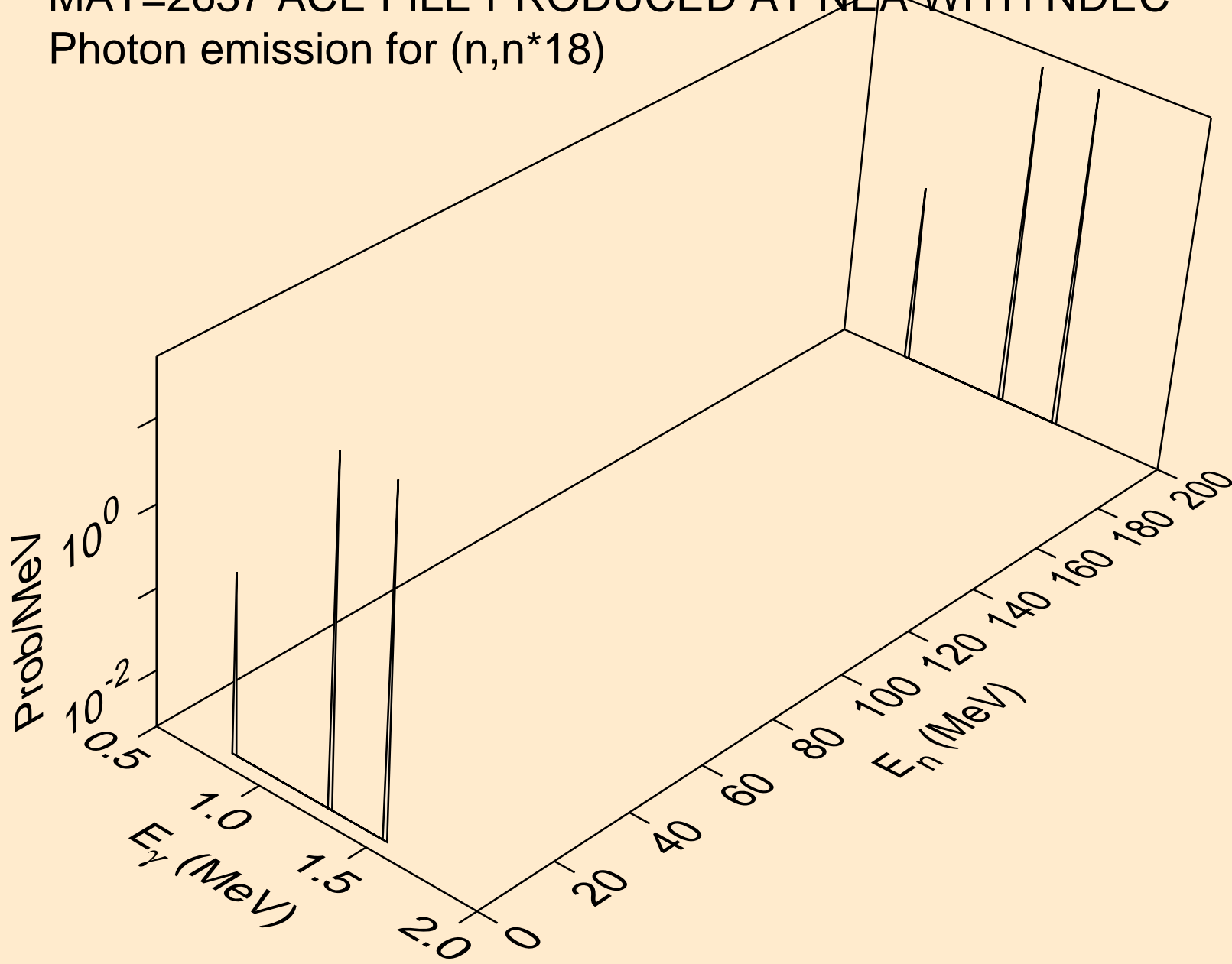

MAT=2637 ACE FILE PRODUCED AT NEA WITH NDEC  
Photon emission for (n,n\*19)

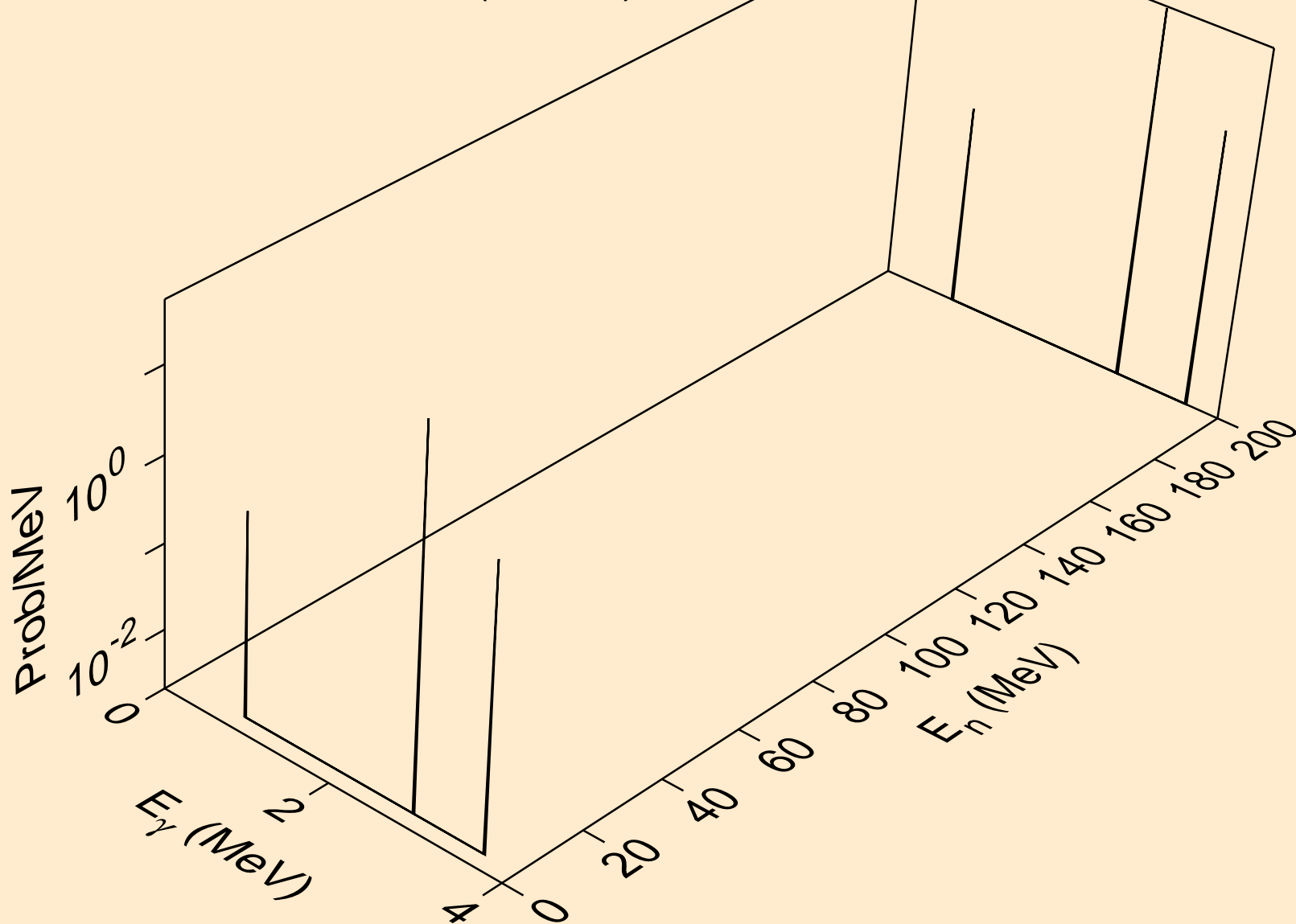

MAT=2637 ACE FILE PRODUCED AT NEA WITH NDEC  
Photon emission for (n,n\*20)

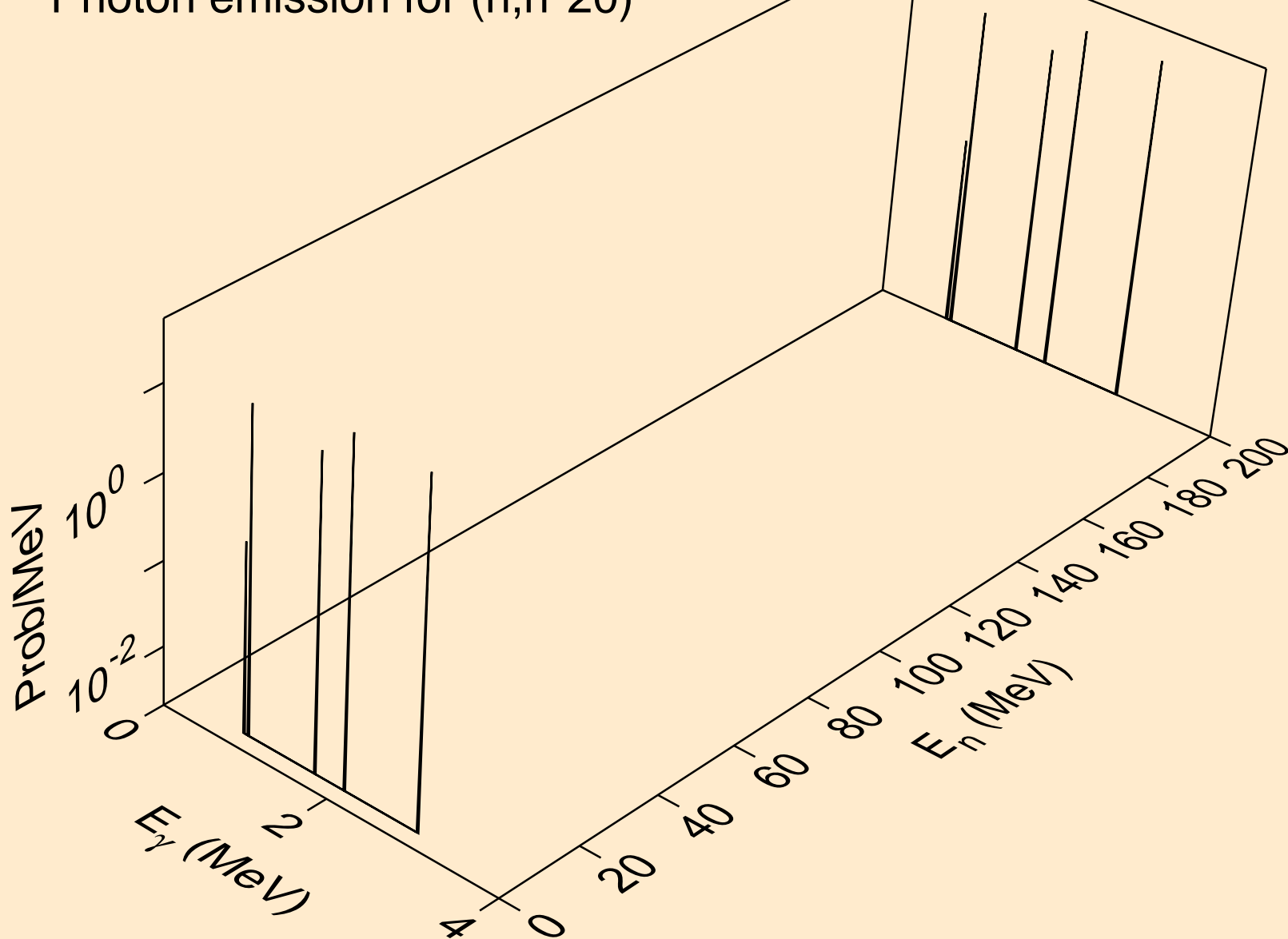

MAT=2637 ACE FILE PRODUCED AT NEA WITH NDEC  
Photon emission for (n,n\*c)

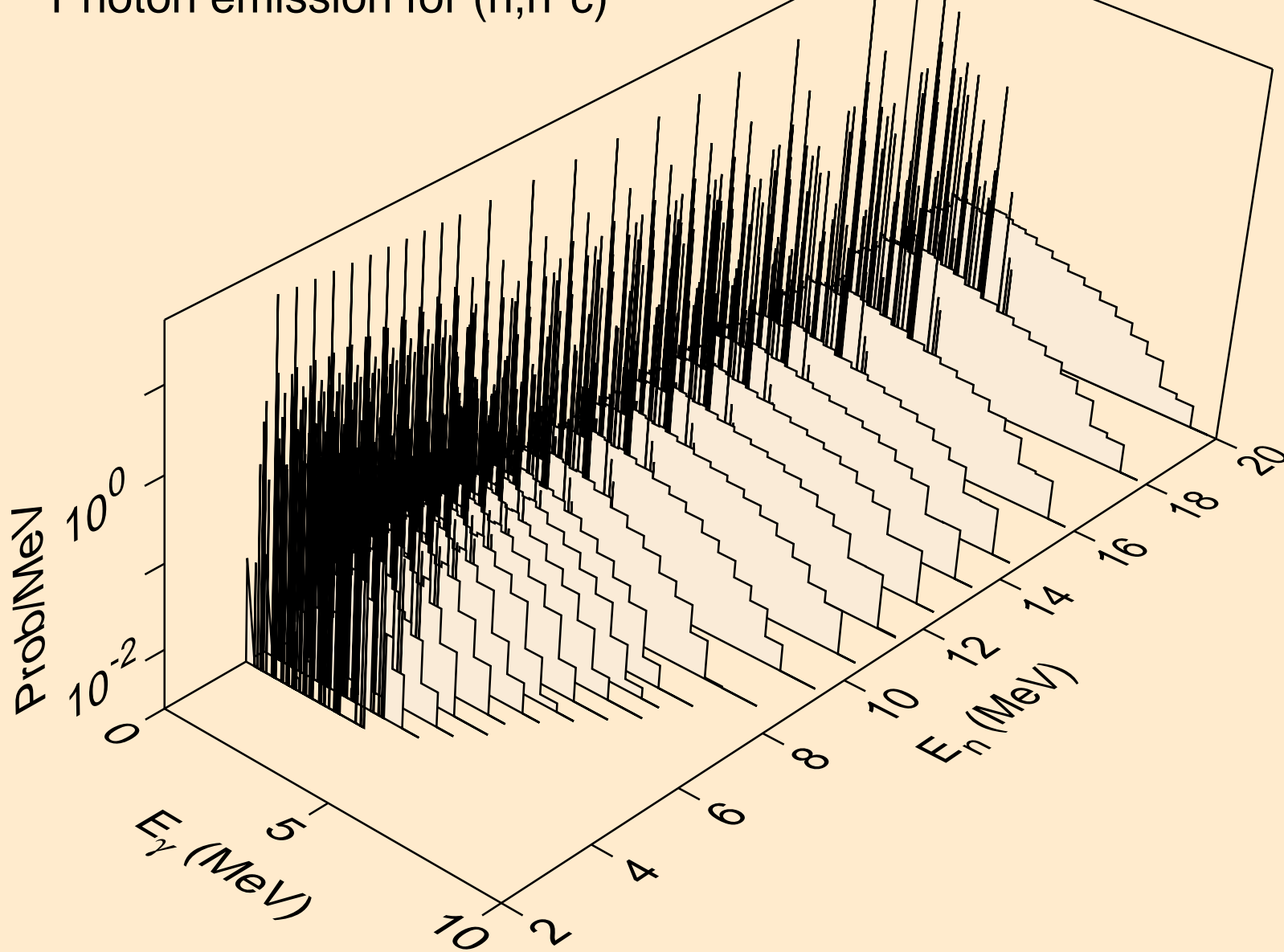

MAT=2637 ACE FILE PRODUCED AT NEA WITH NDEC  
Photon emission for (n,gma)

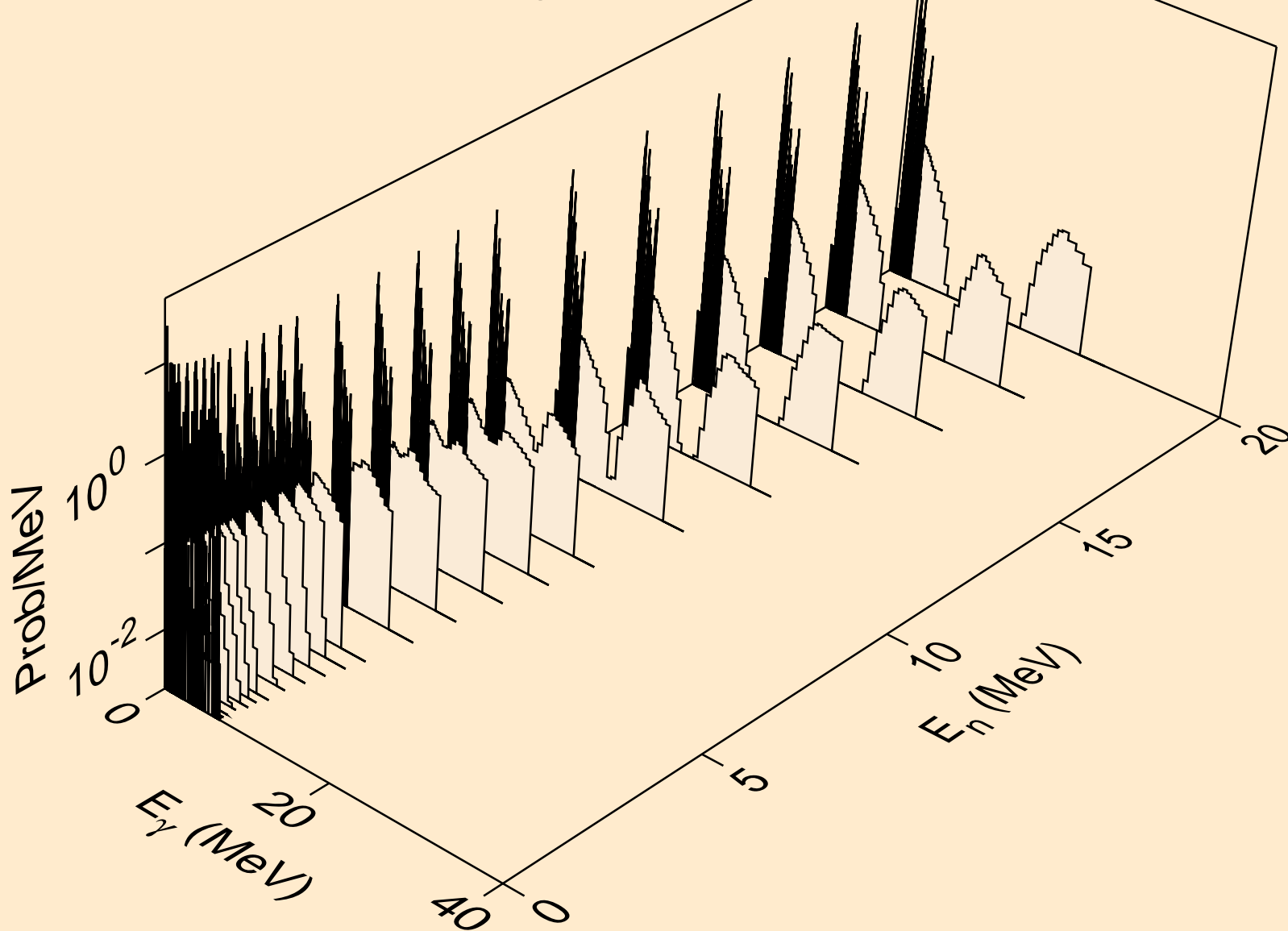

MAT=2637 ACE FILE PRODUCED AT NEA WITH NDEC  
Photon emission for (n,2a)

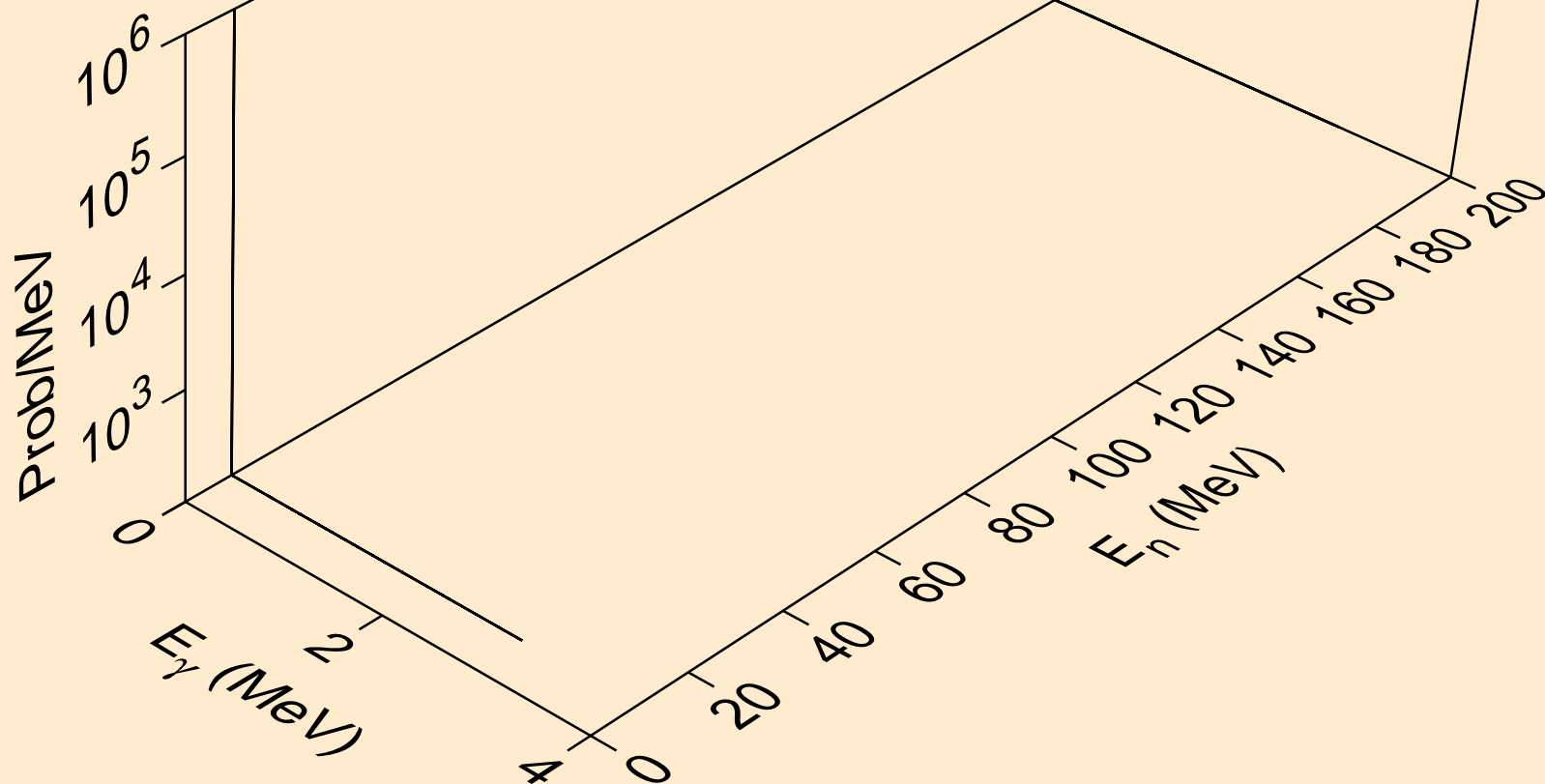

MAT=2637 ACE FILE PRODUCED AT NEA WITH NDEC  
Photon emission for (n,p\*2)

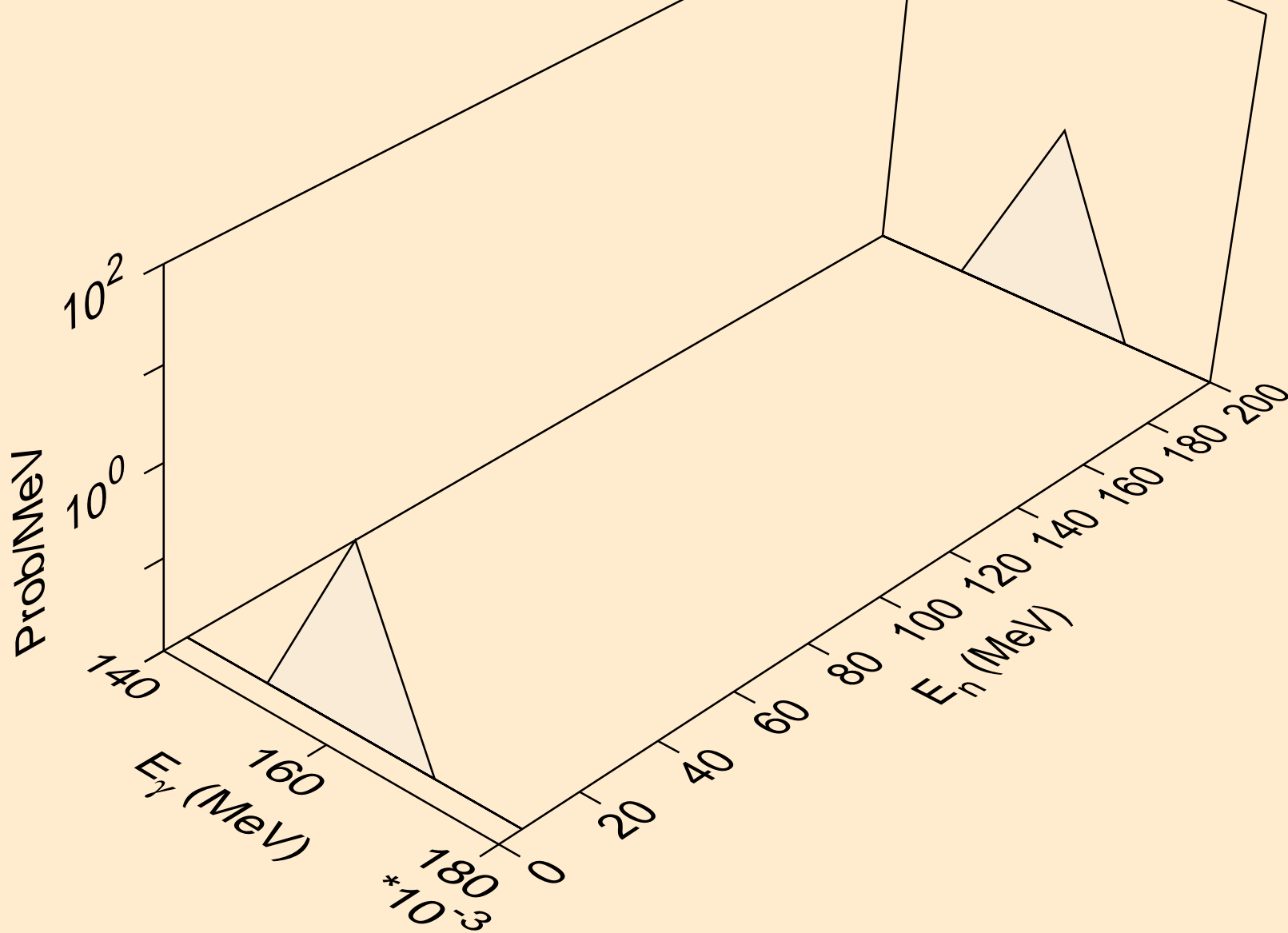

MAT=2637 ACE FILE PRODUCED AT NEA WITH NDEC  
Photon emission for (n,p\*3)

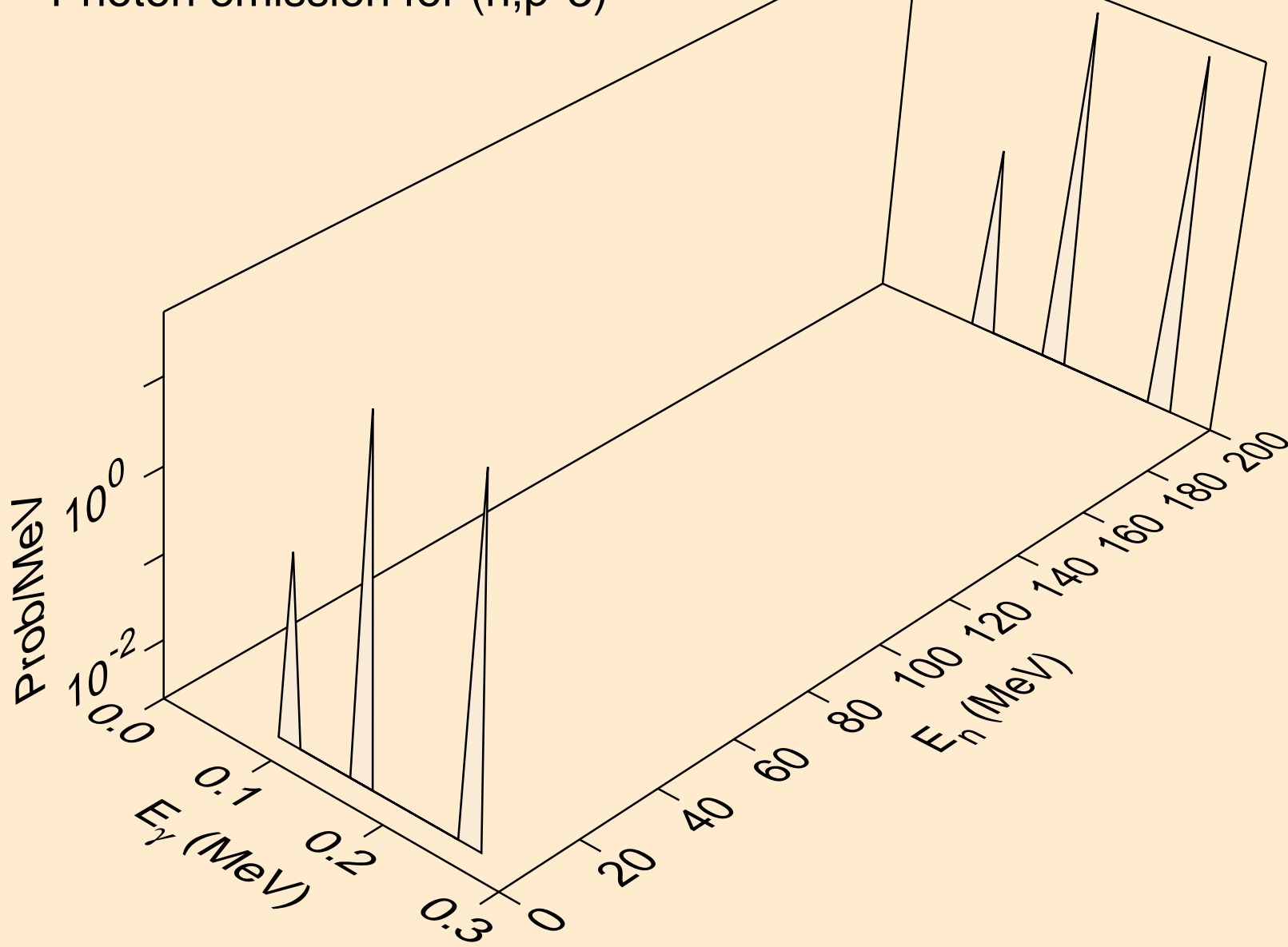



MAT=2637 ACE FILE PRODUCED AT NEA WITH NDEC  
Photon emission for (n,p\*4)

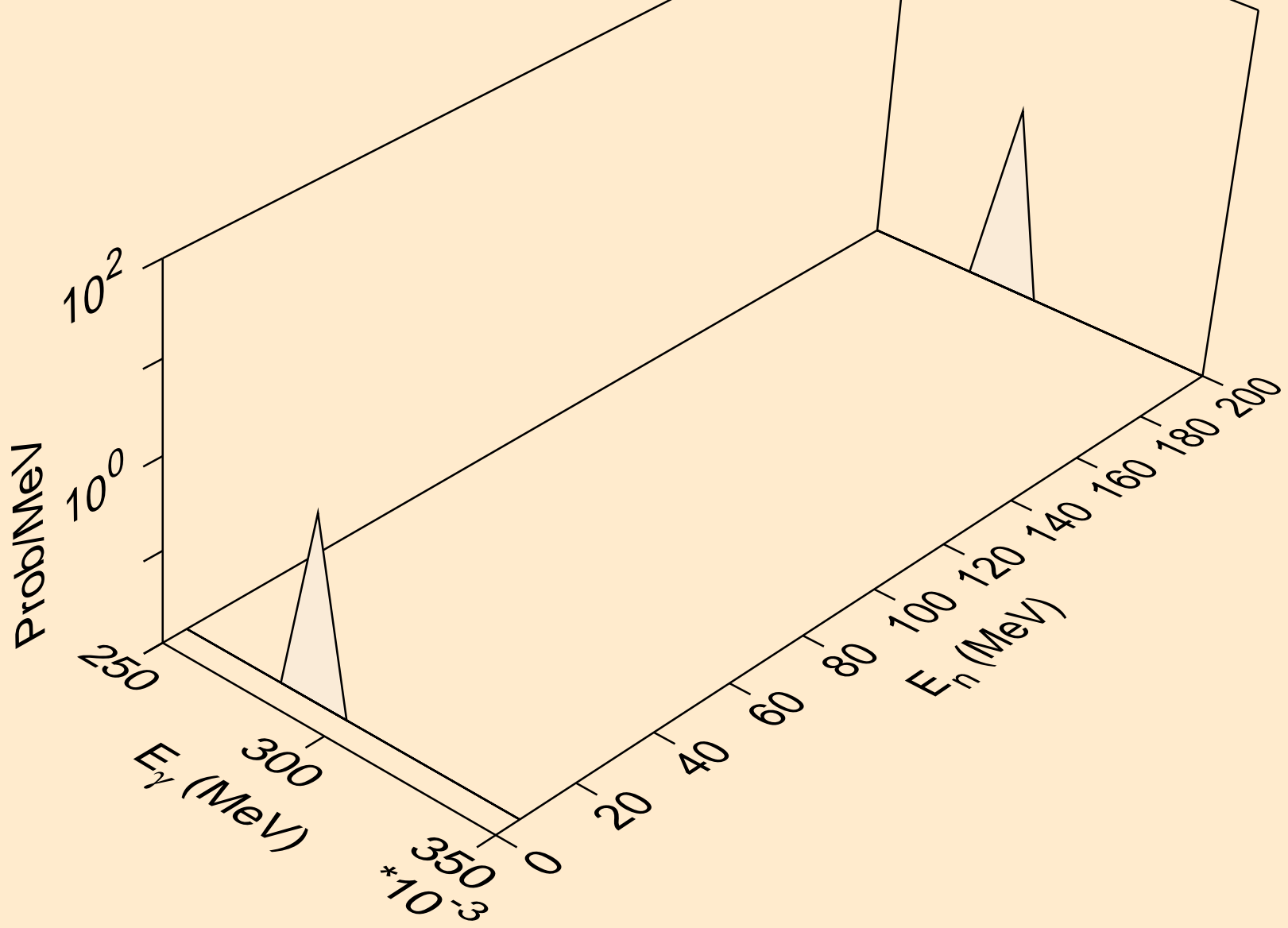

MAT=2637 ACE FILE PRODUCED AT NEA WITH NDEC  
Photon emission for (n,p\*5)

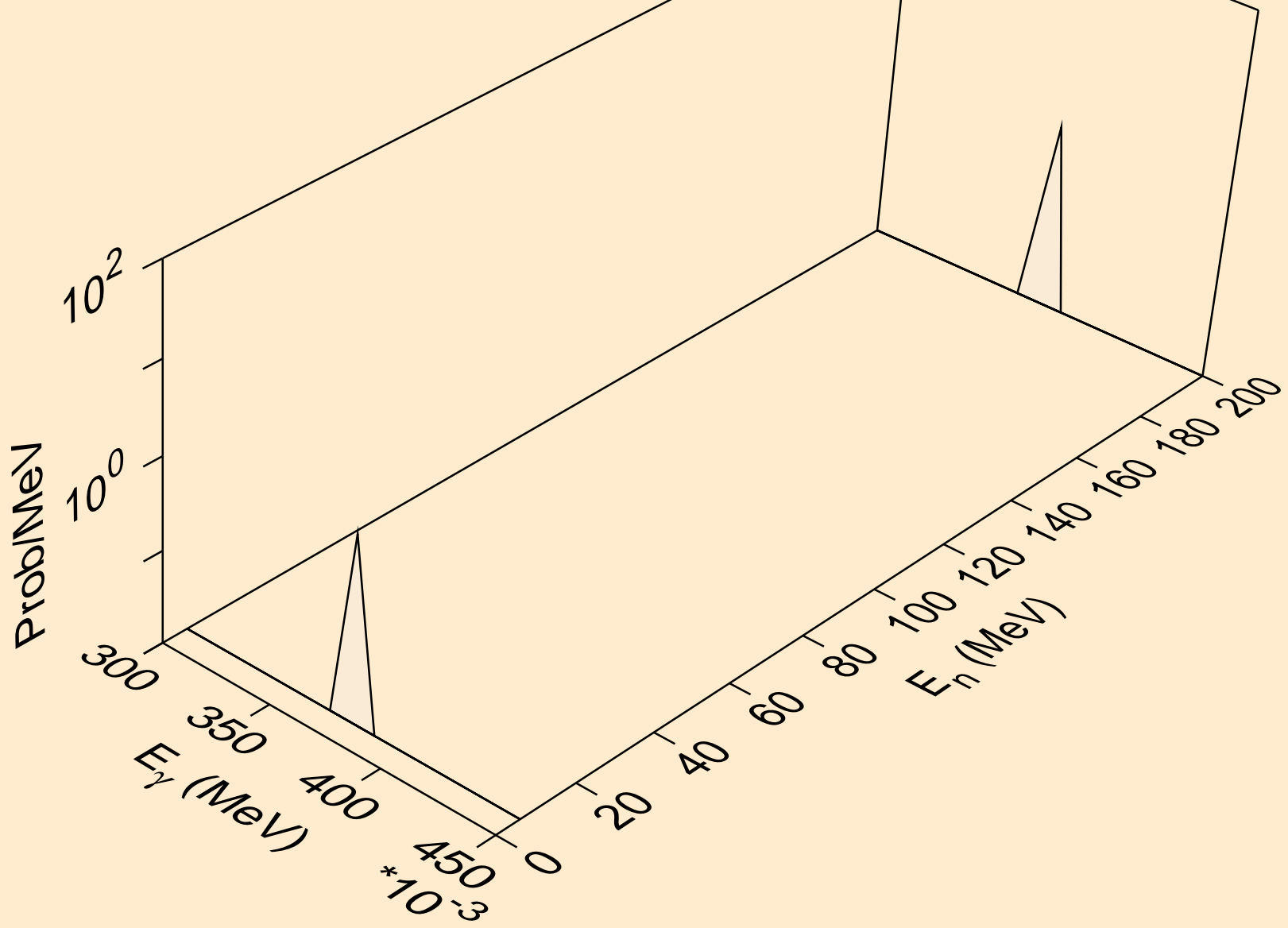

MAT=2637 ACE FILE PRODUCED AT NEA WITH NDEC  
Photon emission for (n,p\*6)

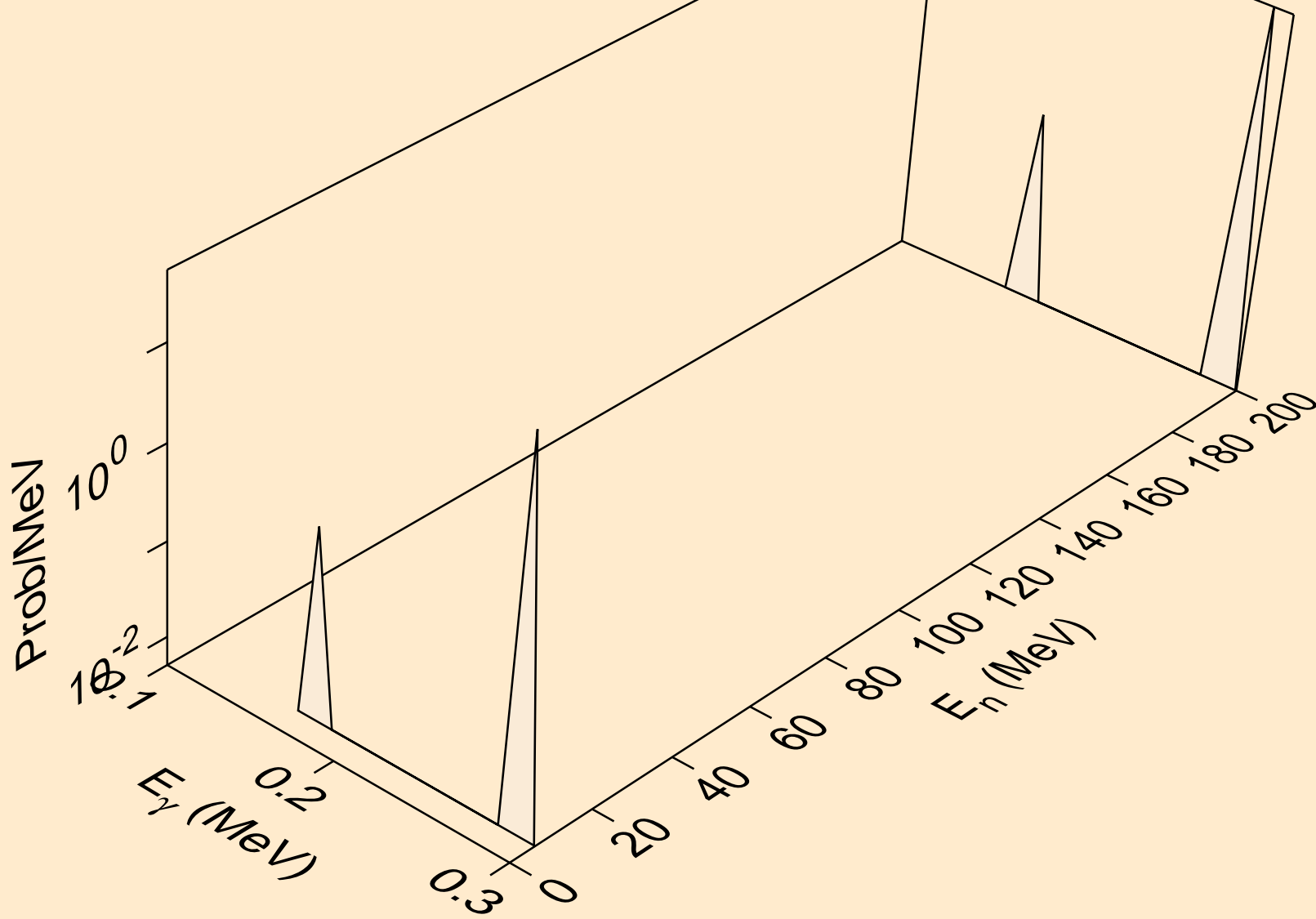

MAT=2637 ACE FILE PRODUCED AT NEA WITH NDEC  
Photon emission for (n,p\*7)

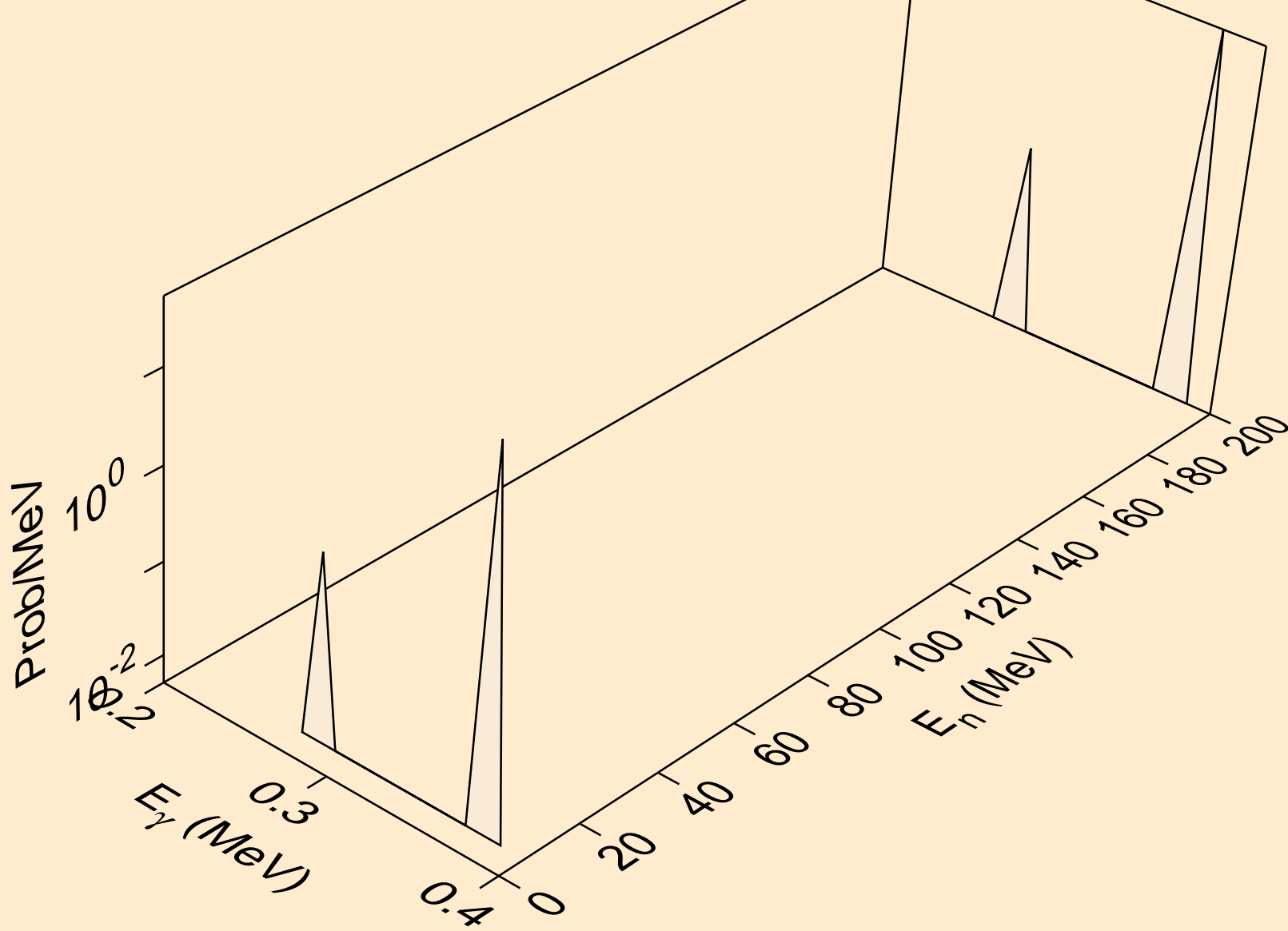

MAT=2637 ACE FILE PRODUCED AT NEA WITH NDEC  
Photon emission for (n,p\*8)

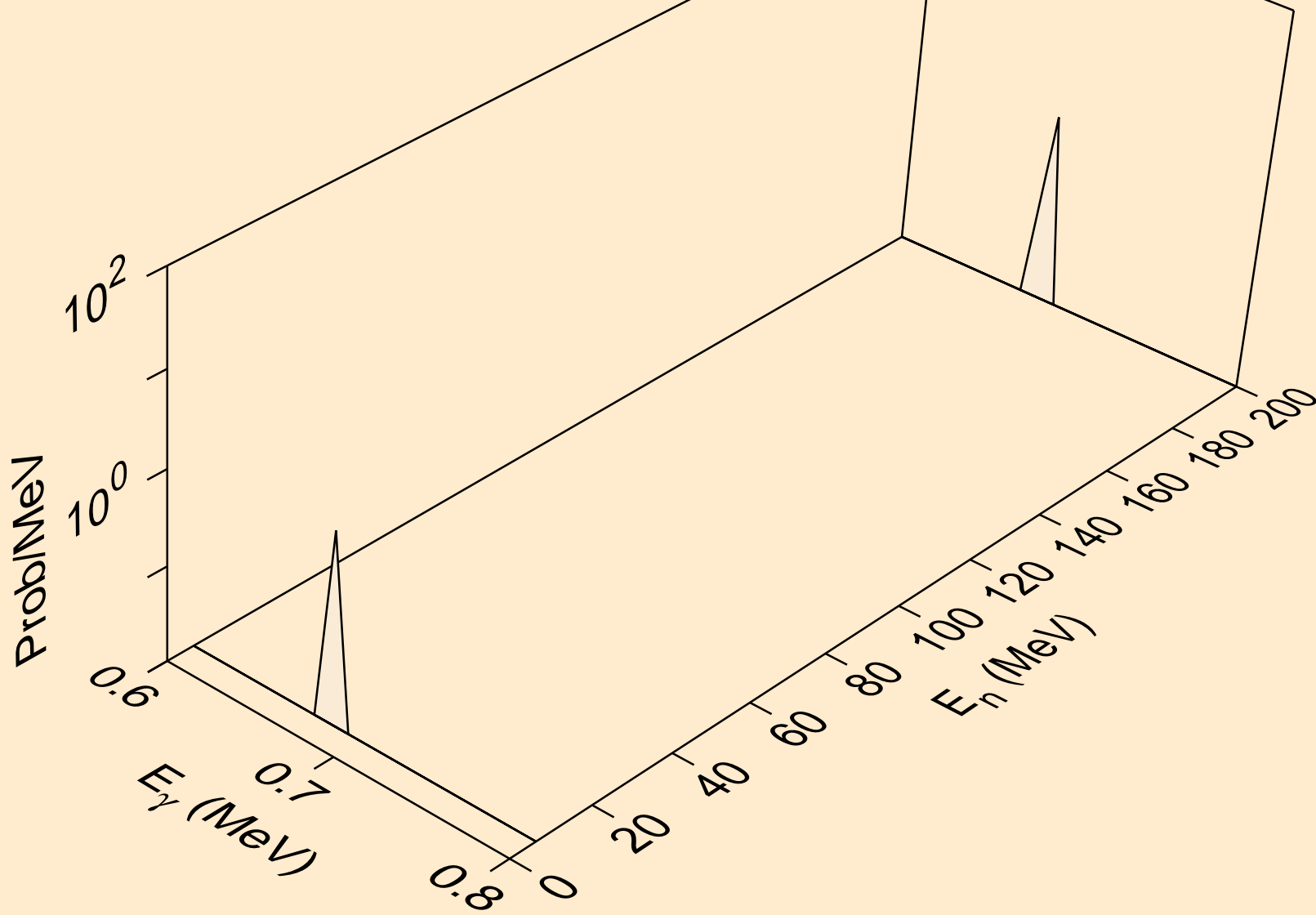

MAT=2637 ACE FILE PRODUCED AT NEA WITH NDEC  
Photon emission for (n,p\*9)

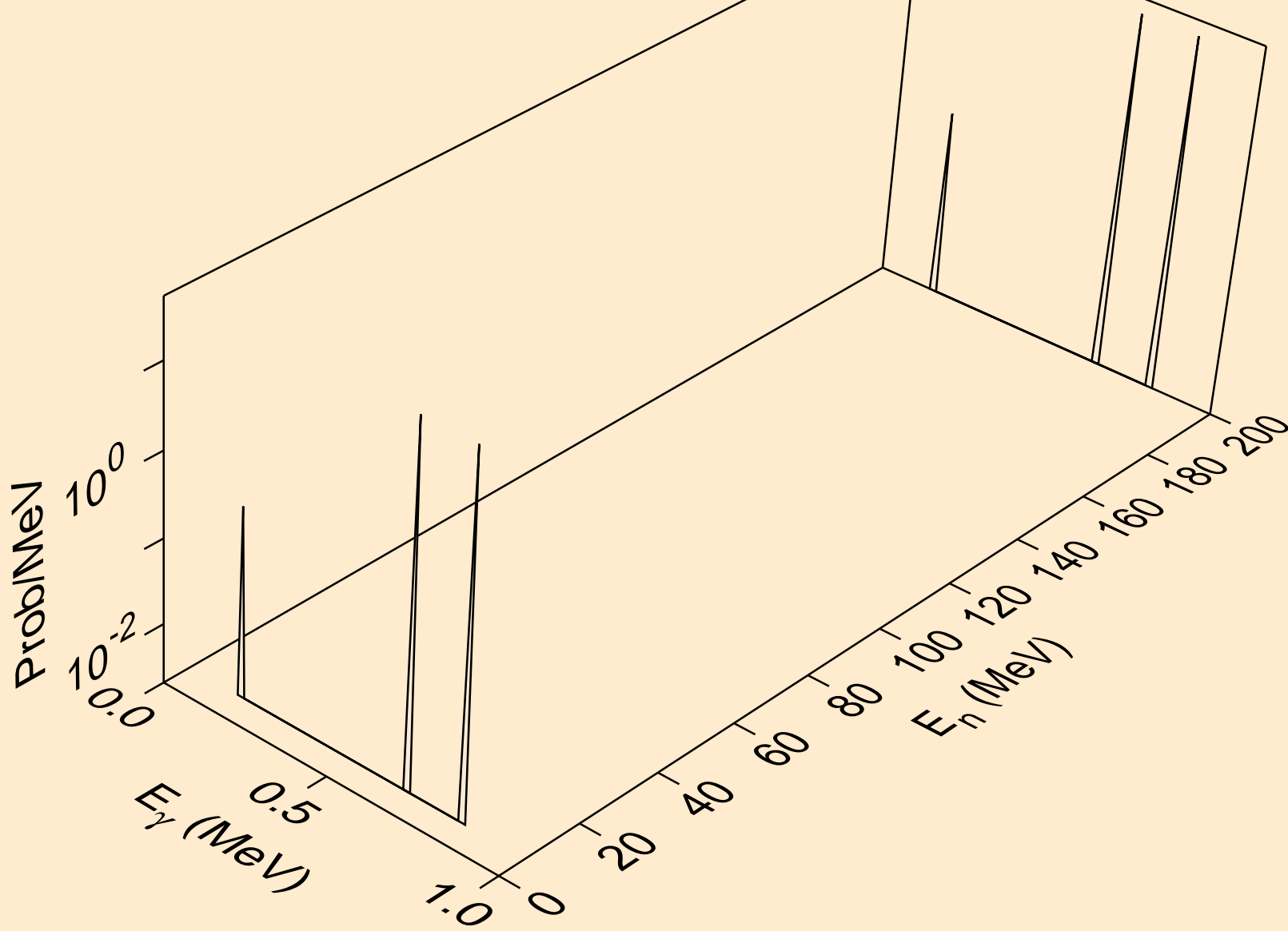

MAT=2637 ACE FILE PRODUCED AT NEA WITH NDEC  
Photon emission for (n,p\*10)

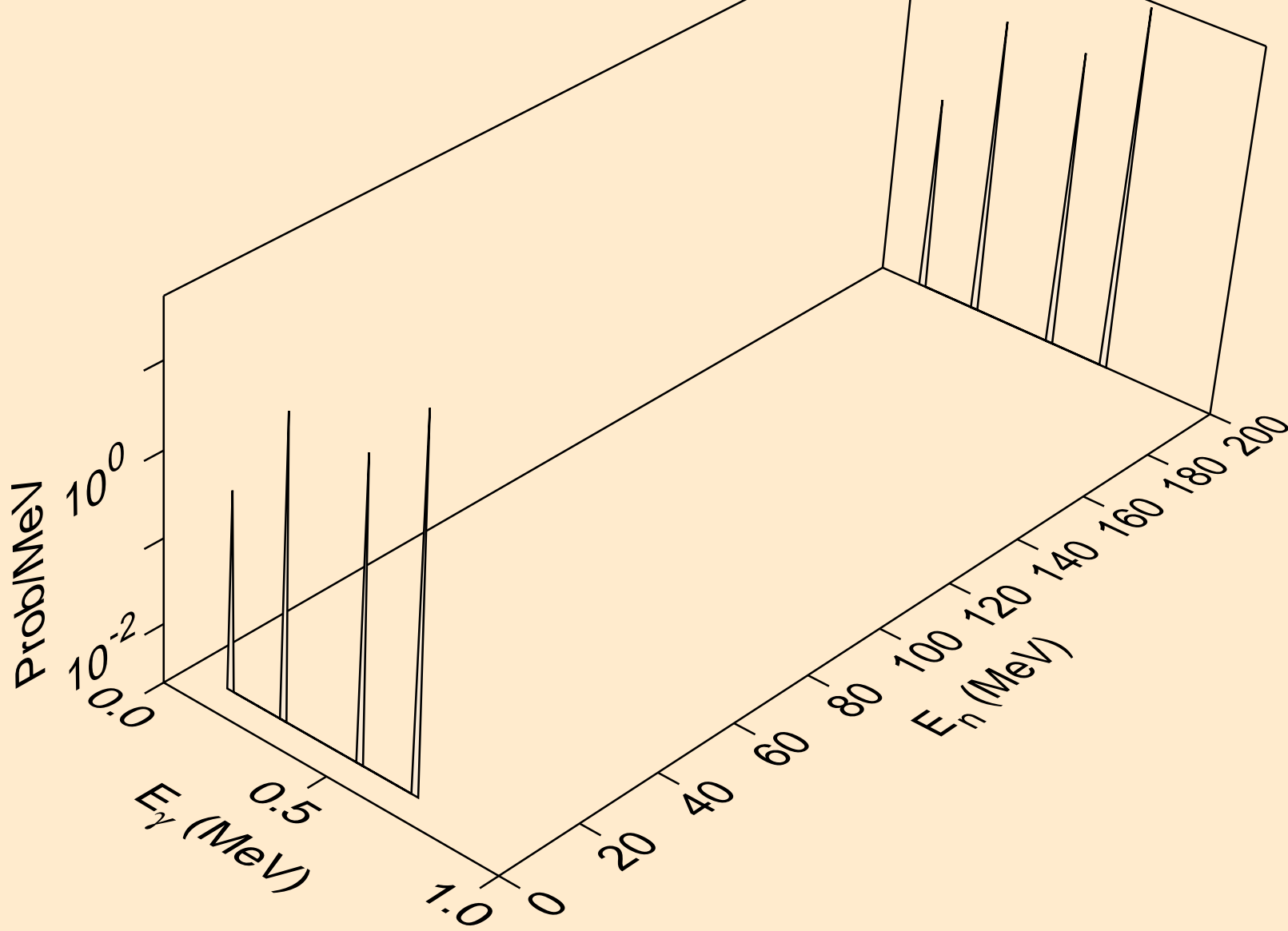

MAT=2637 ACE FILE PRODUCED AT NEA WITH NDEC  
Photon emission for (n,p\*c)

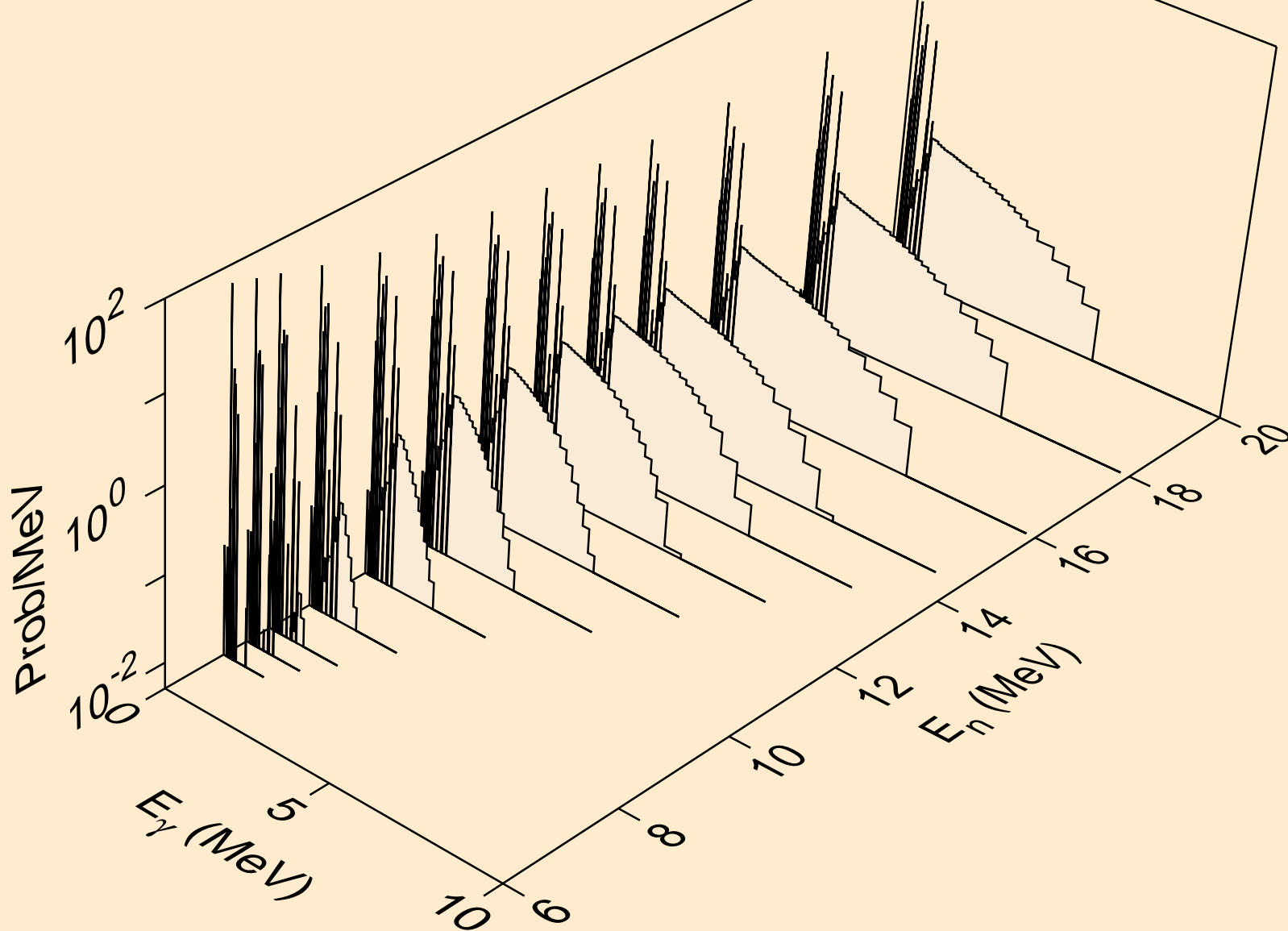



MAT=2637 ACE FILE PRODUCED AT NEA WITH NDEC  
Photon emission for (n,d\*1)

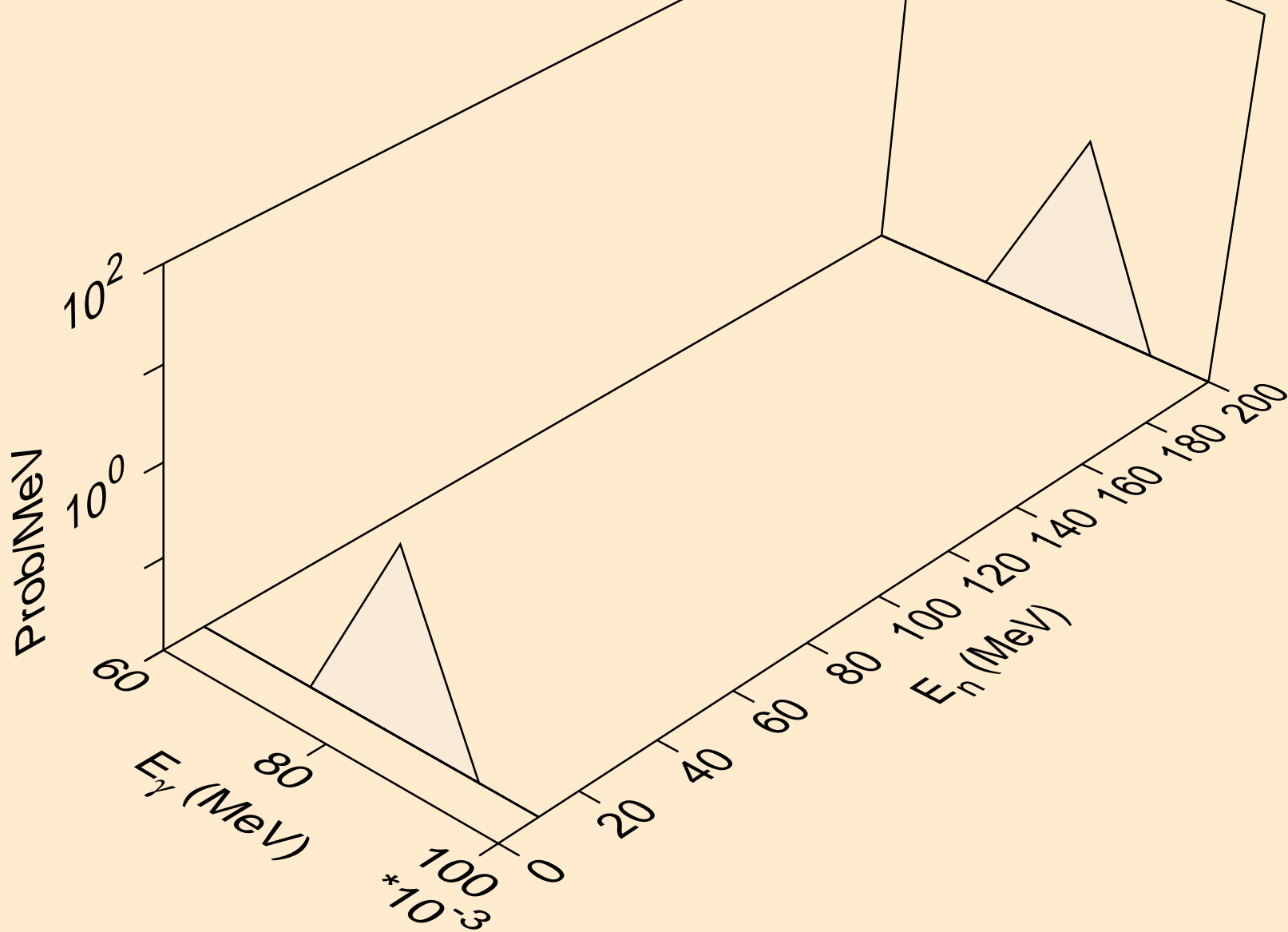

MAT=2637 ACE FILE PRODUCED AT NEA WITH NDEC  
Photon emission for (n,d\*2)

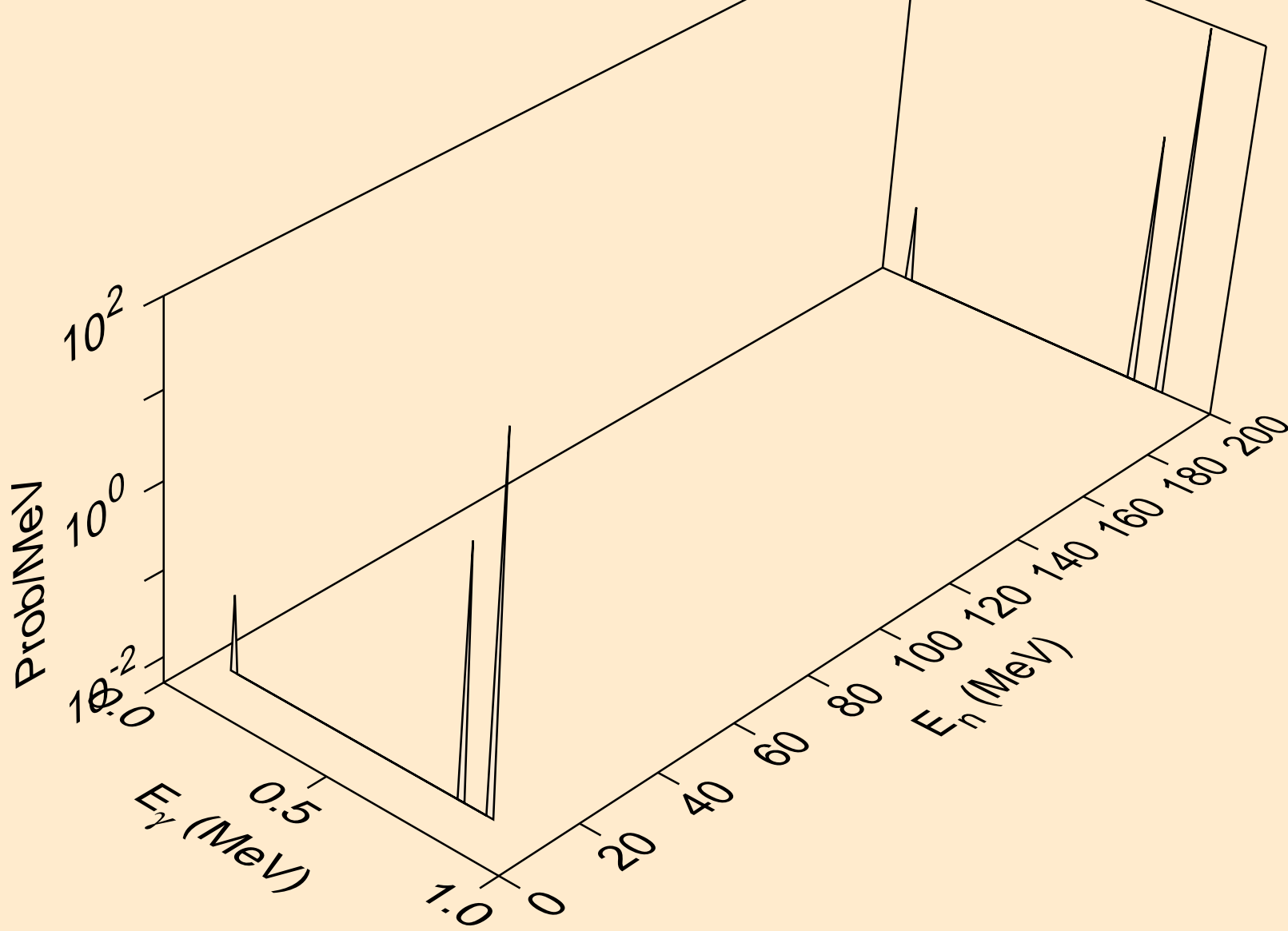

MAT=2637 ACE FILE PRODUCED AT NEA WITH NDEC  
Photon emission for (n,d\*3)

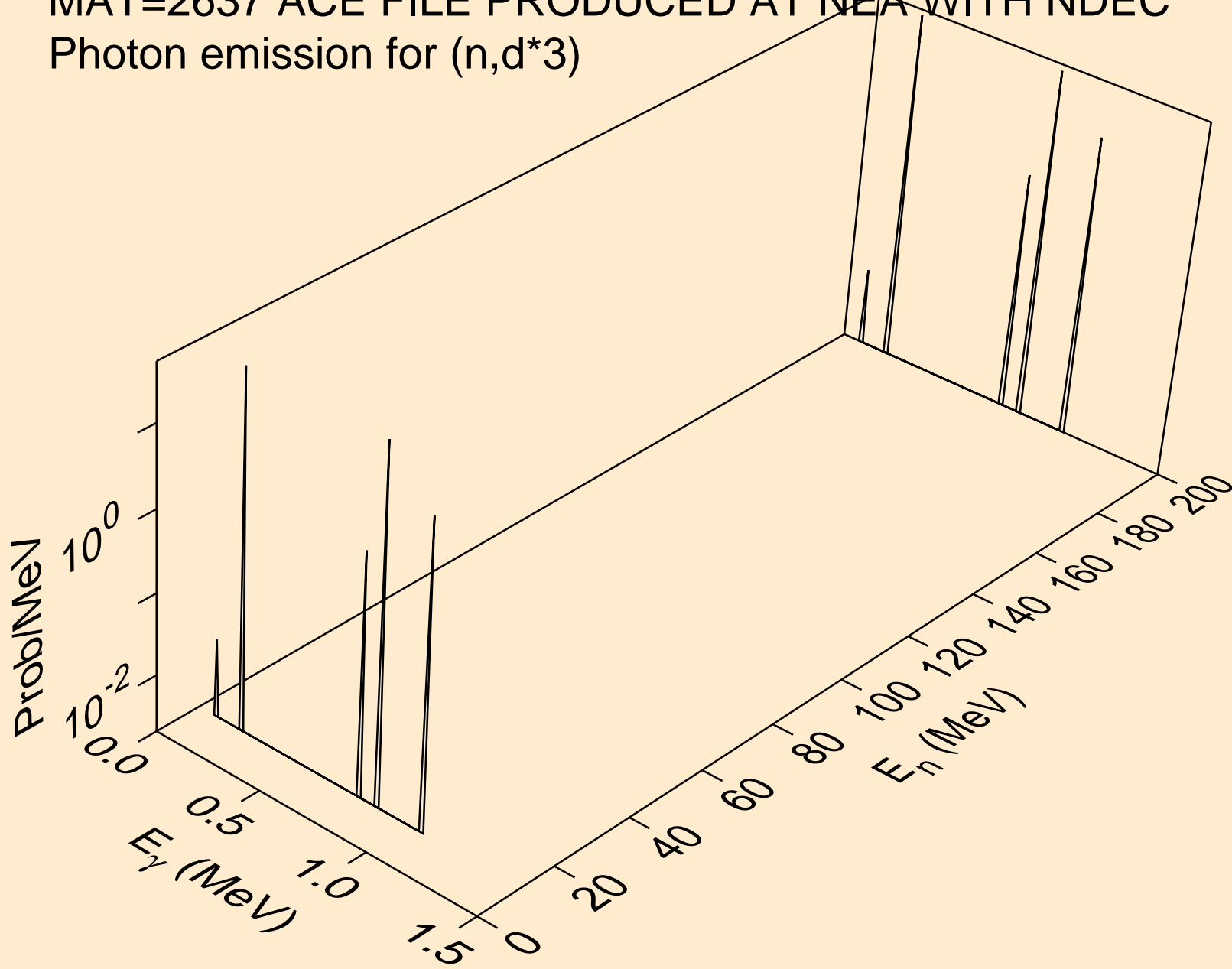

MAT=2637 ACE FILE PRODUCED AT NEA WITH NDEC  
Photon emission for (n,d\*4)

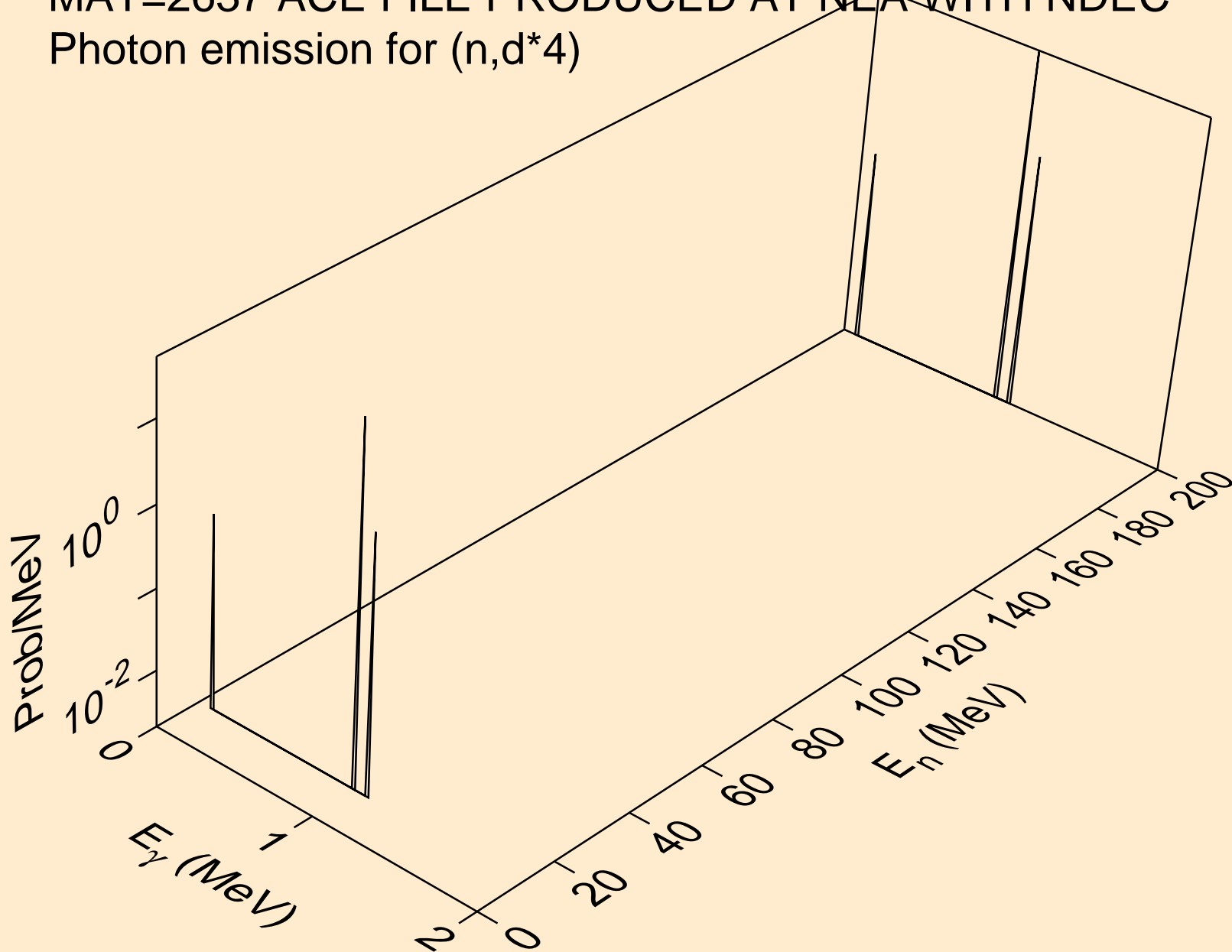

MAT=2637 ACE FILE PRODUCED AT NEA WITH NDEC  
Photon emission for (n,d\*5)

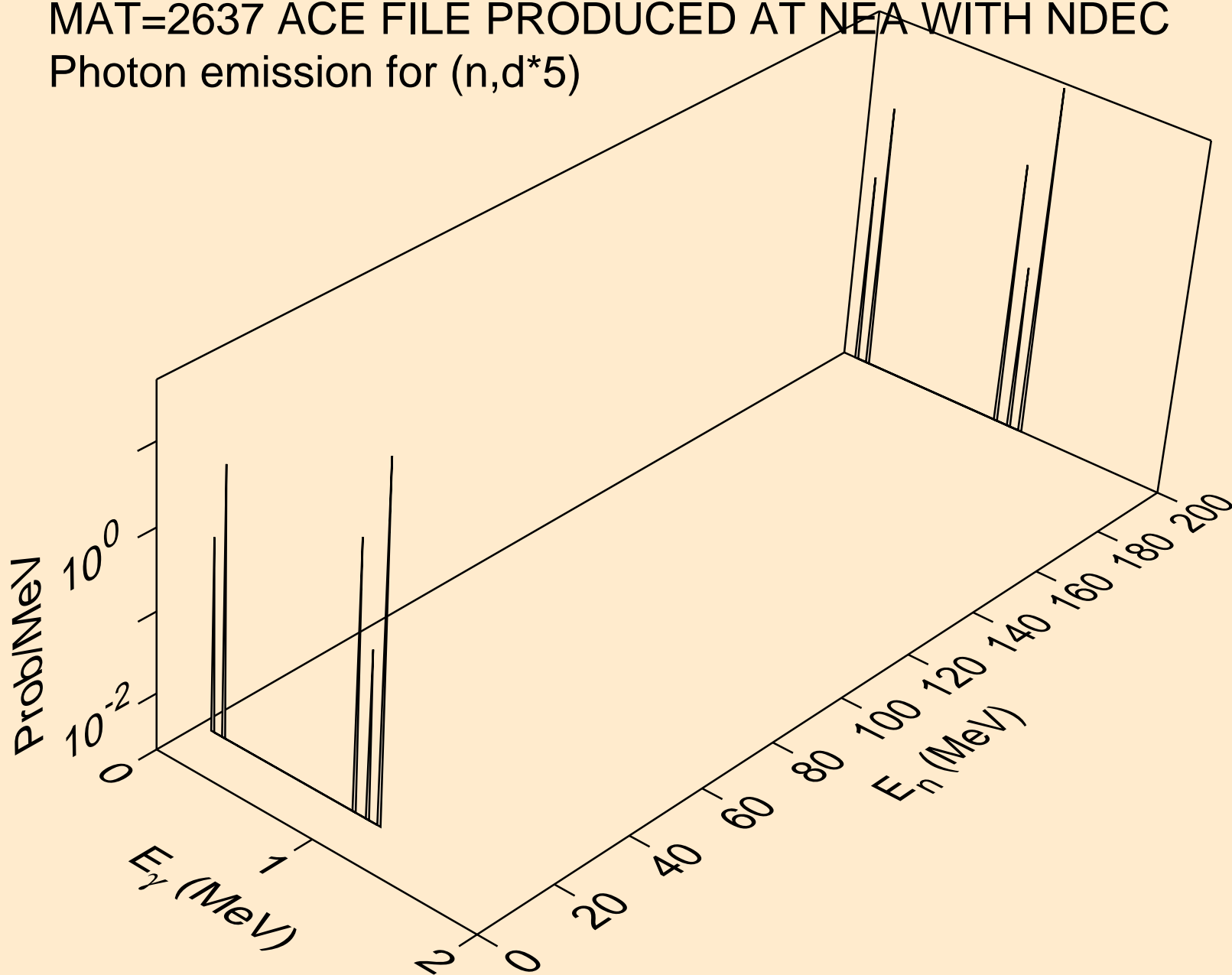

MAT=2637 ACE FILE PRODUCED AT NEA WITH NDEC  
Photon emission for (n,d\*c)

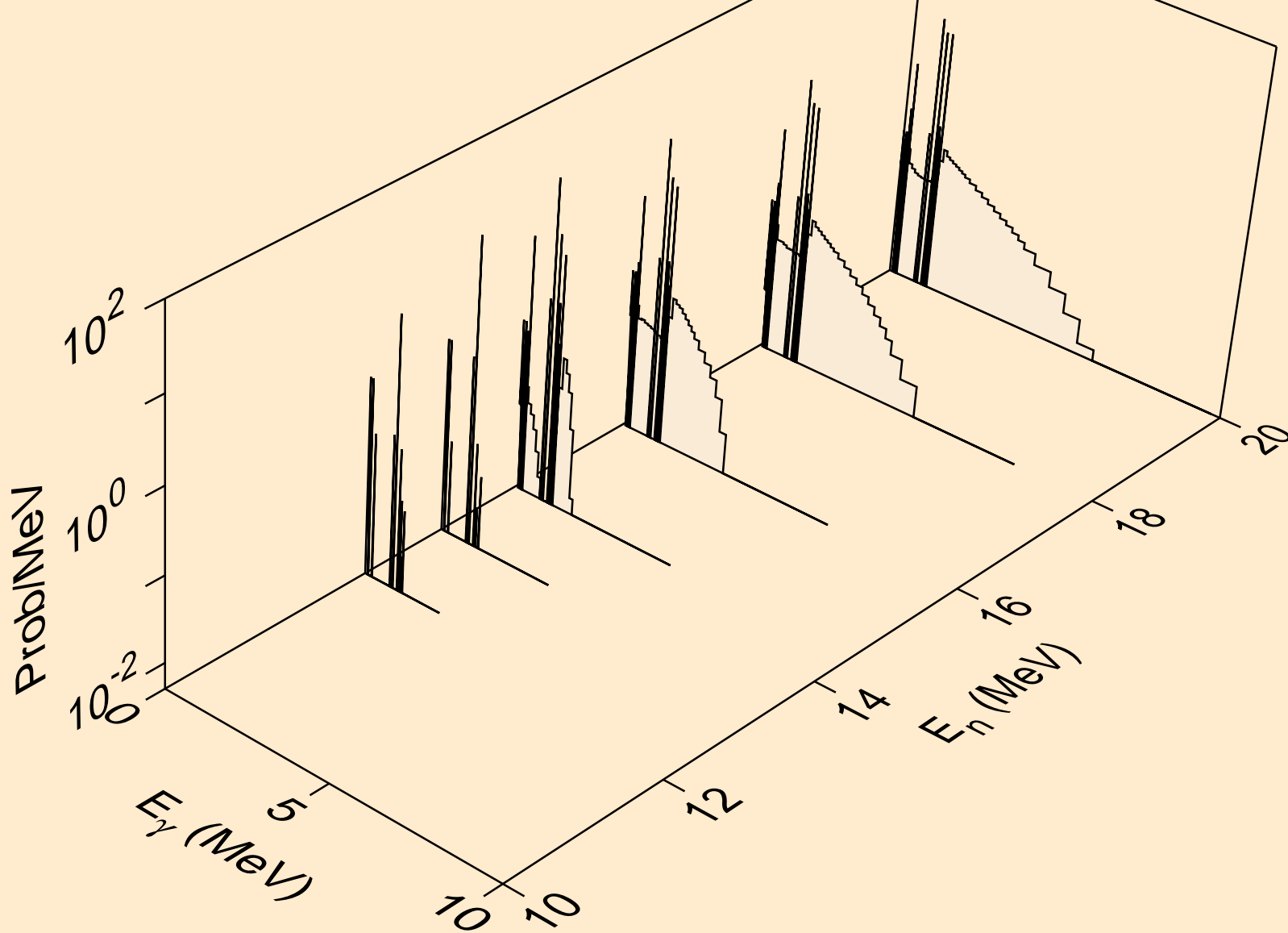

MAT=2637 ACE FILE PRODUCED AT NEA WITH NDEC  
Photon emission for (n,t\*1)

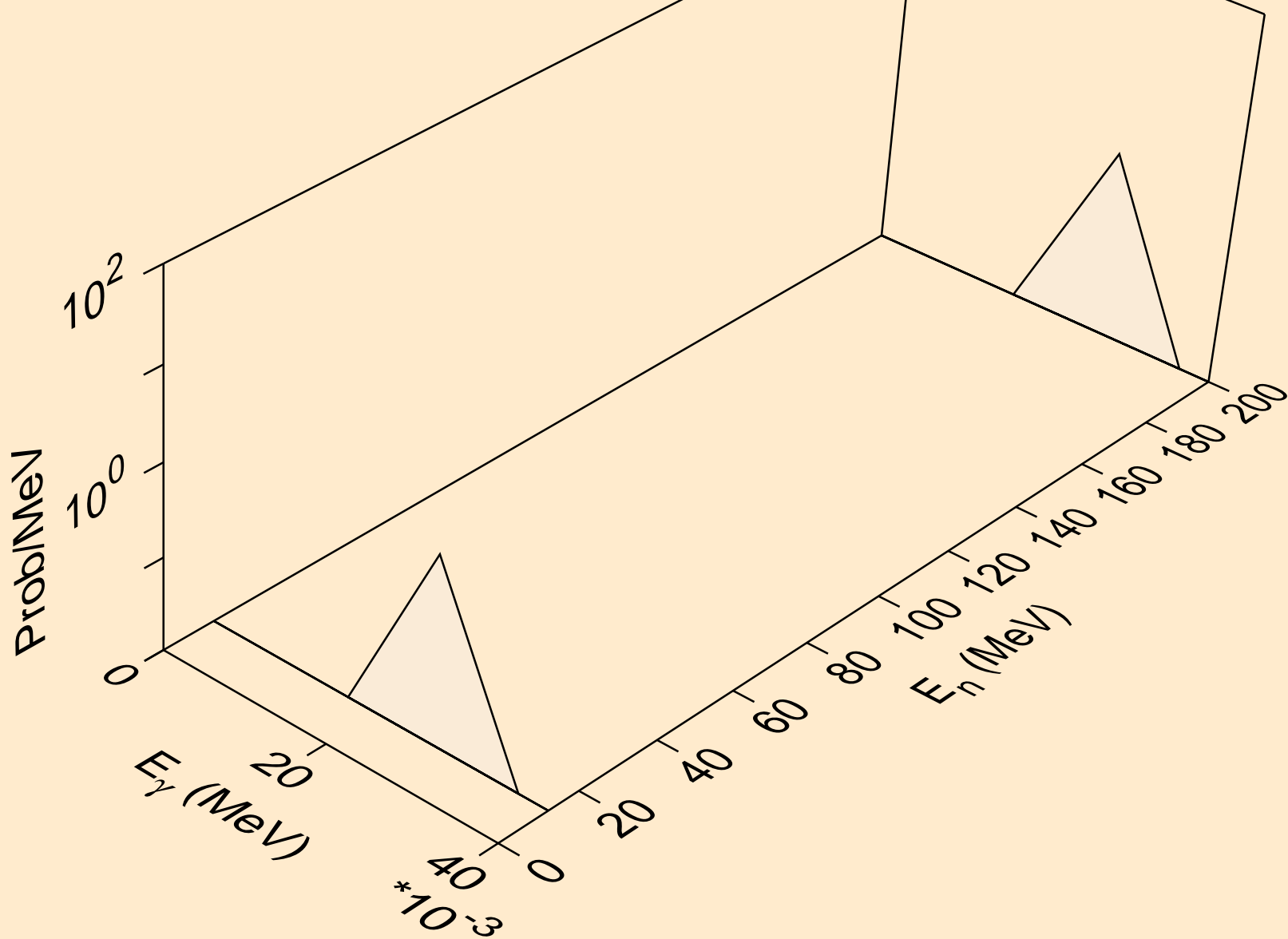

MAT=2637 ACE FILE PRODUCED AT NEA WITH NDEC  
Photon emission for (n,t\*2)

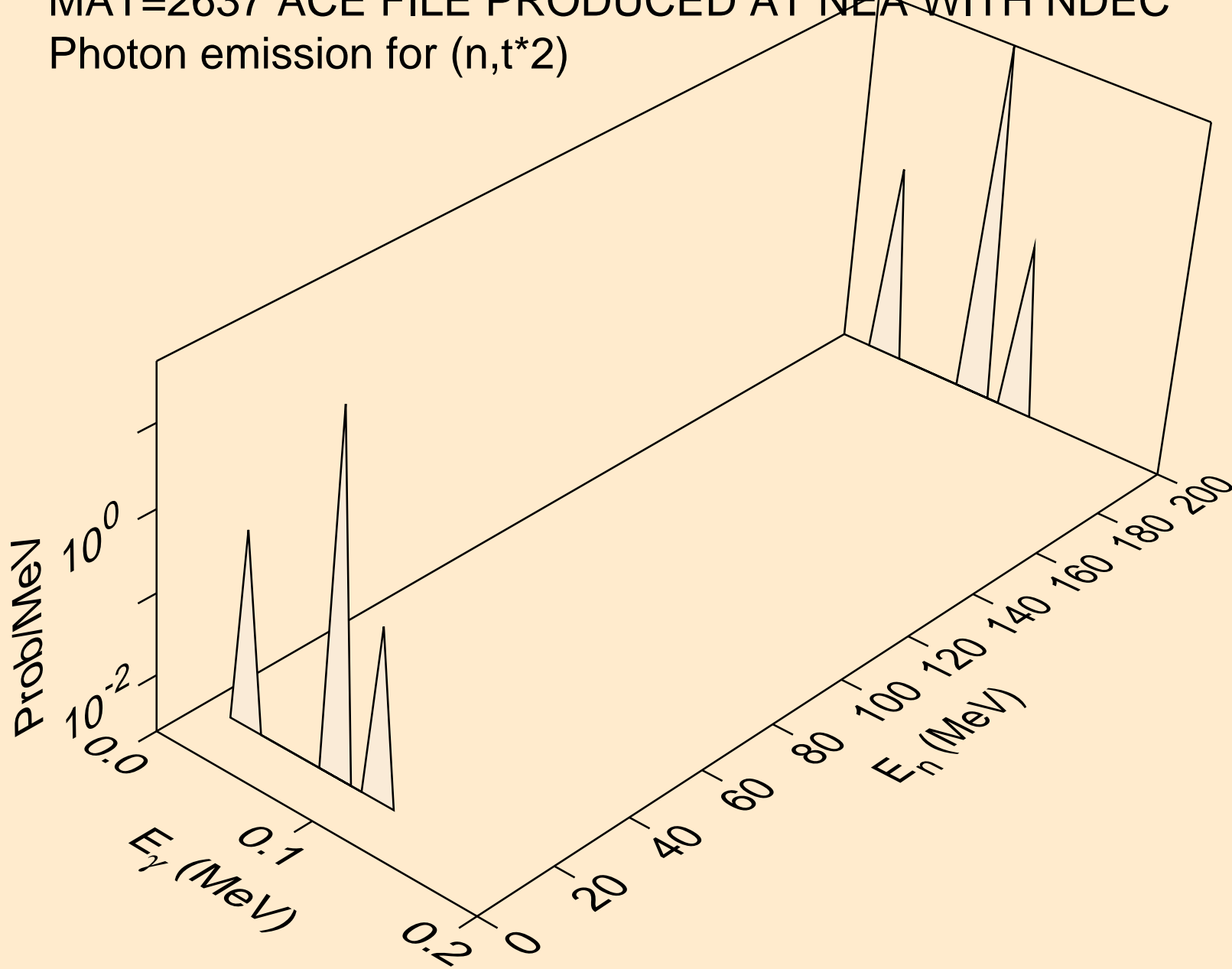



MAT=2637 ACE FILE PRODUCED AT NEA WITH NDEC  
Photon emission for (n,t\*3)

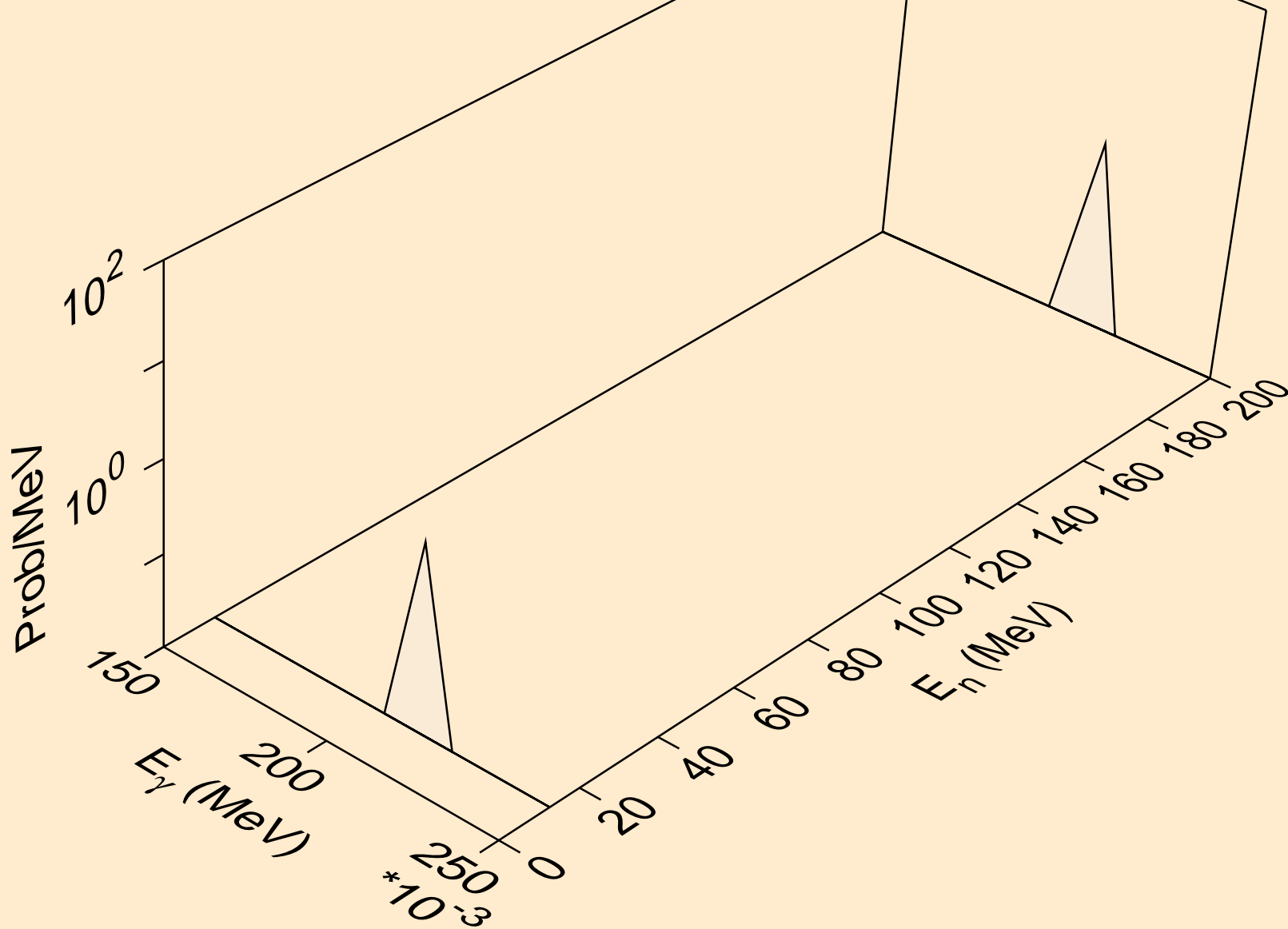

MAT=2637 ACE FILE PRODUCED AT NEA WITH NDEC  
Photon emission for (n,t\*4)

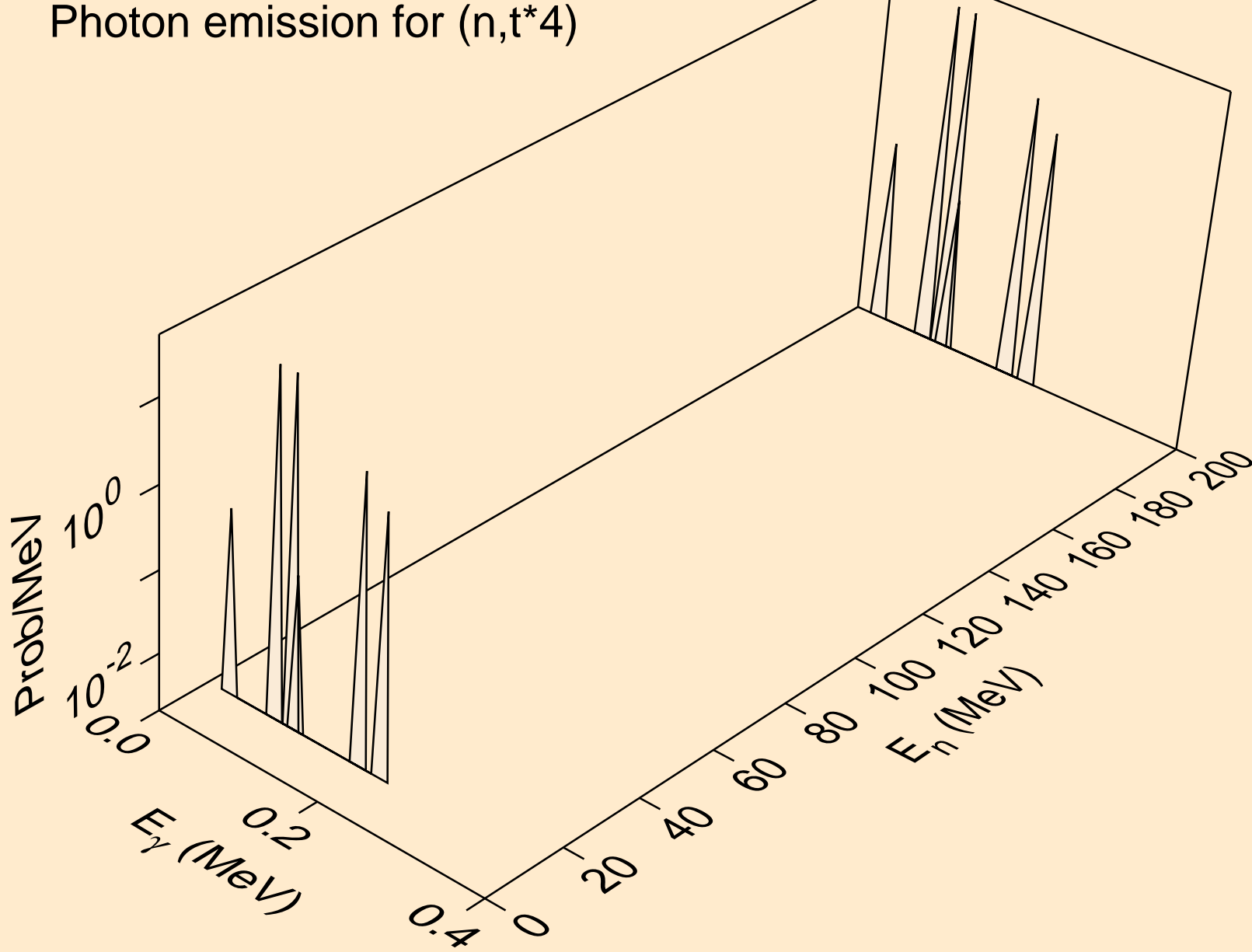

MAT=2637 ACE FILE PRODUCED AT NEA WITH NDEC  
Photon emission for (n,t\*5)

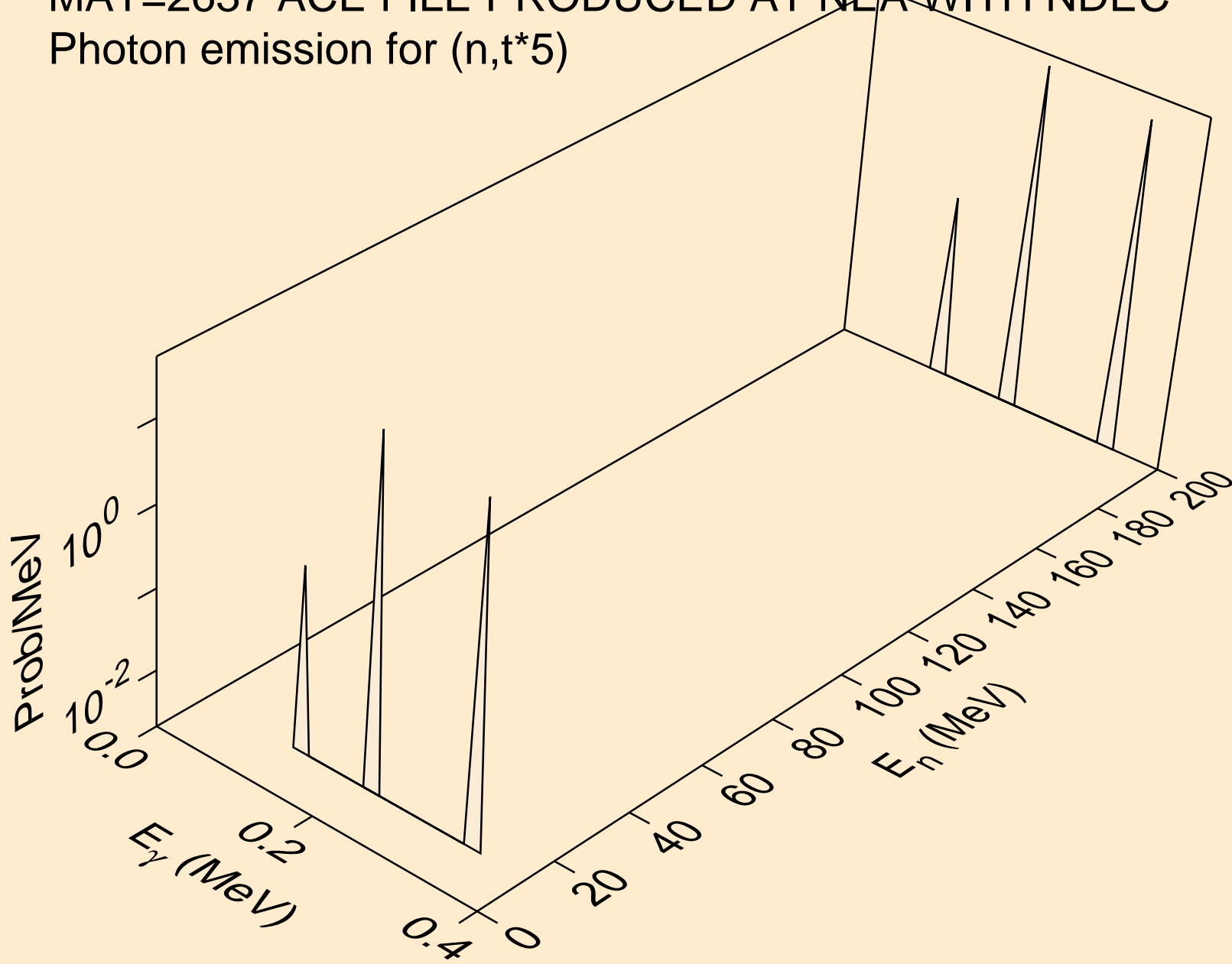

MAT=2637 ACE FILE PRODUCED AT NEA WITH NDEC  
Photon emission for (n,t\*c)

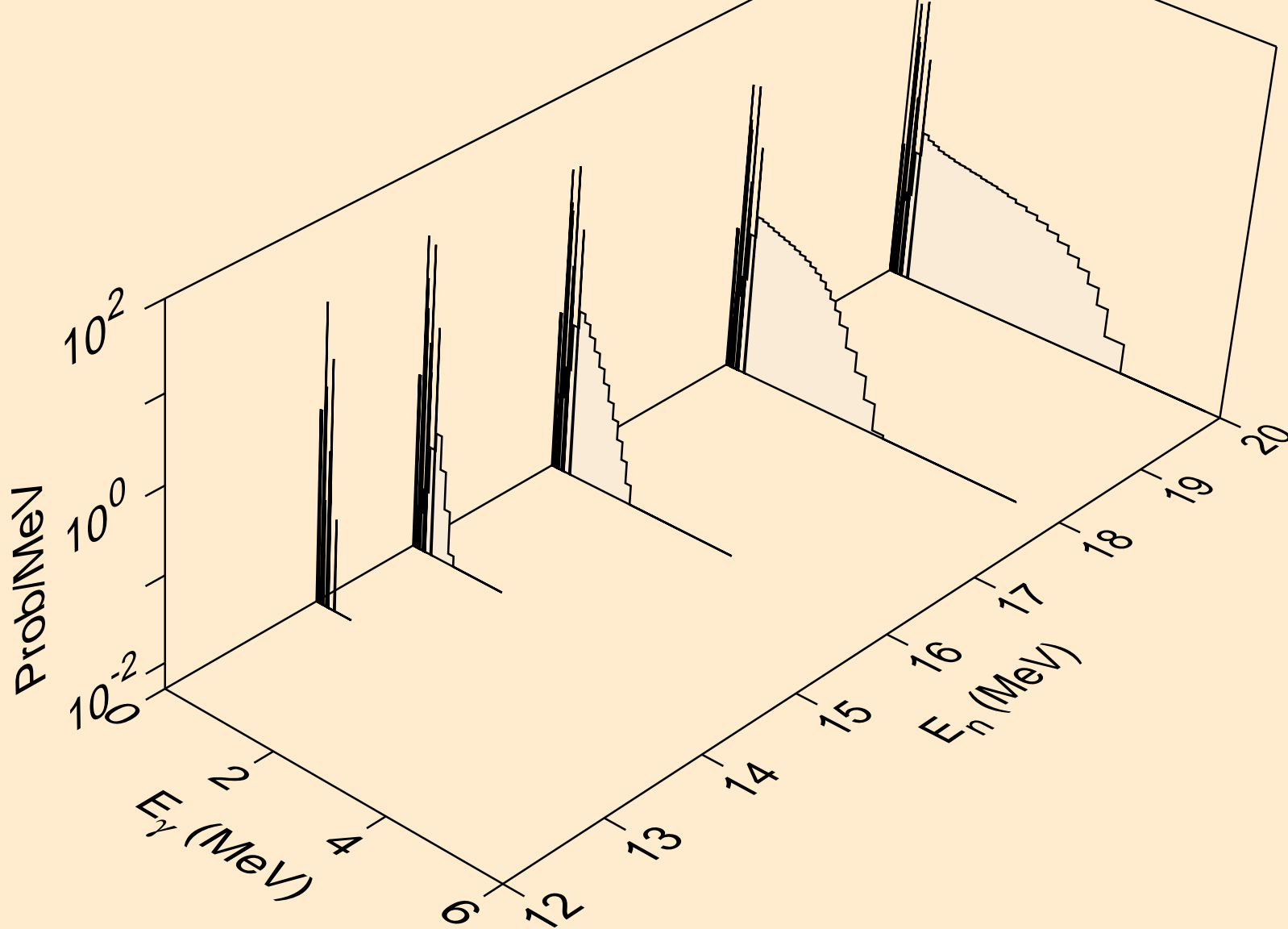

MAT=2637 ACE FILE PRODUCED AT NEA WITH NDEC  
Photon emission for (n,he3\*1)

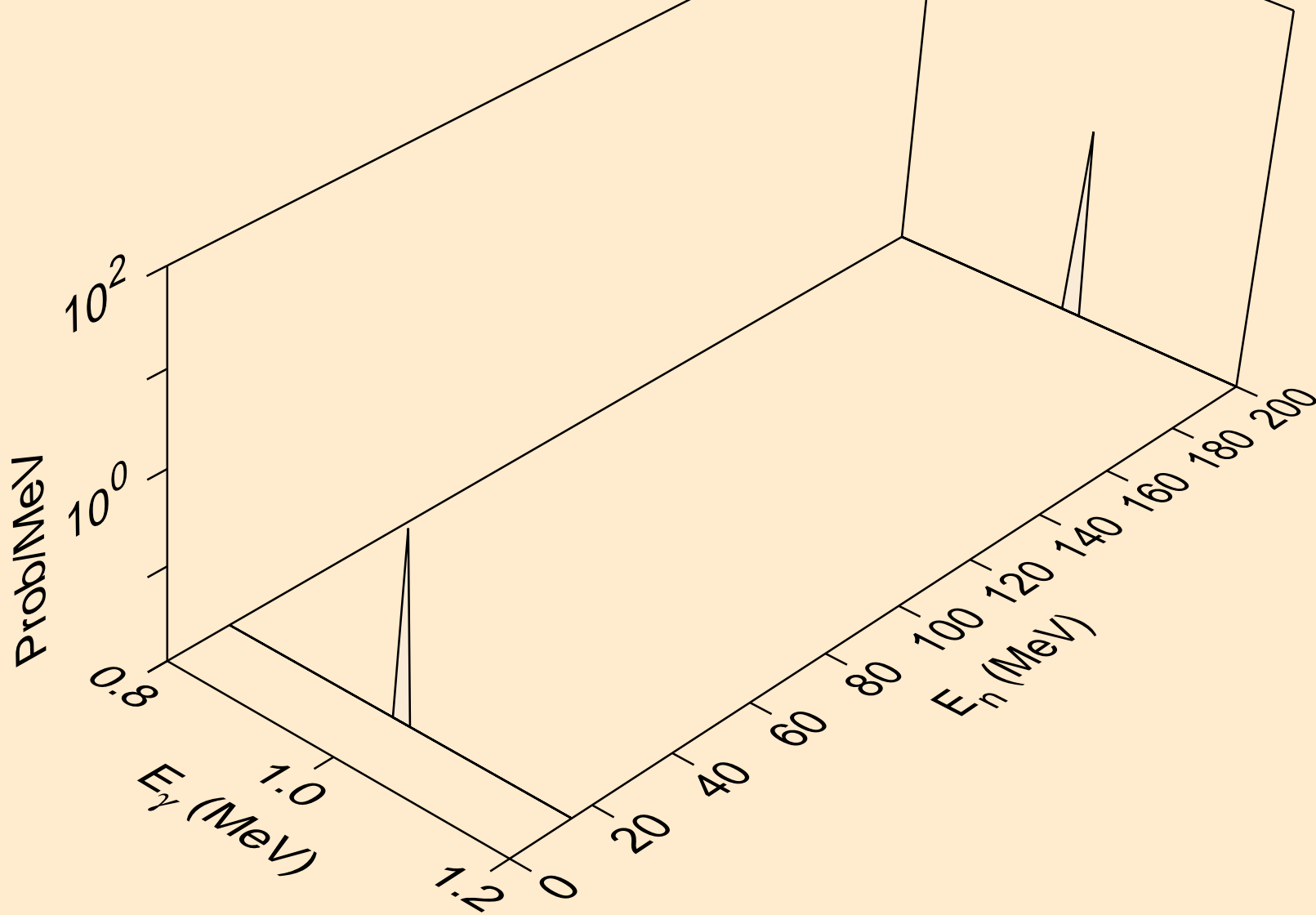

MAT=2637 ACE FILE PRODUCED AT NEA WITH NDEC  
Photon emission for (n,he3\*2)

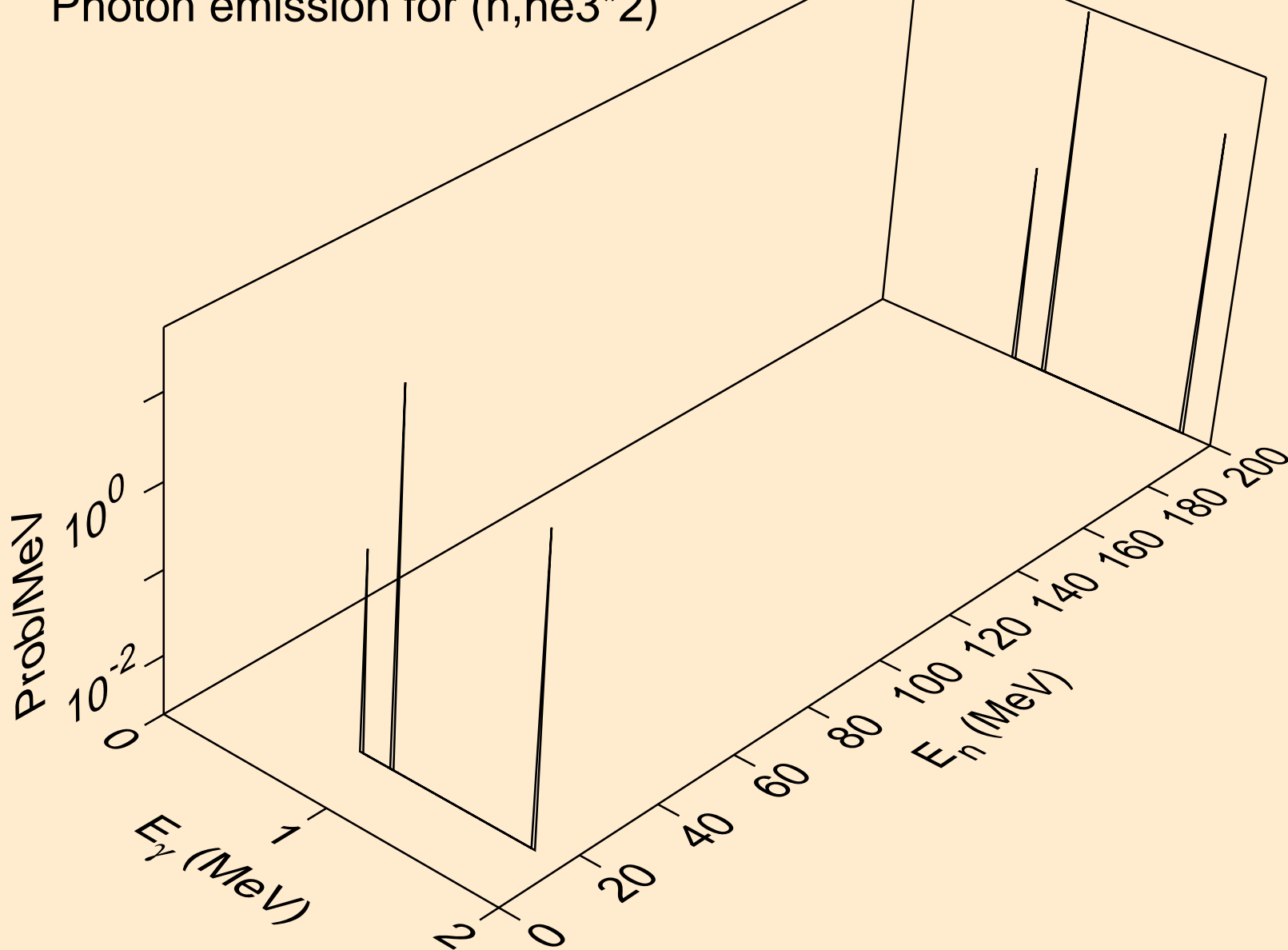

MAT=2637 ACE FILE PRODUCED AT NEA WITH NDEC  
Photon emission for (n,a\*1)

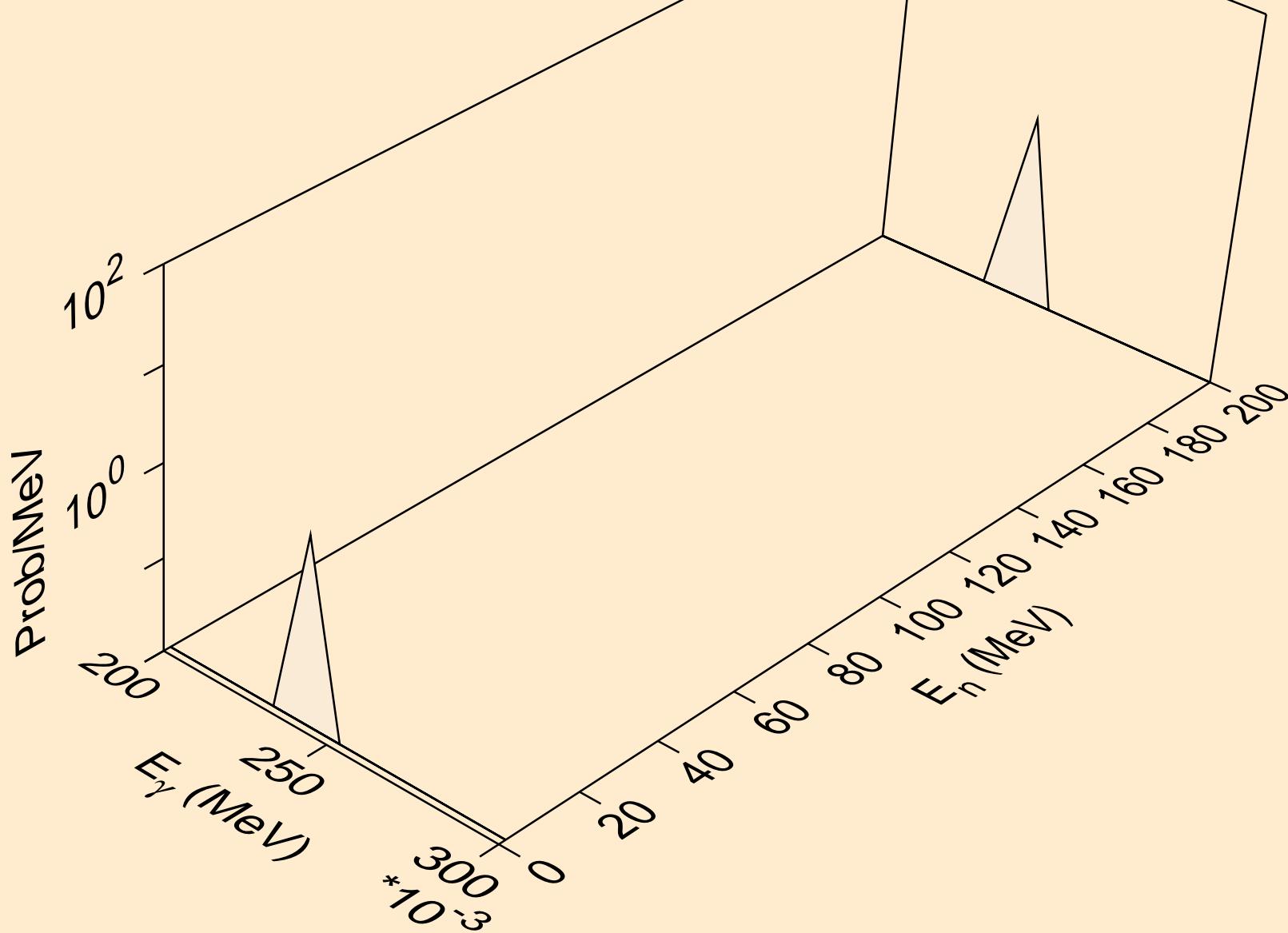

MAT=2637 ACE FILE PRODUCED AT NEA WITH NDEC  
Photon emission for (n,a\*2)

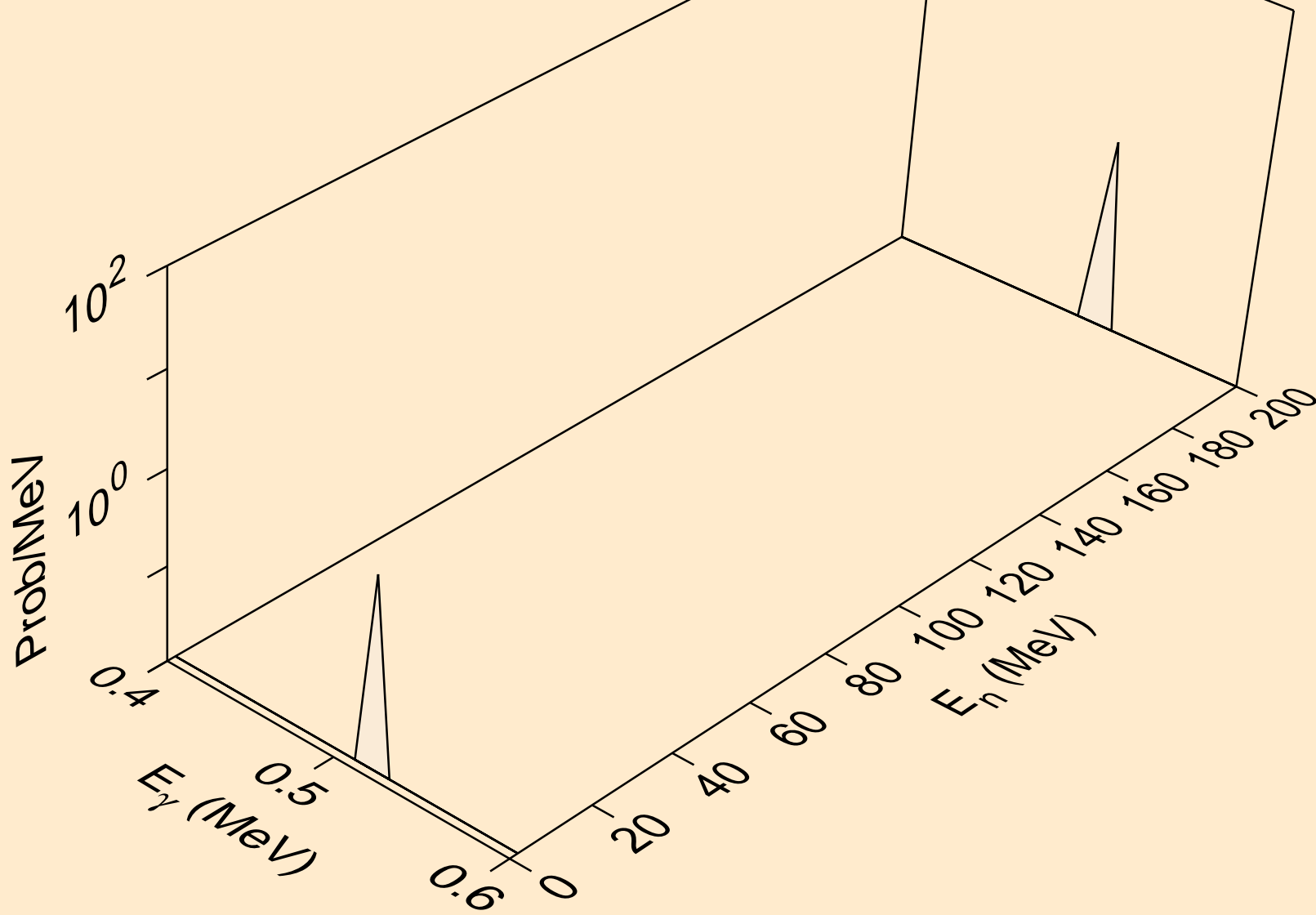



MAT=2637 ACE FILE PRODUCED AT NEA WITH NDEC  
Photon emission for (n,a\*3)

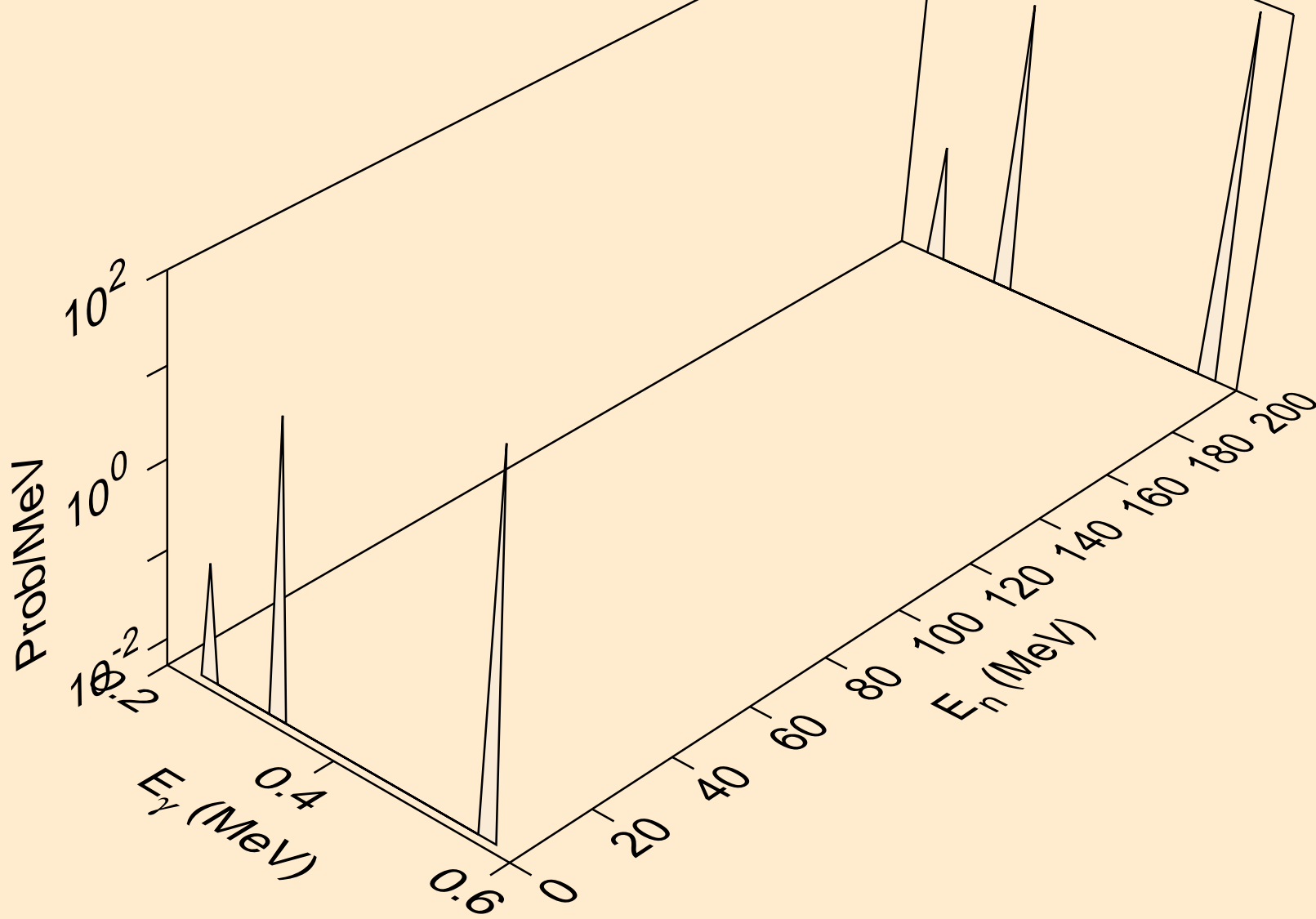

MAT=2637 ACE FILE PRODUCED AT NEA WITH NDEC  
Photon emission for (n,a\*4)

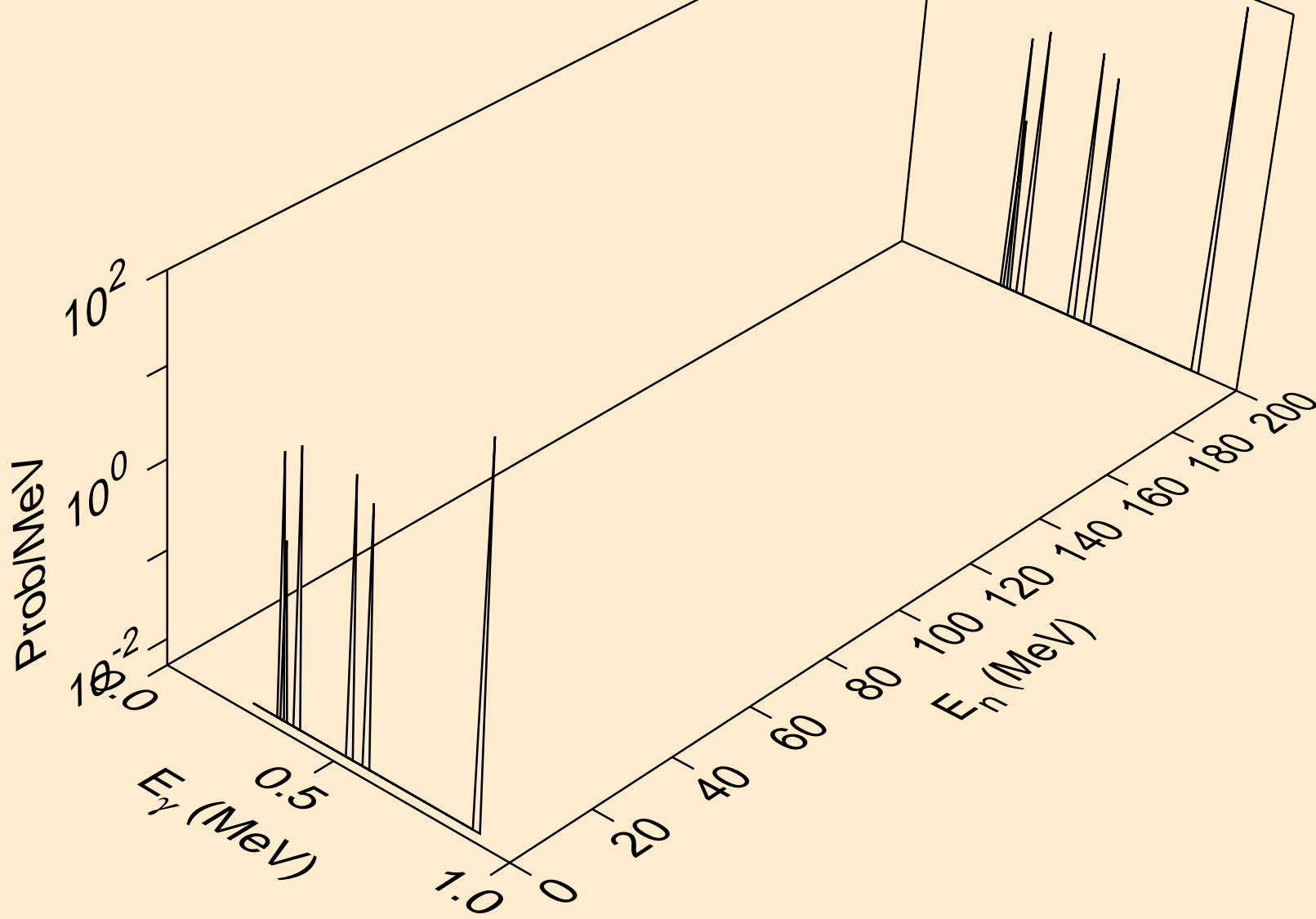

MAT=2637 ACE FILE PRODUCED AT NEA WITH NDEC  
Photon emission for (n,a\*5)

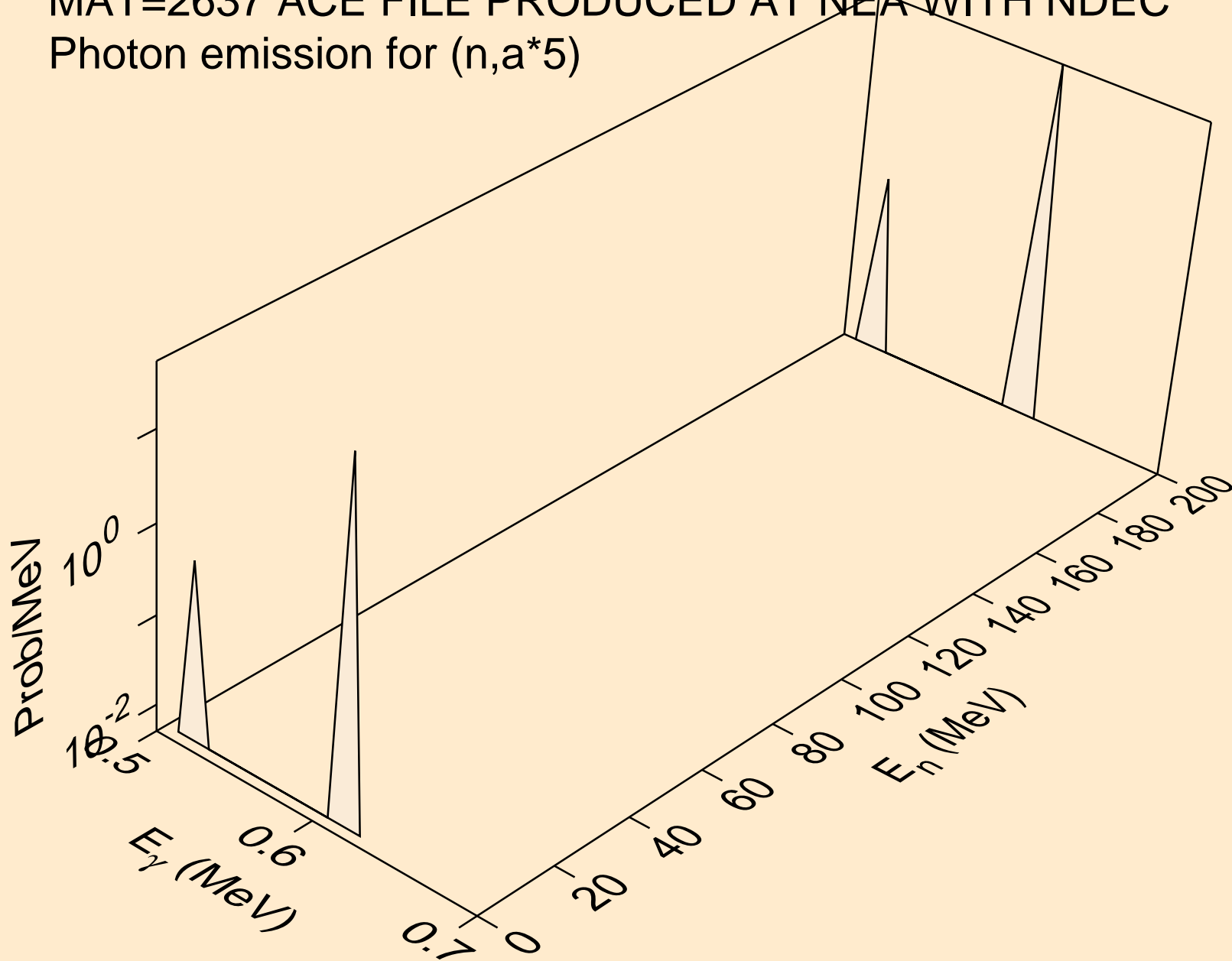

MAT=2637 ACE FILE PRODUCED AT NEA WITH NDEC  
Photon emission for (n,a\*6)

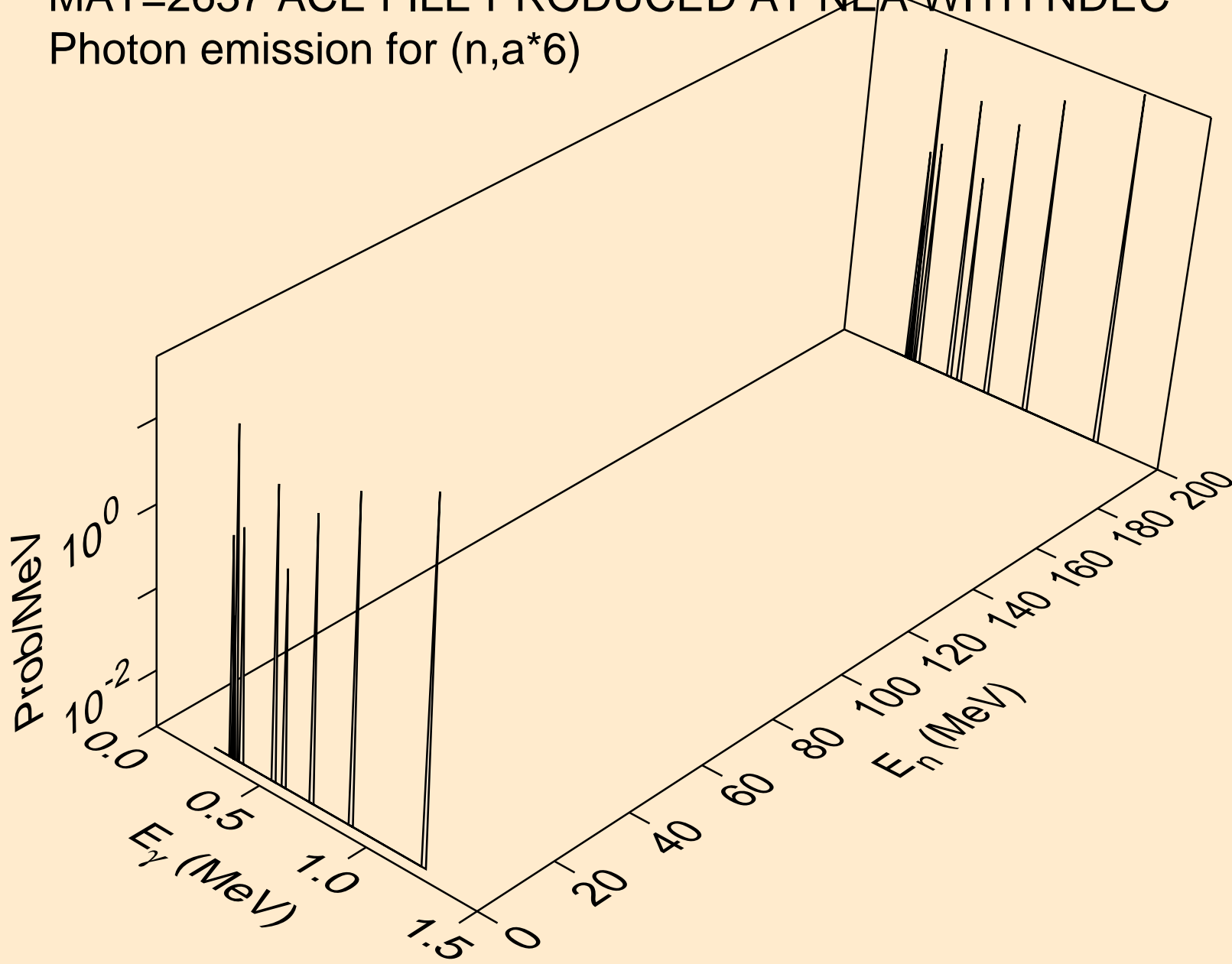

MAT=2637 ACE FILE PRODUCED AT NEA WITH NDEC  
Photon emission for (n,a\*7)

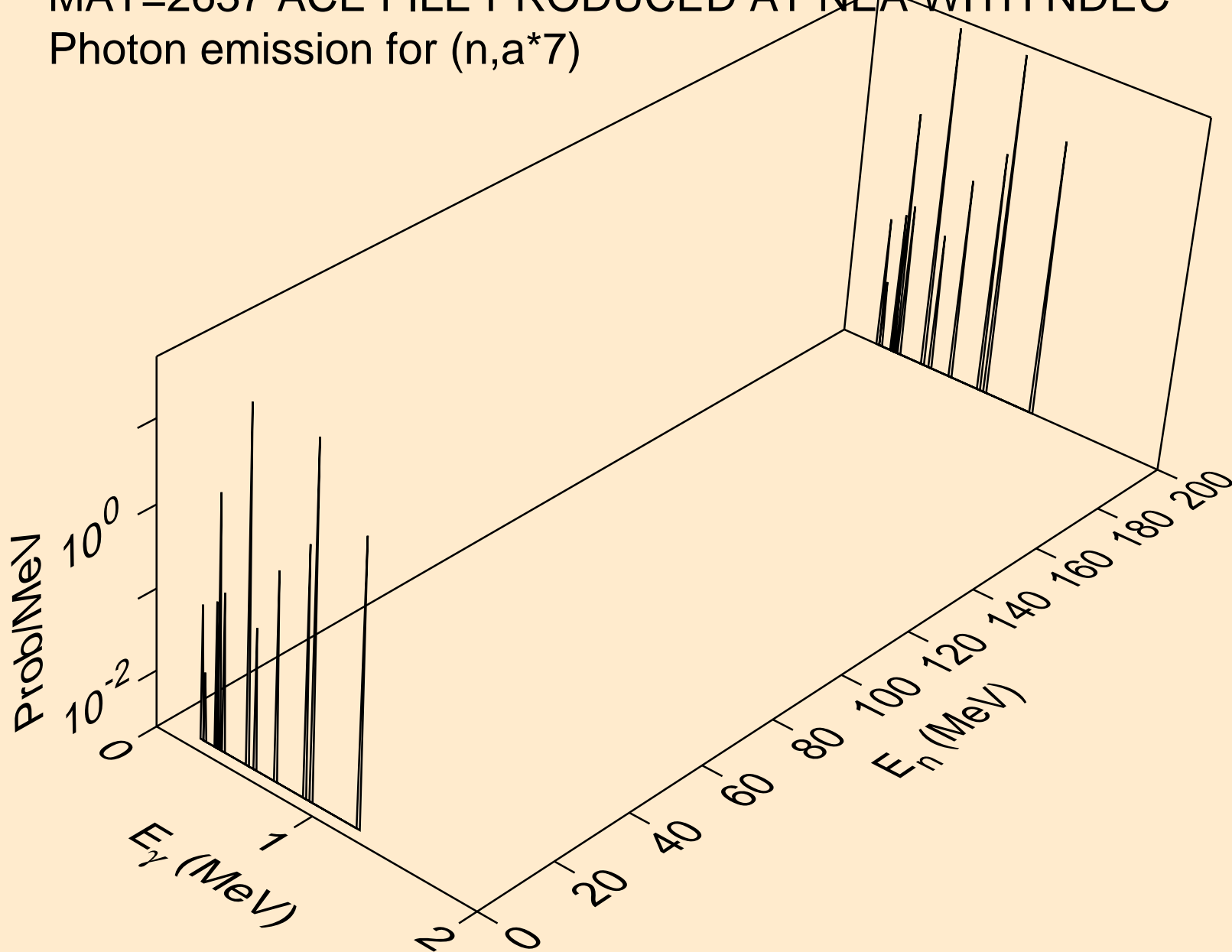

MAT=2637 ACE FILE PRODUCED AT NEA WITH NDEC  
Photon emission for (n,a\*8)

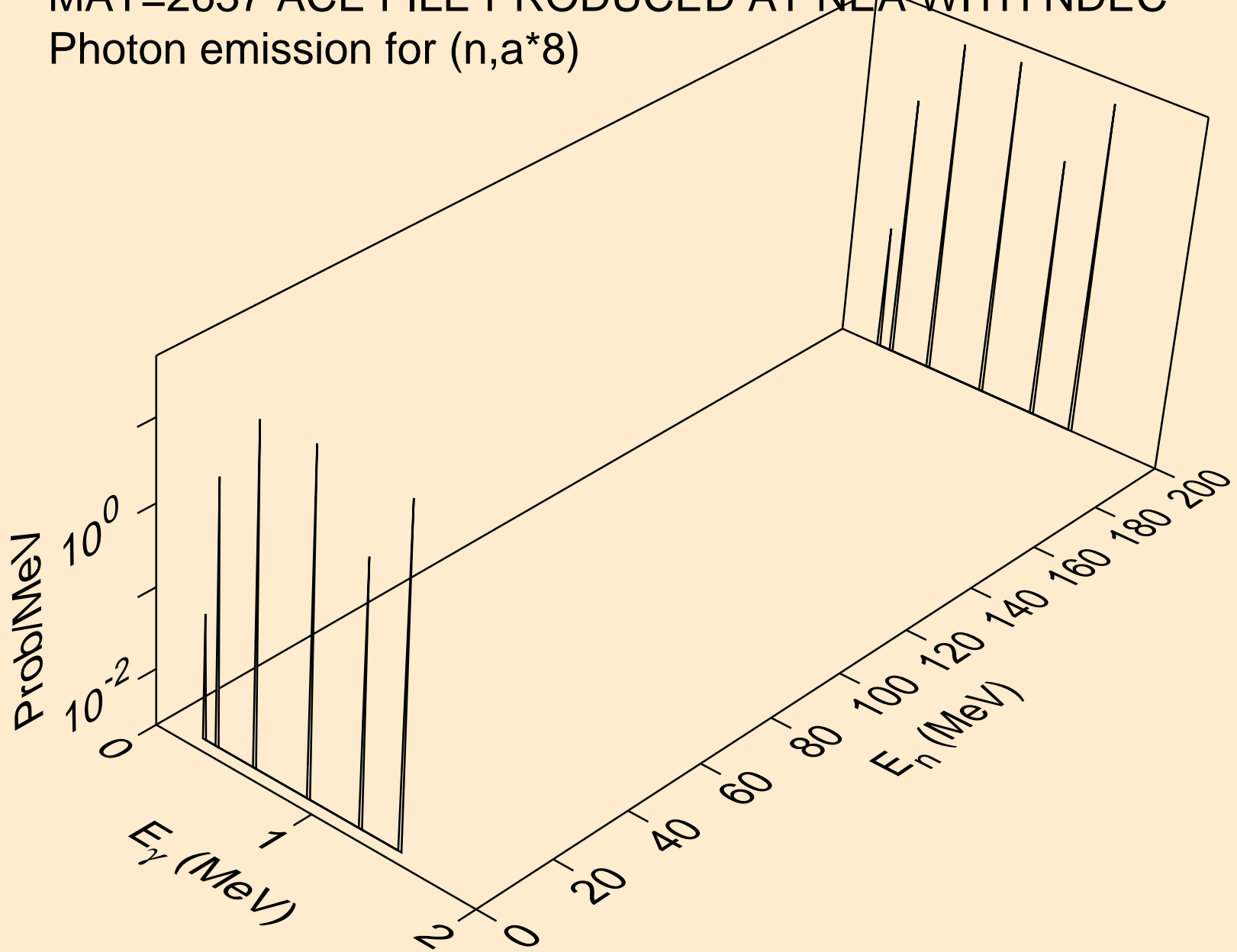

MAT=2637 ACE FILE PRODUCED AT NEA WITH NDEC  
Photon emission for (n,a\*9)

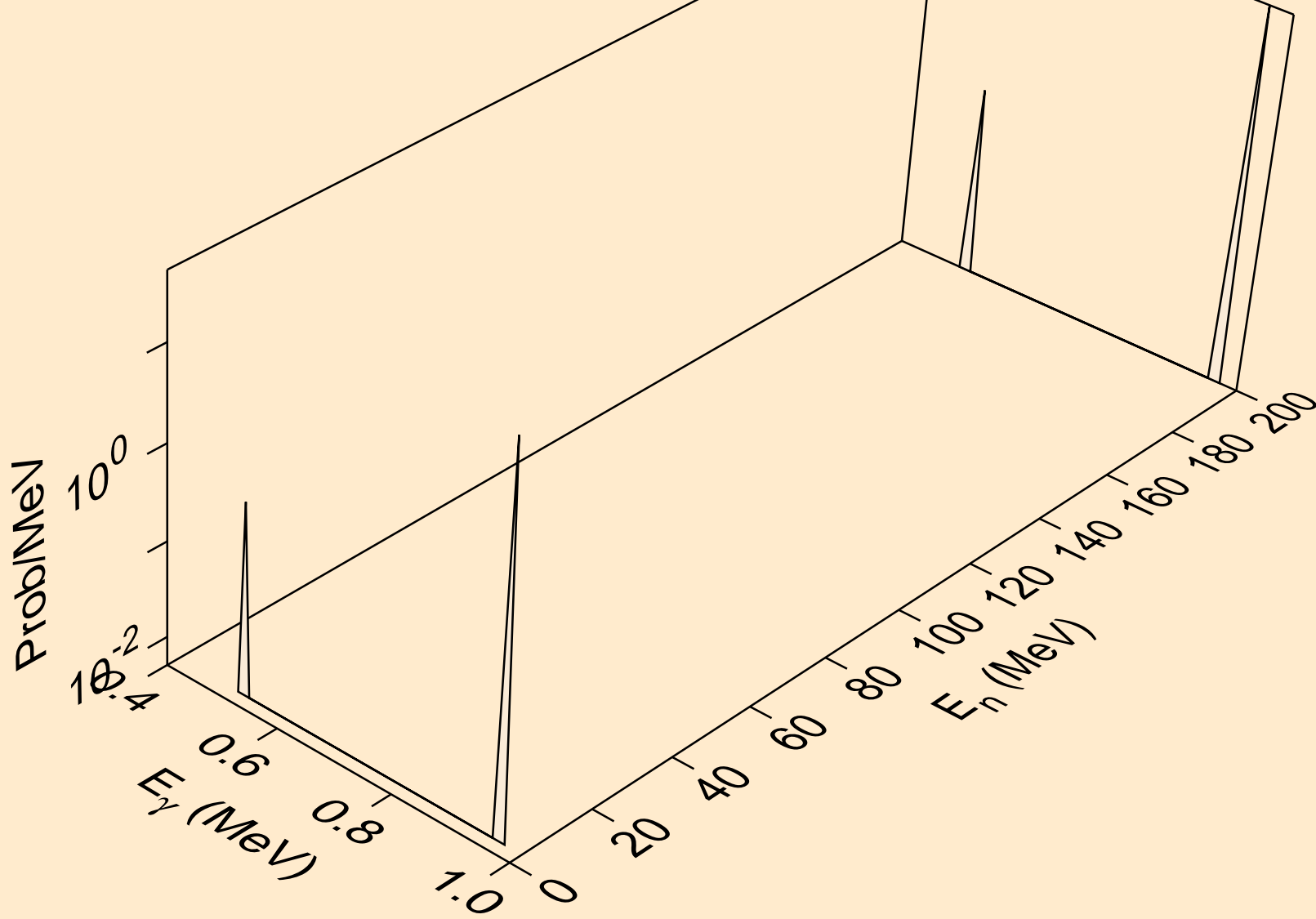

MAT=2637 ACE FILE PRODUCED AT NEA WITH NDEC  
Photon emission for (n,a\*10)

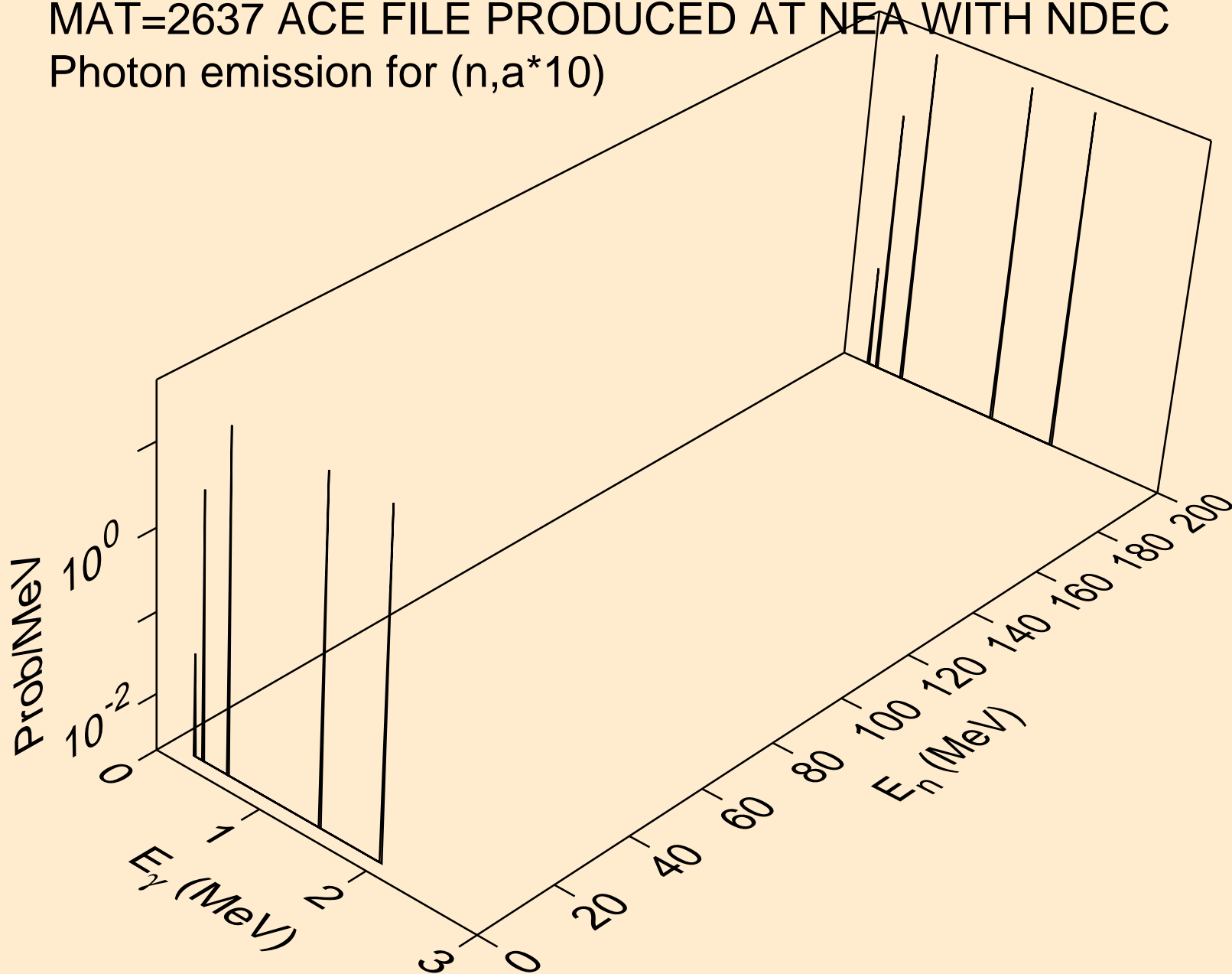



MAT=2637 ACE FILE PRODUCED AT NEA WITH NDEC  
Photon emission for (n,a\*c)

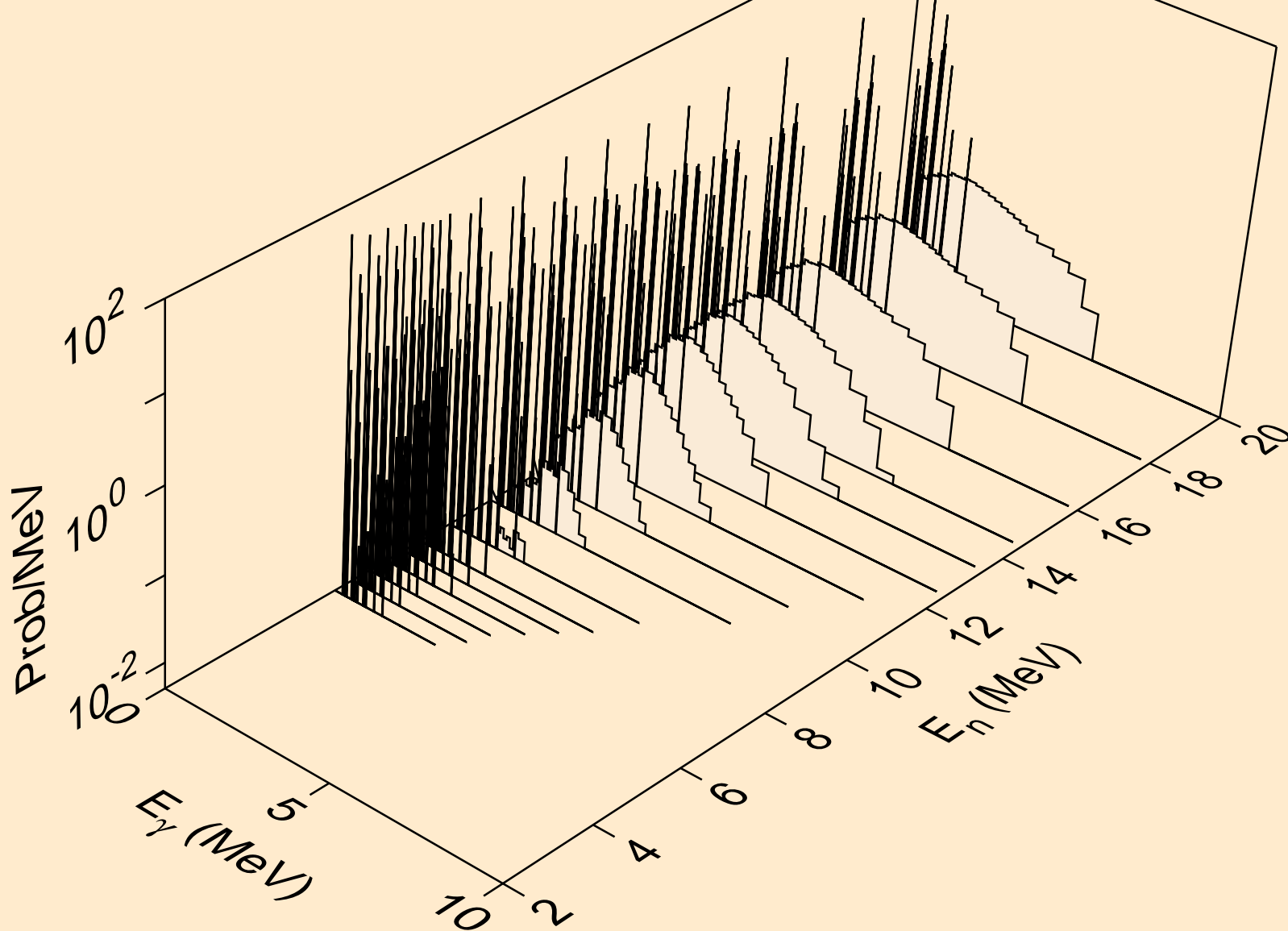

MAT=2637 ACE FILE PRODUCED AT NEA WITH NDEC  
thermal capture photon spectrum

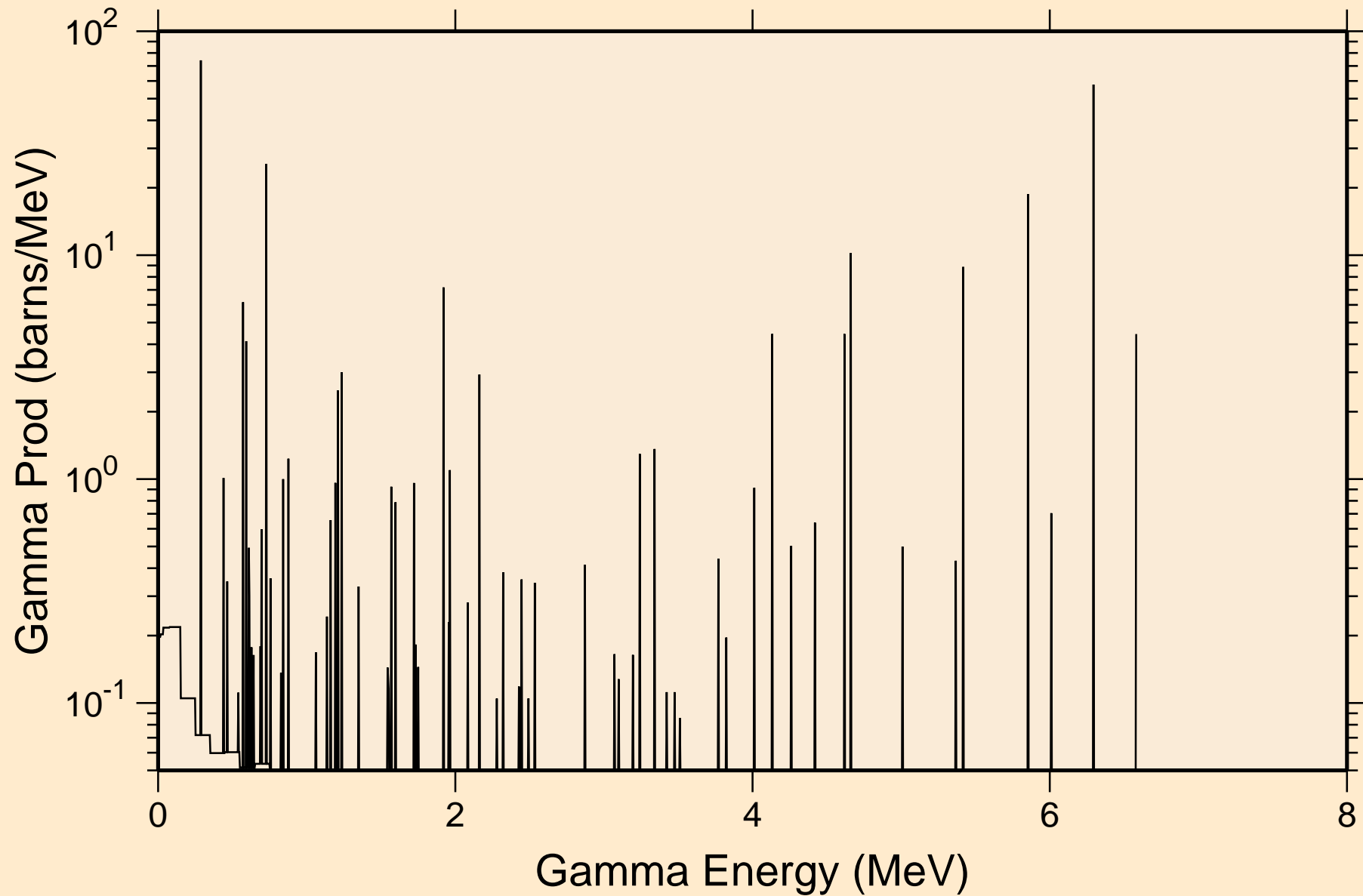

MAT=2637 ACE FILE PRODUCED AT NEA WITH NDEC  
14 MeV photon spectrum

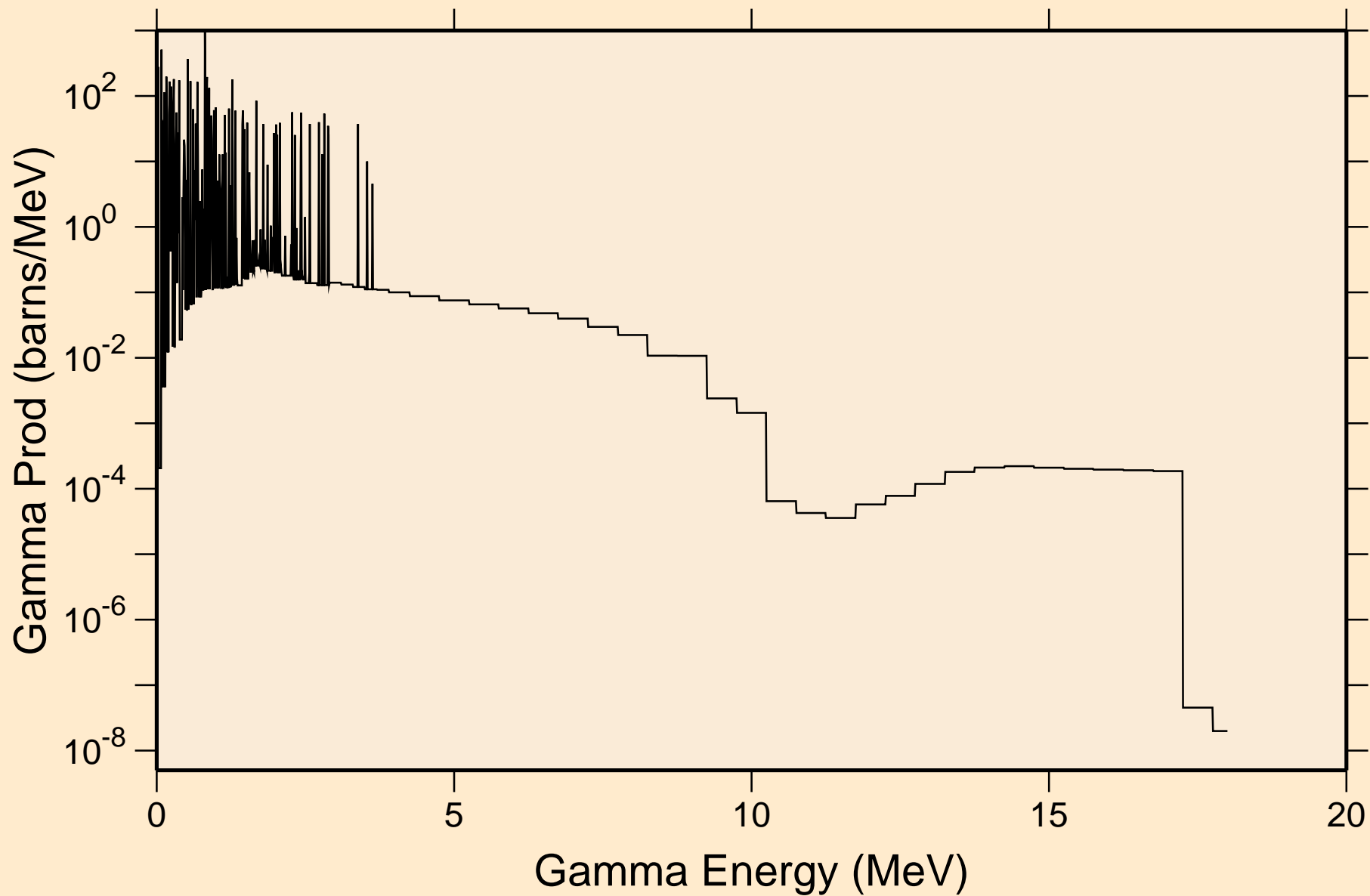

MAT=2637 ACE FILE PRODUCED AT NEA WITH NDEC  
Particle heating contributions

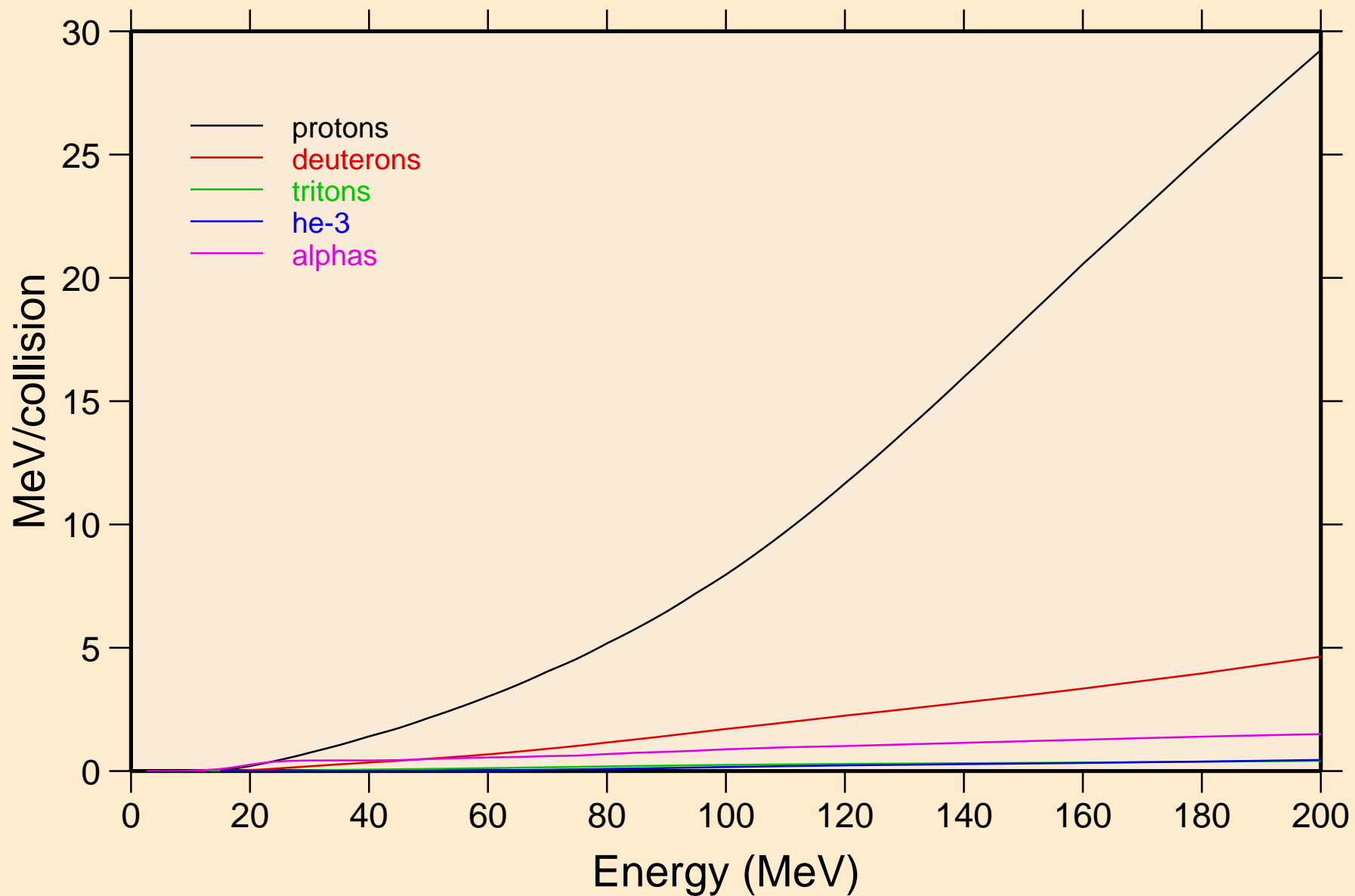

MAT=2637 ACE FILE PRODUCED AT NEA WITH NDEC  
Recoil Heating

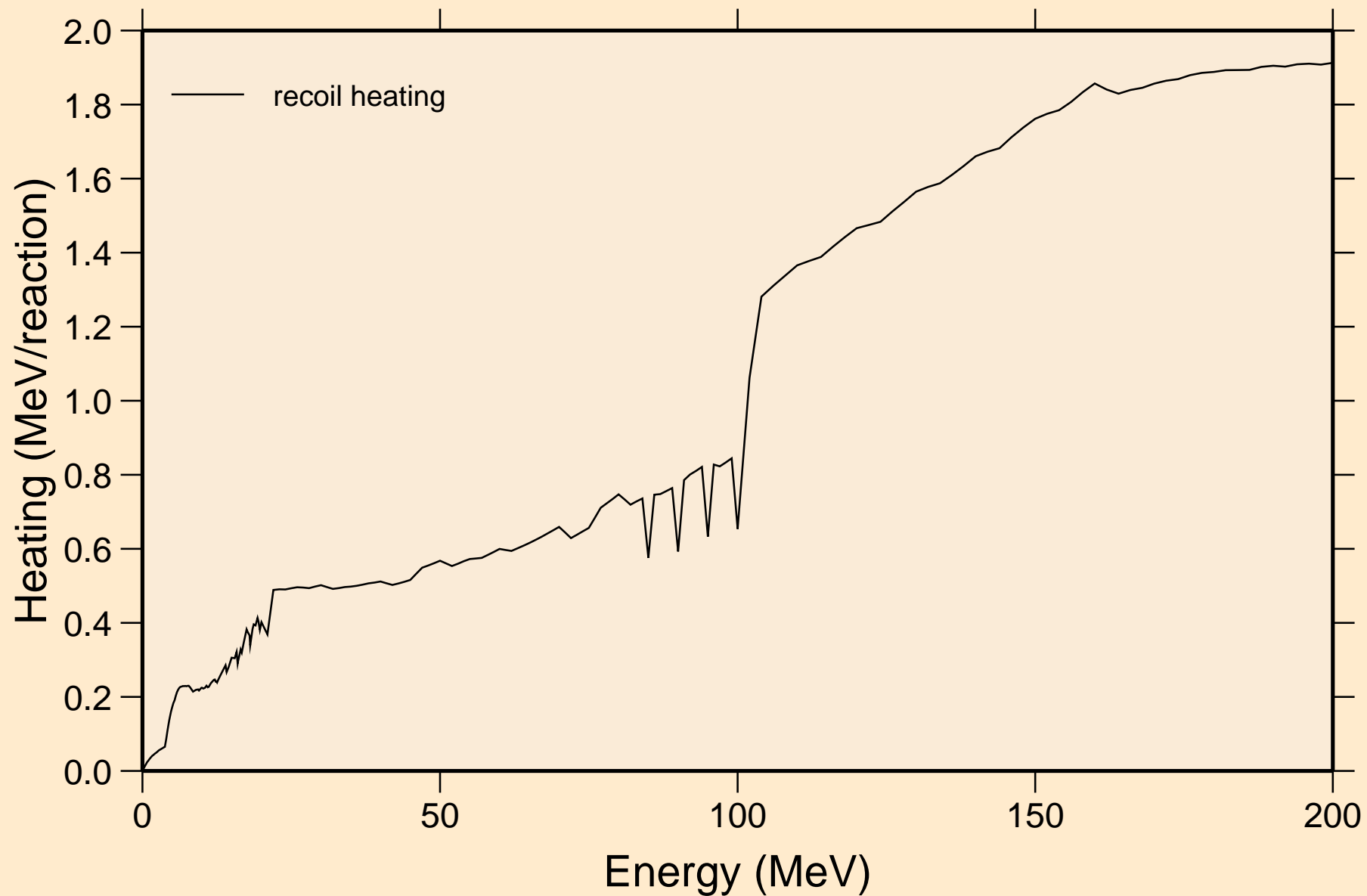

MAT=2637 ACE FILE PRODUCED AT NEA WITH NDEC  
Particle production cross sections

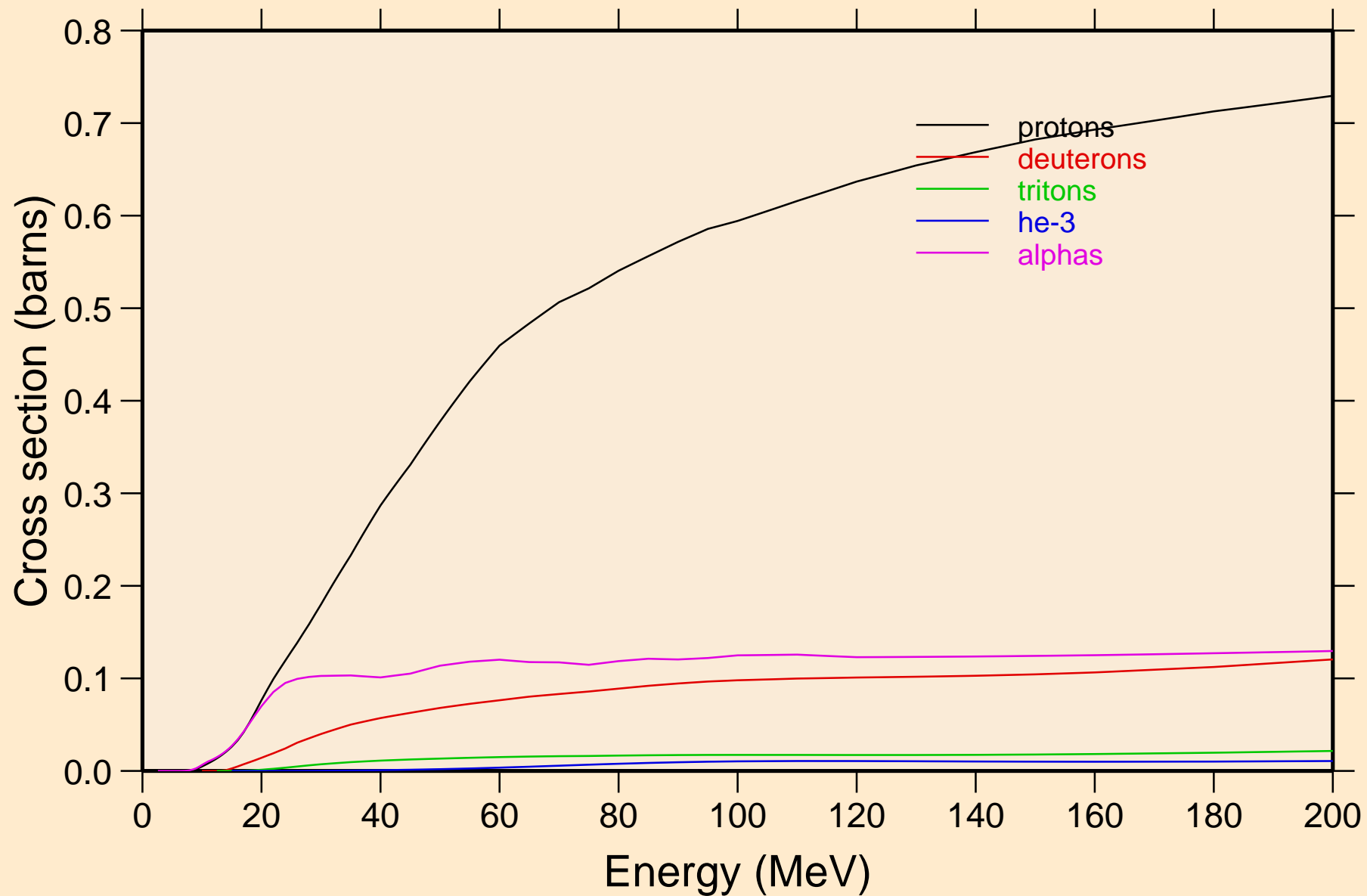

MAT=2637 ACE FILE PRODUCED AT NEA WITH NDEC  
protons from (n,x)

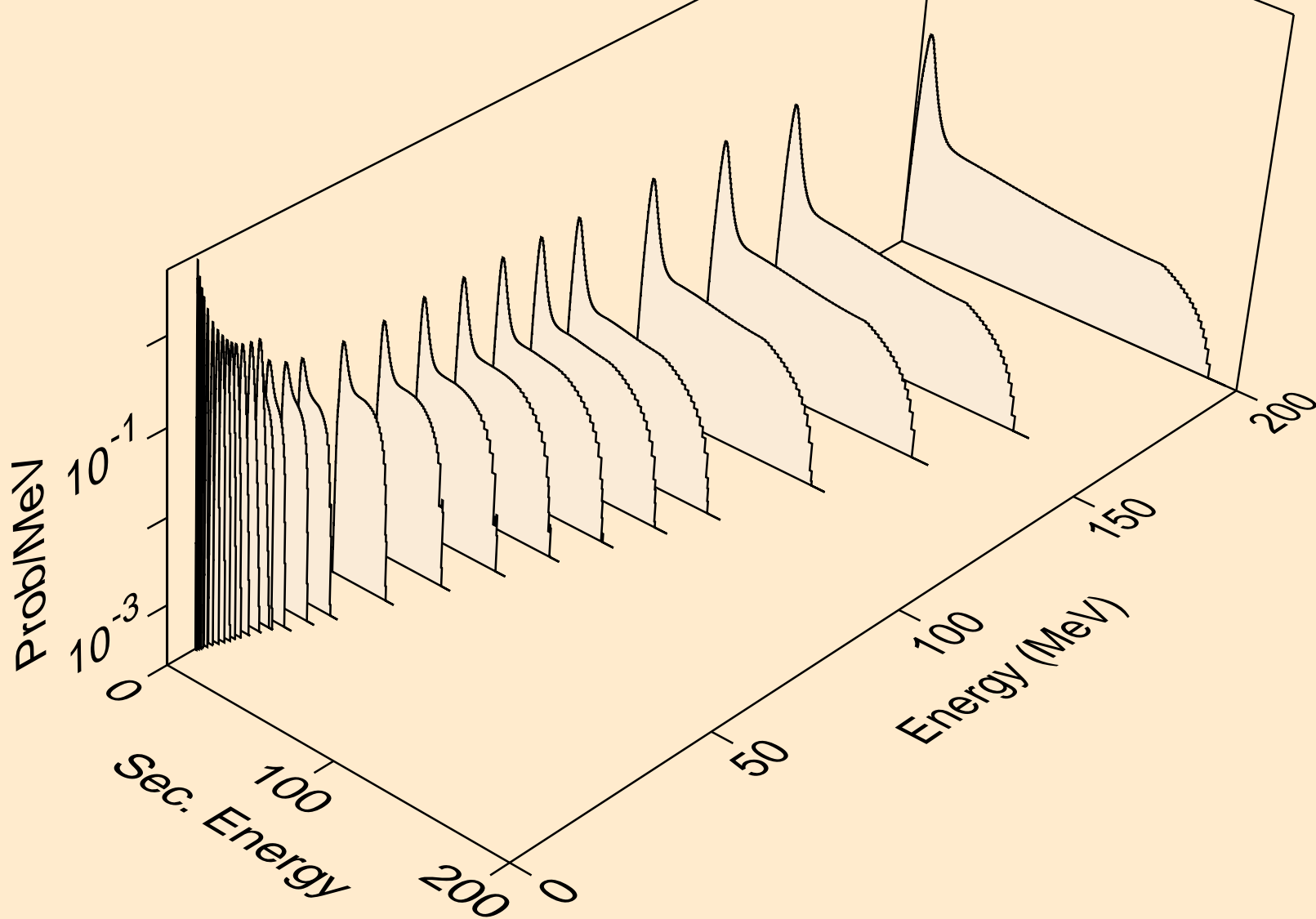

MAT=2637 ACE FILE PRODUCED AT NEA WITH NDEC  
protons from (n,n\*)p

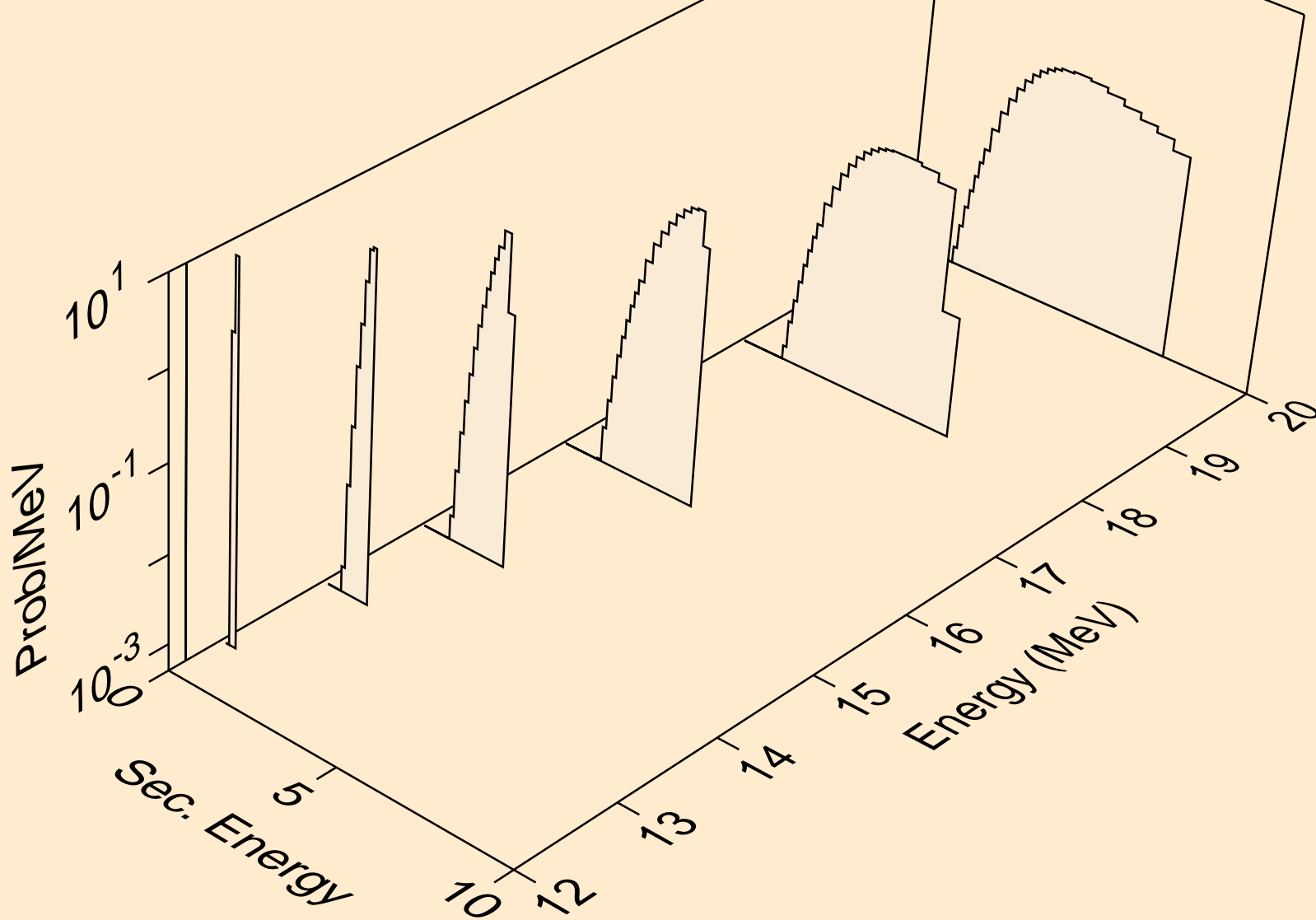



MAT=2637 ACE FILE PRODUCED AT NEA WITH NDEC  
angular distribution for (n,p\*0) proton

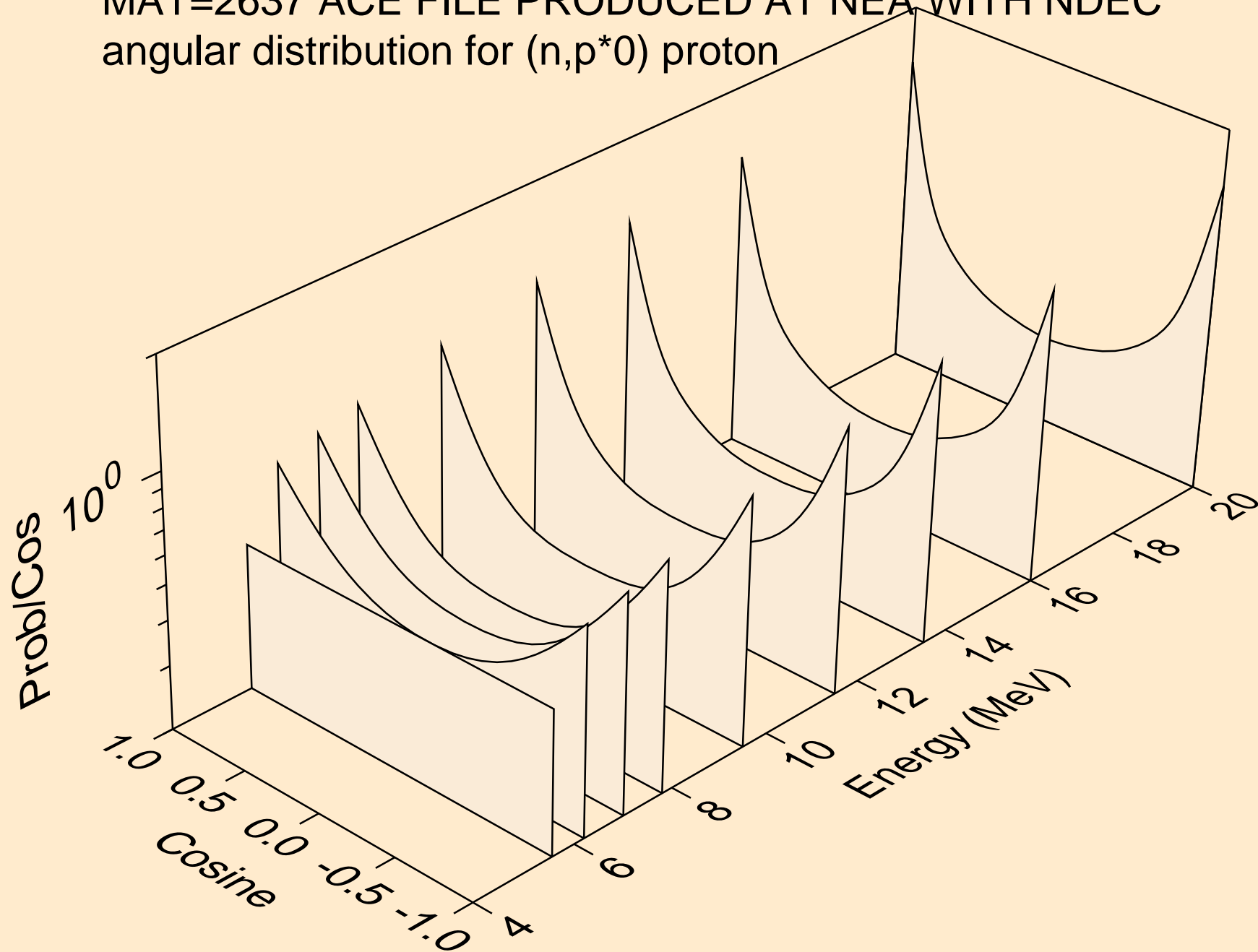

MAT=2637 ACE FILE PRODUCED AT NEA WITH NDEC  
angular distribution for (n,p\*1) proton

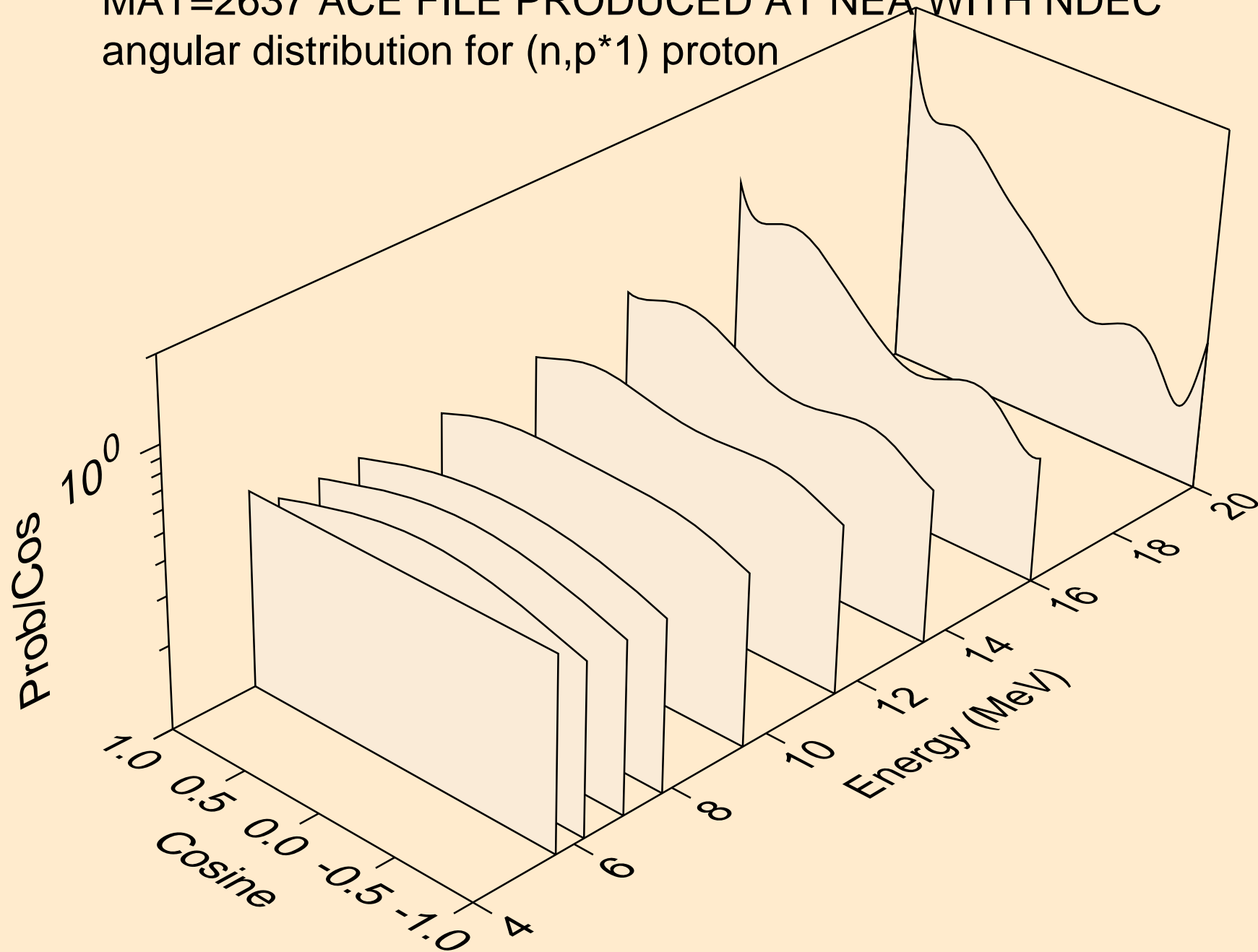

MAT=2637 ACE FILE PRODUCED AT NEA WITH NDEC  
angular distribution for (n,p\*2) proton

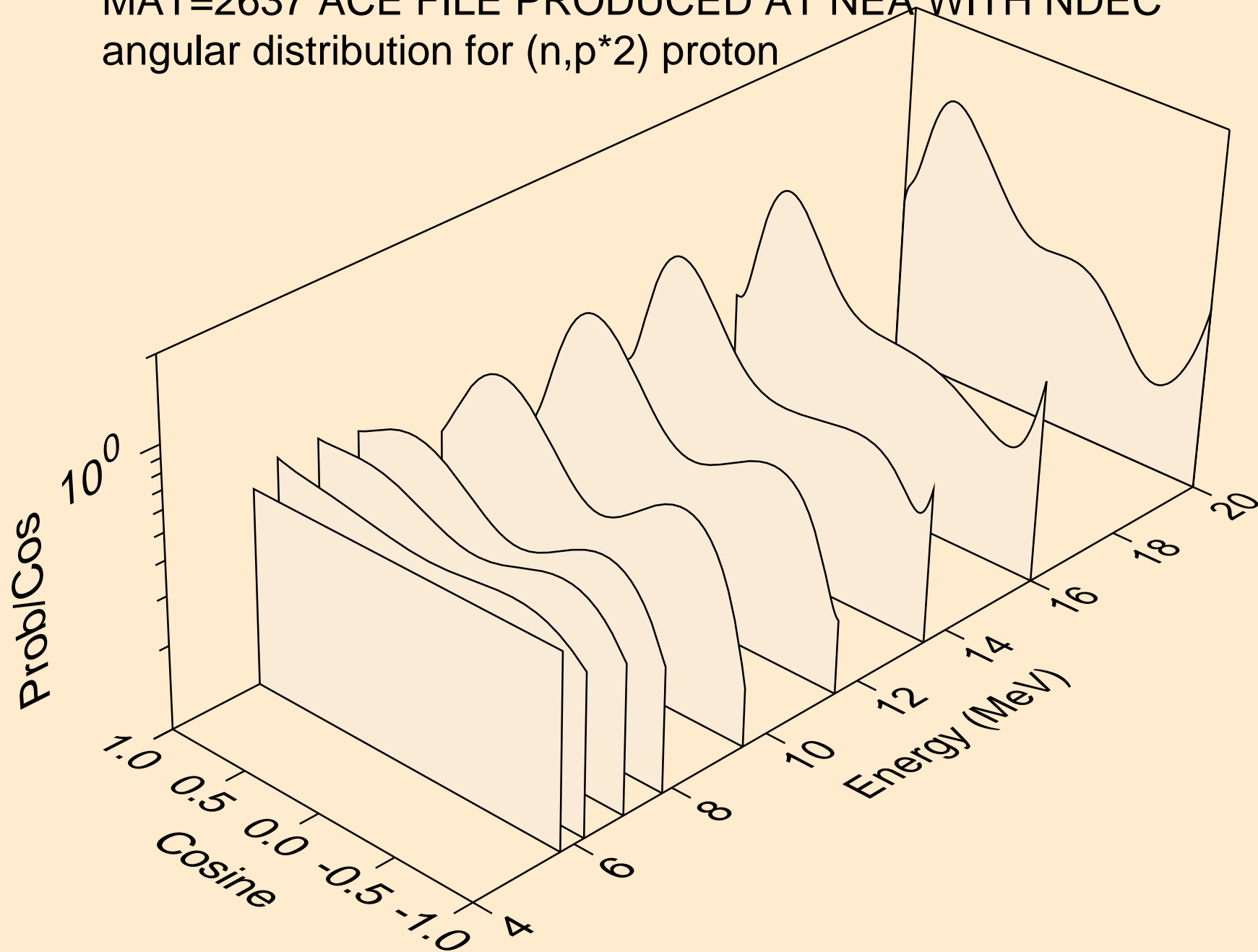

MAT=2637 ACE FILE PRODUCED AT NEA WITH NDEC  
angular distribution for (n,p\*3) proton

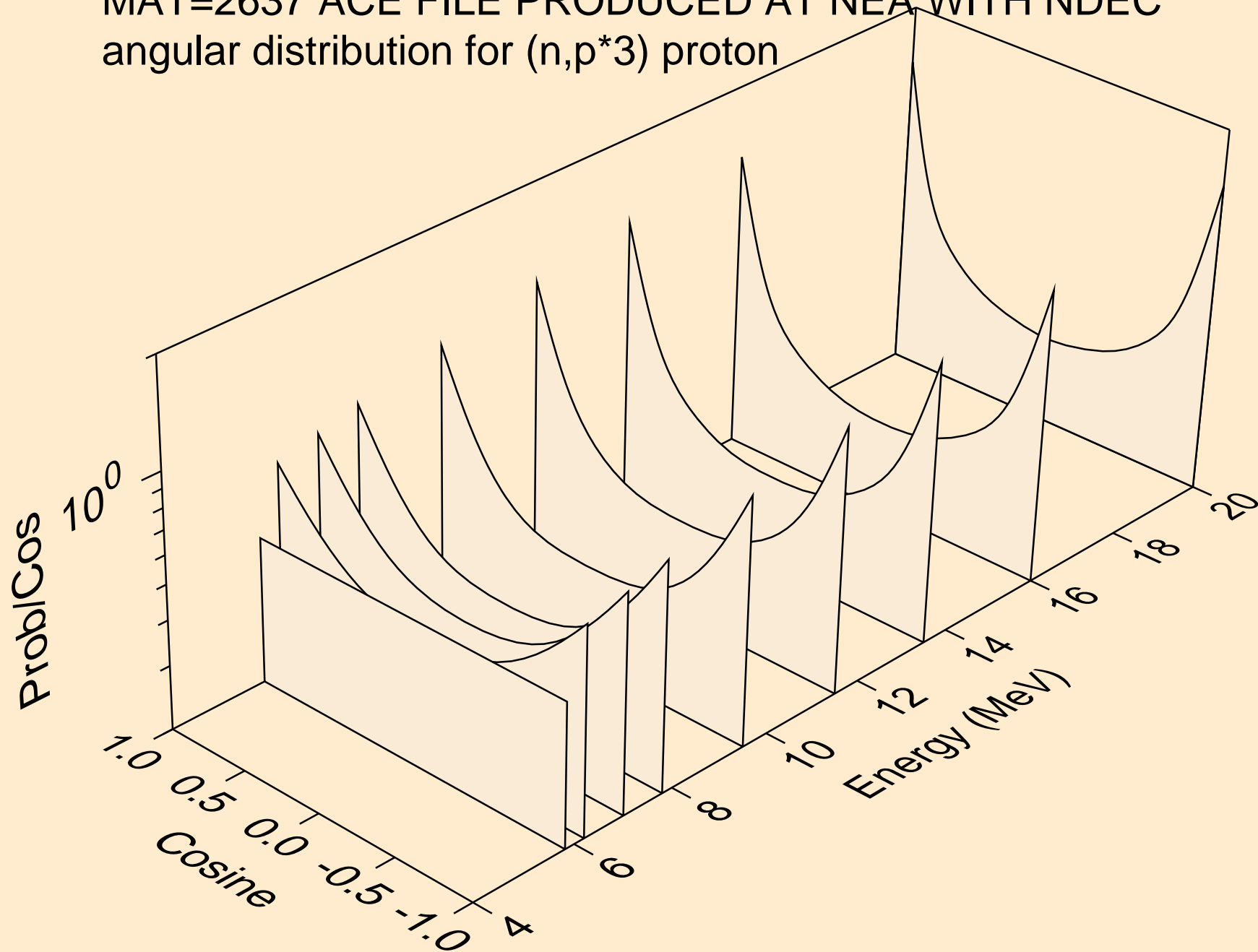

MAT=2637 ACE FILE PRODUCED AT NEA WITH NDEC  
angular distribution for (n,p\*4) proton

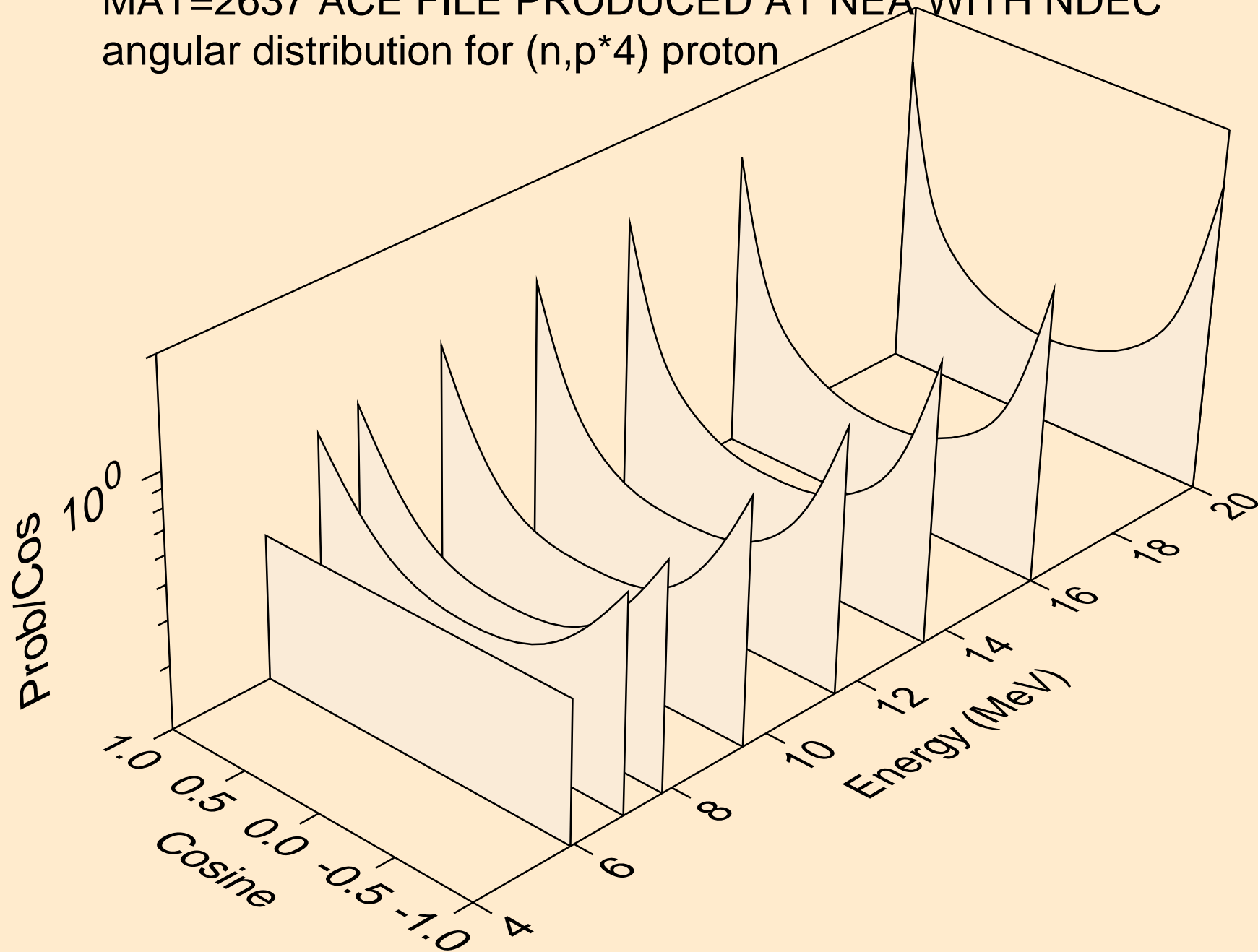

MAT=2637 ACE FILE PRODUCED AT NEA WITH NDEC  
angular distribution for (n,p\*5) proton

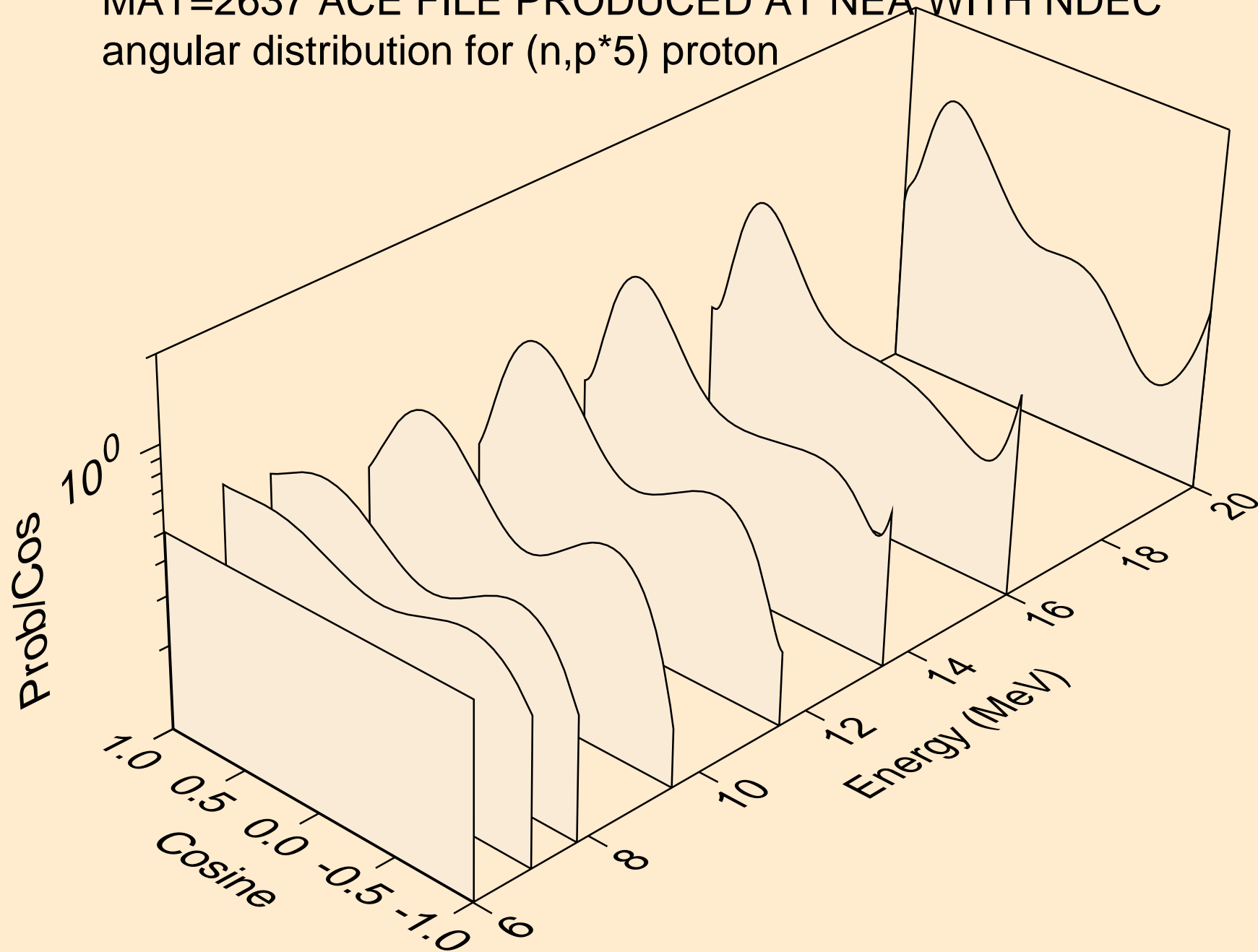

MAT=2637 ACE FILE PRODUCED AT NEA WITH NDEC  
angular distribution for (n,p\*6) proton

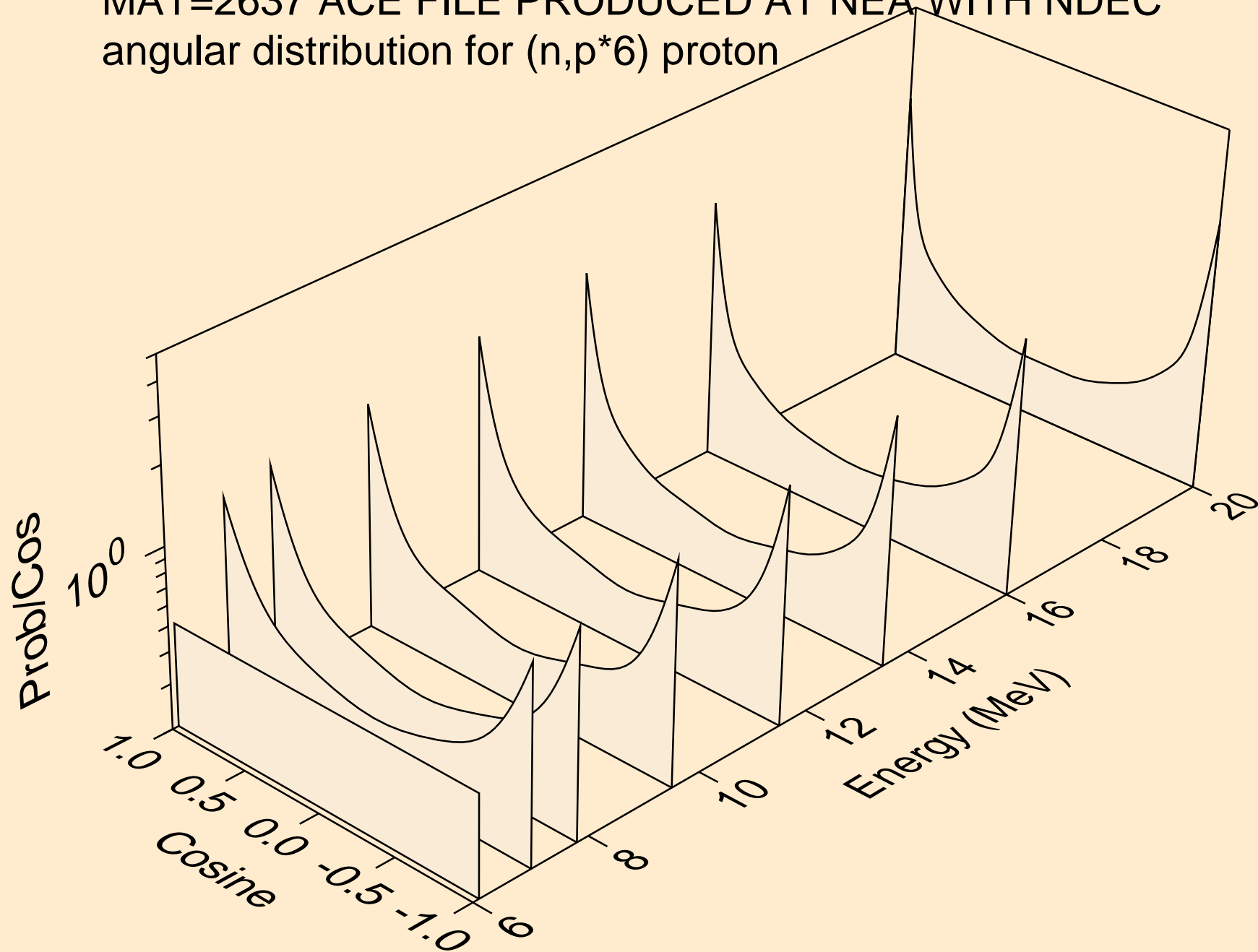

MAT=2637 ACE FILE PRODUCED AT NEA WITH NDEC  
angular distribution for (n,p\*7) proton

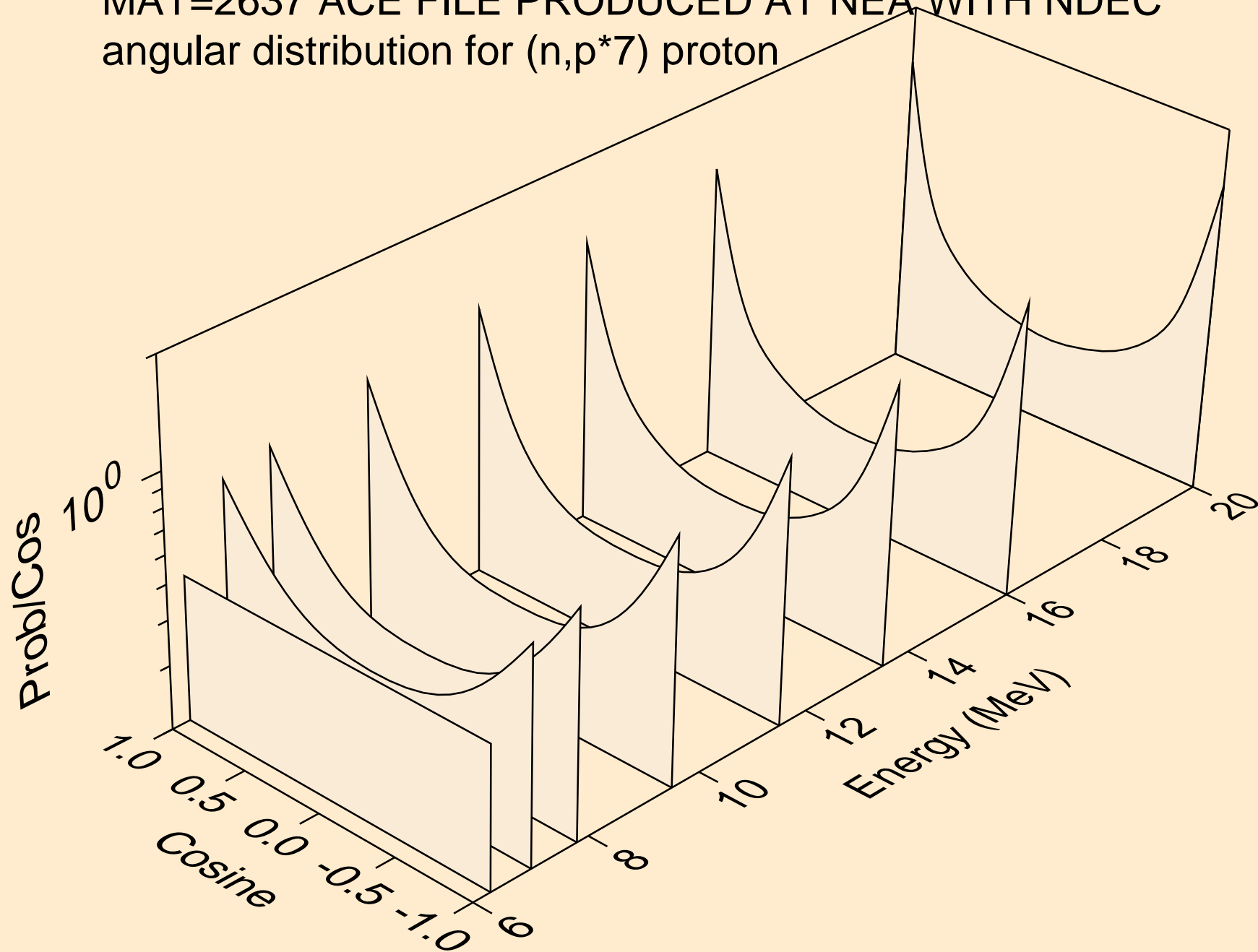



MAT=2637 ACE FILE PRODUCED AT NEA WITH NDEC  
angular distribution for (n,p\*8) proton

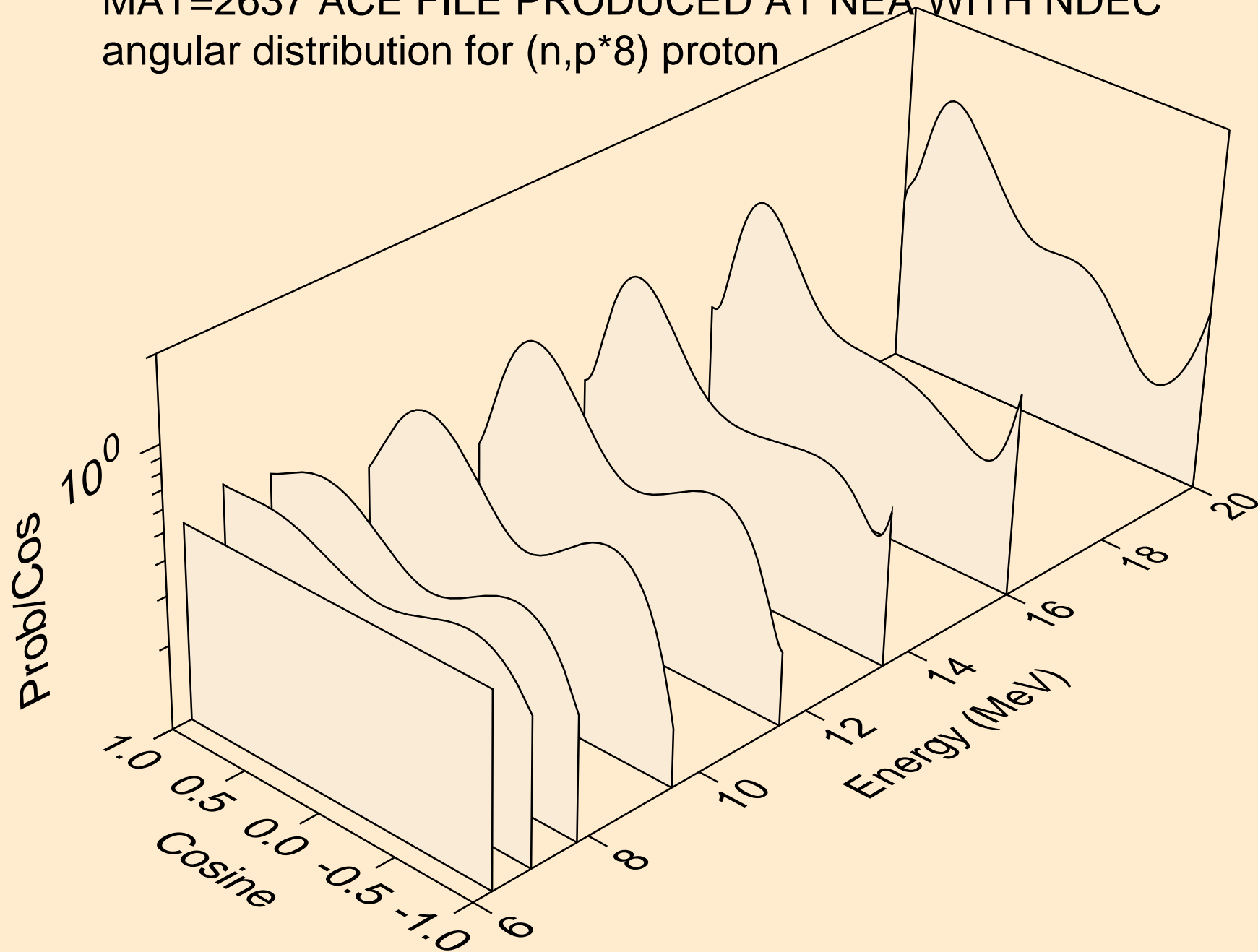

MAT=2637 ACE FILE PRODUCED AT NEA WITH NDEC  
angular distribution for (n,p\*9) proton

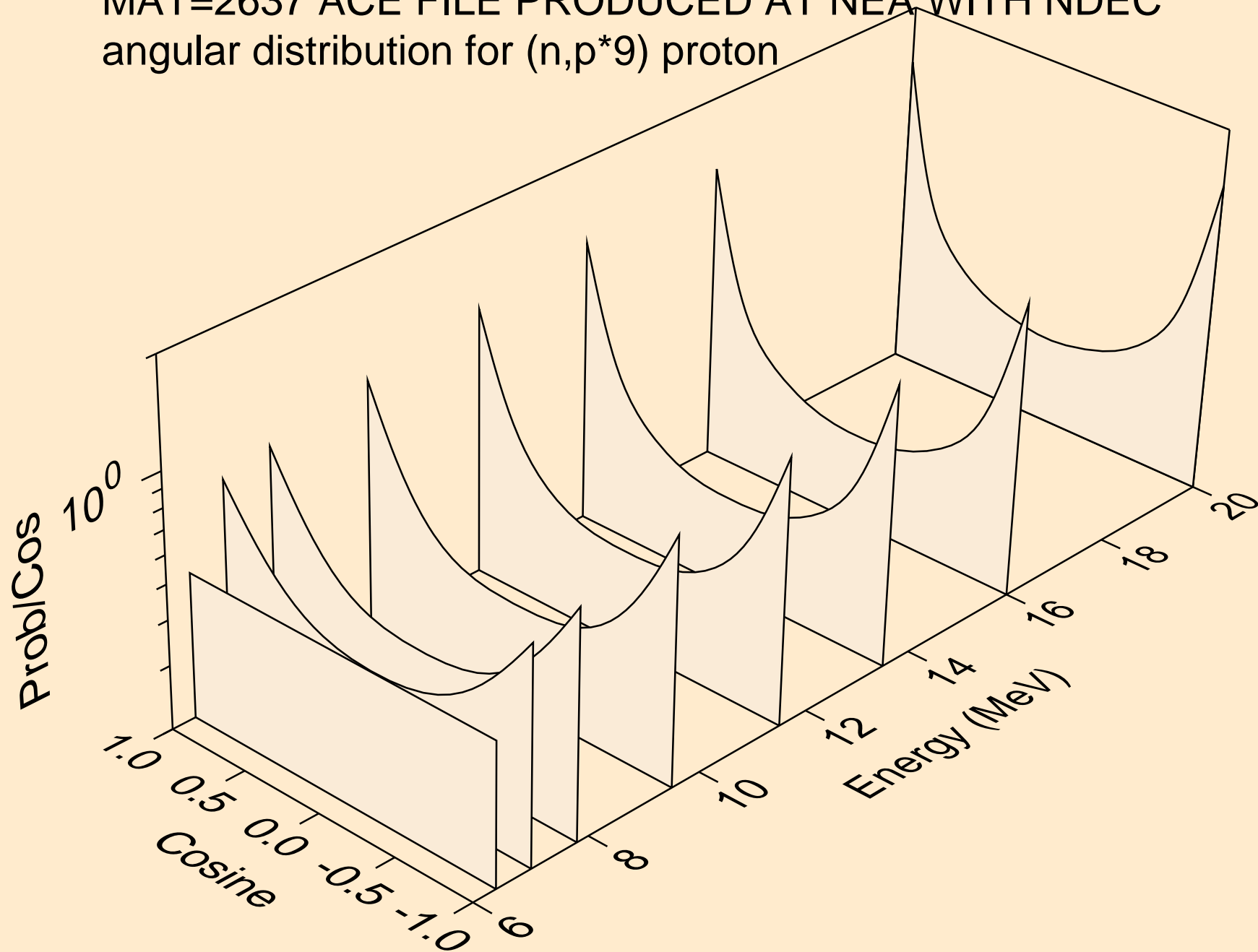

MAT=2637 ACE FILE PRODUCED AT NEA WITH NDEC  
angular distribution for (n,p\*10) proton

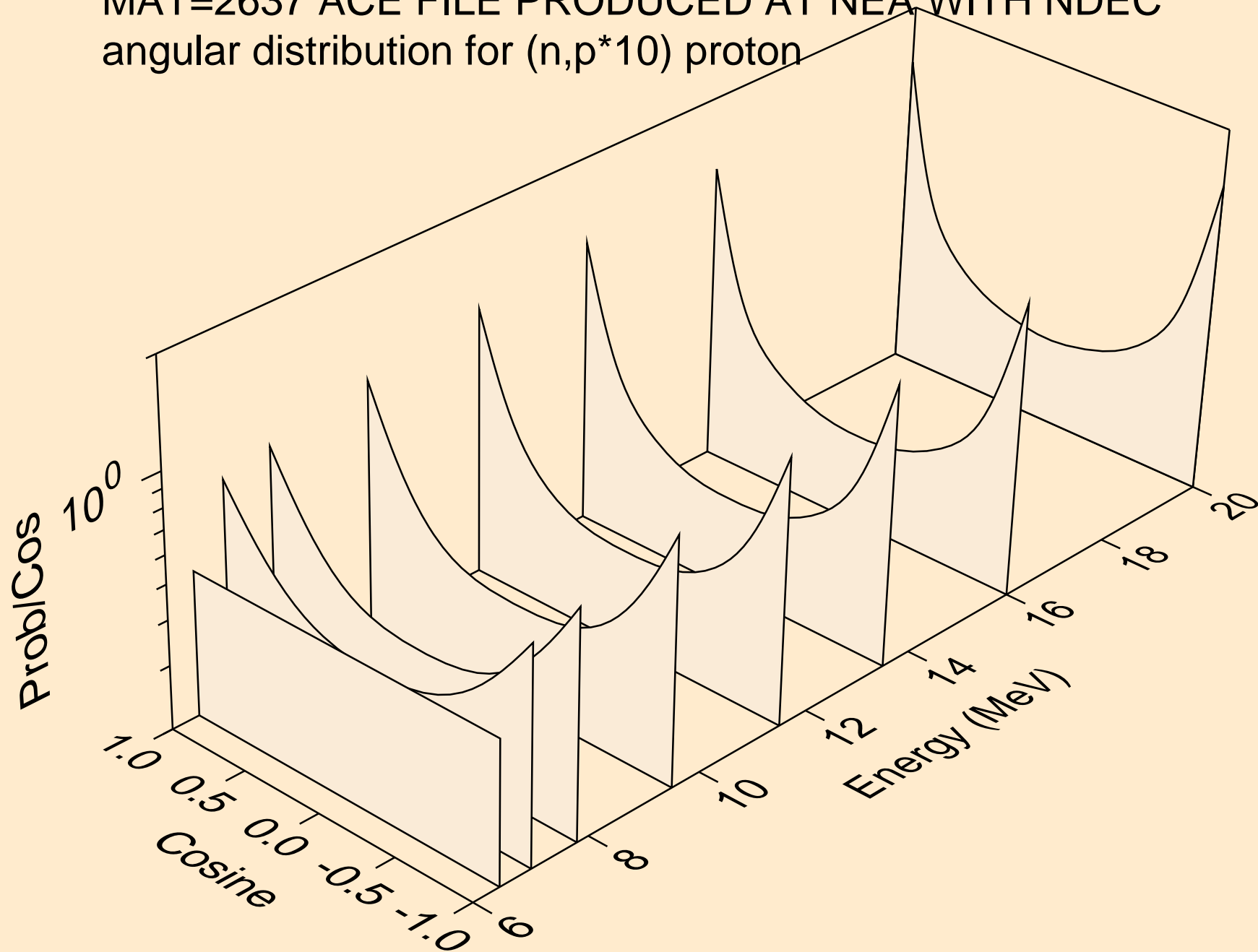

MAT=2637 ACE FILE PRODUCED AT NEA WITH NDEC  
protons from (n,p\*c)

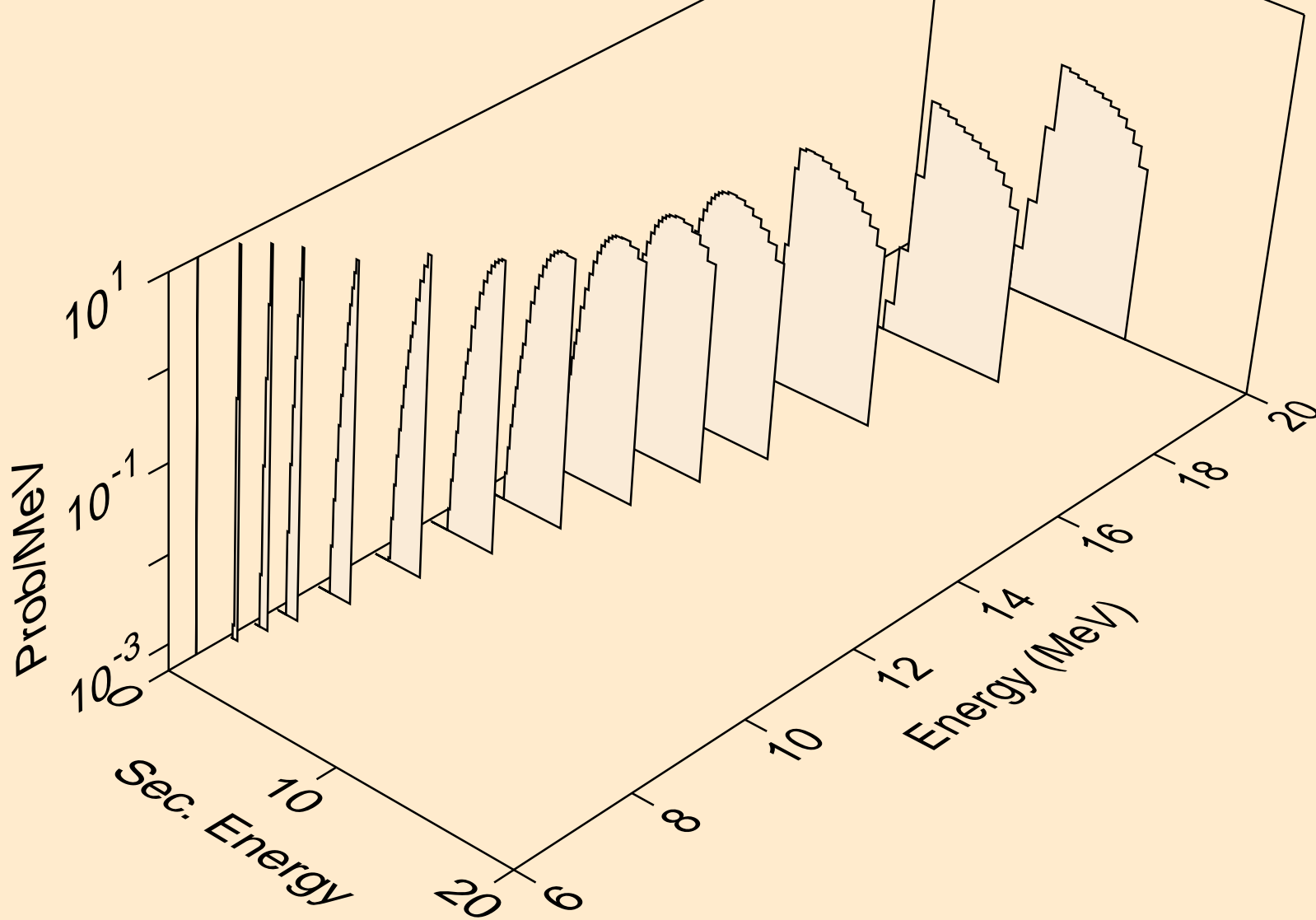

MAT=2637 ACE FILE PRODUCED AT NEA WITH NDEC  
deuterons from (n,x)

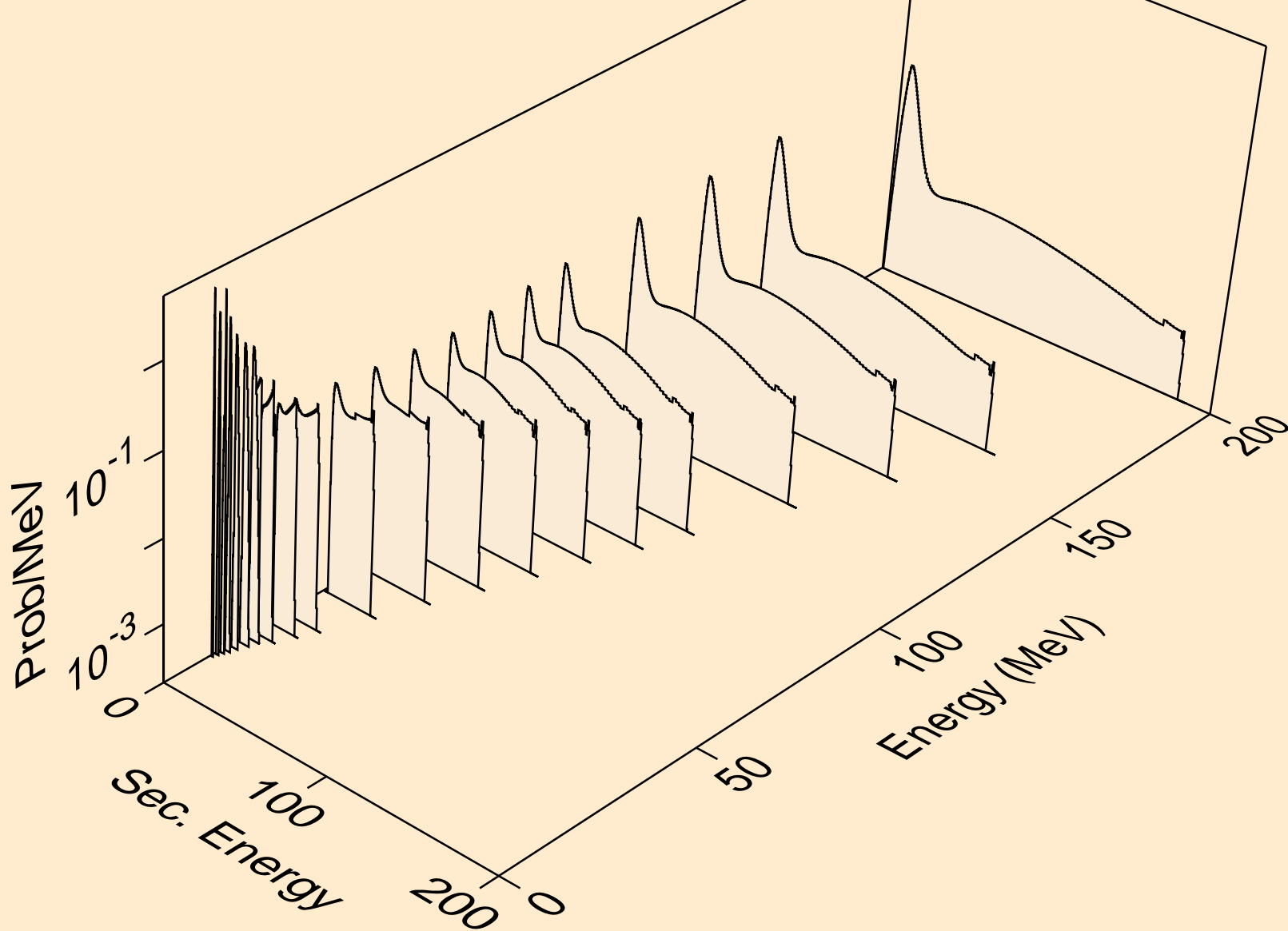

MAT=2637 ACE FILE PRODUCED AT NEA WITH NDEC  
angular distribution for (n,d\*0) deuteron

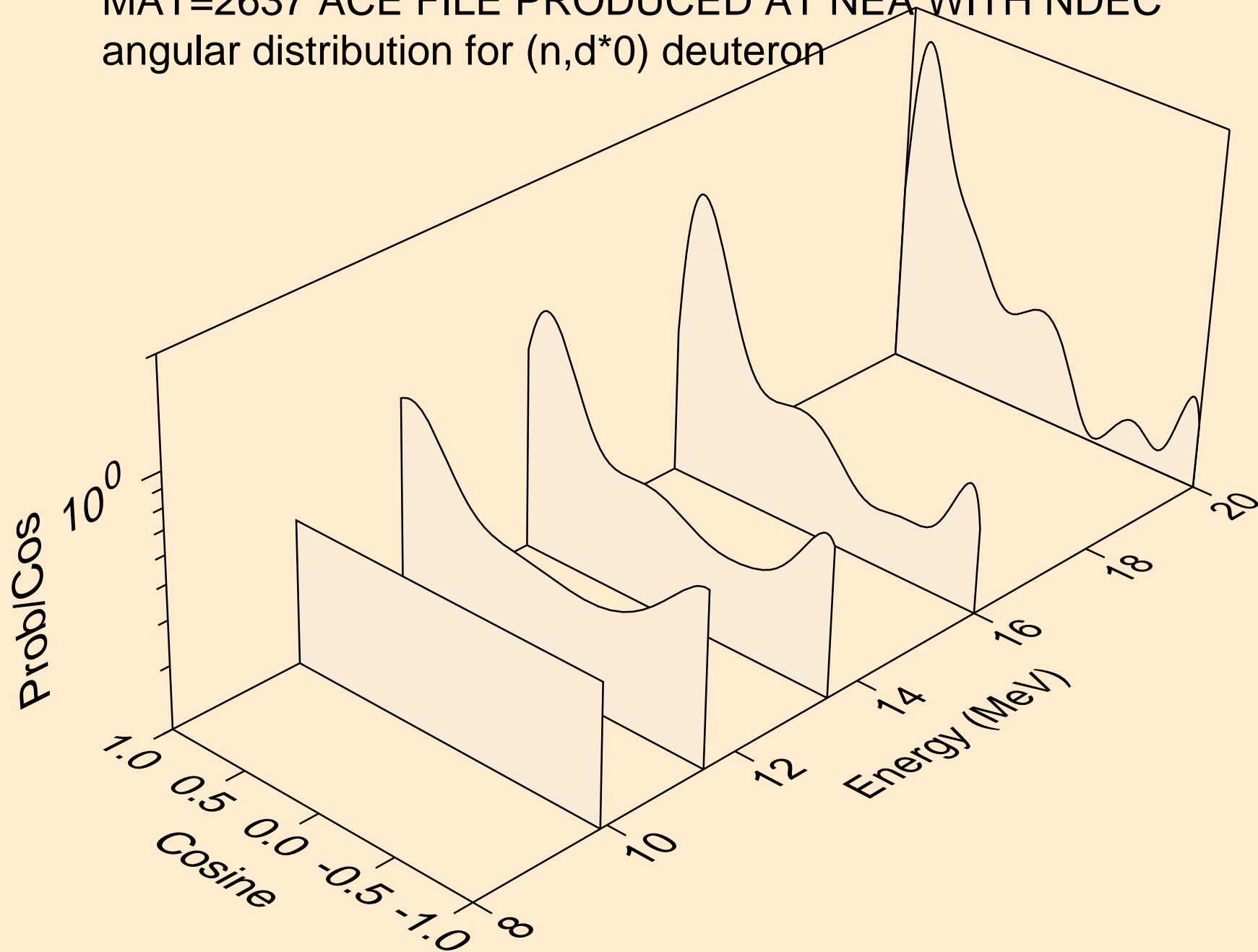

MAT=2637 ACE FILE PRODUCED AT NEA WITH NDEC  
angular distribution for (n,d\*1) deuteron

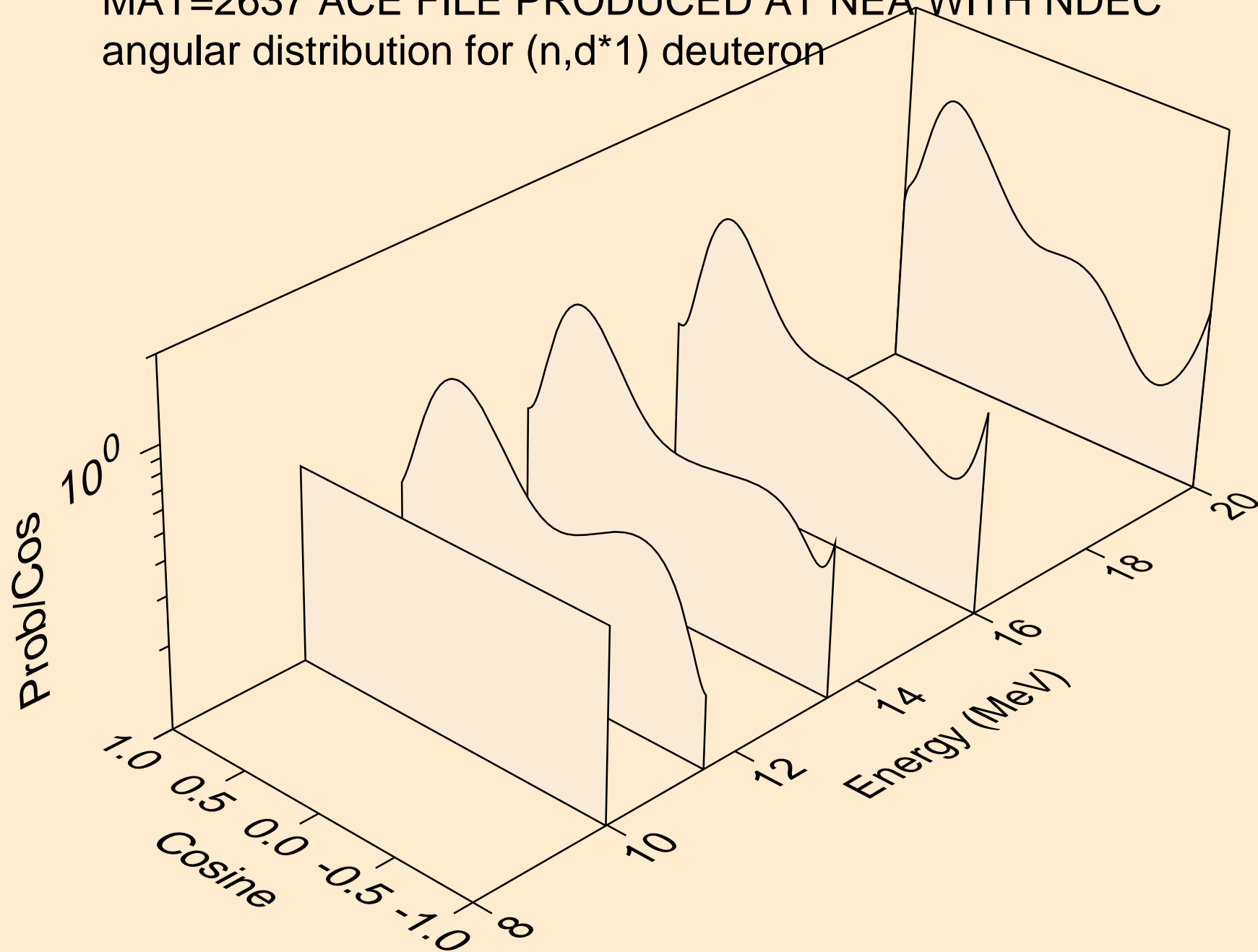

MAT=2637 ACE FILE PRODUCED AT NEA WITH NDEC  
angular distribution for (n,d\*2) deuteron

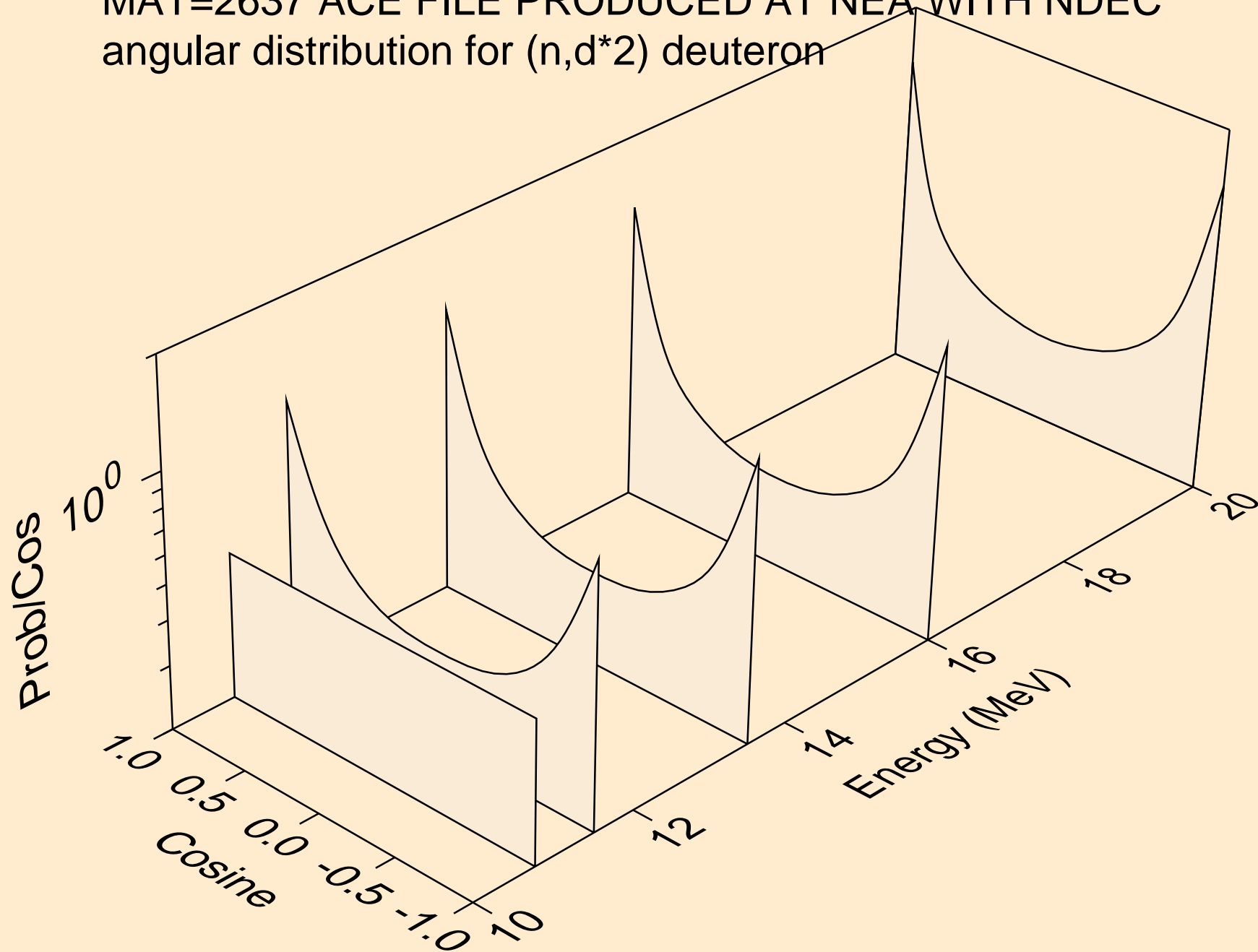



MAT=2637 ACE FILE PRODUCED AT NEA WITH NDEC  
angular distribution for (n,d\*3) deuteron

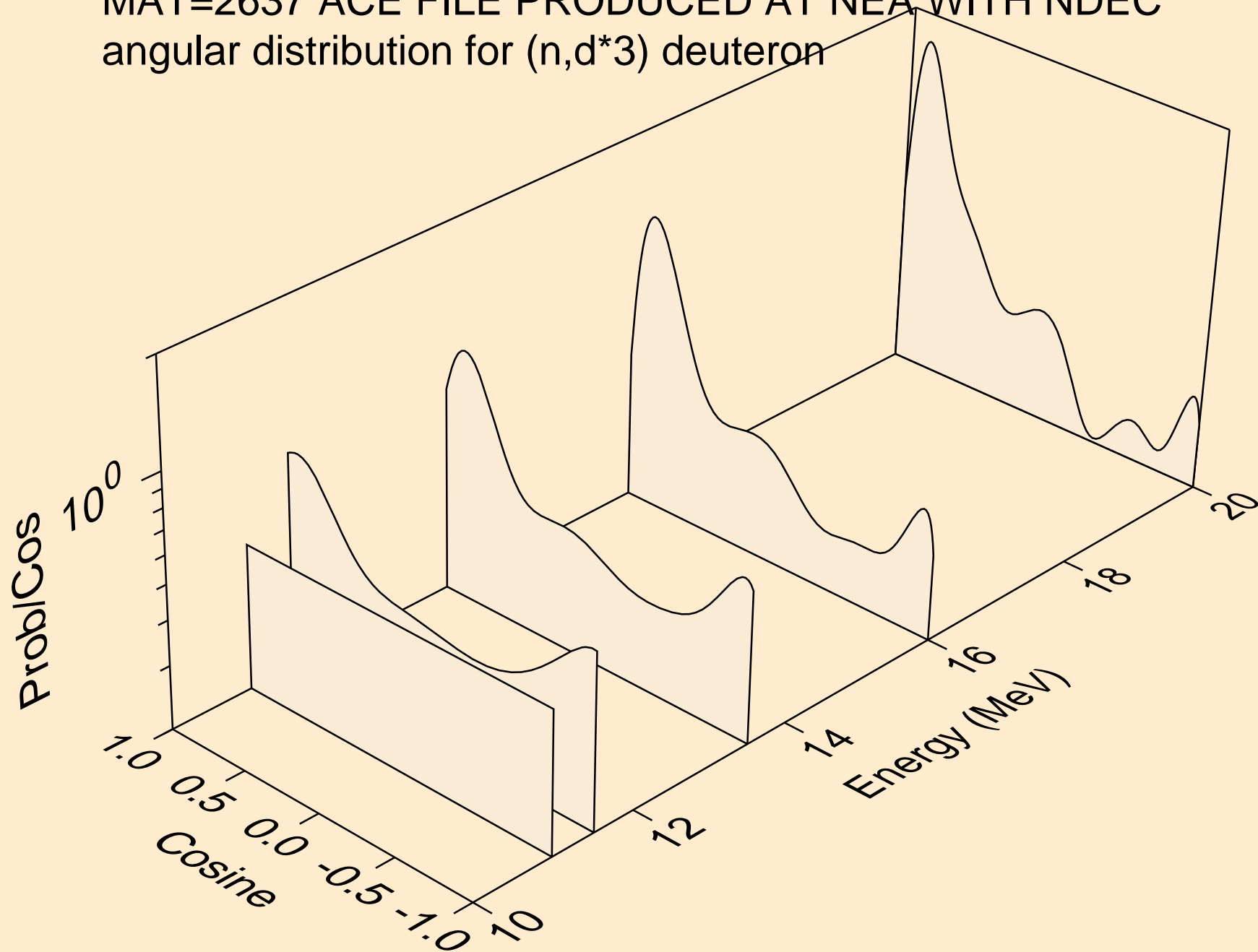

MAT=2637 ACE FILE PRODUCED AT NEA WITH NDEC  
angular distribution for (n,d\*4) deuteron

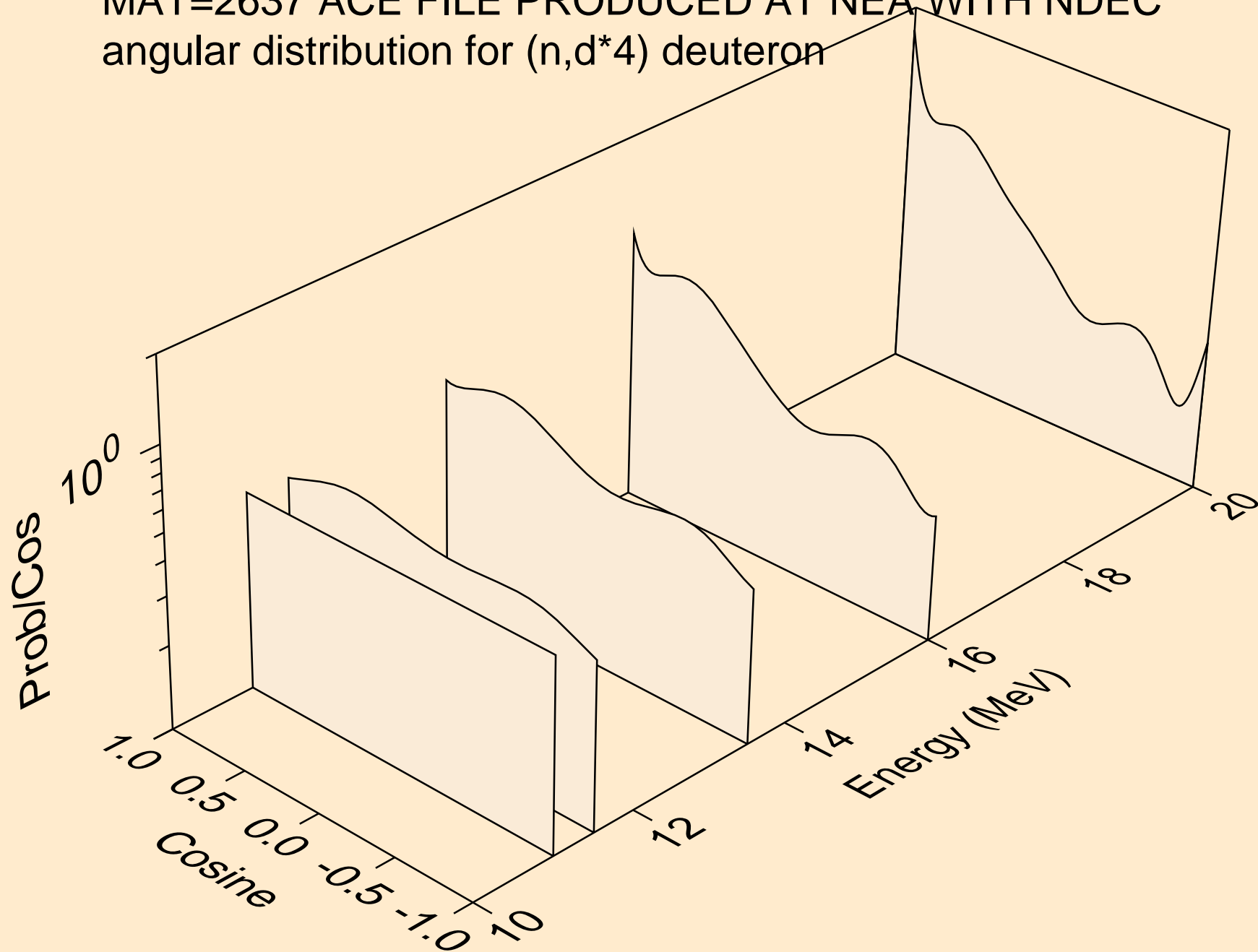

MAT=2637 ACE FILE PRODUCED AT NEA WITH NDEC  
angular distribution for (n,d\*5) deuteron

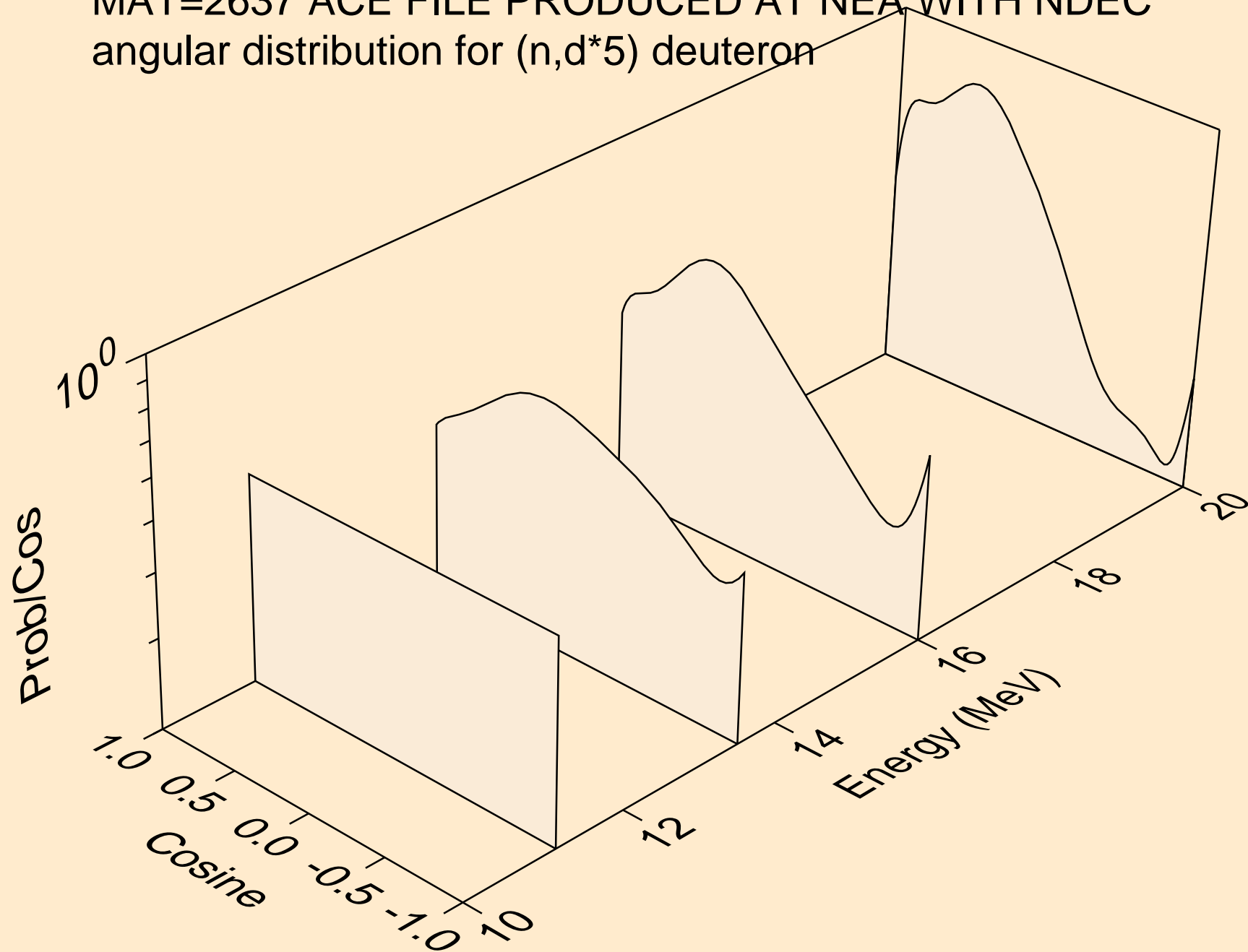

MAT=2637 ACE FILE PRODUCED AT NEA WITH NDEC  
deuterons from (n,d\*c)

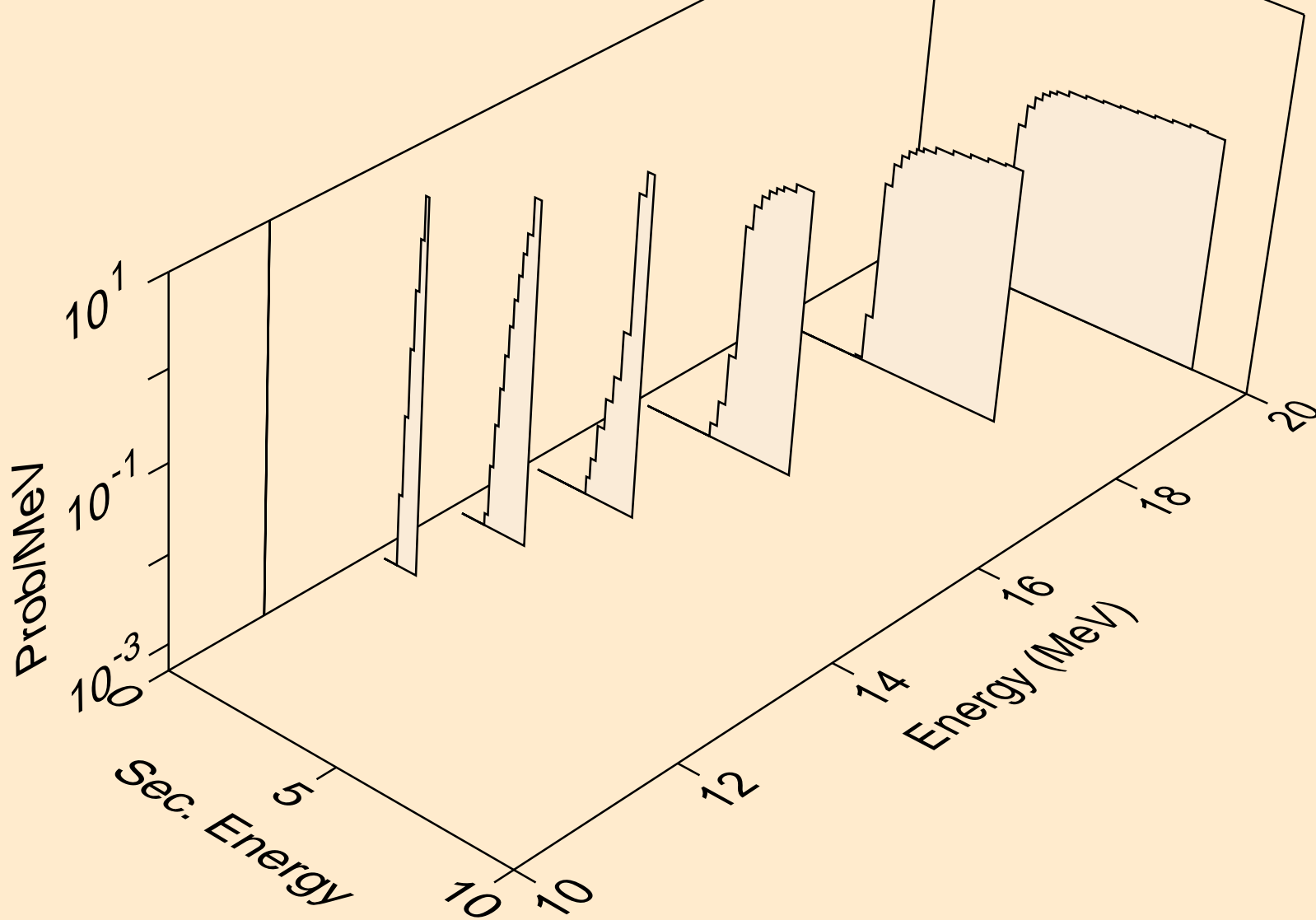

MAT=2637 ACE FILE PRODUCED AT NEA WITH NDEC  
tritons from (n,x)

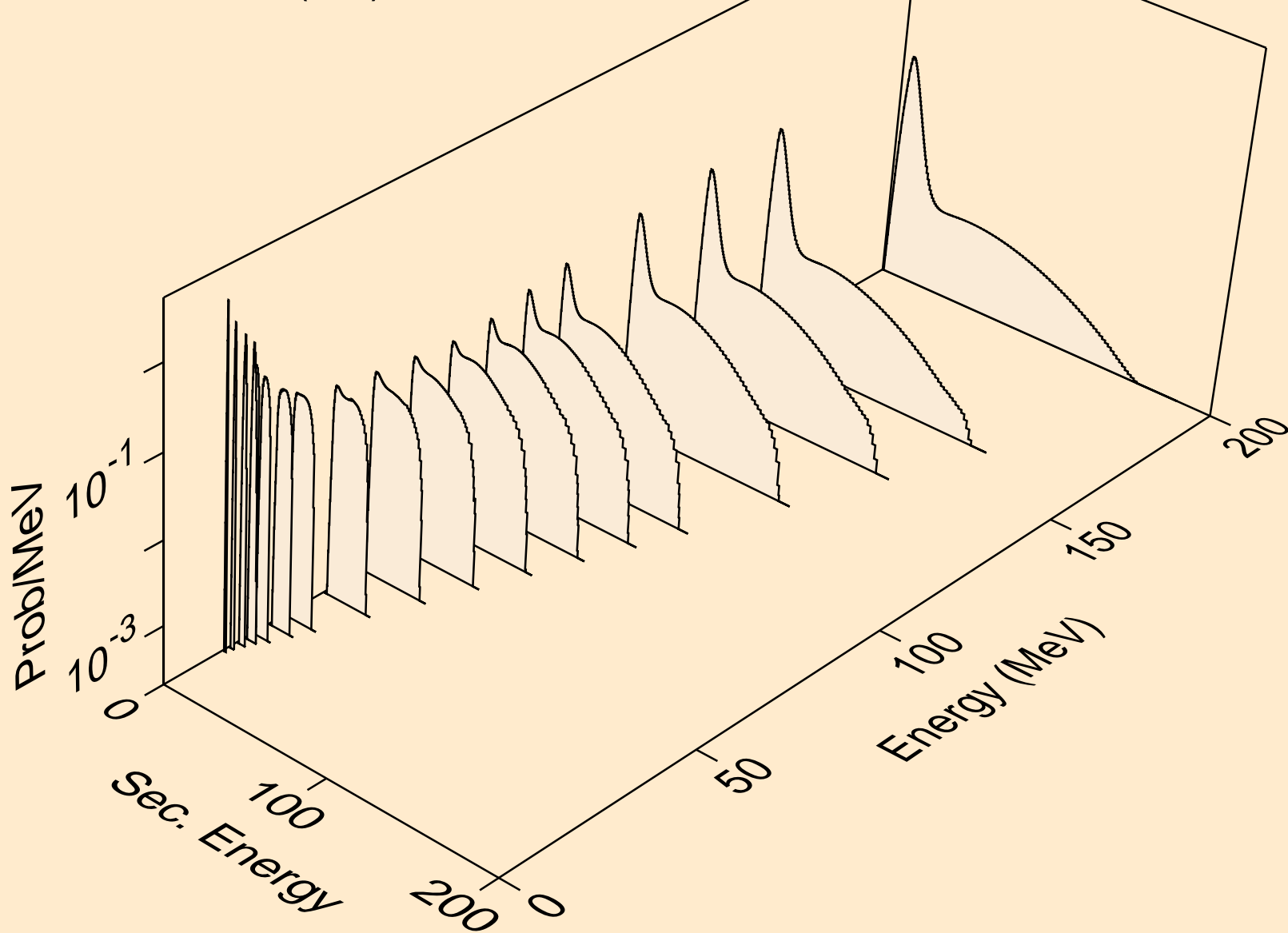

MAT=2637 ACE FILE PRODUCED AT NEA WITH NDEC  
angular distribution for (n,t\*0) triton

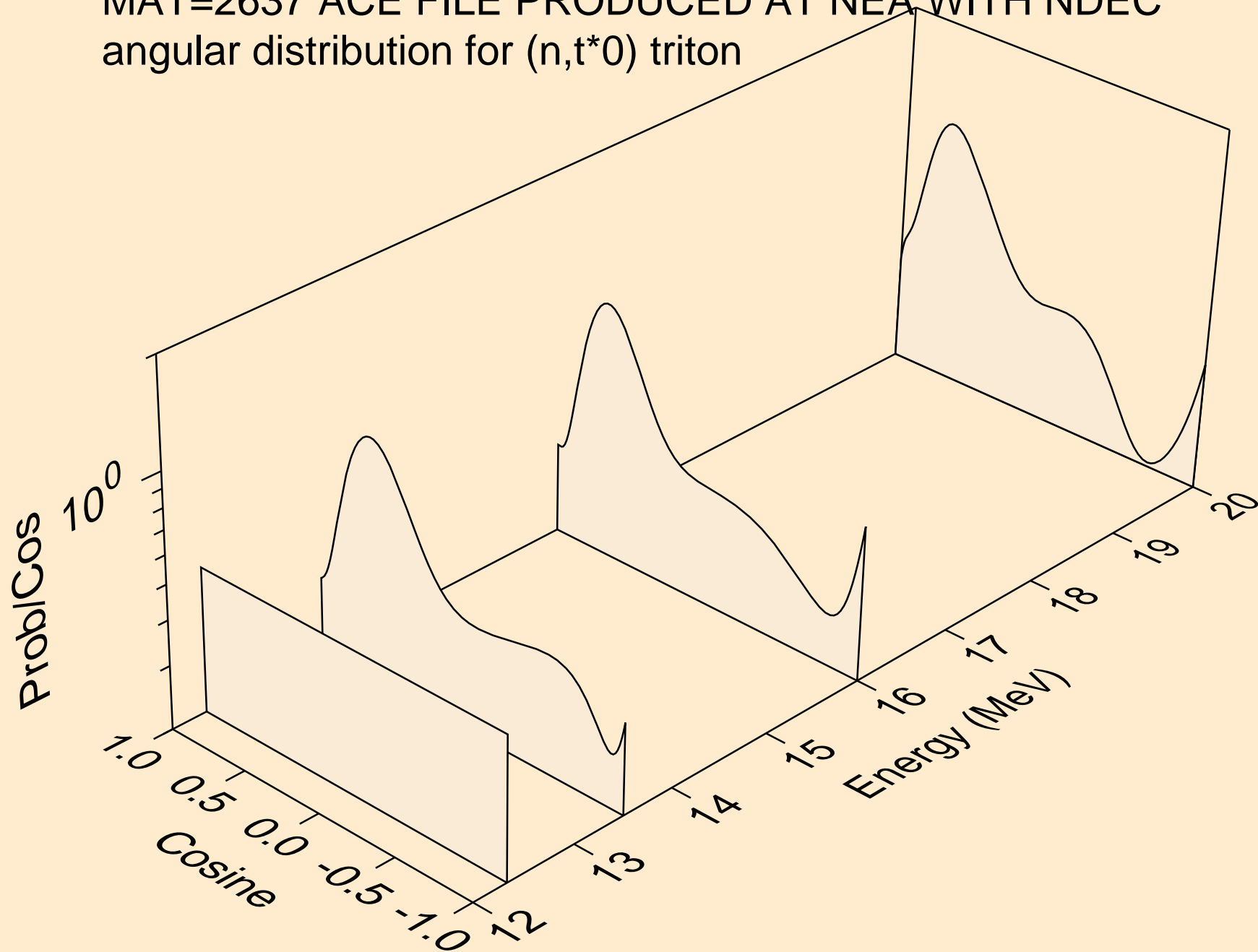

MAT=2637 ACE FILE PRODUCED AT NEA WITH NDEC  
angular distribution for (n,t\*1) triton

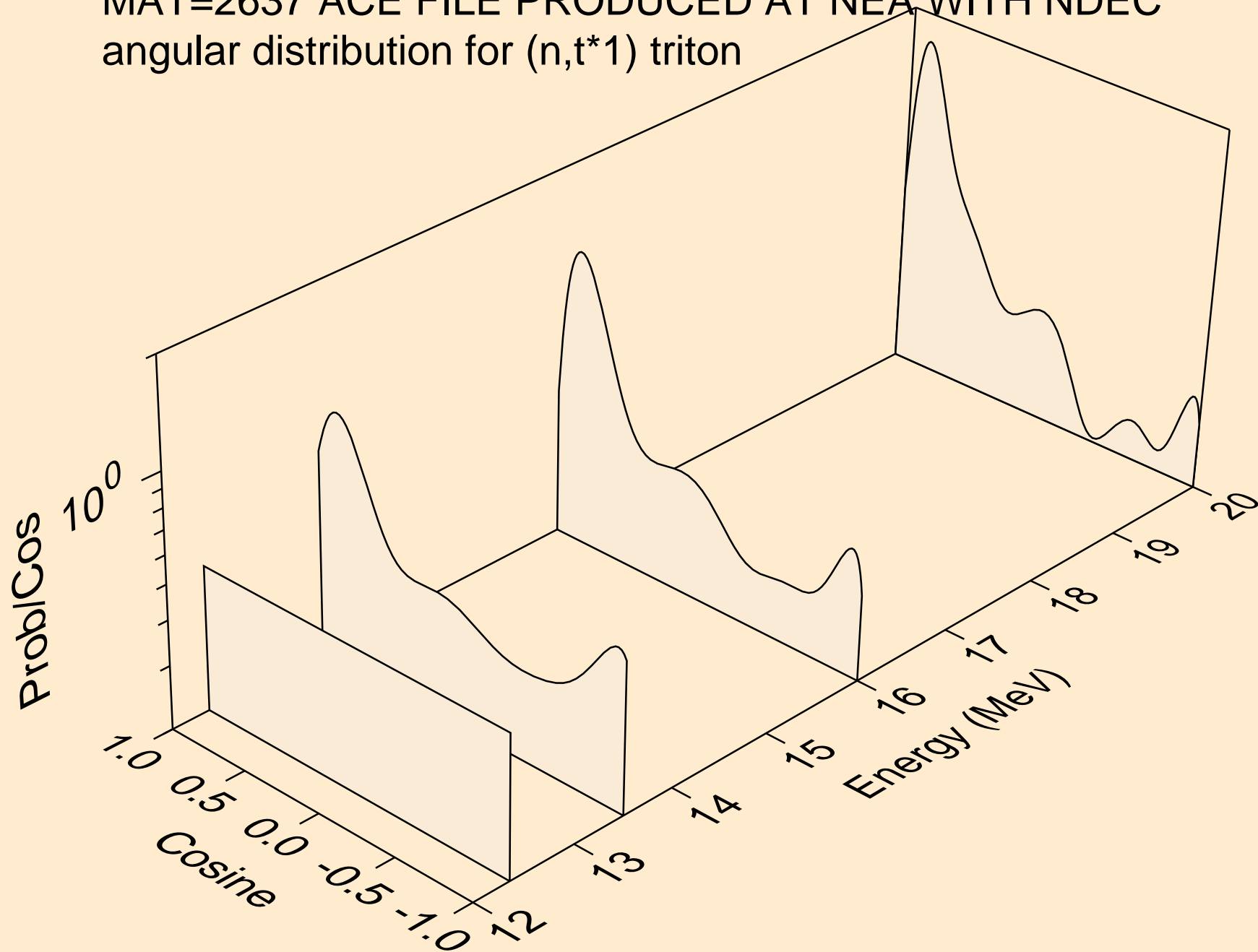

MAT=2637 ACE FILE PRODUCED AT NEA WITH NDEC  
angular distribution for (n,t\*2) triton

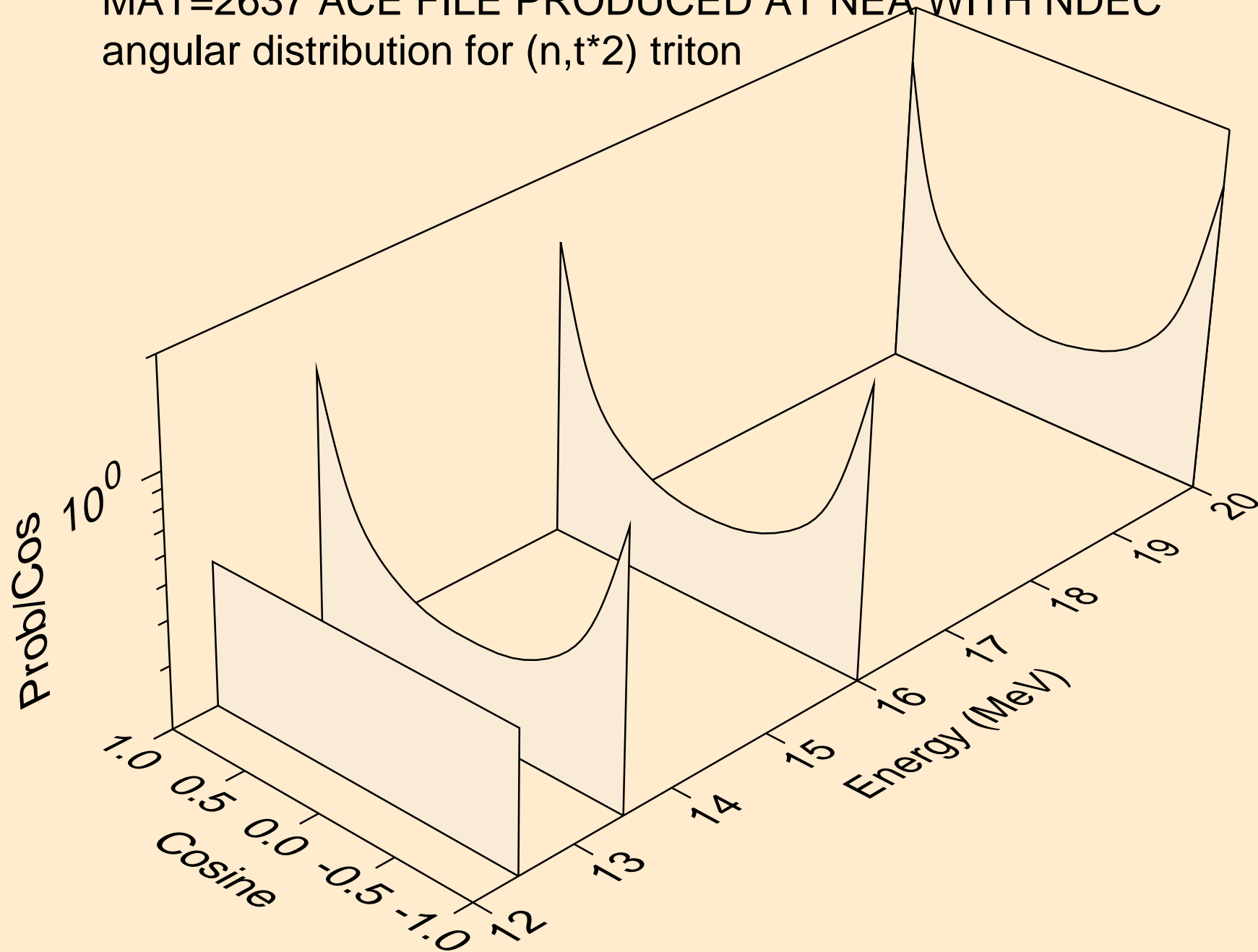



MAT=2637 ACE FILE PRODUCED AT NEA WITH NDEC  
angular distribution for (n,t\*3) triton

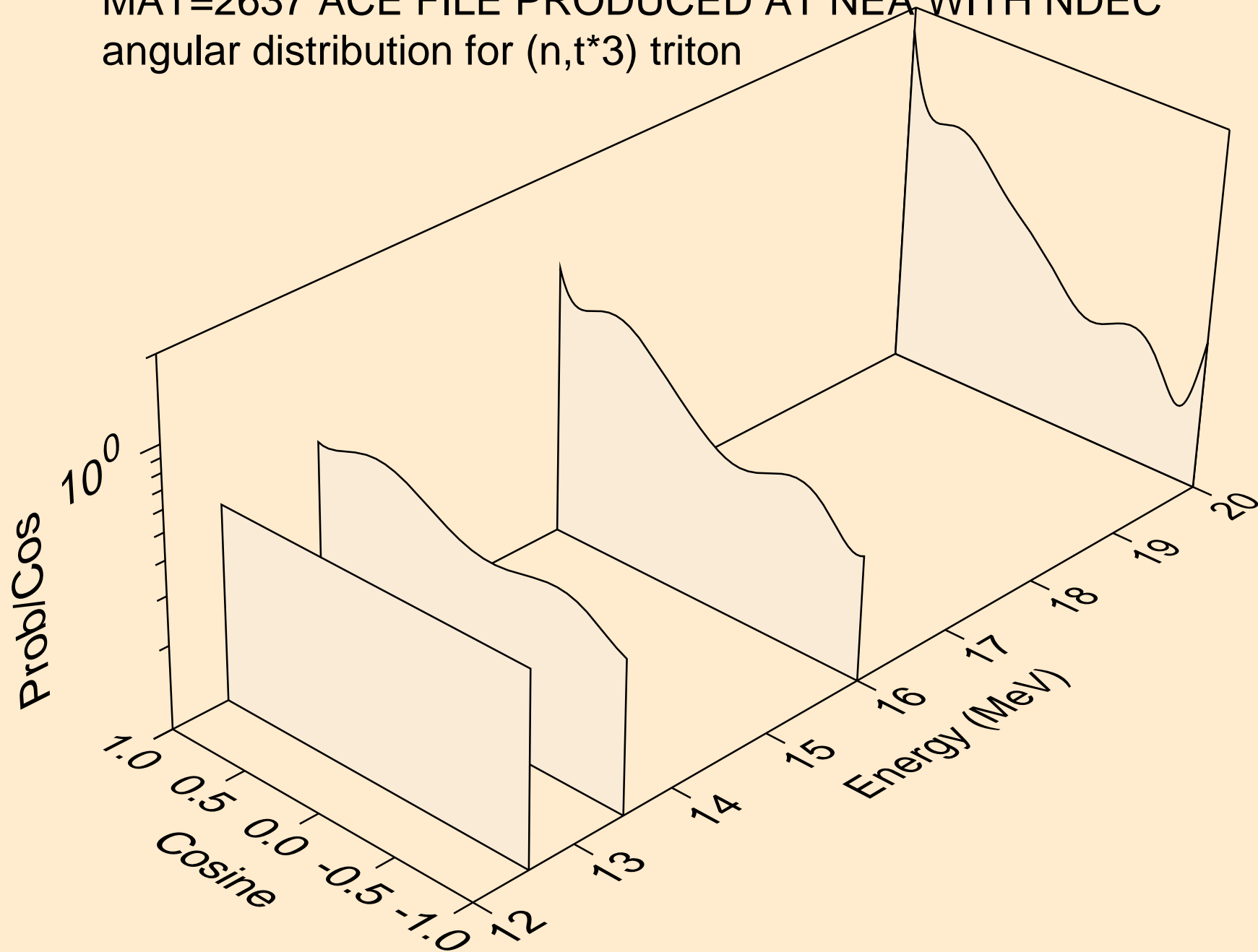

MAT=2637 ACE FILE PRODUCED AT NEA WITH NDEC  
angular distribution for (n,t\*4) triton

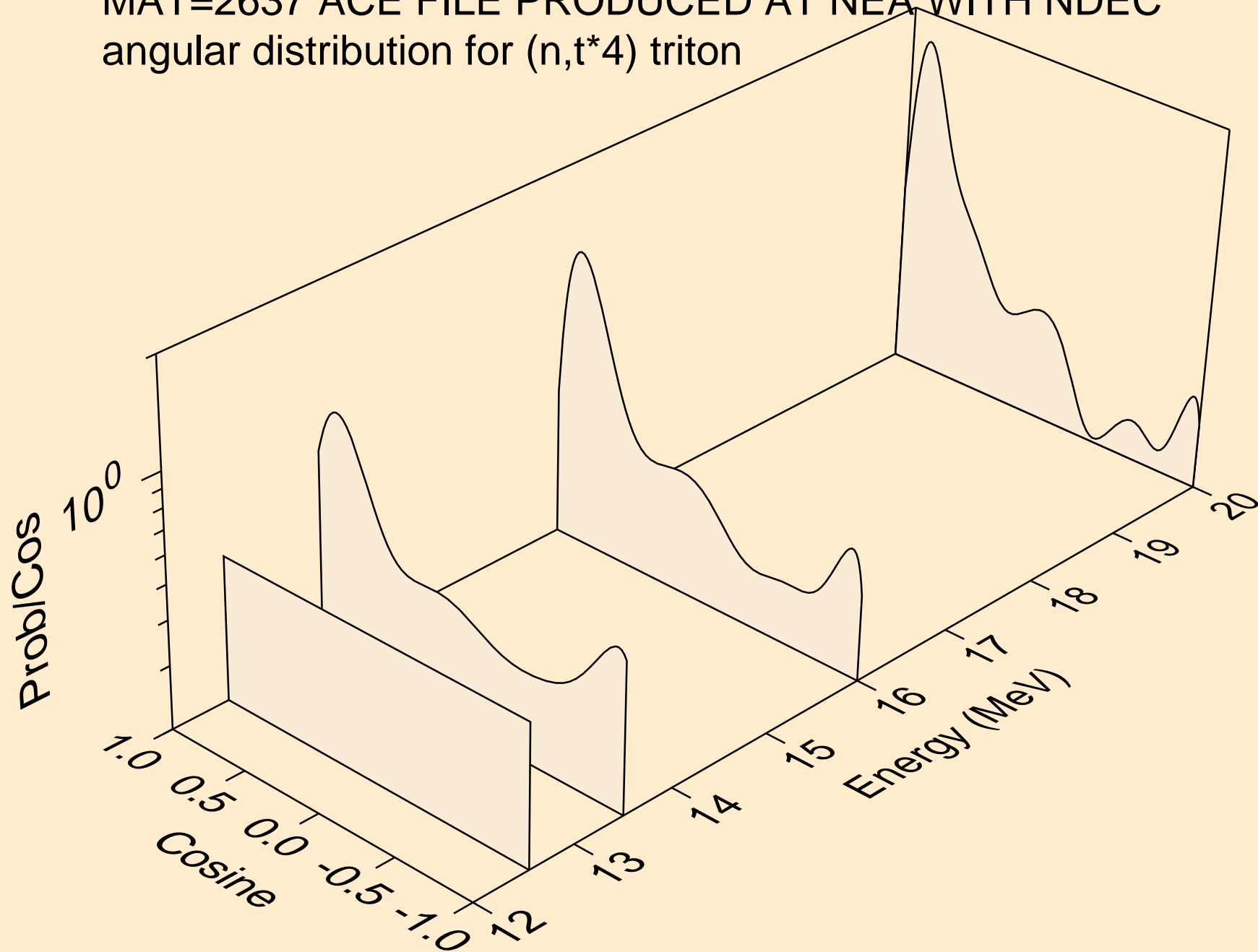

MAT=2637 ACE FILE PRODUCED AT NEA WITH NDEC  
angular distribution for (n,t\*5) triton

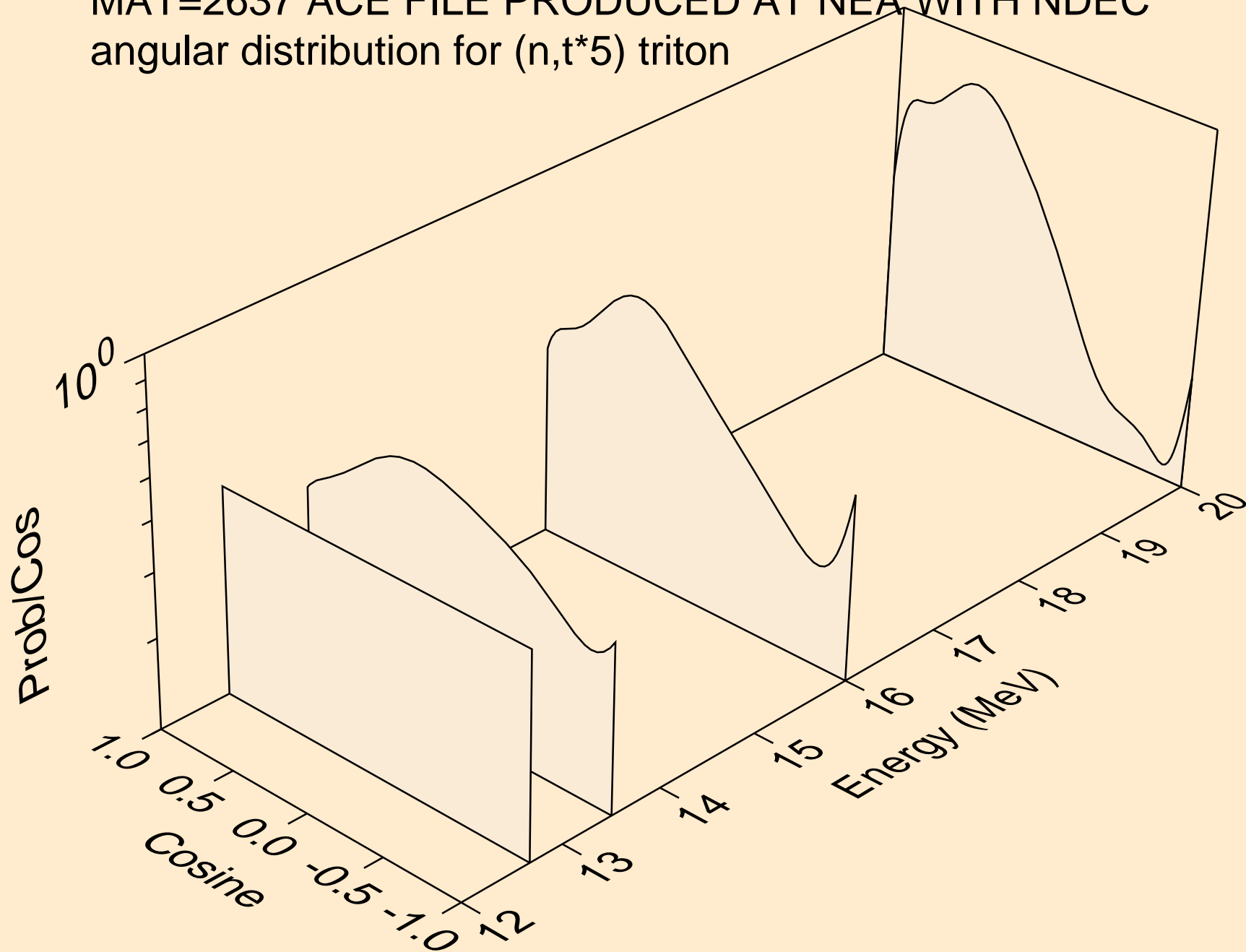

MAT=2637 ACE FILE PRODUCED AT NEA WITH NDEC  
tritons from (n,t\*c)

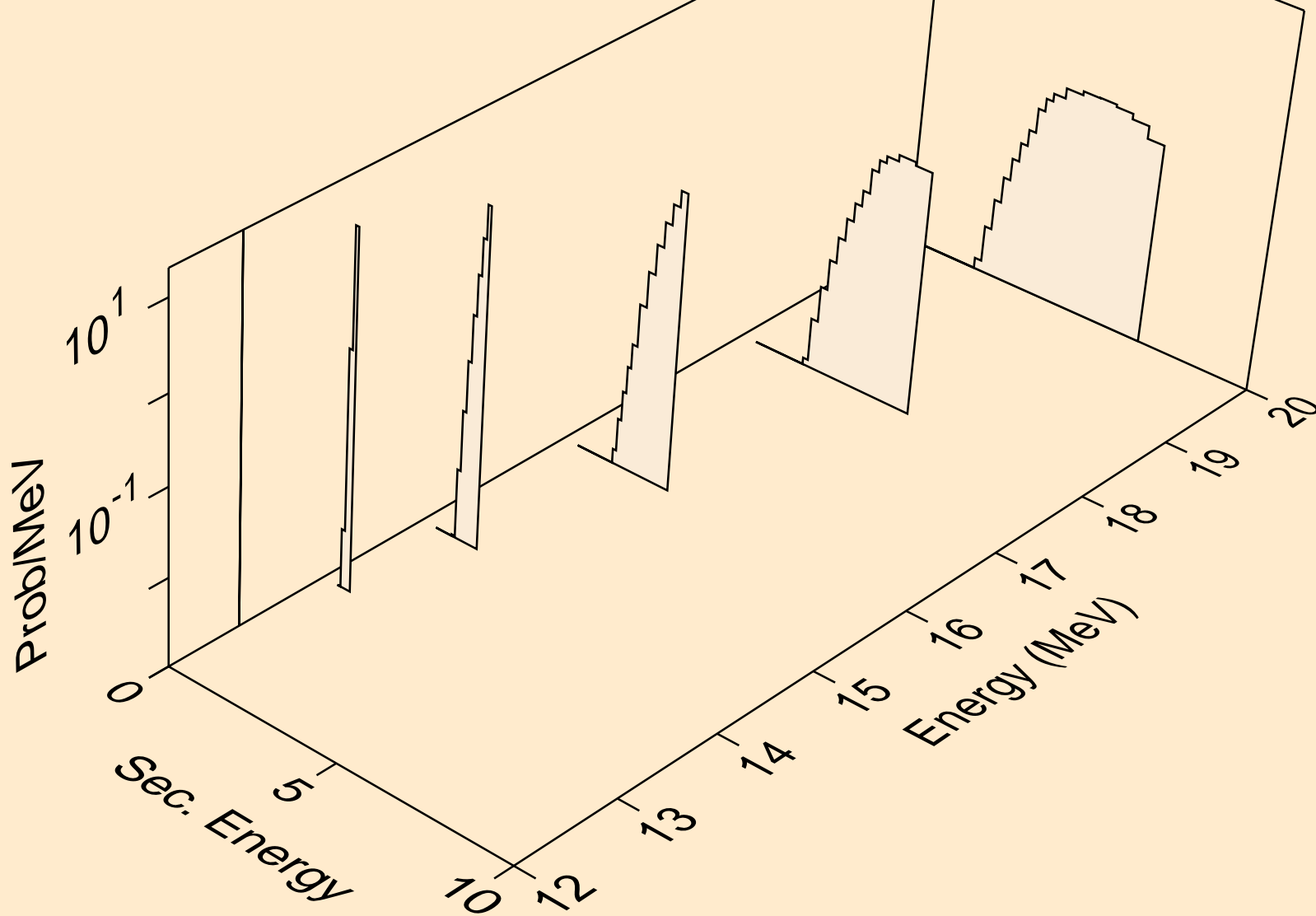

MAT=2637 ACE FILE PRODUCED AT NEA WITH NDEC  
he3s from (n,x)

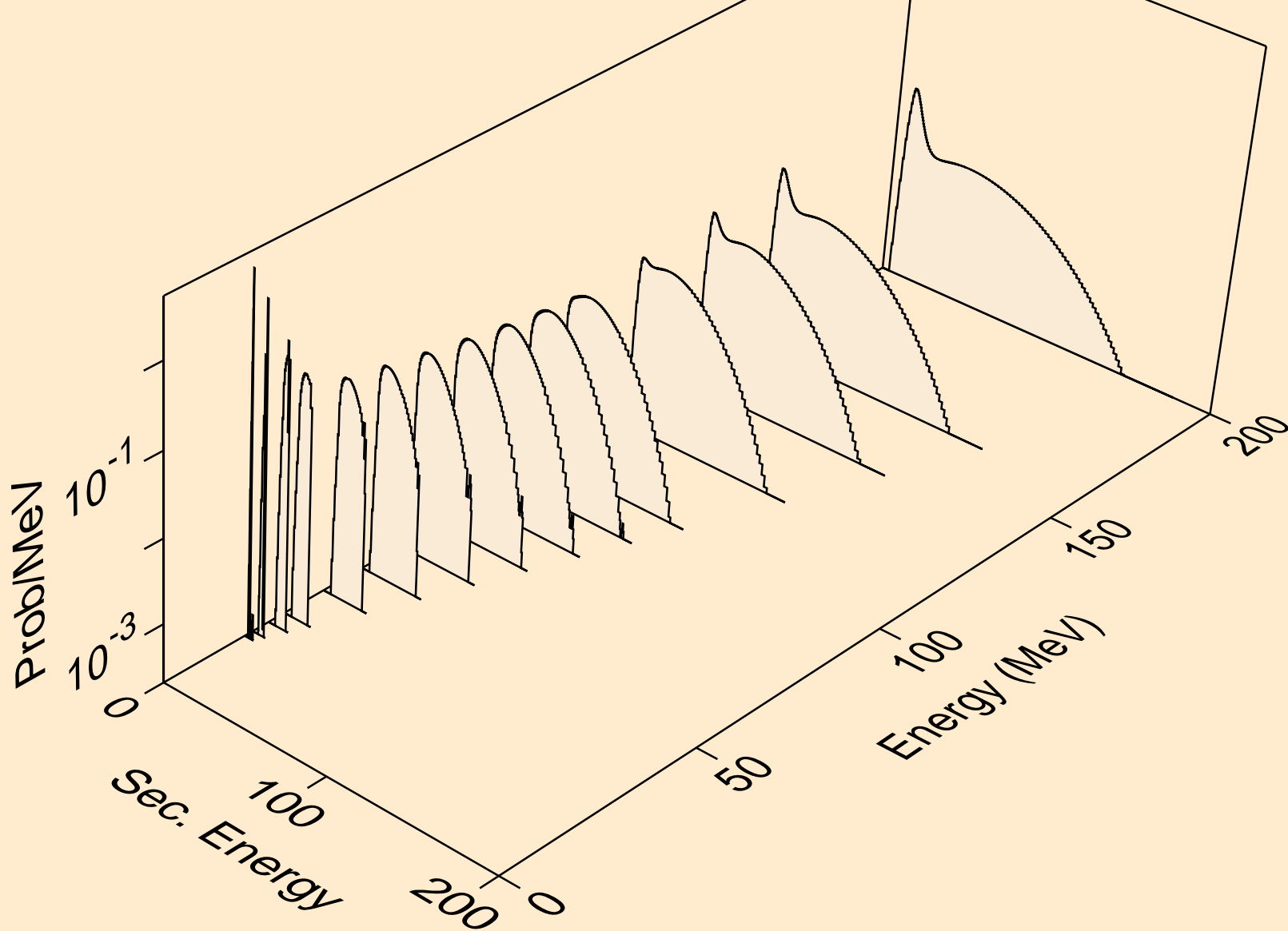

MAT=2637 ACE FILE PRODUCED AT NEA WITH NDEC  
angular distribution for (n,he3\*0) 3he

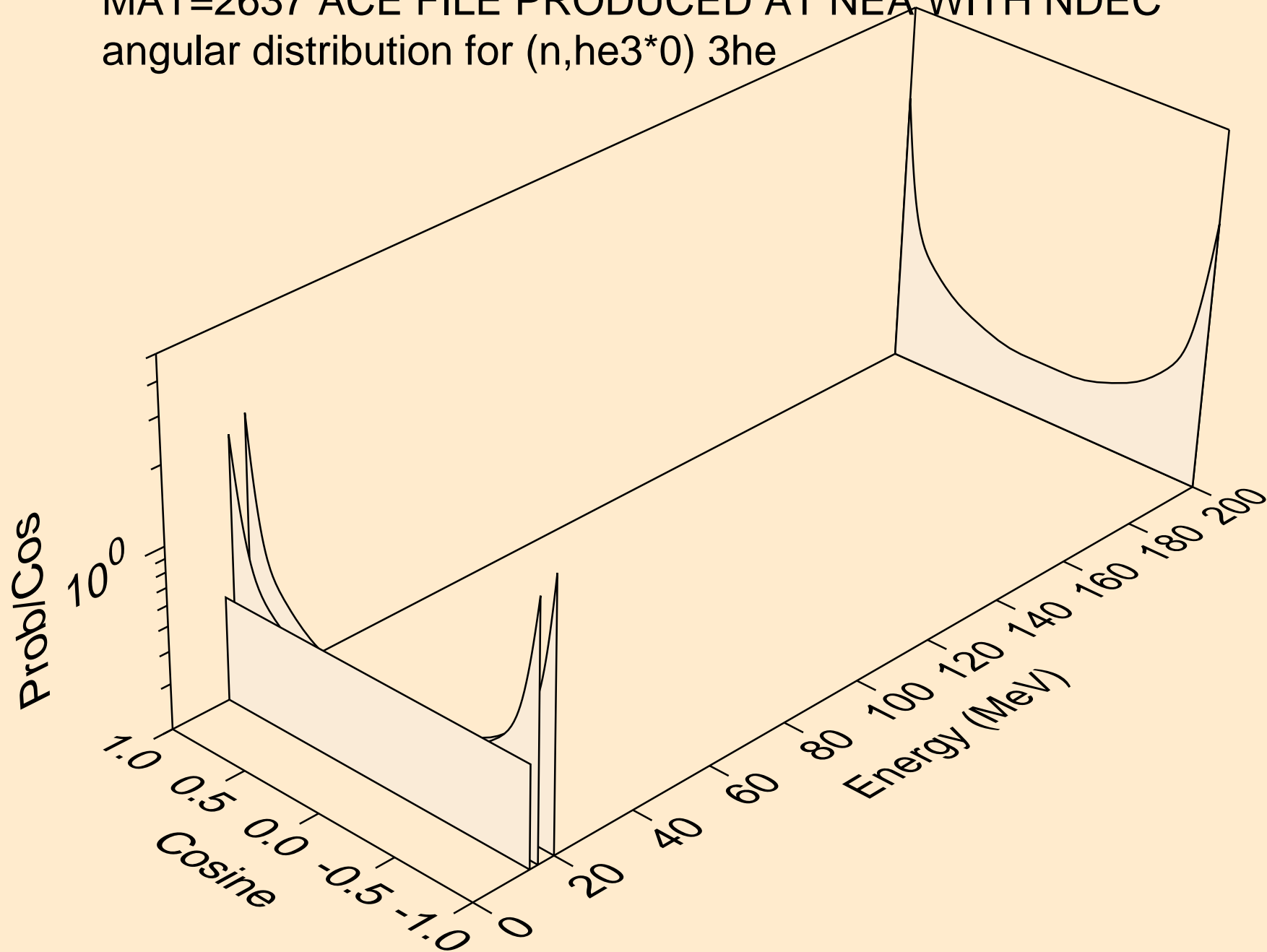

MAT=2637 ACE FILE PRODUCED AT NEA WITH NDEC  
angular distribution for (n,he3\*1) 3he

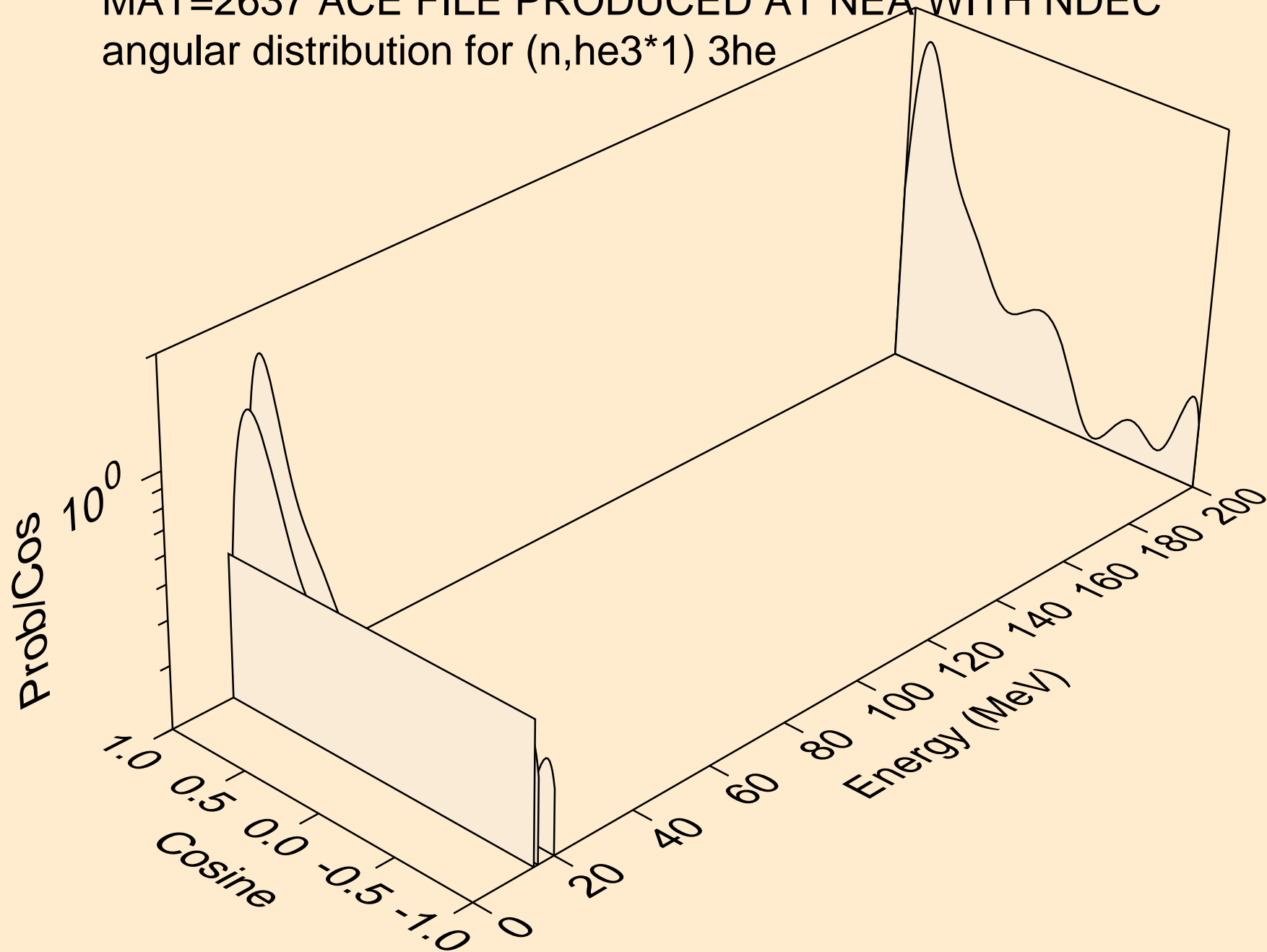

MAT=2637 ACE FILE PRODUCED AT NEA WITH NDEC  
angular distribution for (n,he3\*2) 3he

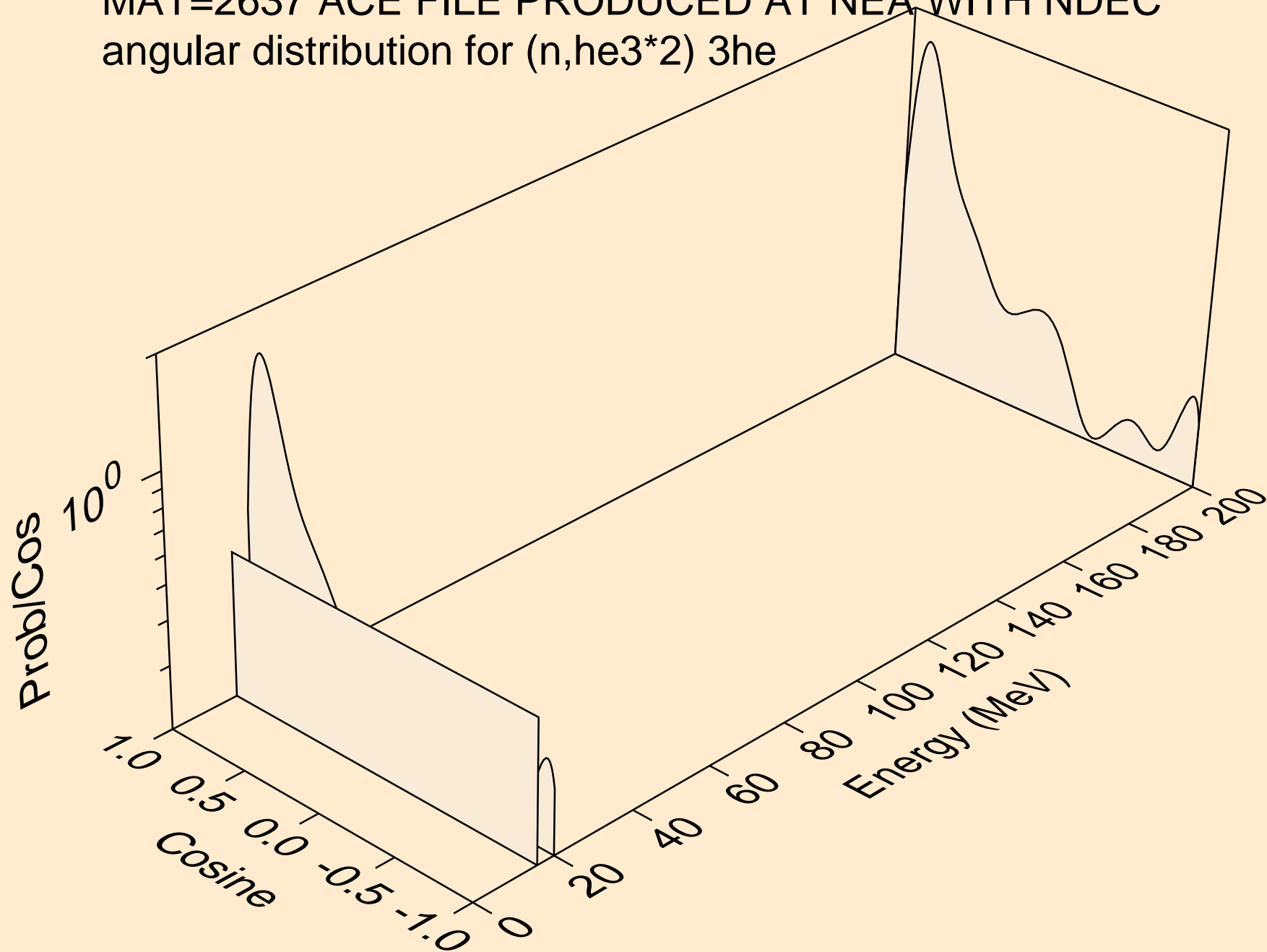



MAT=2637 ACE FILE PRODUCED AT NEA WITH NDEC  
alphas from (n,x)

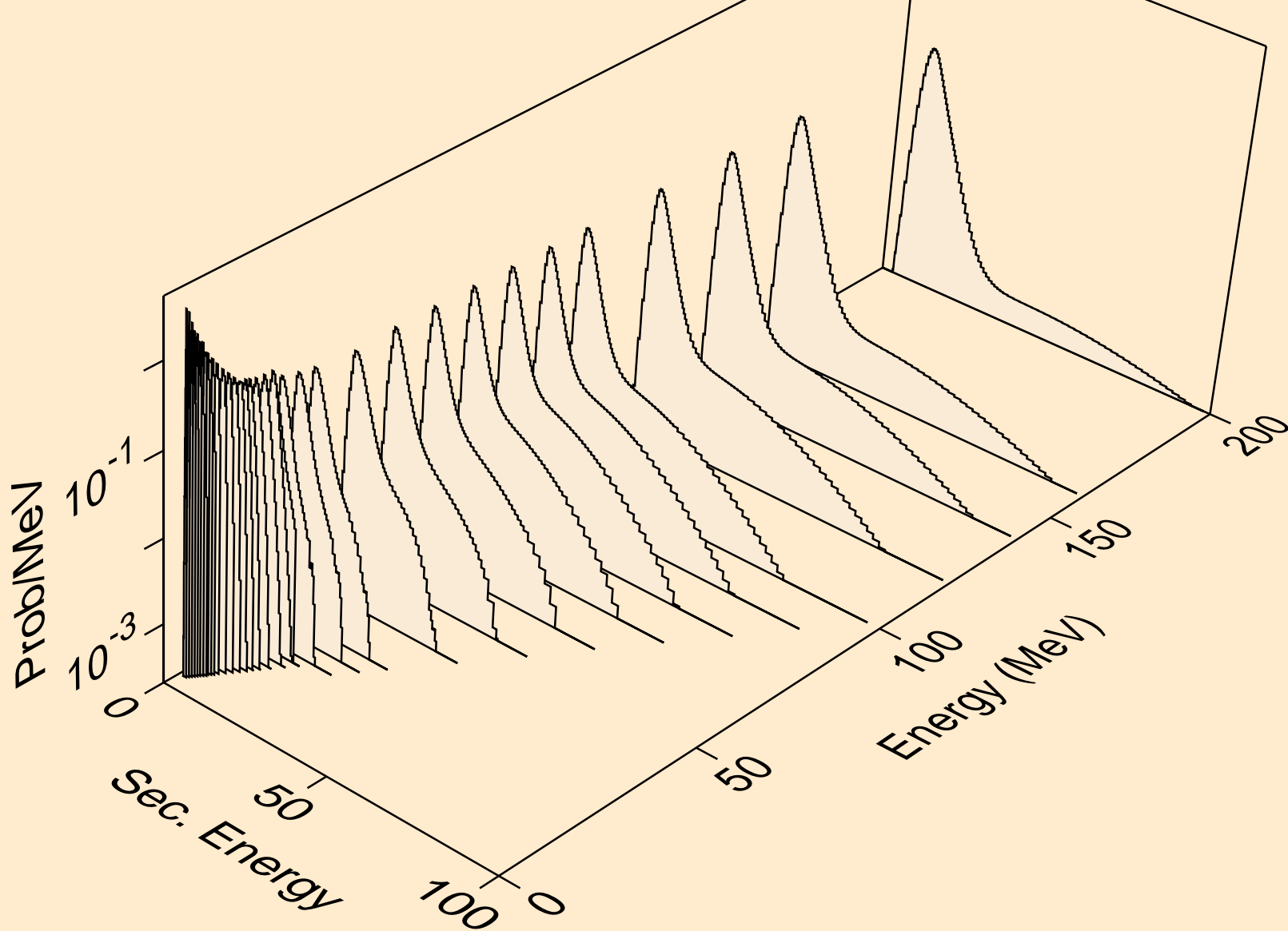

MAT=2637 ACE FILE PRODUCED AT NEA WITH NDEC  
alphas from (n,n\*)a

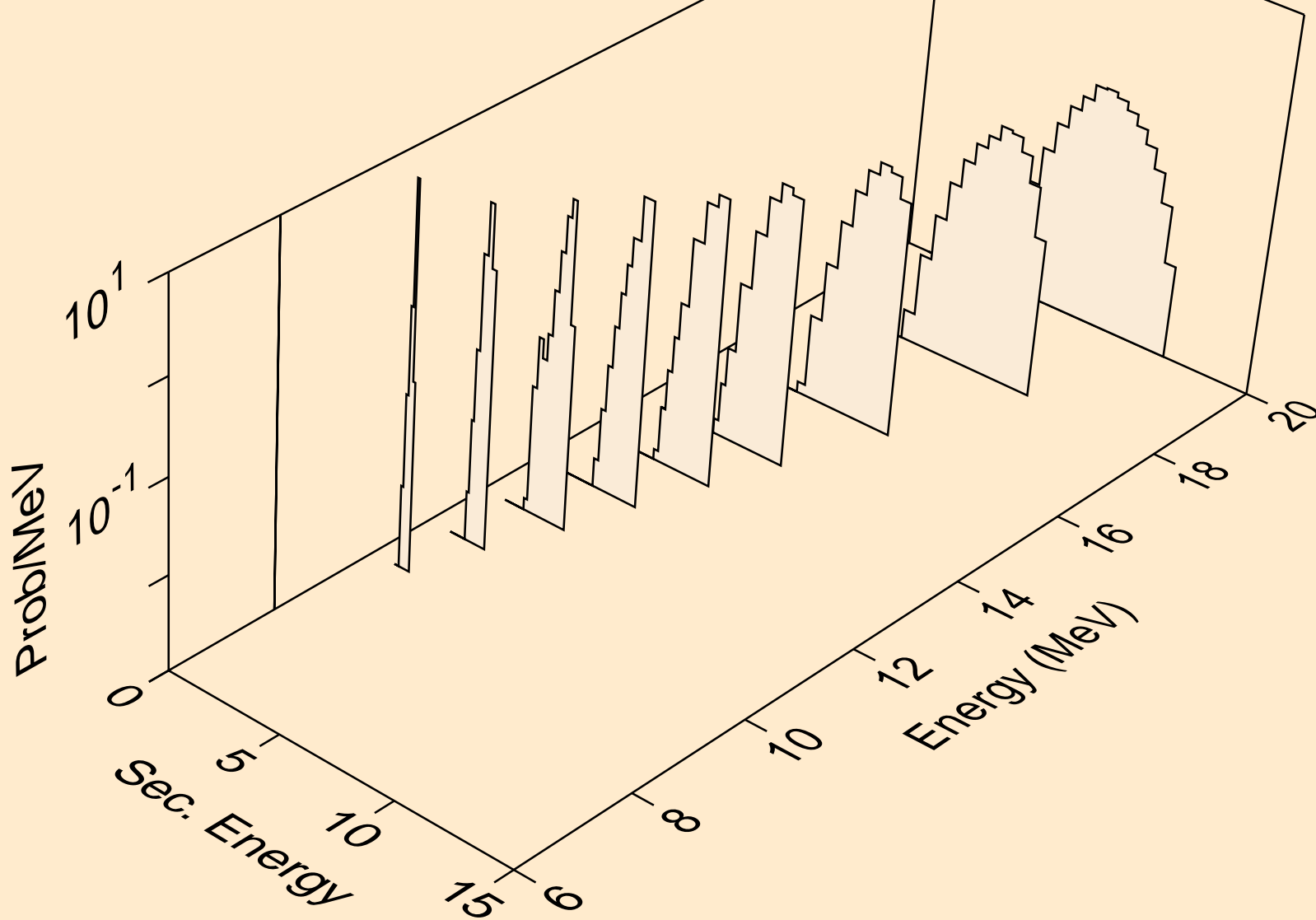

MAT=2637 ACE FILE PRODUCED AT NEA WITH NDEC  
alphas from (n,2a)

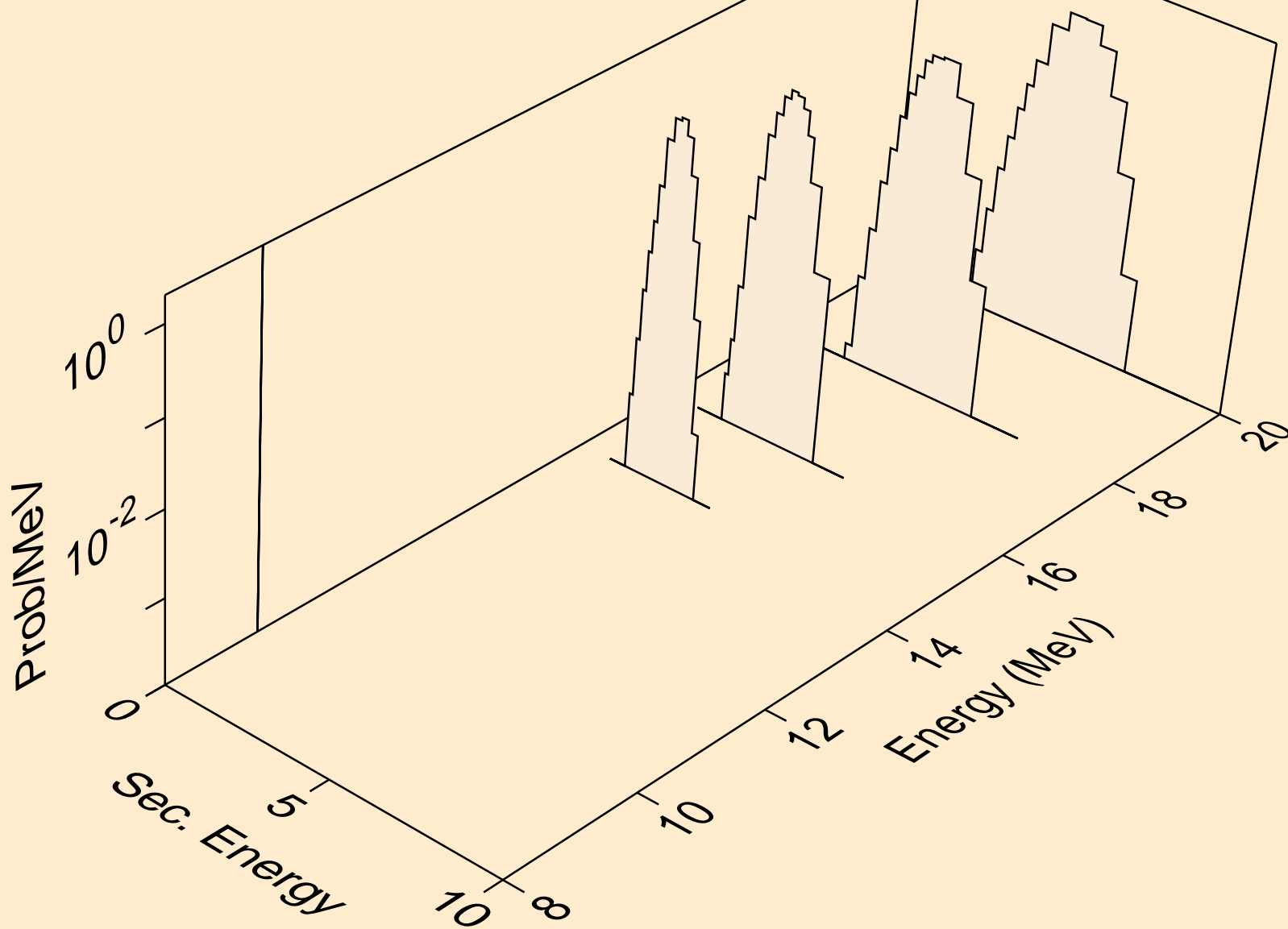

MAT=2637 ACE FILE PRODUCED AT NEA WITH NDEC  
angular distribution for (n,a\*0) alpha

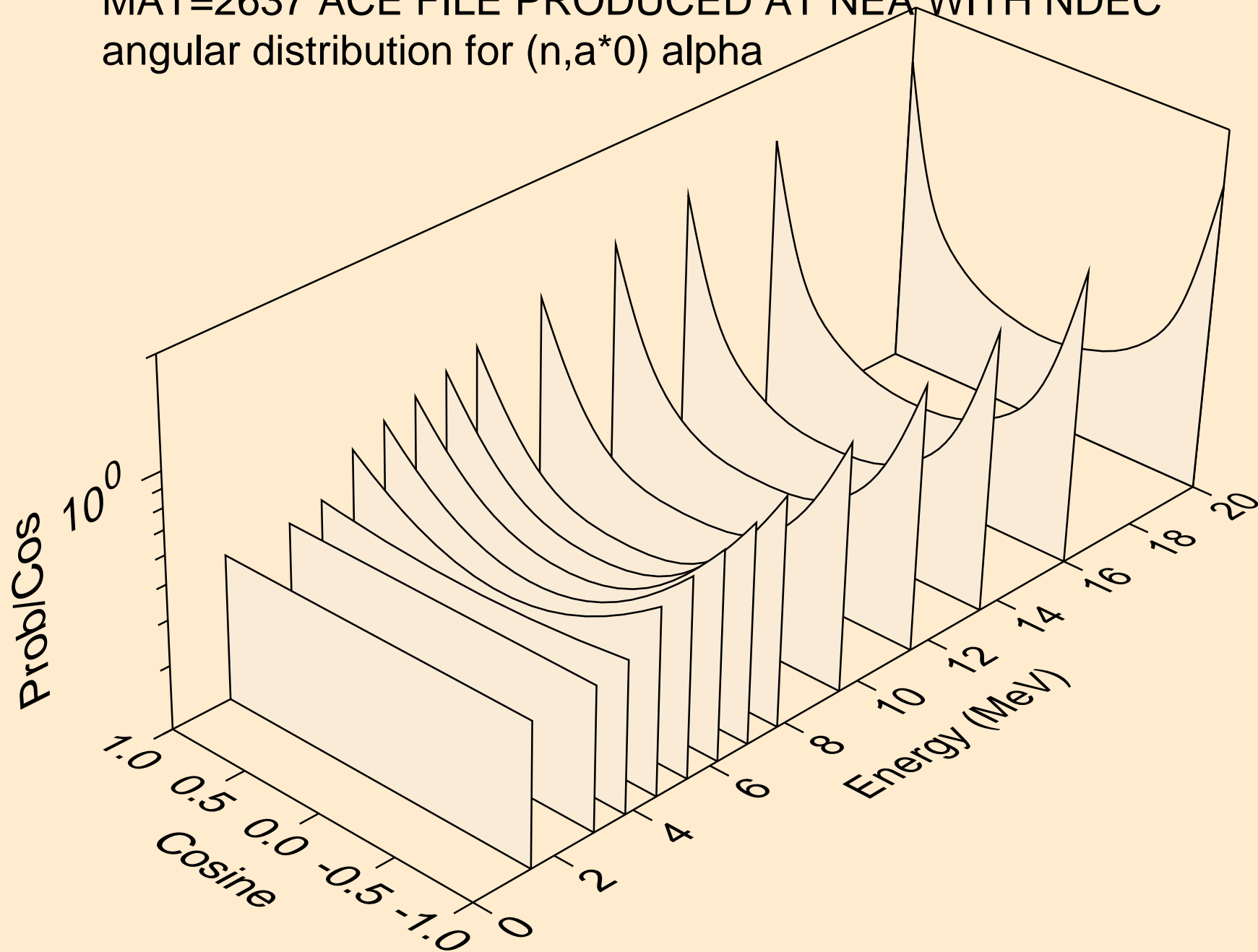

MAT=2637 ACE FILE PRODUCED AT NEA WITH NDEC  
angular distribution for (n,a\*1) alpha

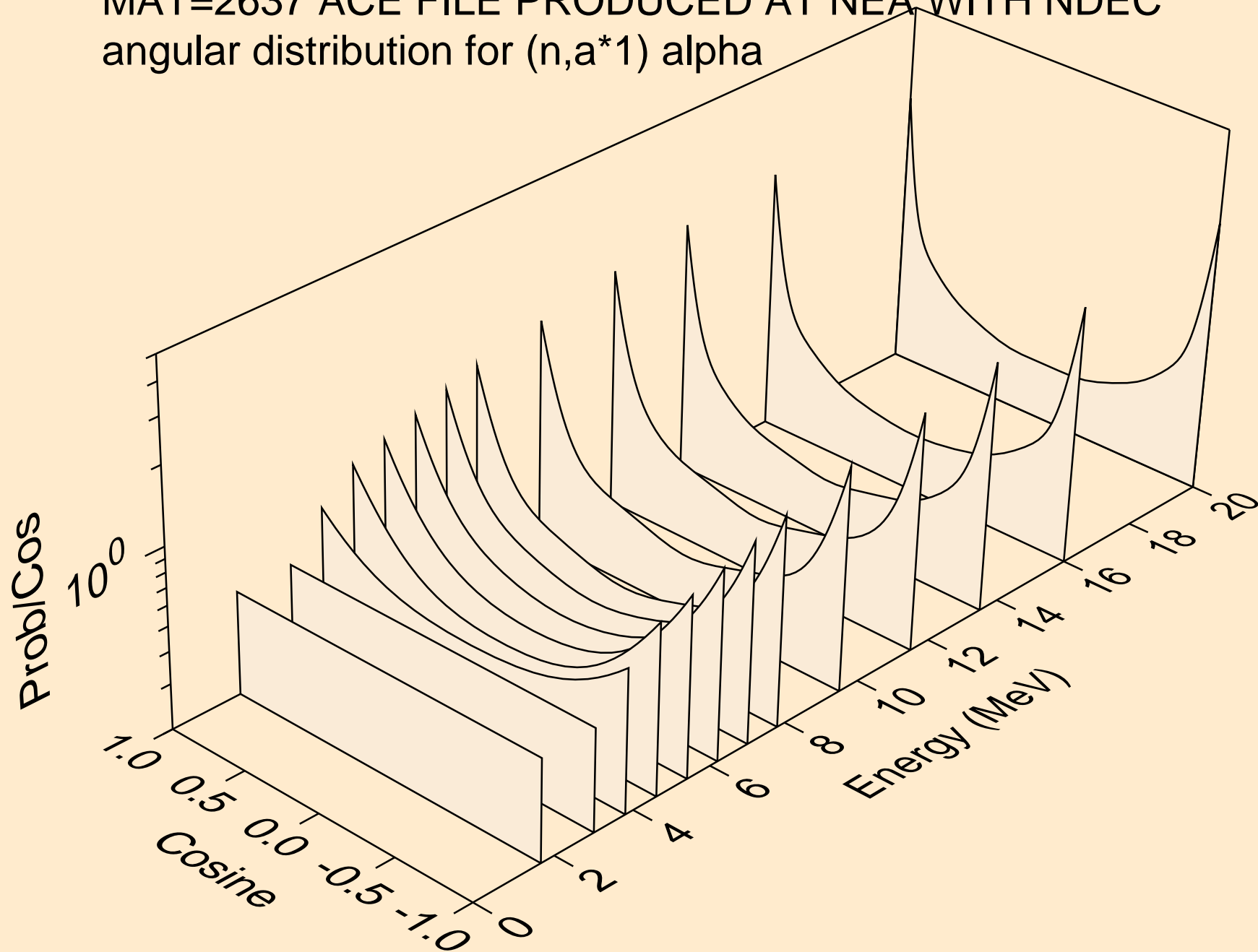

MAT=2637 ACE FILE PRODUCED AT NEA WITH NDEC  
angular distribution for (n,a\*2) alpha

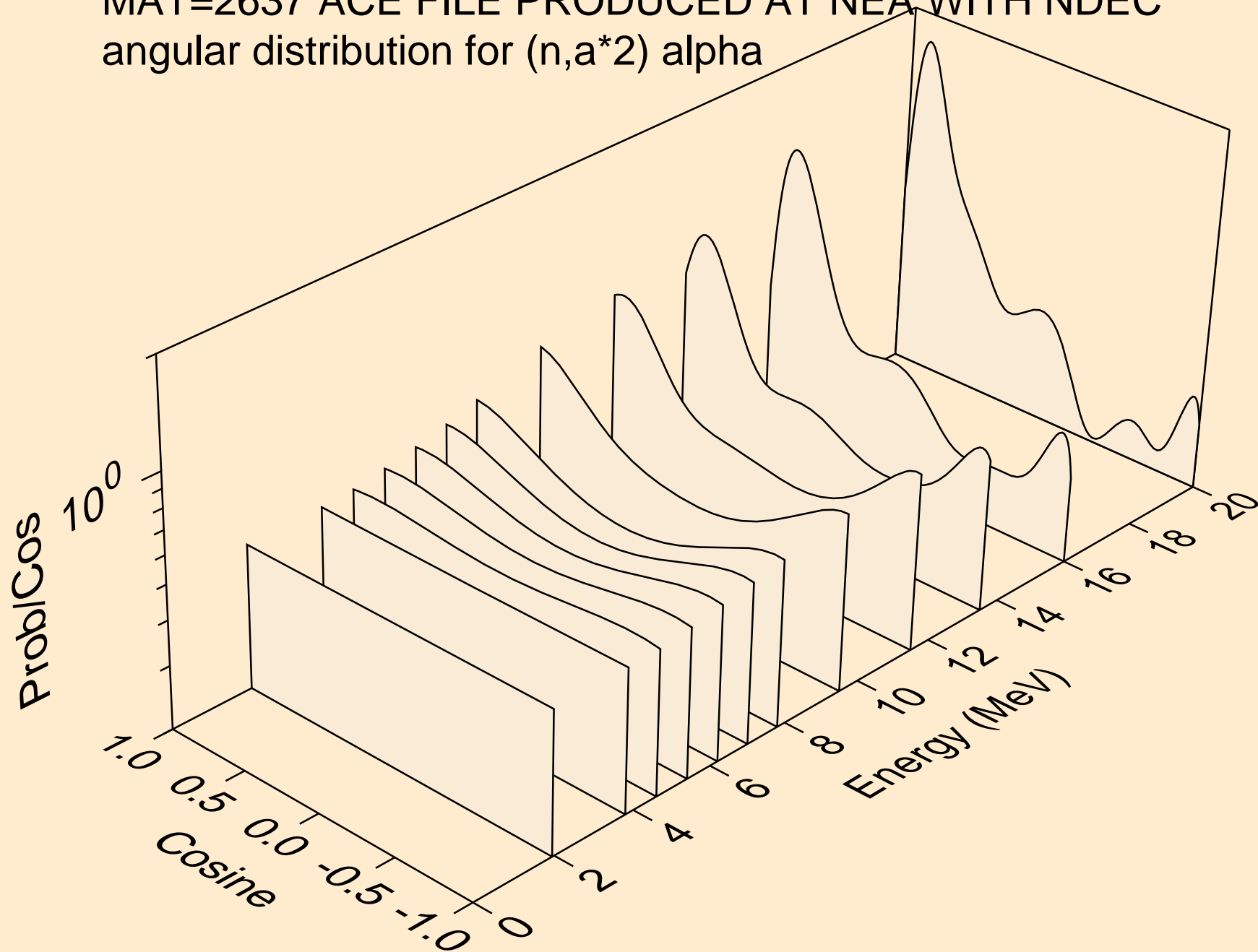

MAT=2637 ACE FILE PRODUCED AT NEA WITH NDEC  
angular distribution for (n,a\*3) alpha

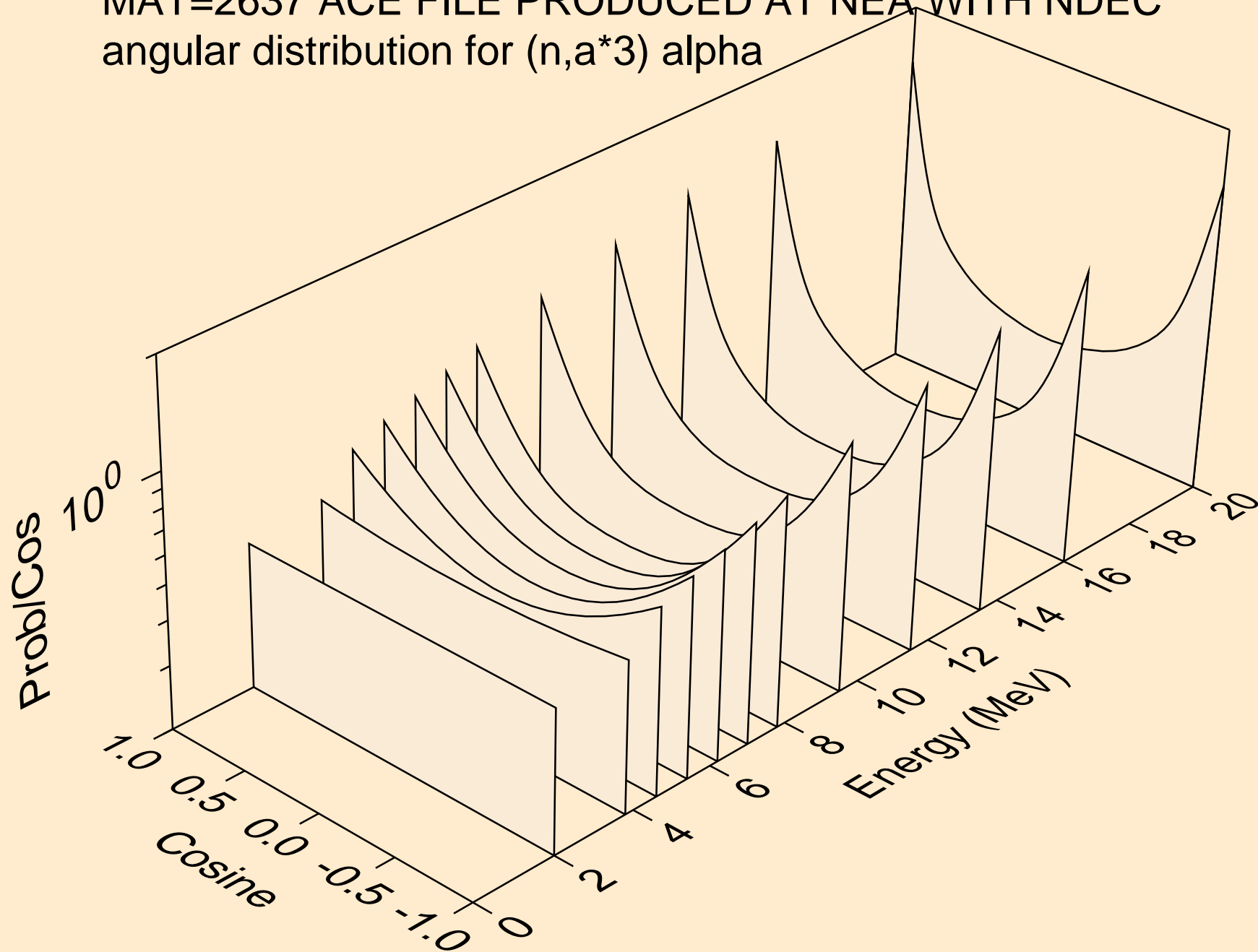

MAT=2637 ACE FILE PRODUCED AT NEA WITH NDEC  
angular distribution for (n,a\*4) alpha

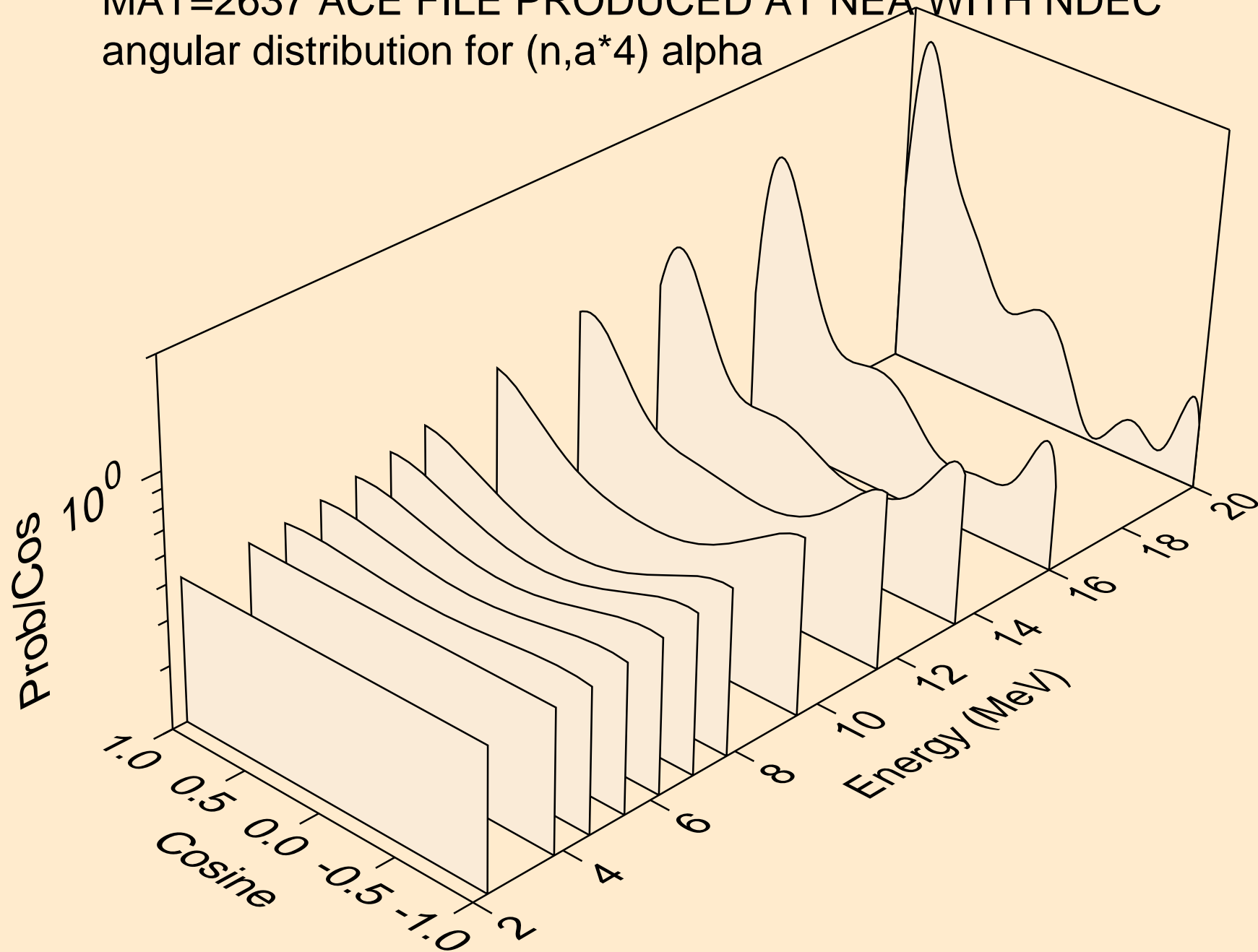



MAT=2637 ACE FILE PRODUCED AT NEA WITH NDEC  
angular distribution for (n,a\*5) alpha

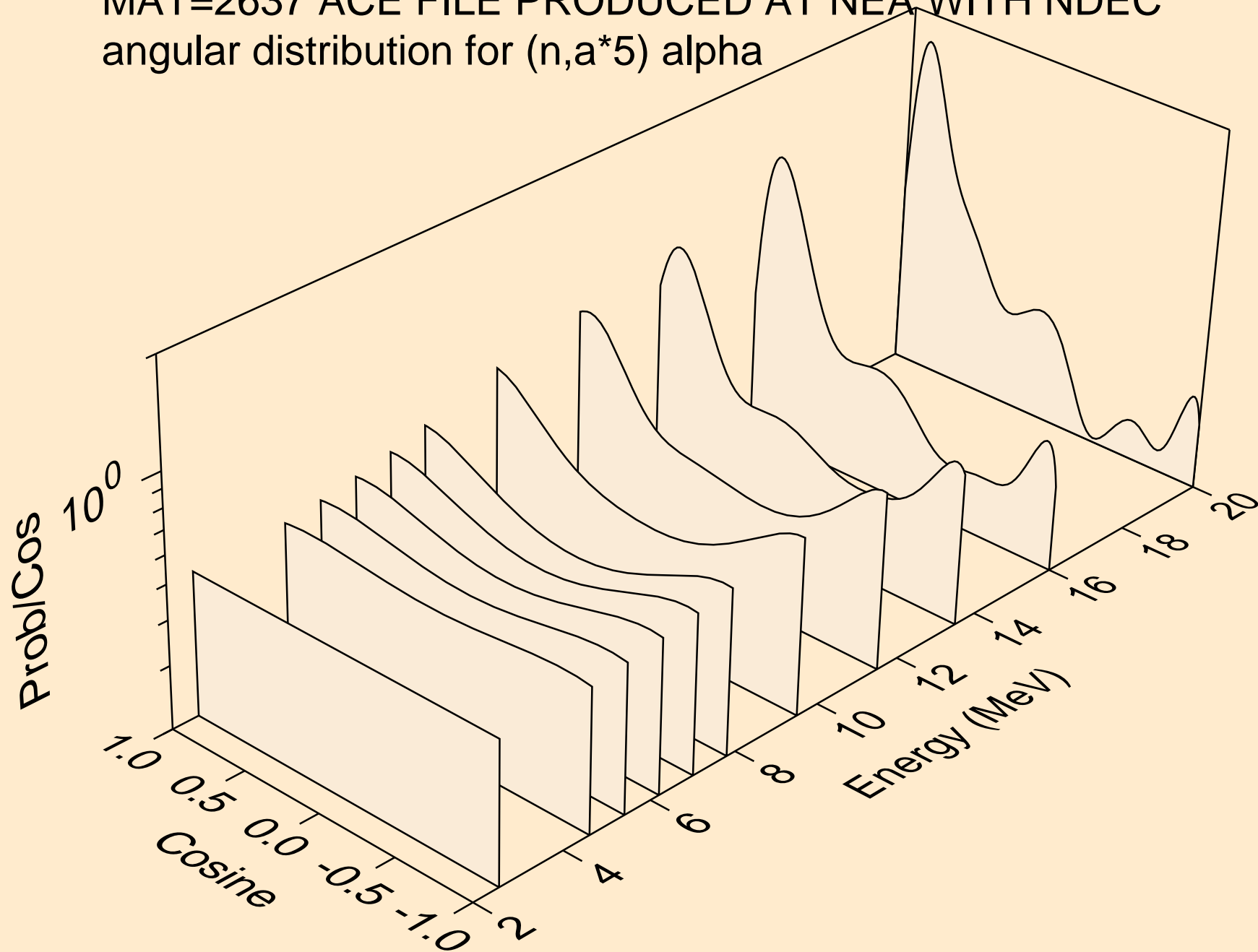

MAT=2637 ACE FILE PRODUCED AT NEA WITH NDEC  
angular distribution for (n,a\*6) alpha

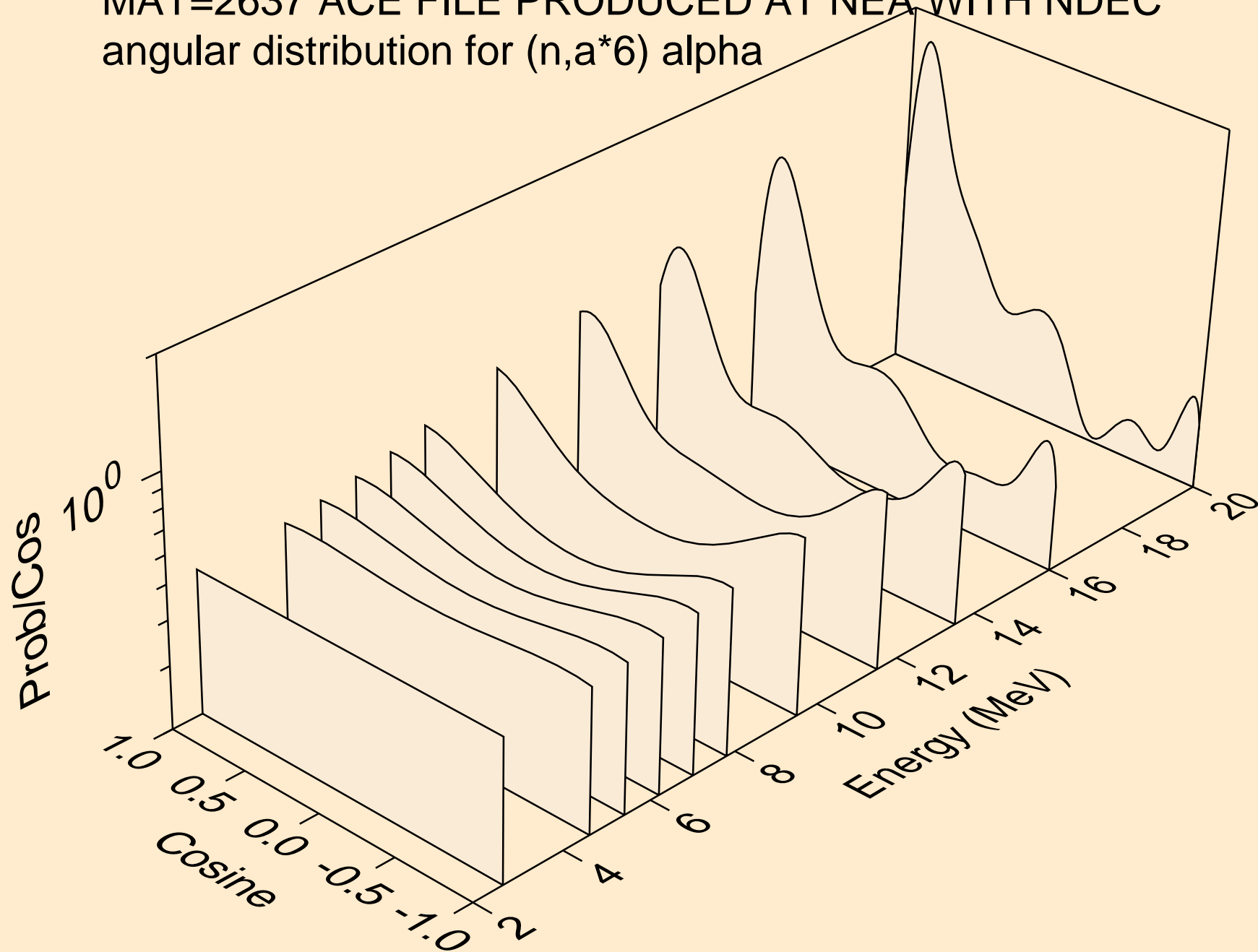

MAT=2637 ACE FILE PRODUCED AT NEA WITH NDEC  
angular distribution for (n,a\*7) alpha

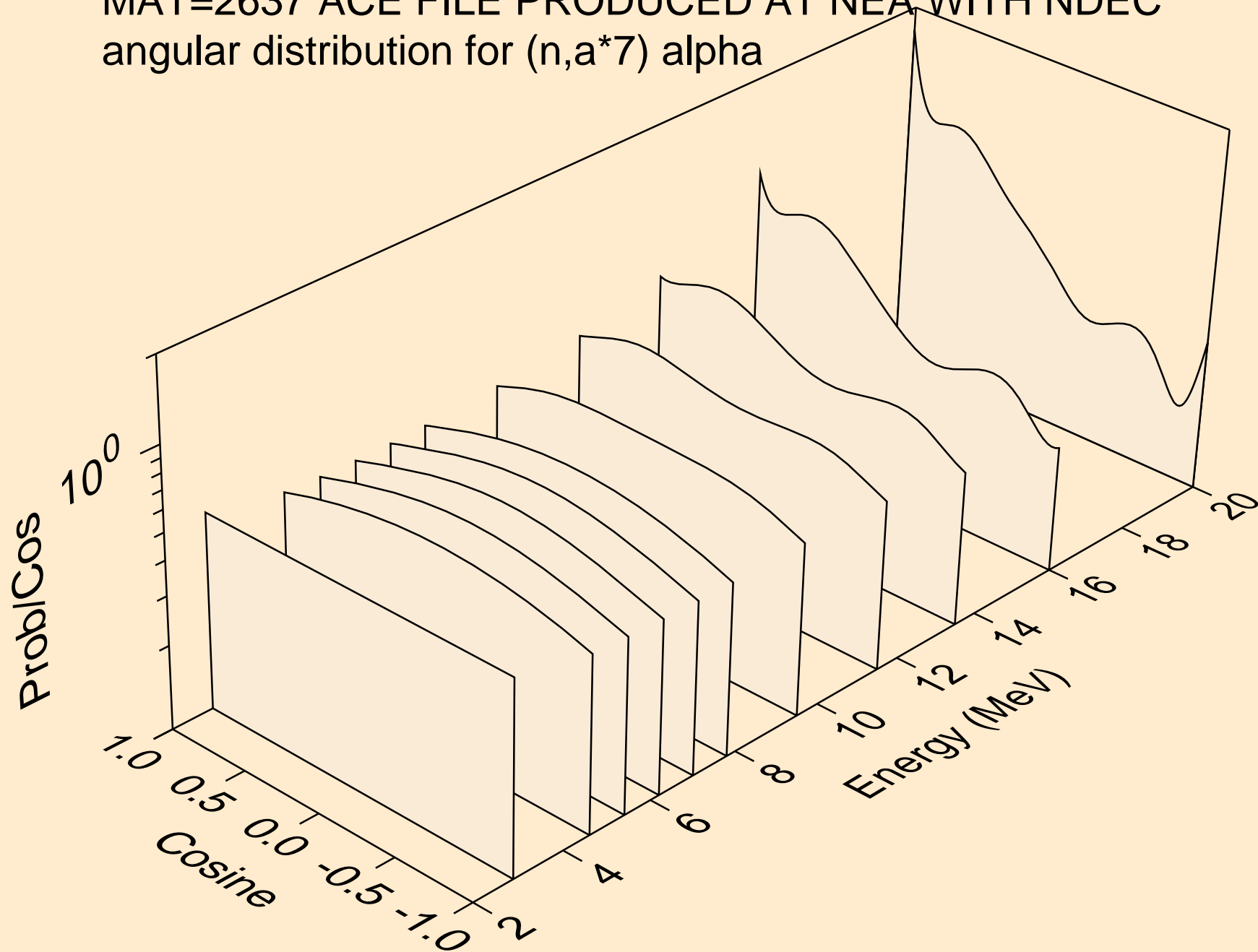

MAT=2637 ACE FILE PRODUCED AT NEA WITH NDEC  
angular distribution for (n,a\*8) alpha

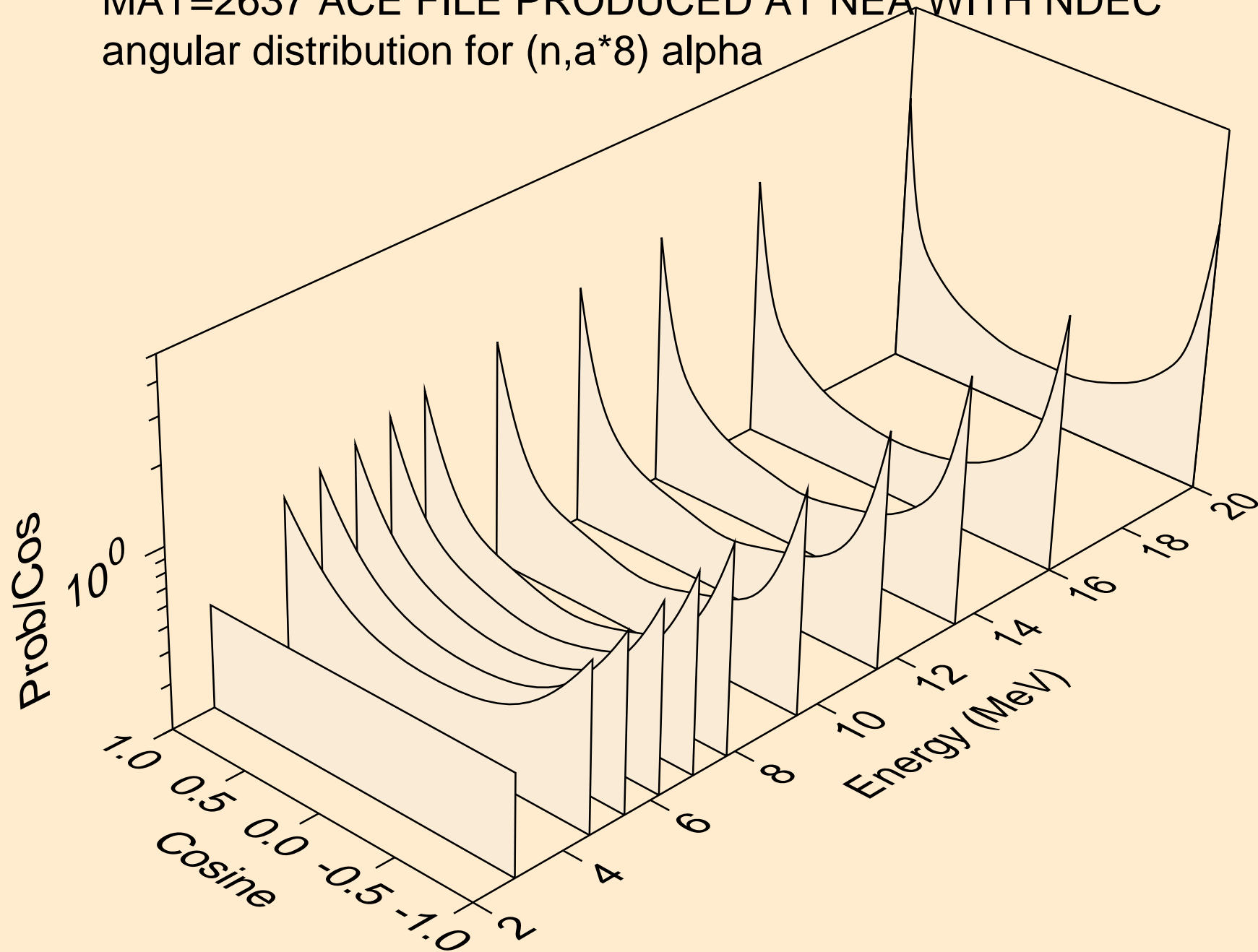

MAT=2637 ACE FILE PRODUCED AT NEA WITH NDEC  
angular distribution for (n,a\*9) alpha

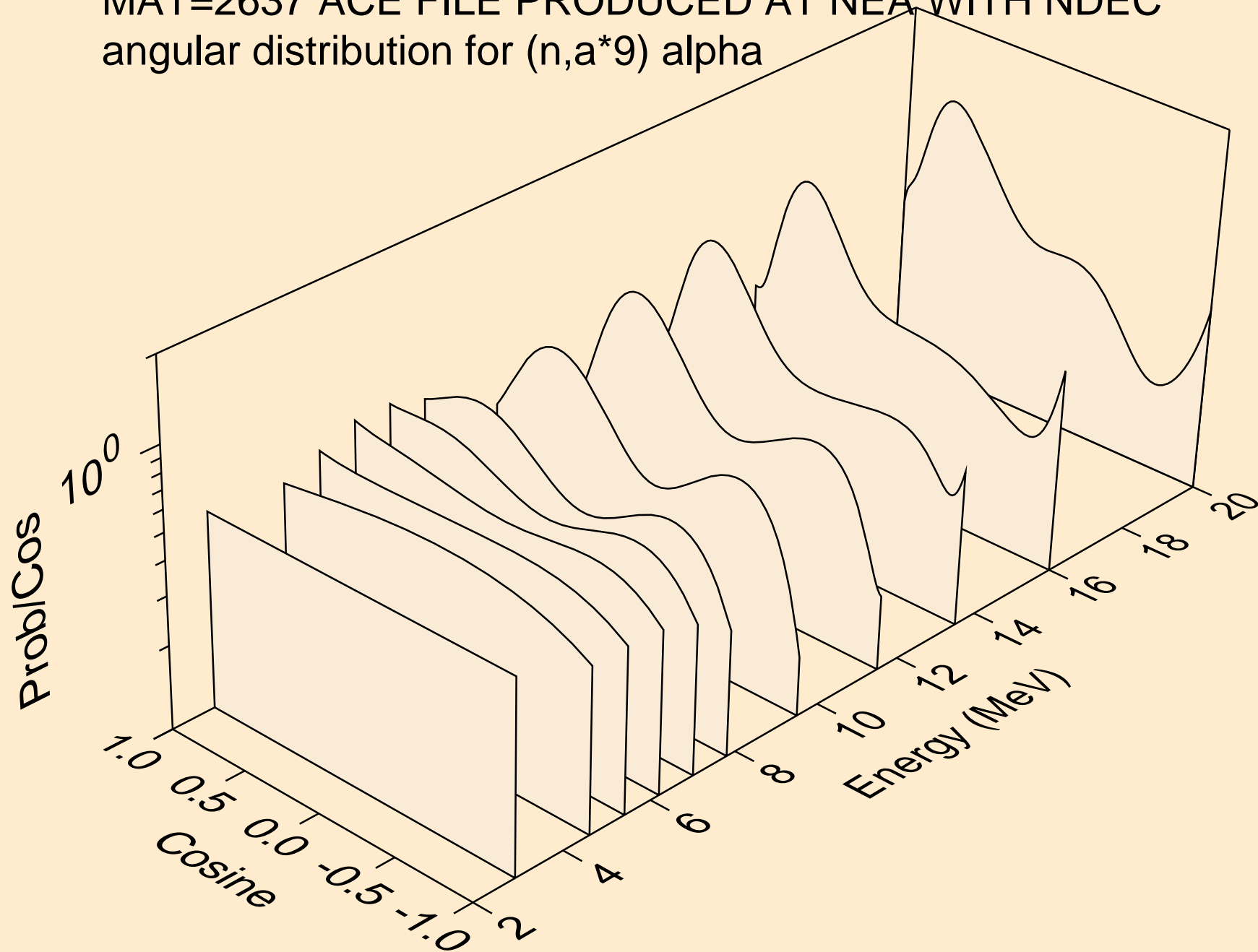

MAT=2637 ACE FILE PRODUCED AT NEA WITH NDEC  
angular distribution for (n,a\*10) alpha

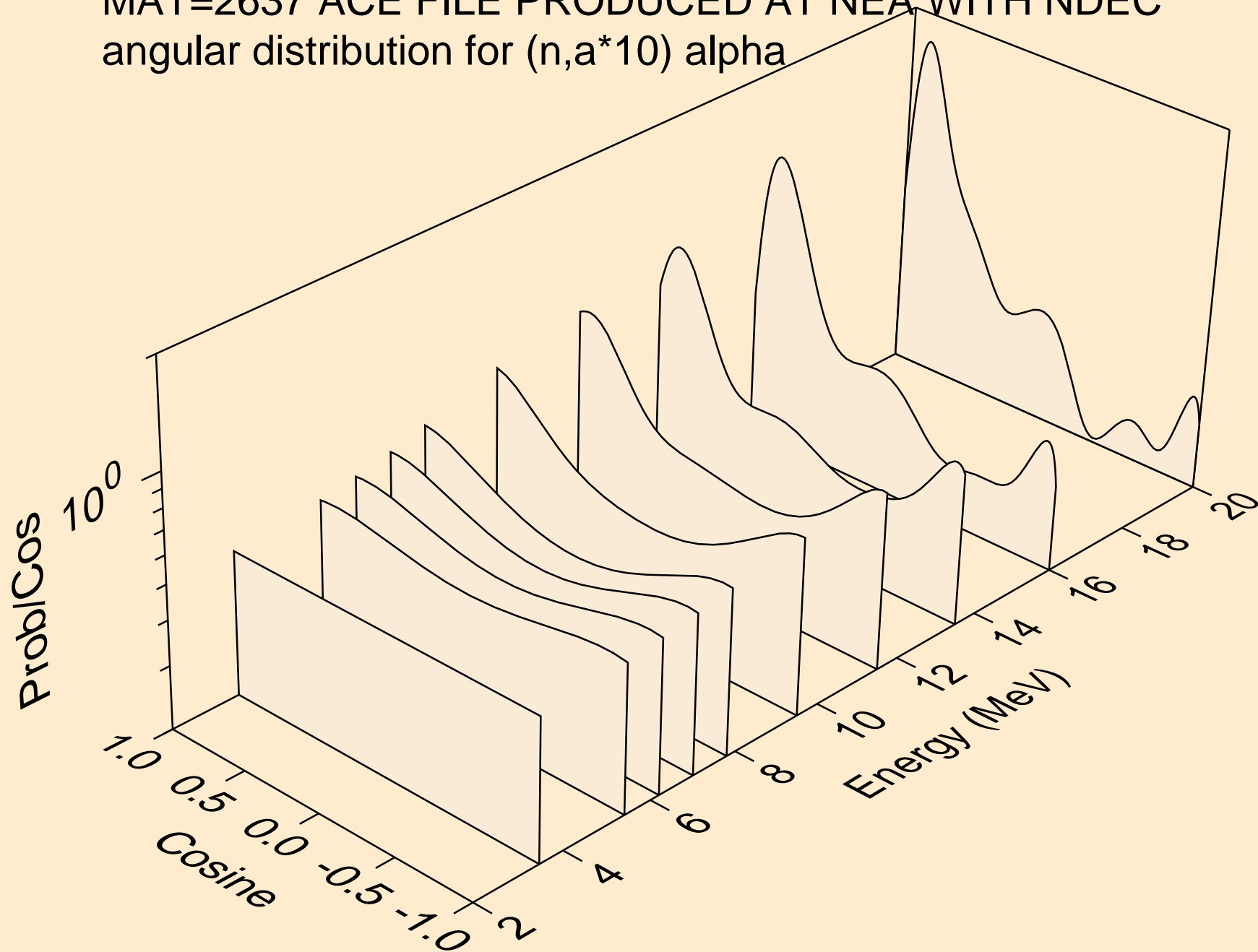

MAT=2637 ACE FILE PRODUCED AT NEA WITH NDEC  
alphas from (n,a\*c)

