

MAT=2834 ACE FILE PRODUCED AT NEA WITH NDEC
Principal cross sections

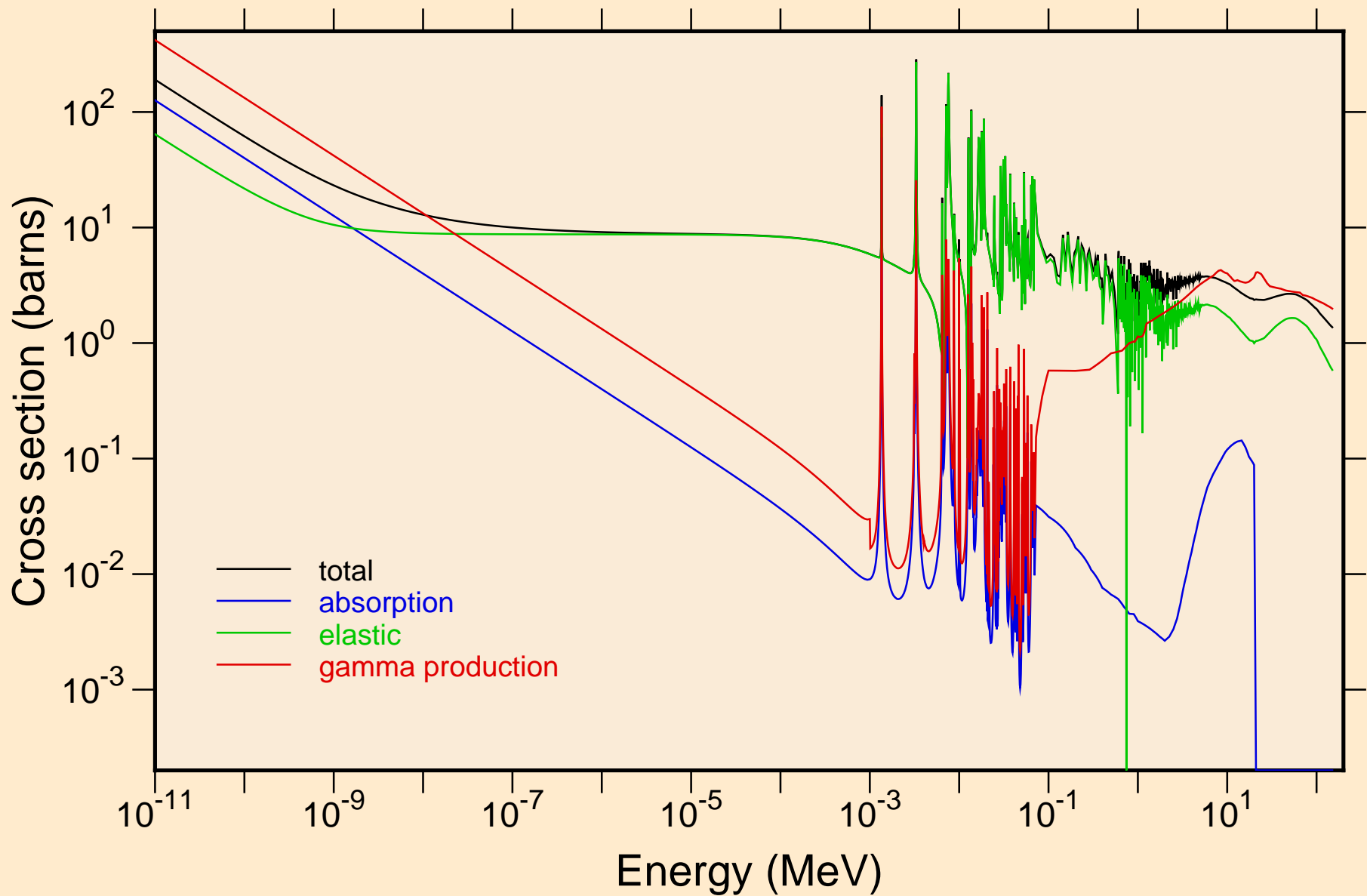

MAT=2834 ACE FILE PRODUCED AT NEA WITH NDEC
resonance total cross section

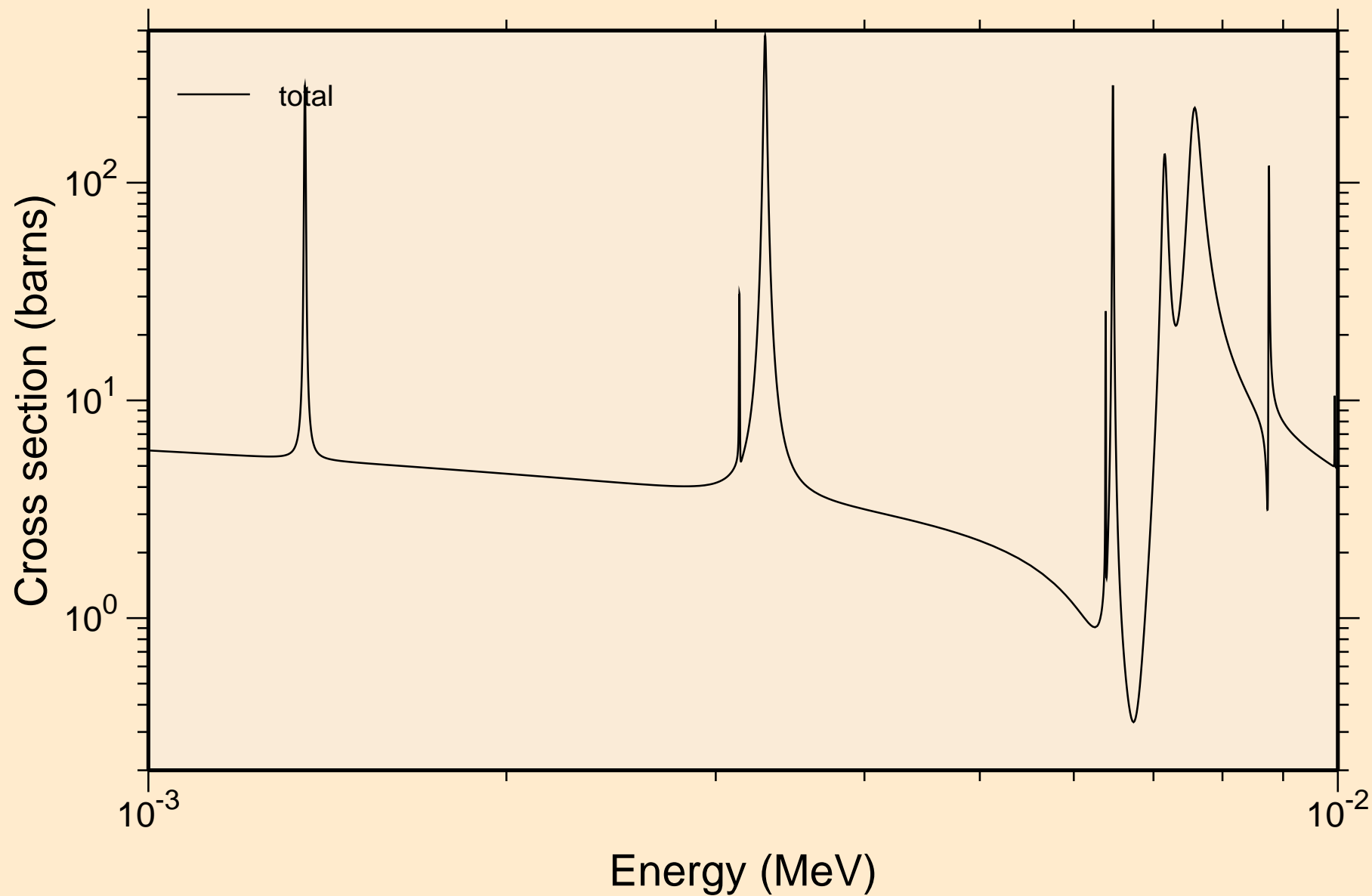

MAT=2834 ACE FILE PRODUCED AT NEA WITH NDEC
resonance total cross section

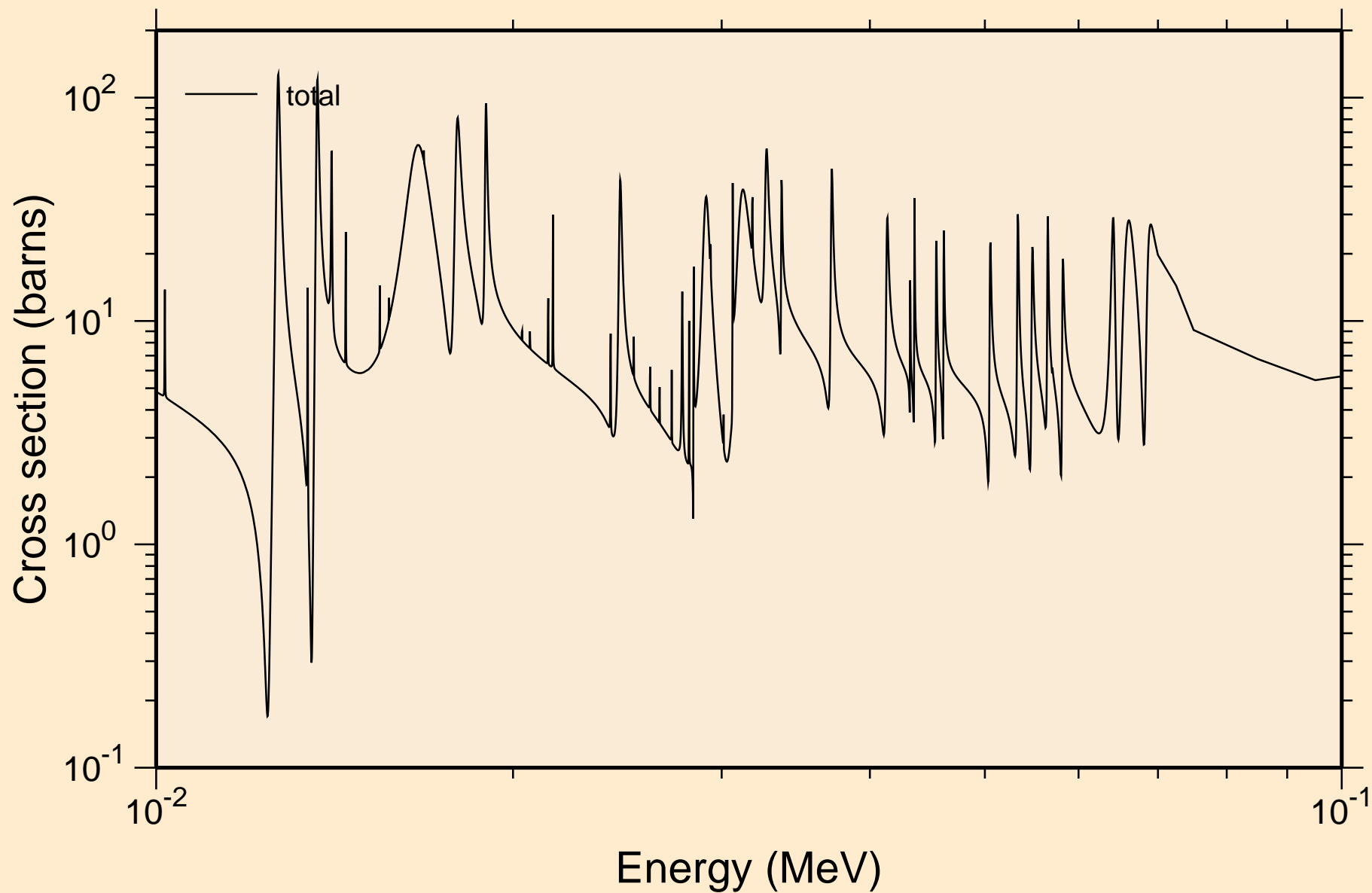

MAT=2834 ACE FILE PRODUCED AT NEA WITH NDEC
resonance total cross section

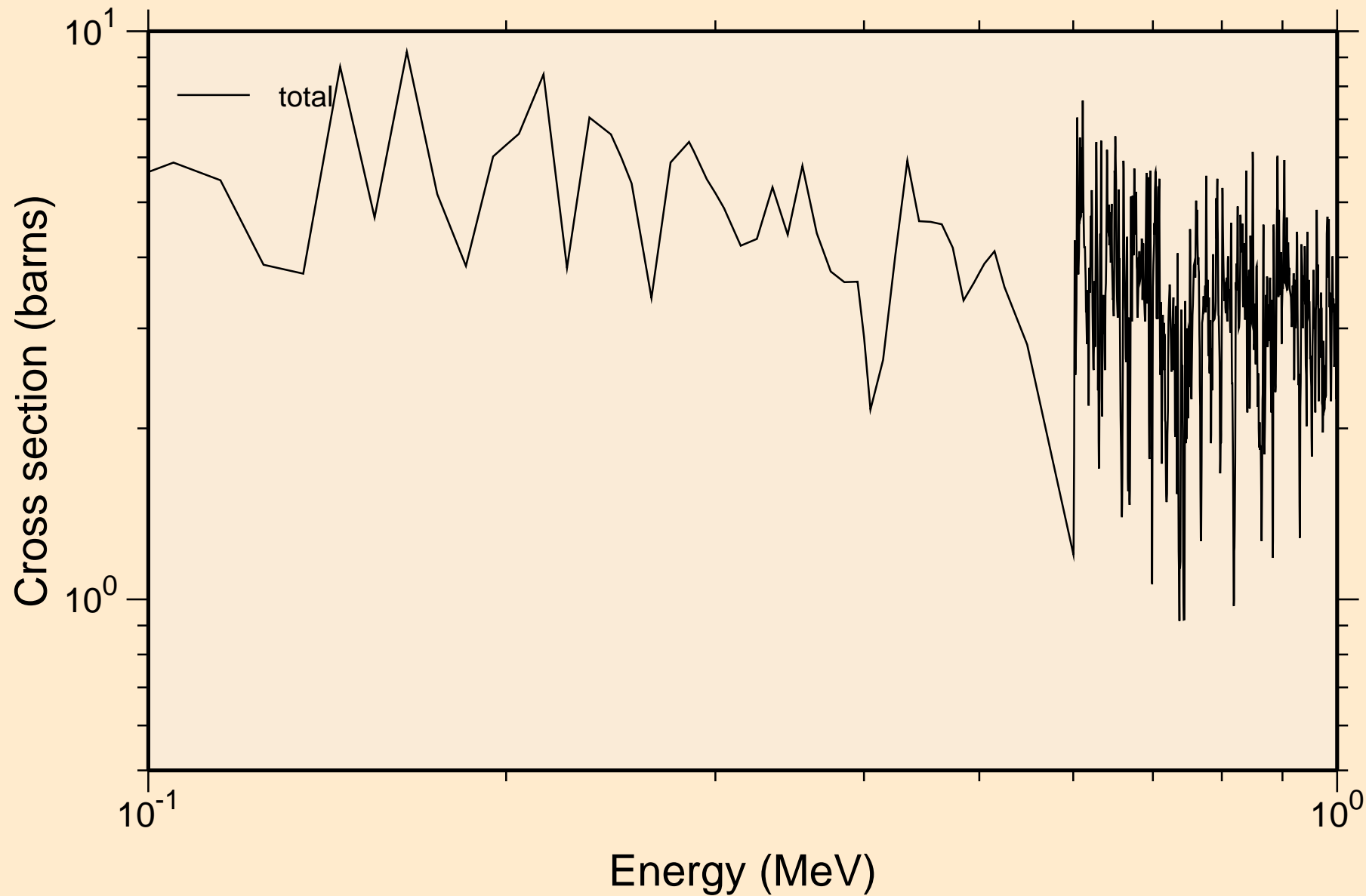

MAT=2834 ACE FILE PRODUCED AT NEA WITH NDEC
resonance total cross section

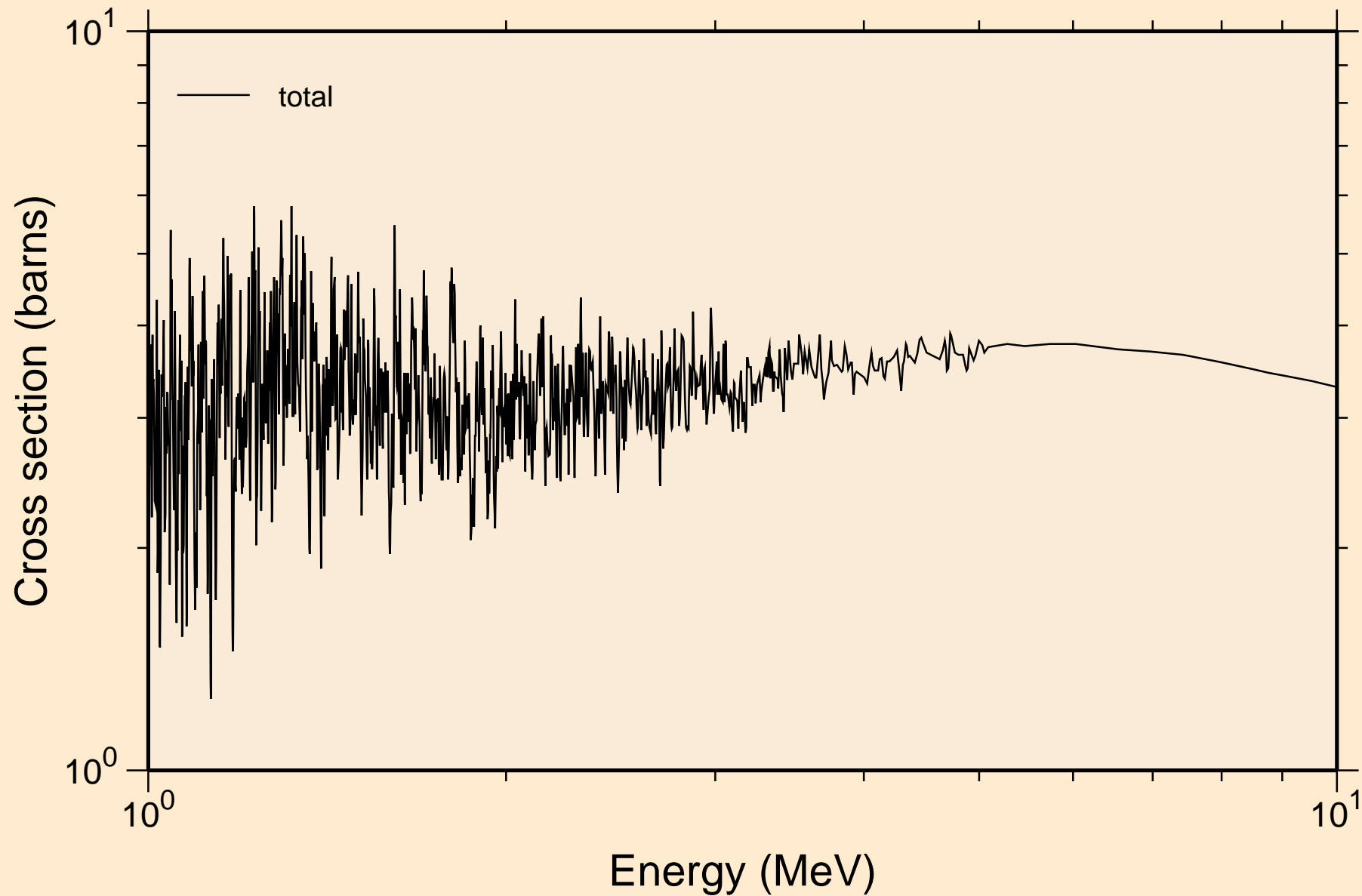

MAT=2834 ACE FILE PRODUCED AT NEA WITH NDEC
resonance absorption cross sections

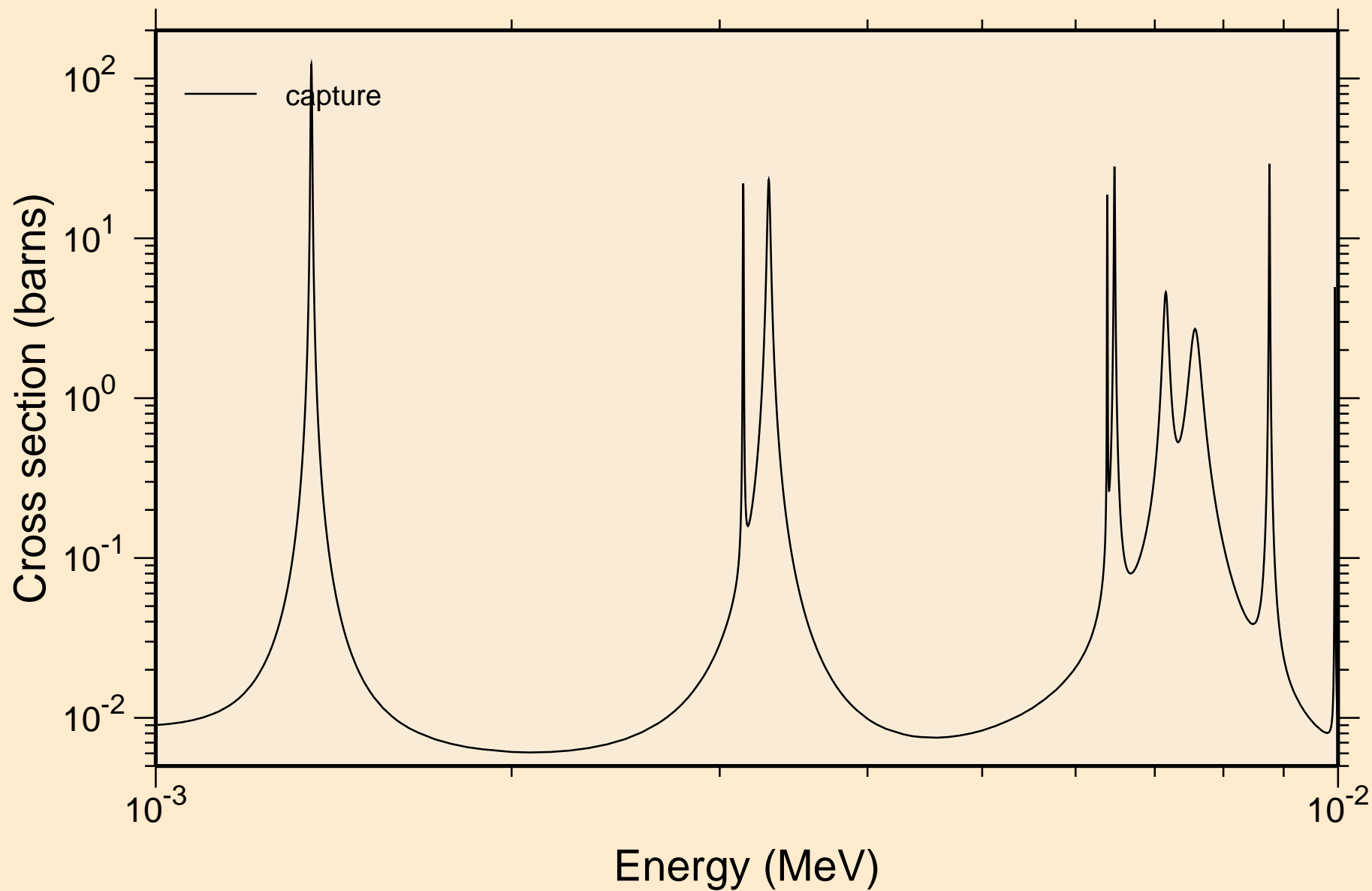

MAT=2834 ACE FILE PRODUCED AT NEA WITH NDEC
resonance absorption cross sections

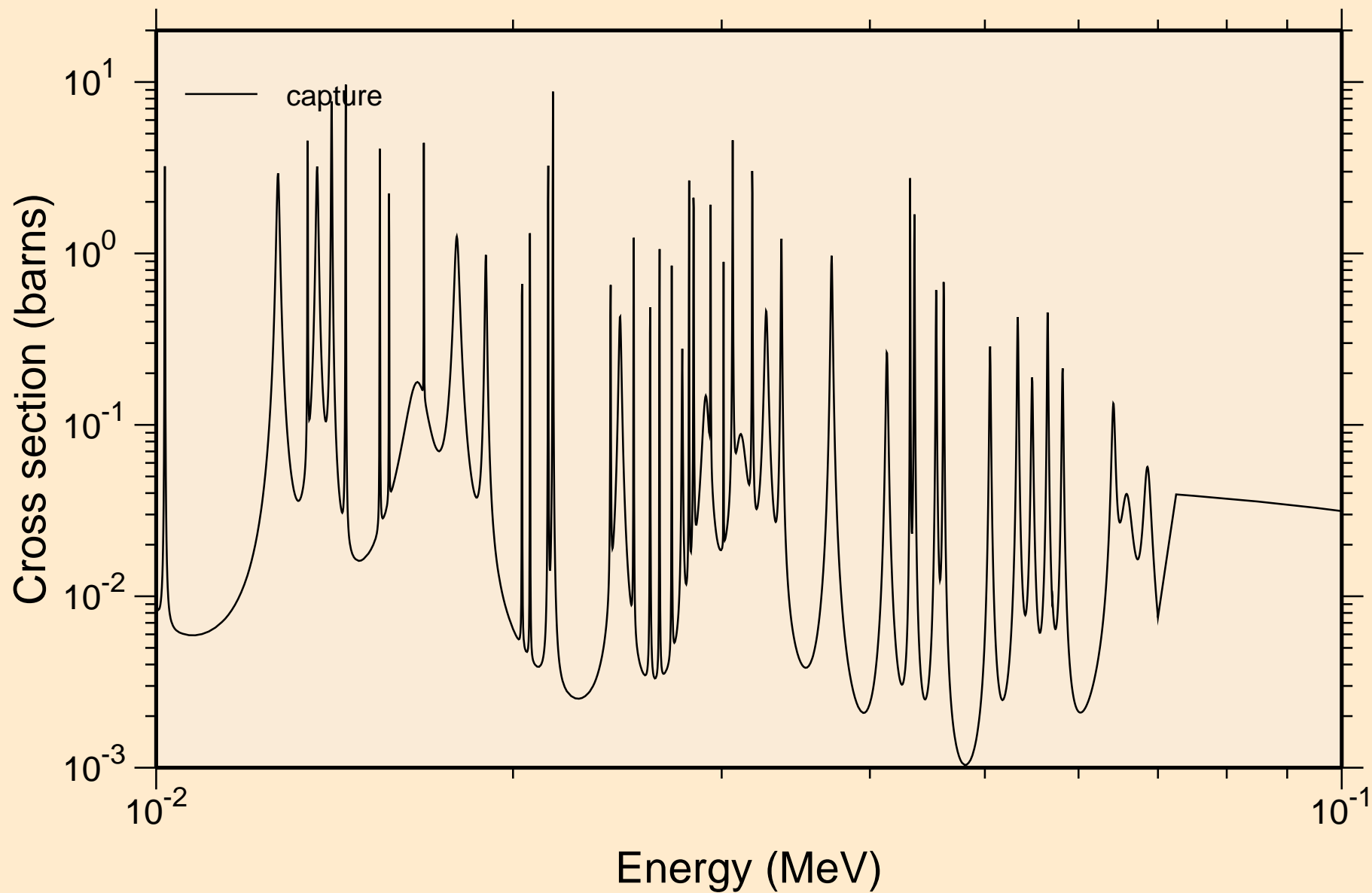

MAT=2834 ACE FILE PRODUCED AT NEA WITH NDEC
resonance absorption cross sections

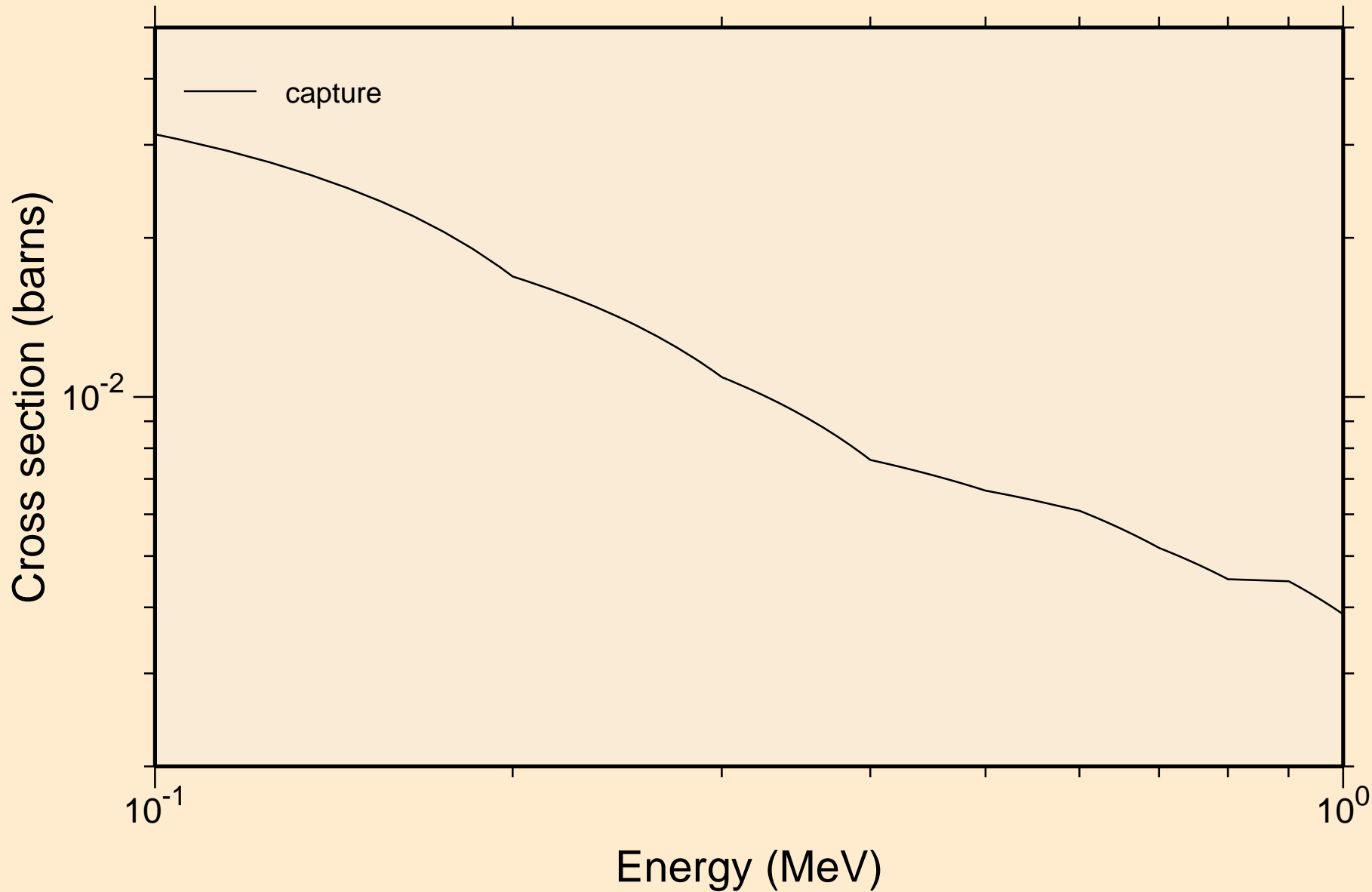

MAT=2834 ACE FILE PRODUCED AT NEA WITH NDEC
resonance absorption cross sections

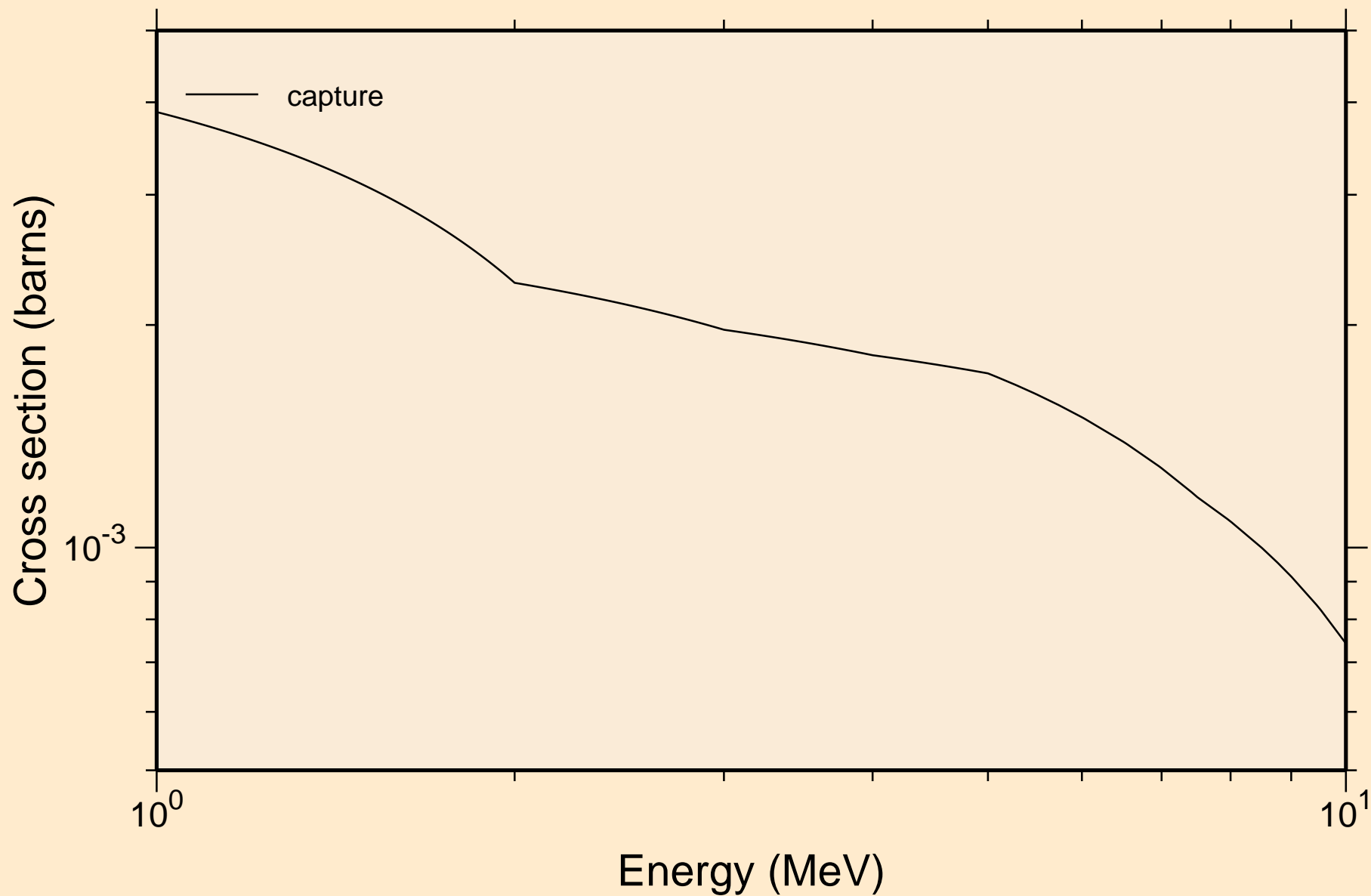

MAT=2834 ACE FILE PRODUCED AT NEA WITH NDEC
Heating

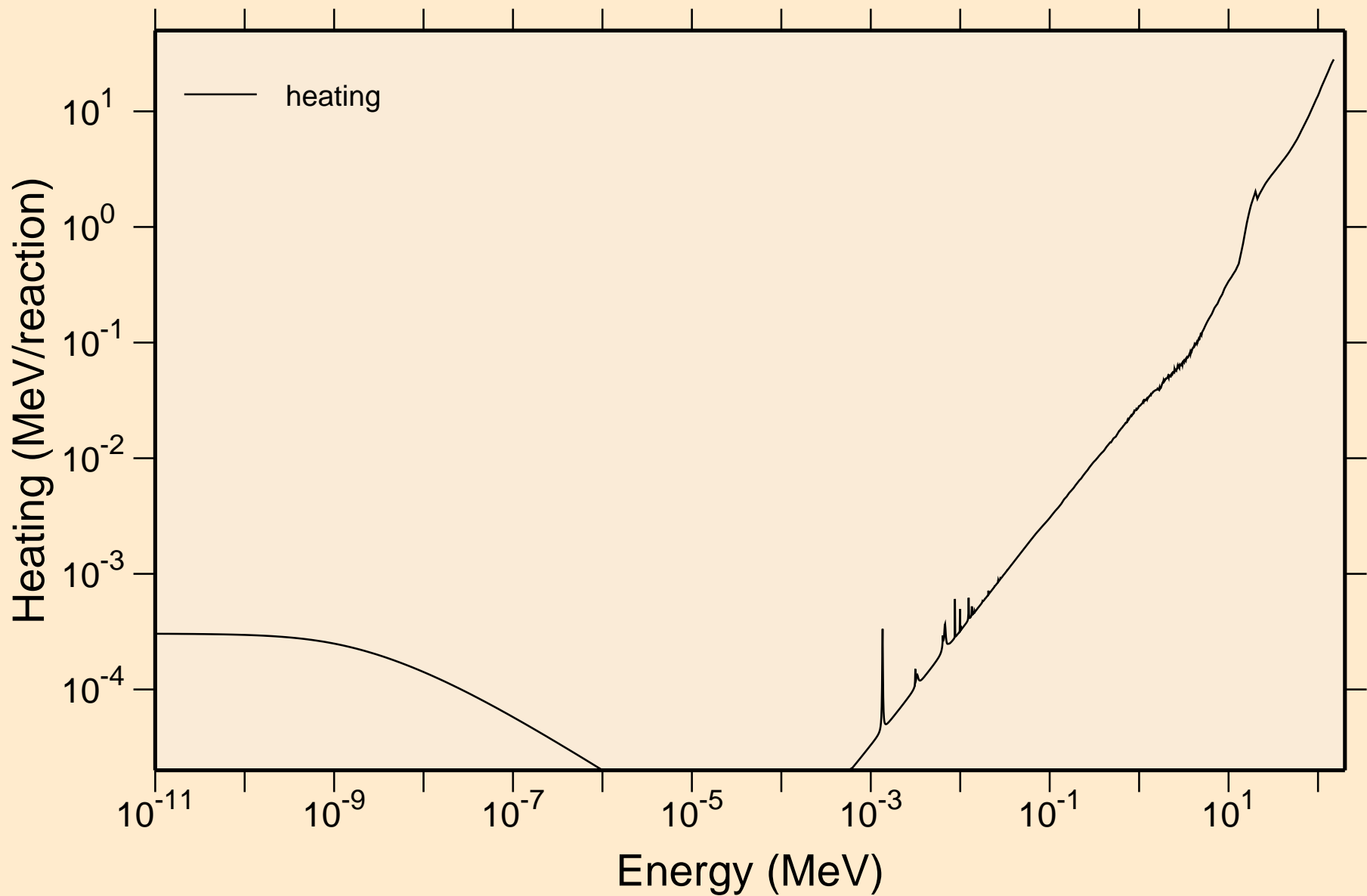

MAT=2834 ACE FILE PRODUCED AT NEA WITH NDEC
Damage

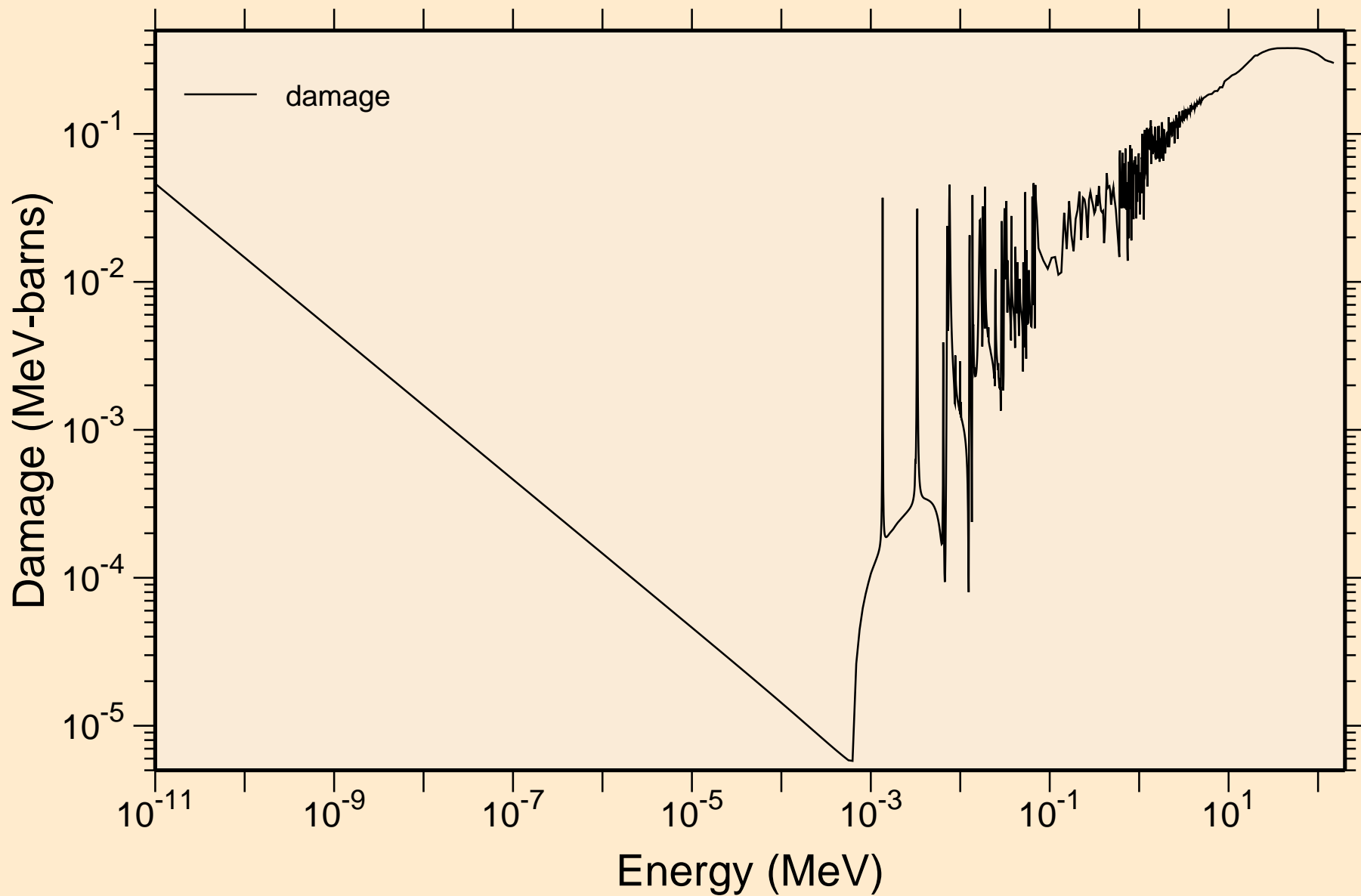

MAT=2834 ACE FILE PRODUCED AT NEA WITH NDEC
Non-threshold reactions

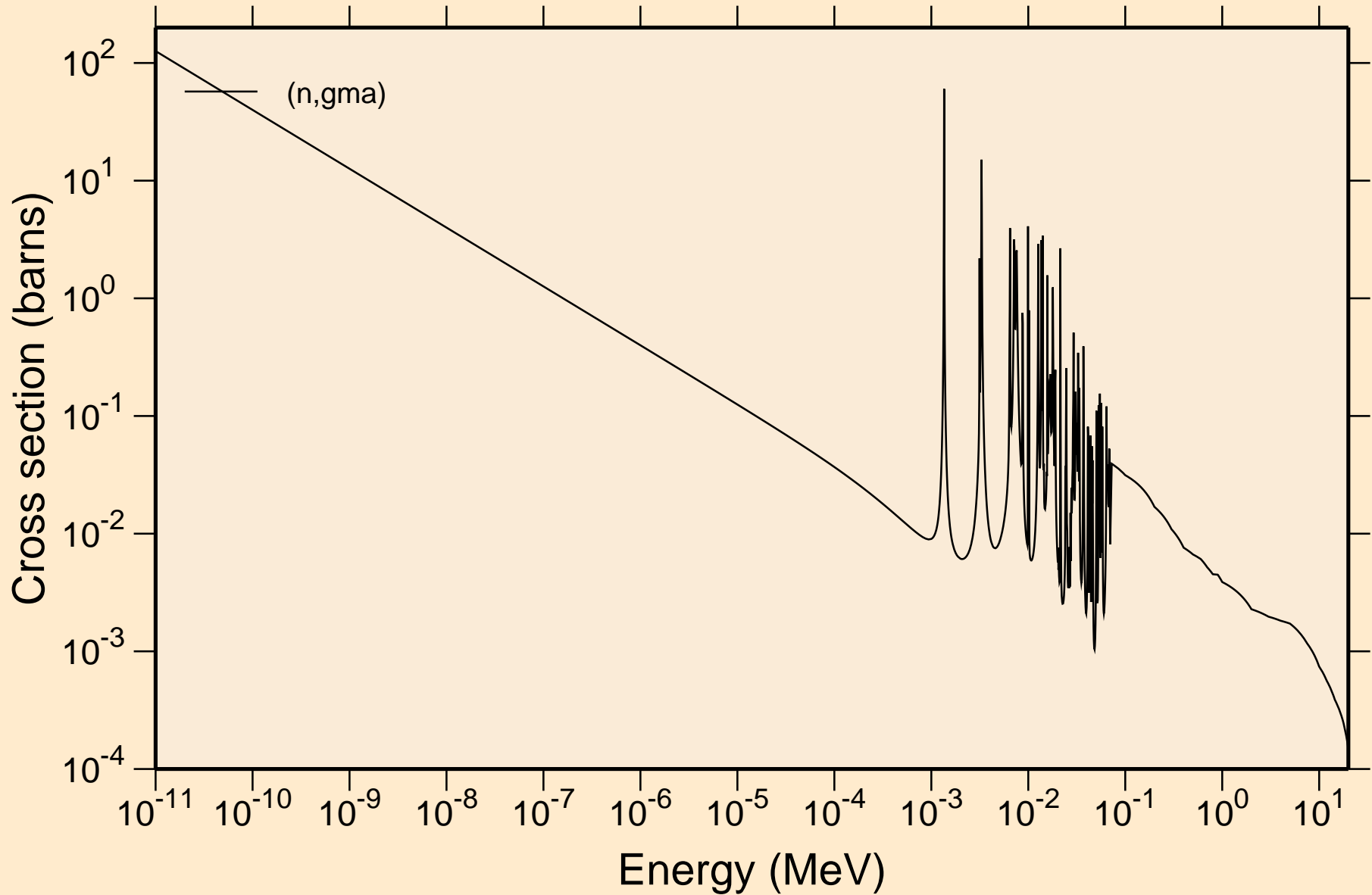

MAT=2834 ACE FILE PRODUCED AT NEA WITH NDEC

Principal cross sections

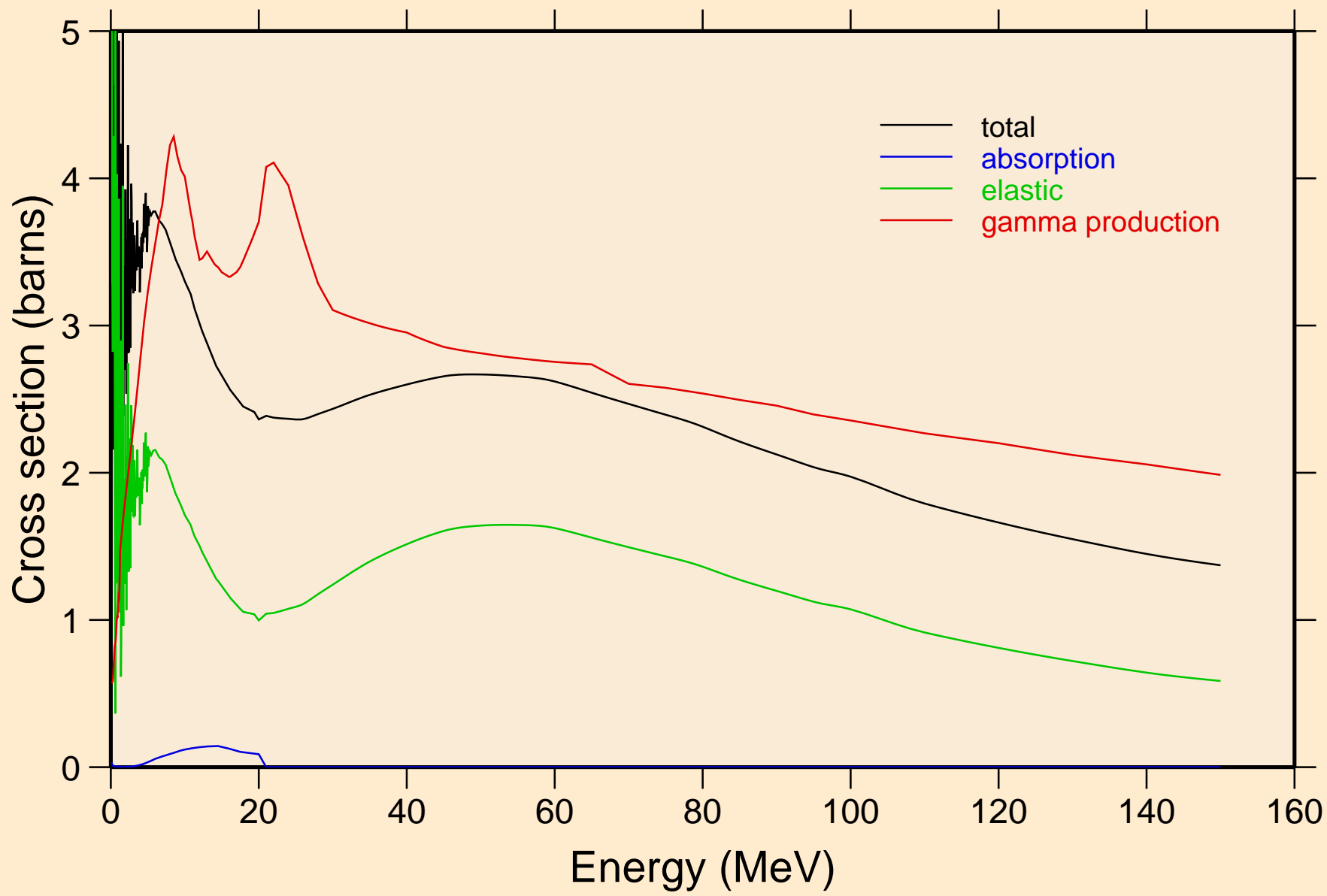

MAT=2834 ACE FILE PRODUCED AT NEA WITH NDEC
Heating

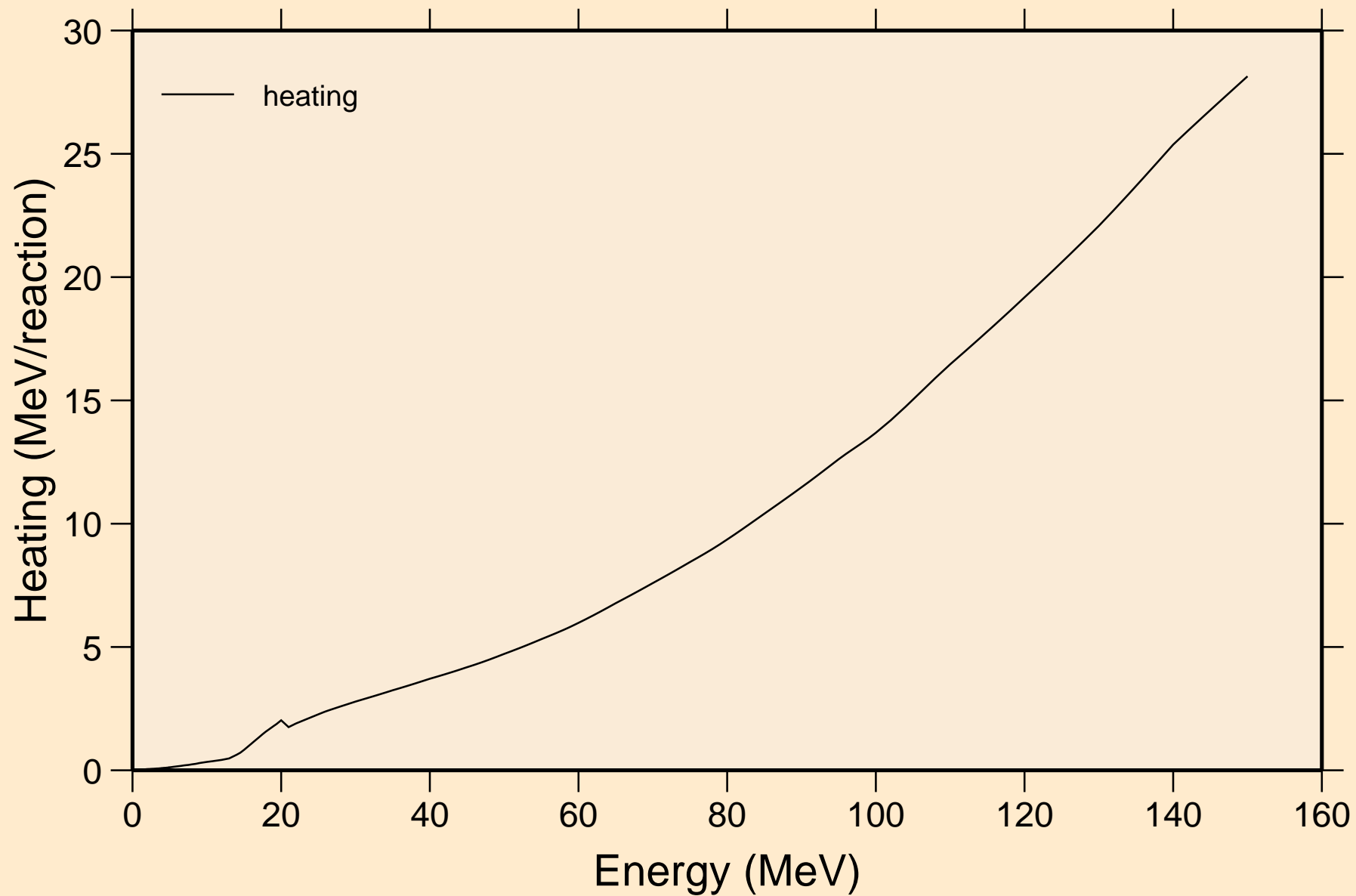

MAT=2834 ACE FILE PRODUCED AT NEA WITH NDEC
Damage

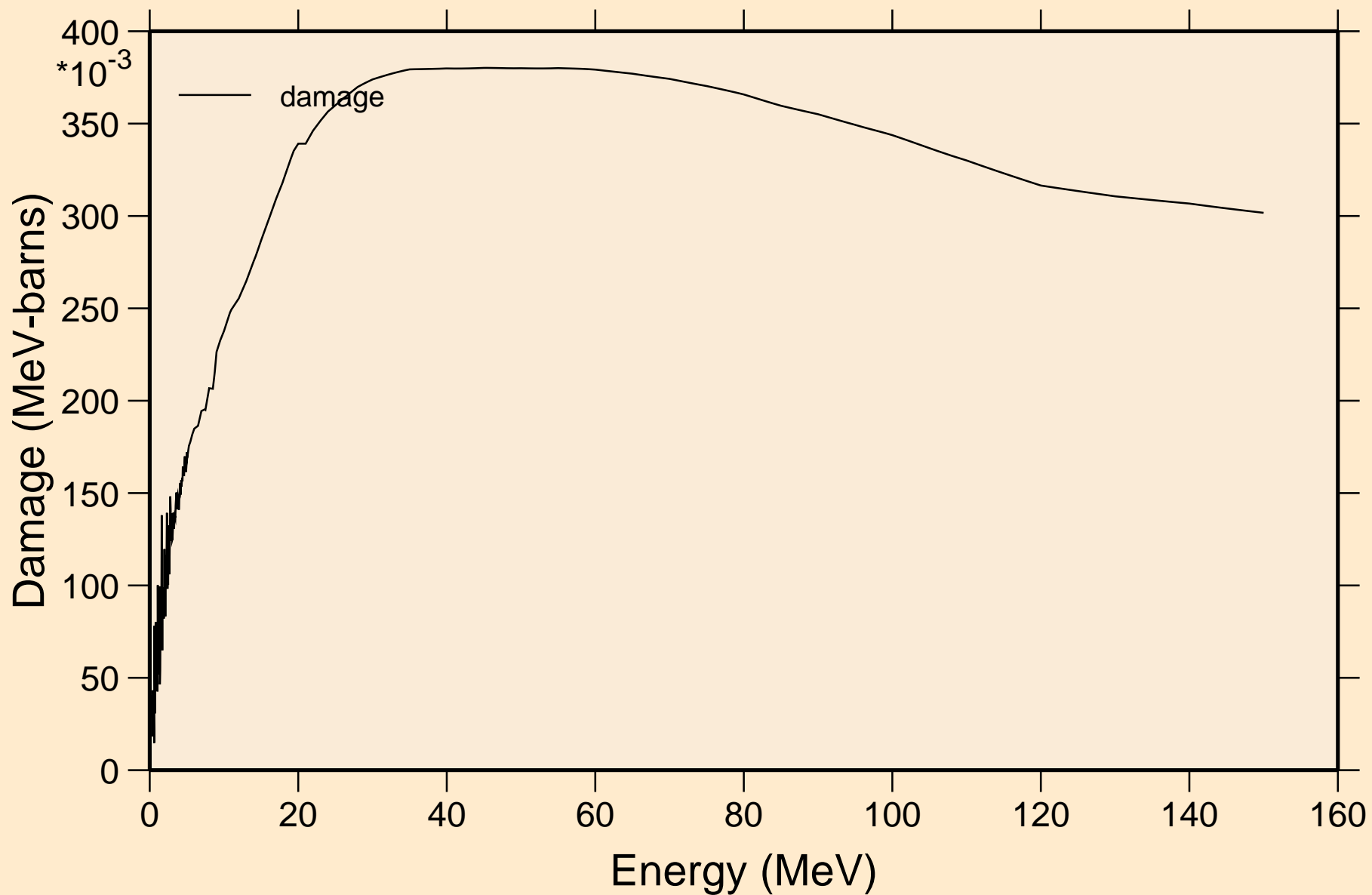

MAT=2834 ACE FILE PRODUCED AT NEA WITH NDEC
Non-threshold reactions

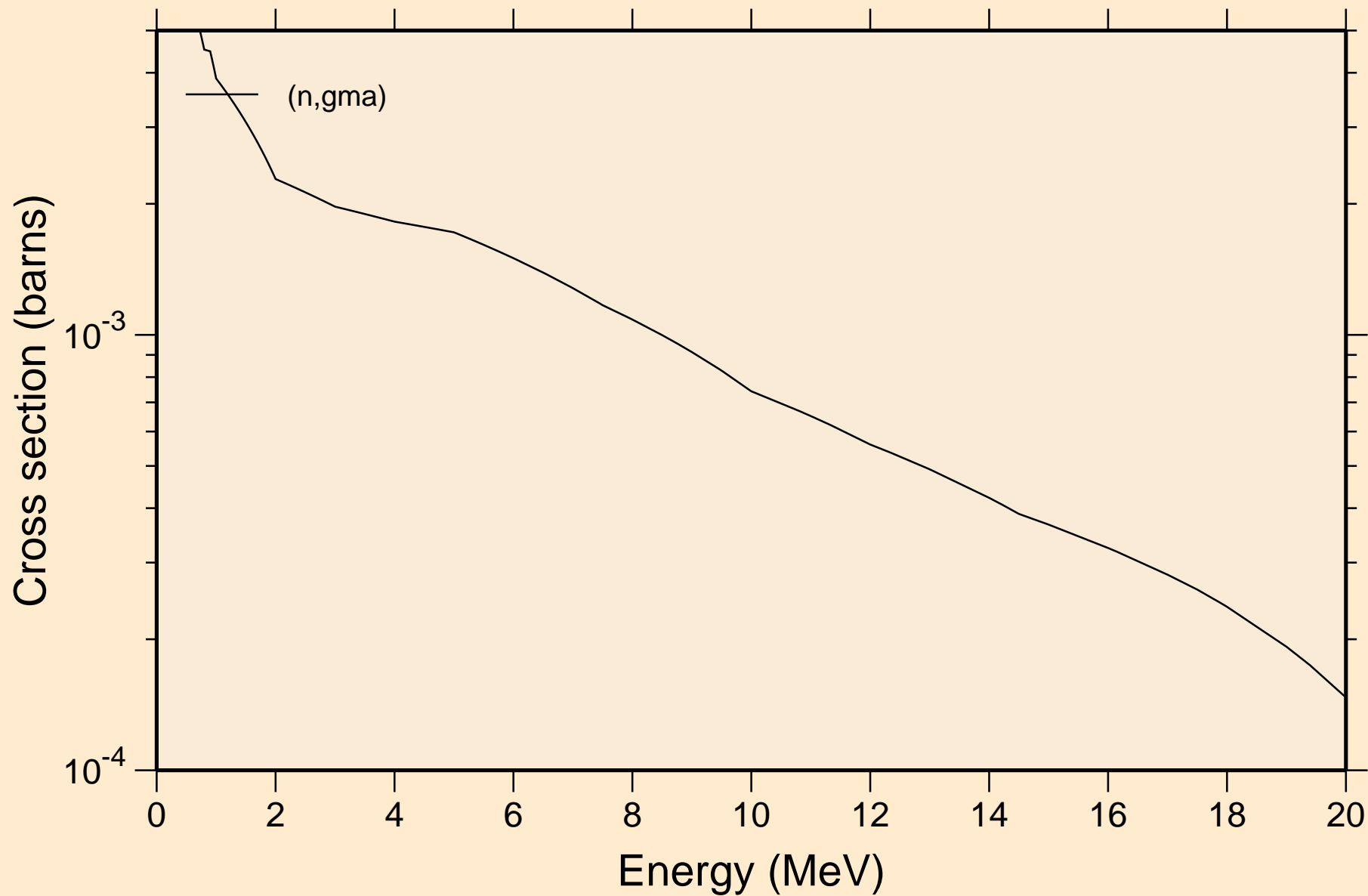

MAT=2834 ACE FILE PRODUCED AT NEA WITH NDEC
Inelastic levels

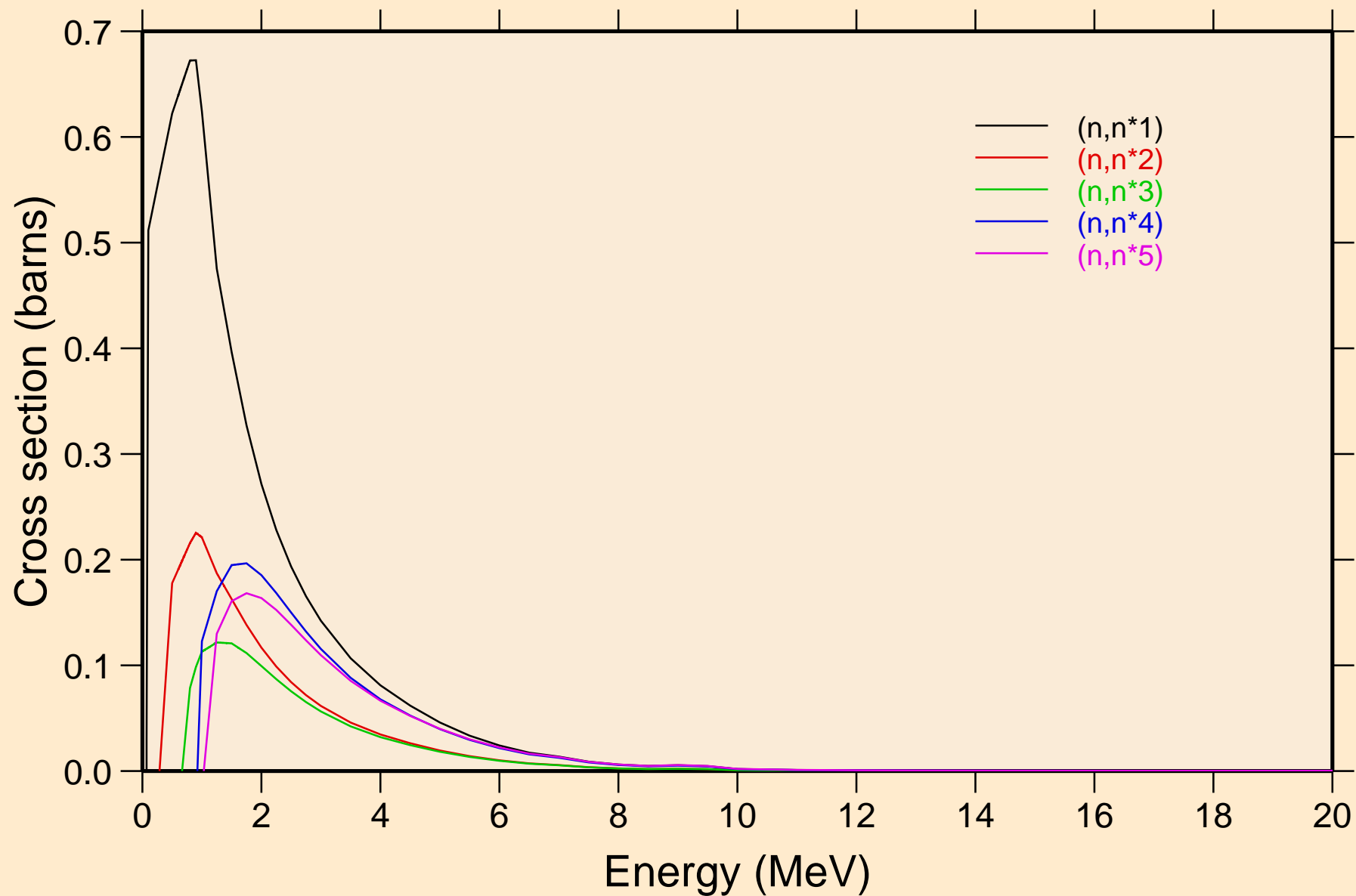

MAT=2834 ACE FILE PRODUCED AT NEA WITH NDEC
Inelastic levels

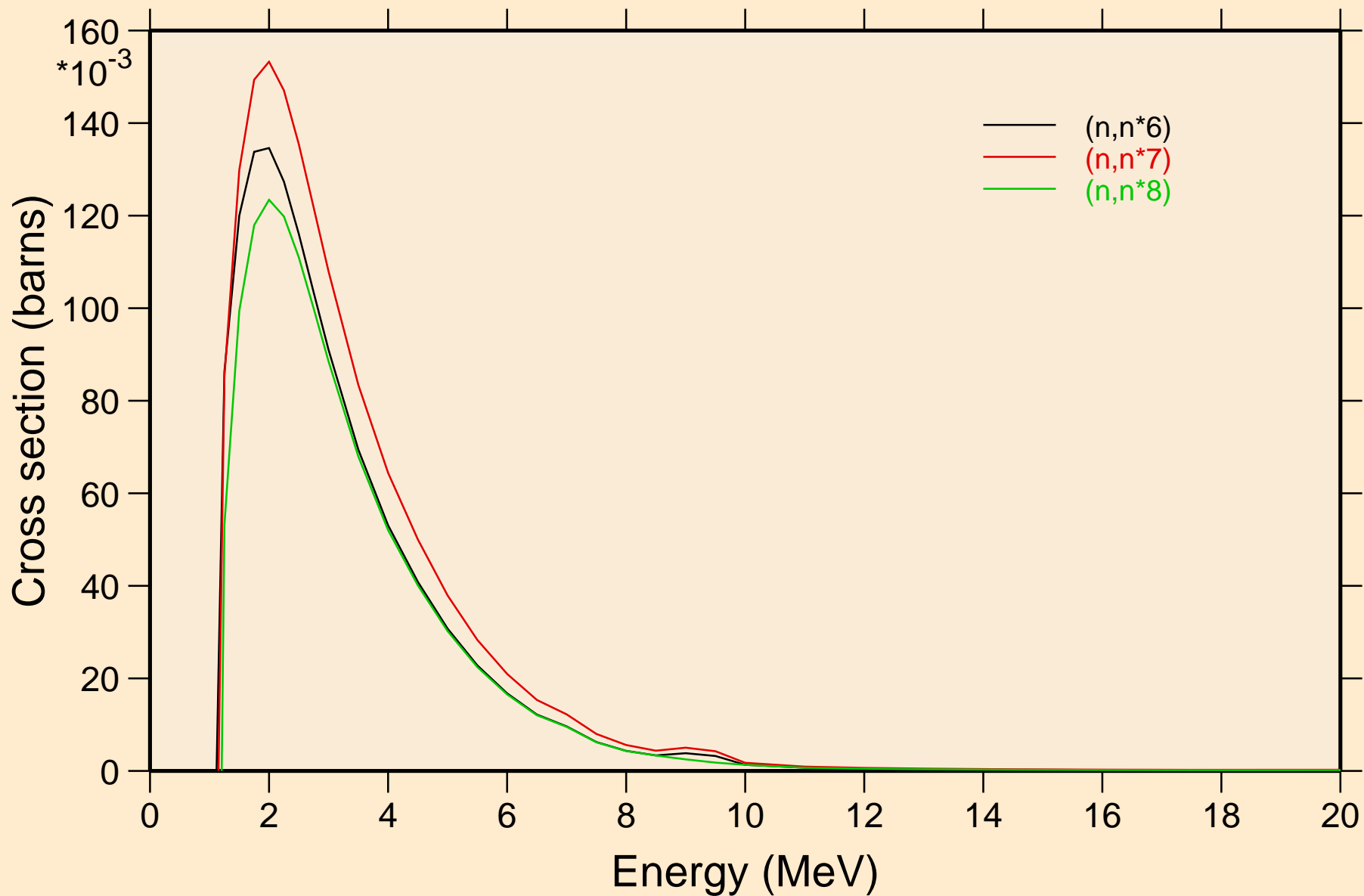

MAT=2834 ACE FILE PRODUCED AT NEA WITH NDEC
Threshold reactions

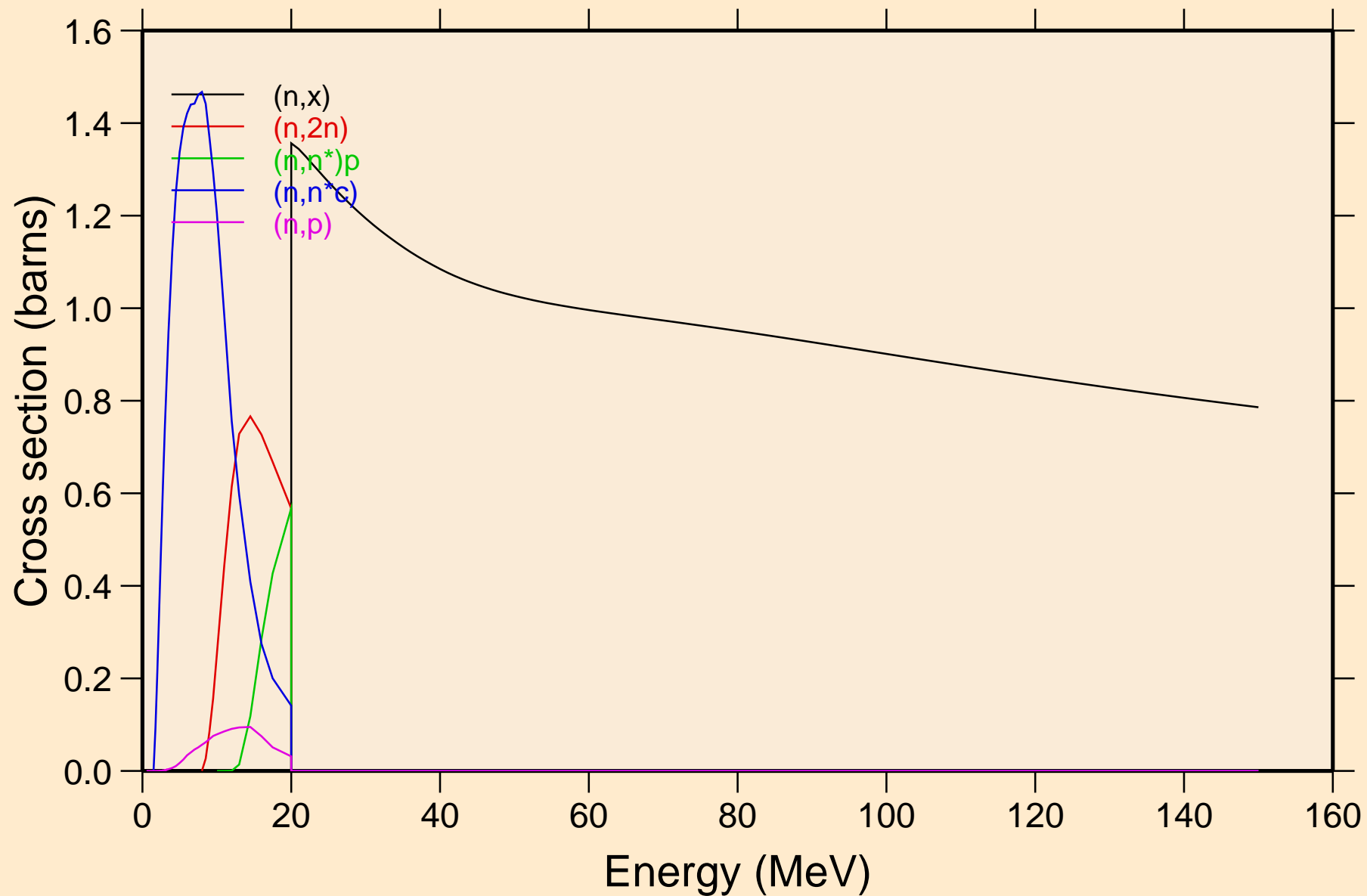

MAT=2834 ACE FILE PRODUCED AT NEA WITH NDEC
Threshold reactions

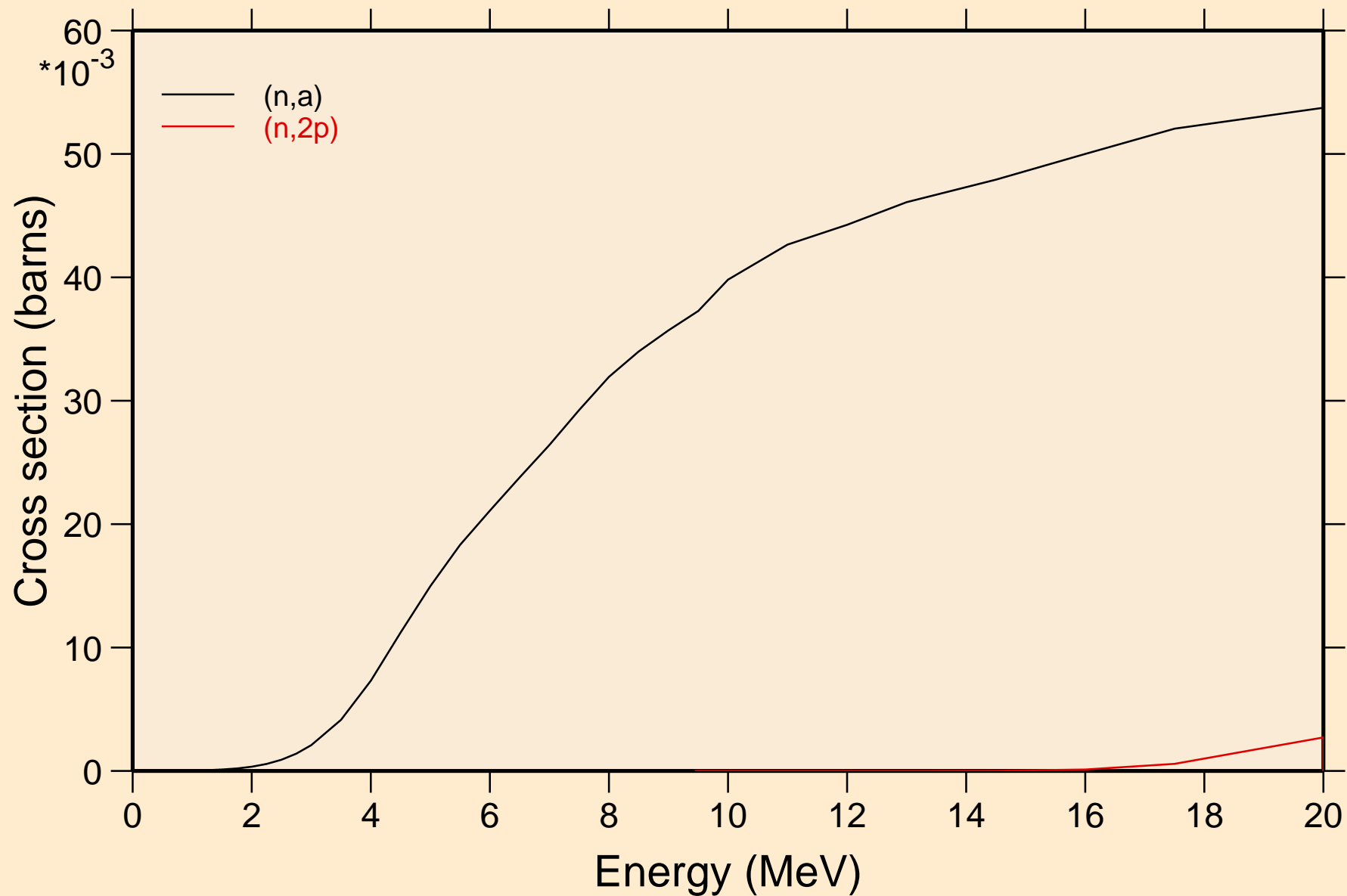

MAT=2834 ACE FILE PRODUCED AT NEA WITH NDEC
Threshold reactions

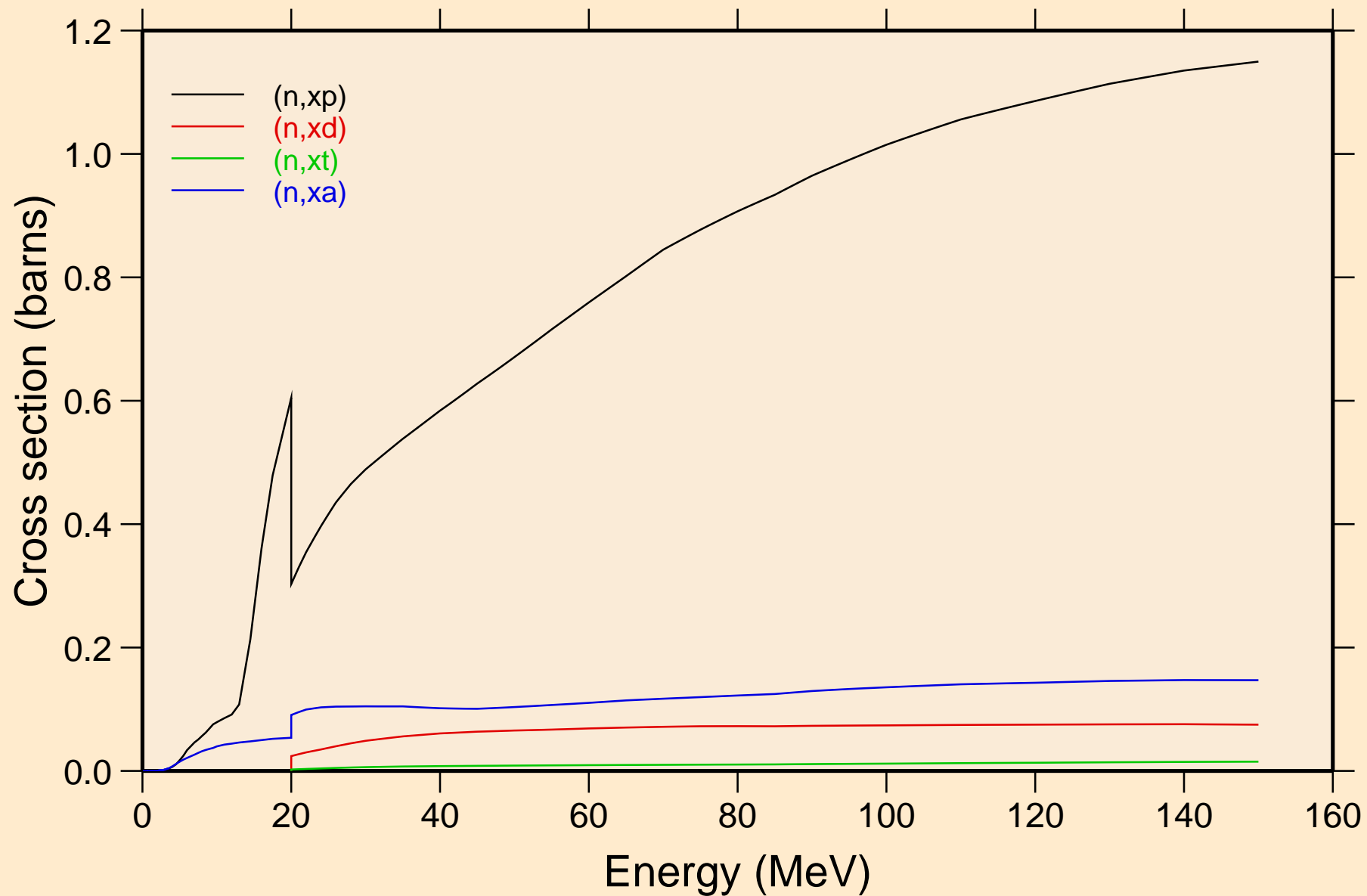

MAT=2834 ACE FILE PRODUCED AT NEA WITH NDEC
angular distribution for elastic

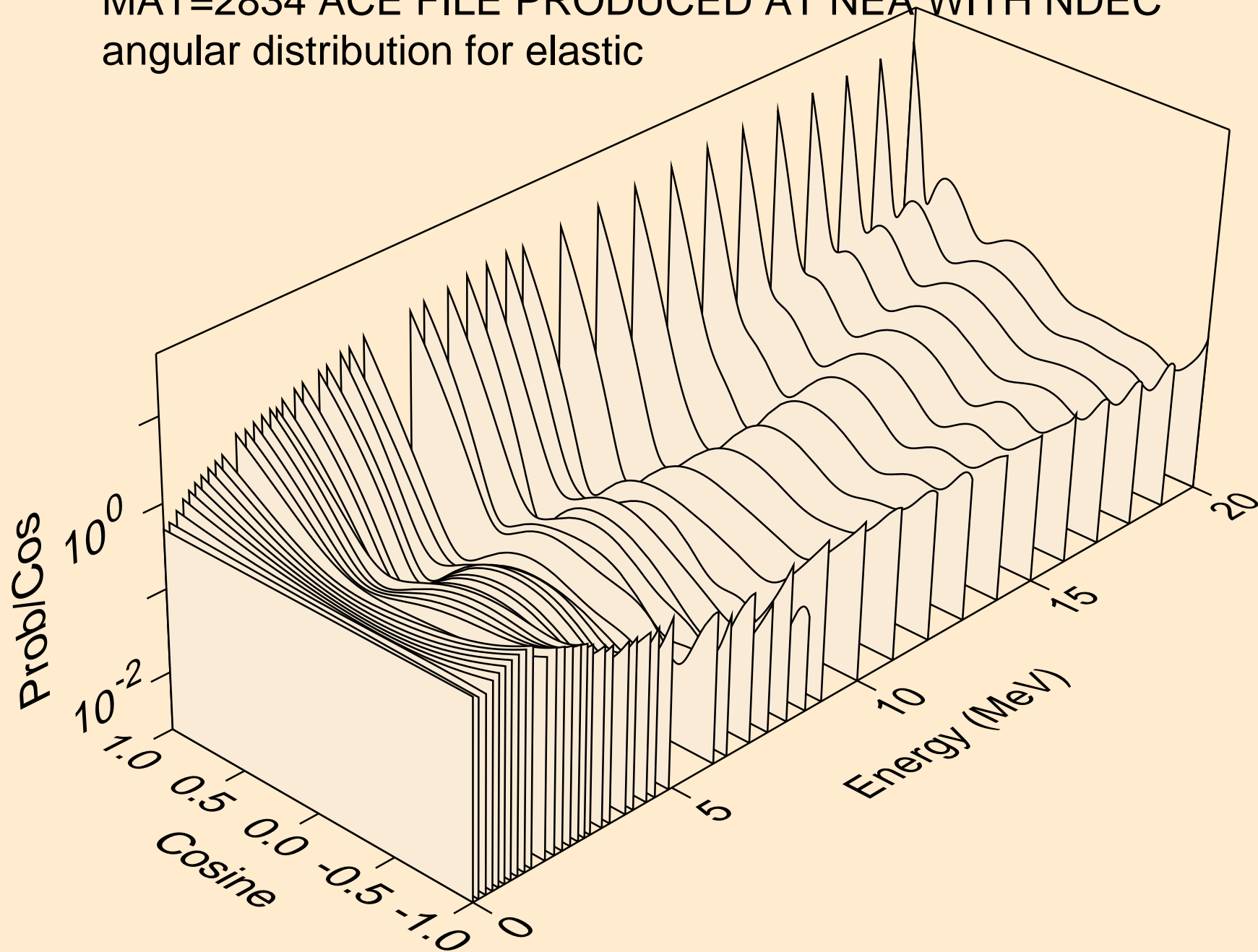

MAT=2834 ACE FILE PRODUCED AT NEA WITH NDEC
angular distribution for elastic

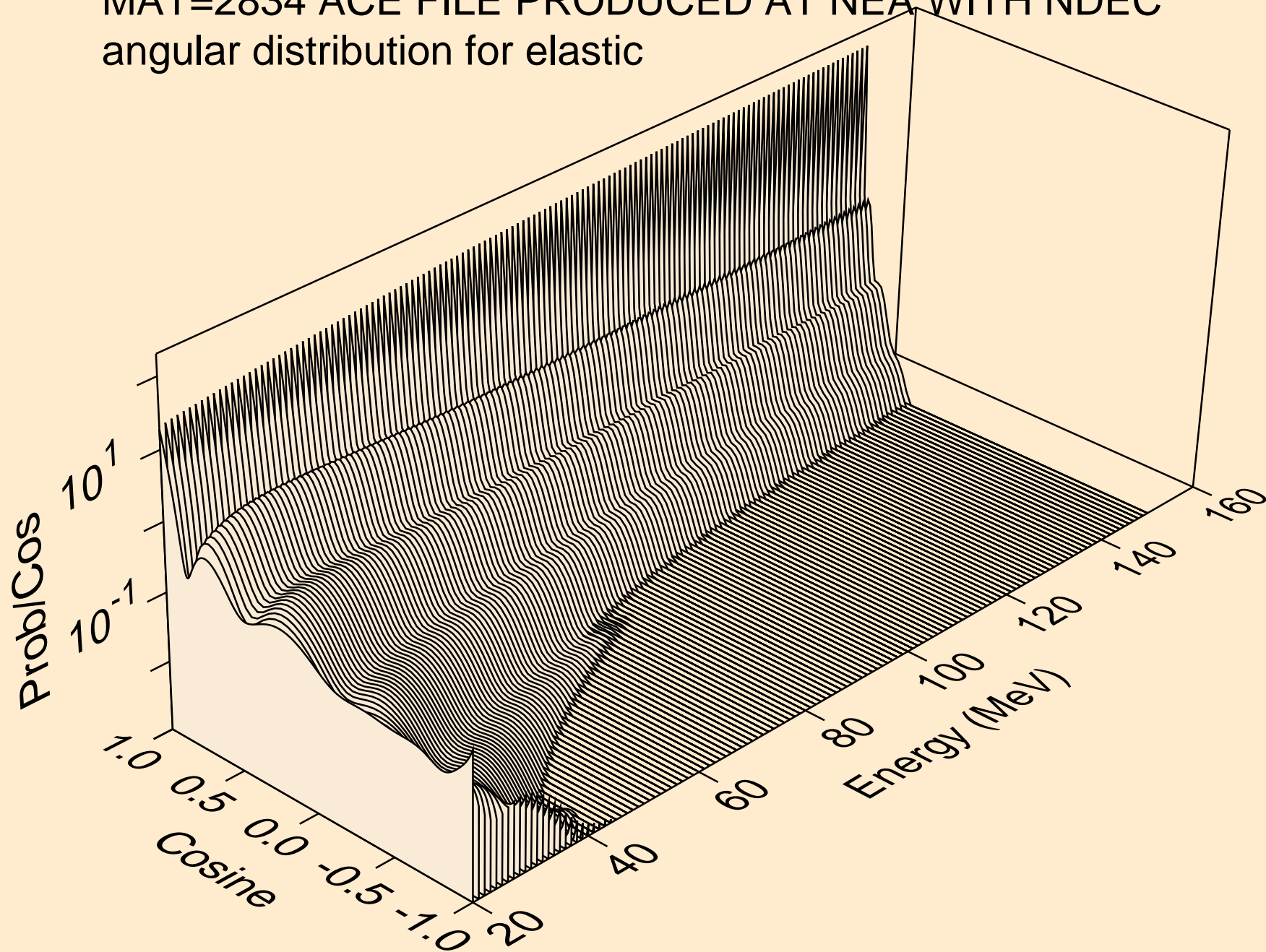

MAT=2834 ACE FILE PRODUCED AT NEA WITH NDEC
Neutron emission for (n,x)

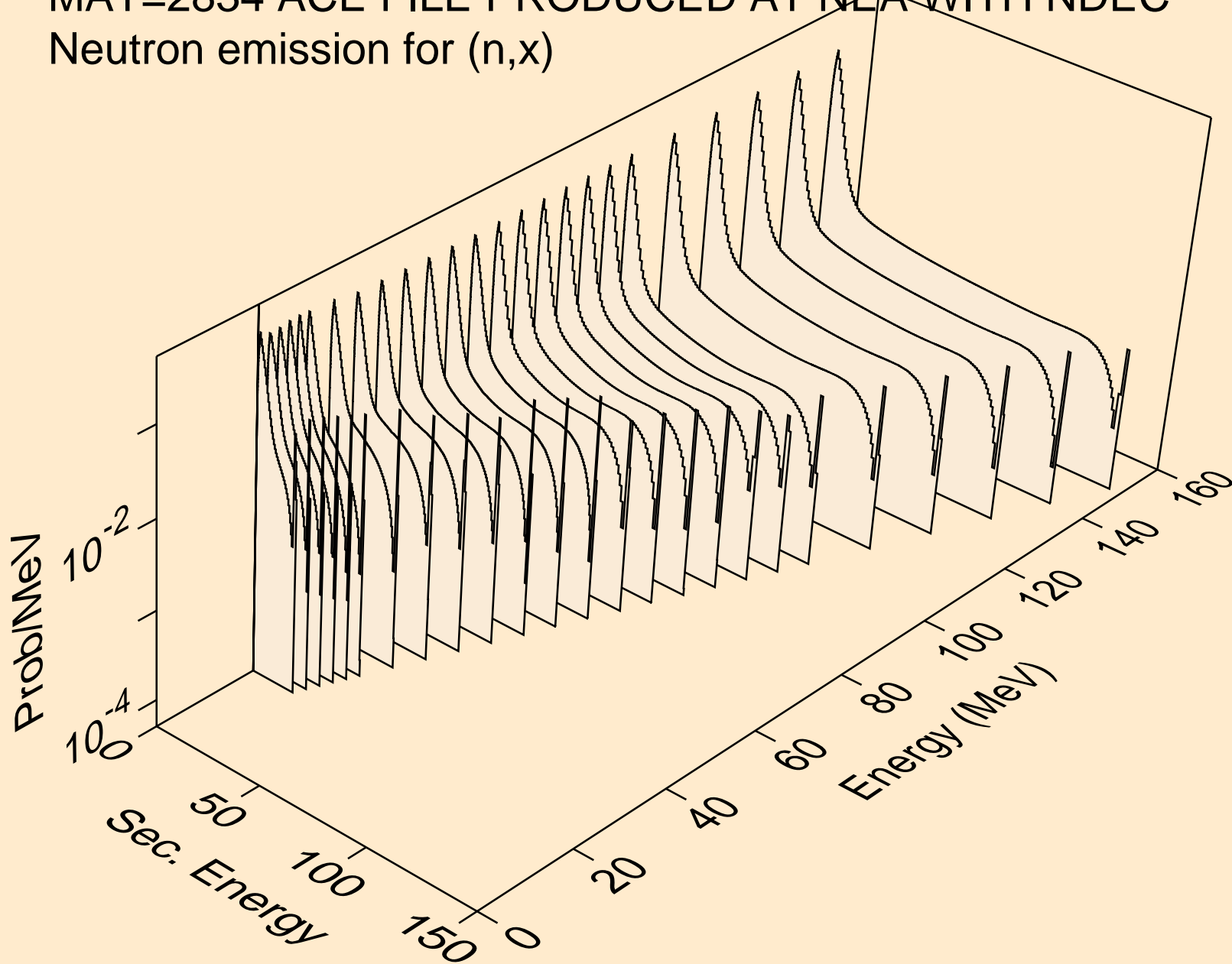

MAT=2834 ACE FILE PRODUCED AT NEA WITH NDEC
Neutron emission for (n,2n)

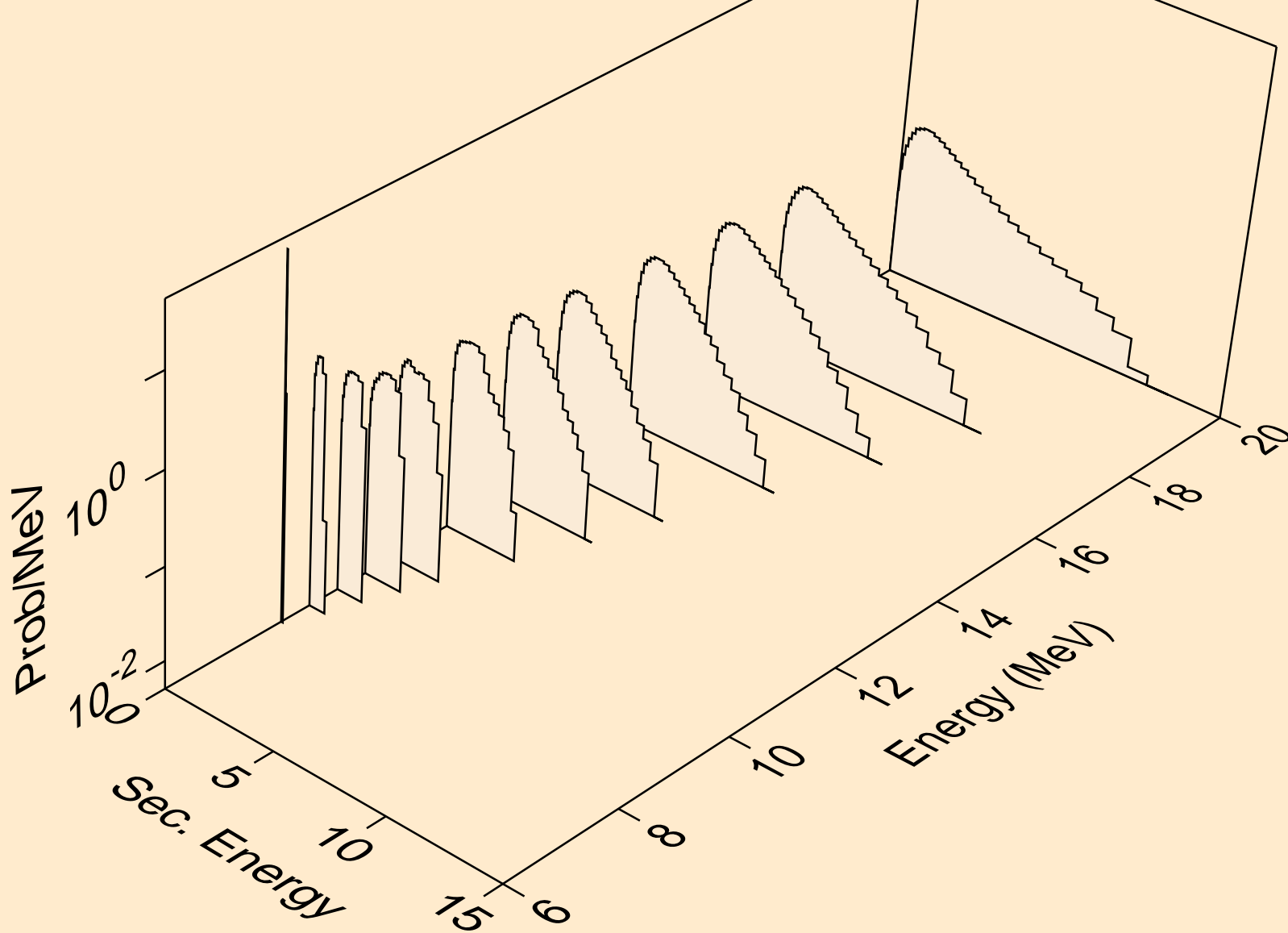

MAT=2834 ACE FILE PRODUCED AT NEA WITH NDEC
Neutron emission for (n,n*)p

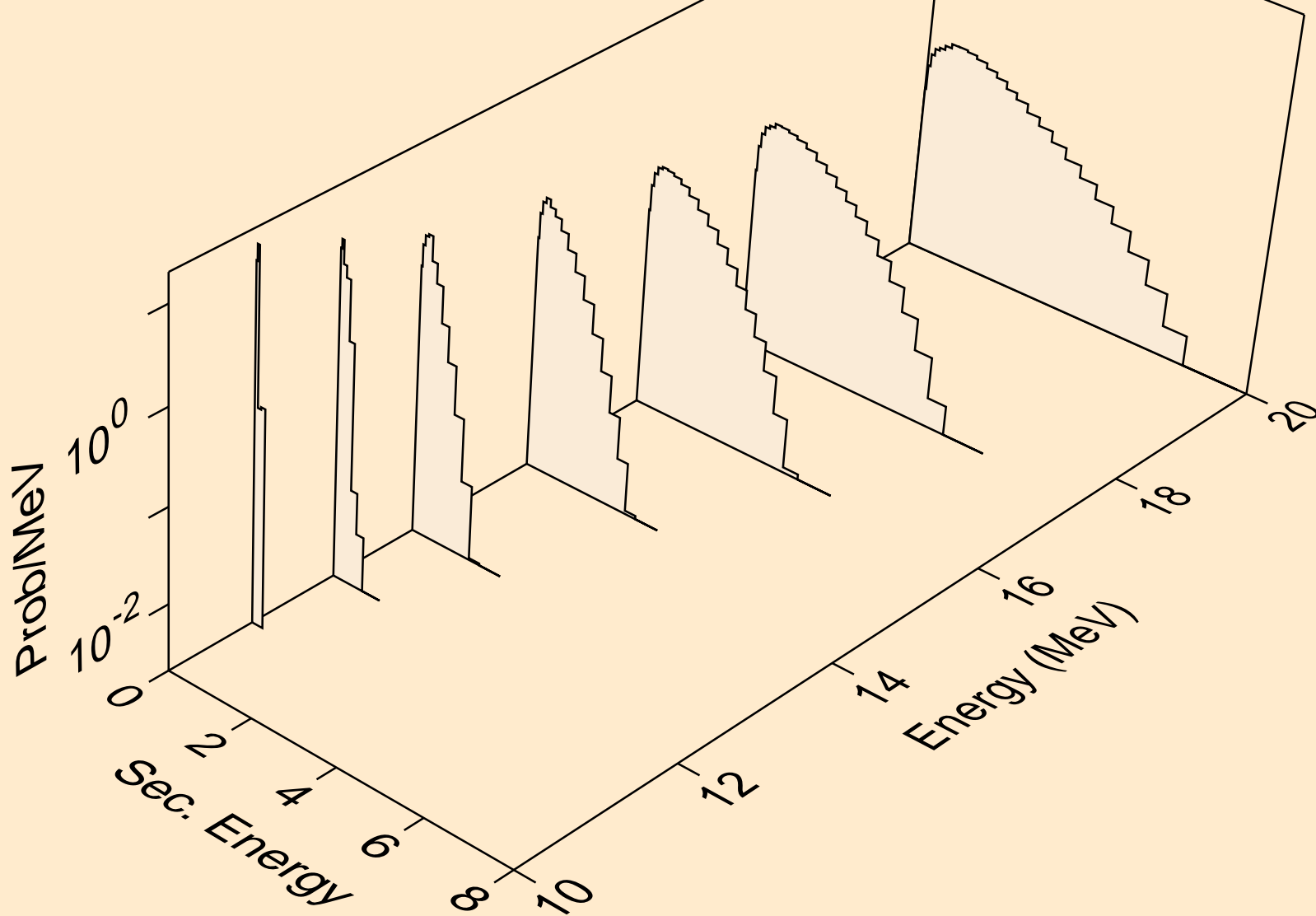

MAT=2834 ACE FILE PRODUCED AT NEA WITH NDEC
Neutron emission for (n,n*c)

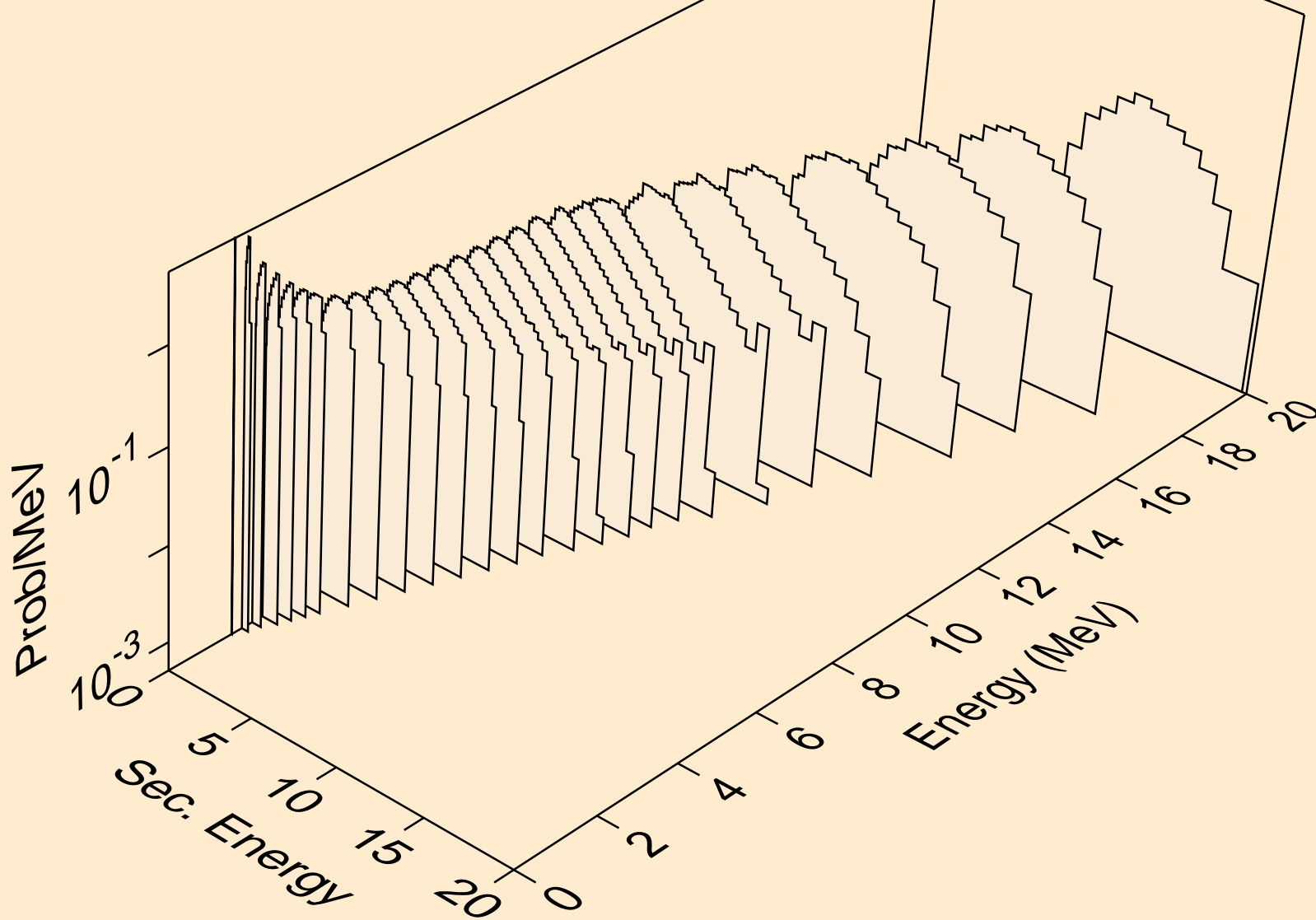

MAT=2834 ACE FILE PRODUCED AT NEA WITH NDEC
Photon emission for (n,gma)

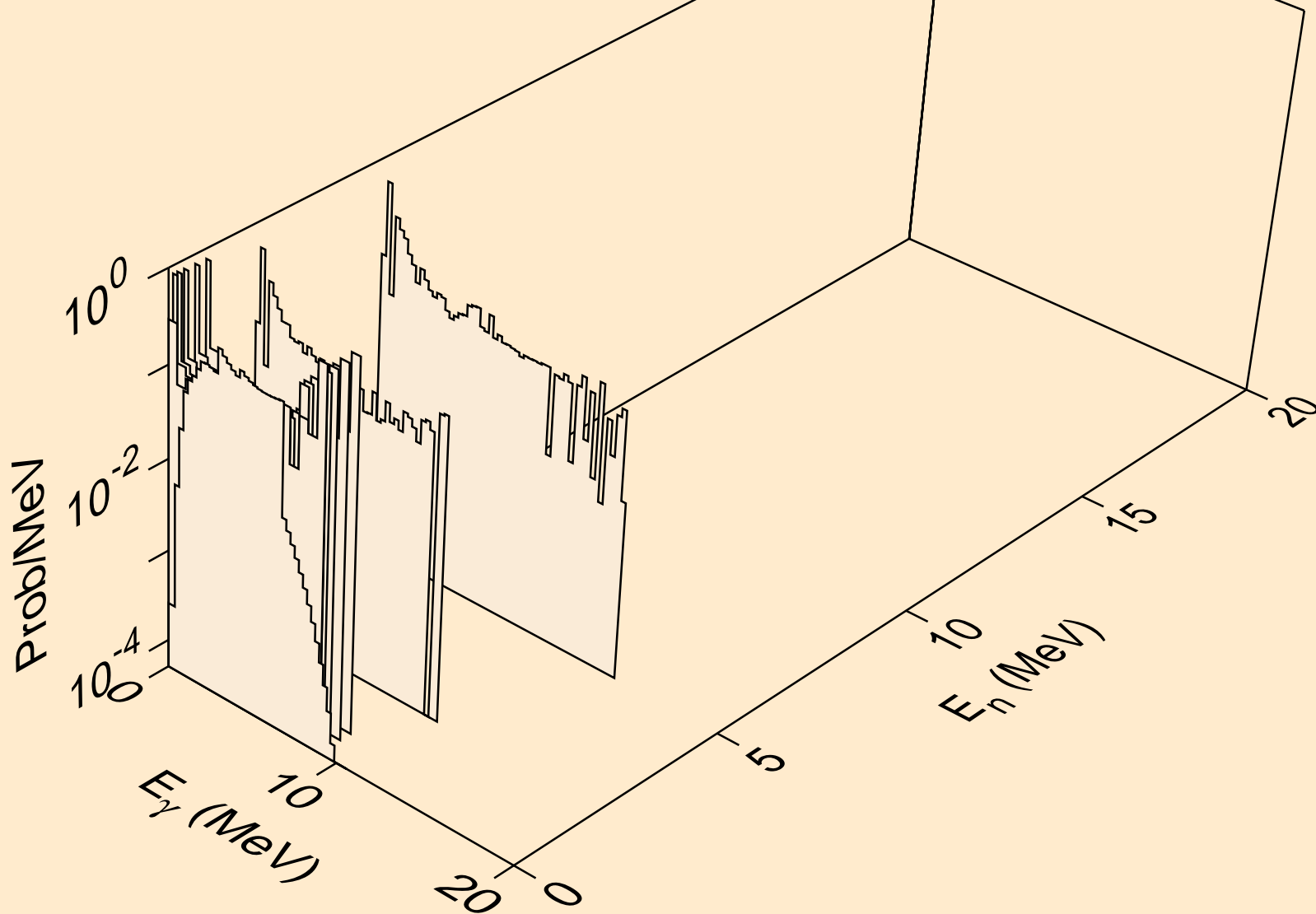

MAT=2834 ACE FILE PRODUCED AT NEA WITH NDEC
Photon emission for (n,x)

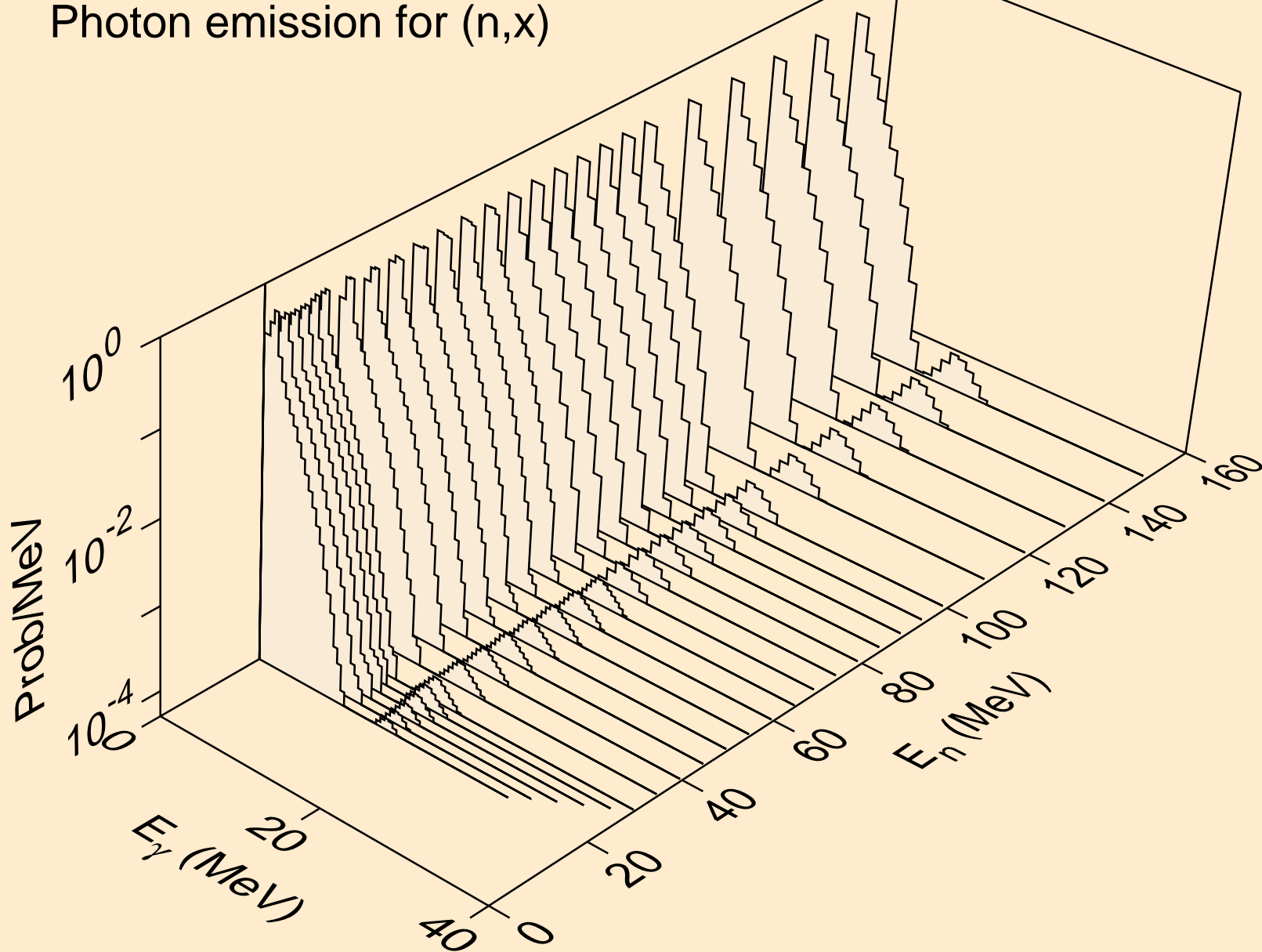

MAT=2834 ACE FILE PRODUCED AT NEA WITH NDEC
Photon emission for (n,2n)

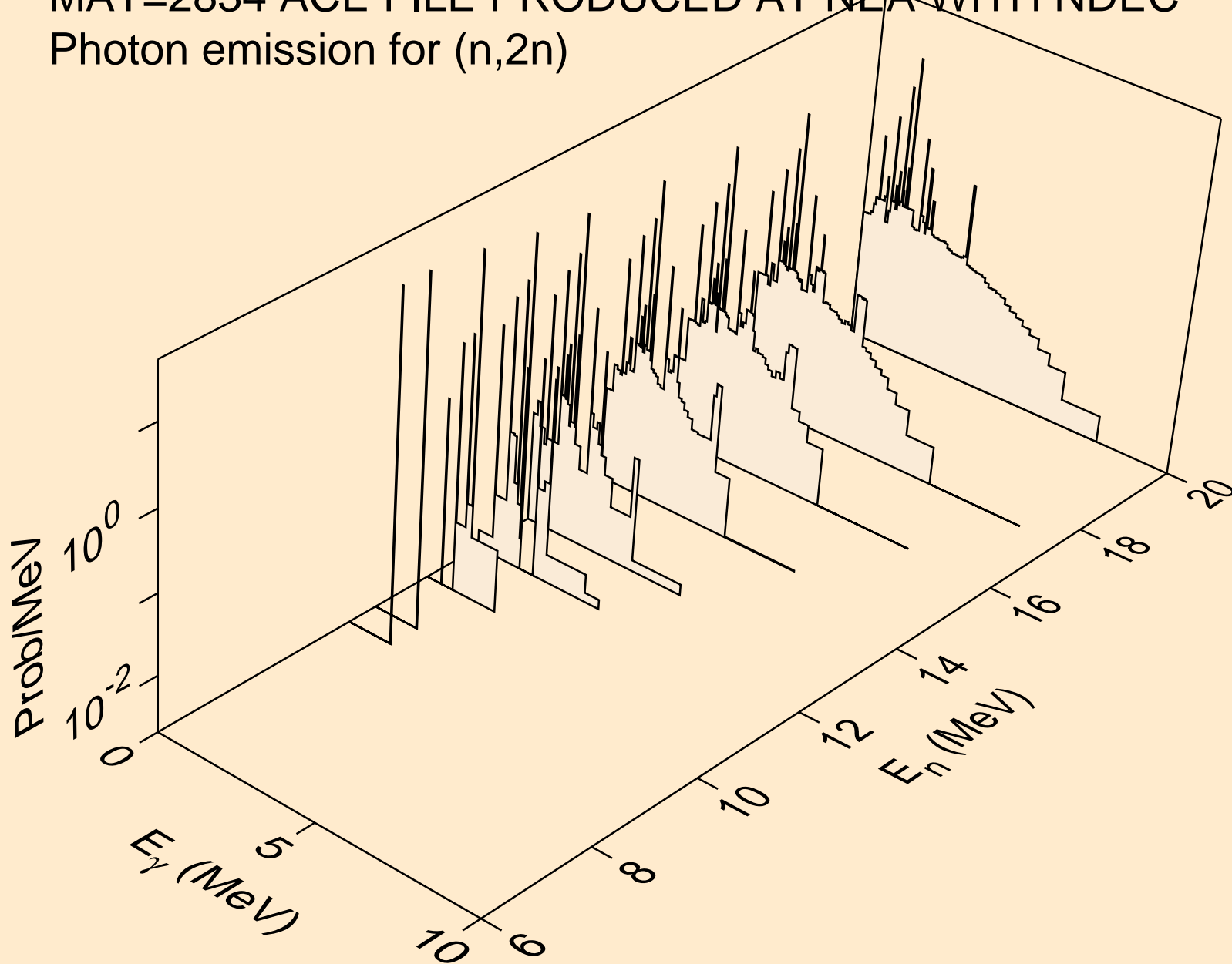

MAT=2834 ACE FILE PRODUCED AT NEA WITH NDEC
Photon emission for (n,n*)p

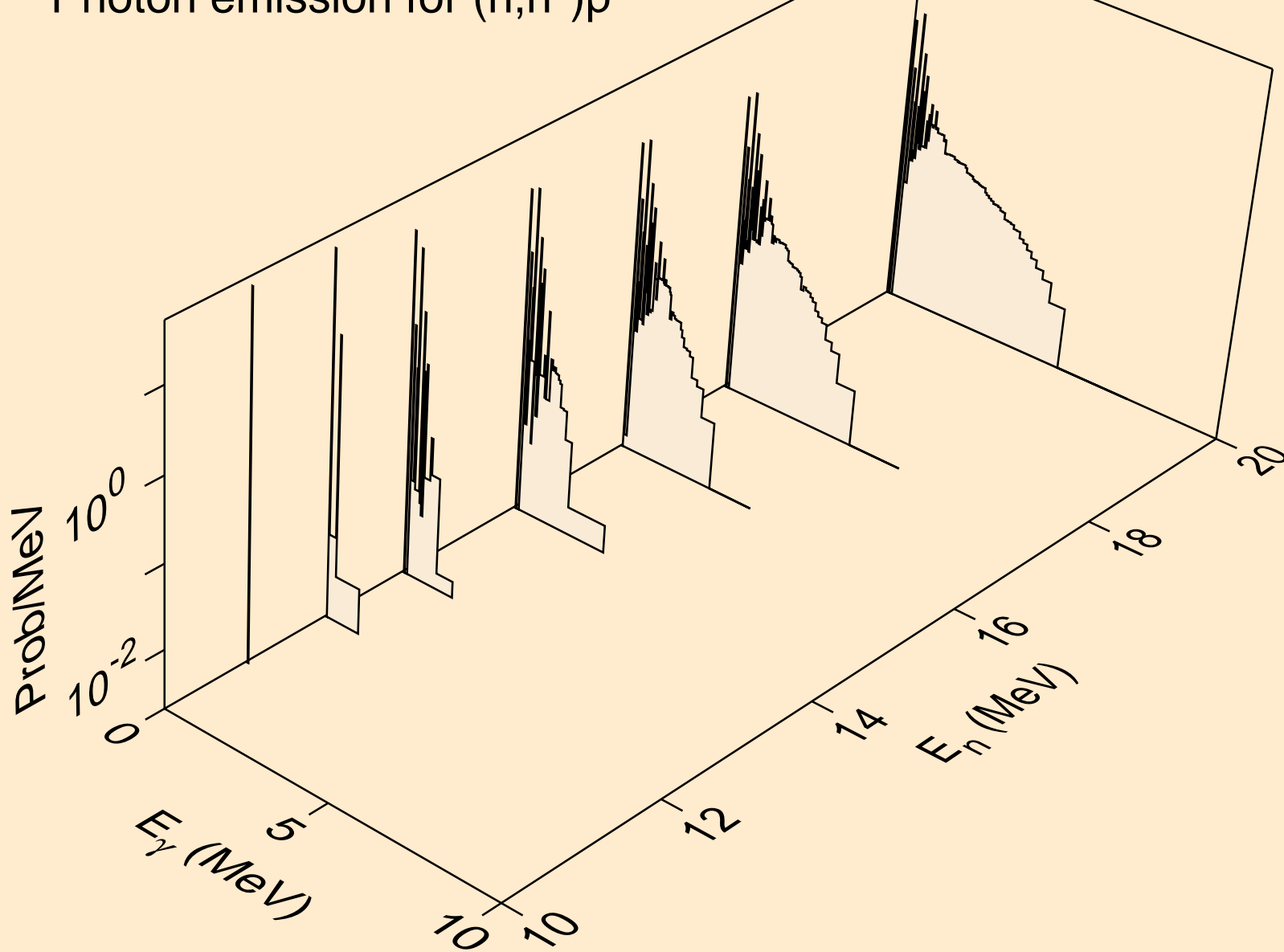

MAT=2834 ACE FILE PRODUCED AT NEA WITH NDEC
Photon emission for (n,n*c)

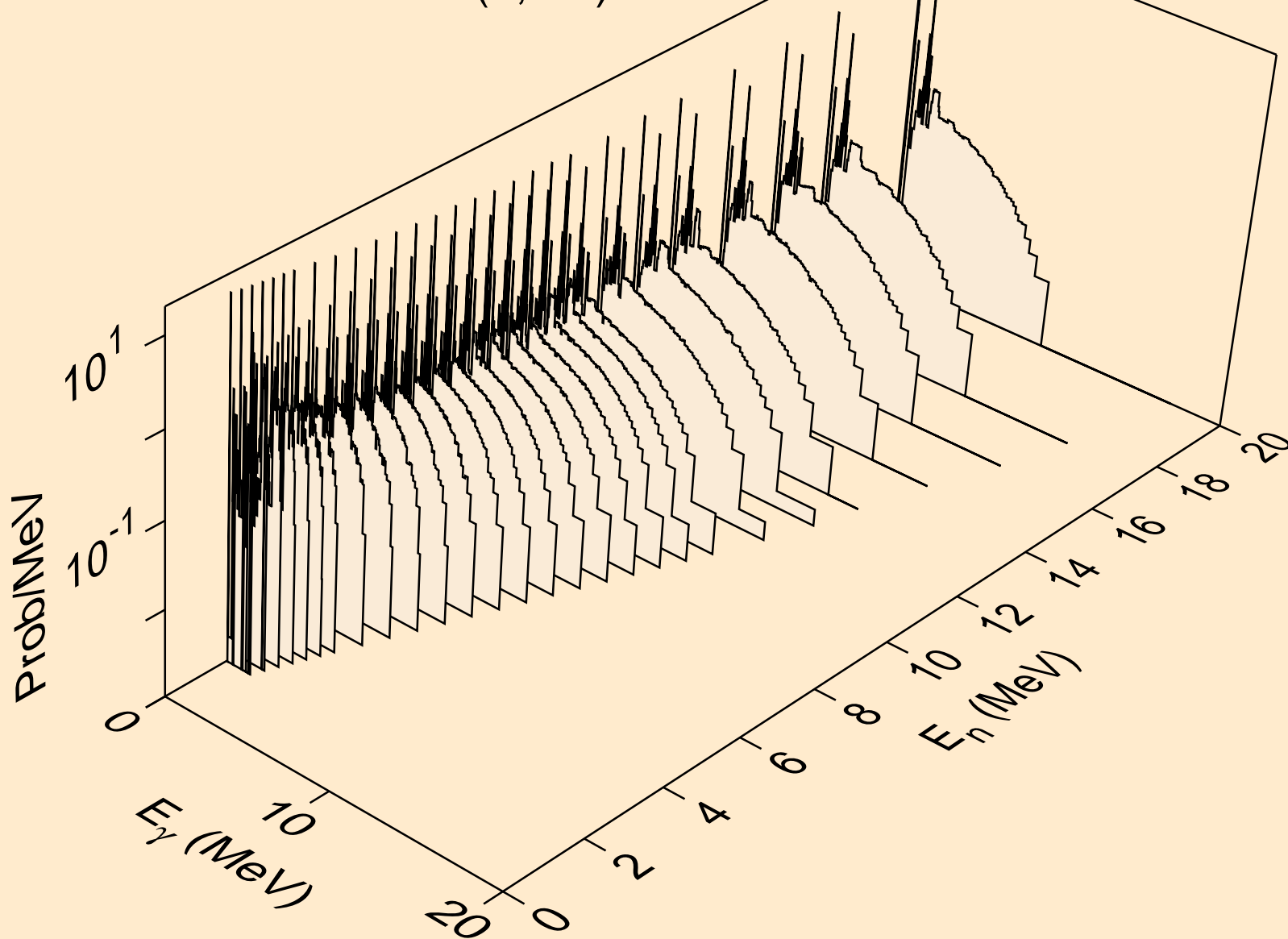

MAT=2834 ACE FILE PRODUCED AT NEA WITH NDEC
Photon emission for (n,p)

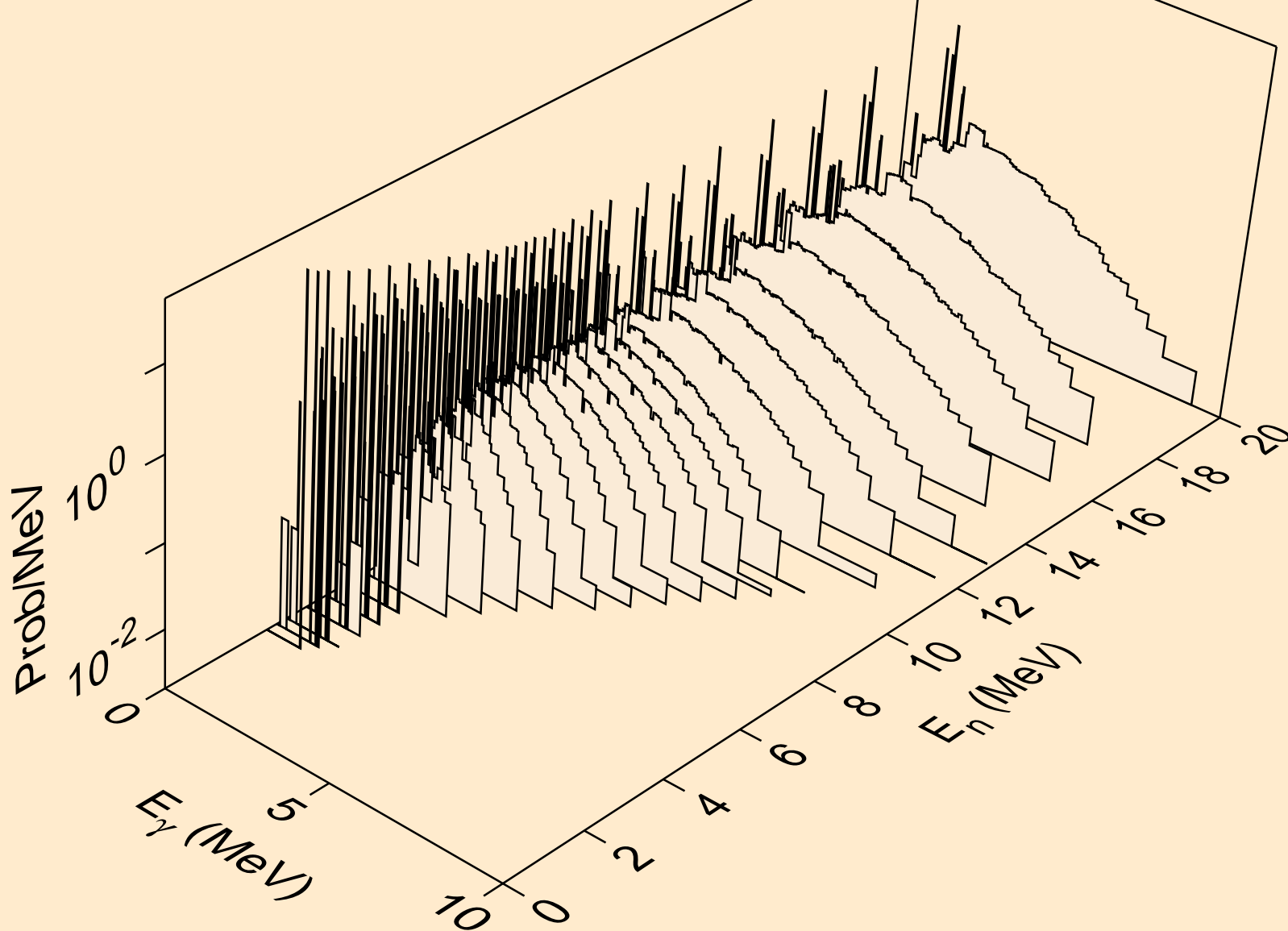

MAT=2834 ACE FILE PRODUCED AT NEA WITH NDEC
Photon emission for (n,a)

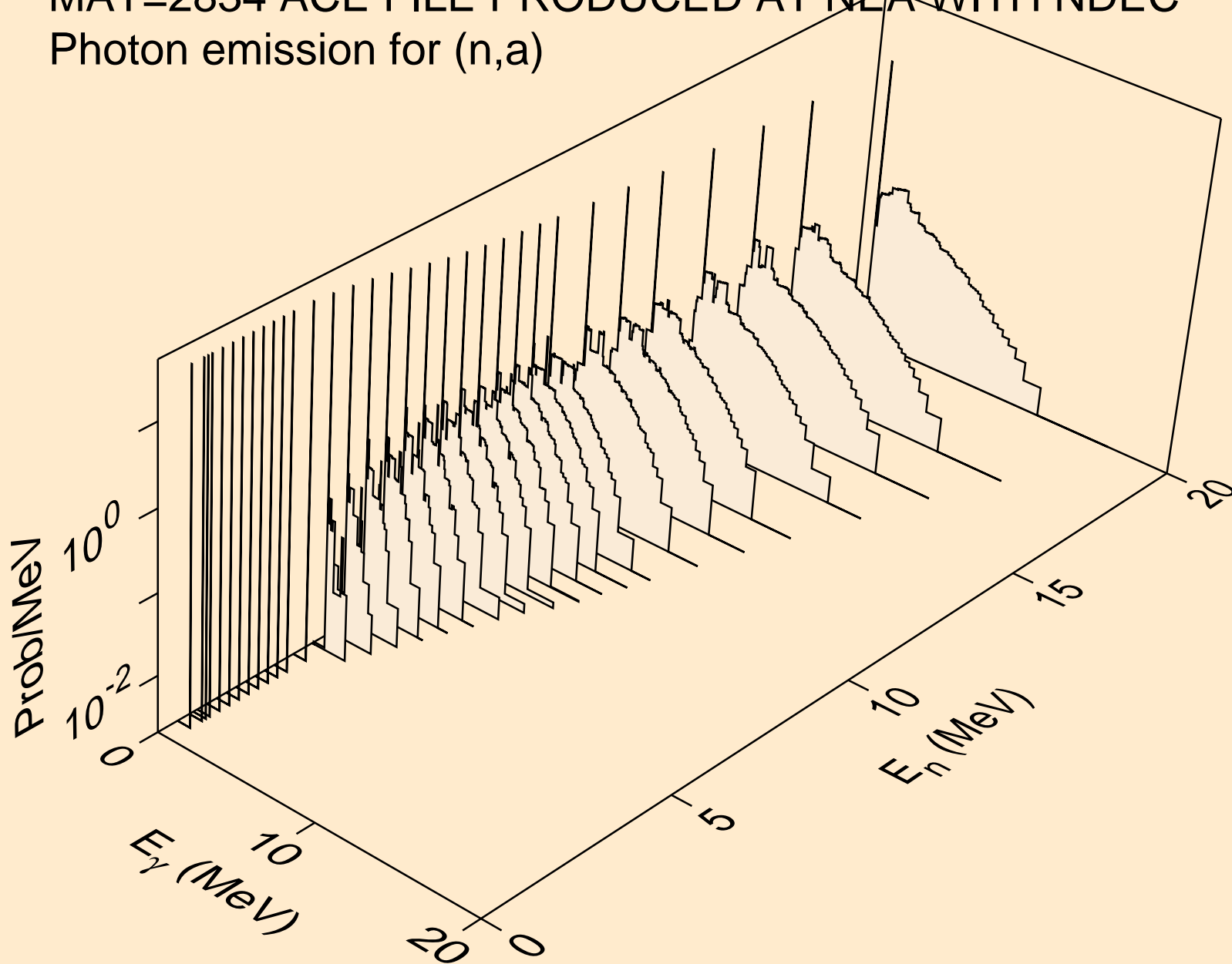

MAT=2834 ACE FILE PRODUCED AT NEA WITH NDEC
thermal capture photon spectrum

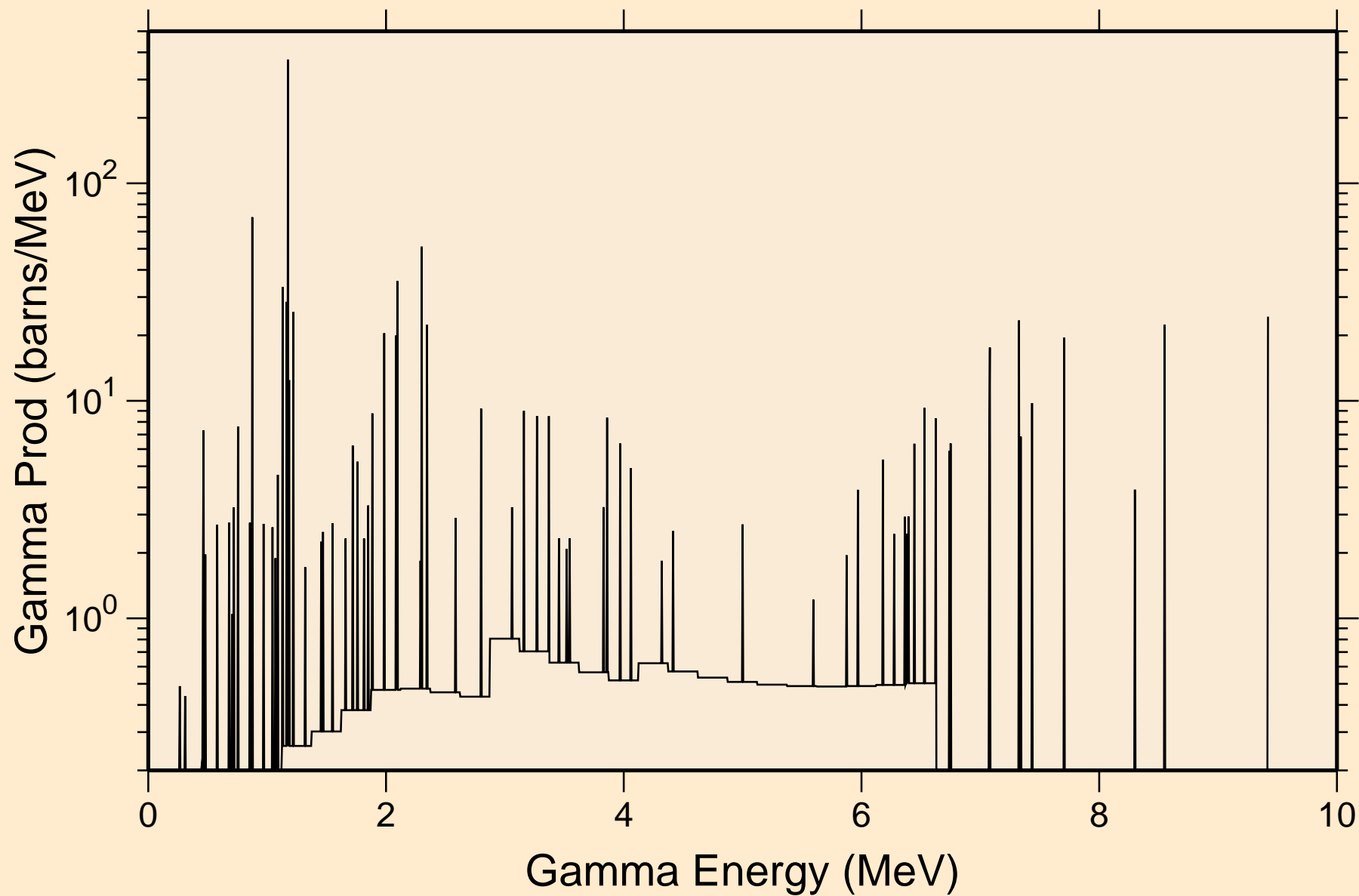

MAT=2834 ACE FILE PRODUCED AT NEA WITH NDEC
14 MeV photon spectrum

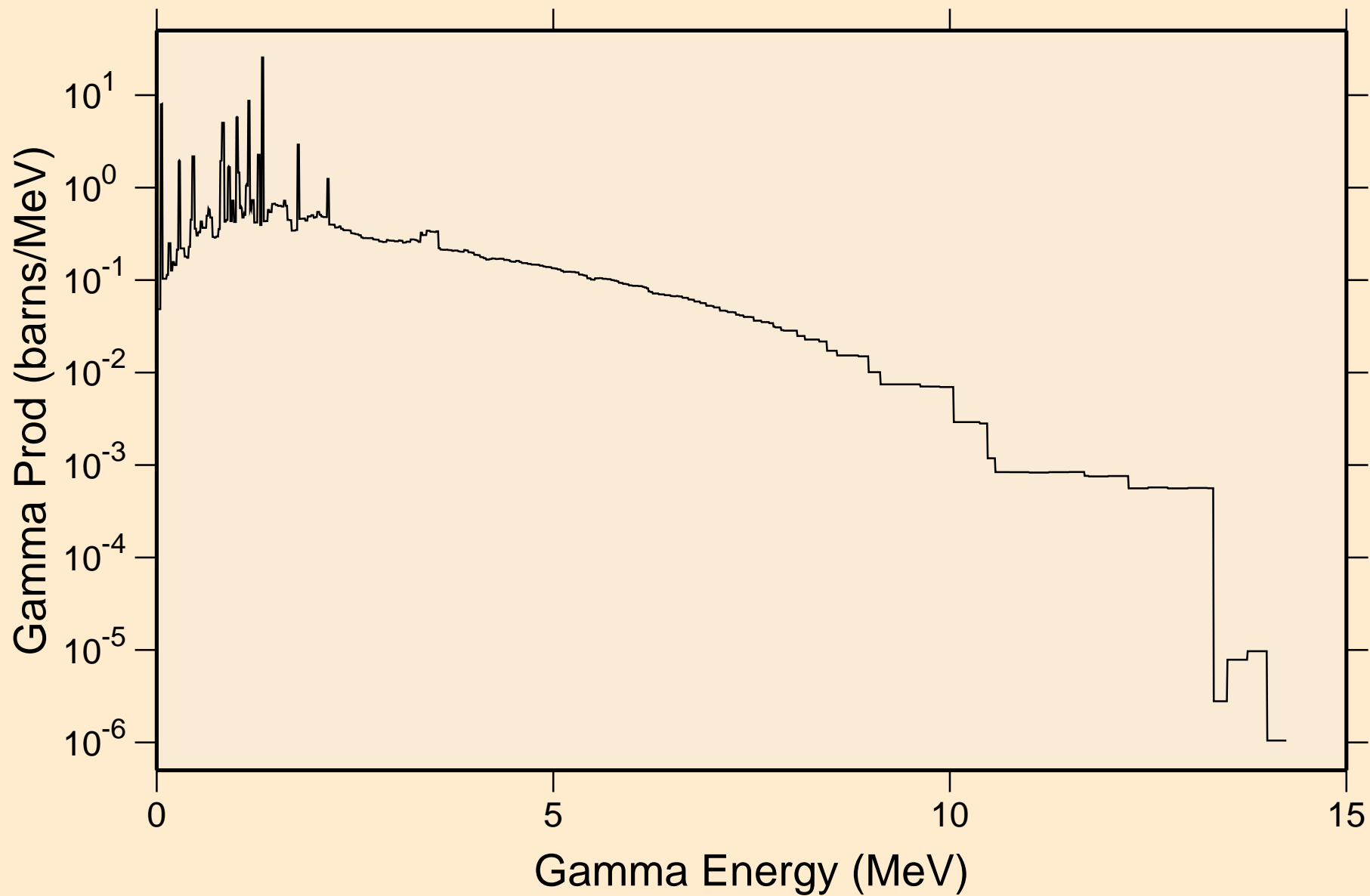

MAT=2834 ACE FILE PRODUCED AT NEA WITH NDEC
Particle heating contributions

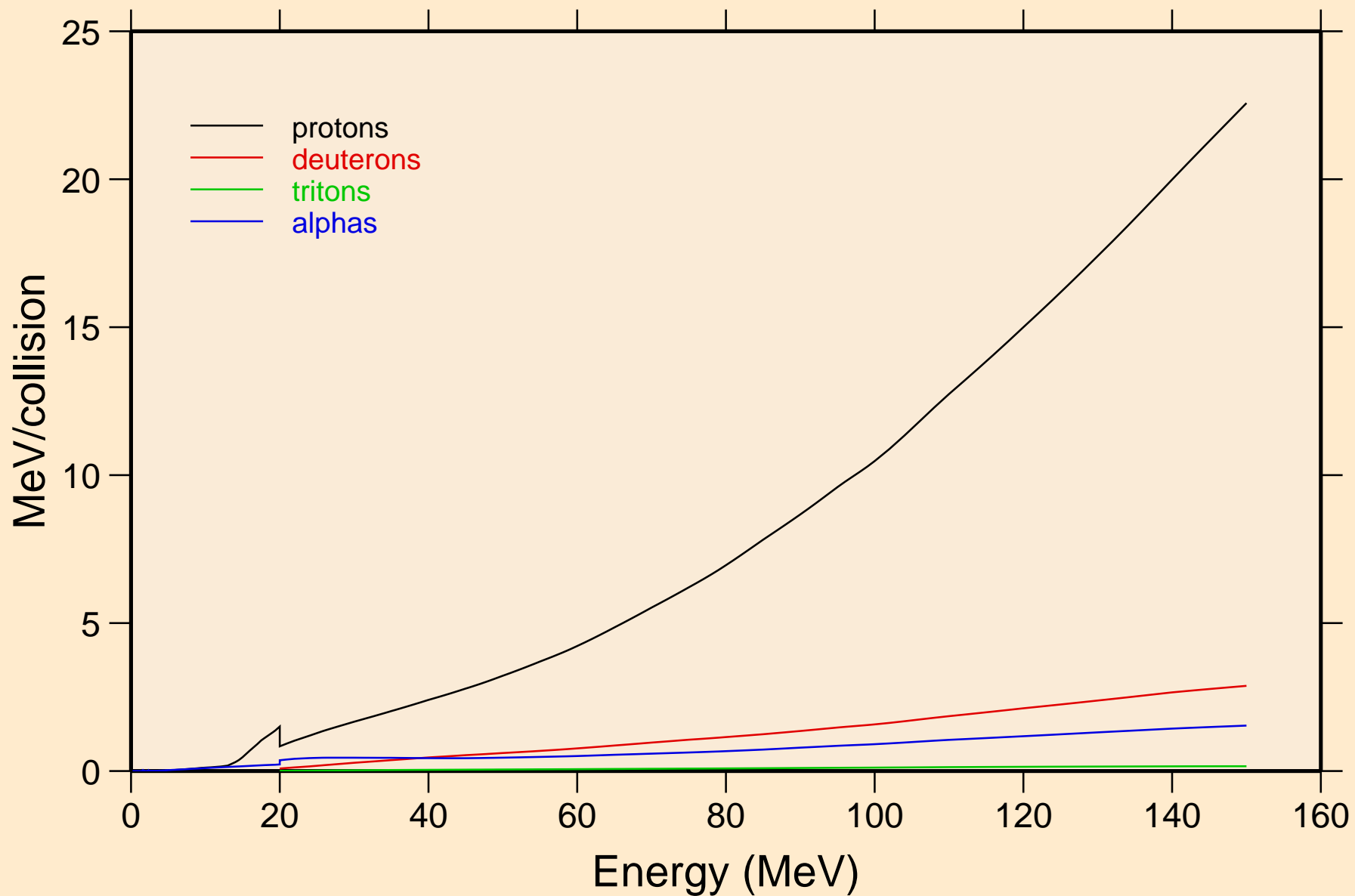

MAT=2834 ACE FILE PRODUCED AT NEA WITH NDEC
Recoil Heating

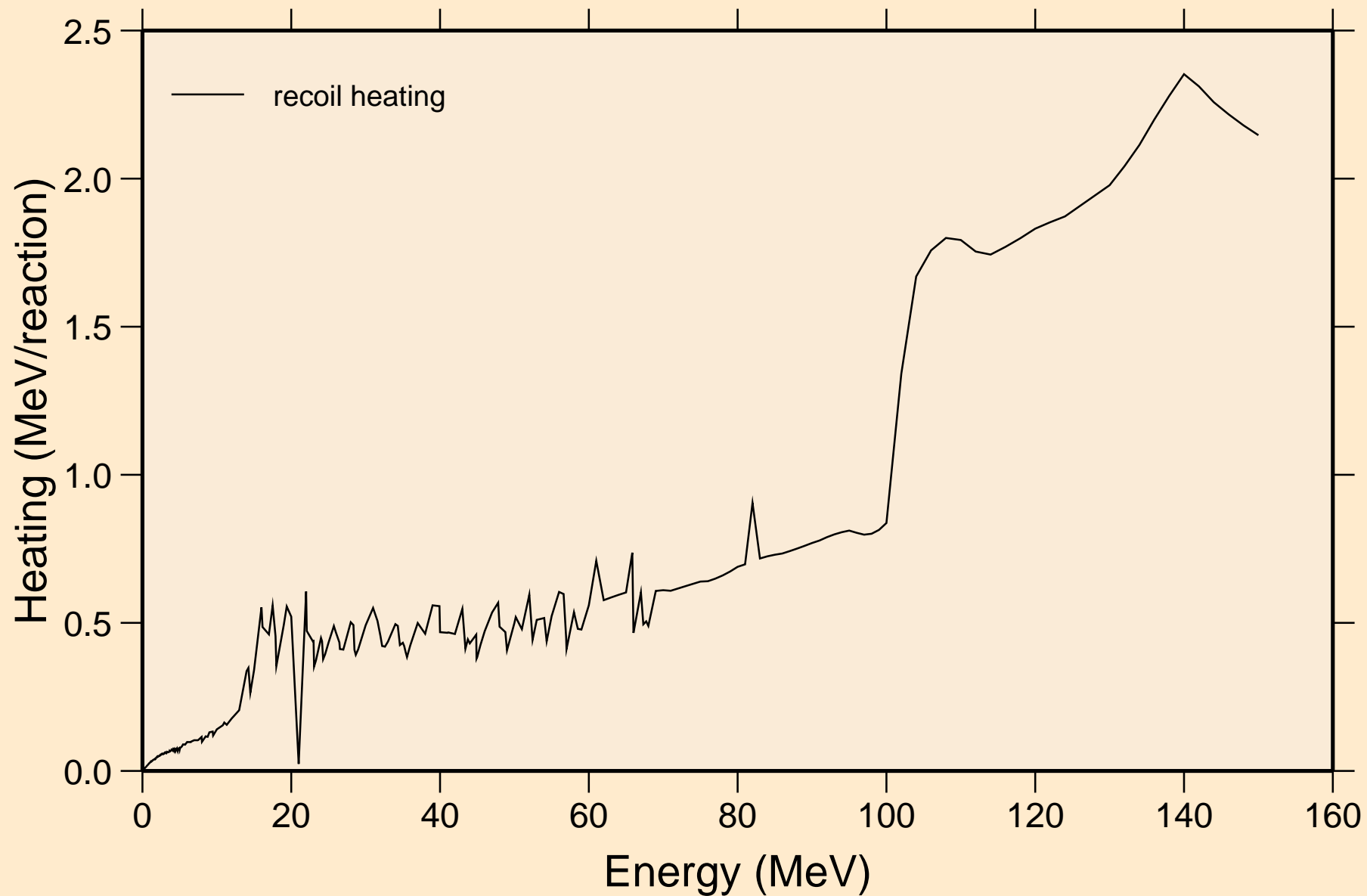

MAT=2834 ACE FILE PRODUCED AT NEA WITH NDEC
Particle production cross sections

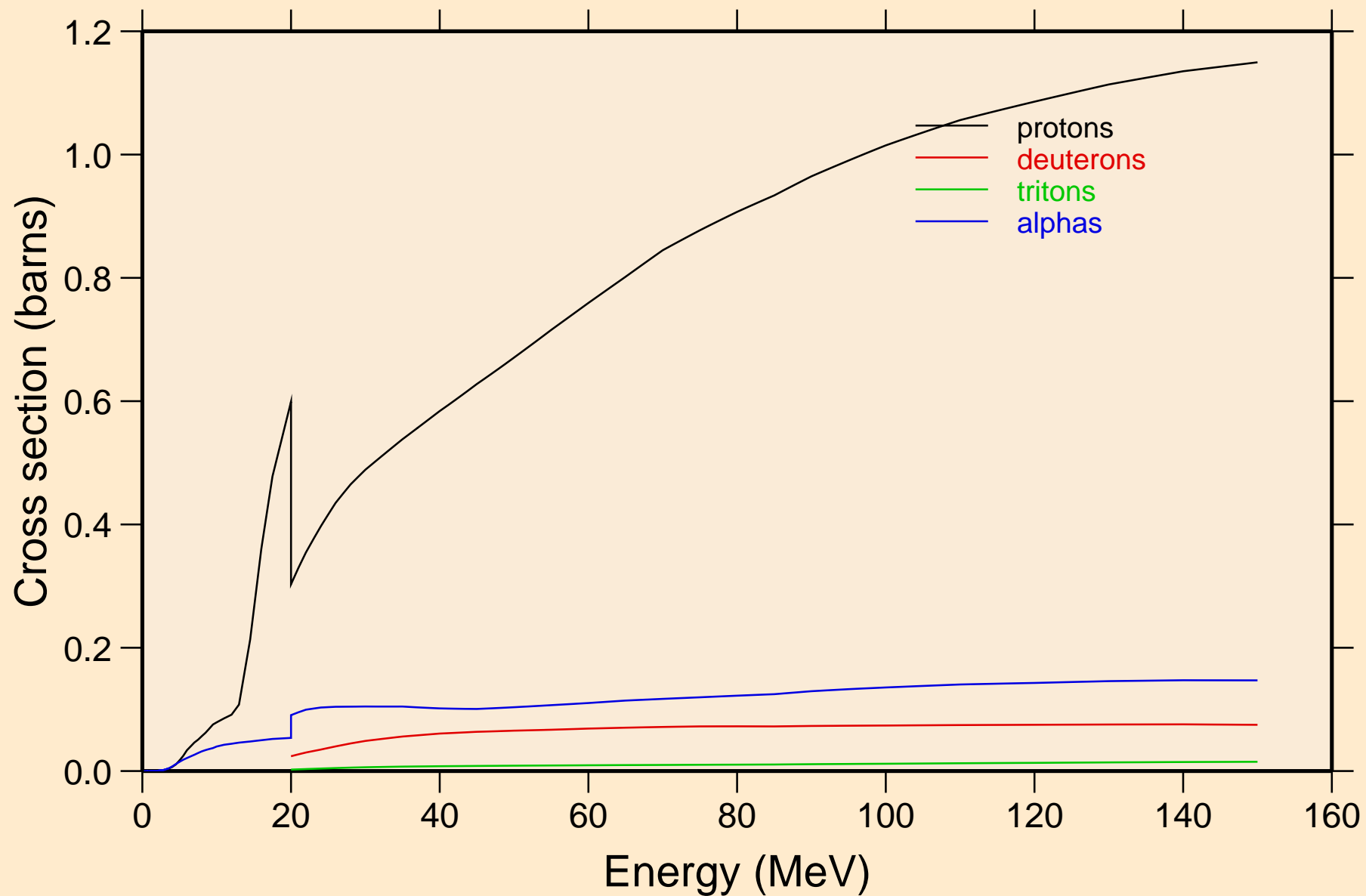

MAT=2834 ACE FILE PRODUCED AT NEA WITH NDEC
protons from (n,x)

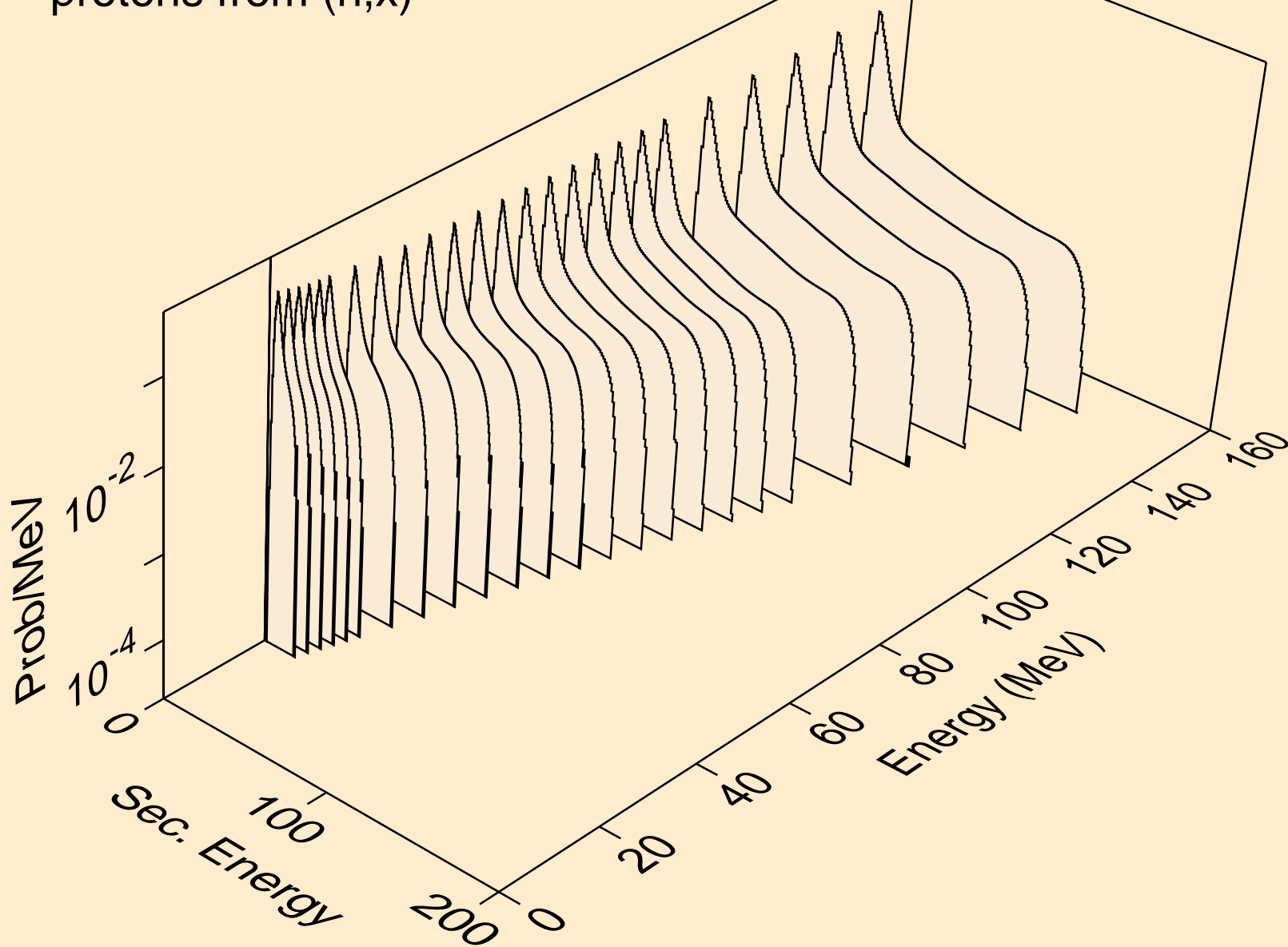

MAT=2834 ACE FILE PRODUCED AT NEA WITH NDEC
protons from (n,n*)p

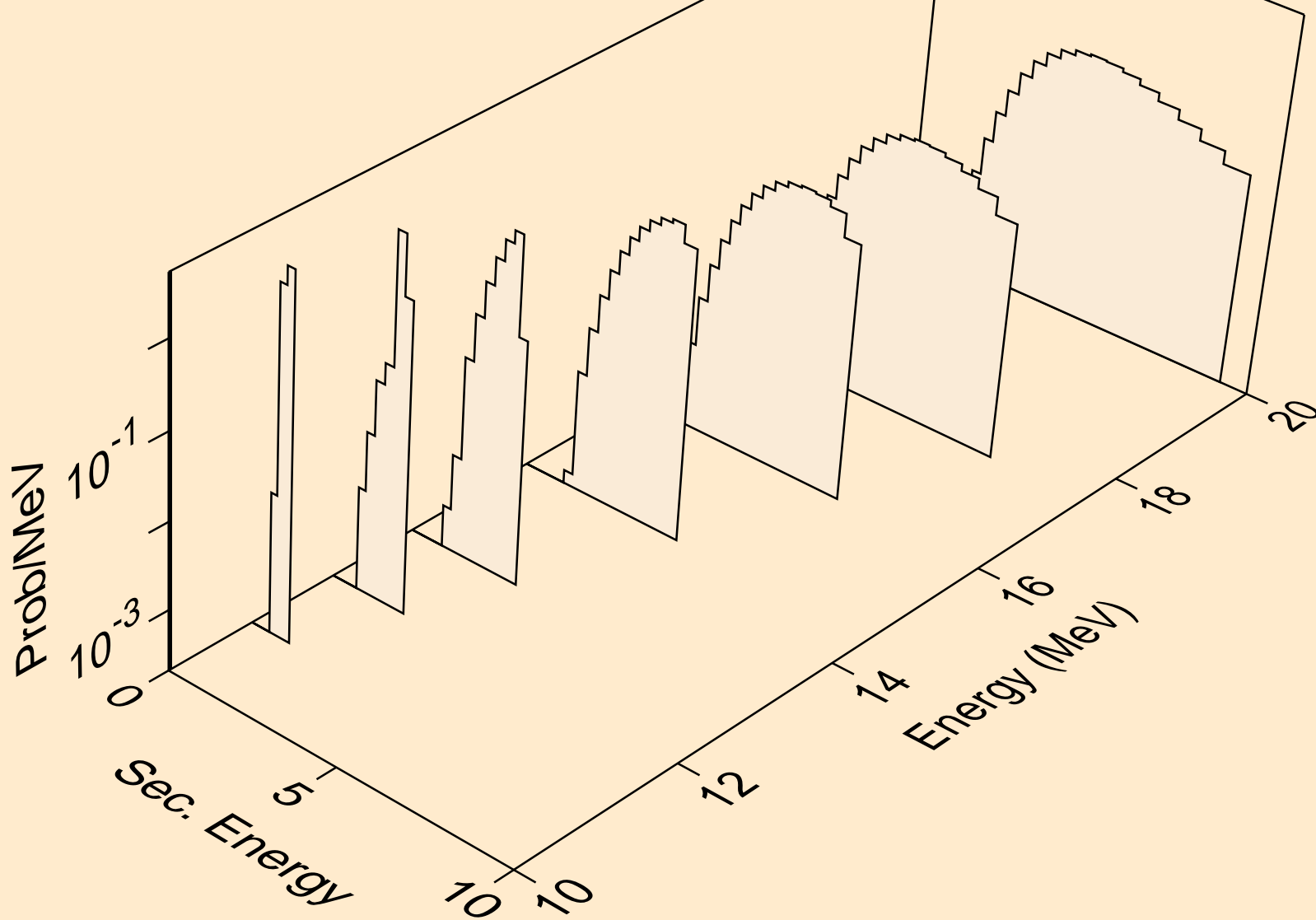

MAT=2834 ACE FILE PRODUCED AT NEA WITH NDEC
protons from (n,p)

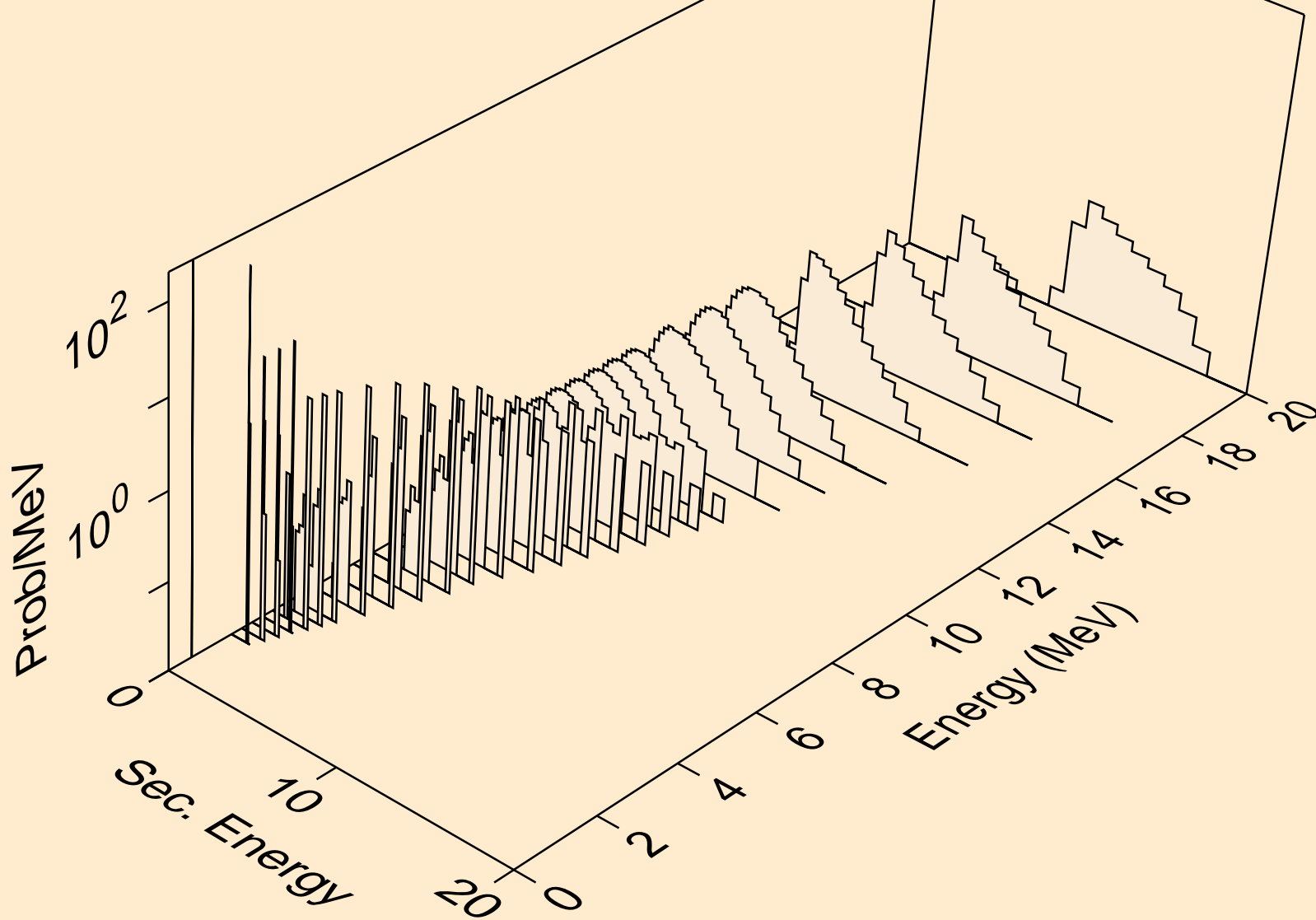

MAT=2834 ACE FILE PRODUCED AT NEA WITH NDEC
deuterons from (n,x)

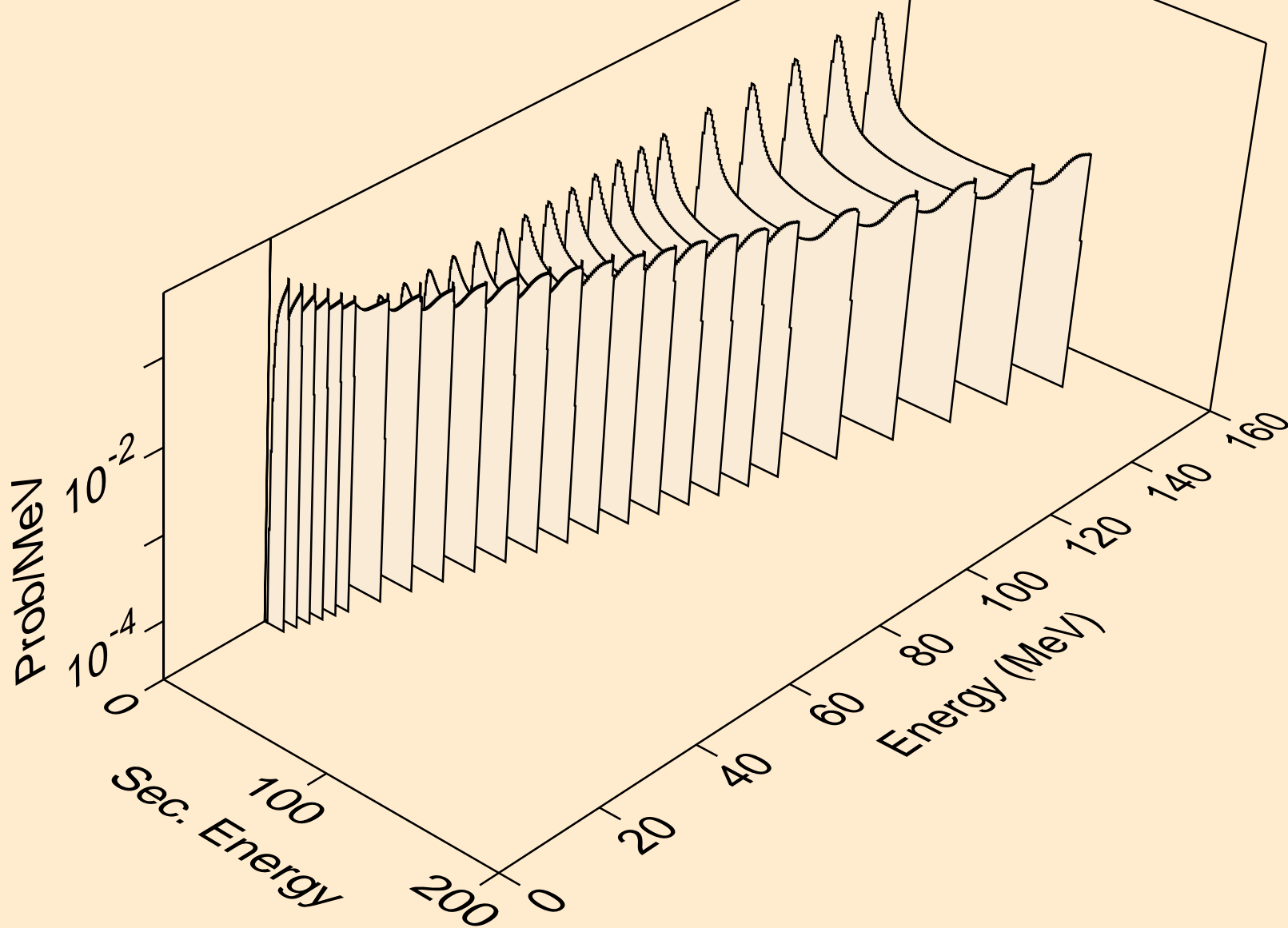

MAT=2834 ACE FILE PRODUCED AT NEA WITH NDEC
tritons from (n,x)

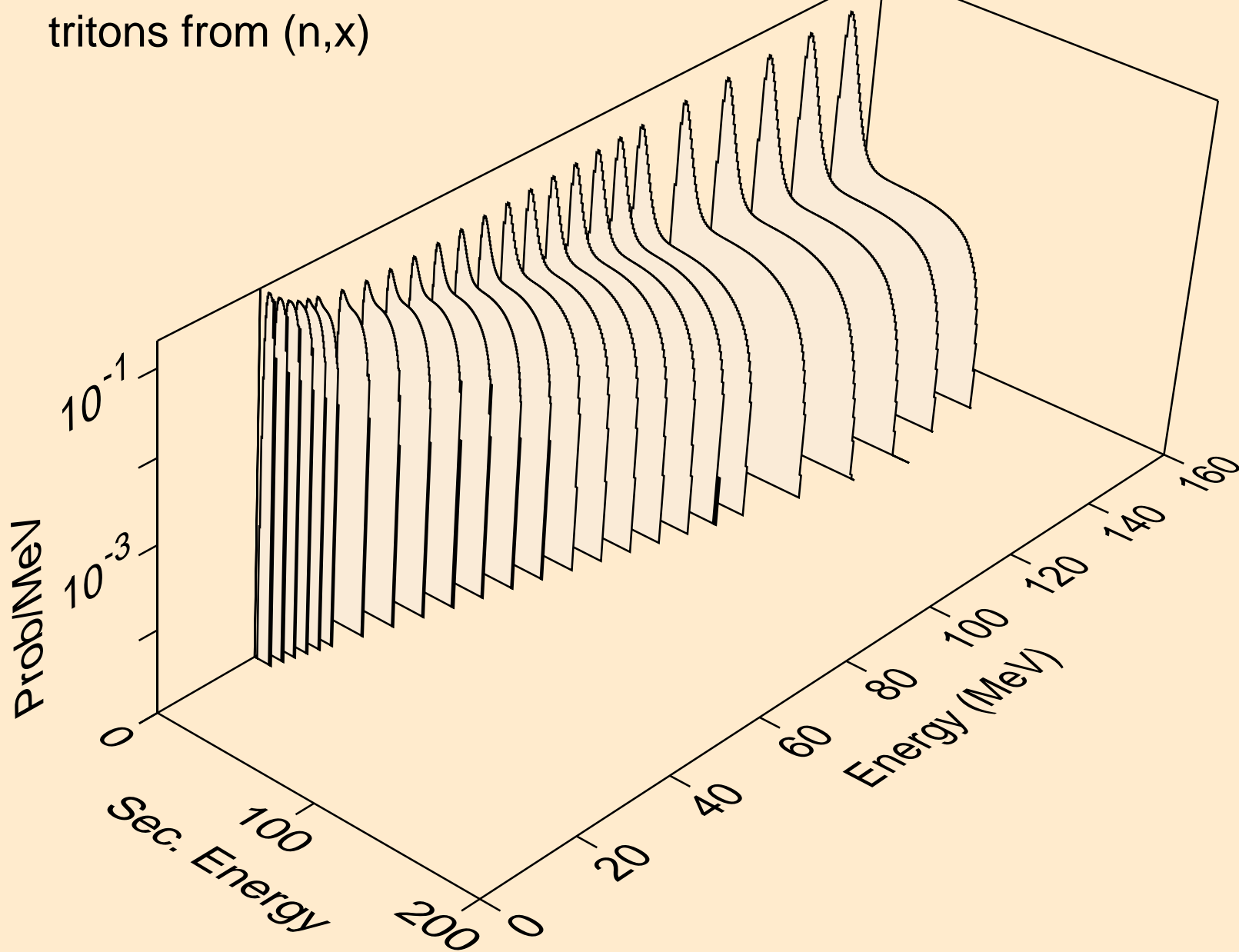

MAT=2834 ACE FILE PRODUCED AT NEA WITH NDEC
alphas from (n,x)

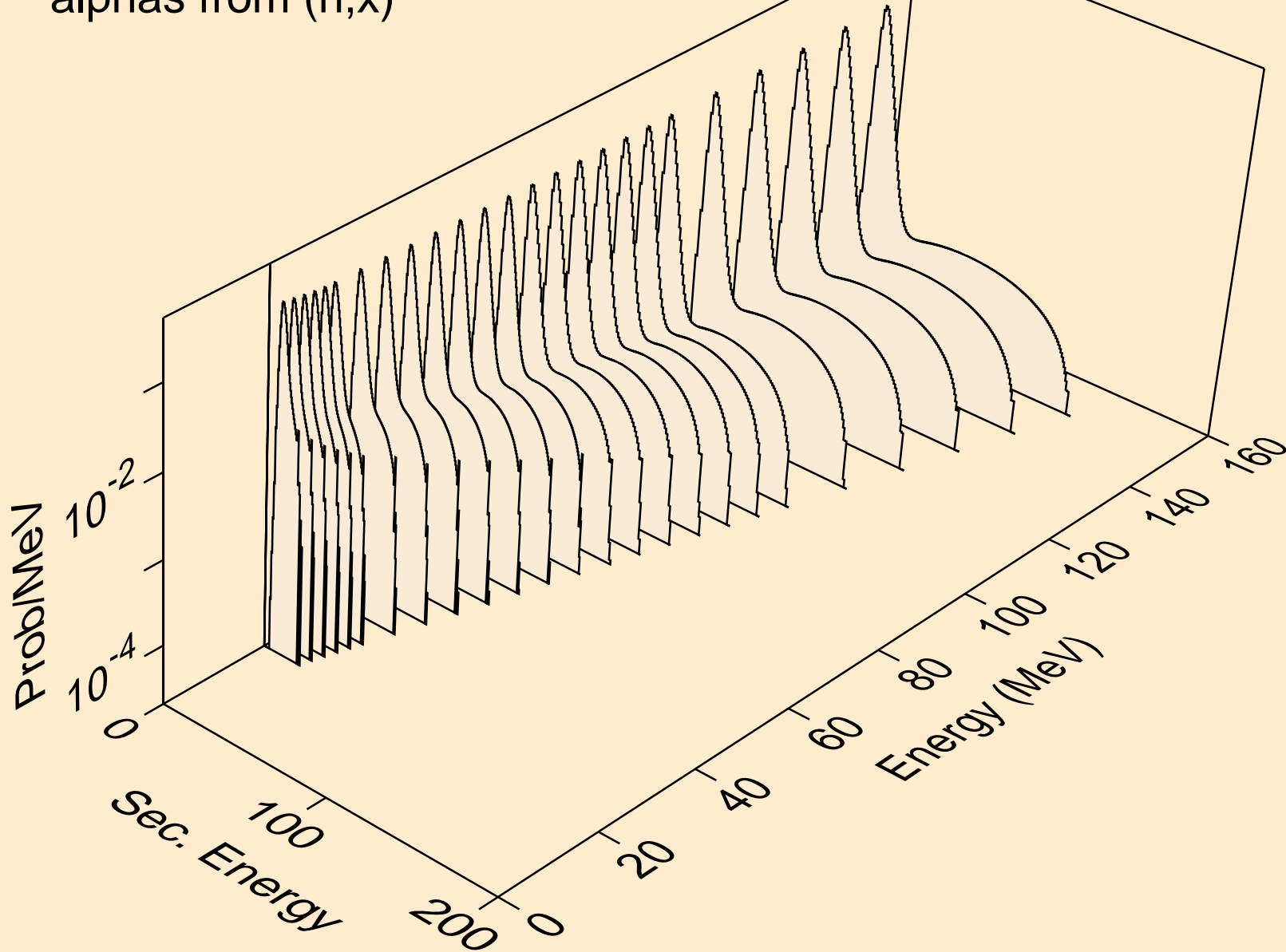

MAT=2834 ACE FILE PRODUCED AT NEA WITH NDEC
alphas from (n,a)

