

MAT=2437 ACE FILE PRODUCED AT NEA WITH NDEC  
Principal cross sections

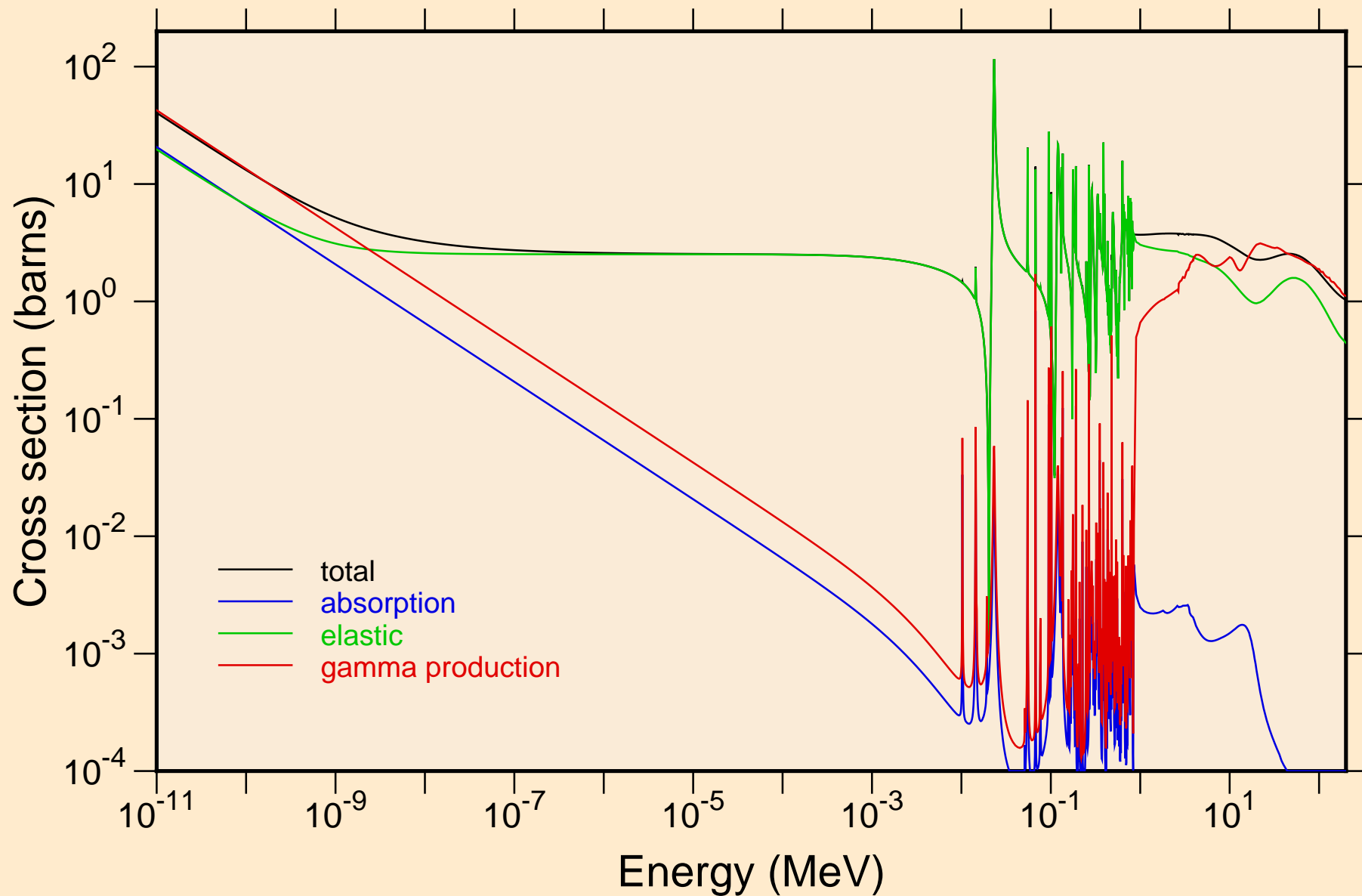

MAT=2437 ACE FILE PRODUCED AT NEA WITH NDEC  
resonance total cross section

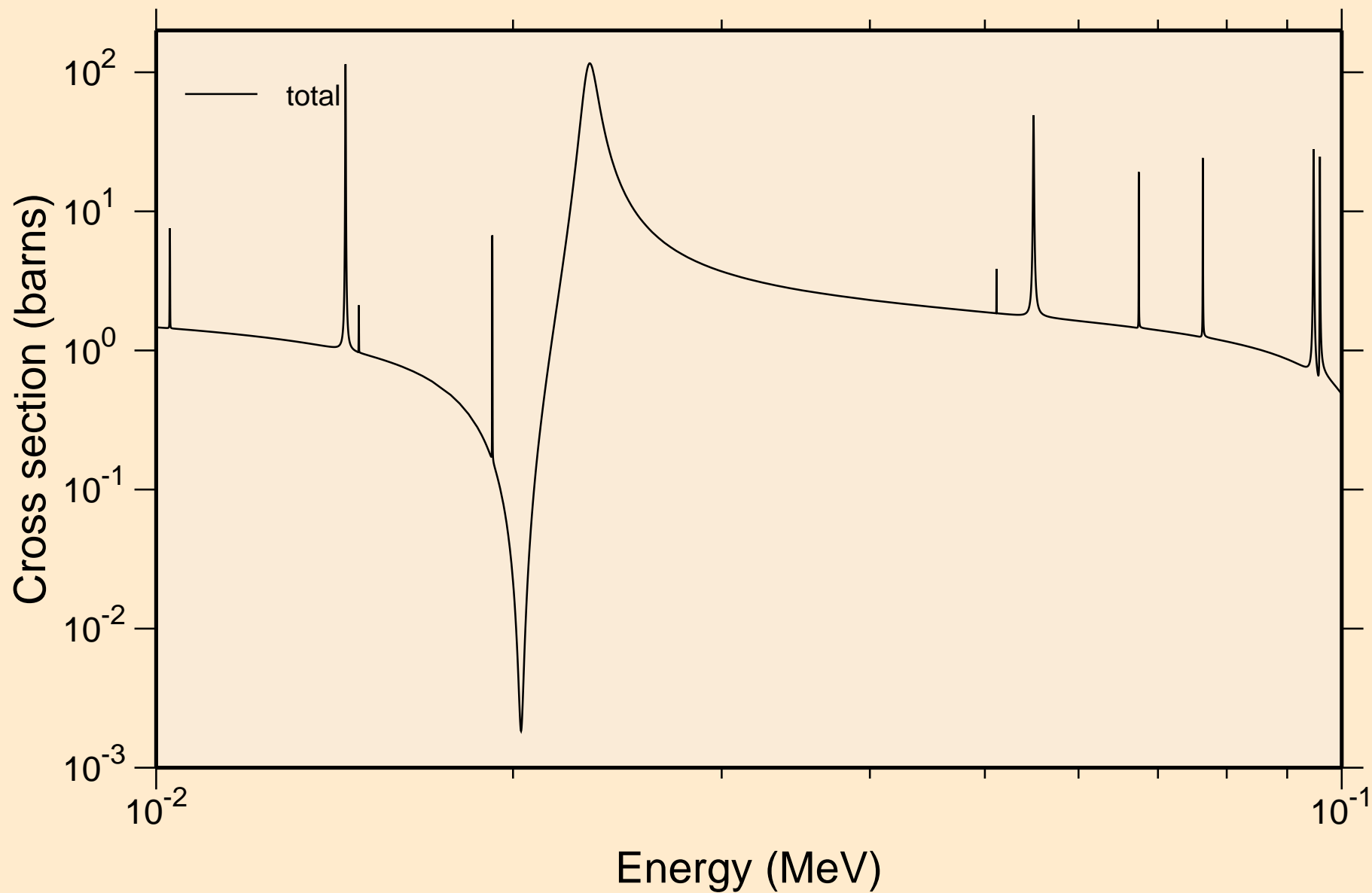

MAT=2437 ACE FILE PRODUCED AT NEA WITH NDEC  
resonance total cross section

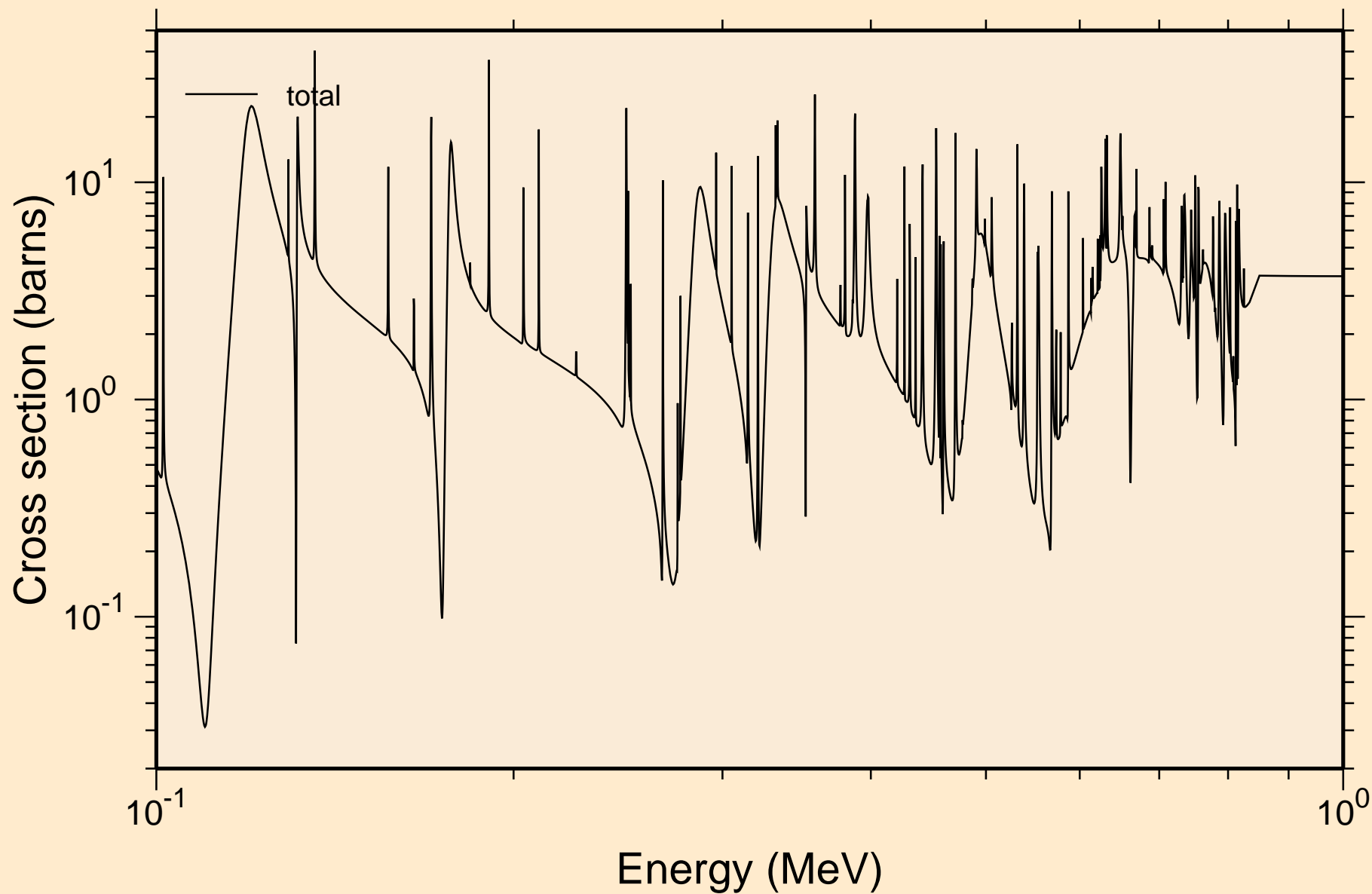

MAT=2437 ACE FILE PRODUCED AT NEA WITH NDEC  
resonance absorption cross sections

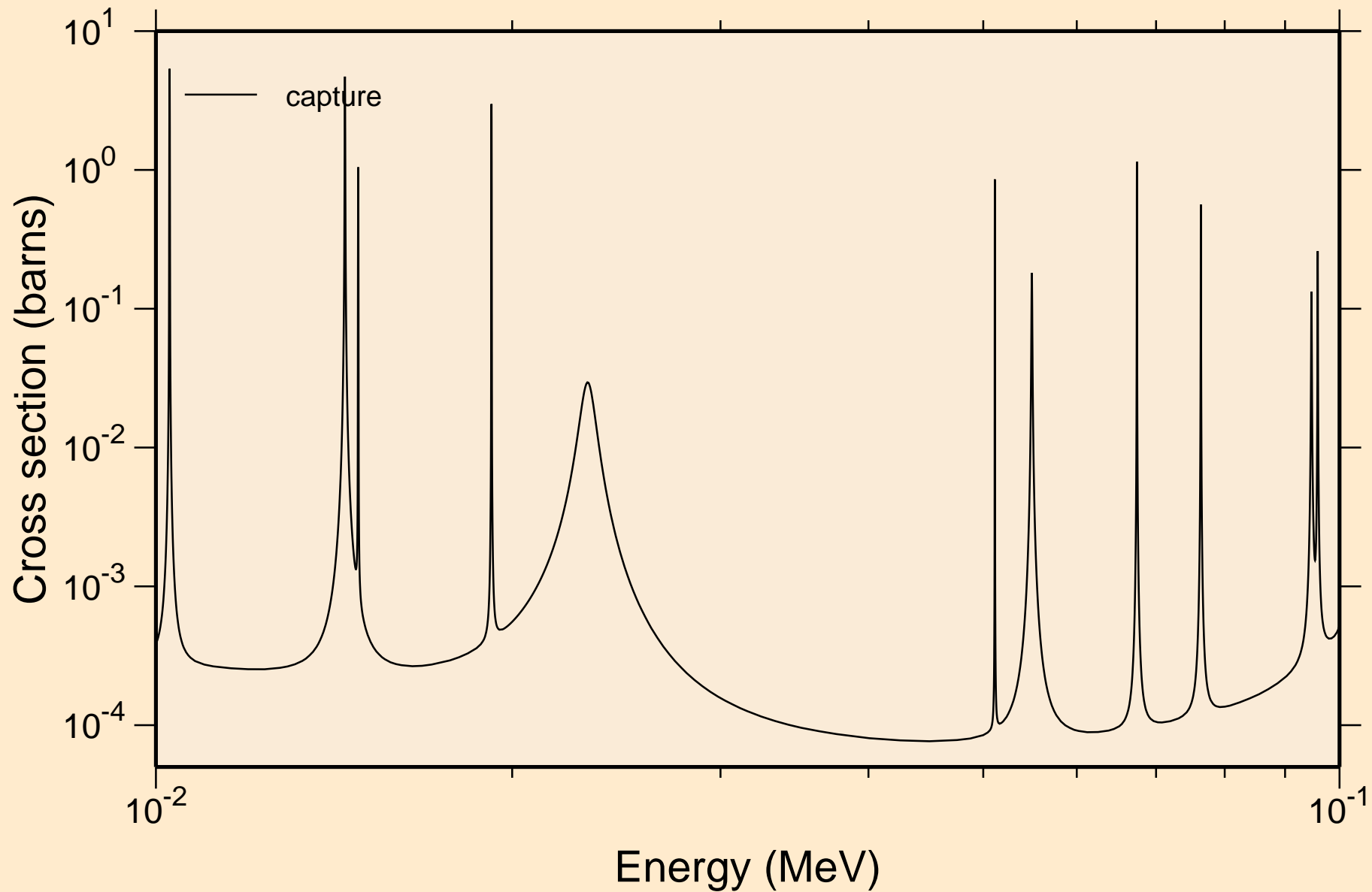

MAT=2437 ACE FILE PRODUCED AT NEA WITH NDEC  
resonance absorption cross sections

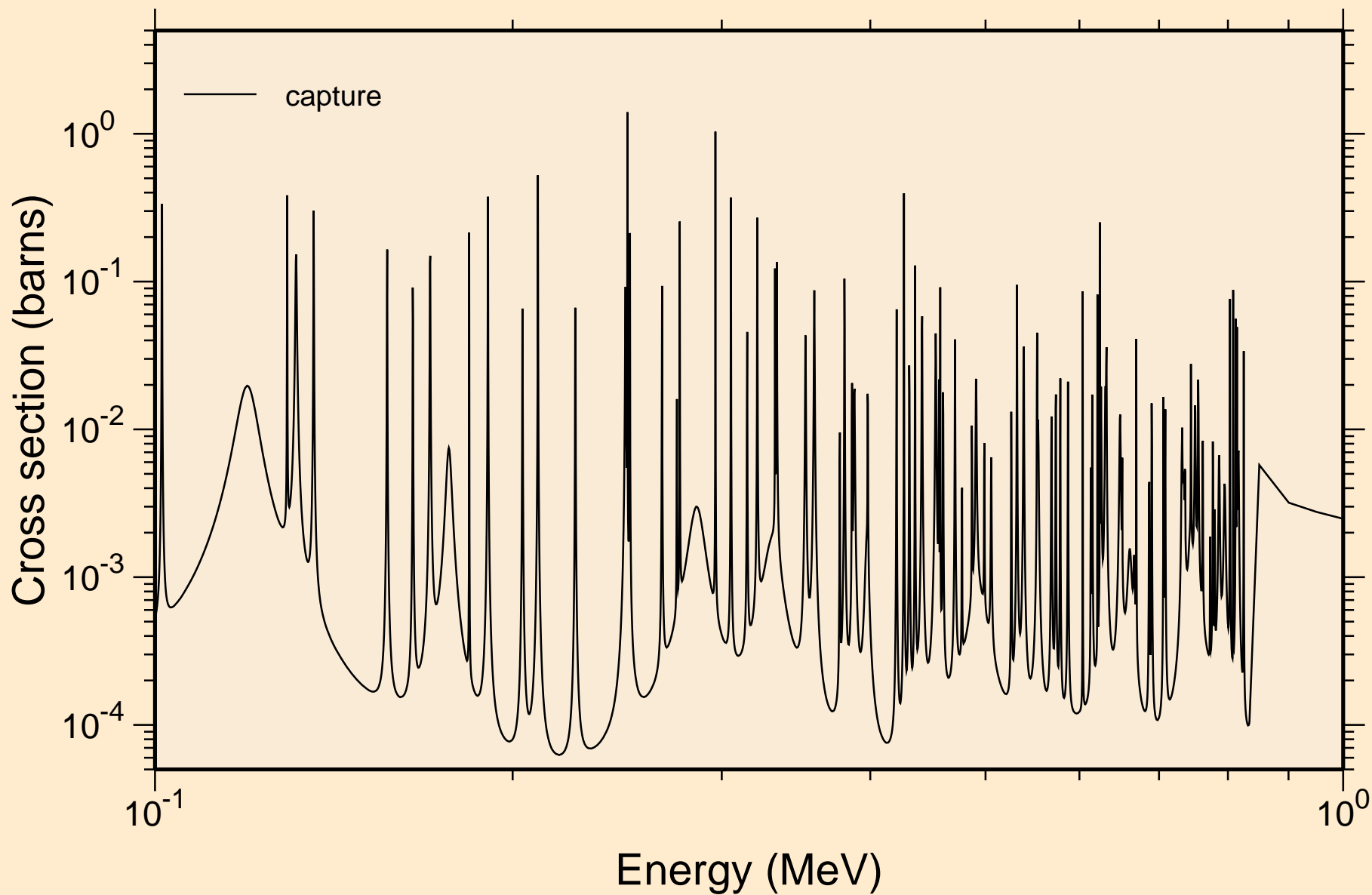

MAT=2437 ACE FILE PRODUCED AT NEA WITH NDEC  
Heating

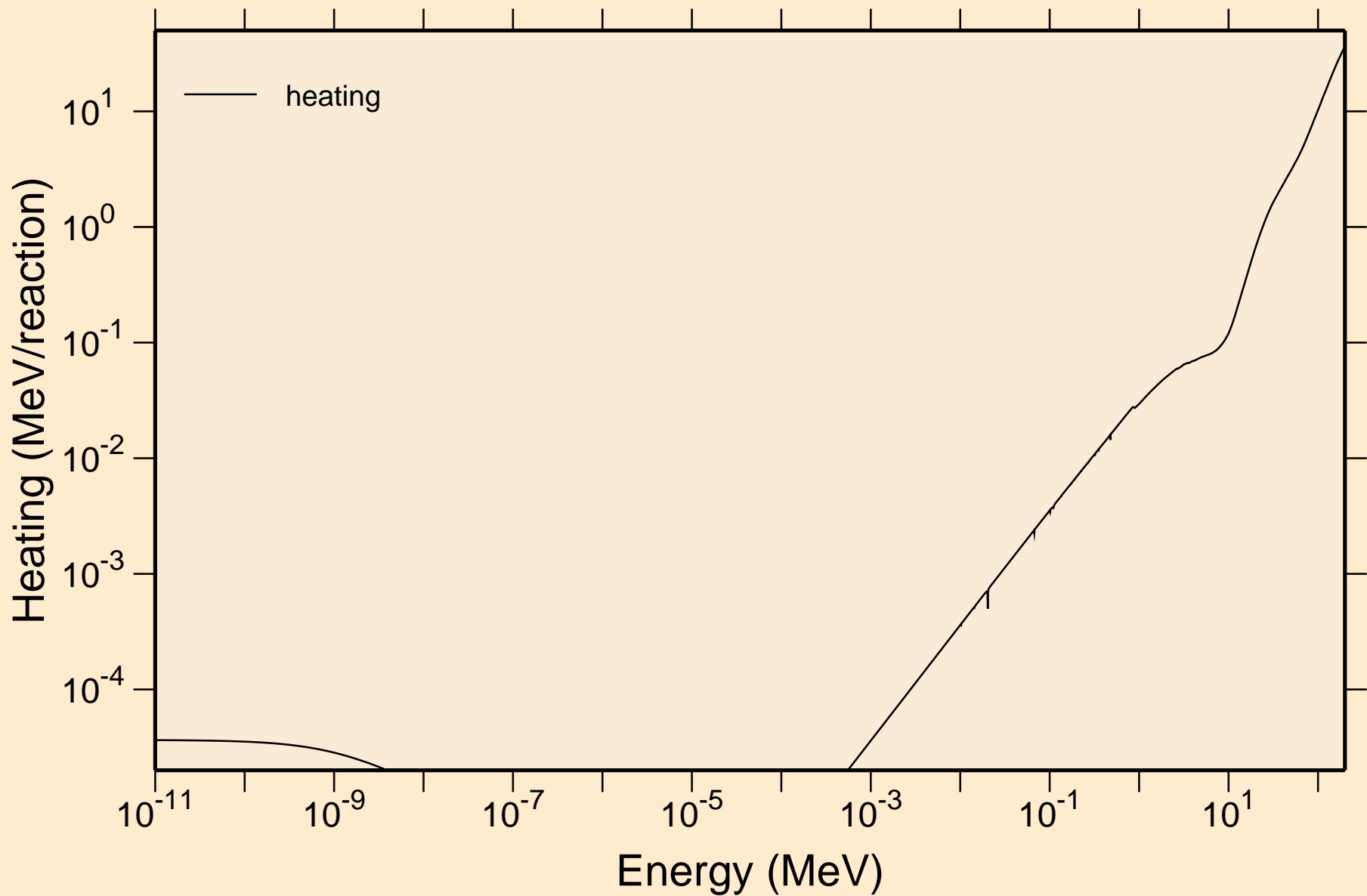

MAT=2437 ACE FILE PRODUCED AT NEA WITH NDEC  
Damage

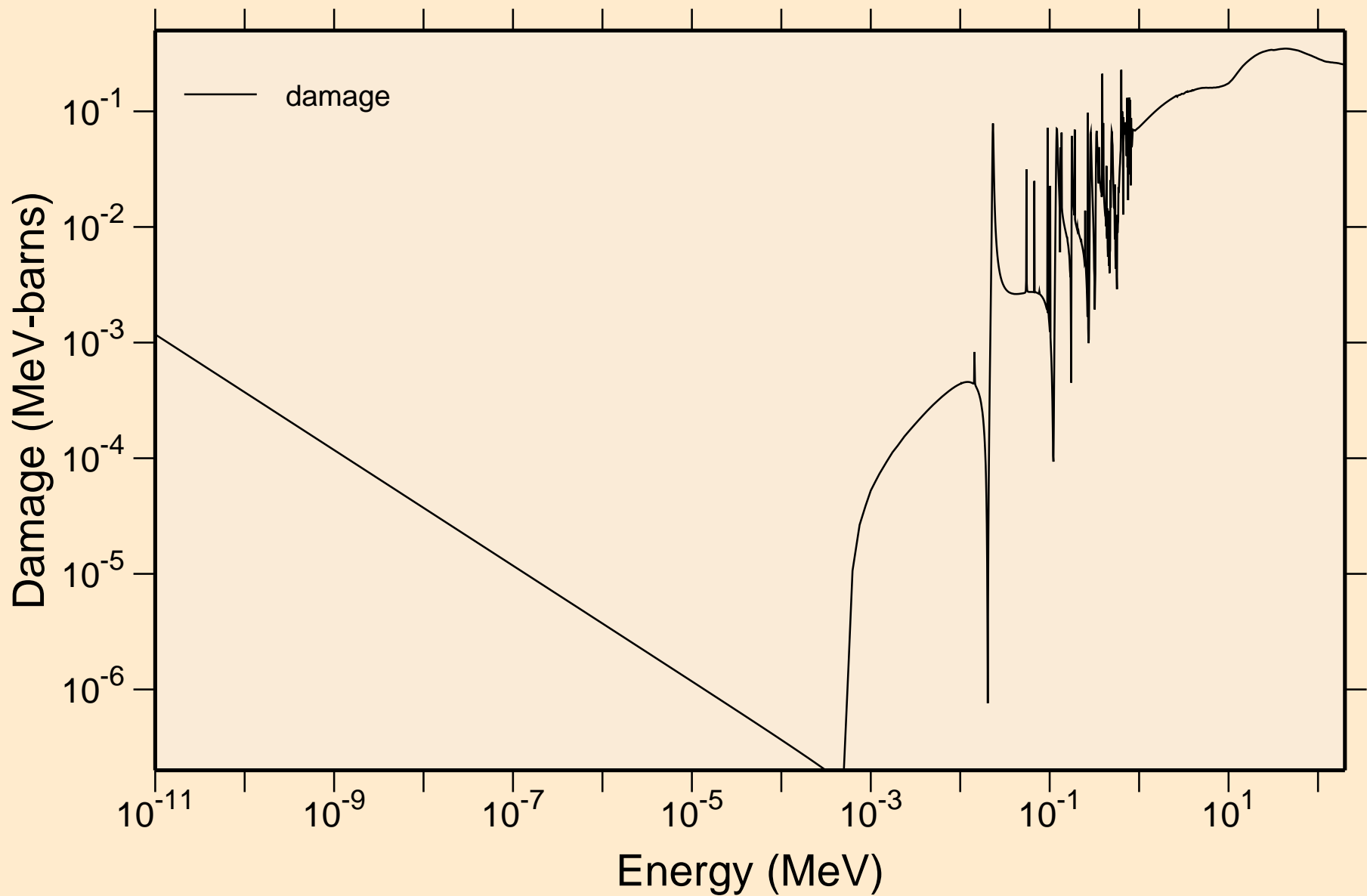

MAT=2437 ACE FILE PRODUCED AT NEA WITH NDEC  
Non-threshold reactions

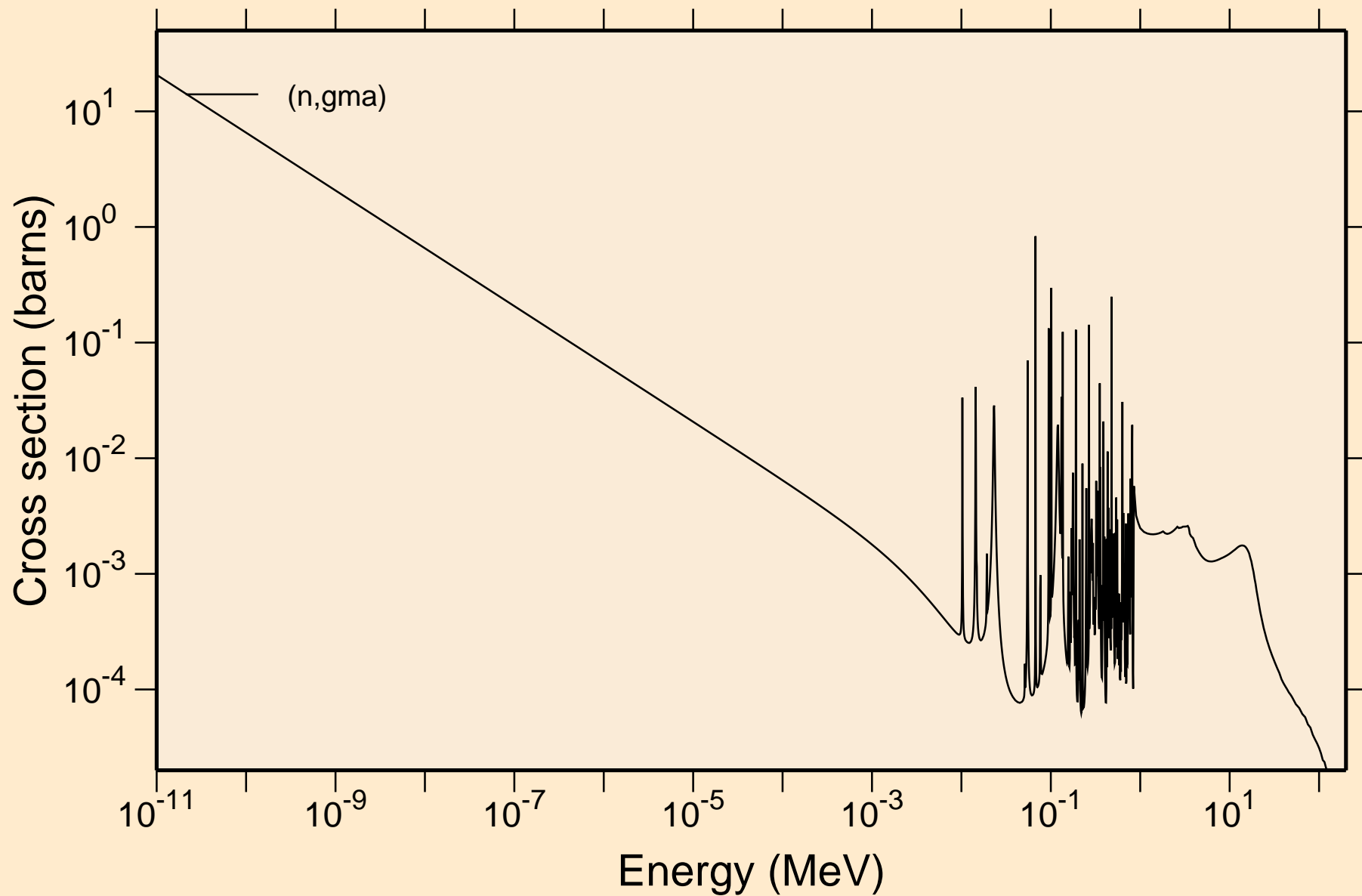

# MAT=2437 ACE FILE PRODUCED AT NEA WITH NDEC

## Principal cross sections

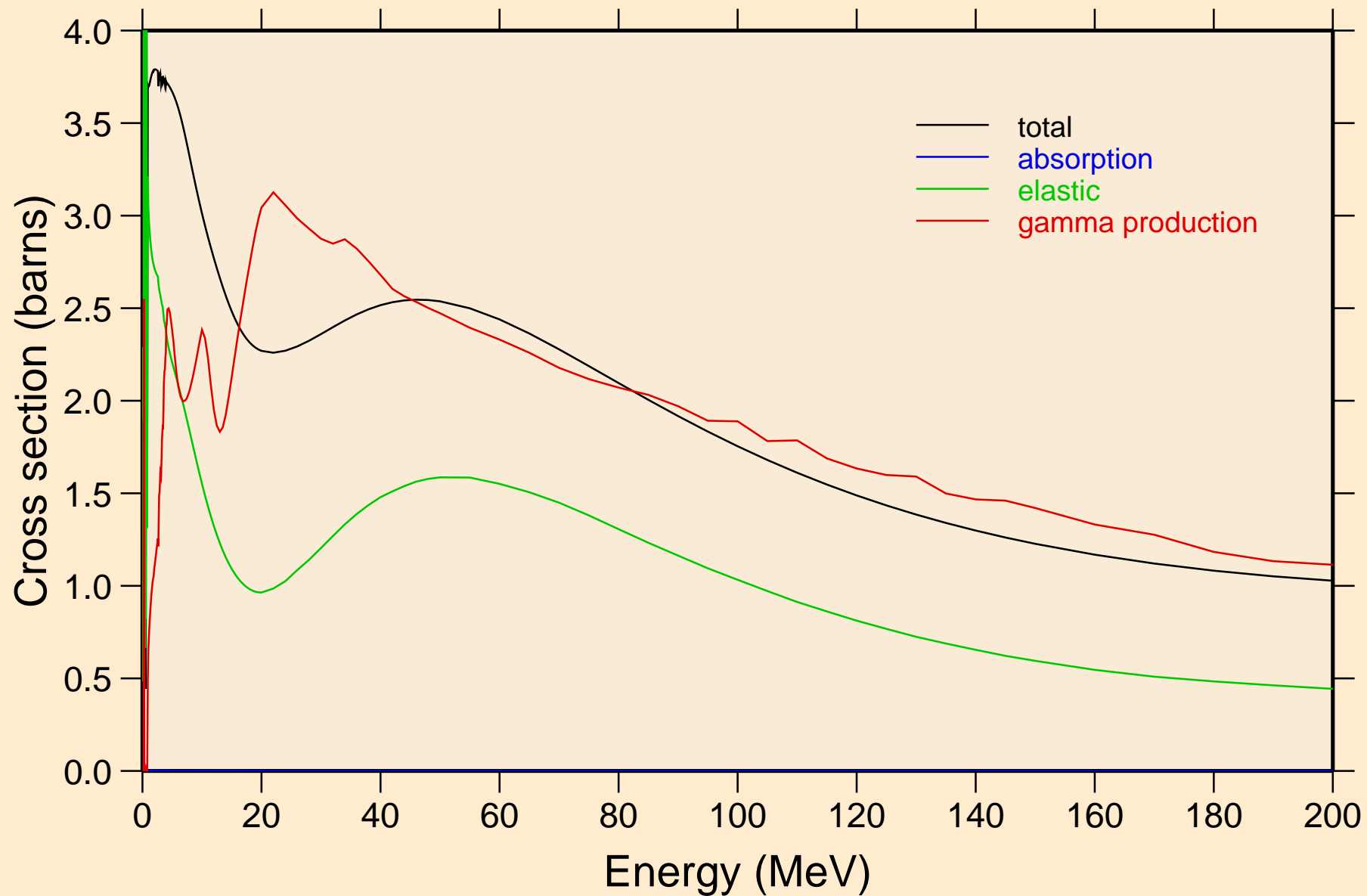

MAT=2437 ACE FILE PRODUCED AT NEA WITH NDEC  
Heating

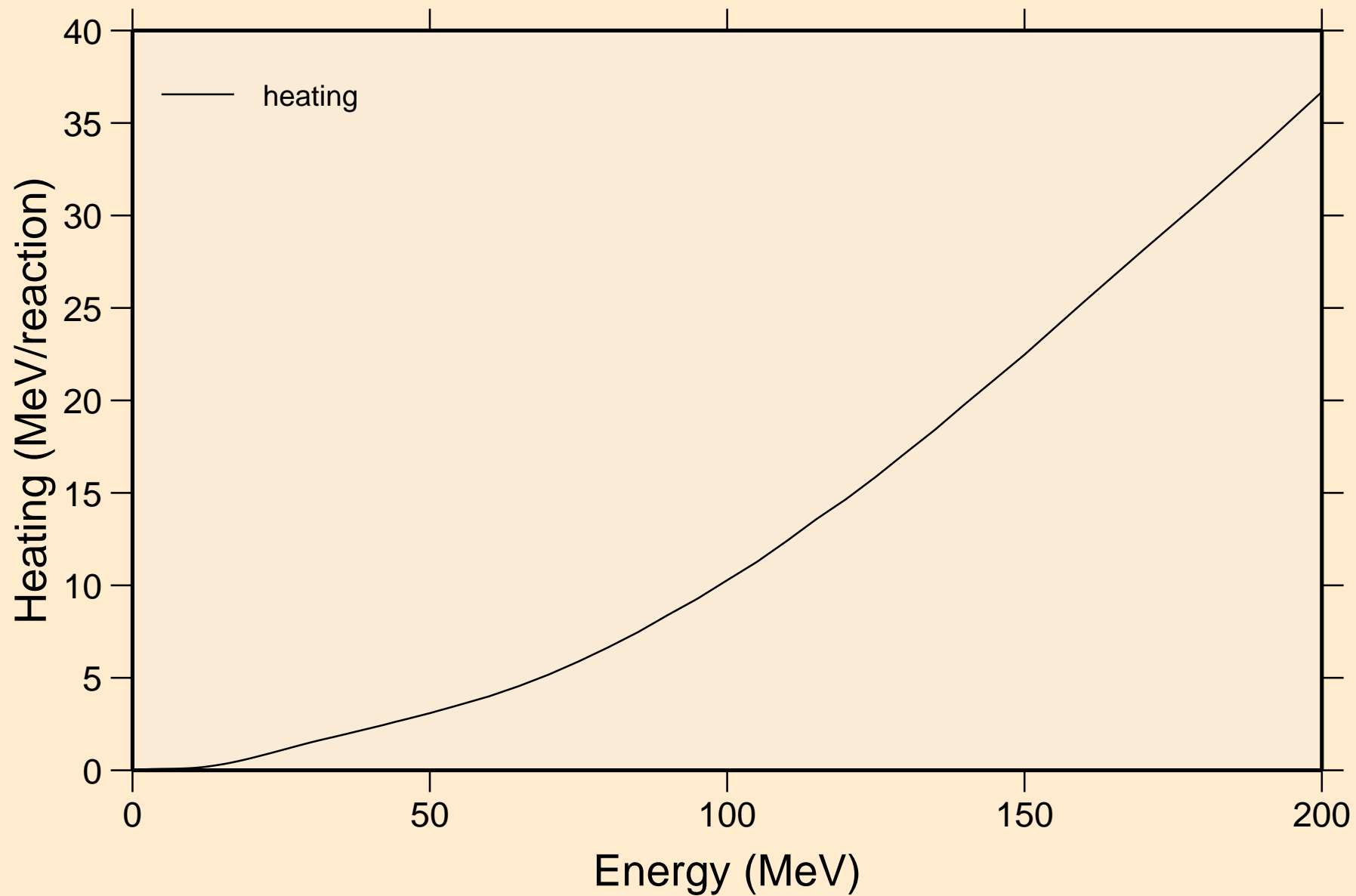

MAT=2437 ACE FILE PRODUCED AT NEA WITH NDEC  
Damage

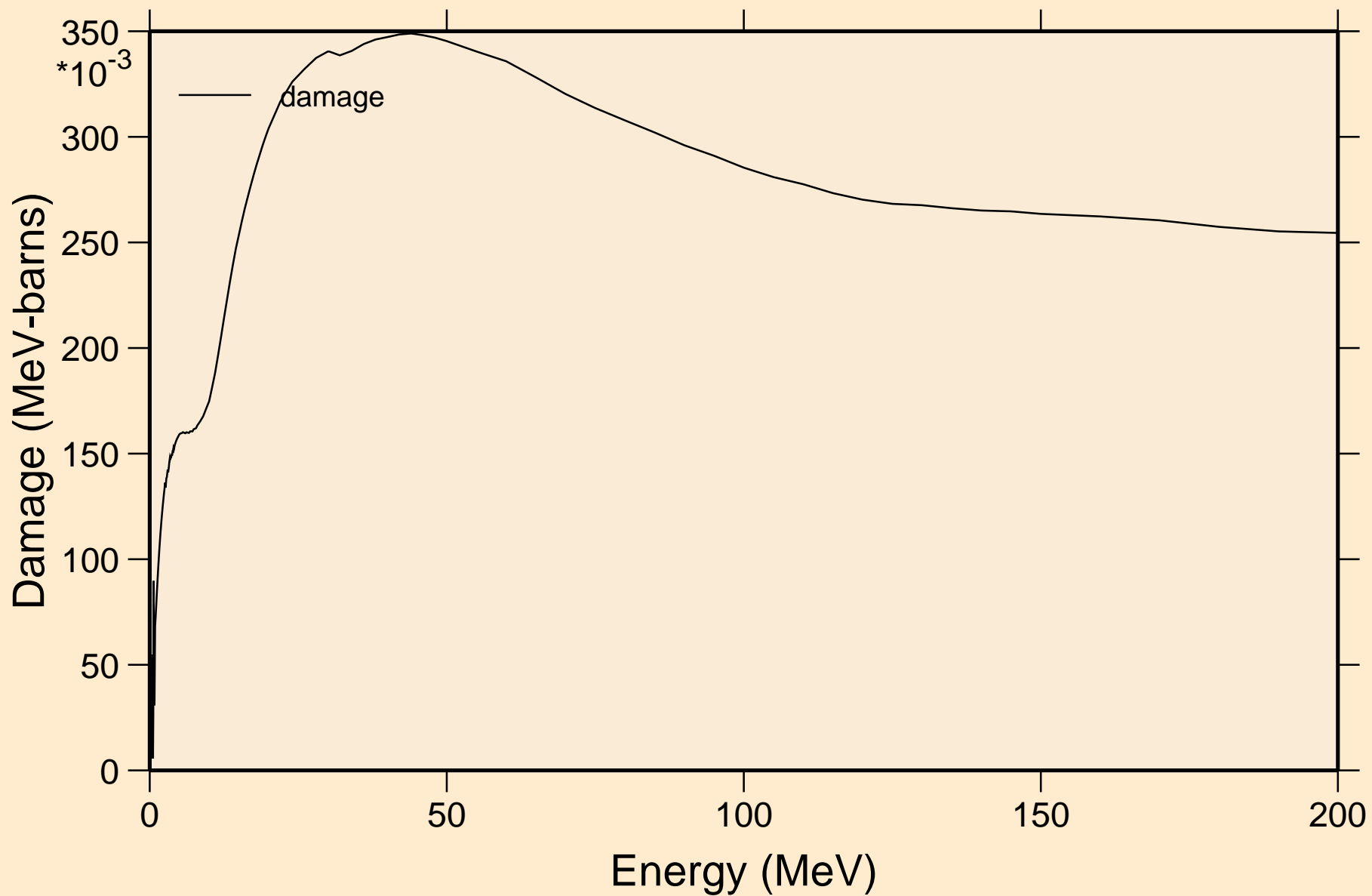

MAT=2437 ACE FILE PRODUCED AT NEA WITH NDEC  
Non-threshold reactions

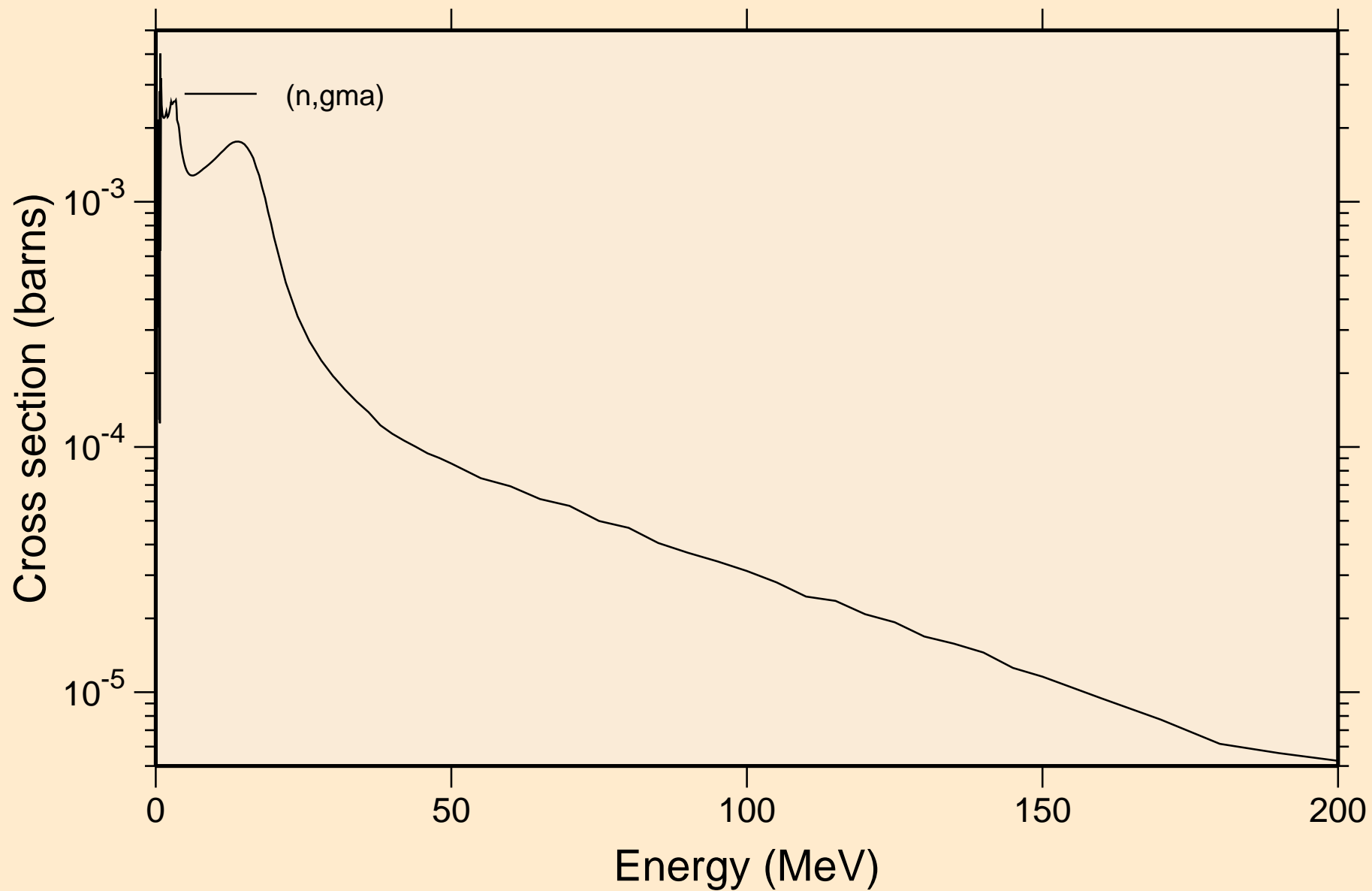

MAT=2437 ACE FILE PRODUCED AT NEA WITH NDEC  
Inelastic levels

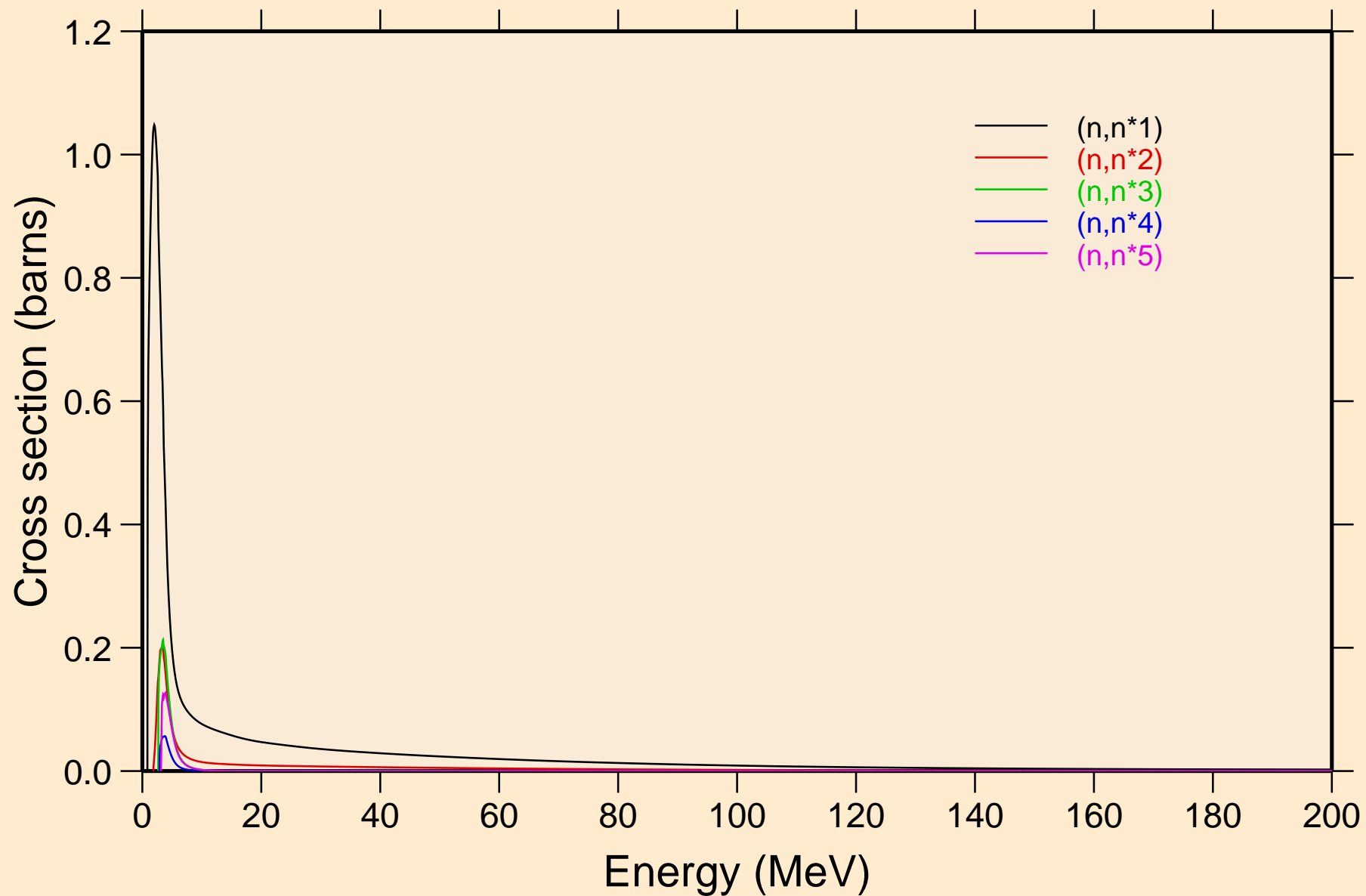

MAT=2437 ACE FILE PRODUCED AT NEA WITH NDEC  
Inelastic levels

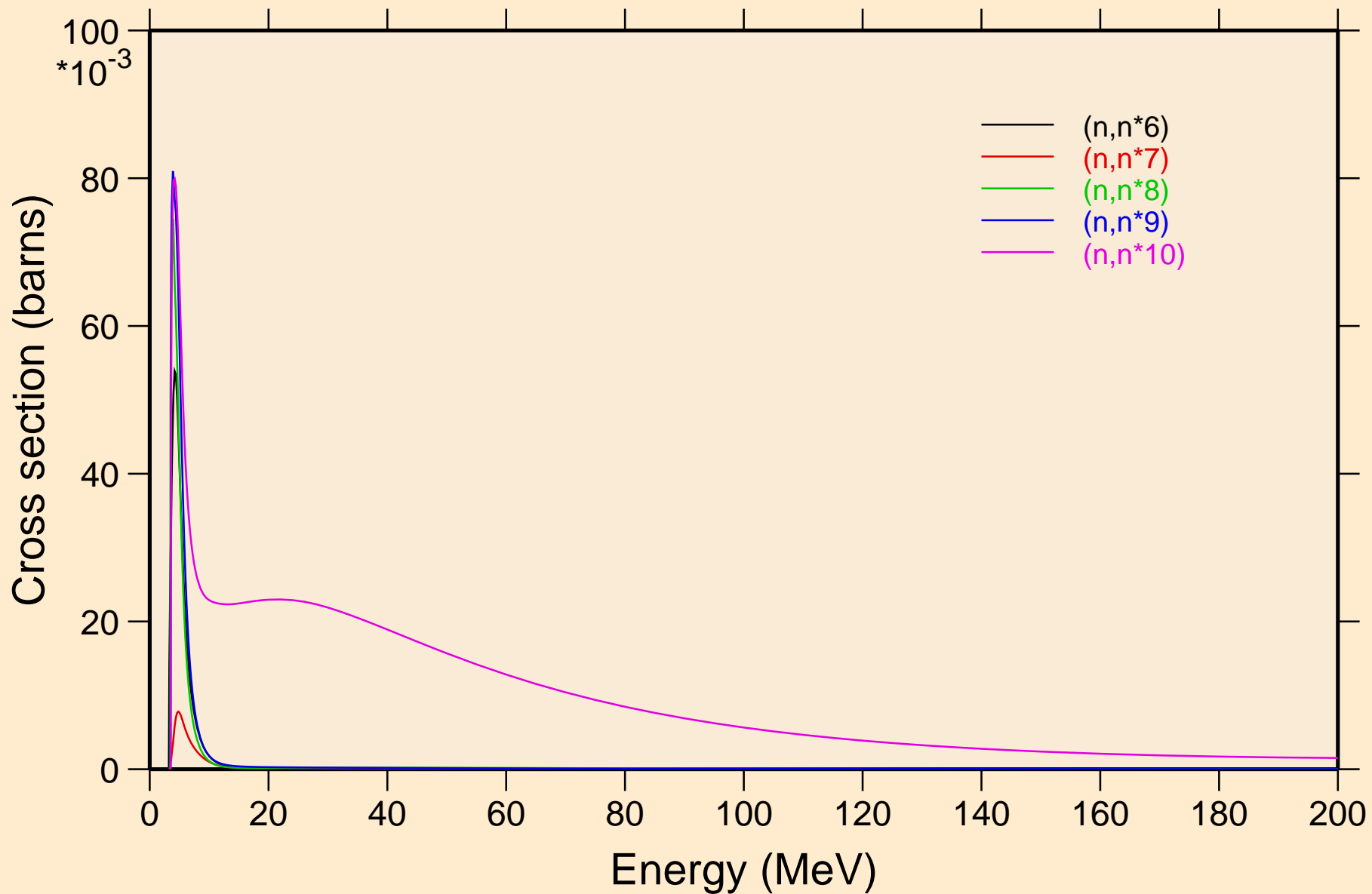

MAT=2437 ACE FILE PRODUCED AT NEA WITH NDEC  
Inelastic levels

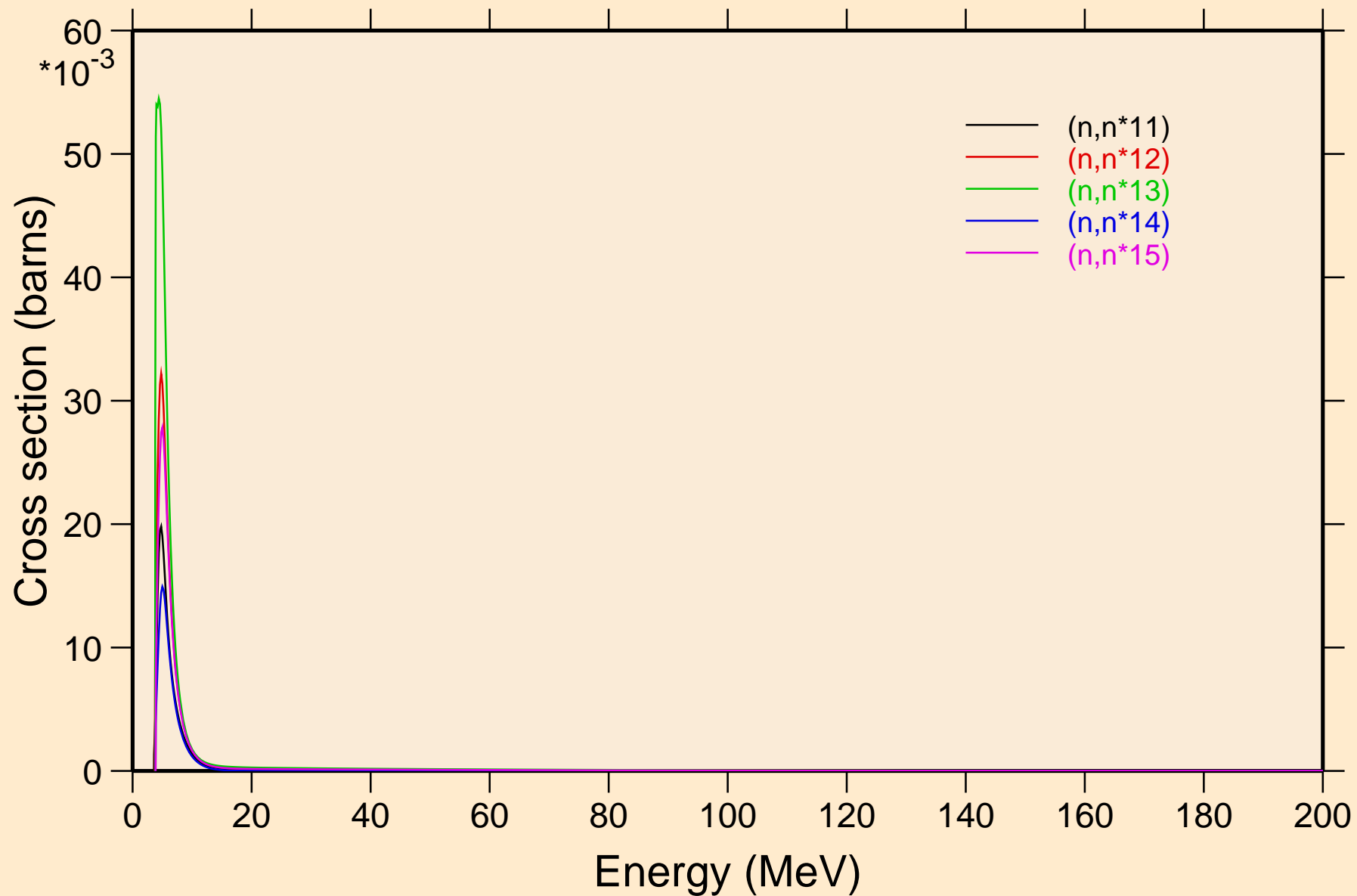

MAT=2437 ACE FILE PRODUCED AT NEA WITH NDEC  
Inelastic levels

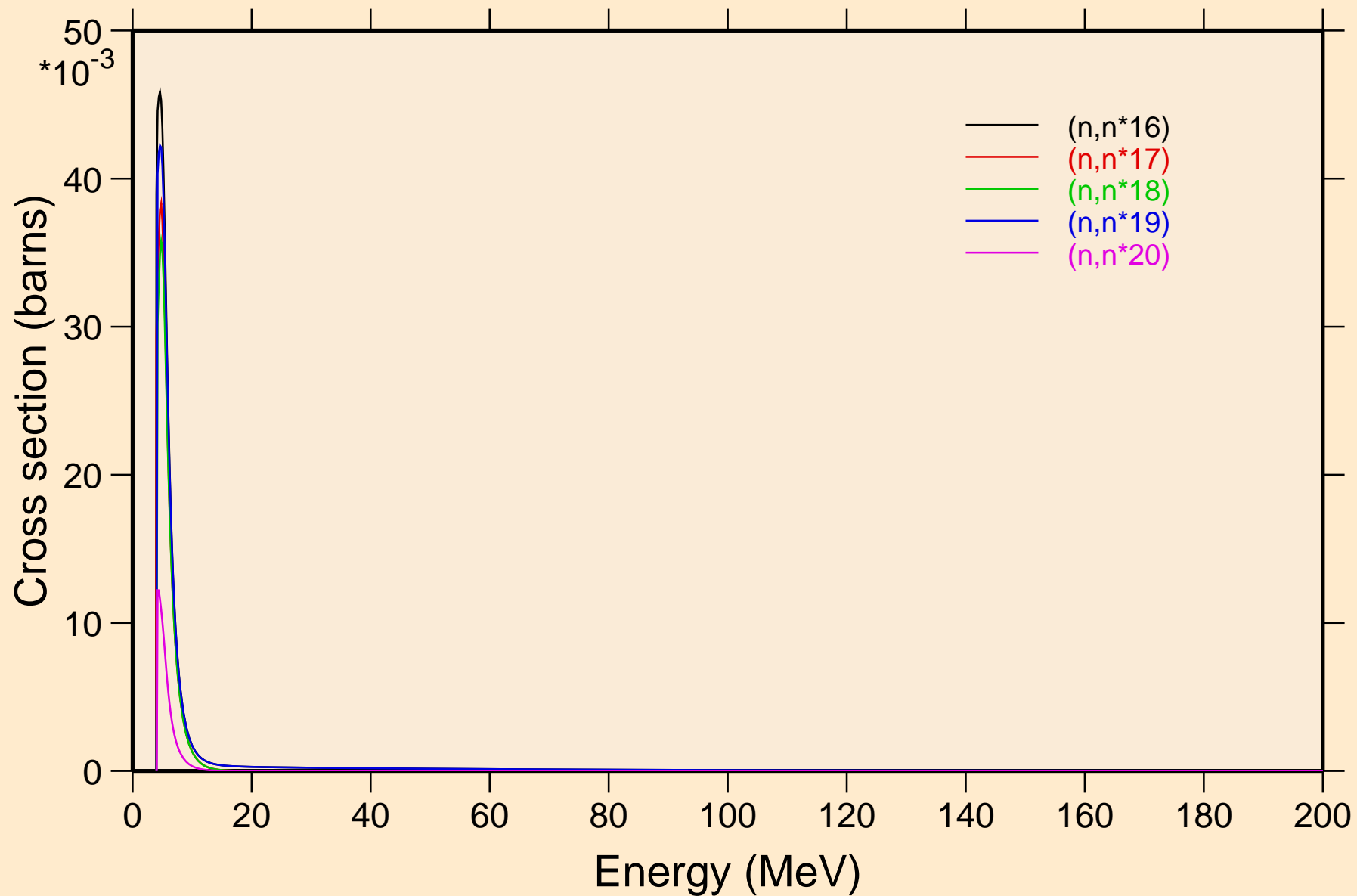

MAT=2437 ACE FILE PRODUCED AT NEA WITH NDEC  
Threshold reactions

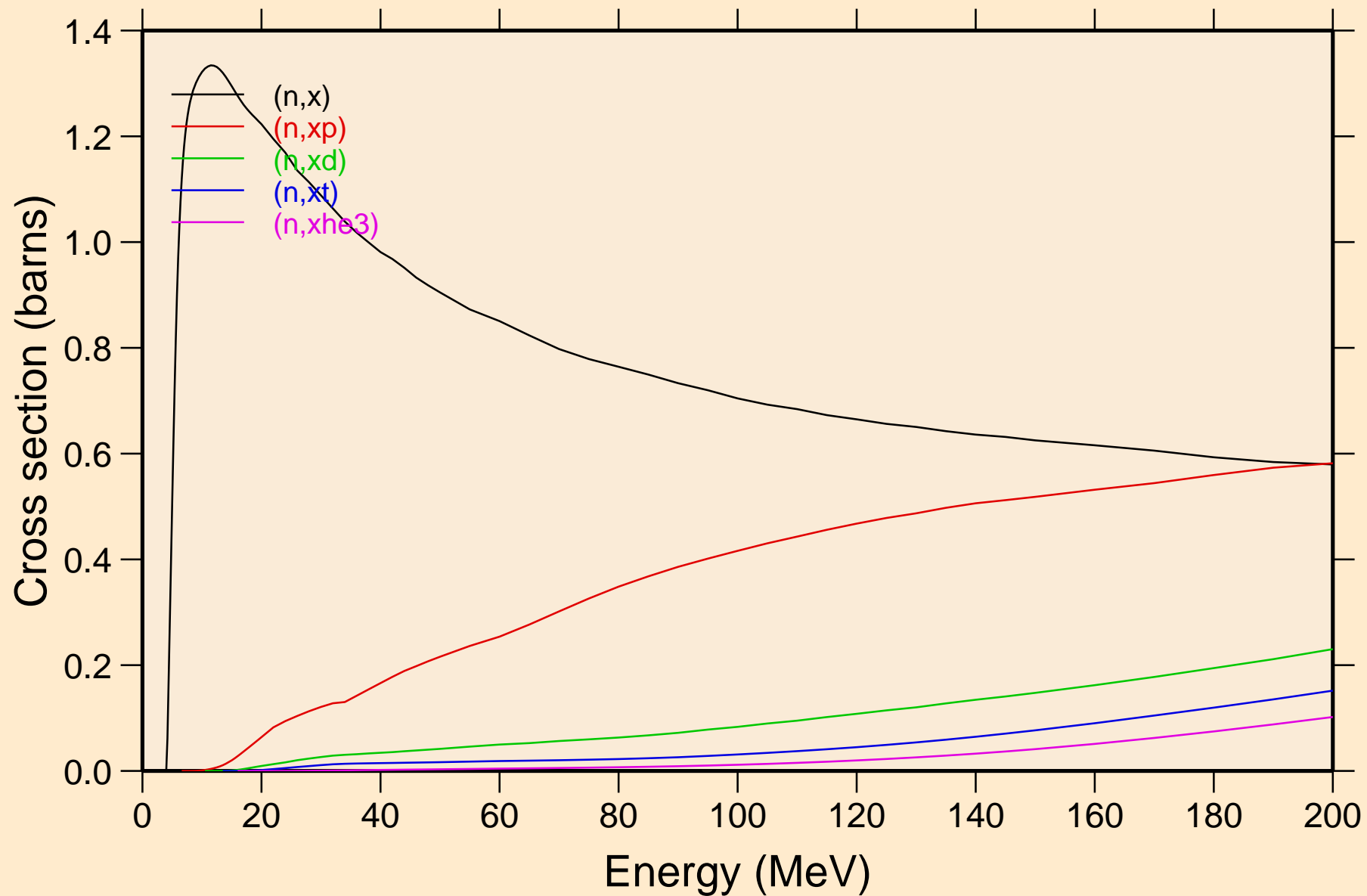

MAT=2437 ACE FILE PRODUCED AT NEA WITH NDEC  
Threshold reactions

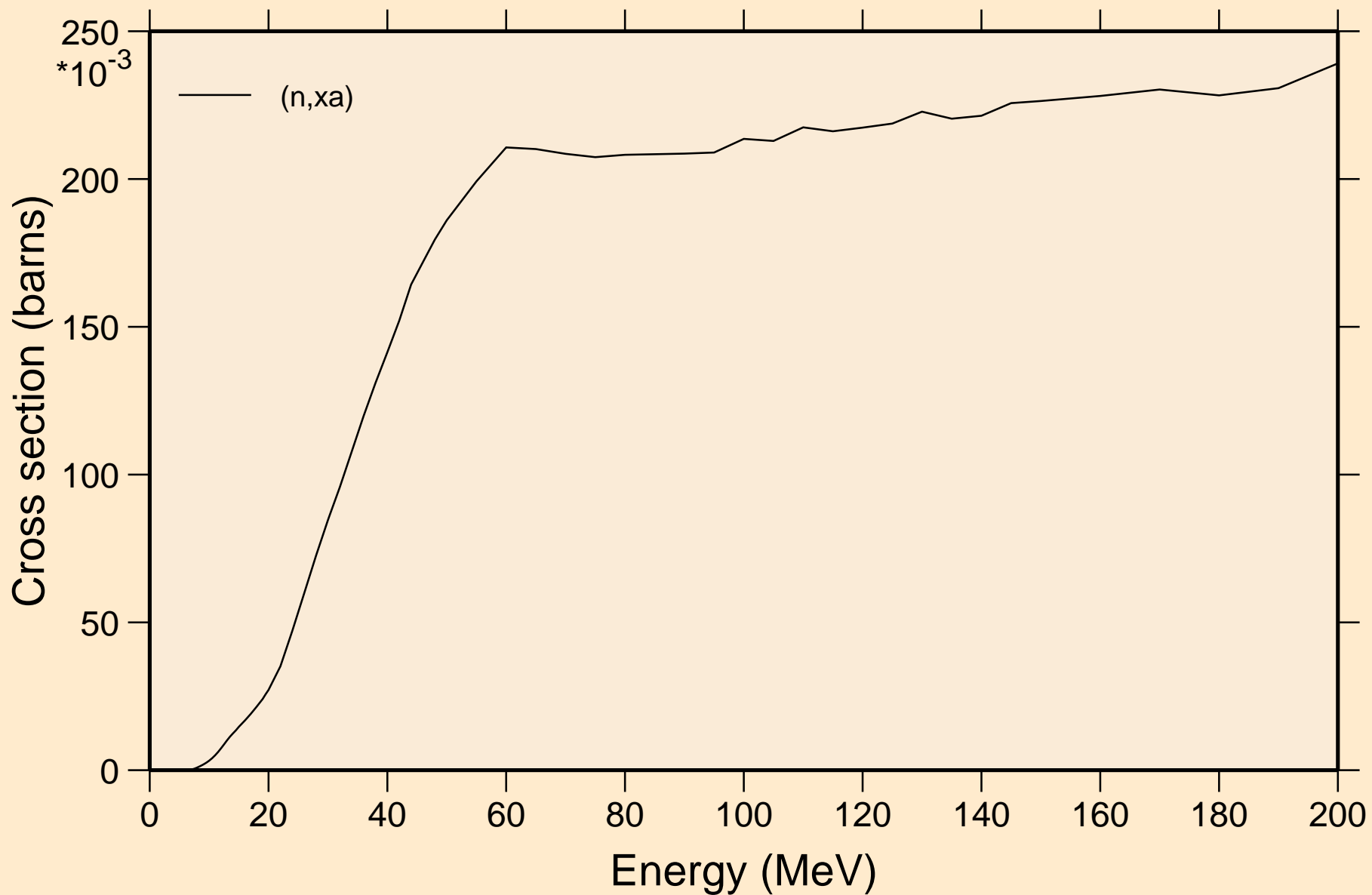

MAT=2437 ACE FILE PRODUCED AT NEA WITH NDEC  
angular distribution for elastic

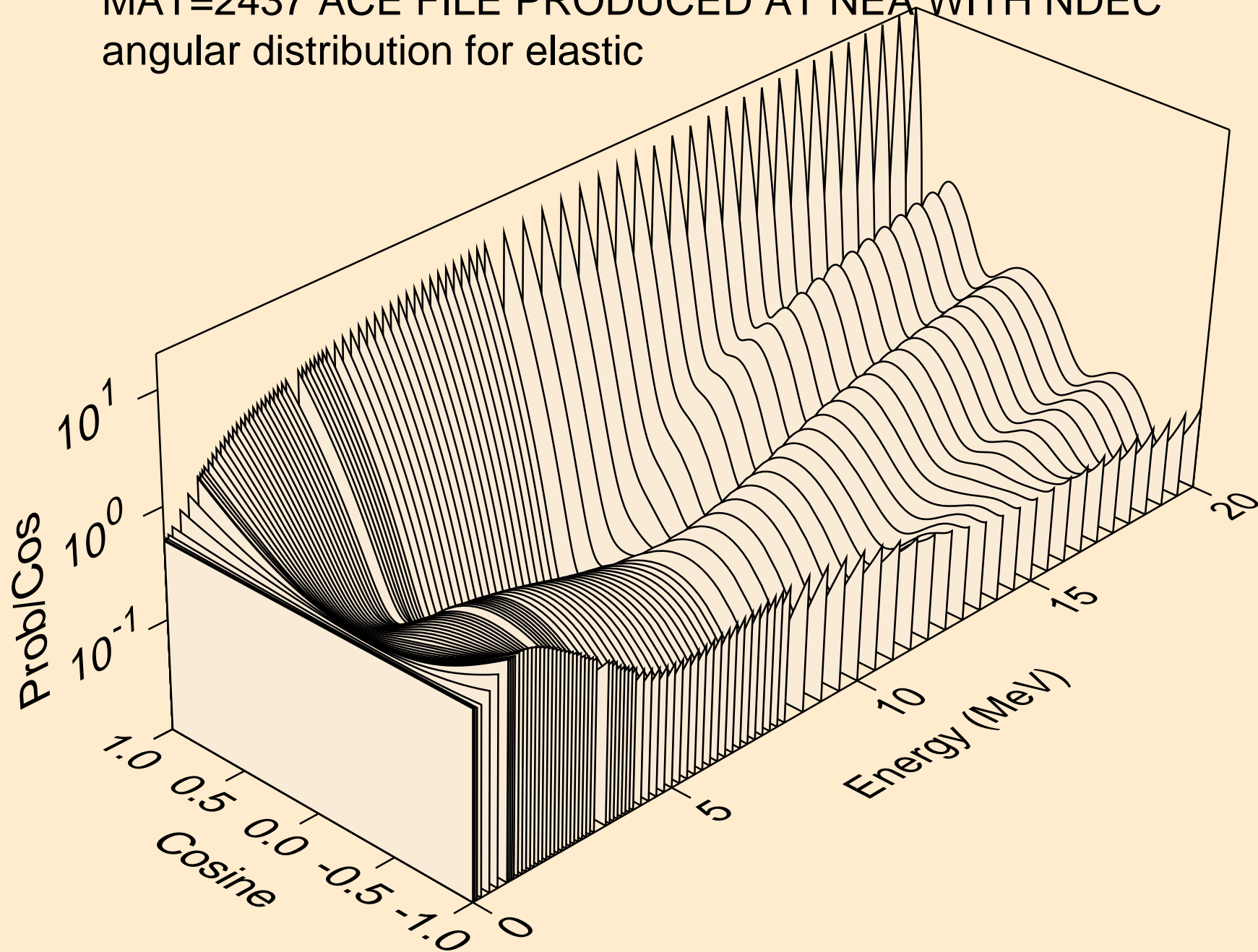

MAT=2437 ACE FILE PRODUCED AT NEA WITH NDEC  
angular distribution for elastic

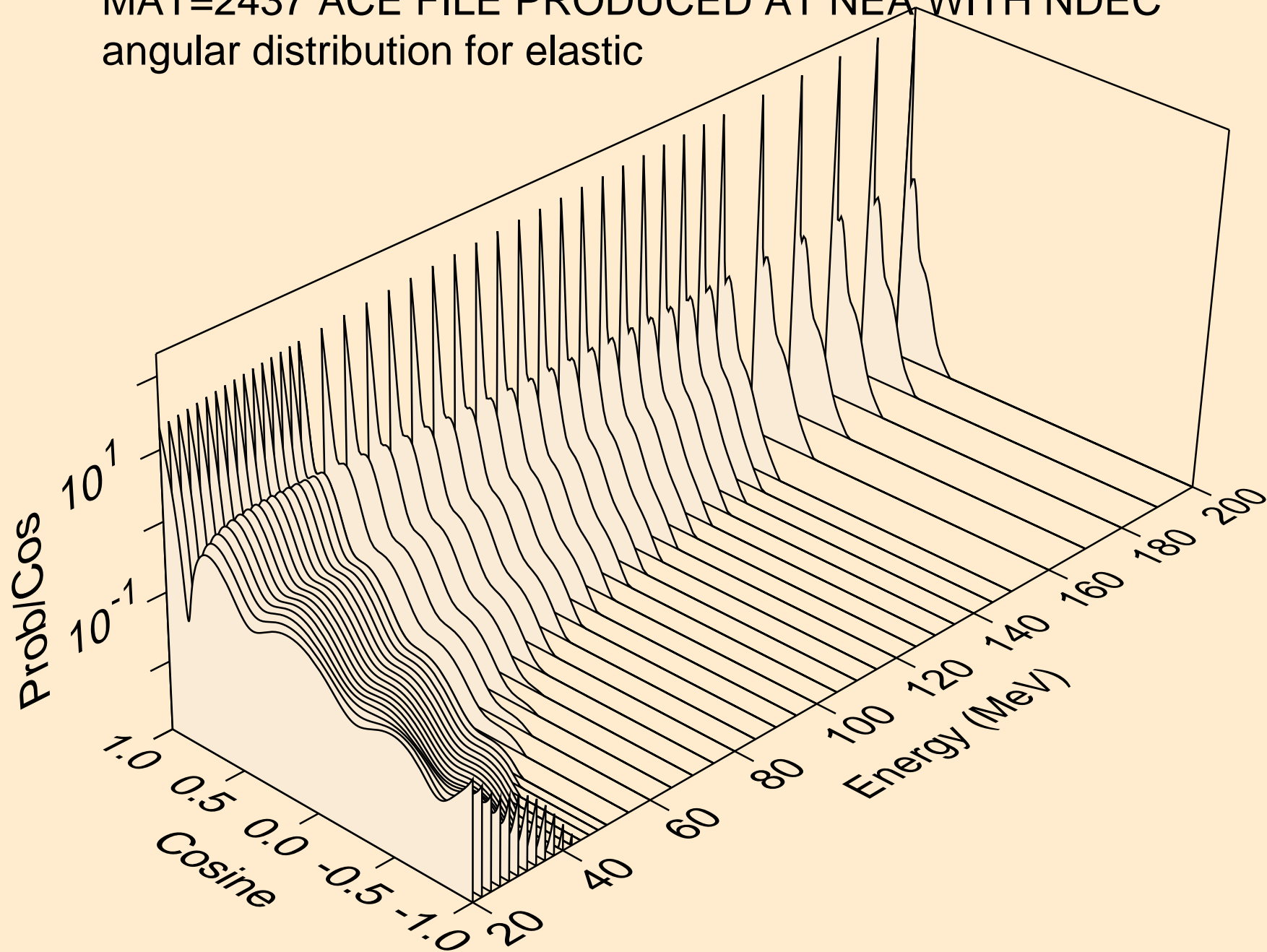

MAT=2437 ACE FILE PRODUCED AT NEA WITH NDEC  
angular distribution for (n,n\*1)

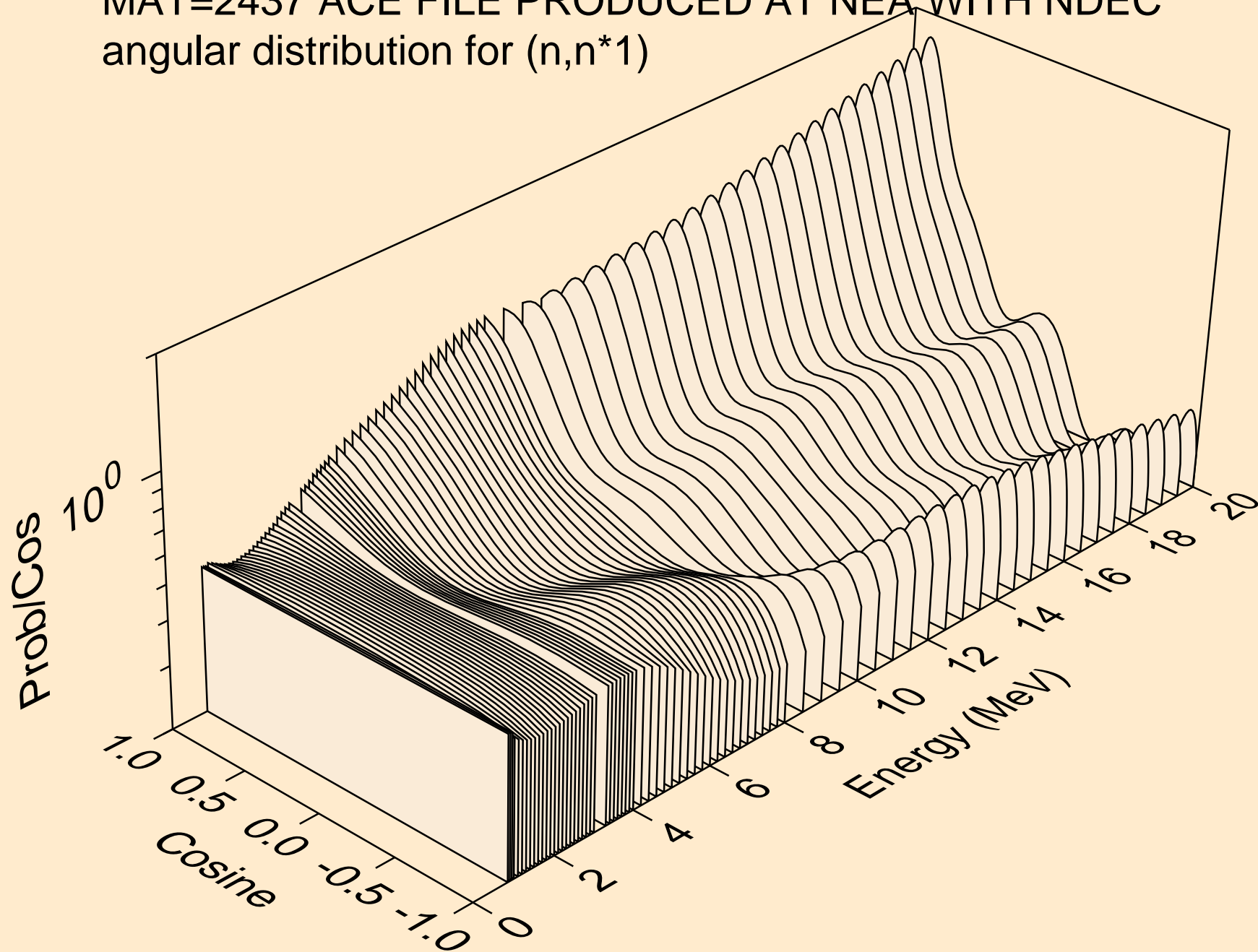

MAT=2437 ACE FILE PRODUCED AT NEA WITH NDEC  
angular distribution for (n,n\*1)

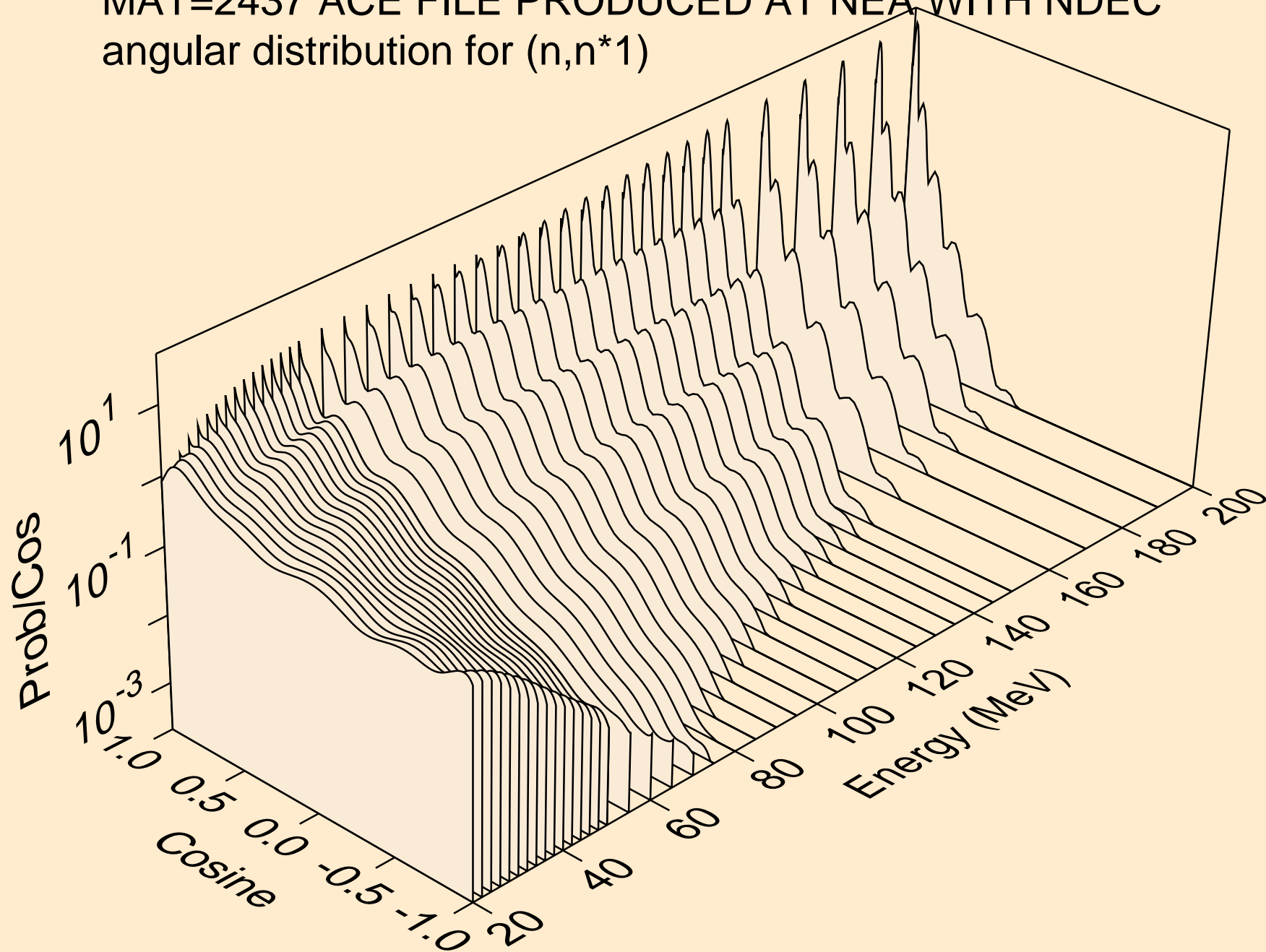

MAT=2437 ACE FILE PRODUCED AT NEA WITH NDEC  
angular distribution for (n,n\*2)

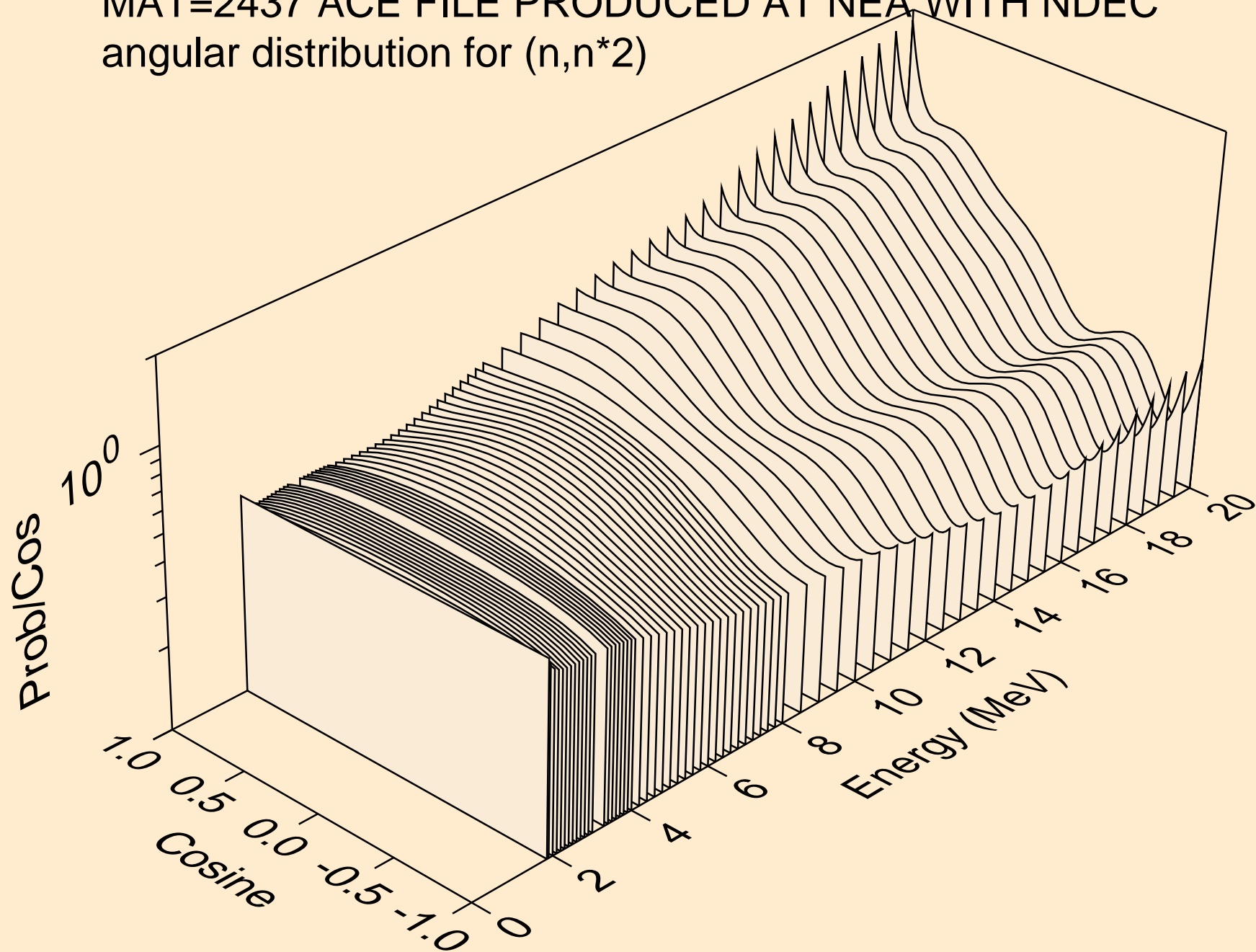

MAT=2437 ACE FILE PRODUCED AT NEA WITH NDEC  
angular distribution for (n,n\*2)

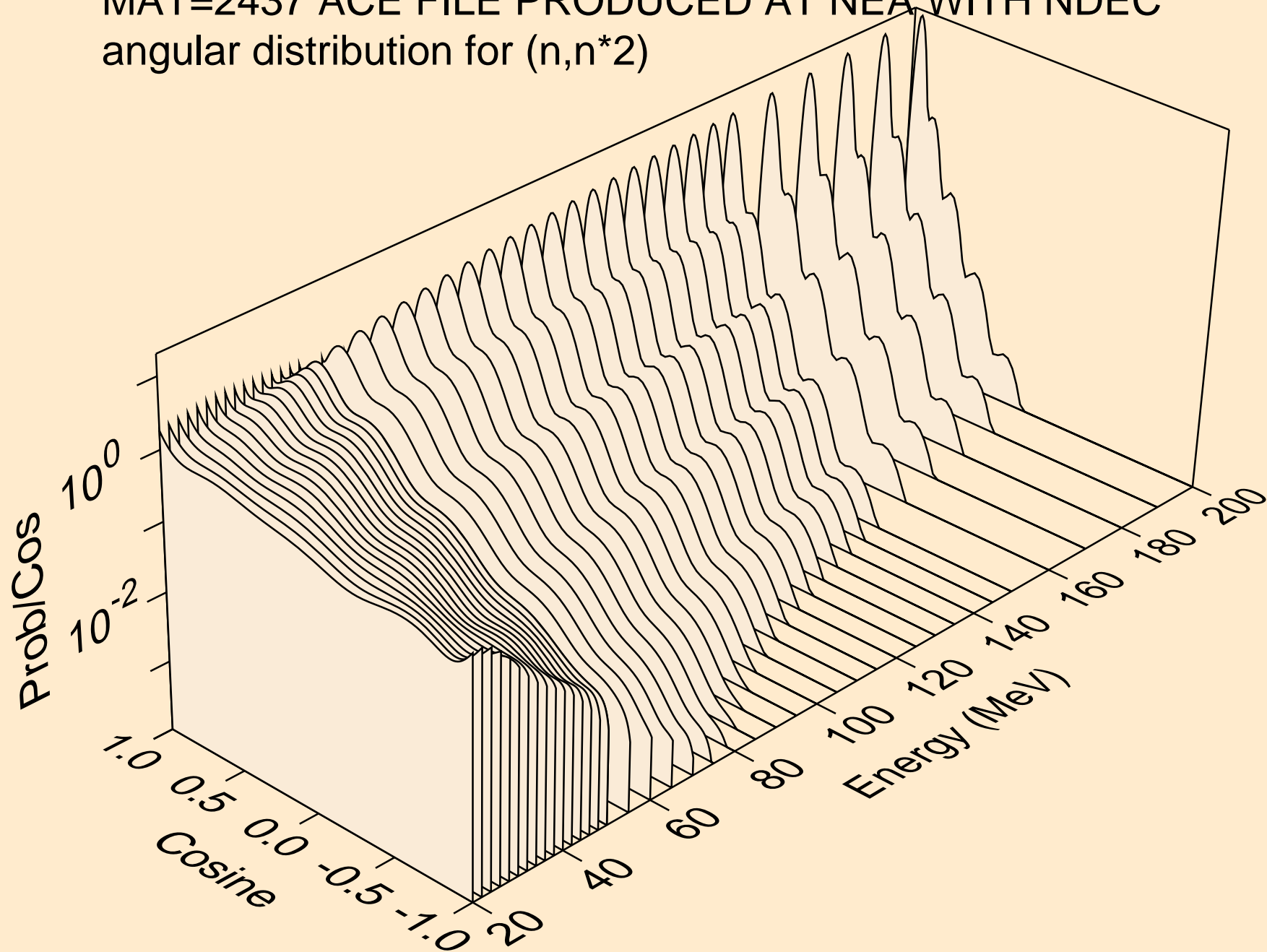

MAT=2437 ACE FILE PRODUCED AT NEA WITH NDEC  
angular distribution for (n,n\*3)

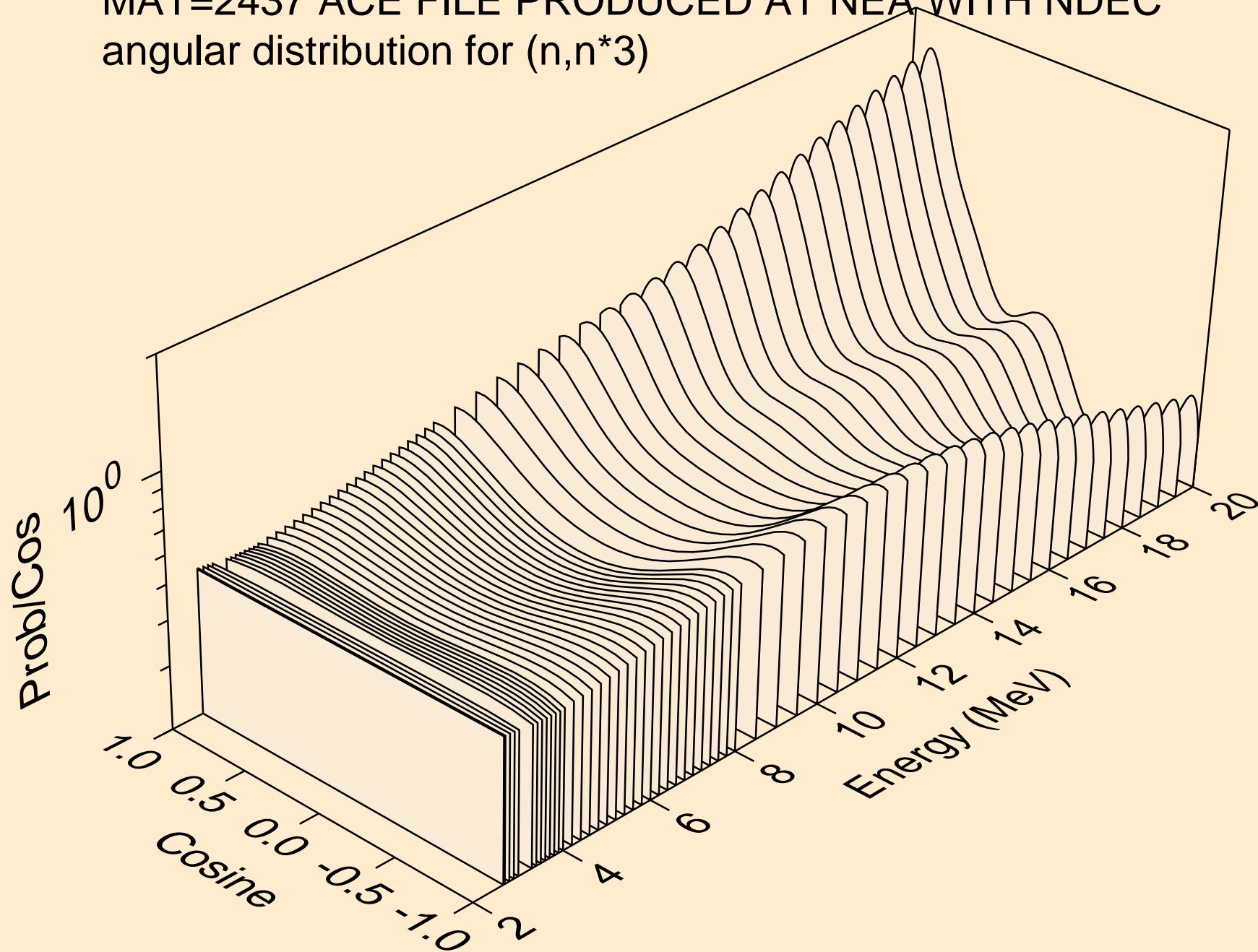

MAT=2437 ACE FILE PRODUCED AT NEA WITH NDEC  
angular distribution for (n,n\*3)

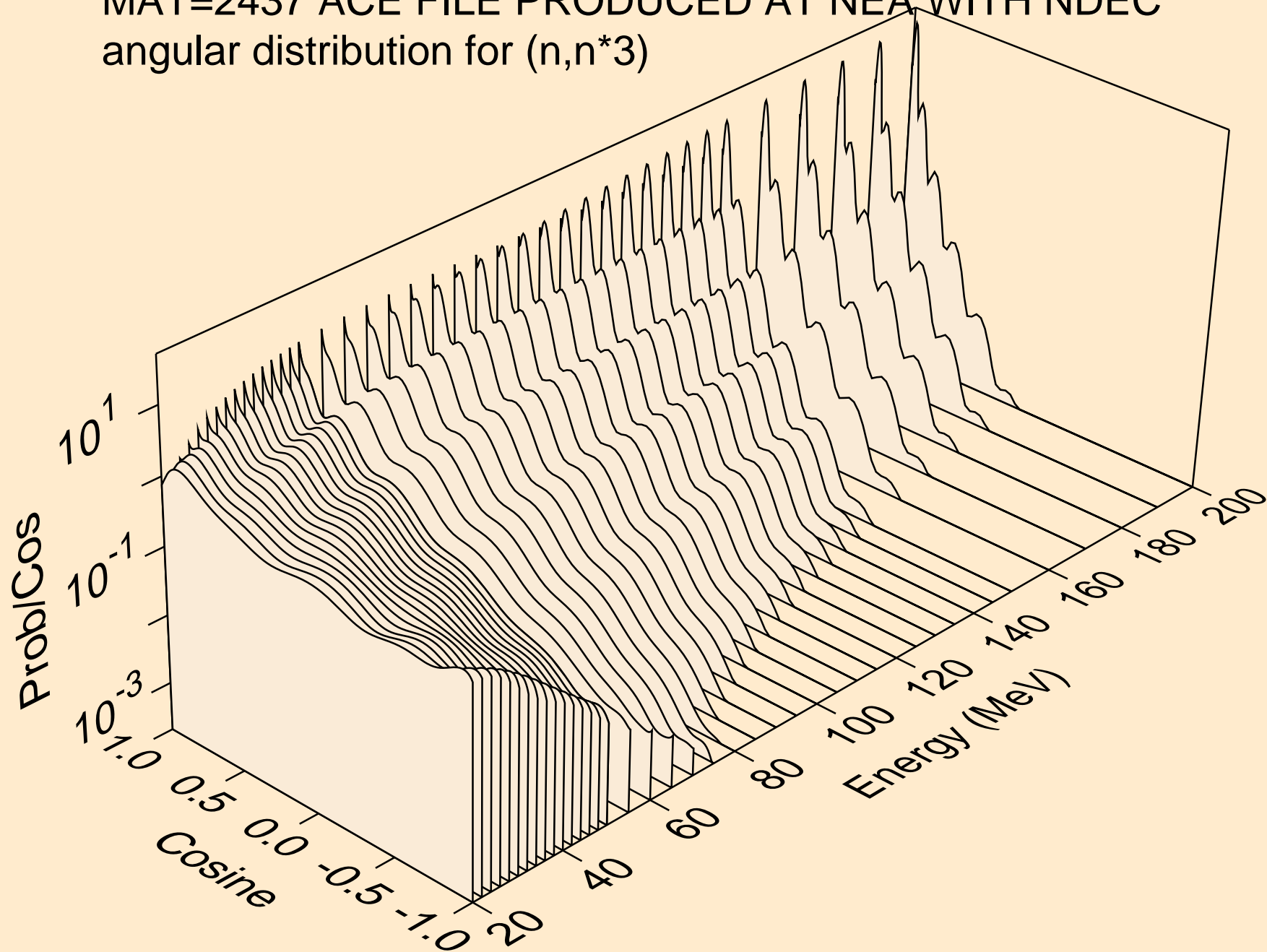

MAT=2437 ACE FILE PRODUCED AT NEA WITH NDEC  
angular distribution for (n,n\*4)

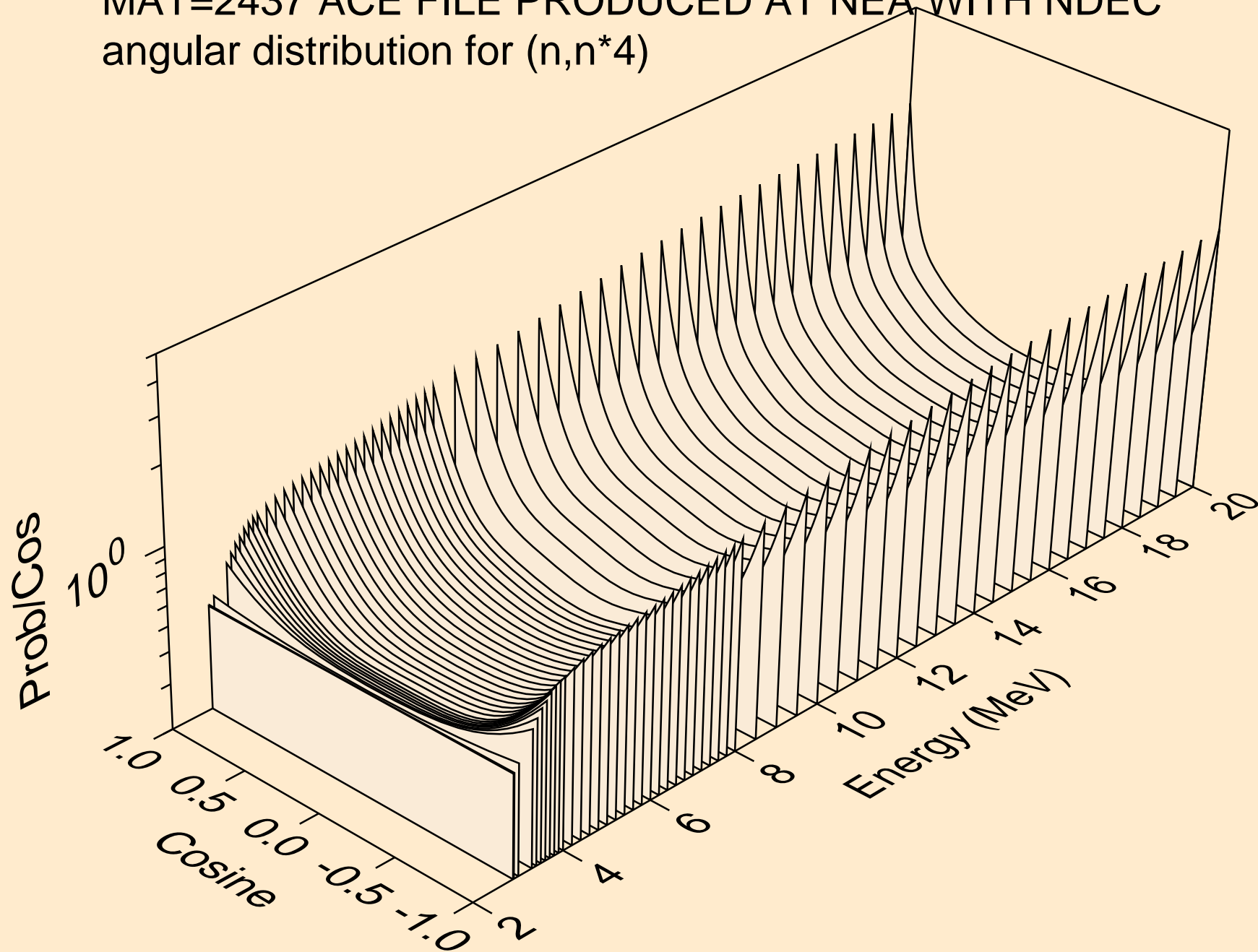

MAT=2437 ACE FILE PRODUCED AT NEA WITH NDEC  
angular distribution for (n,n\*4)

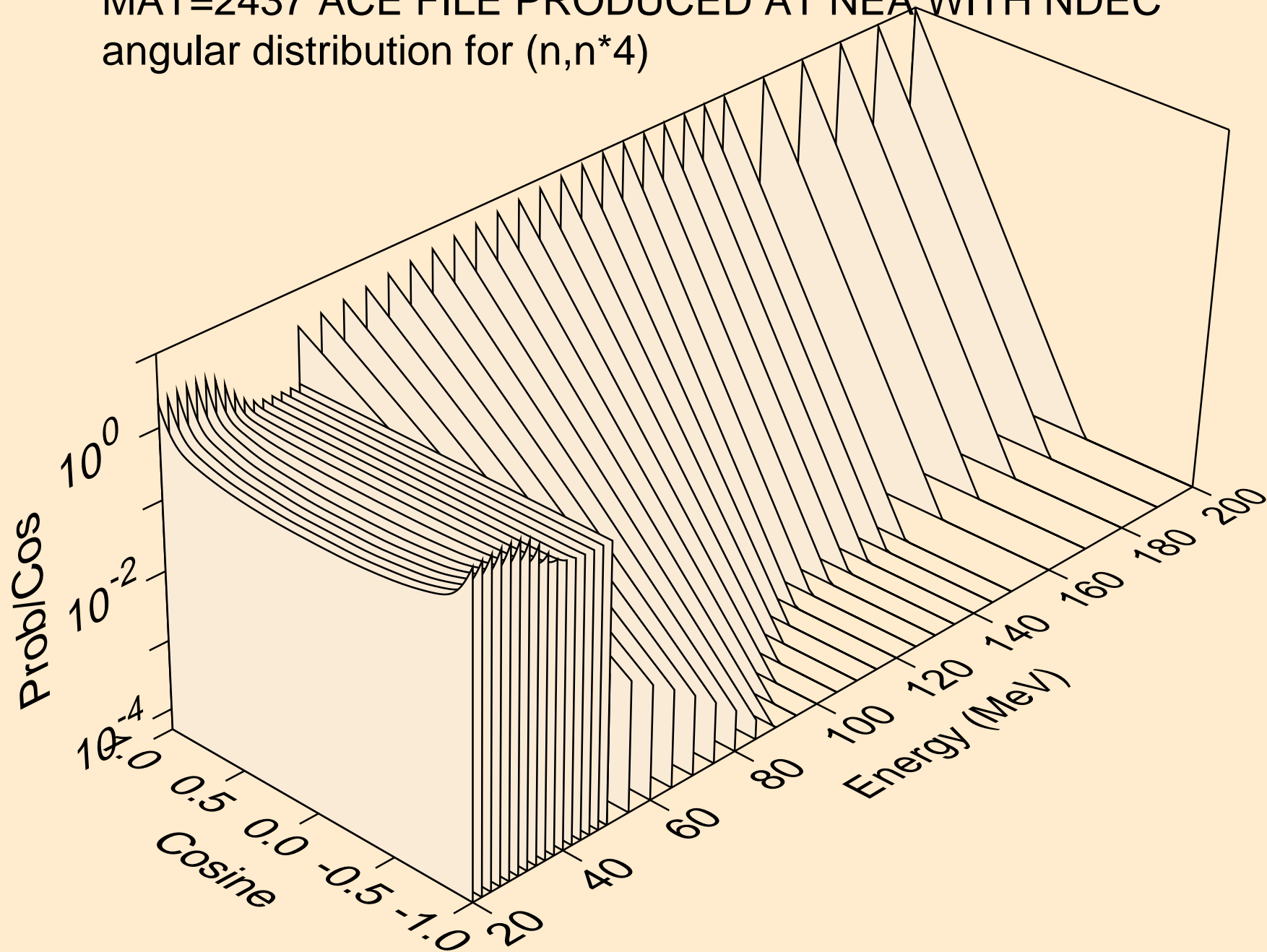

MAT=2437 ACE FILE PRODUCED AT NEA WITH NDEC  
angular distribution for (n,n\*5)

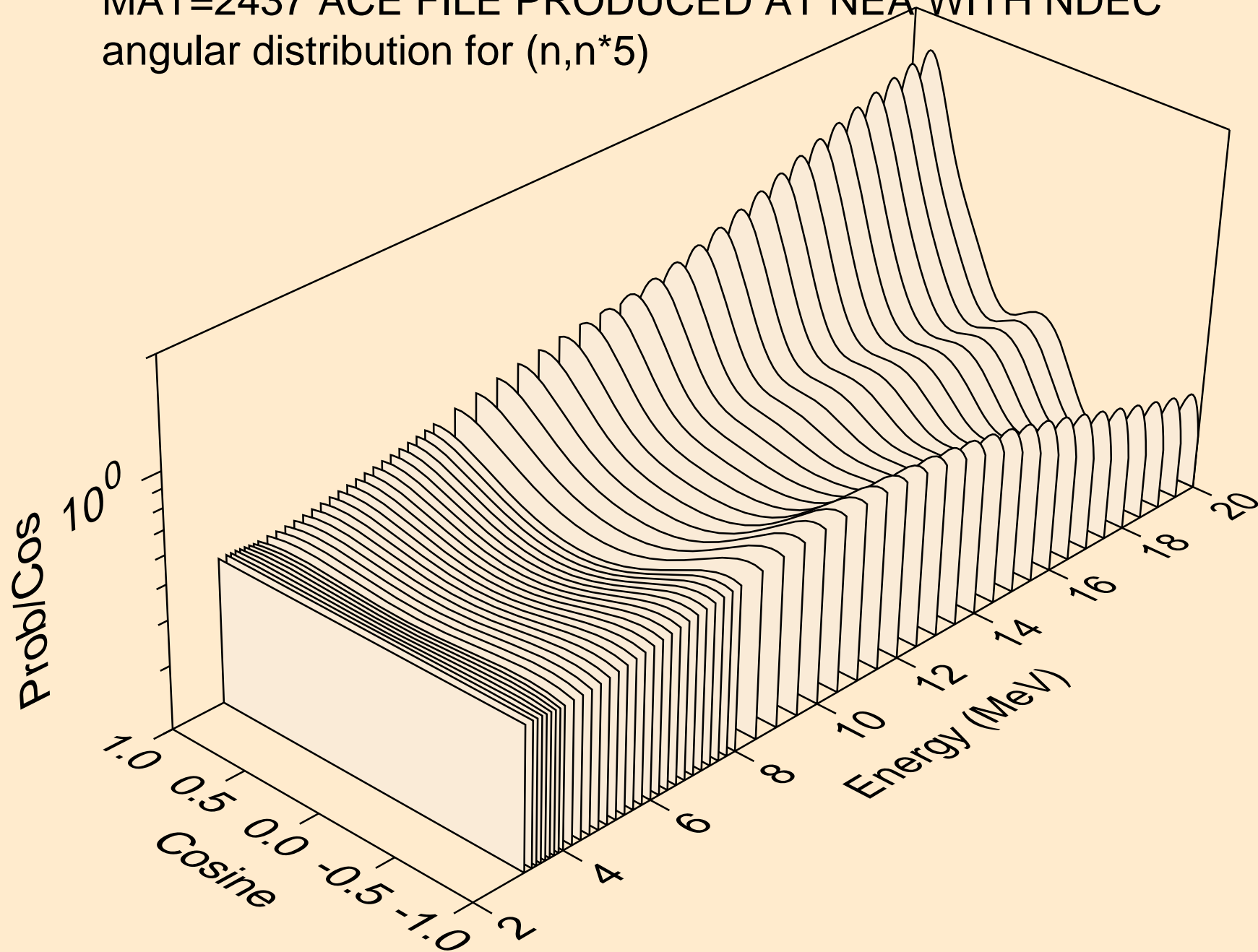

MAT=2437 ACE FILE PRODUCED AT NEA WITH NDEC  
angular distribution for (n,n\*5)

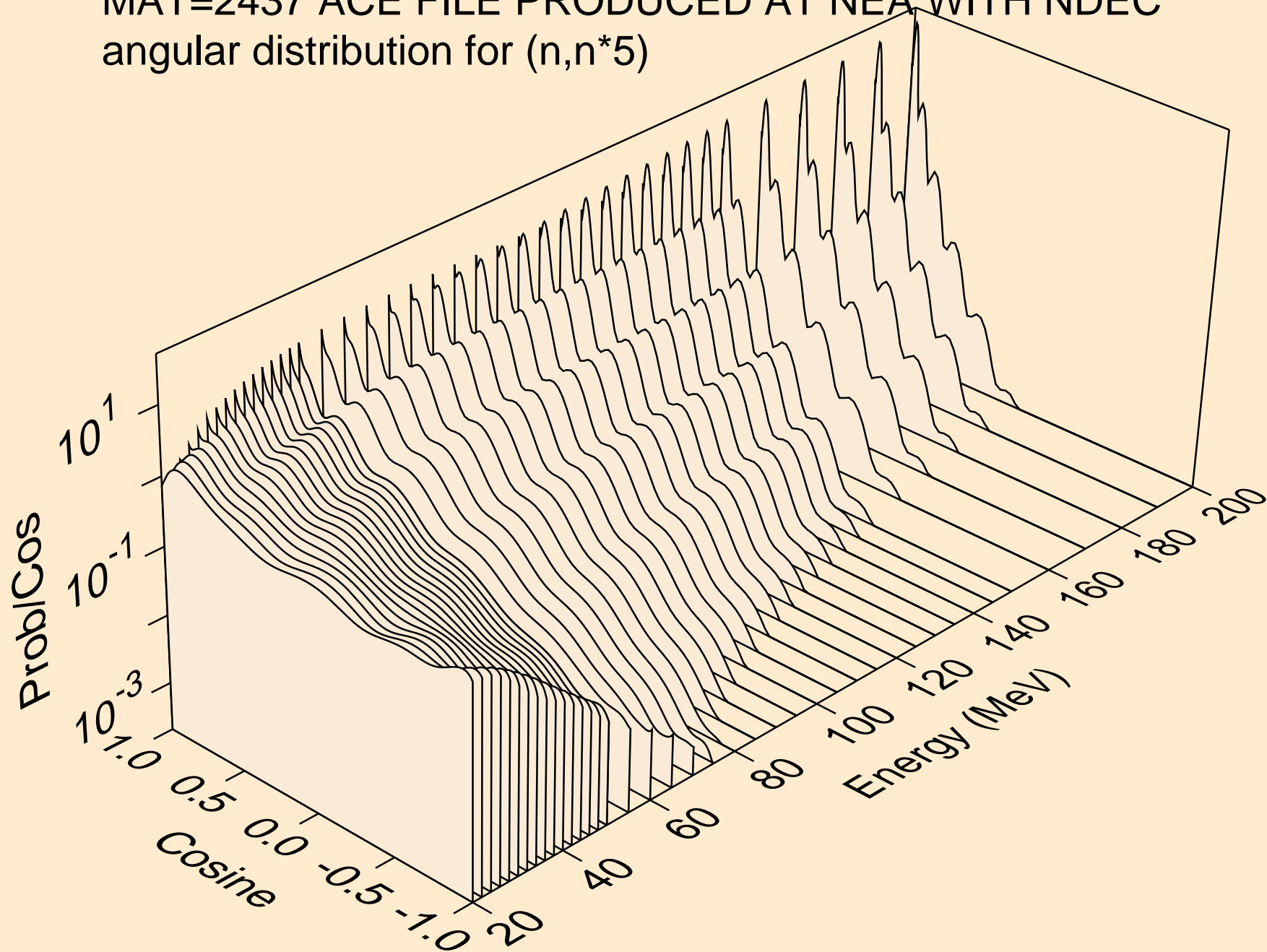

MAT=2437 ACE FILE PRODUCED AT NEA WITH NDEC  
angular distribution for (n,n\*6)

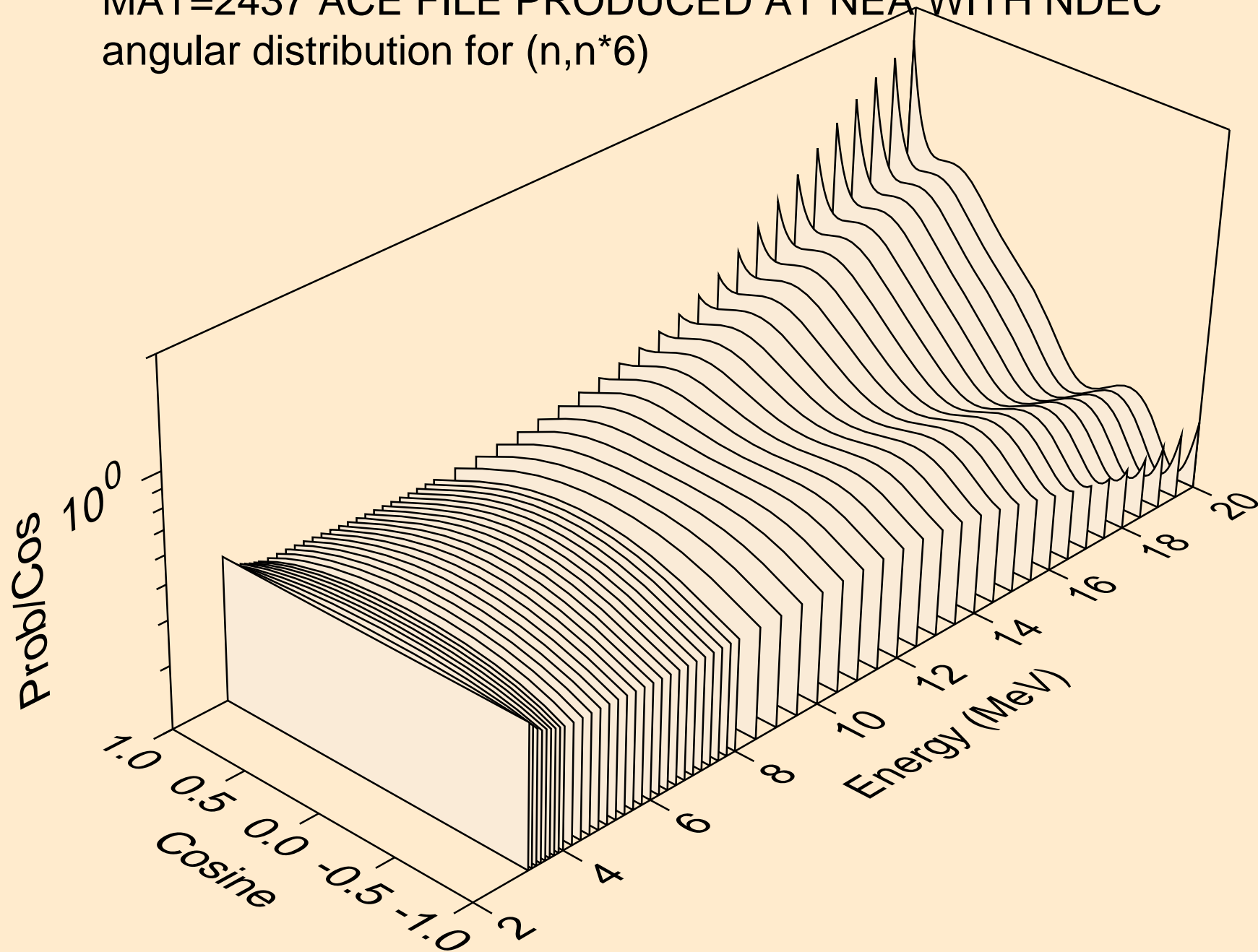

MAT=2437 ACE FILE PRODUCED AT NEA WITH NDEC  
angular distribution for (n,n\*6)

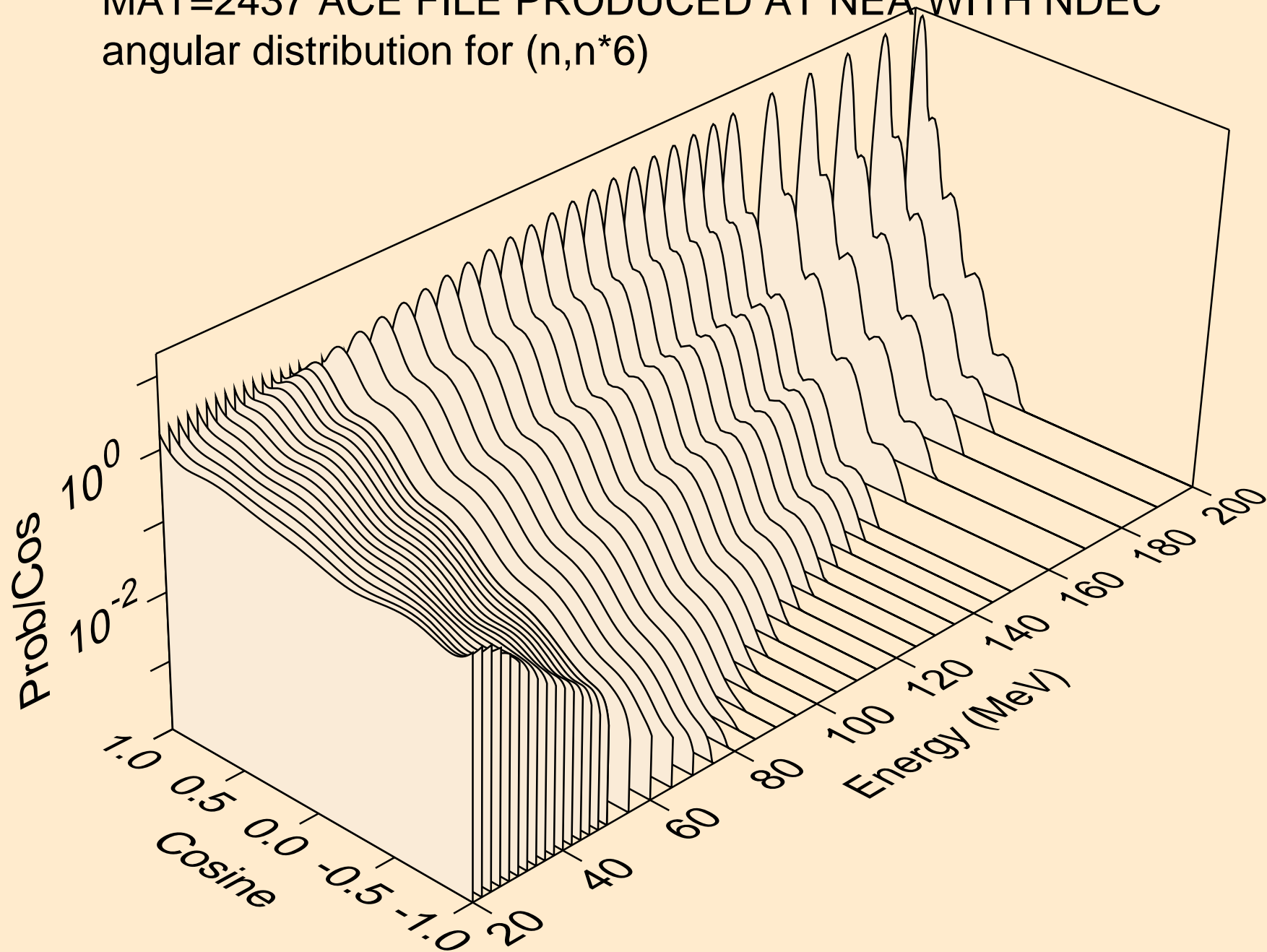

MAT=2437 ACE FILE PRODUCED AT NEA WITH NDEC  
angular distribution for (n,n\*7)

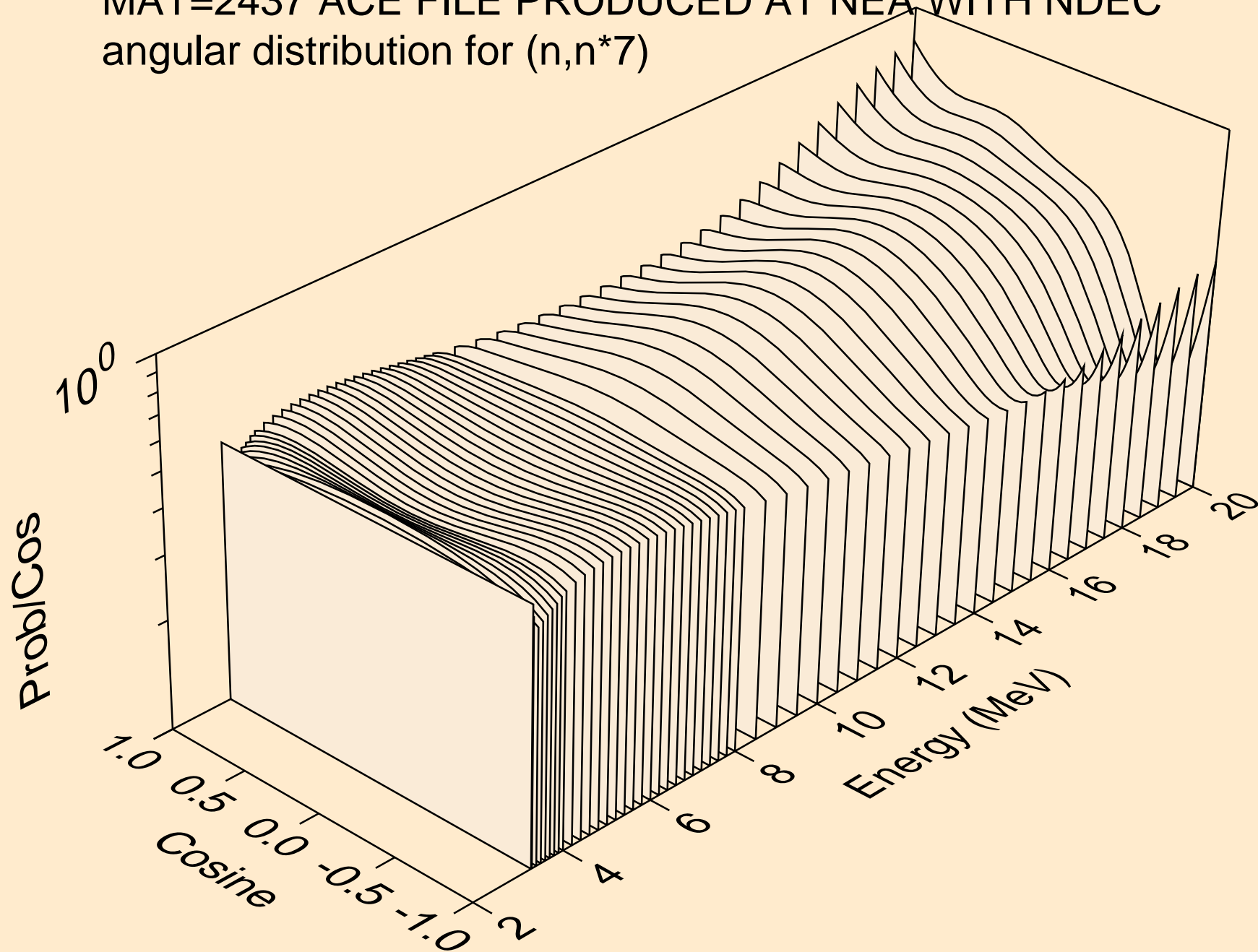

MAT=2437 ACE FILE PRODUCED AT NEA WITH NDEC  
angular distribution for (n,n\*7)

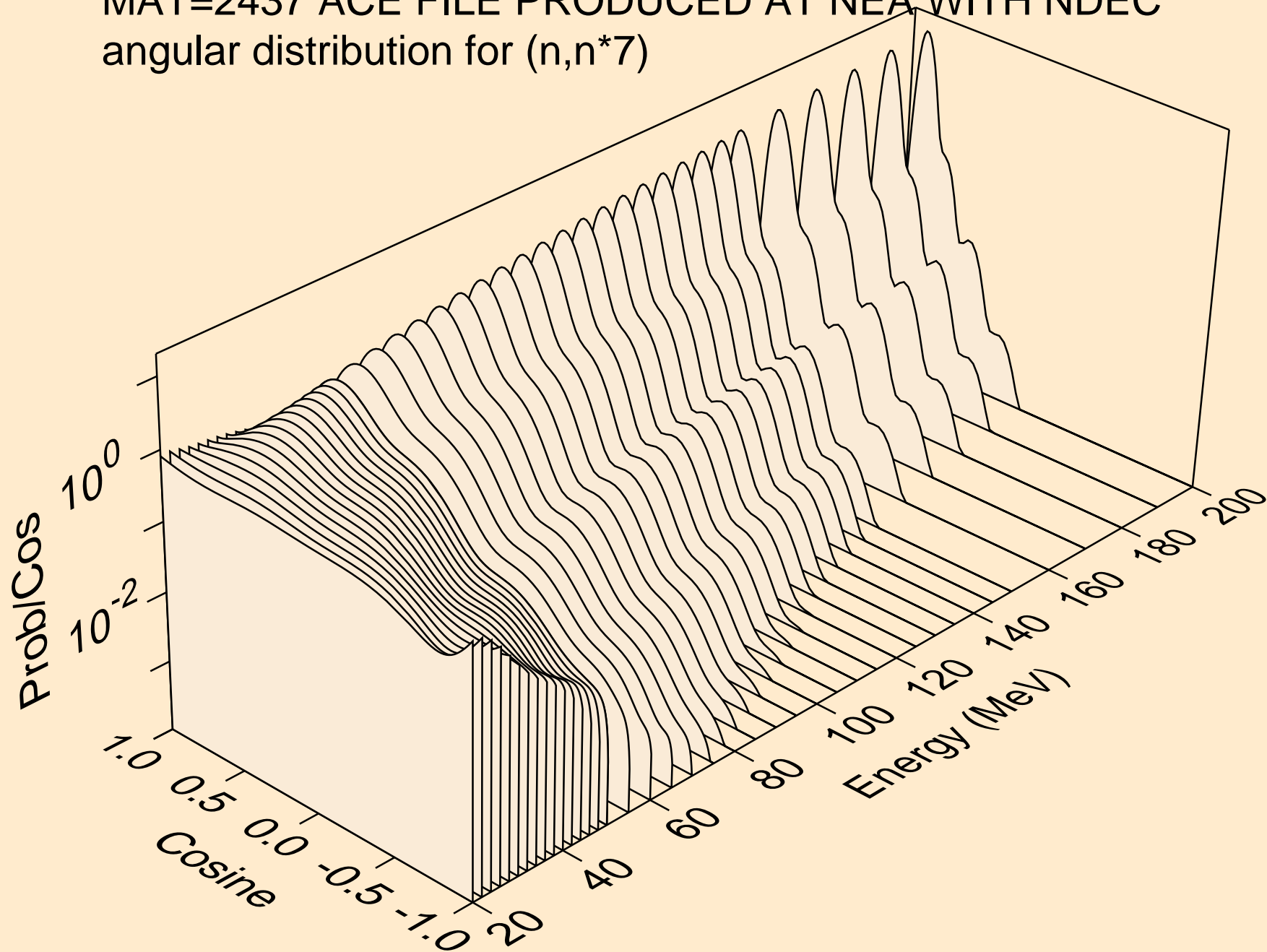

MAT=2437 ACE FILE PRODUCED AT NEA WITH NDEC  
angular distribution for (n,n\*8)

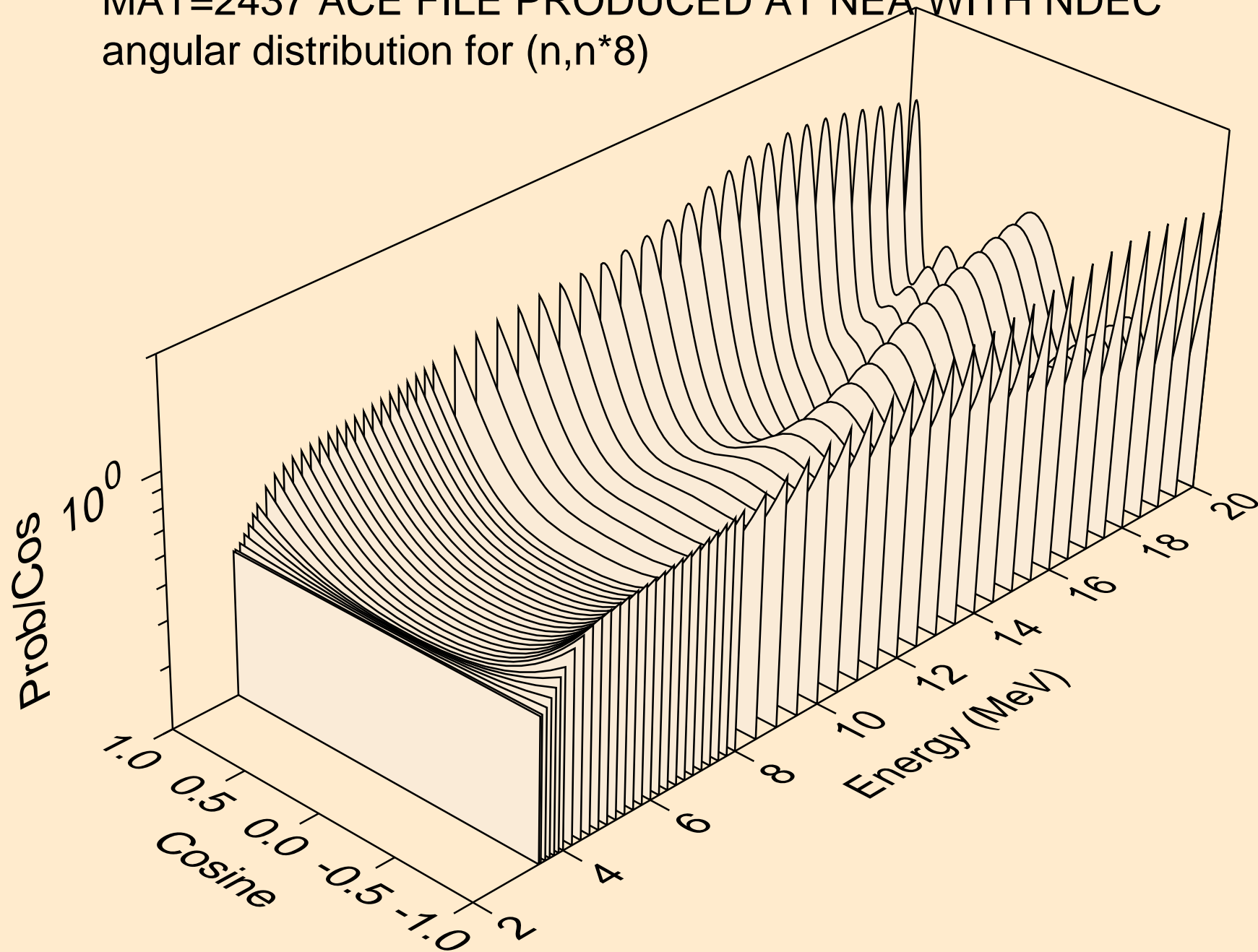

MAT=2437 ACE FILE PRODUCED AT NEA WITH NDEC  
angular distribution for (n,n\*8)

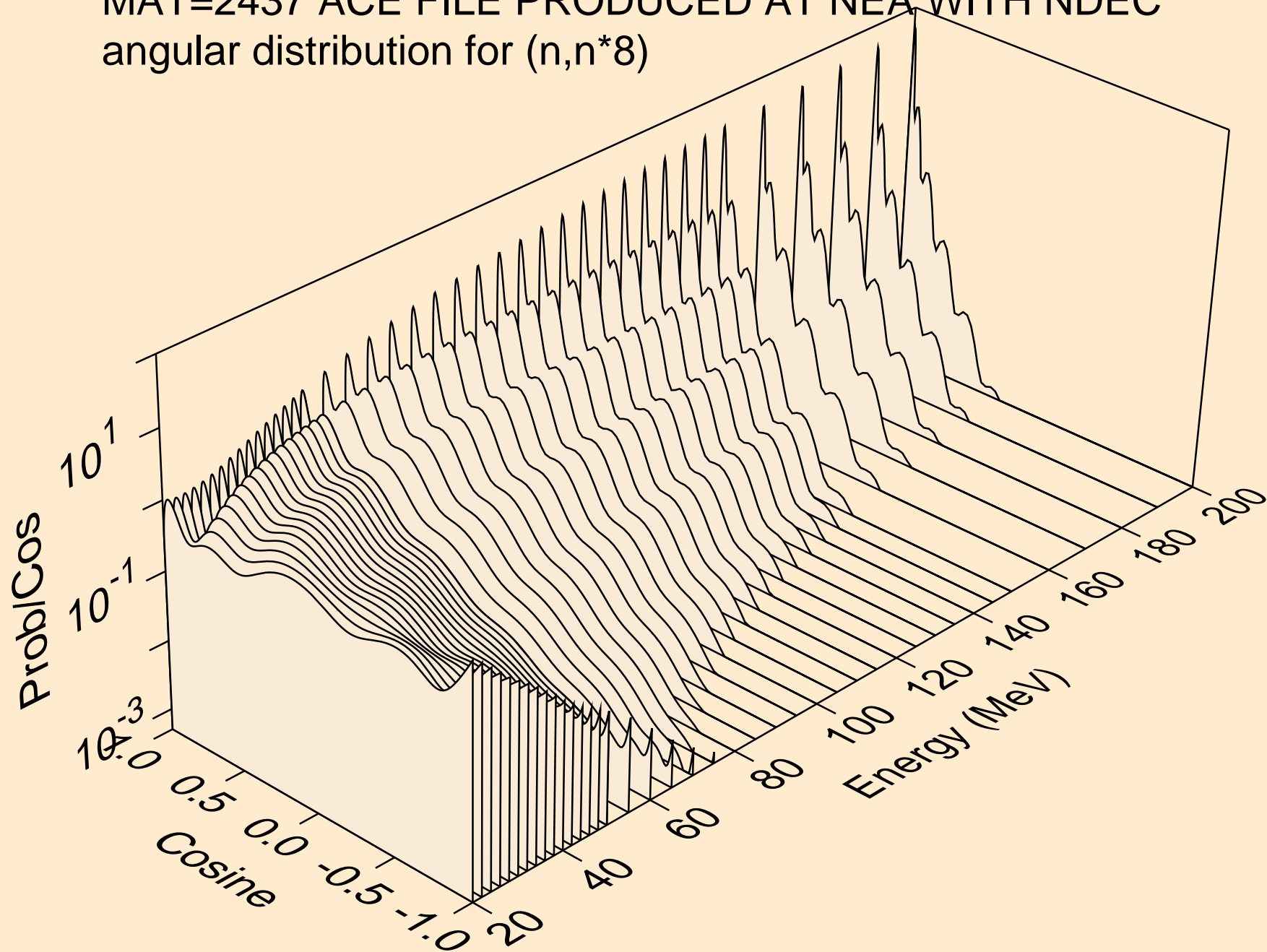

MAT=2437 ACE FILE PRODUCED AT NEA WITH NDEC  
angular distribution for (n,n\*9)

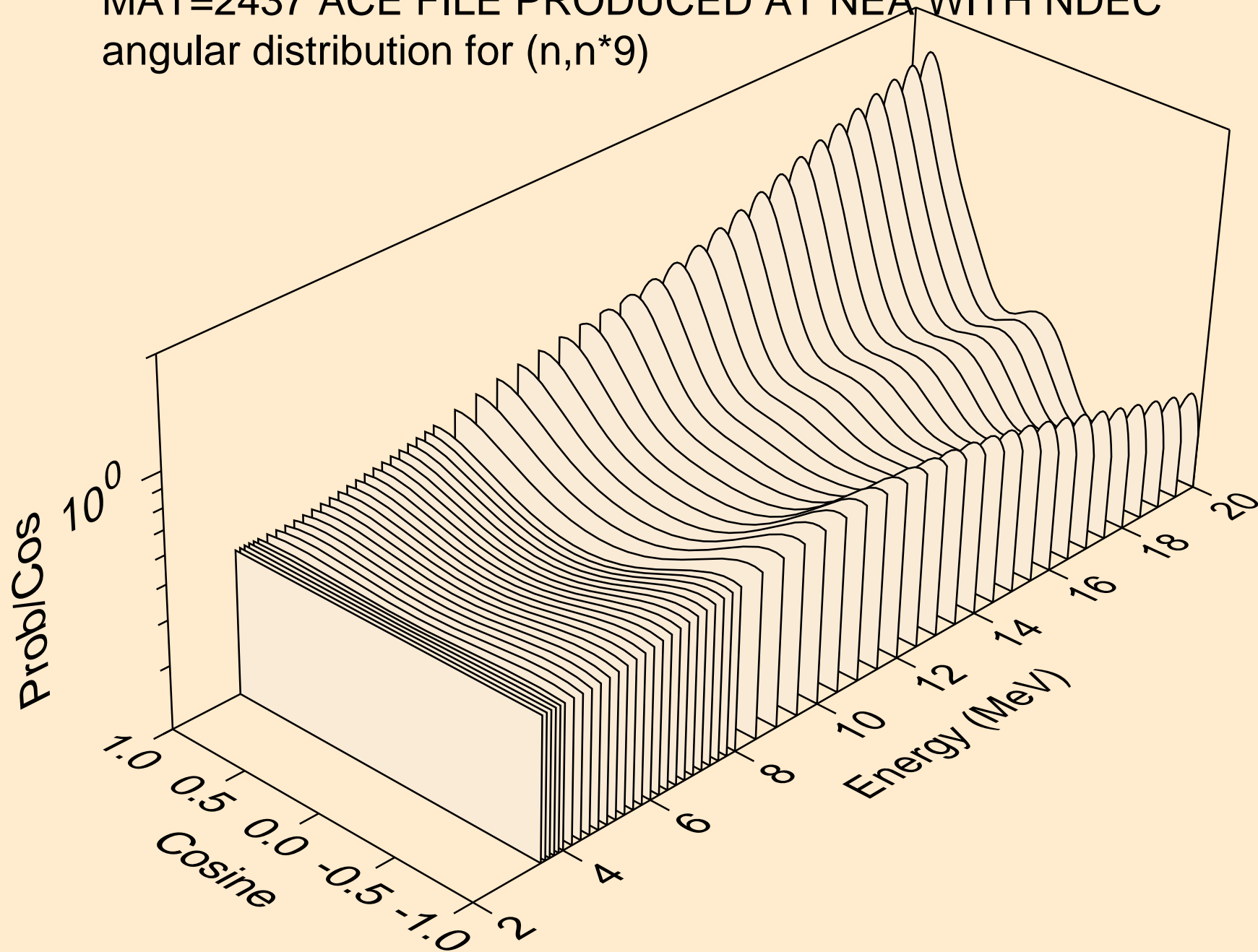

MAT=2437 ACE FILE PRODUCED AT NEA WITH NDEC  
angular distribution for (n,n\*9)

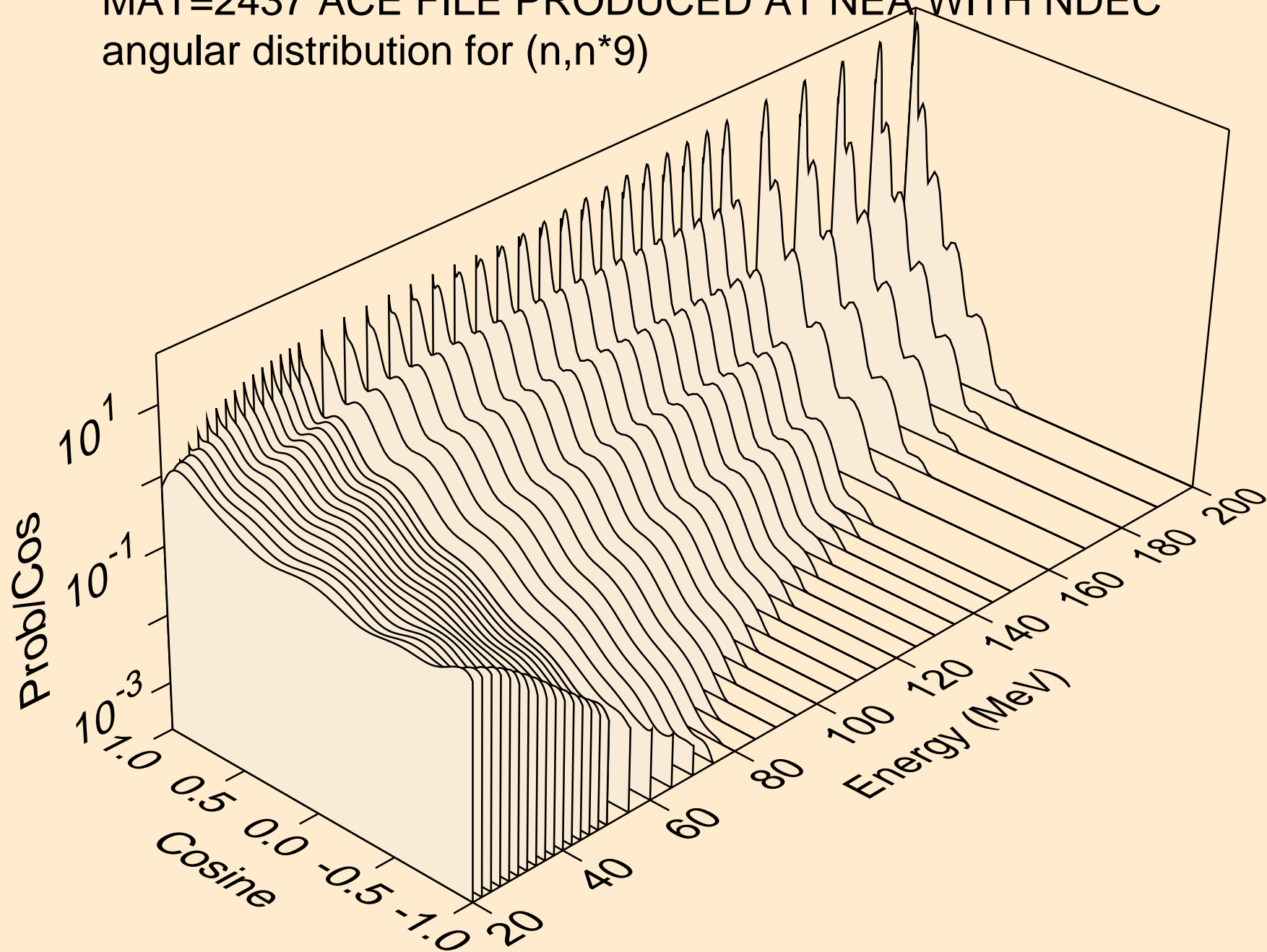

MAT=2437 ACE FILE PRODUCED AT NEA WITH NDEC  
angular distribution for (n,n\*10)

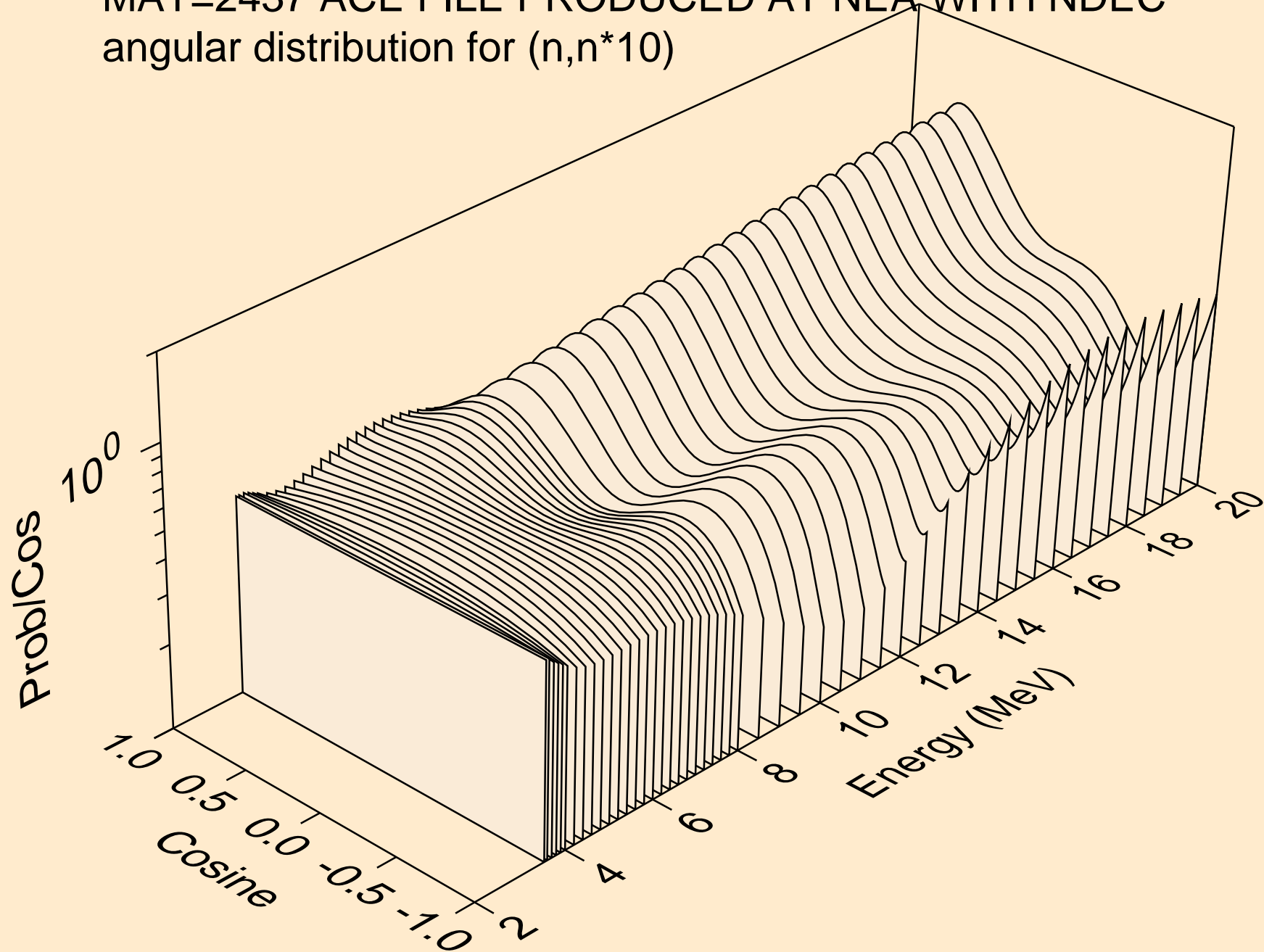

MAT=2437 ACE FILE PRODUCED AT NEA WITH NDEC  
angular distribution for (n,n\*10)

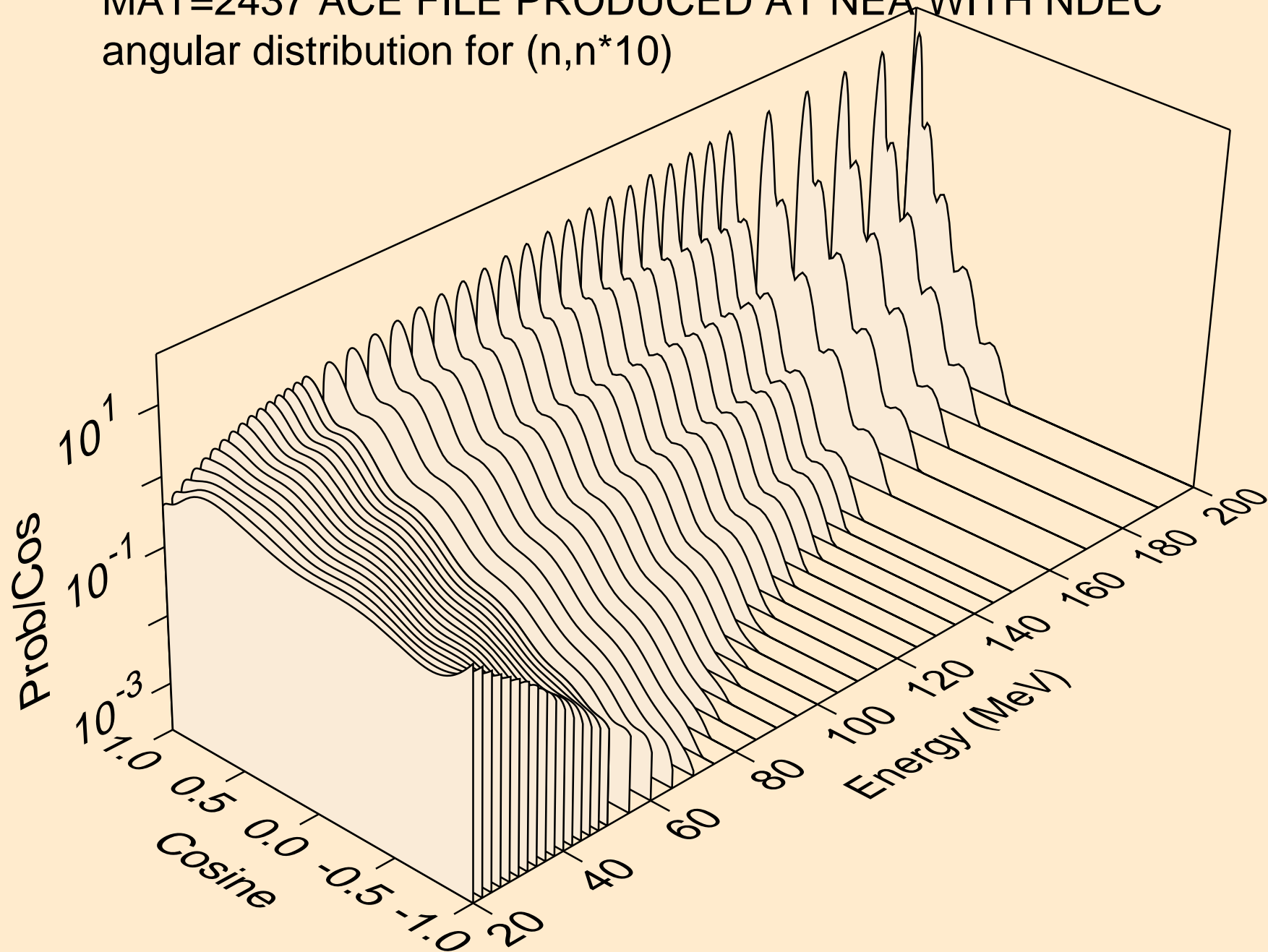

MAT=2437 ACE FILE PRODUCED AT NEA WITH NDEC  
angular distribution for (n,n\*11)

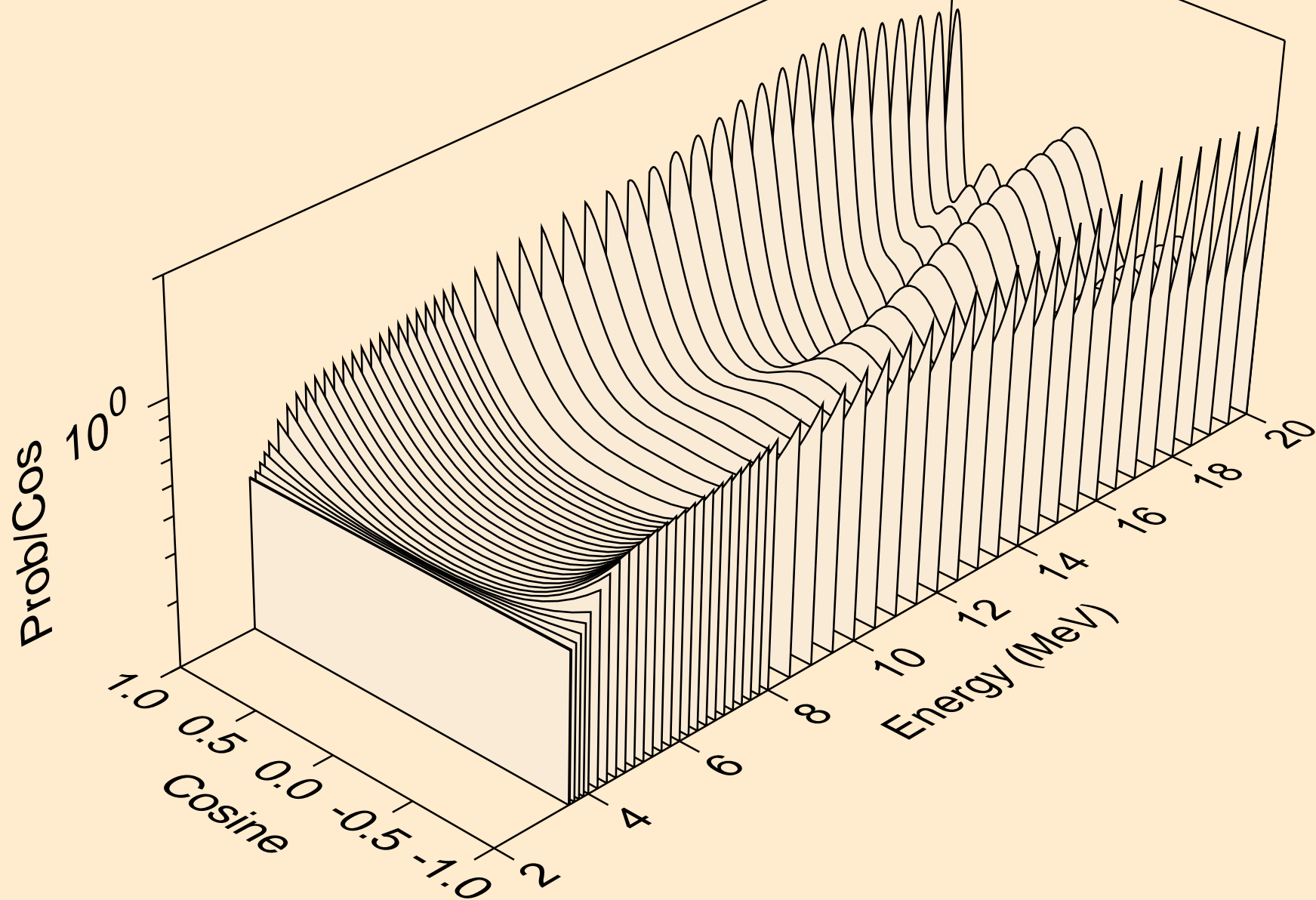

MAT=2437 ACE FILE PRODUCED AT NEA WITH NDEC  
angular distribution for (n,n\*11)

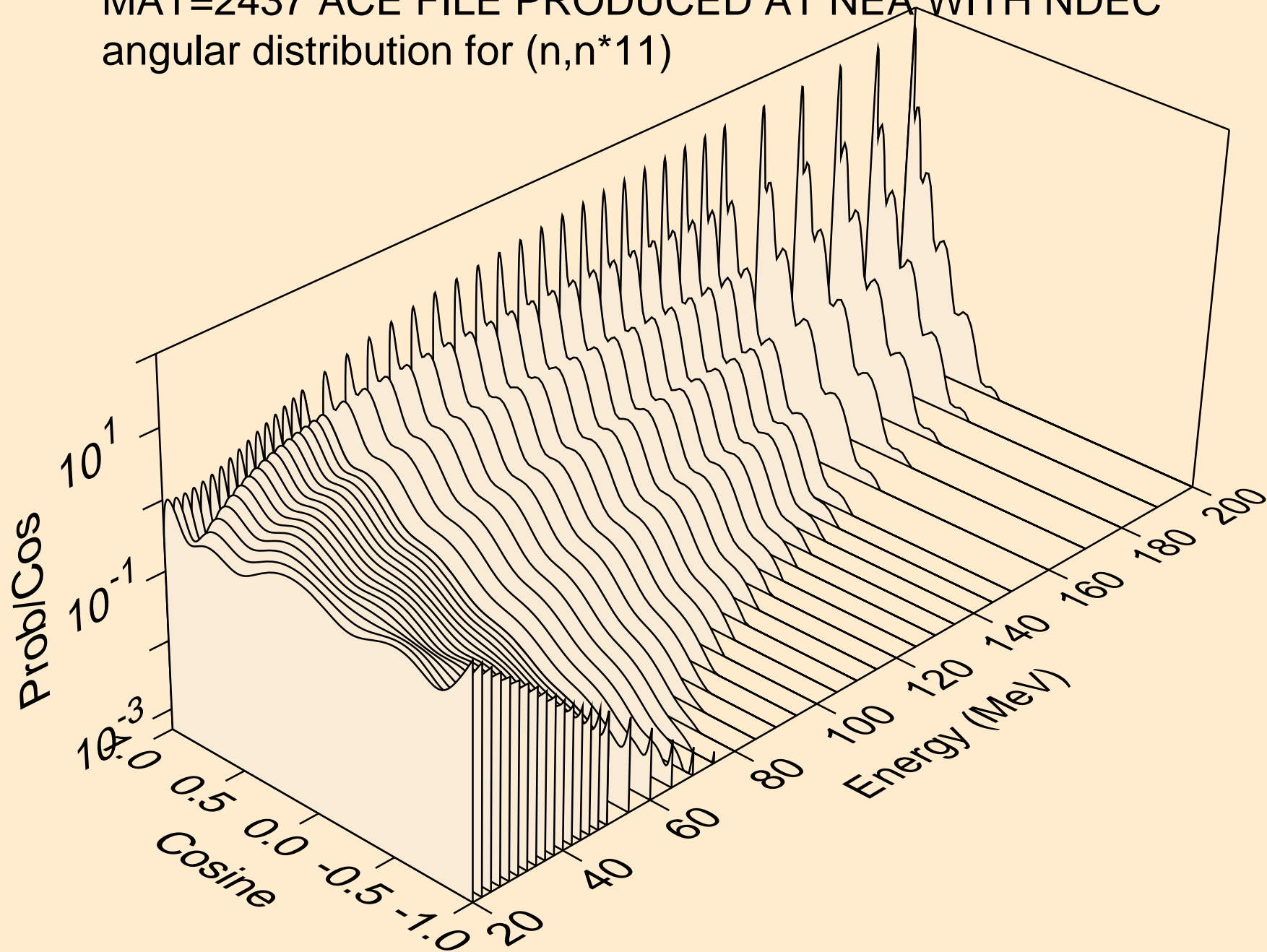

MAT=2437 ACE FILE PRODUCED AT NEA WITH NDEC  
angular distribution for (n,n\*12)

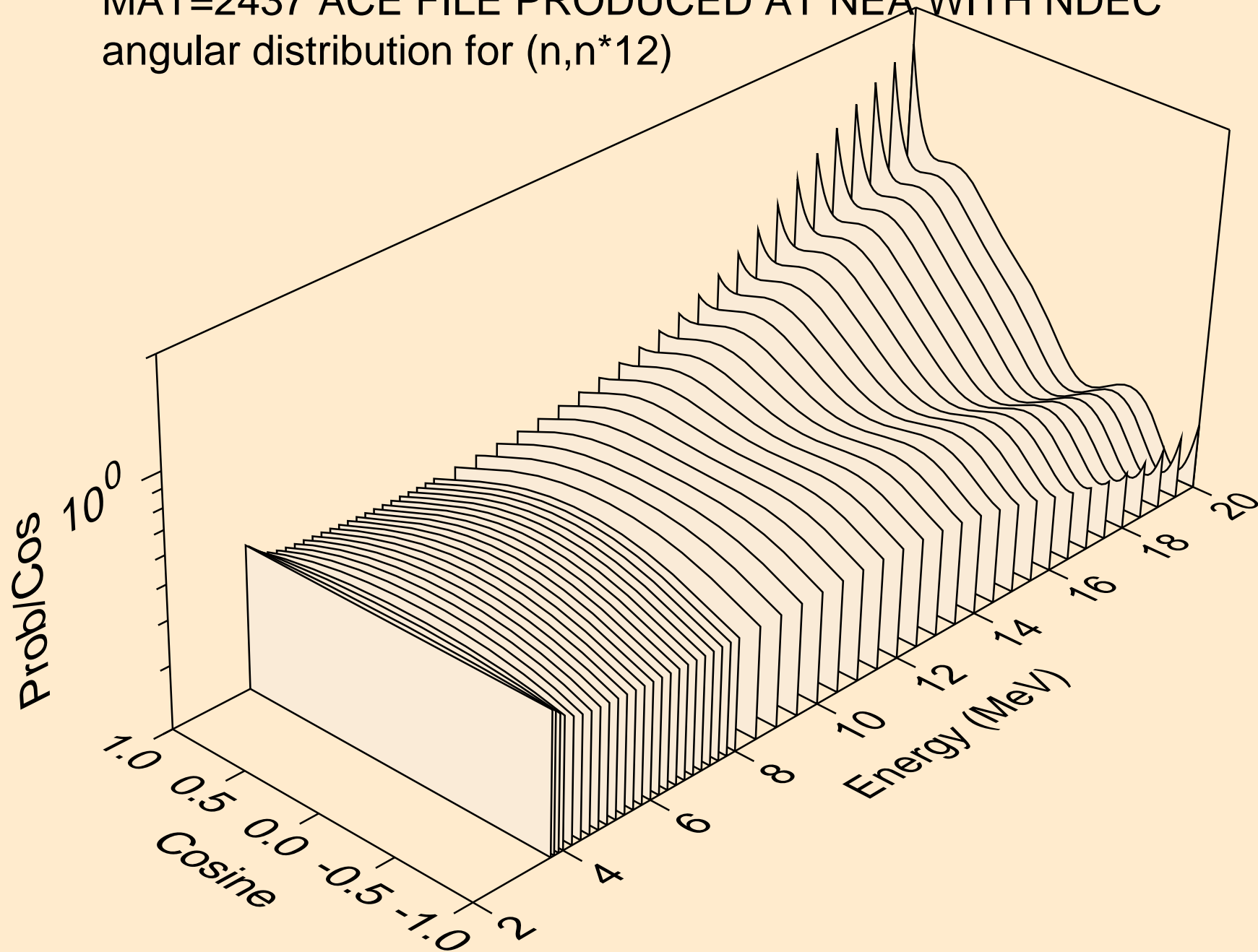

MAT=2437 ACE FILE PRODUCED AT NEA WITH NDEC  
angular distribution for (n,n\*12)

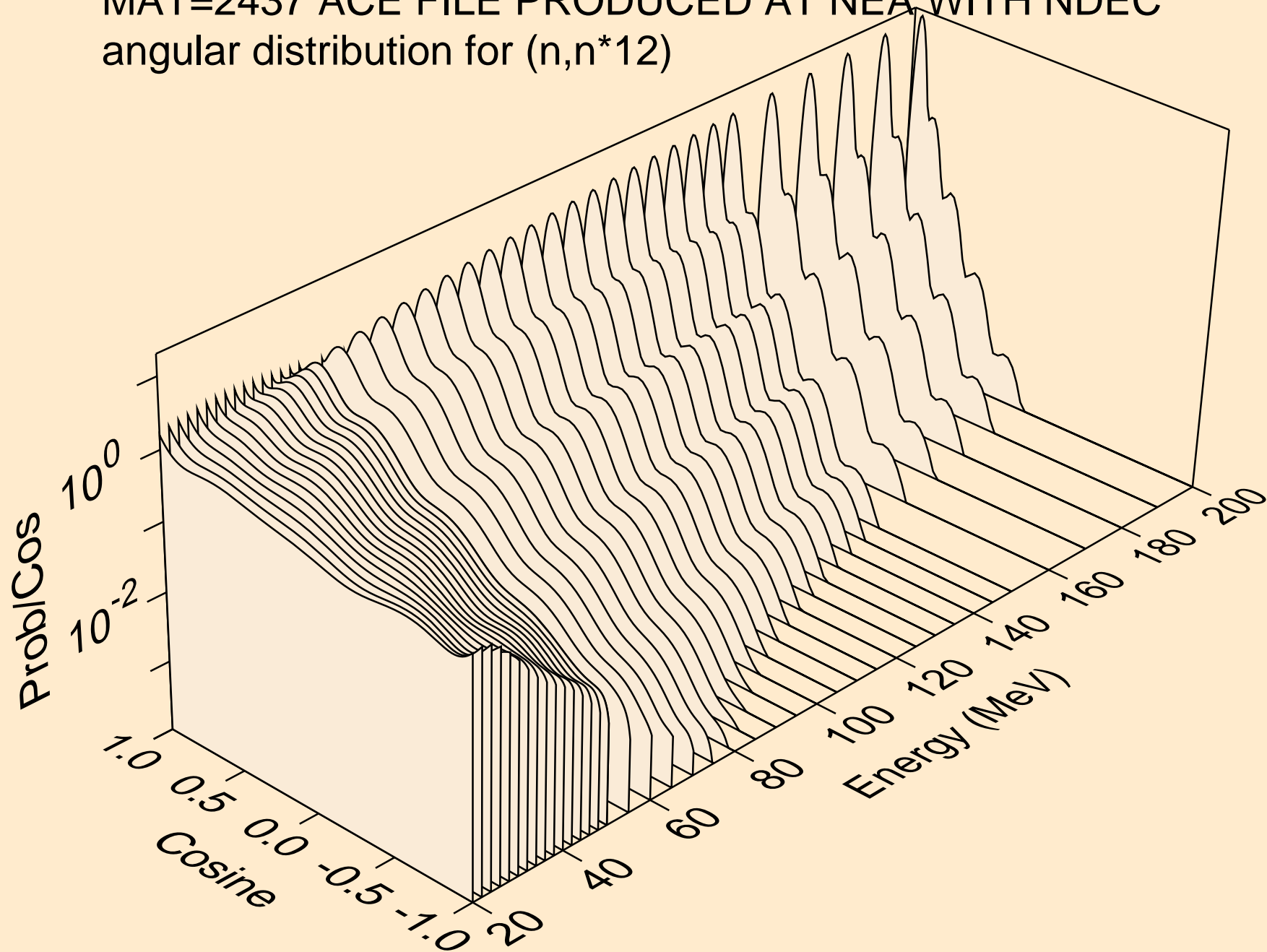

MAT=2437 ACE FILE PRODUCED AT NEA WITH NDEC  
angular distribution for (n,n\*13)

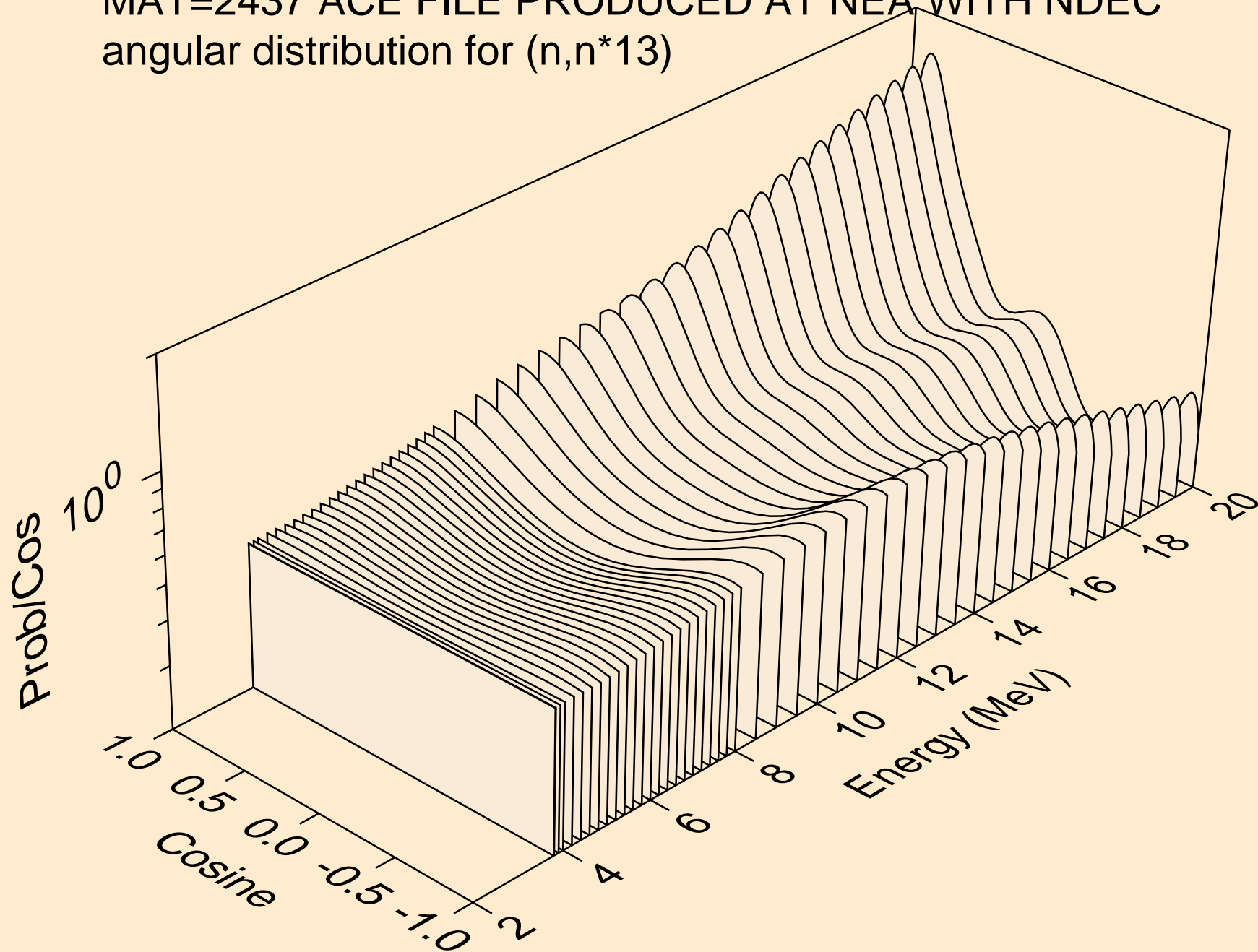

MAT=2437 ACE FILE PRODUCED AT NEA WITH NDEC  
angular distribution for (n,n\*13)

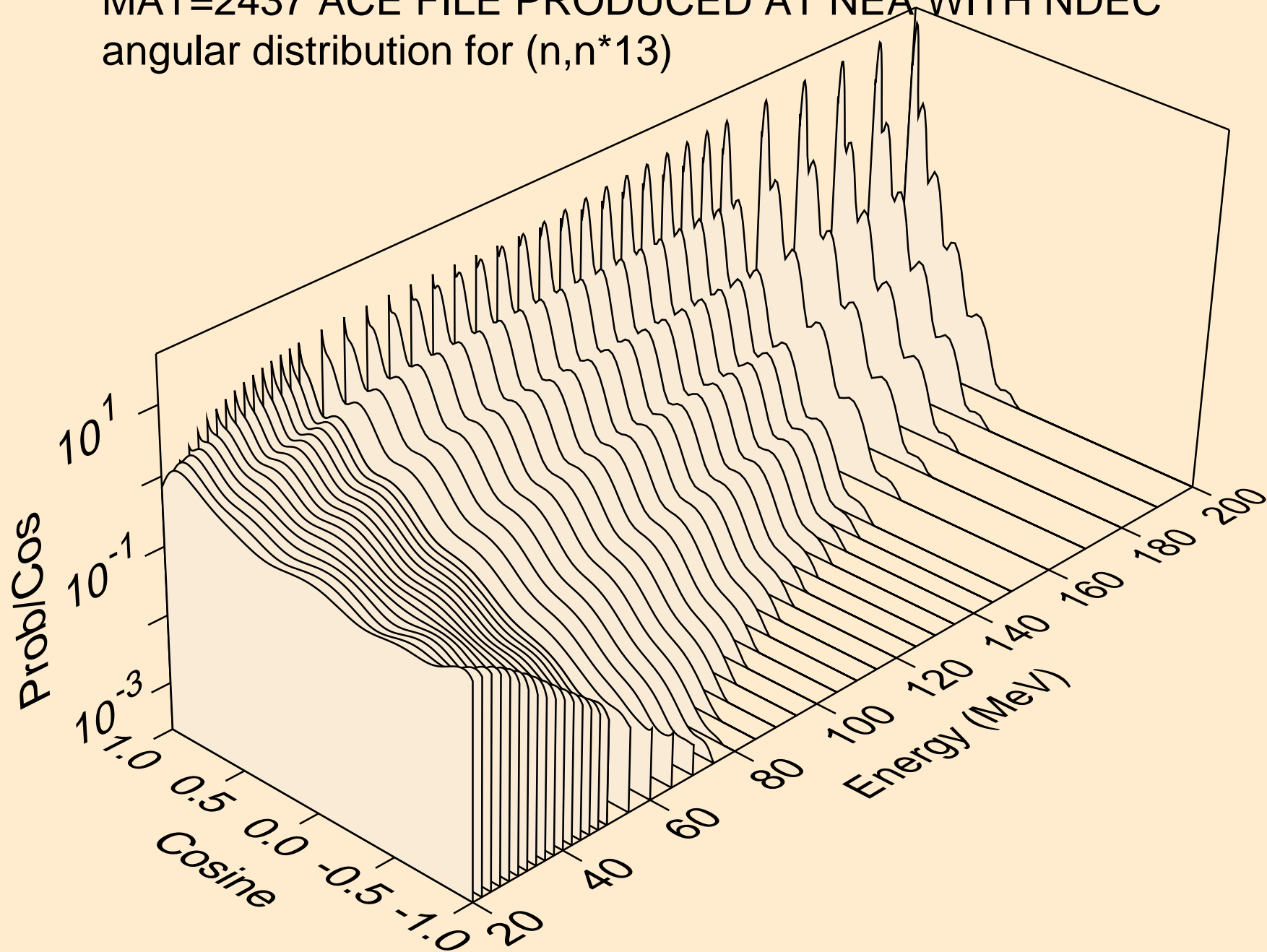

MAT=2437 ACE FILE PRODUCED AT NEA WITH NDEC  
angular distribution for (n,n\*14)

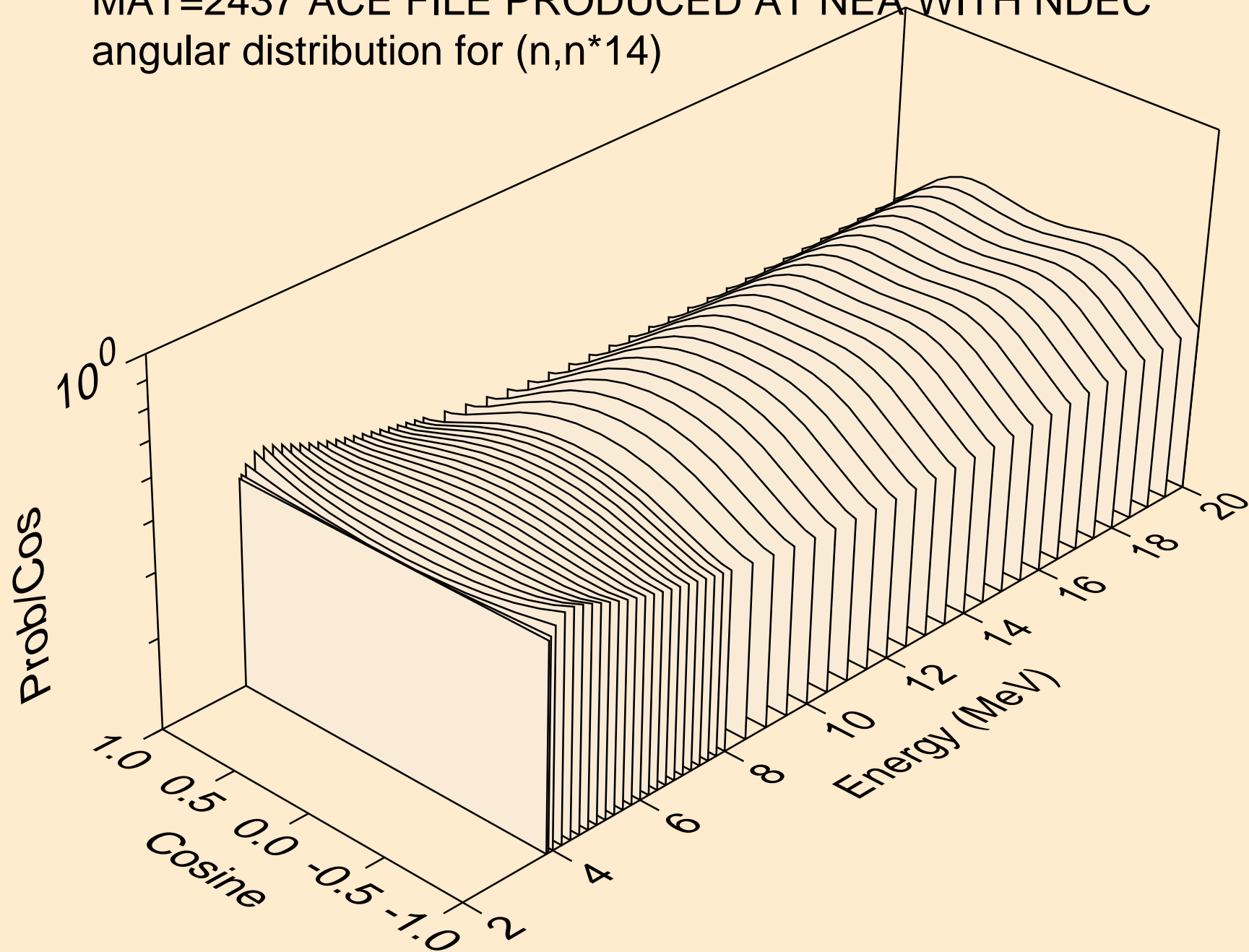

MAT=2437 ACE FILE PRODUCED AT NEA WITH NDEC  
angular distribution for (n,n\*14)

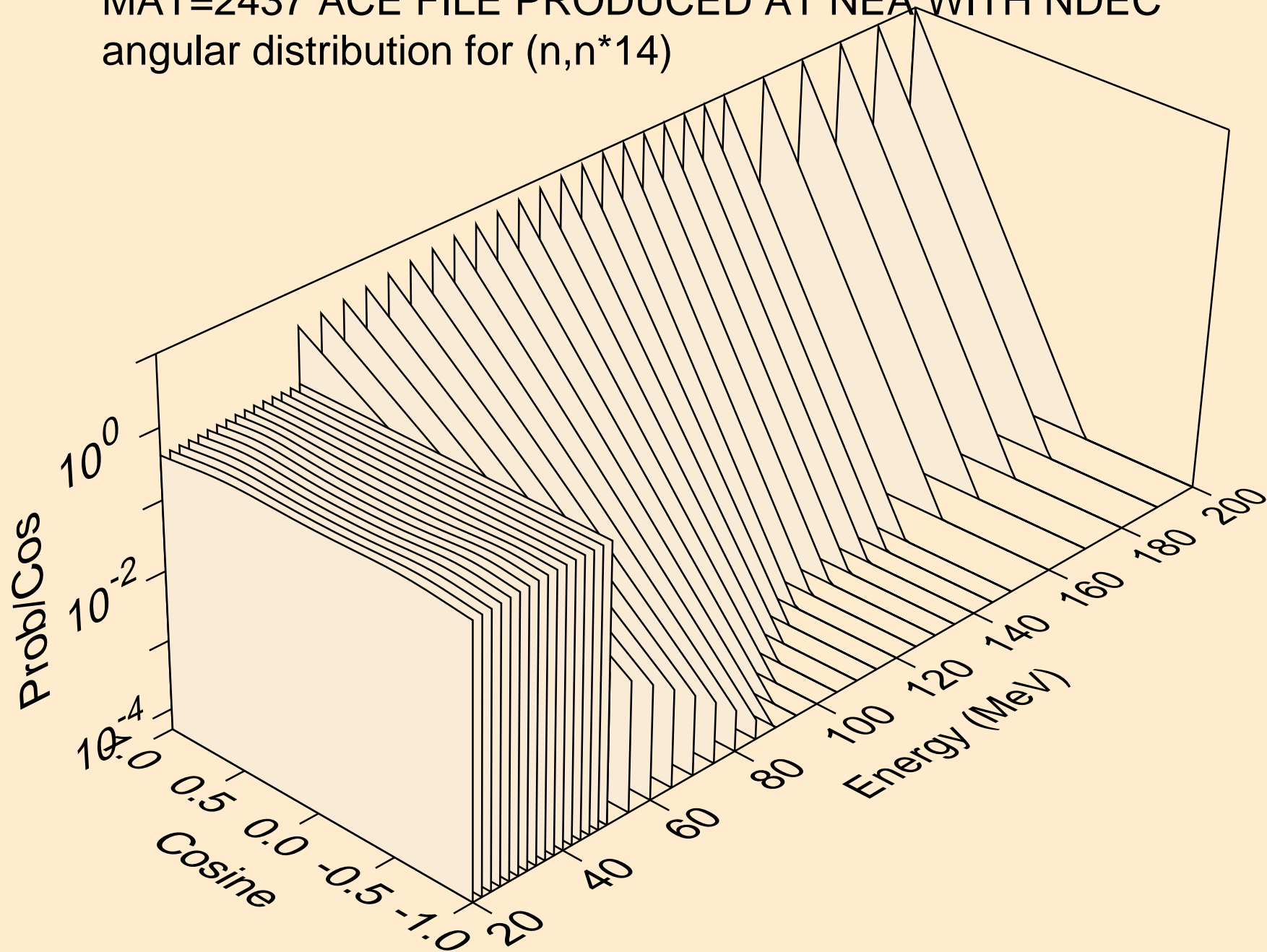

MAT=2437 ACE FILE PRODUCED AT NEA WITH NDEC  
angular distribution for (n,n\*15)

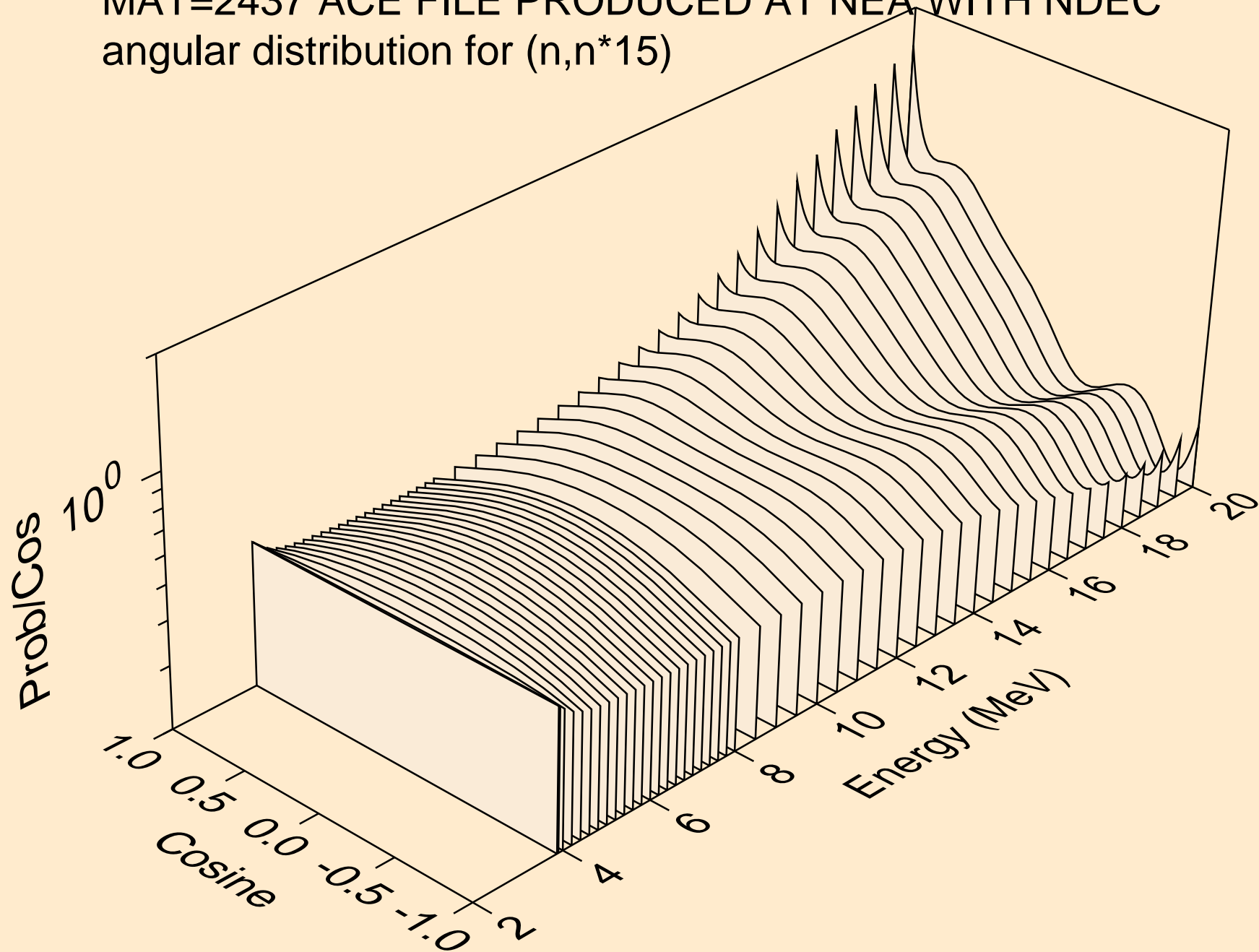

MAT=2437 ACE FILE PRODUCED AT NEA WITH NDEC  
angular distribution for (n,n\*15)

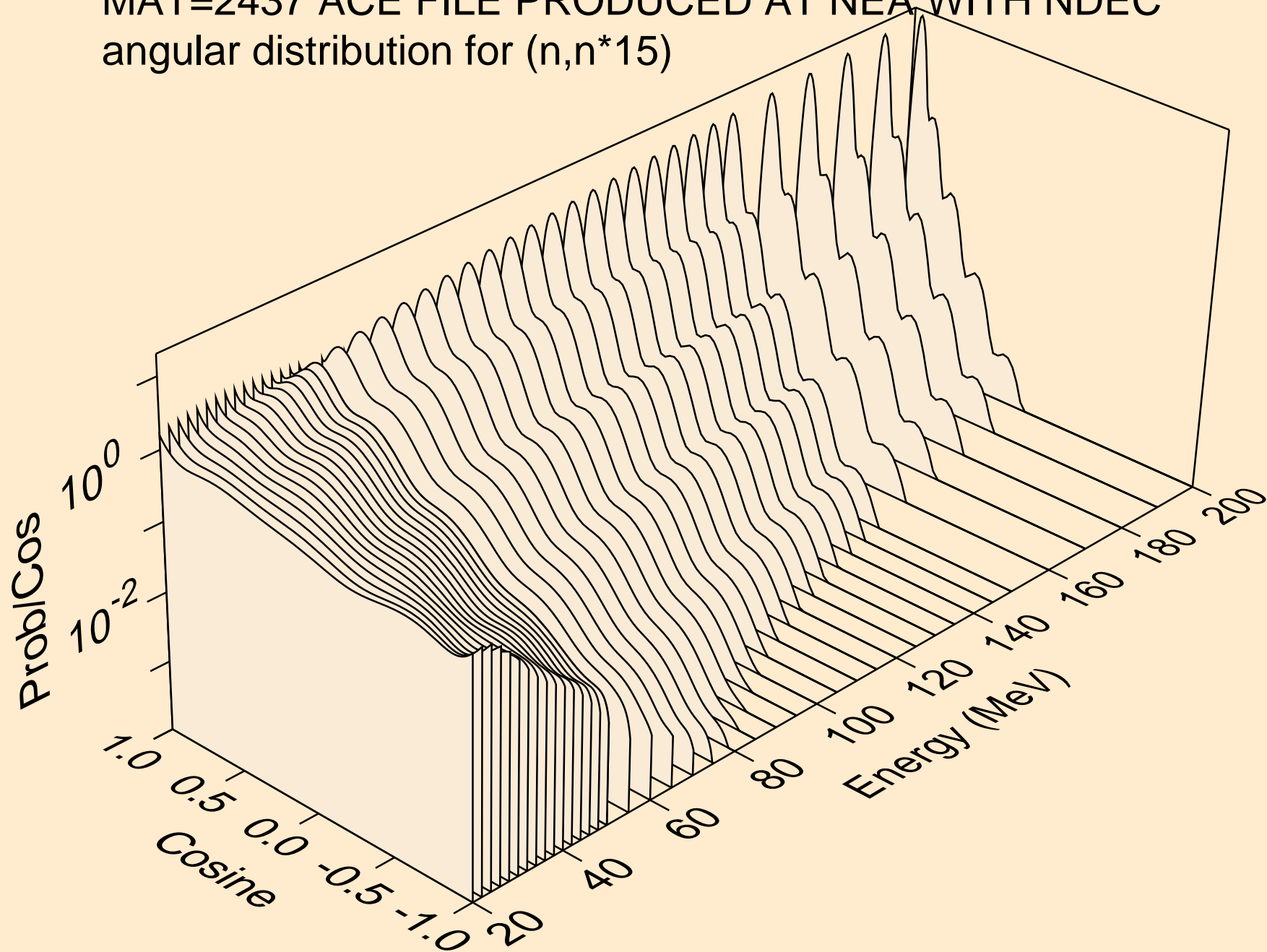

MAT=2437 ACE FILE PRODUCED AT NEA WITH NDEC  
angular distribution for (n,n\*16)

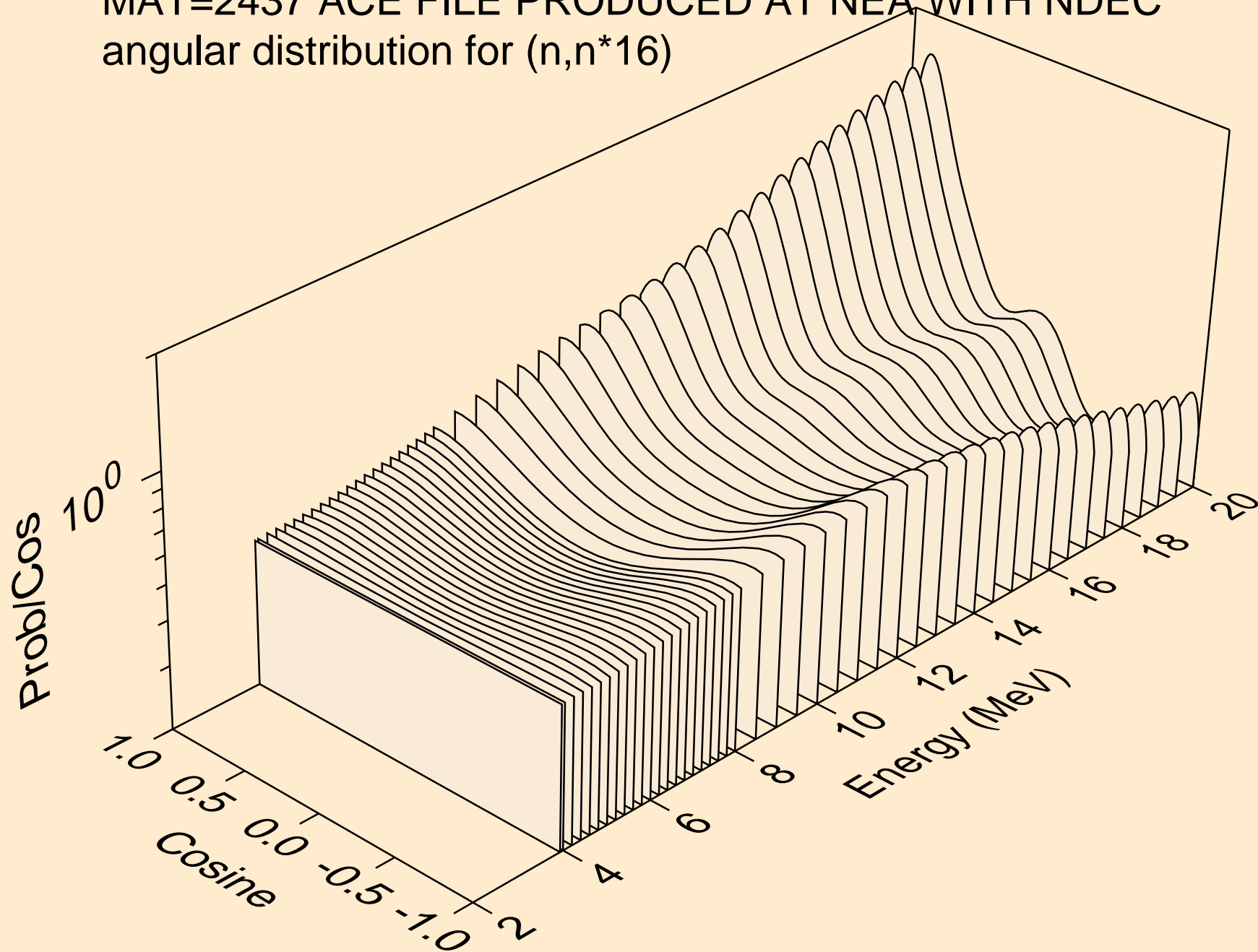

MAT=2437 ACE FILE PRODUCED AT NEA WITH NDEC  
angular distribution for (n,n\*16)

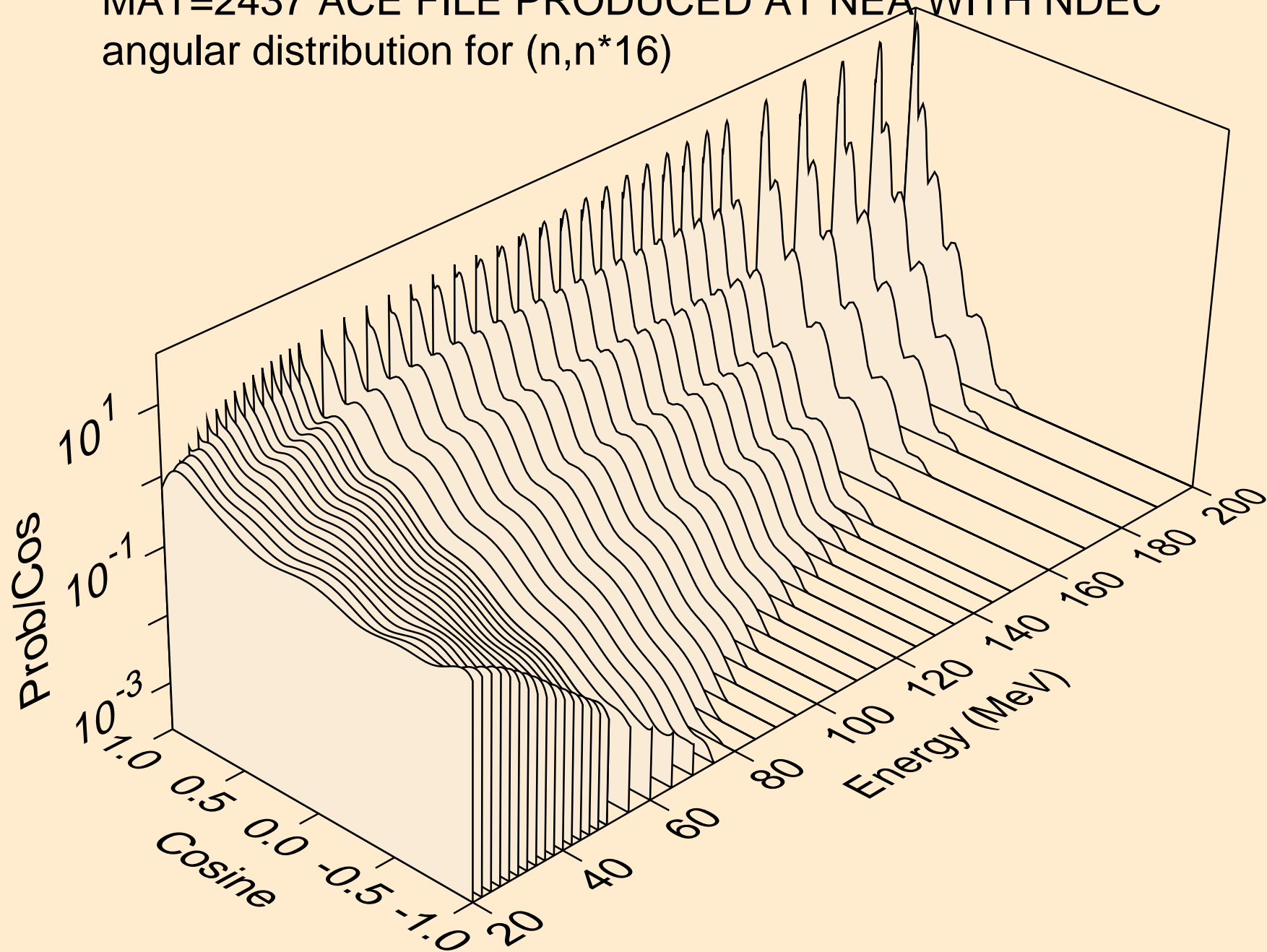

MAT=2437 ACE FILE PRODUCED AT NEA WITH NDEC  
angular distribution for (n,n\*17)

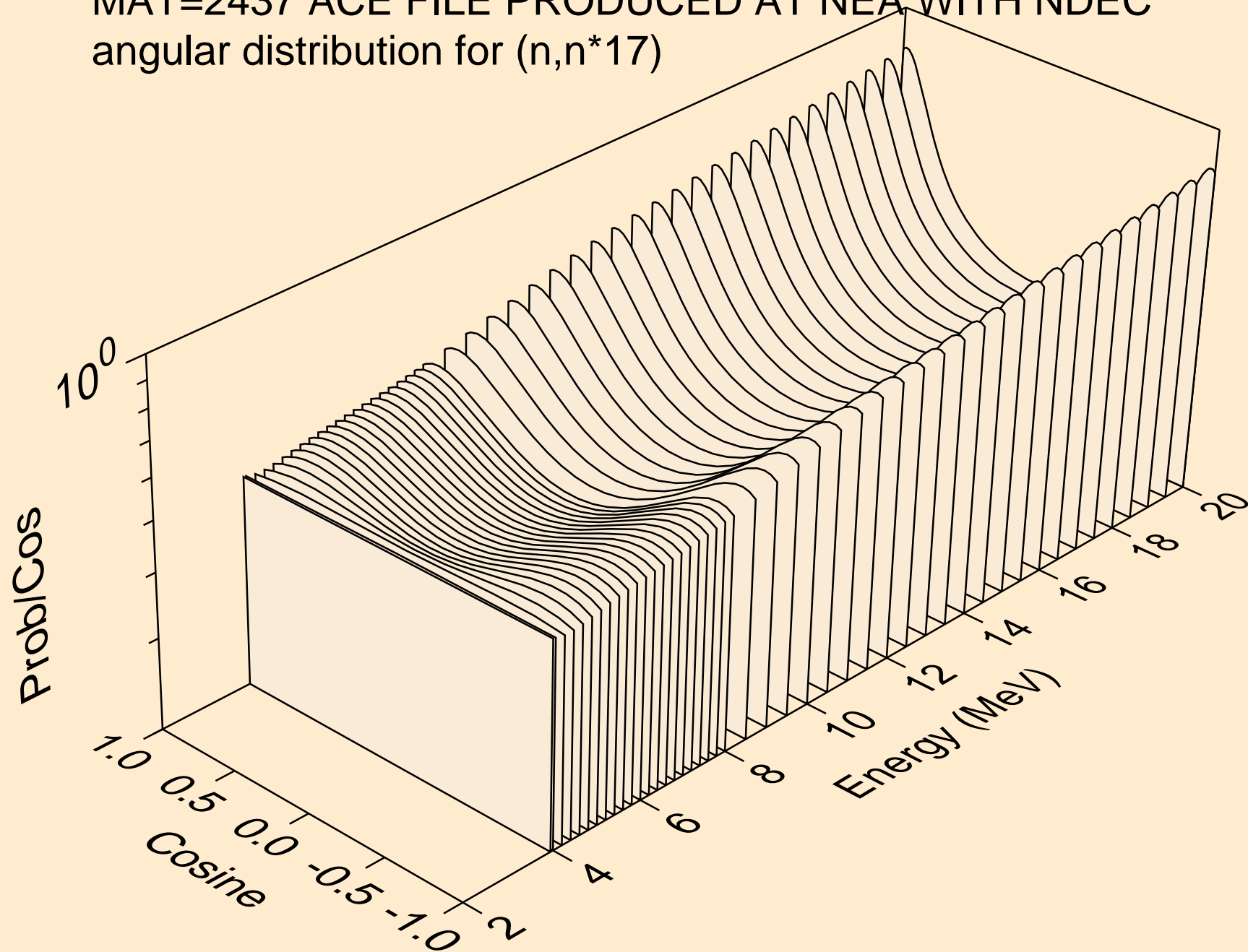

MAT=2437 ACE FILE PRODUCED AT NEA WITH NDEC  
angular distribution for (n,n\*17)

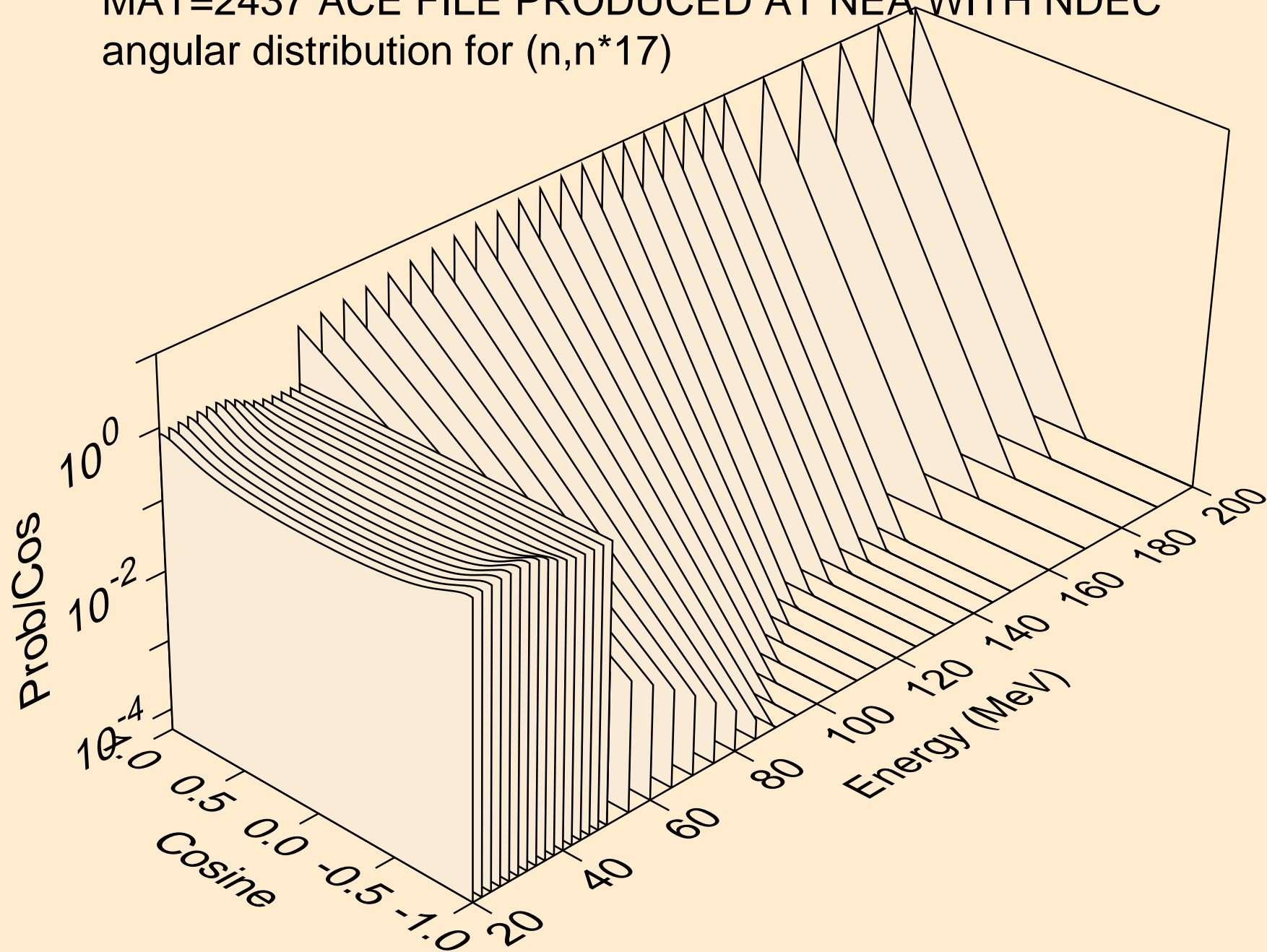

MAT=2437 ACE FILE PRODUCED AT NEA WITH NDEC  
angular distribution for (n,n\*18)

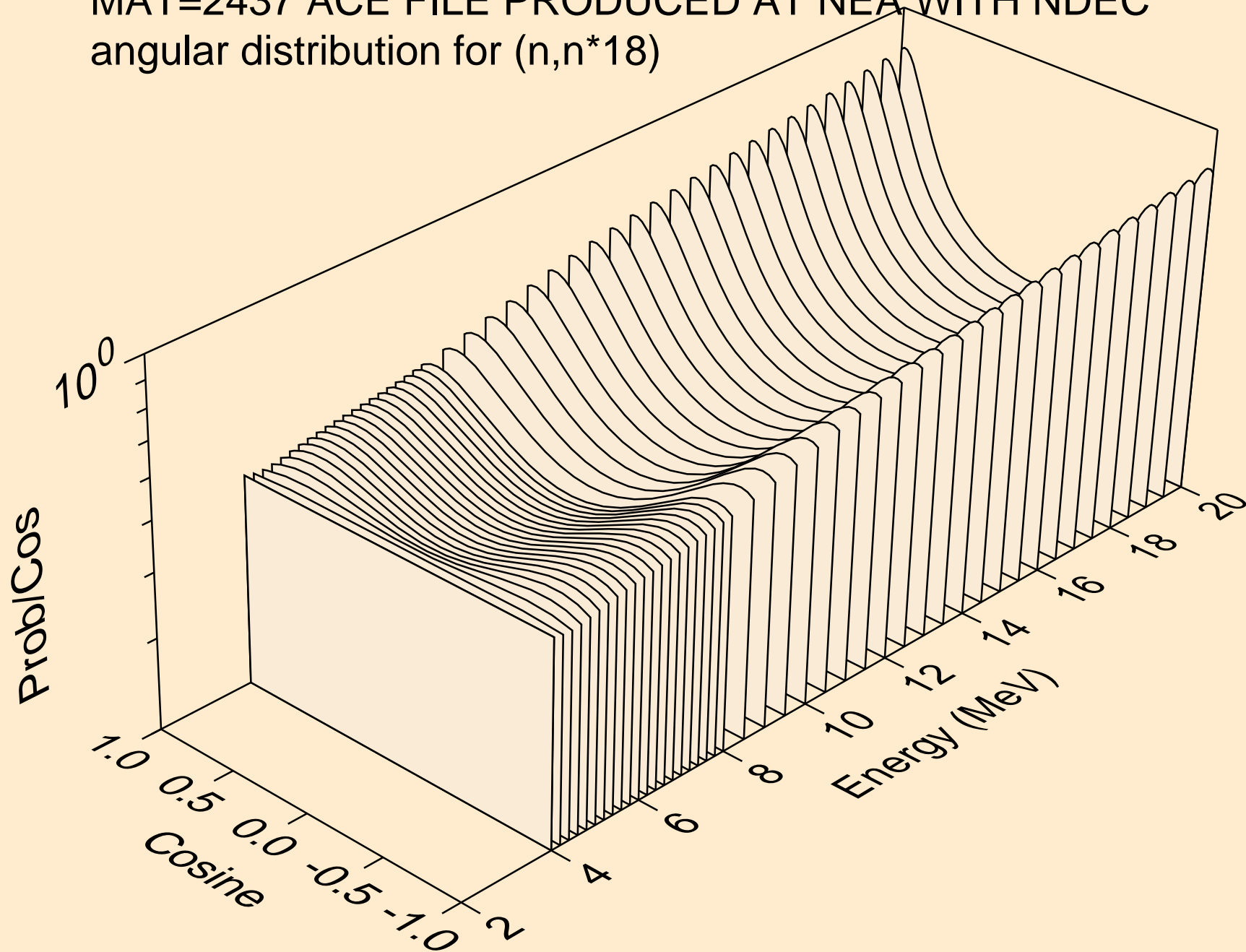

MAT=2437 ACE FILE PRODUCED AT NEA WITH NDEC  
angular distribution for (n,n\*18)

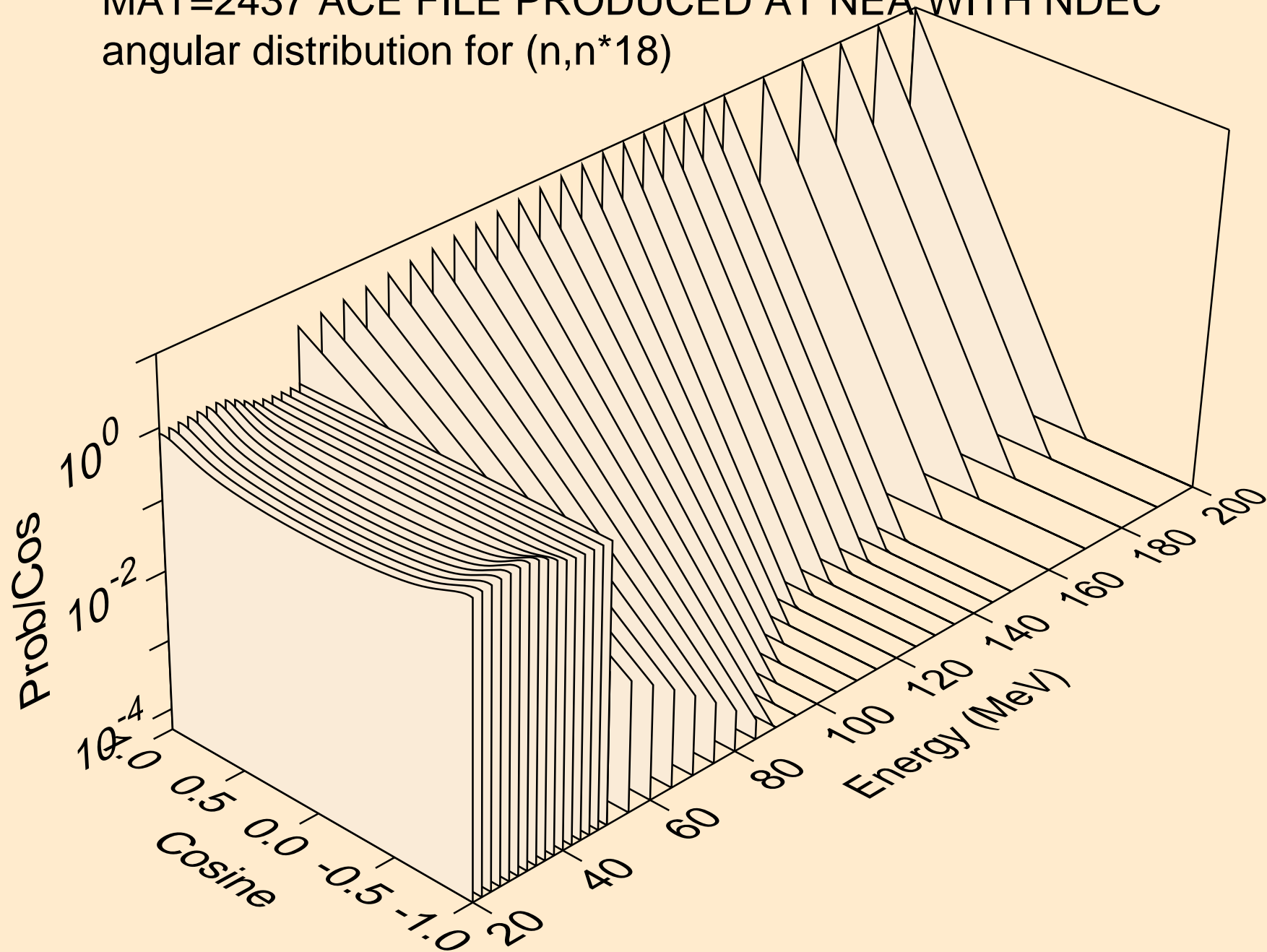

MAT=2437 ACE FILE PRODUCED AT NEA WITH NDEC  
angular distribution for (n,n\*19)

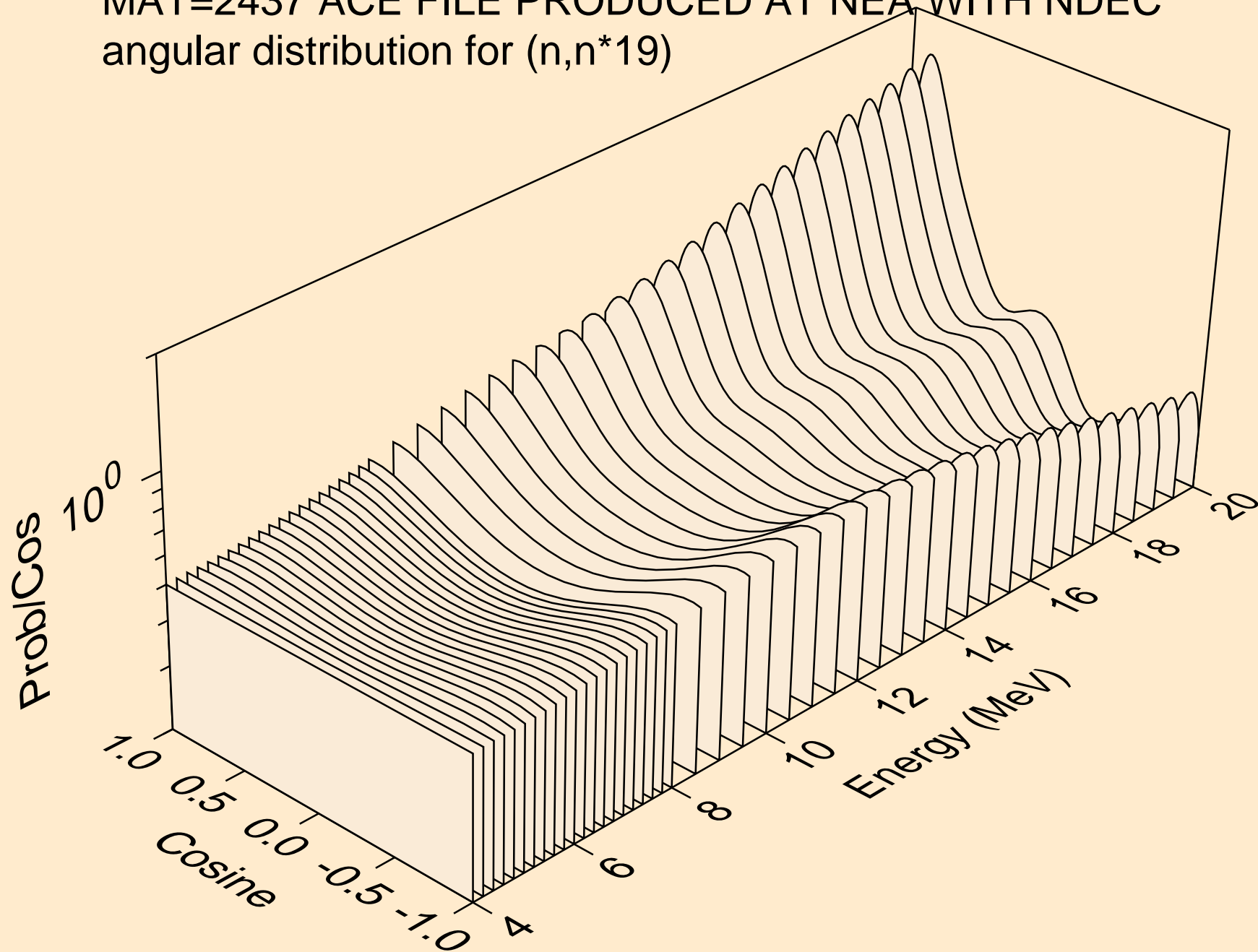

MAT=2437 ACE FILE PRODUCED AT NEA WITH NDEC  
angular distribution for (n,n\*19)

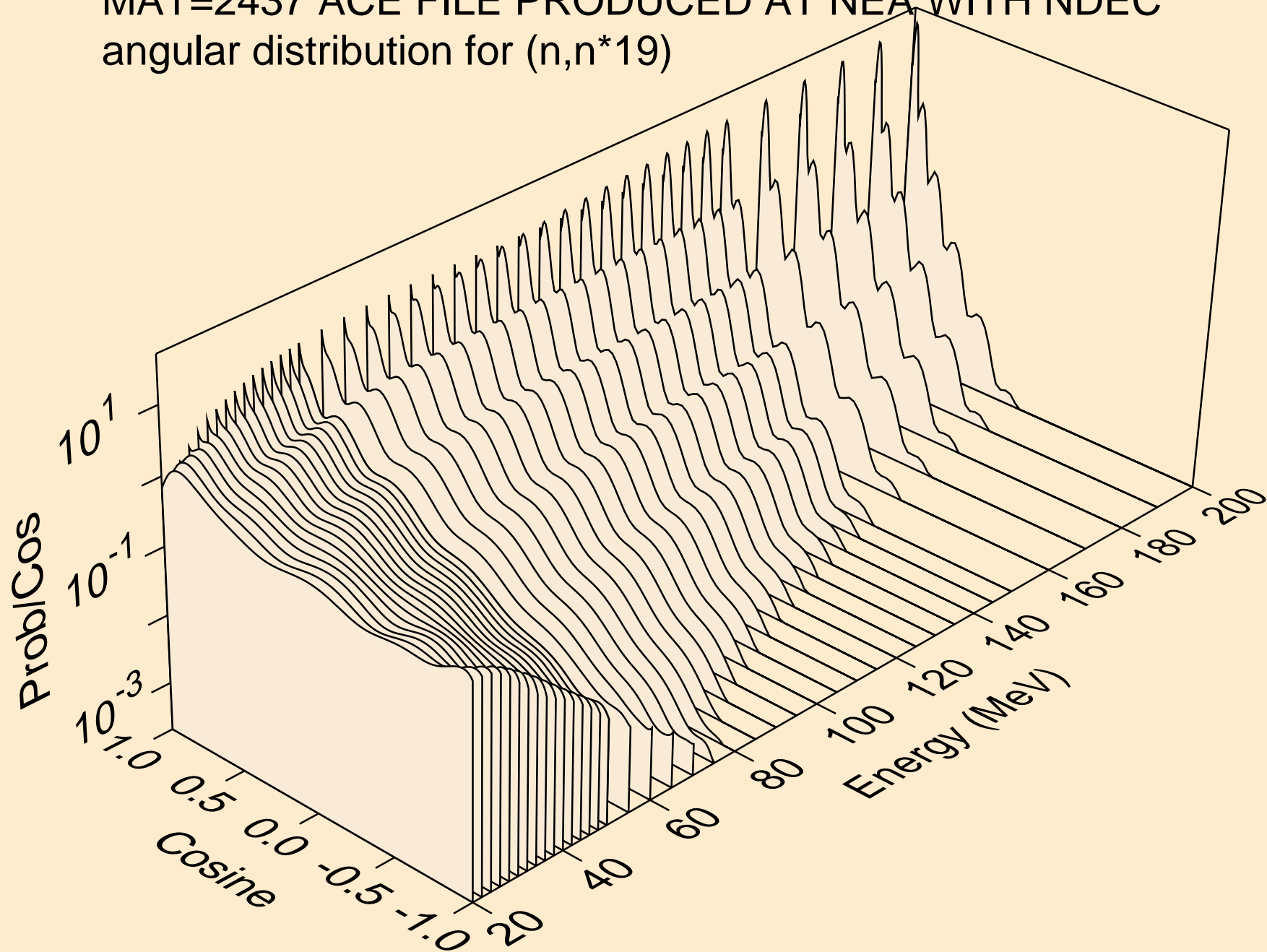

MAT=2437 ACE FILE PRODUCED AT NEA WITH NDEC  
angular distribution for (n,n\*20)

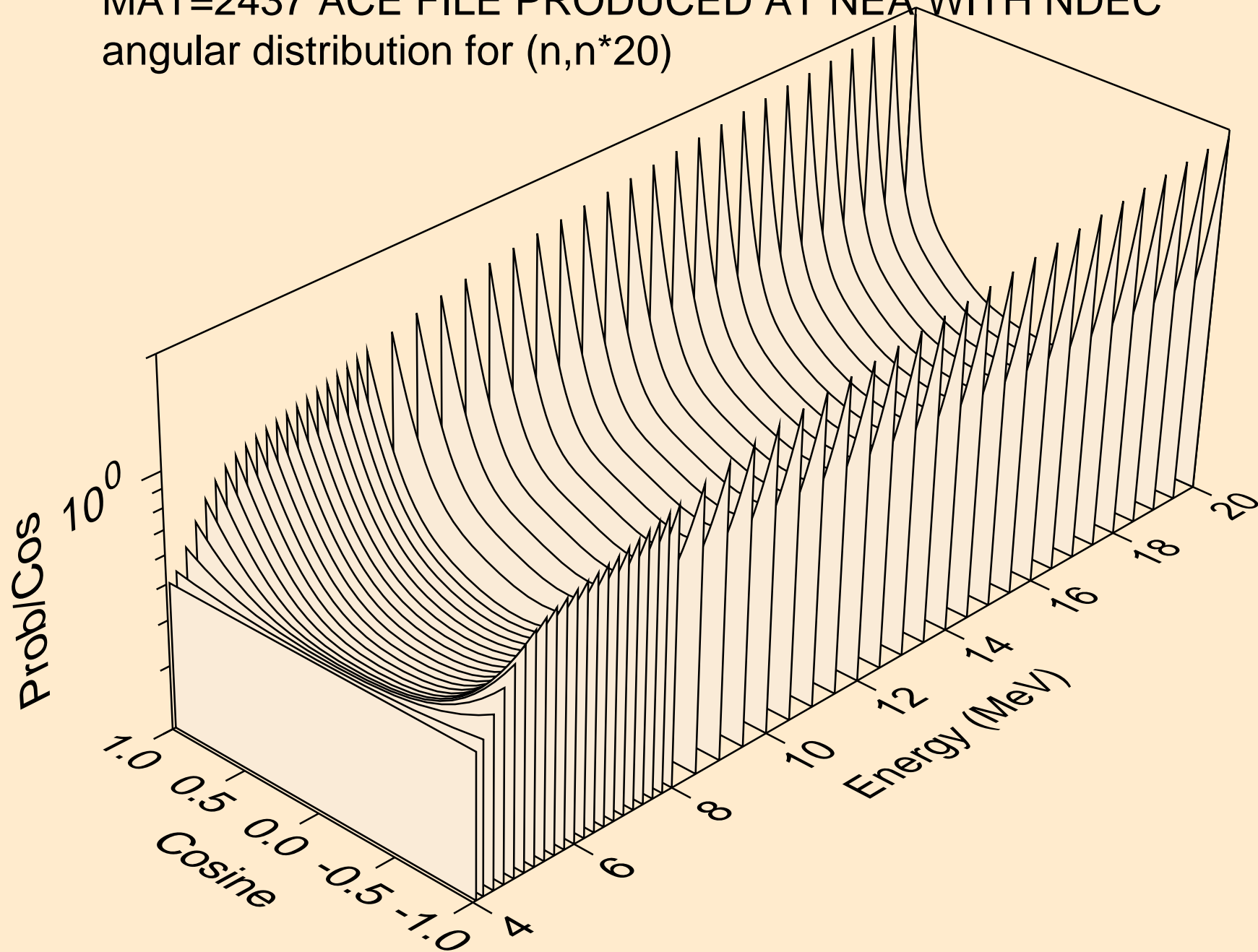

MAT=2437 ACE FILE PRODUCED AT NEA WITH NDEC  
angular distribution for (n,n\*20)

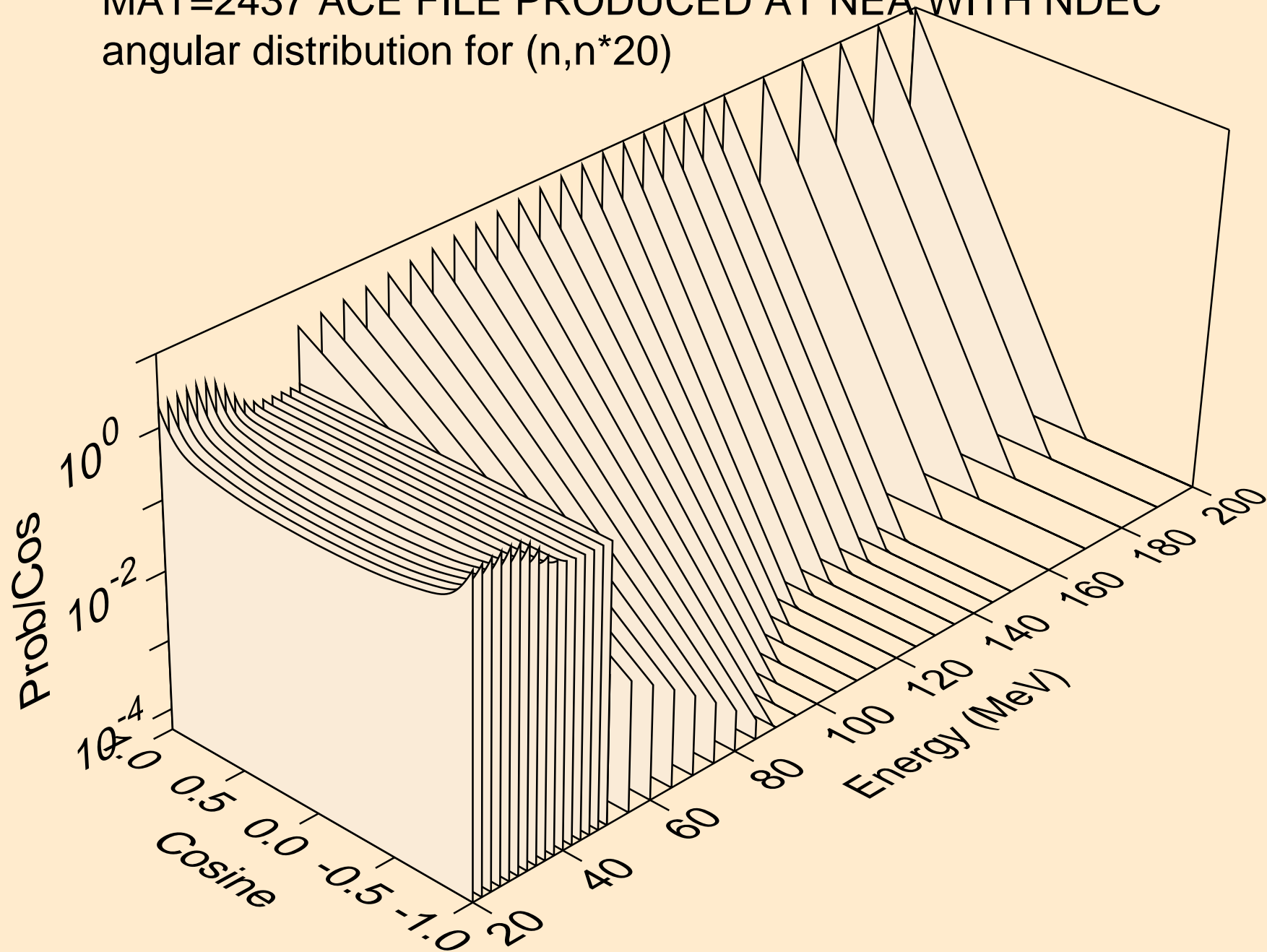

MAT=2437 ACE FILE PRODUCED AT NEA WITH NDEC  
Neutron emission for (n,x)

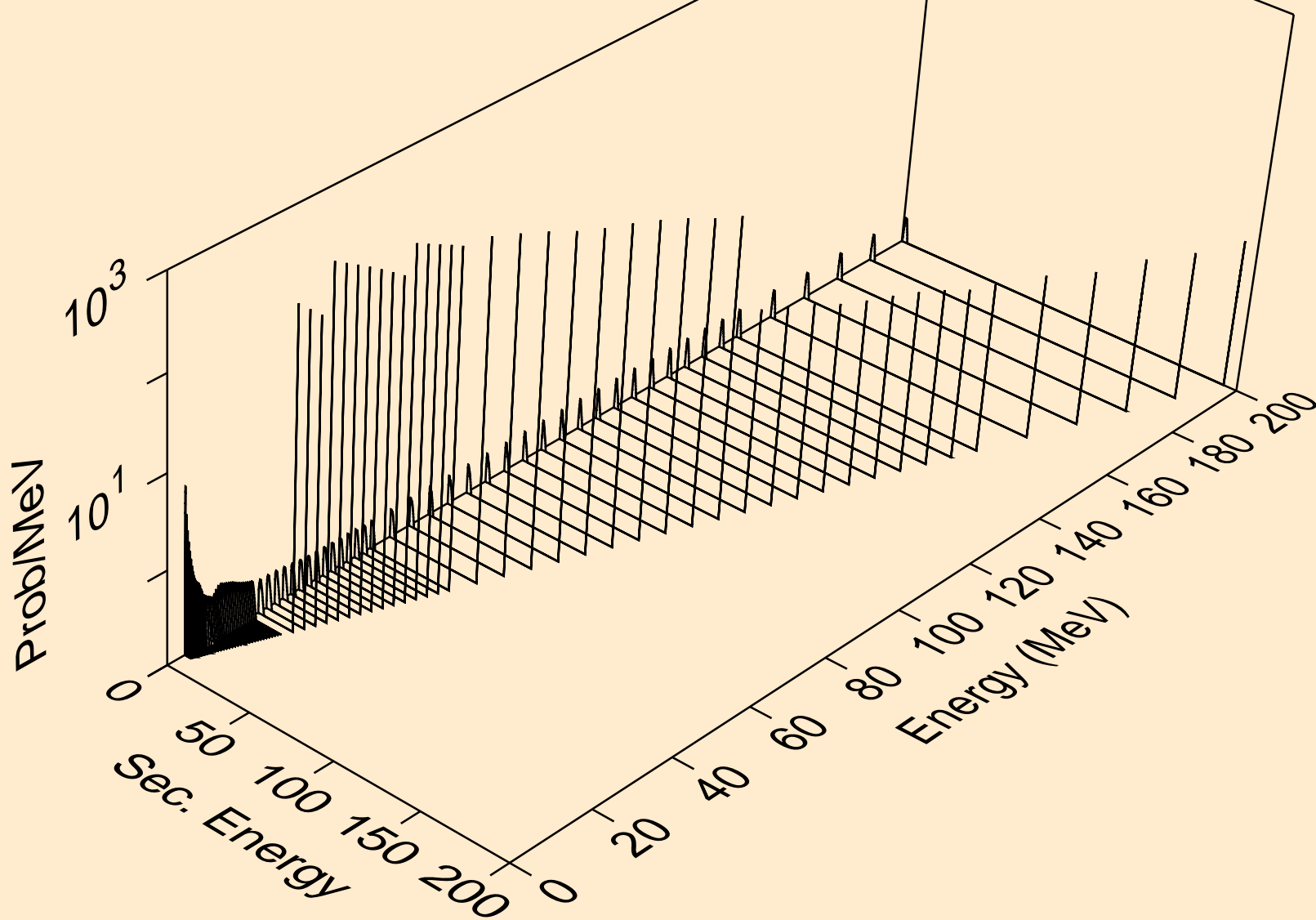

MAT=2437 ACE FILE PRODUCED AT NEA WITH NDEC  
Photon emission for (n,x)

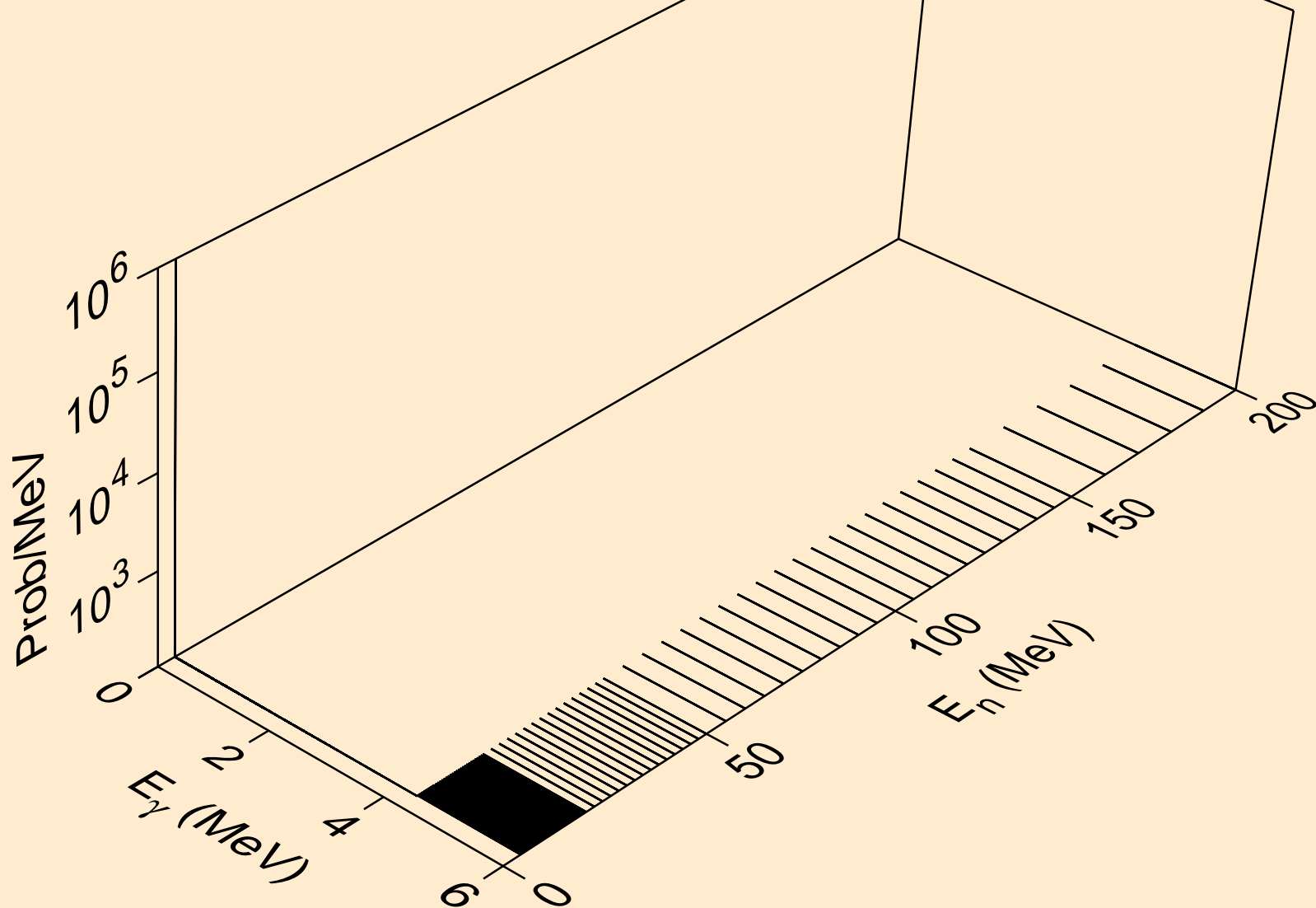

MAT=2437 ACE FILE PRODUCED AT NEA WITH NDEC  
Photon emission for (n,gma)

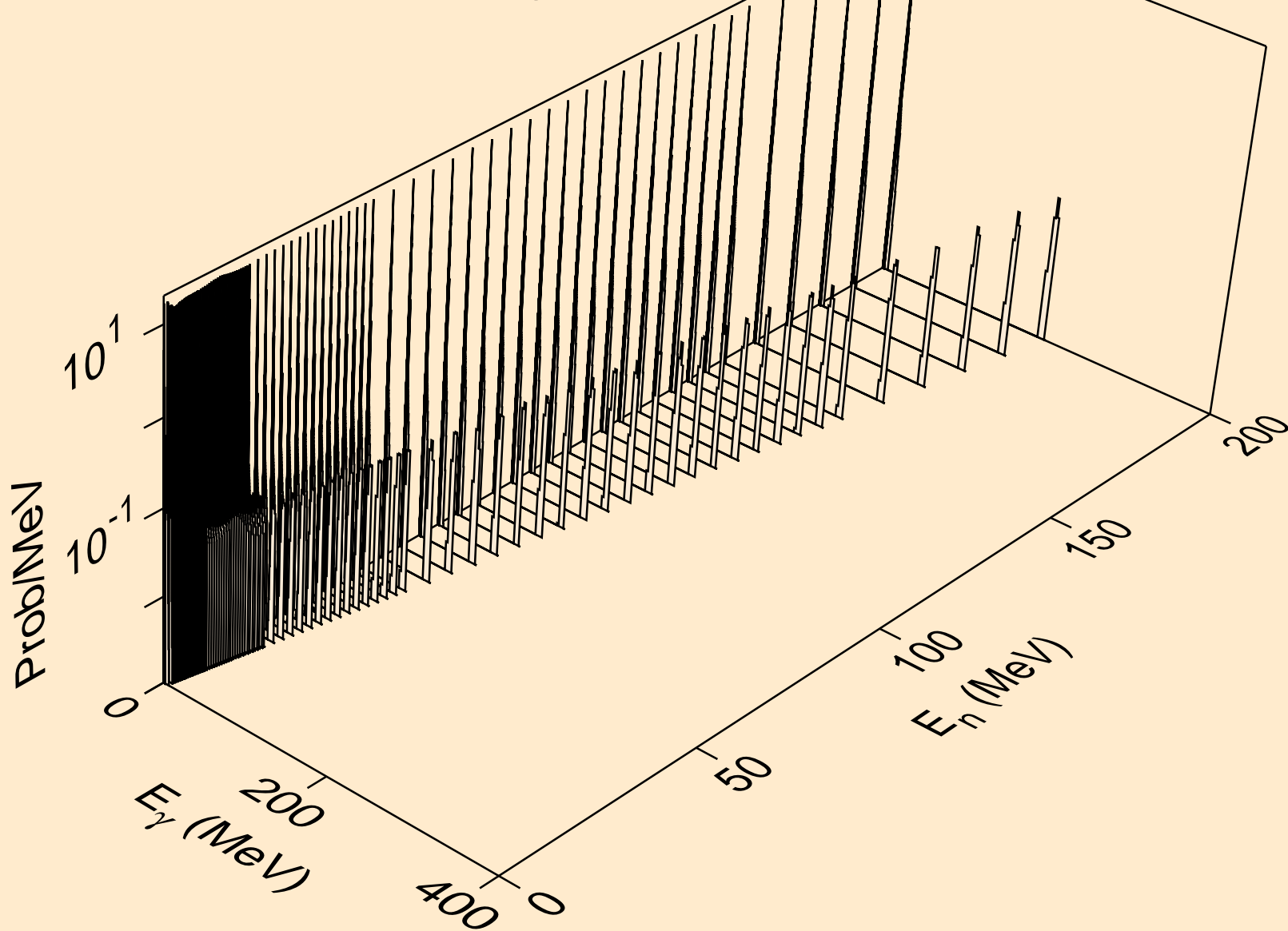

MAT=2437 ACE FILE PRODUCED AT NEA WITH NDEC  
thermal capture photon spectrum

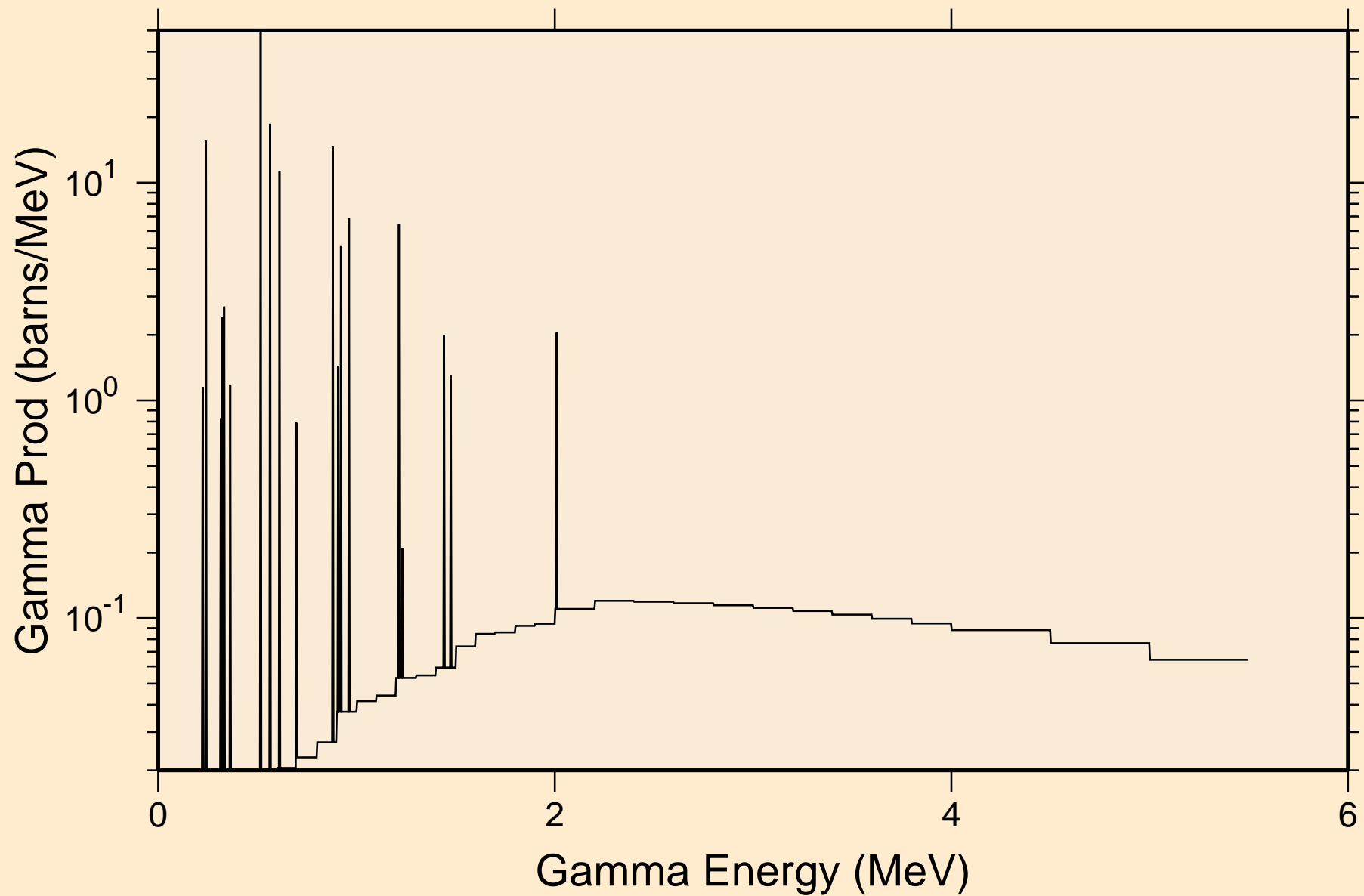

MAT=2437 ACE FILE PRODUCED AT NEA WITH NDEC  
14 MeV photon spectrum

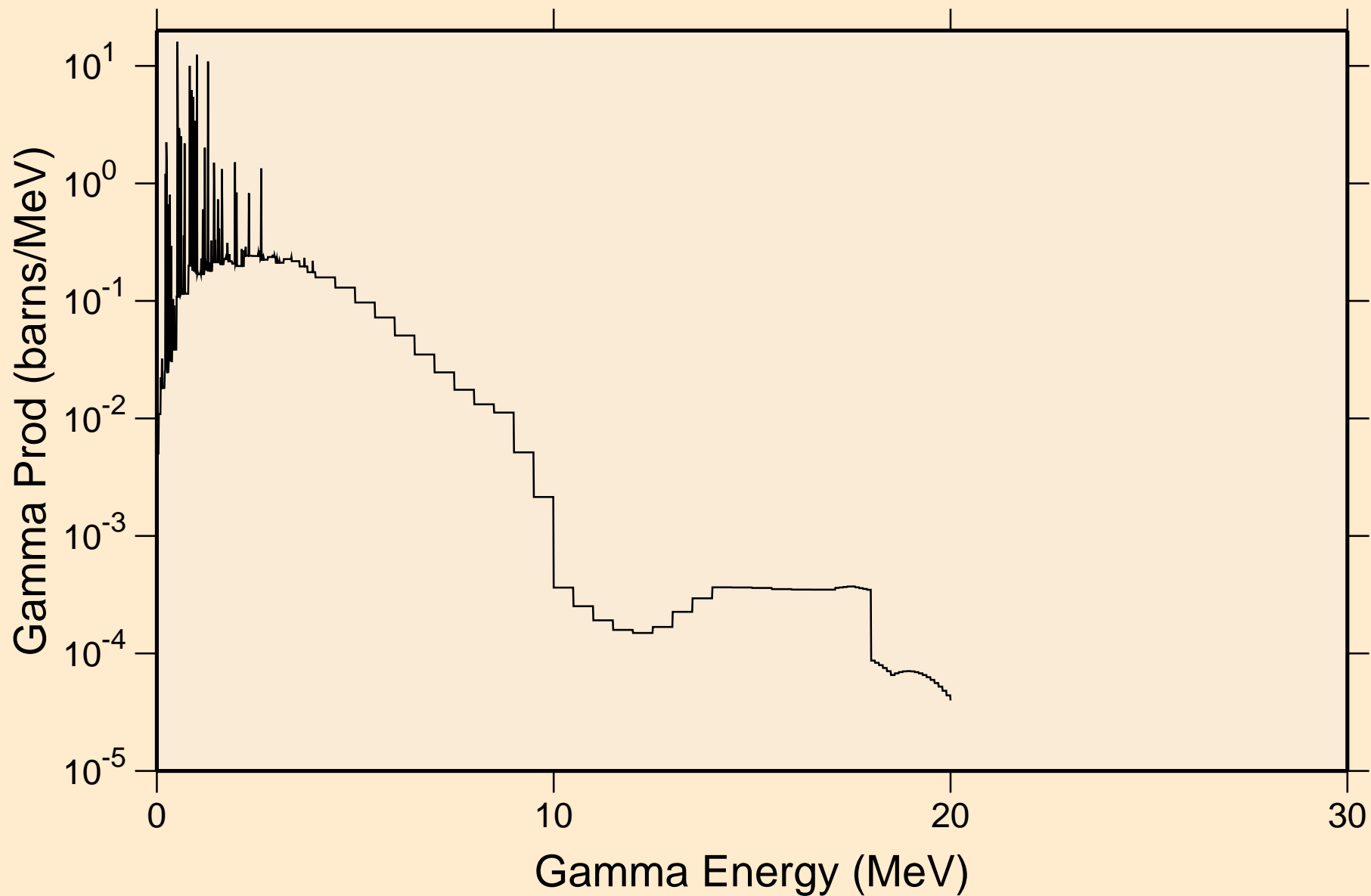

MAT=2437 ACE FILE PRODUCED AT NEA WITH NDEC  
Particle heating contributions

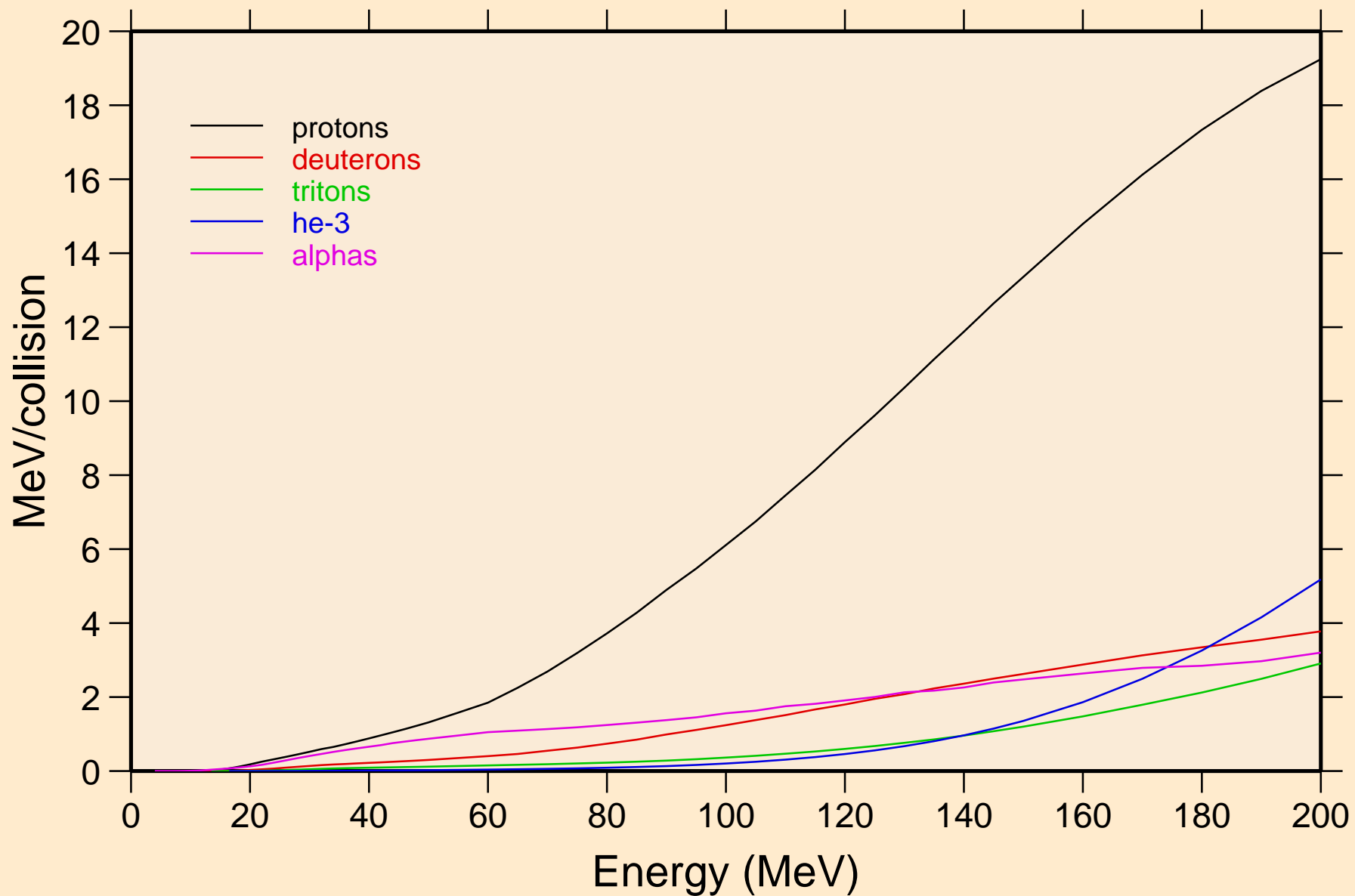

MAT=2437 ACE FILE PRODUCED AT NEA WITH NDEC  
Recoil Heating

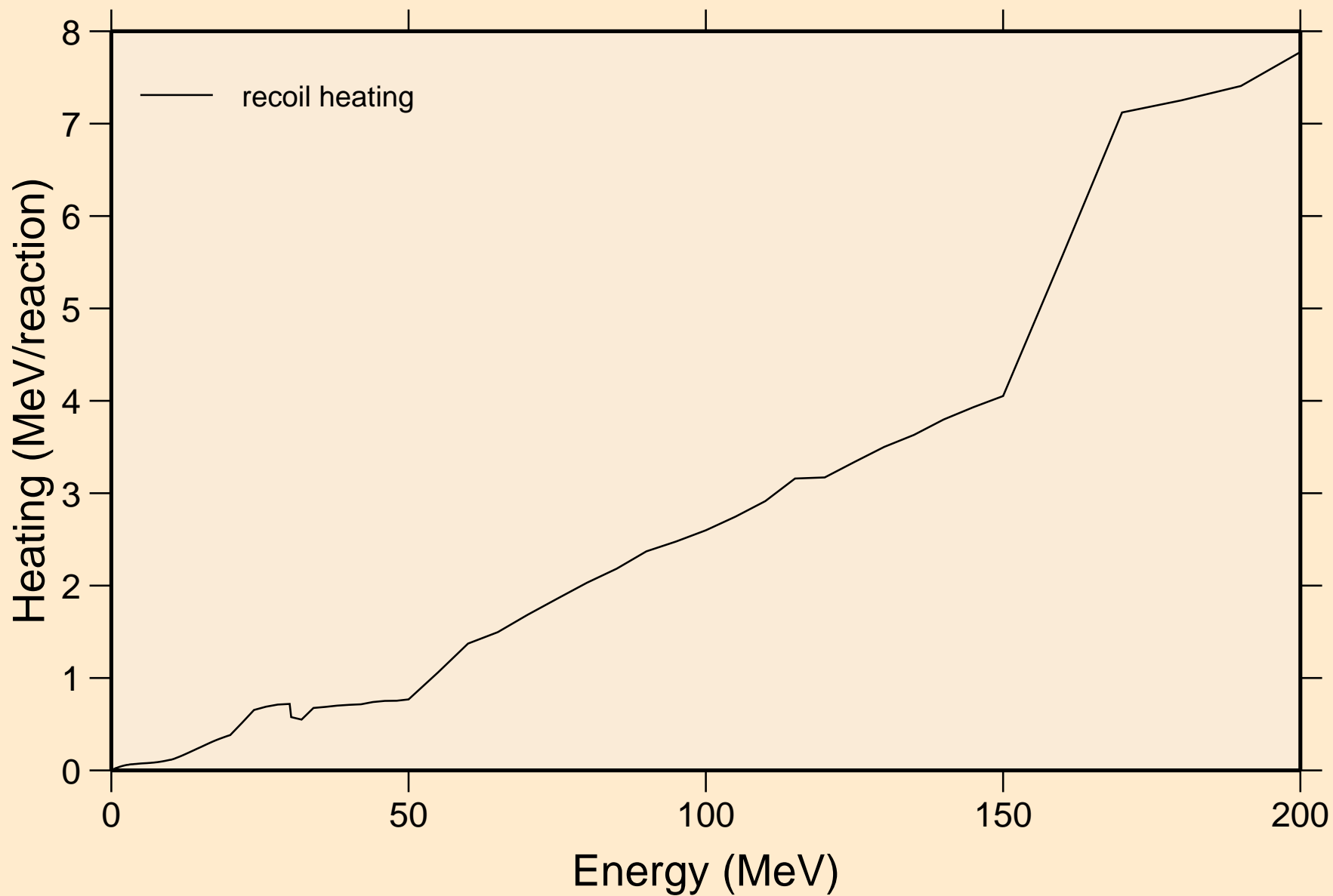

MAT=2437 ACE FILE PRODUCED AT NEA WITH NDEC

Particle production cross sections

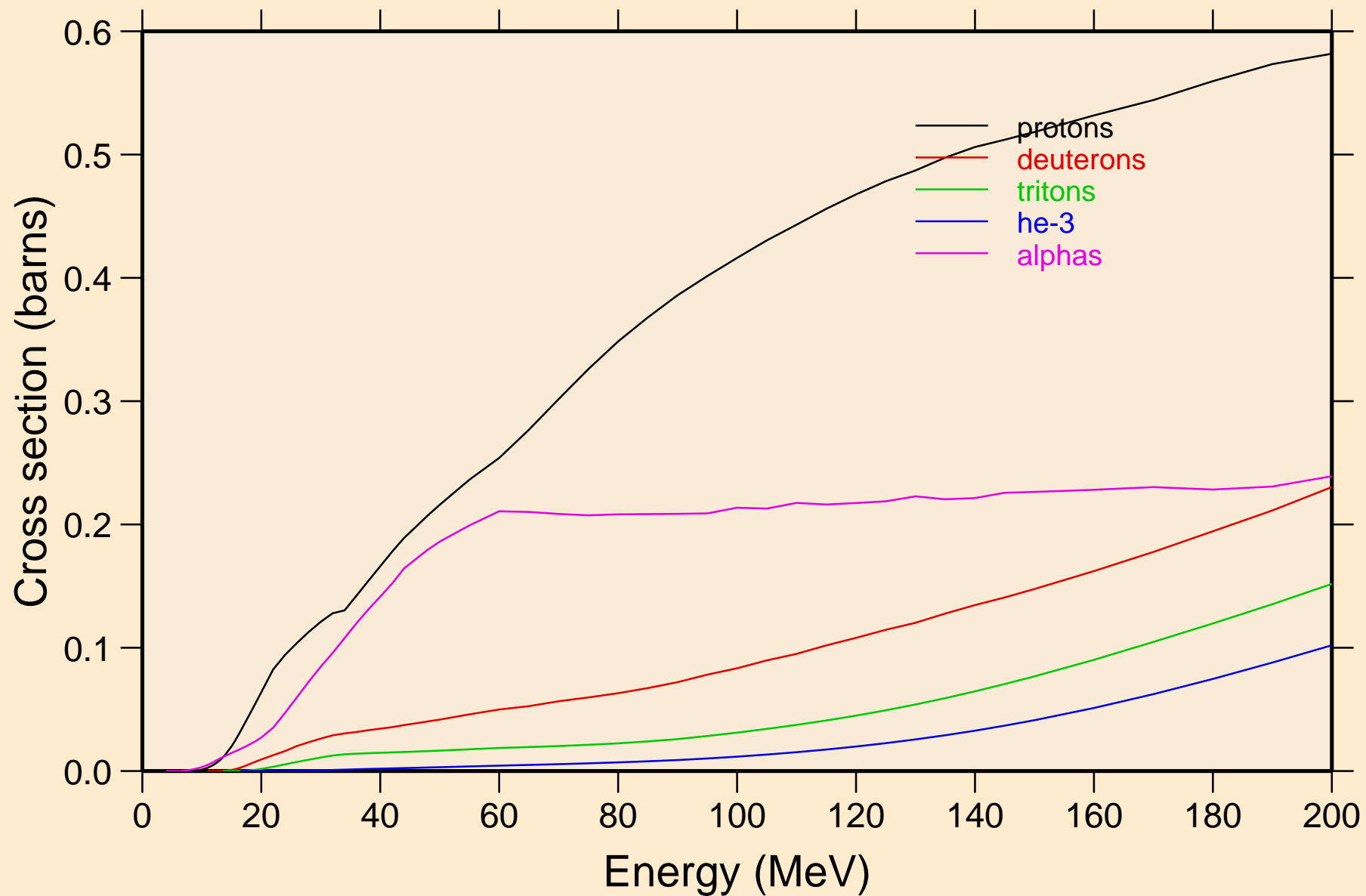

MAT=2437 ACE FILE PRODUCED AT NEA WITH NDEC  
protons from (n,x)

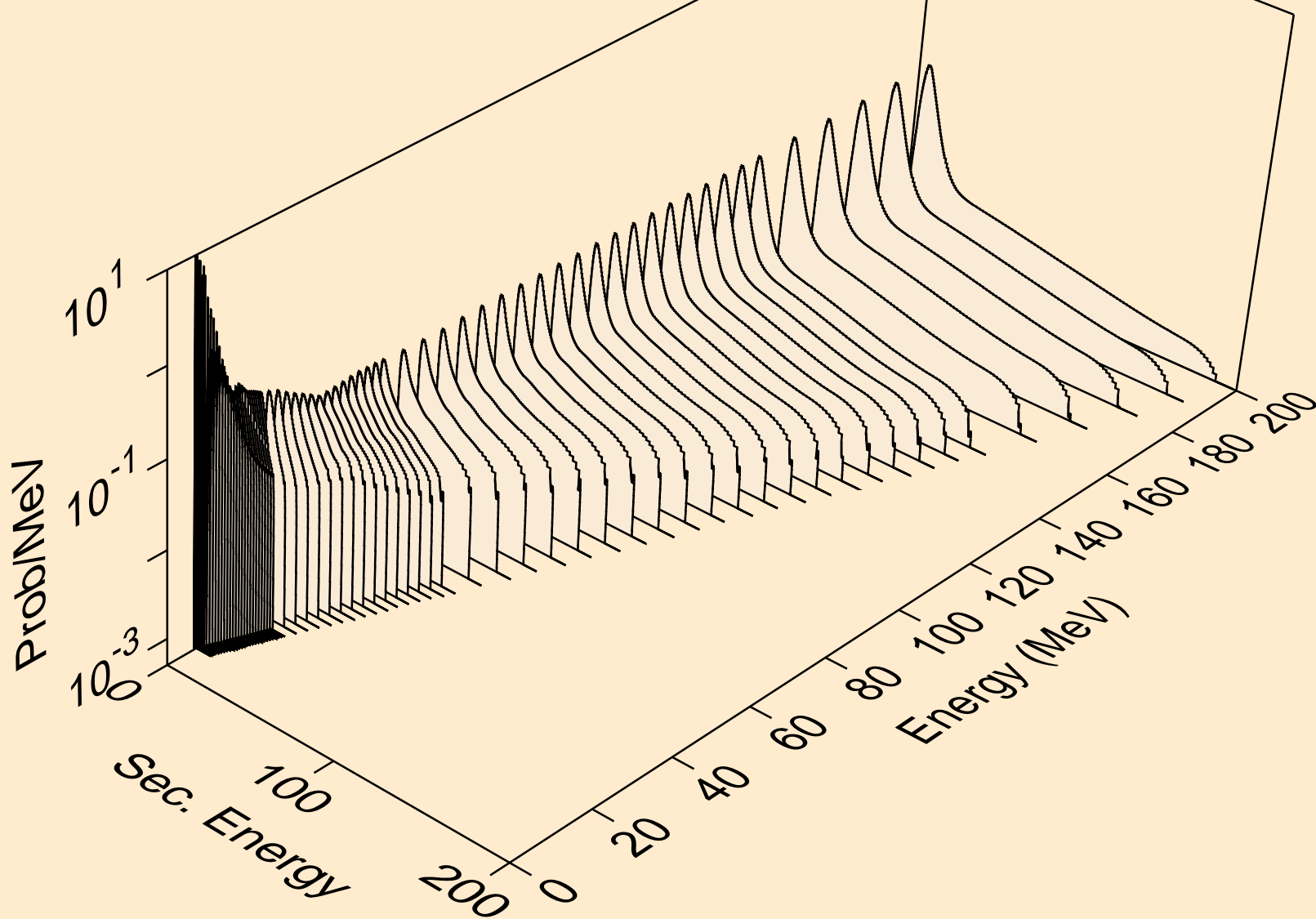

MAT=2437 ACE FILE PRODUCED AT NEA WITH NDEC  
deuterons from (n,x)

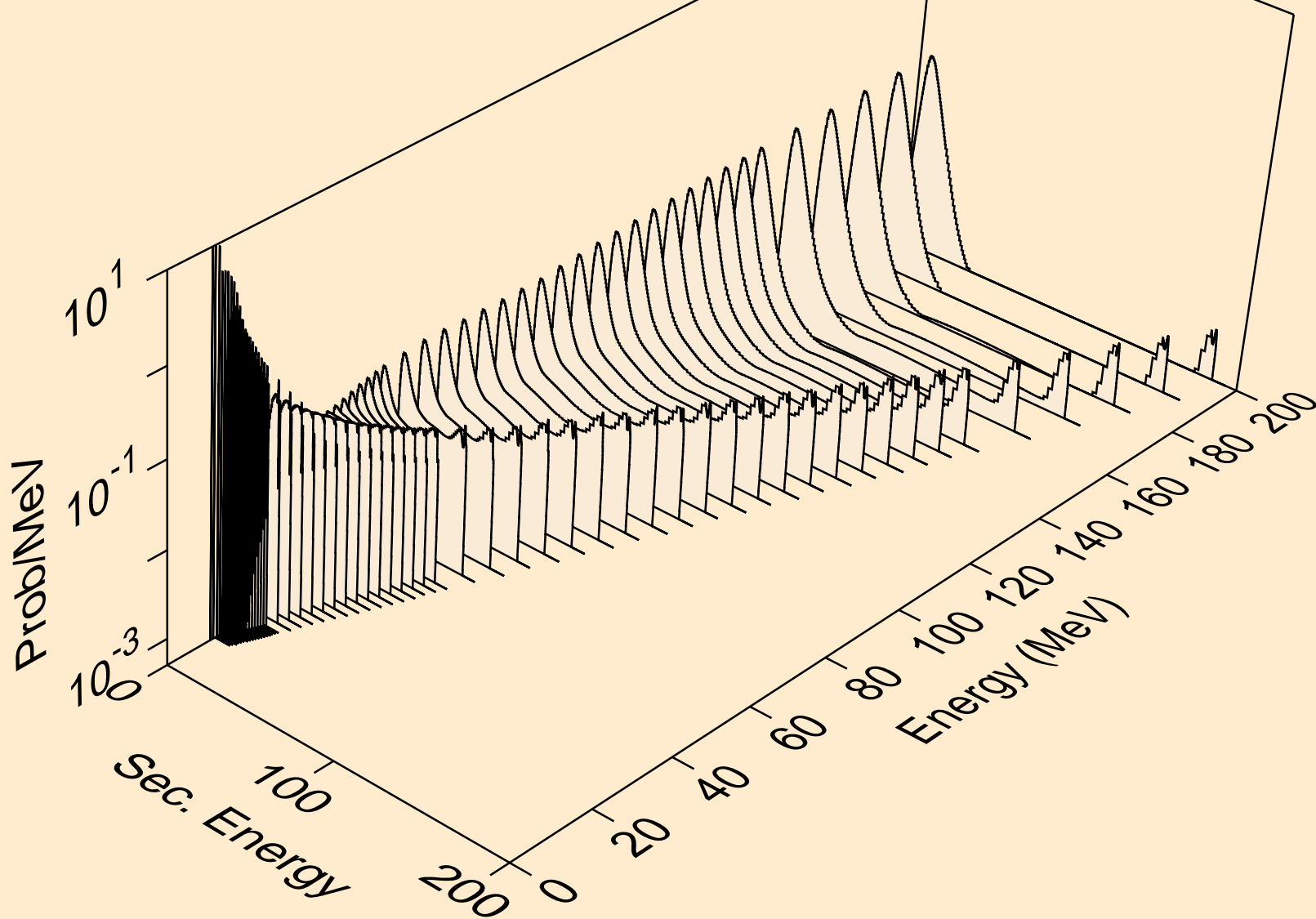

MAT=2437 ACE FILE PRODUCED AT NEA WITH NDEC  
tritons from (n,x)

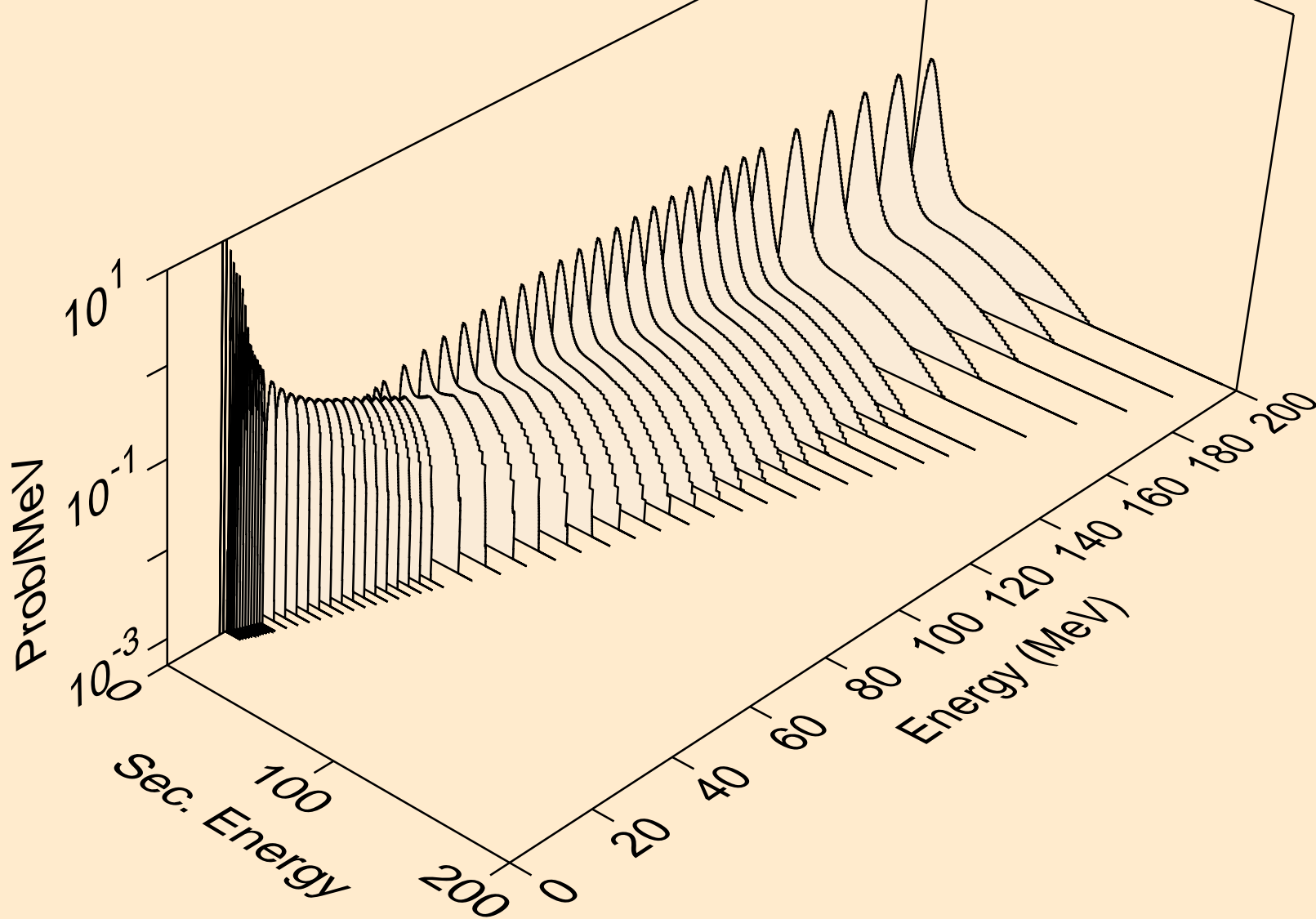

MAT=2437 ACE FILE PRODUCED AT NEA WITH NDEC  
he3s from (n,x)

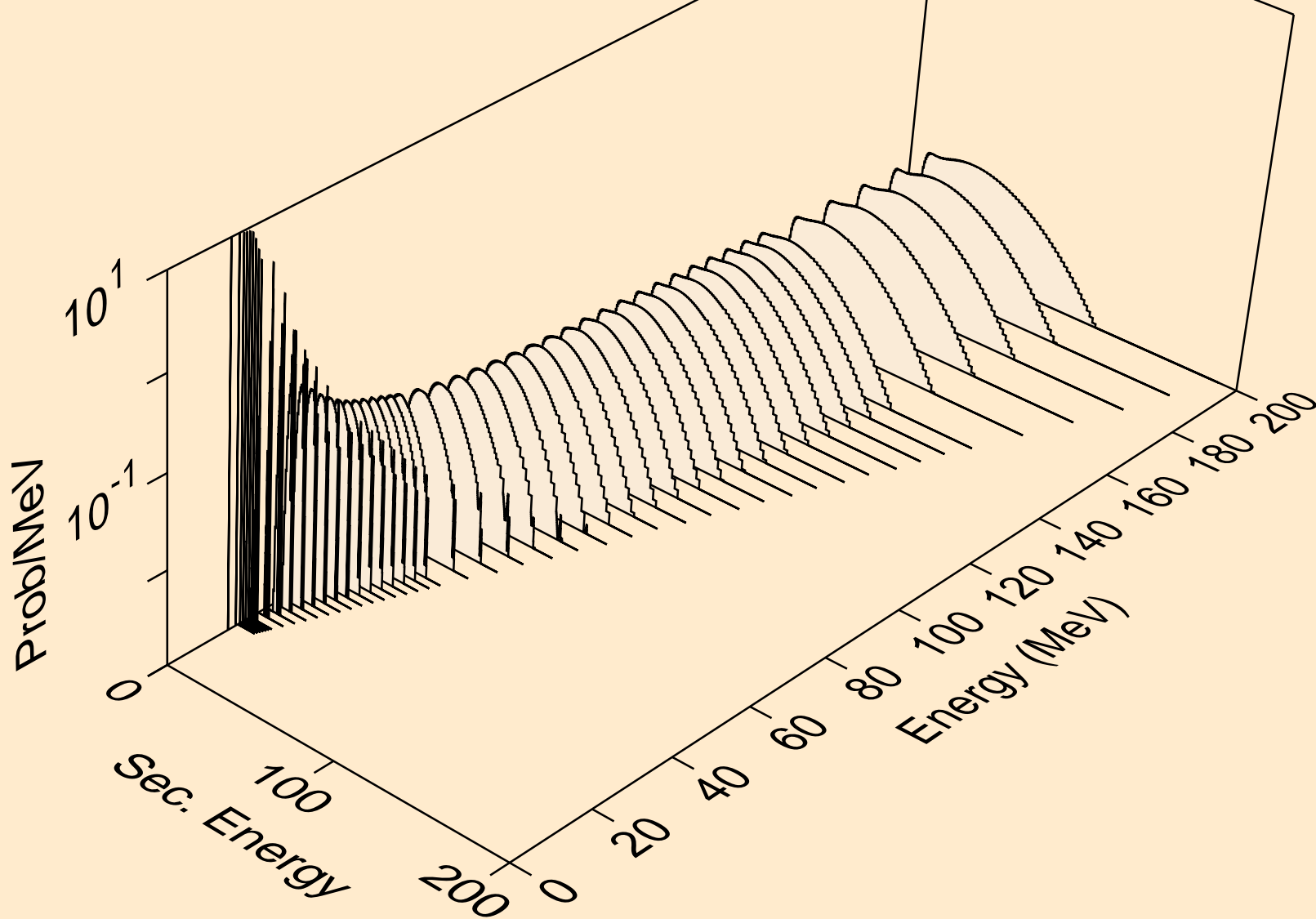

MAT=2437 ACE FILE PRODUCED AT NEA WITH NDEC  
alphas from (n,x)

