

MAT=1725 ACE FILE PRODUCED AT NEA WITH NDEC

Principal cross sections

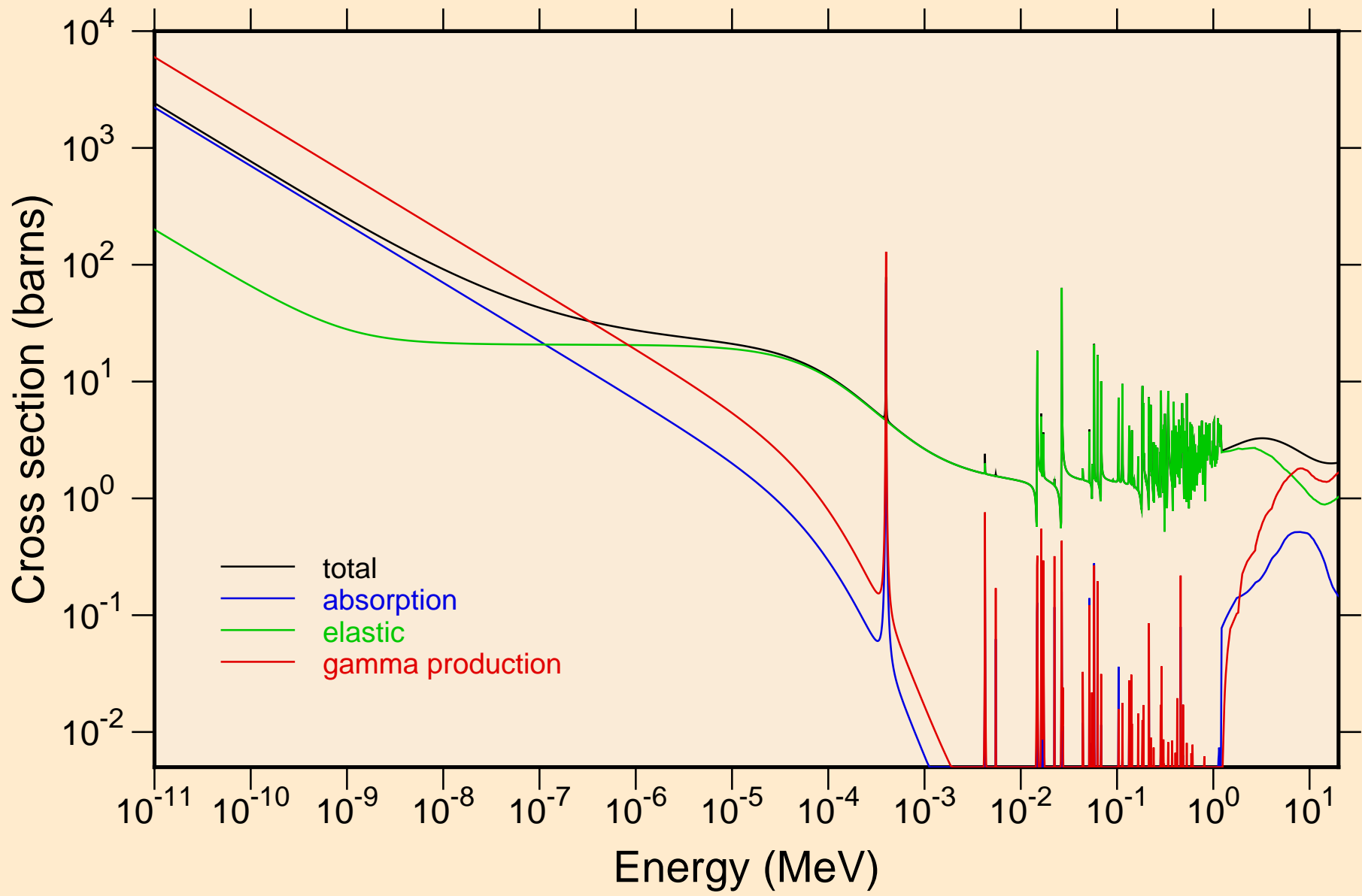

MAT=1725 ACE FILE PRODUCED AT NEA WITH NDEC
resonance total cross section

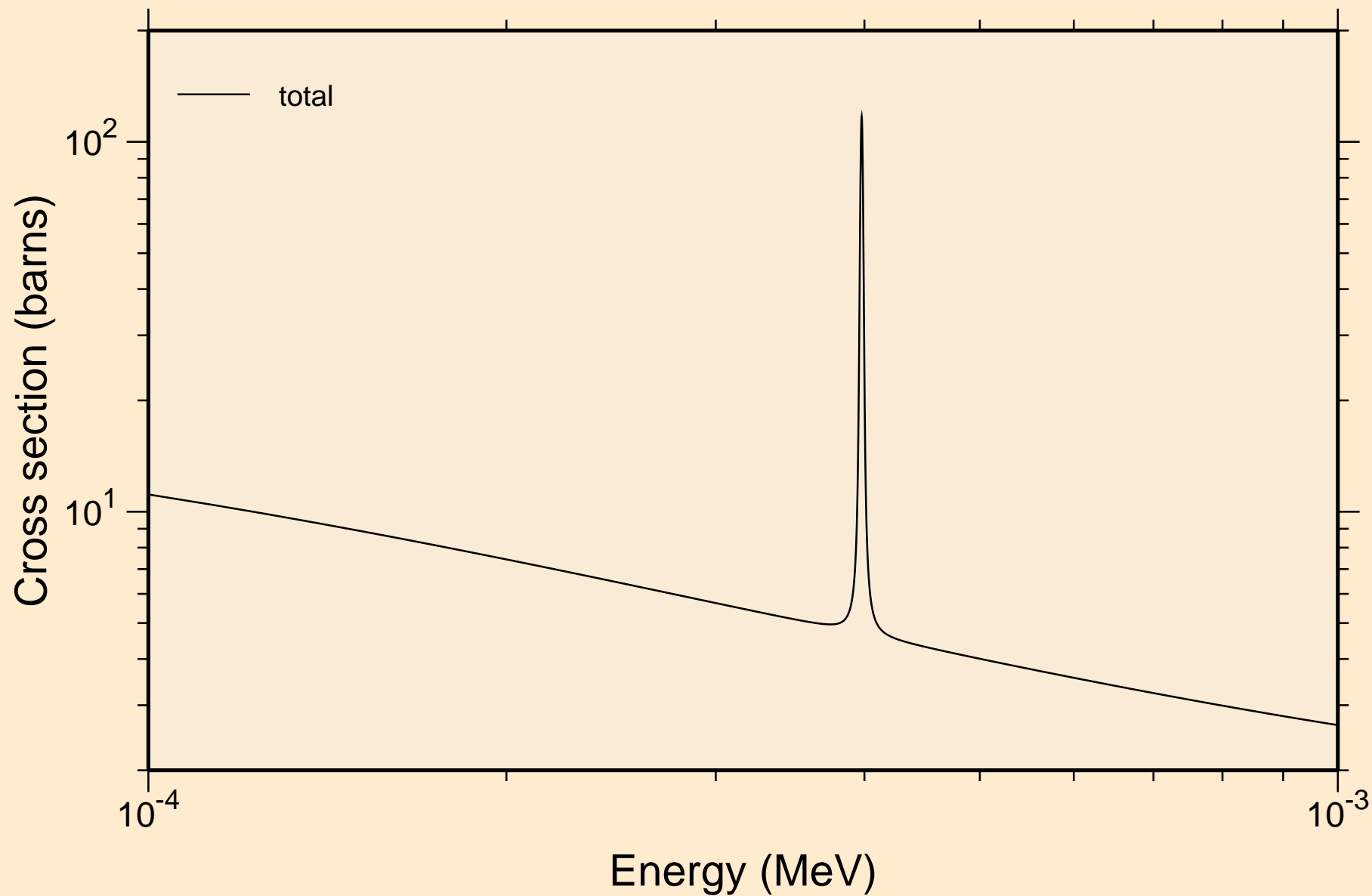

MAT=1725 ACE FILE PRODUCED AT NEA WITH NDEC
resonance total cross section

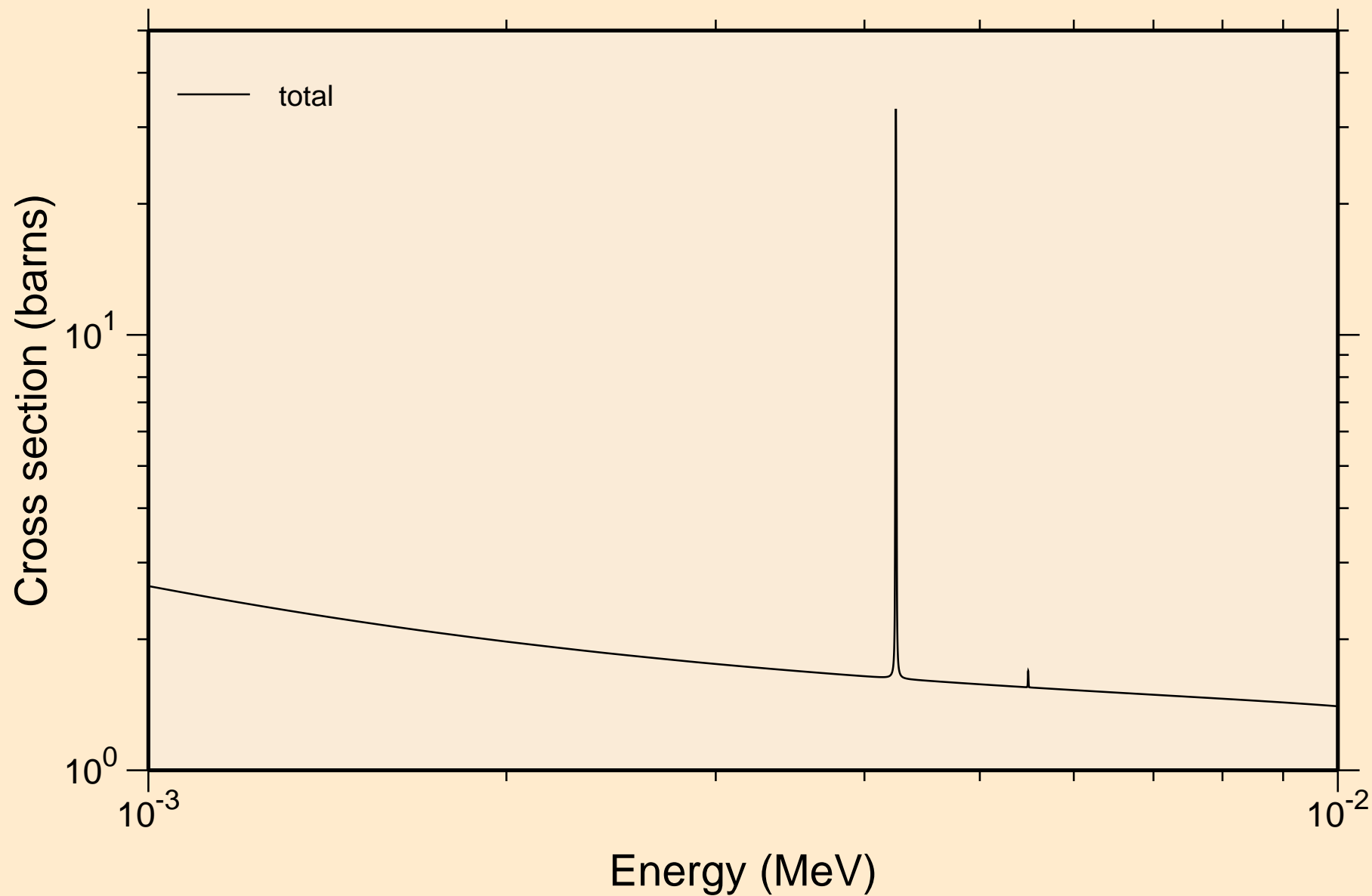

MAT=1725 ACE FILE PRODUCED AT NEA WITH NDEC
resonance total cross section

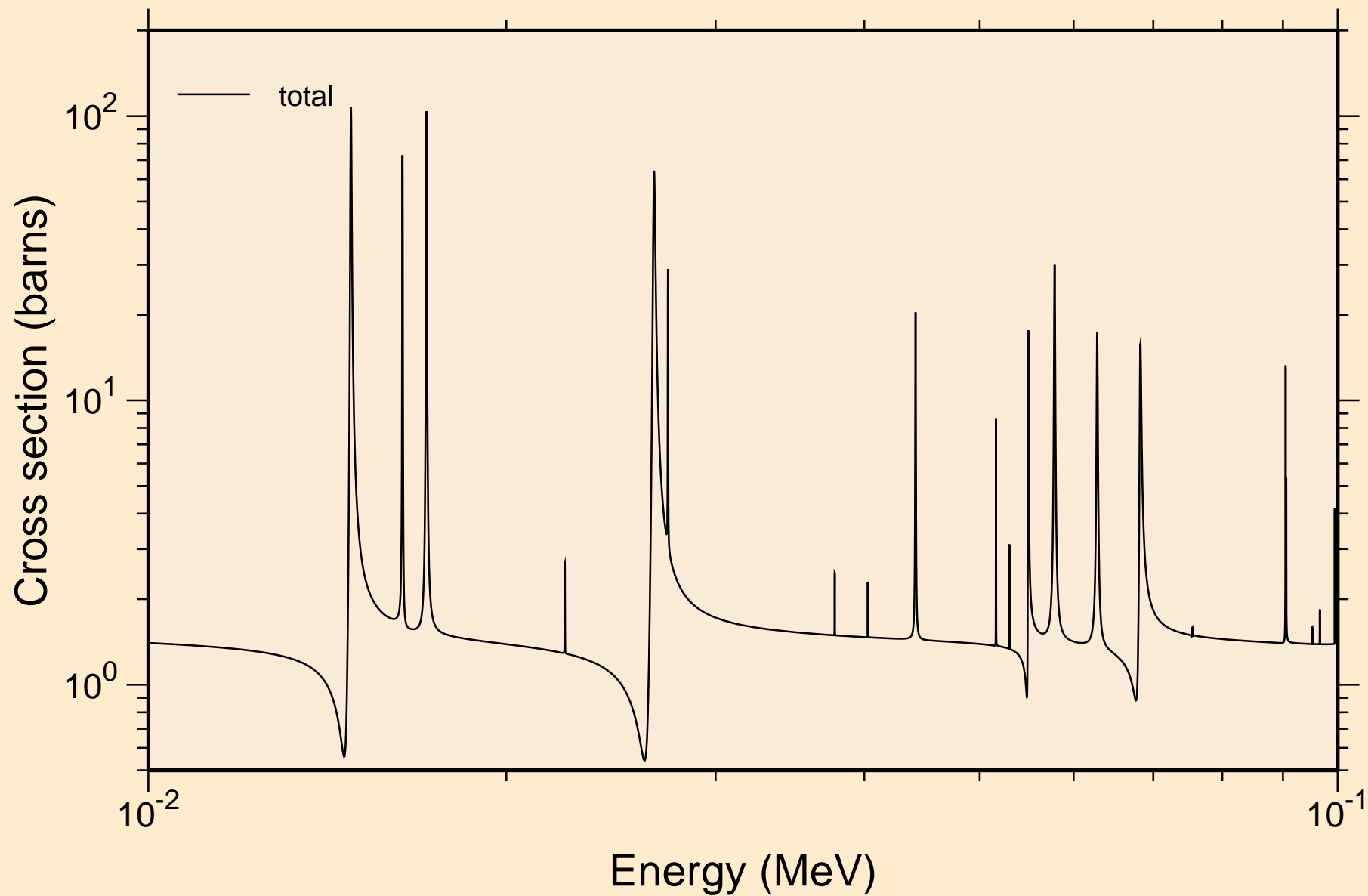

MAT=1725 ACE FILE PRODUCED AT NEA WITH NDEC
resonance total cross section

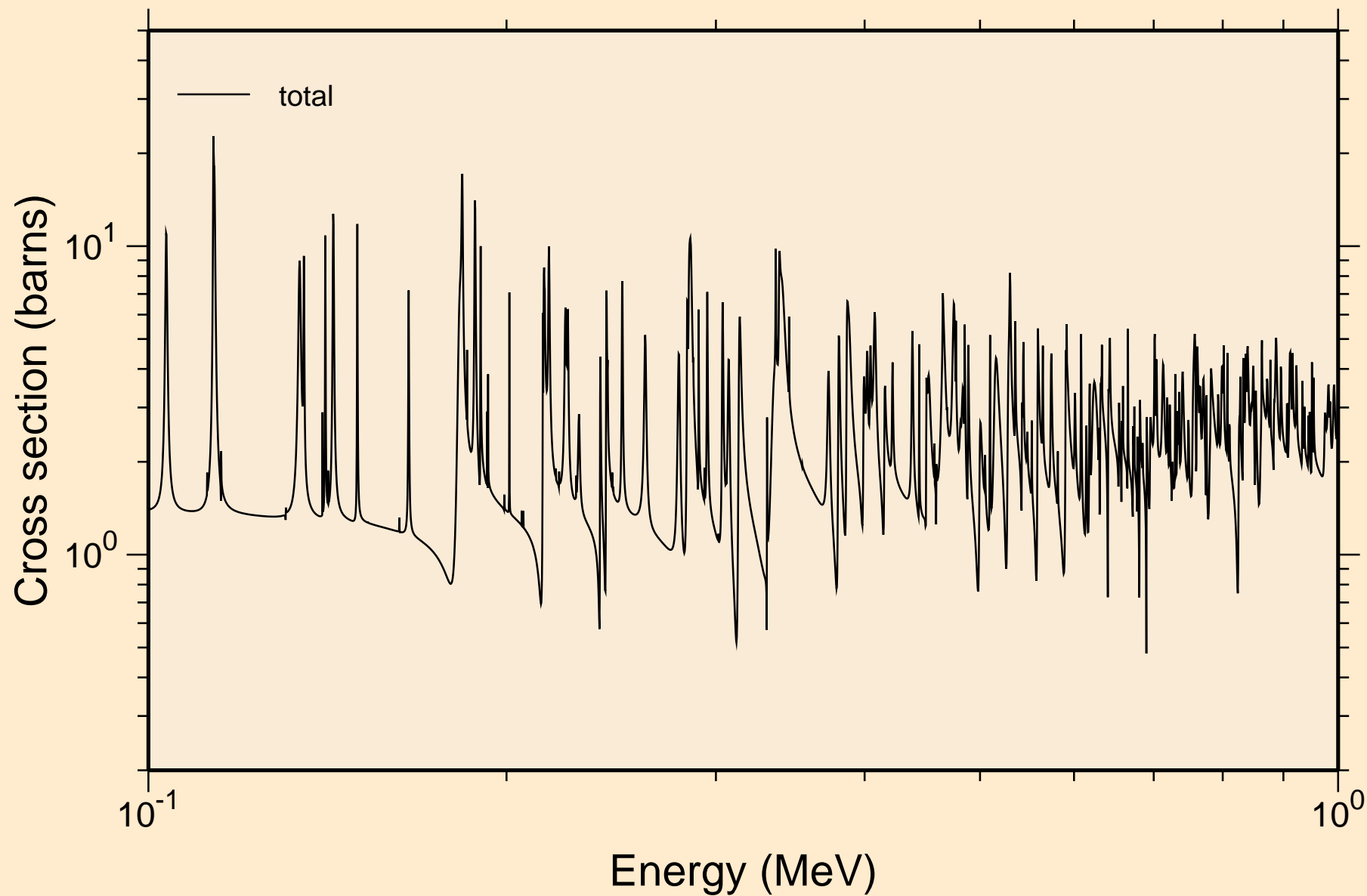

MAT=1725 ACE FILE PRODUCED AT NEA WITH NDEC
resonance total cross section

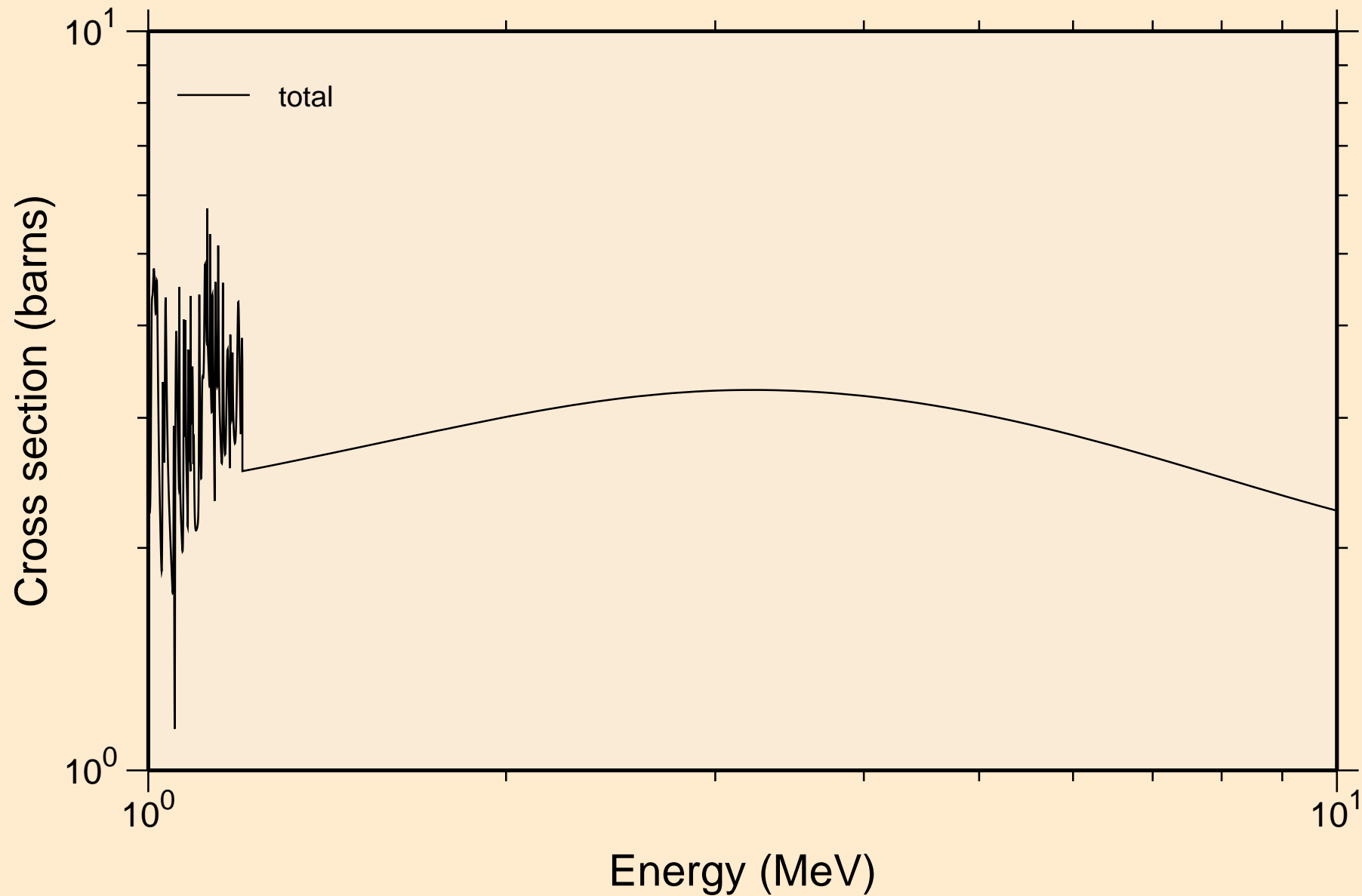

MAT=1725 ACE FILE PRODUCED AT NEA WITH NDEC
resonance absorption cross sections

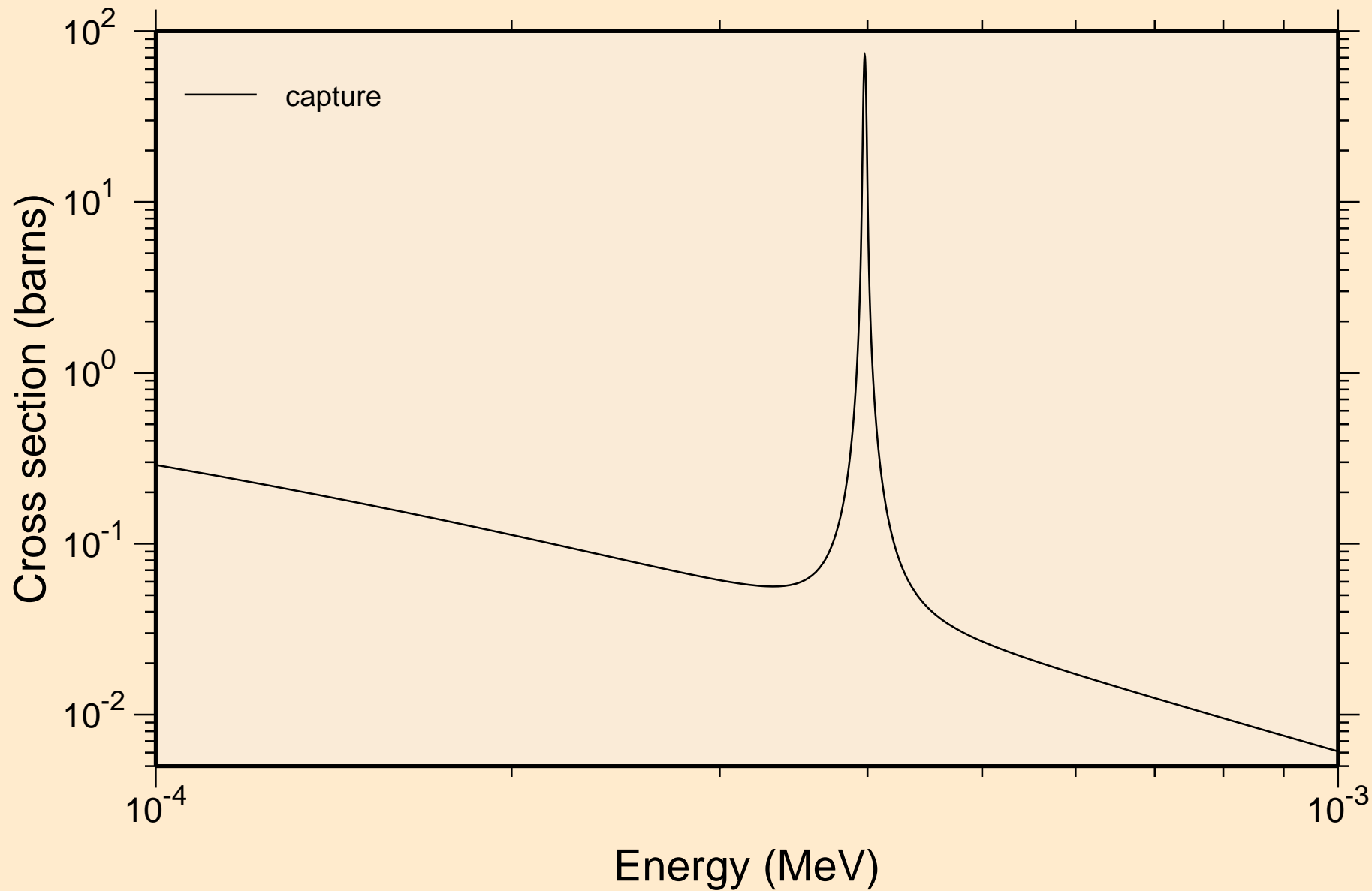

MAT=1725 ACE FILE PRODUCED AT NEA WITH NDEC
resonance absorption cross sections

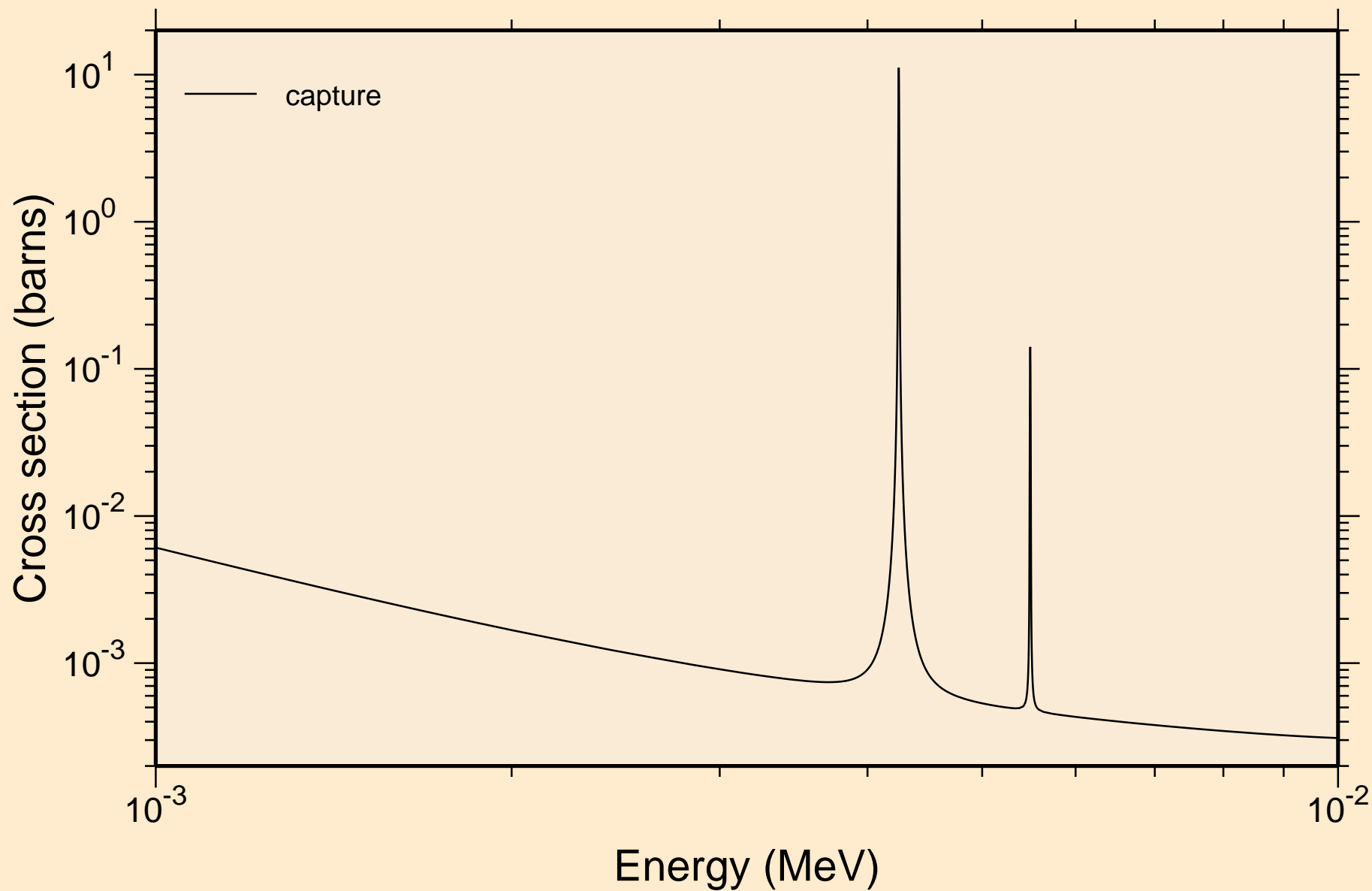

MAT=1725 ACE FILE PRODUCED AT NEA WITH NDEC
resonance absorption cross sections

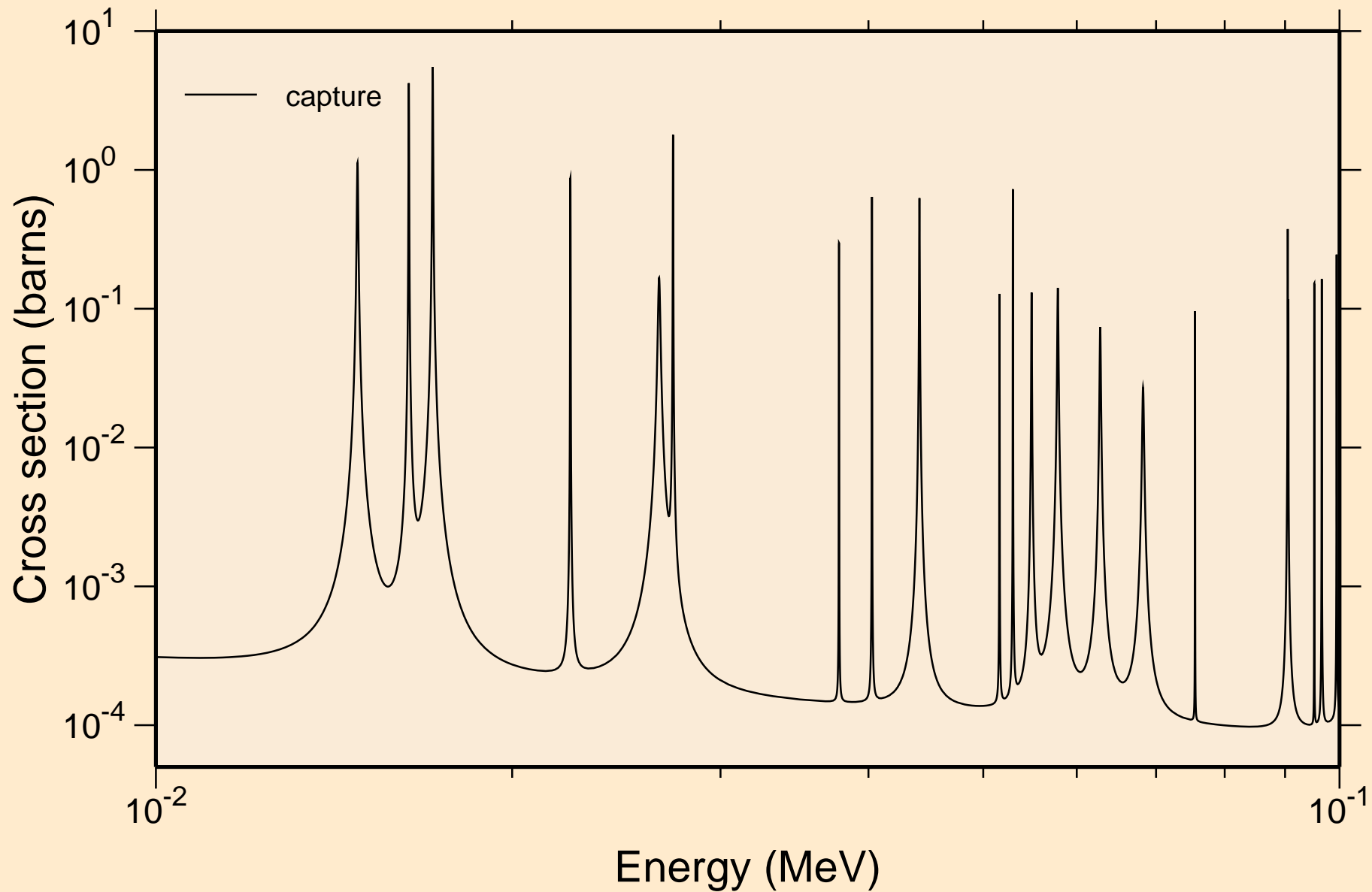

MAT=1725 ACE FILE PRODUCED AT NEA WITH NDEC
resonance absorption cross sections

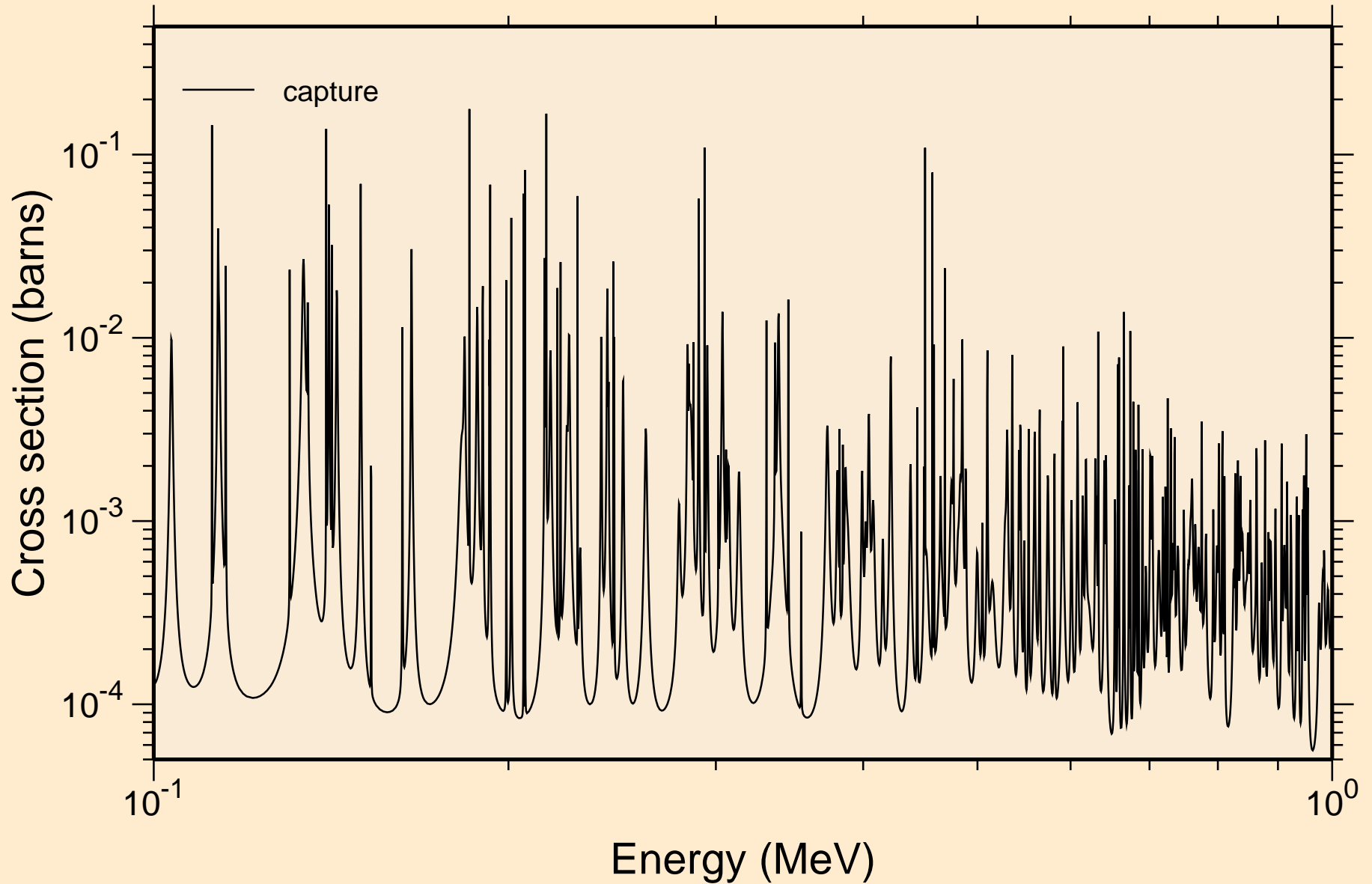

MAT=1725 ACE FILE PRODUCED AT NEA WITH NDEC
resonance absorption cross sections

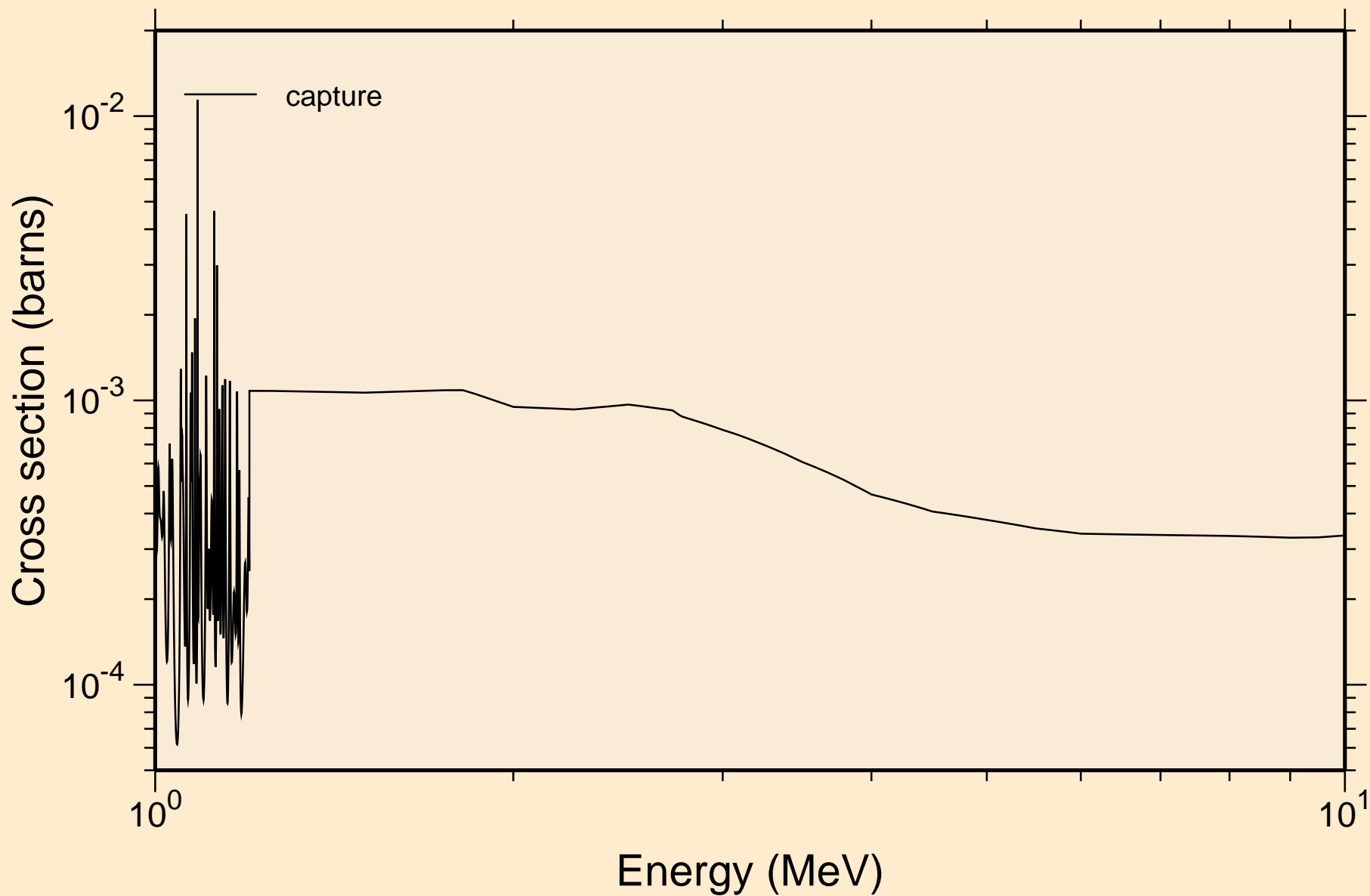

MAT=1725 ACE FILE PRODUCED AT NEA WITH NDEC
Heating

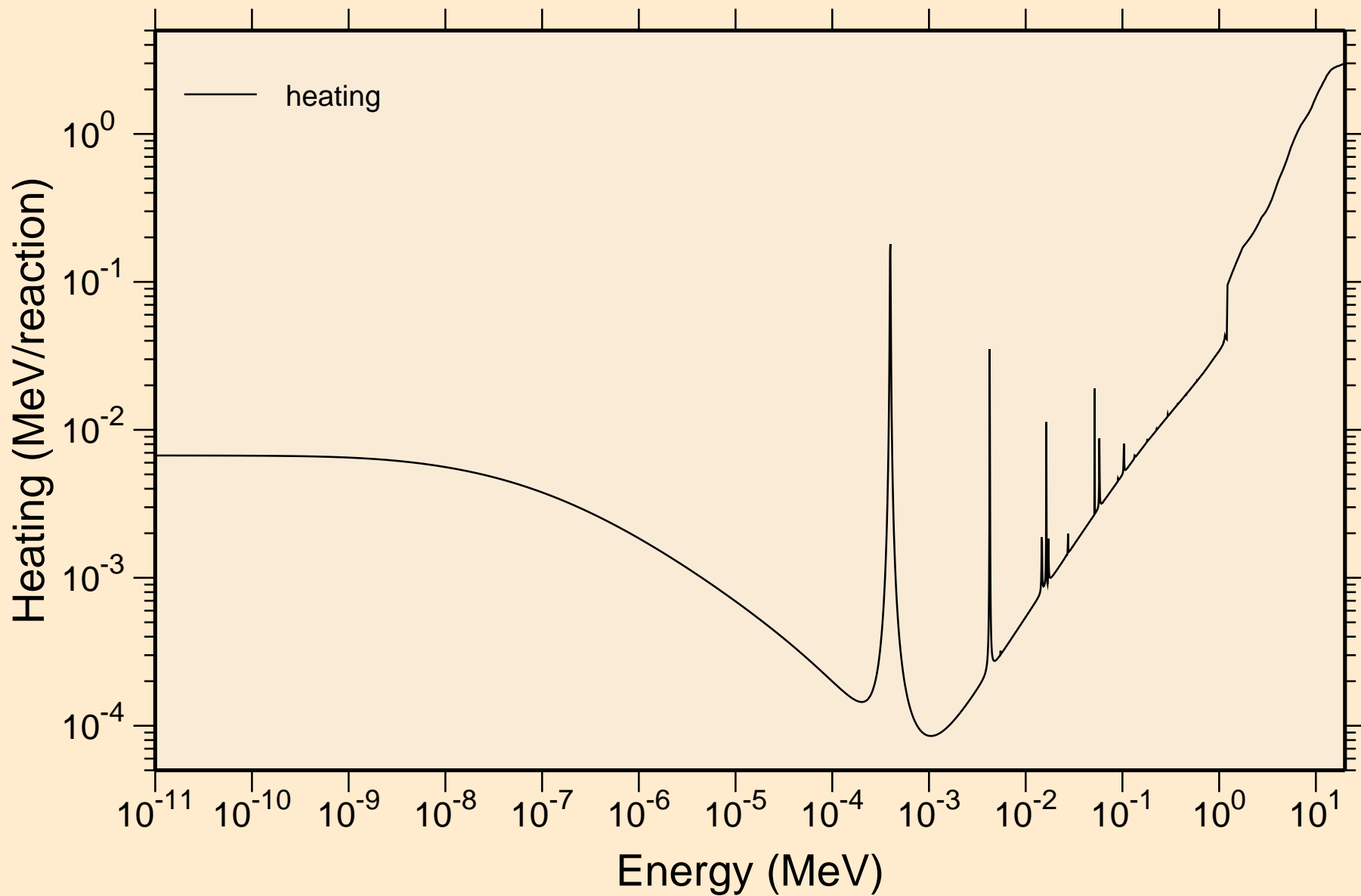

MAT=1725 ACE FILE PRODUCED AT NEA WITH NDEC
Damage

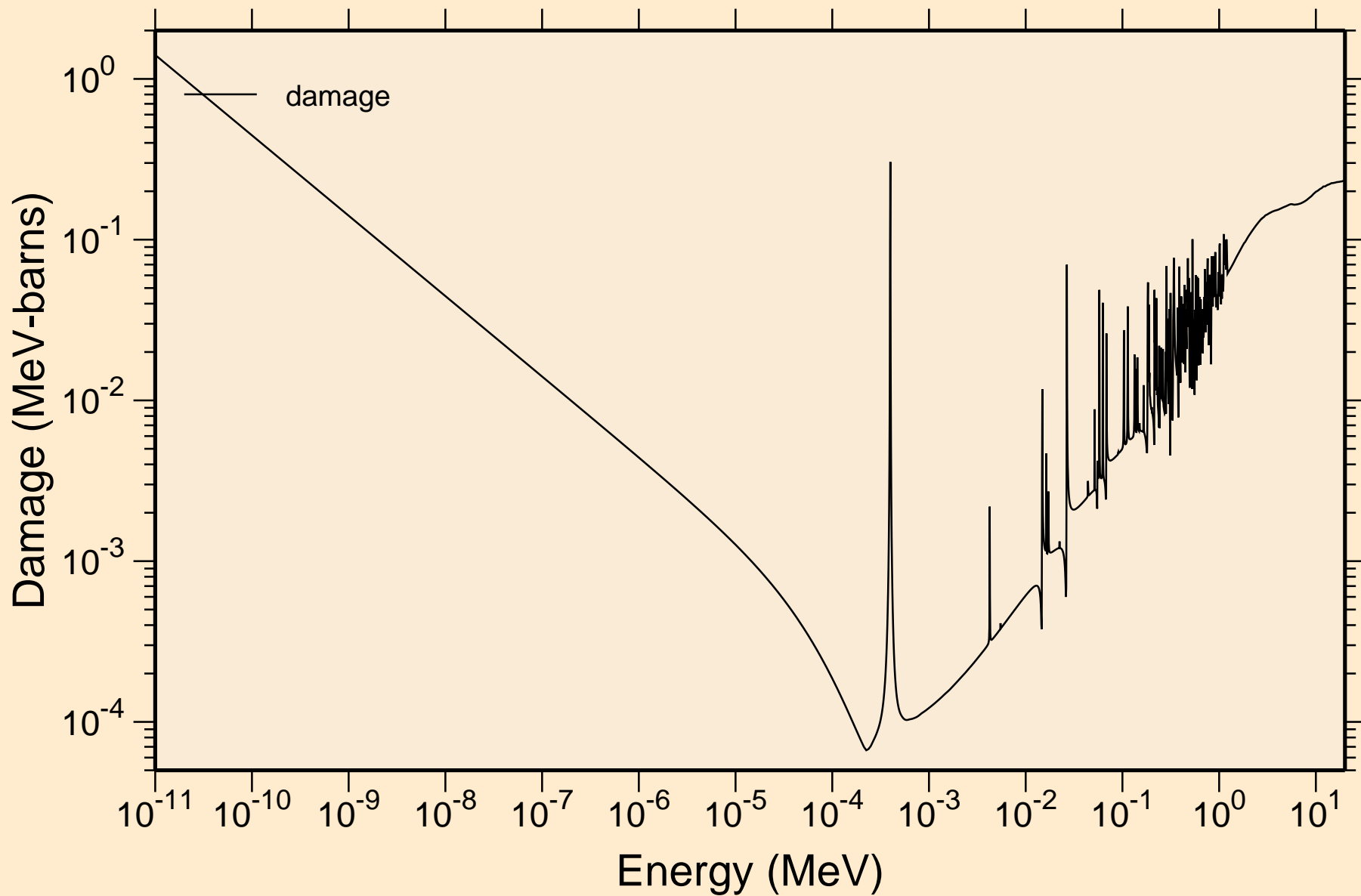

MAT=1725 ACE FILE PRODUCED AT NEA WITH NDEC
Non-threshold reactions

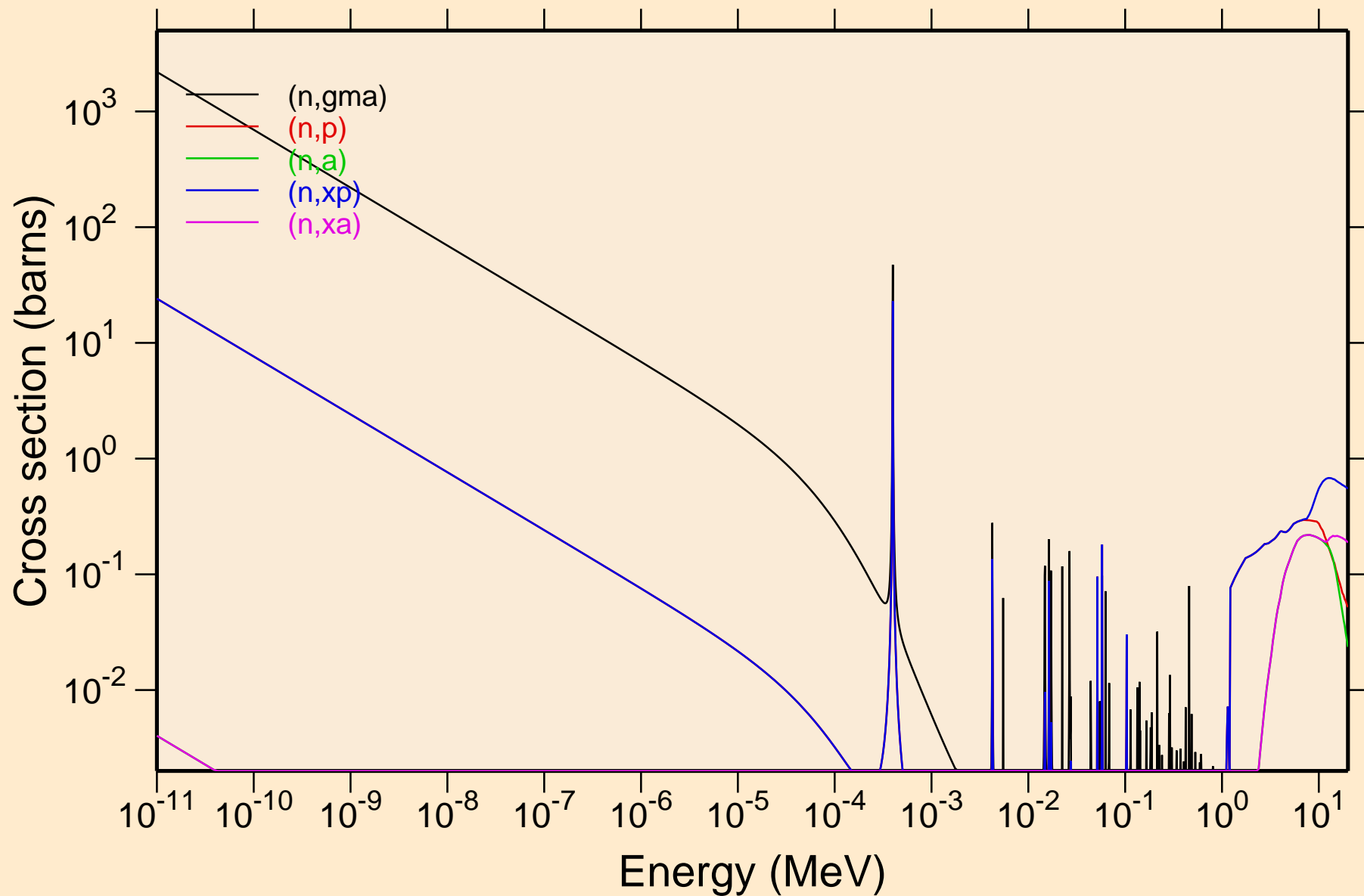

MAT=1725 ACE FILE PRODUCED AT NEA WITH NDEC

Principal cross sections

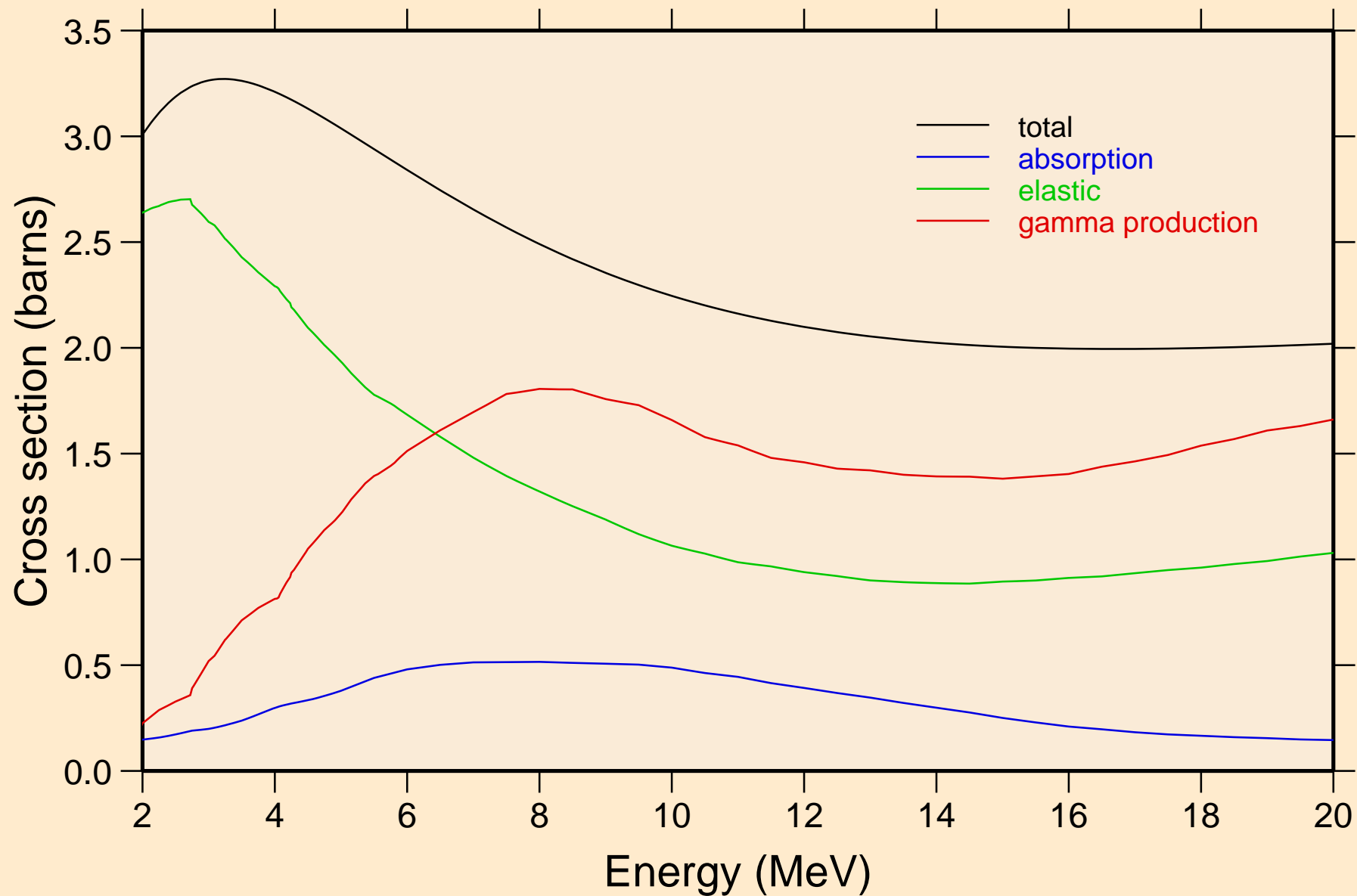

MAT=1725 ACE FILE PRODUCED AT NEA WITH NDEC
Heating

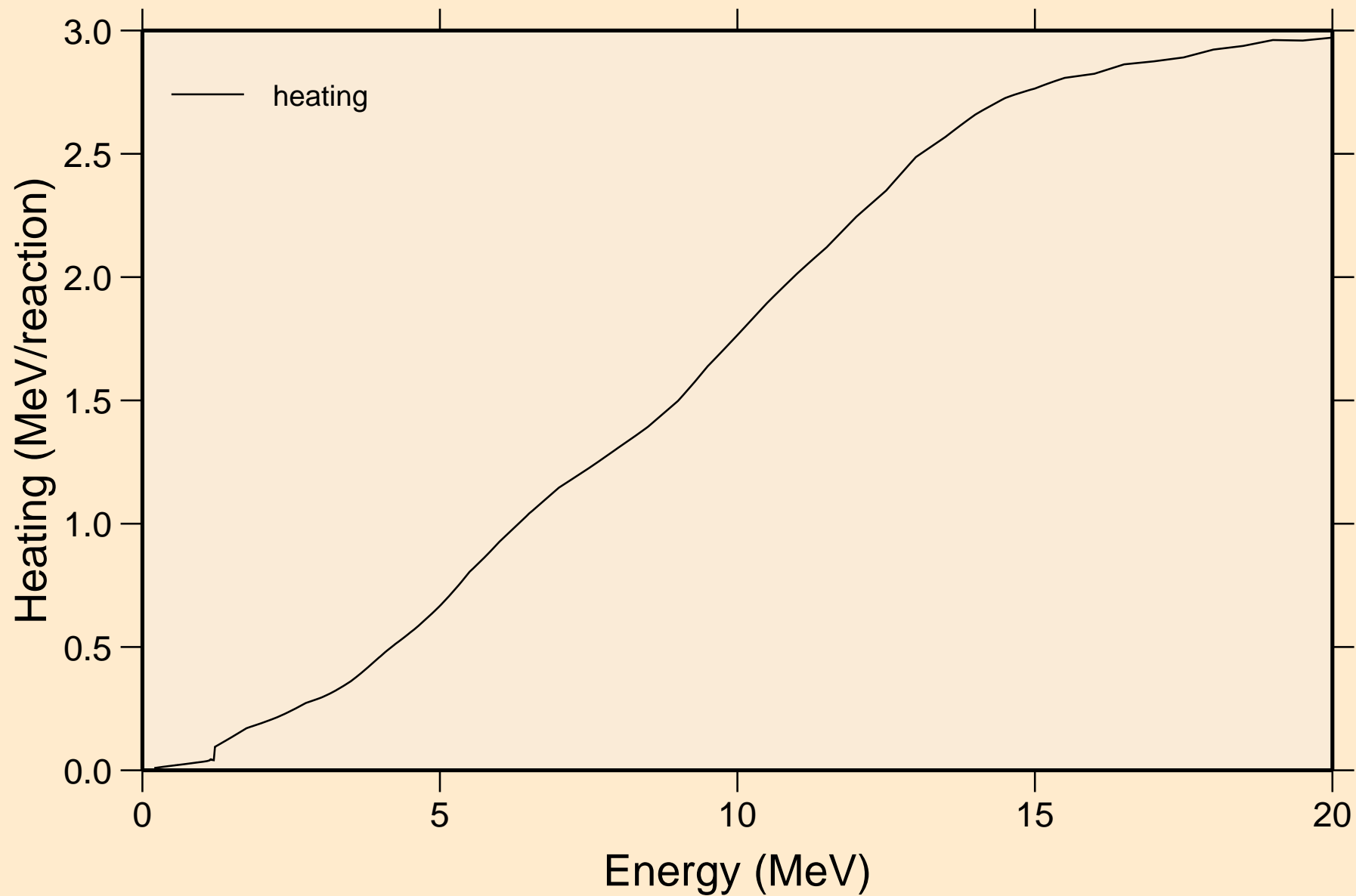

MAT=1725 ACE FILE PRODUCED AT NEA WITH NDEC
Damage

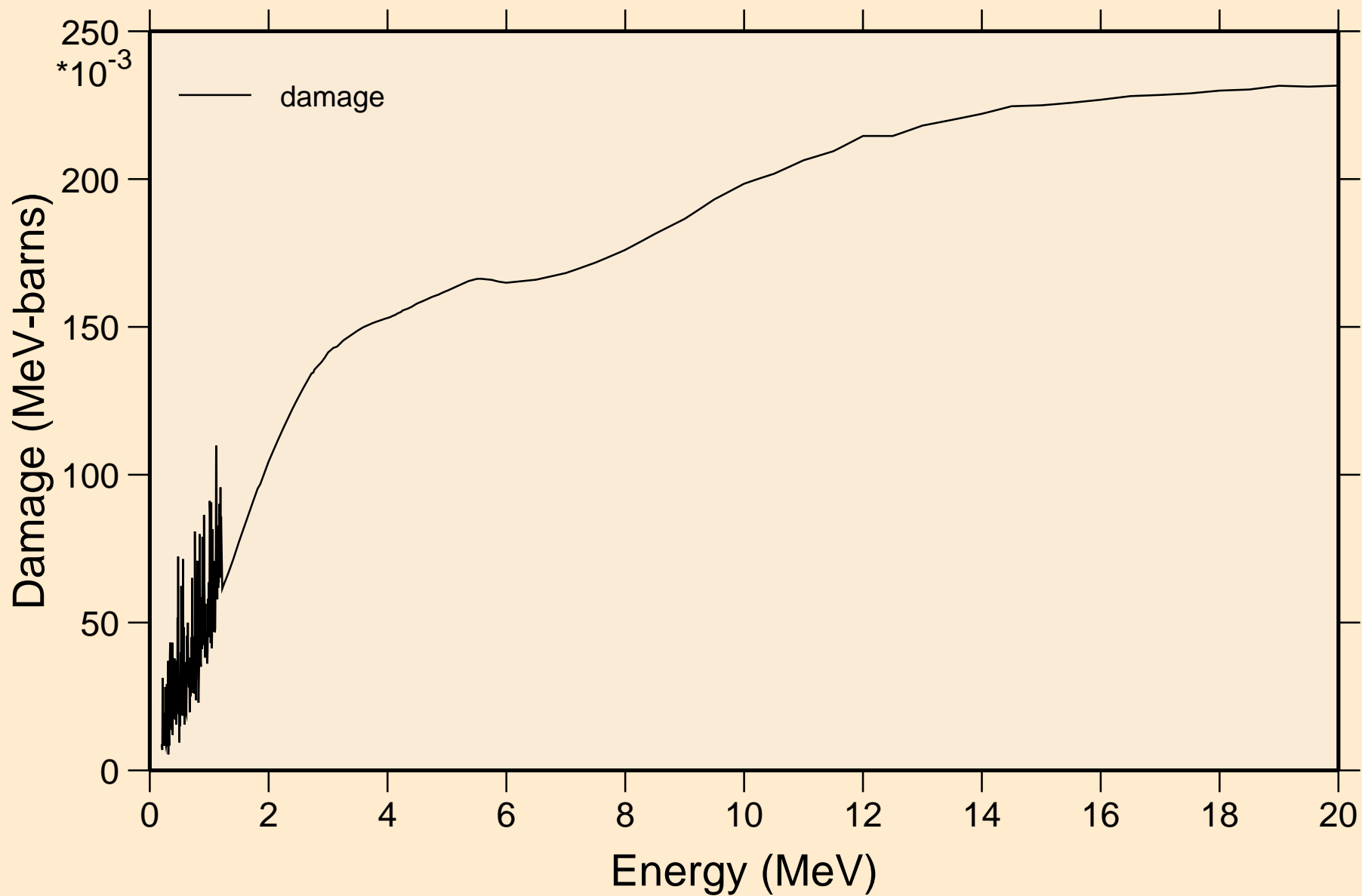

MAT=1725 ACE FILE PRODUCED AT NEA WITH NDEC
Non-threshold reactions

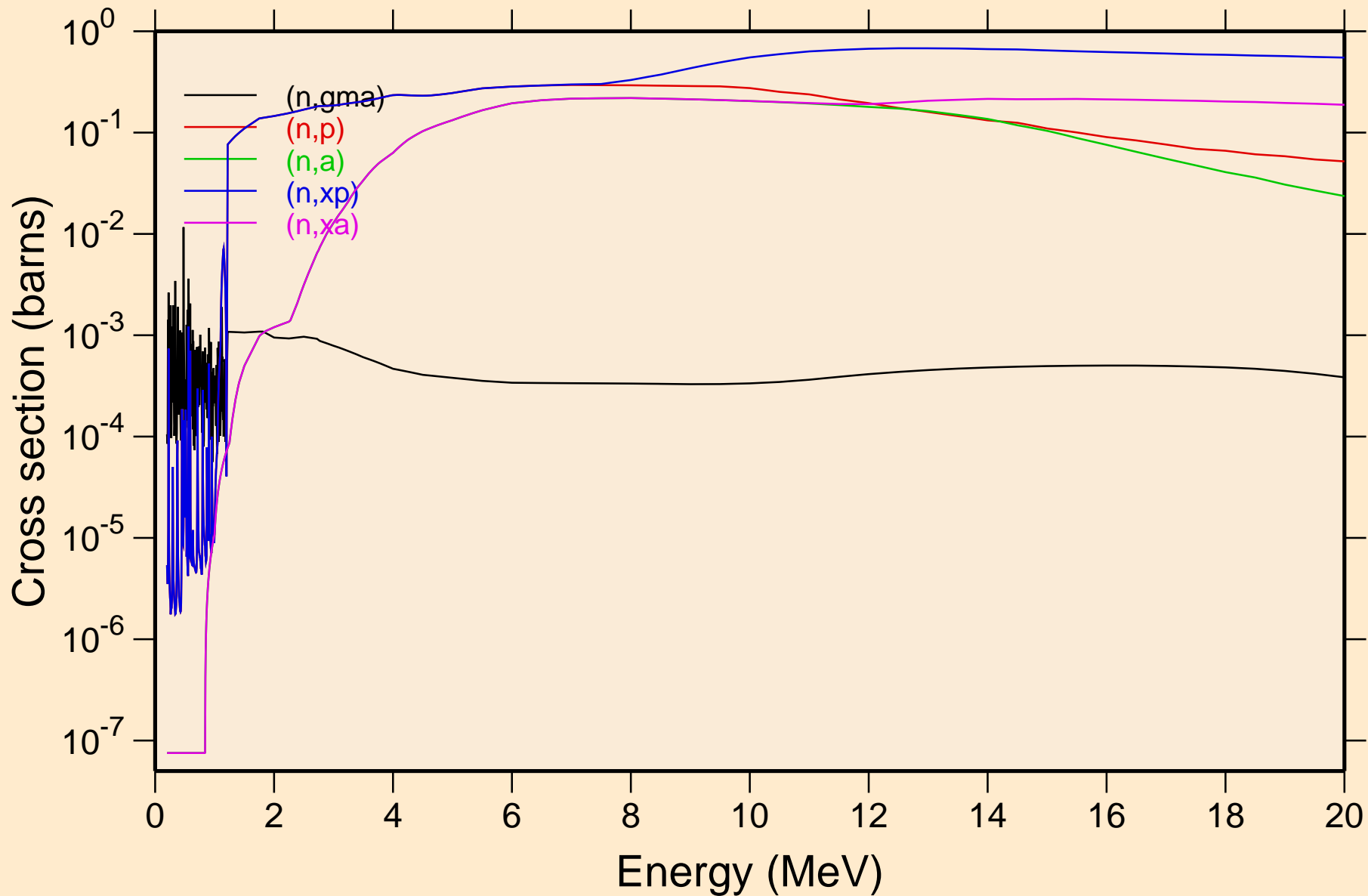

MAT=1725 ACE FILE PRODUCED AT NEA WITH NDEC
Inelastic levels

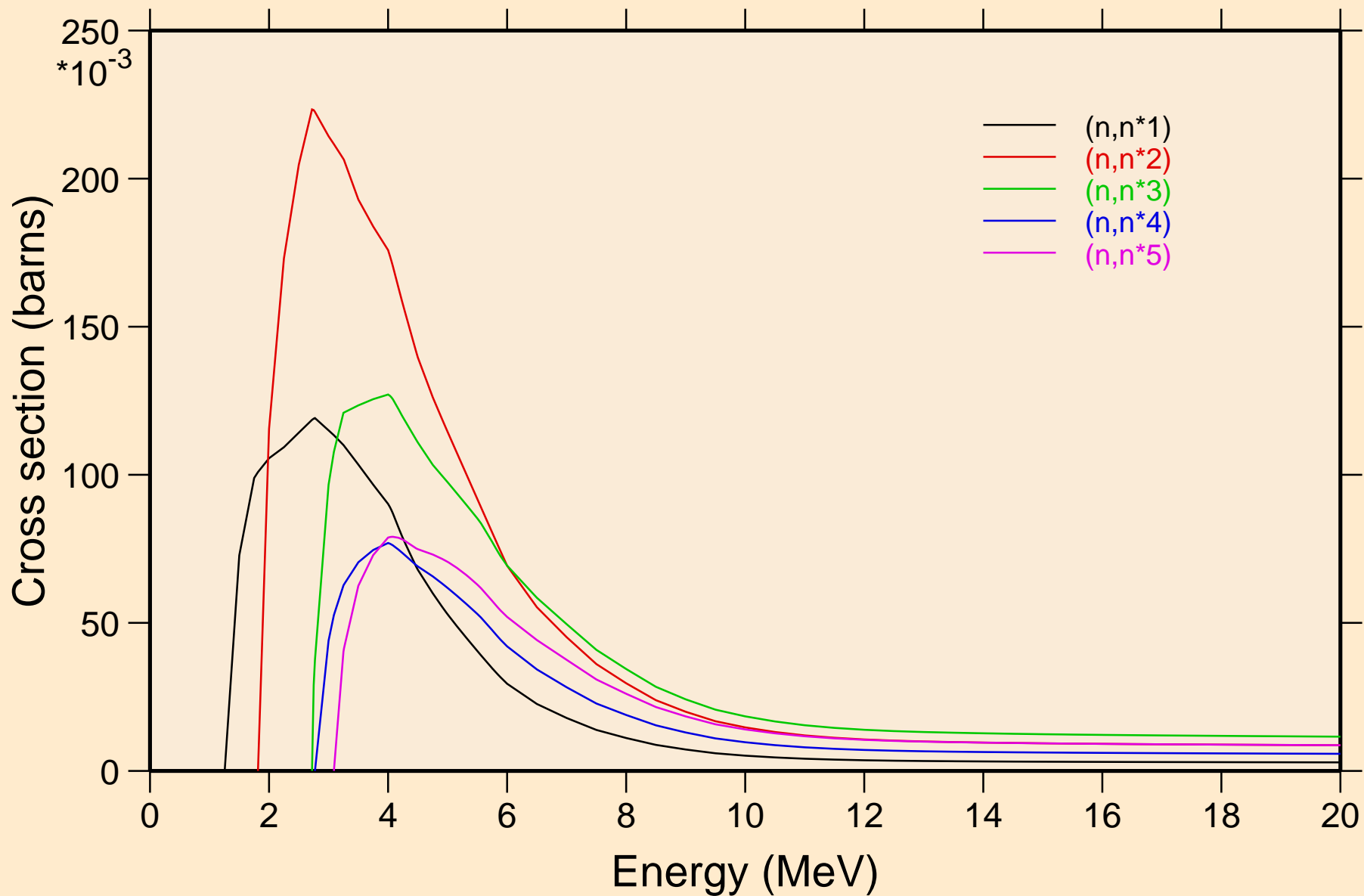

MAT=1725 ACE FILE PRODUCED AT NEA WITH NDEC
Inelastic levels

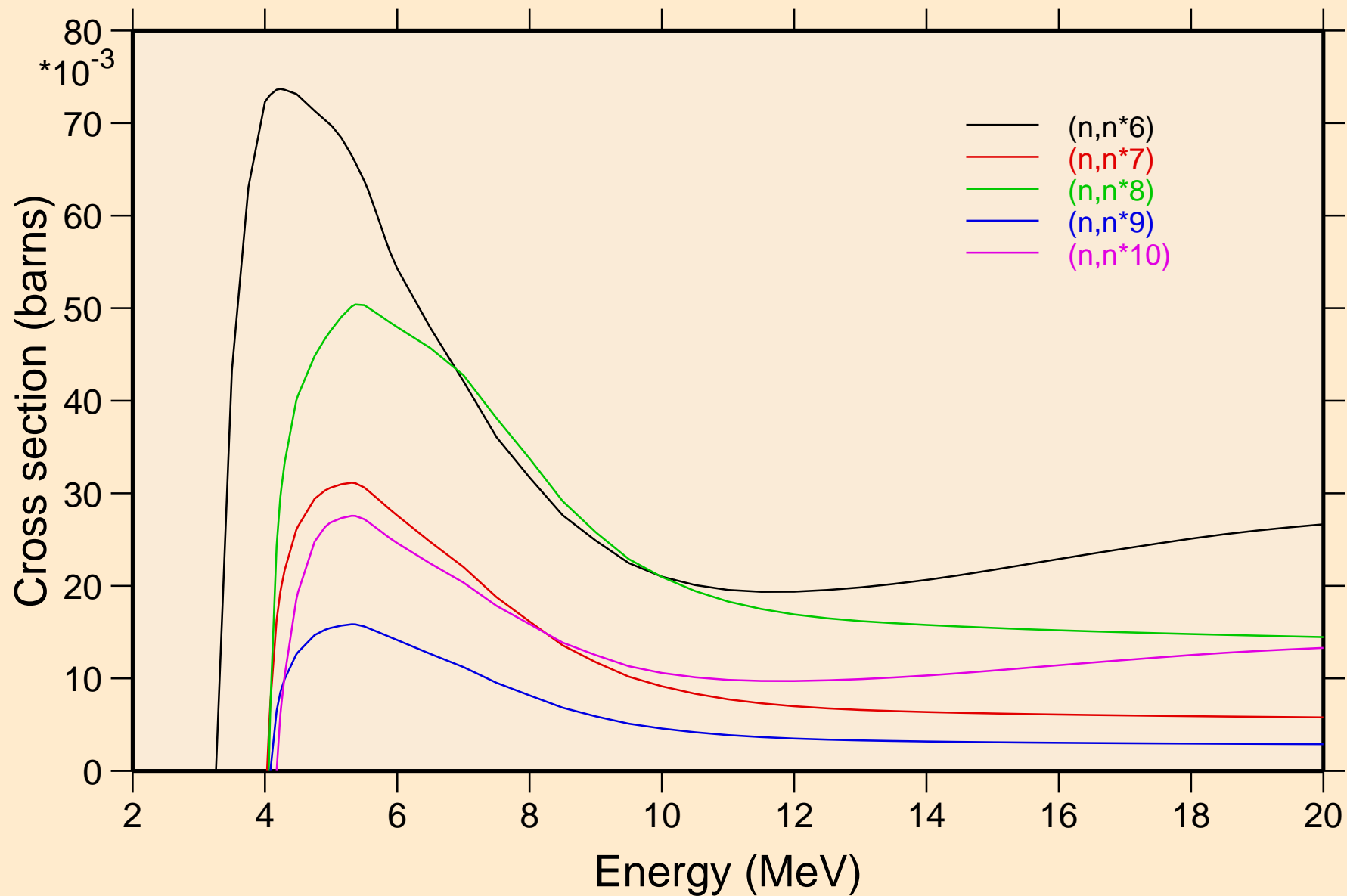

MAT=1725 ACE FILE PRODUCED AT NEA WITH NDEC
Inelastic levels

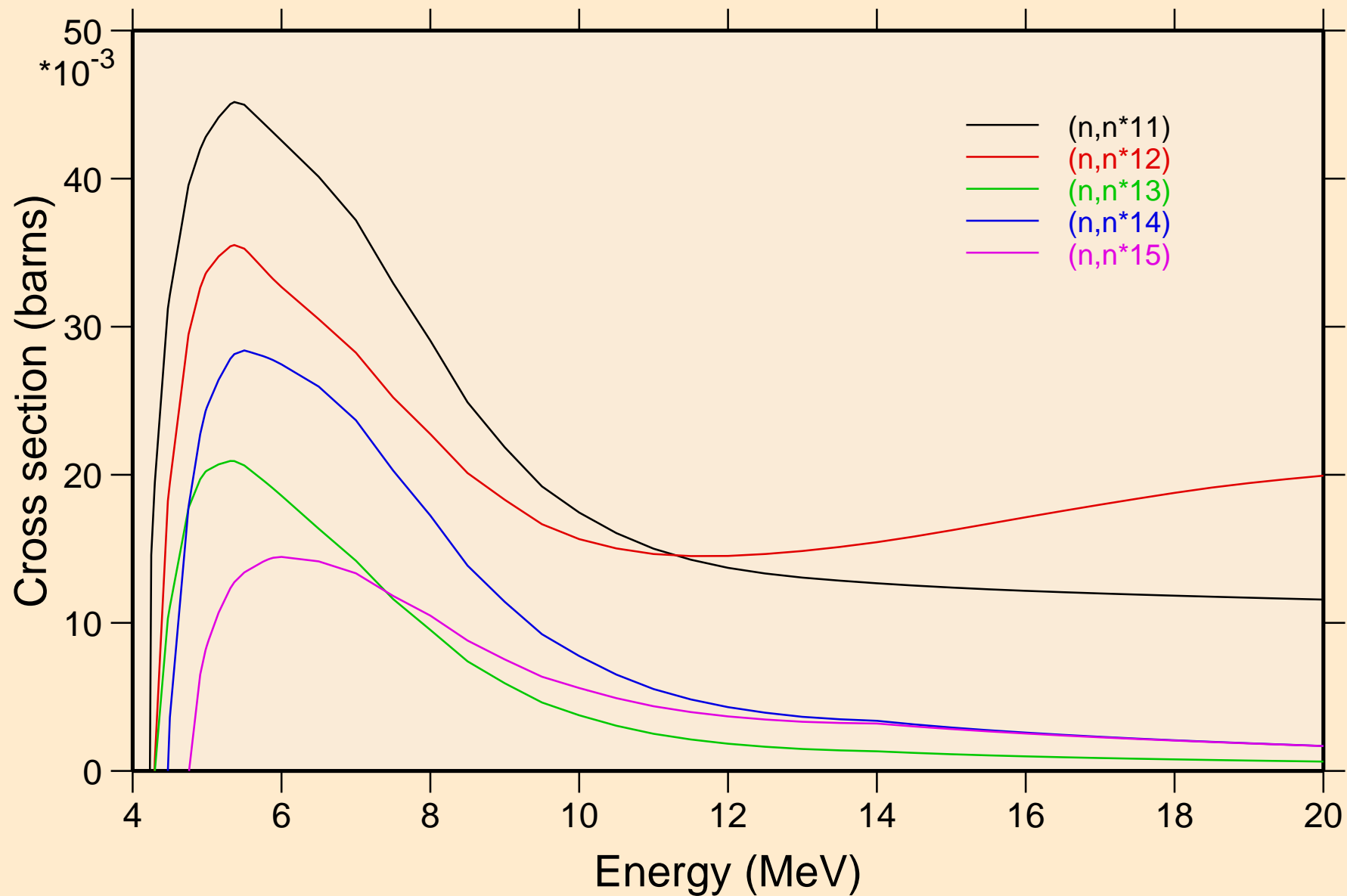

MAT=1725 ACE FILE PRODUCED AT NEA WITH NDEC
Inelastic levels

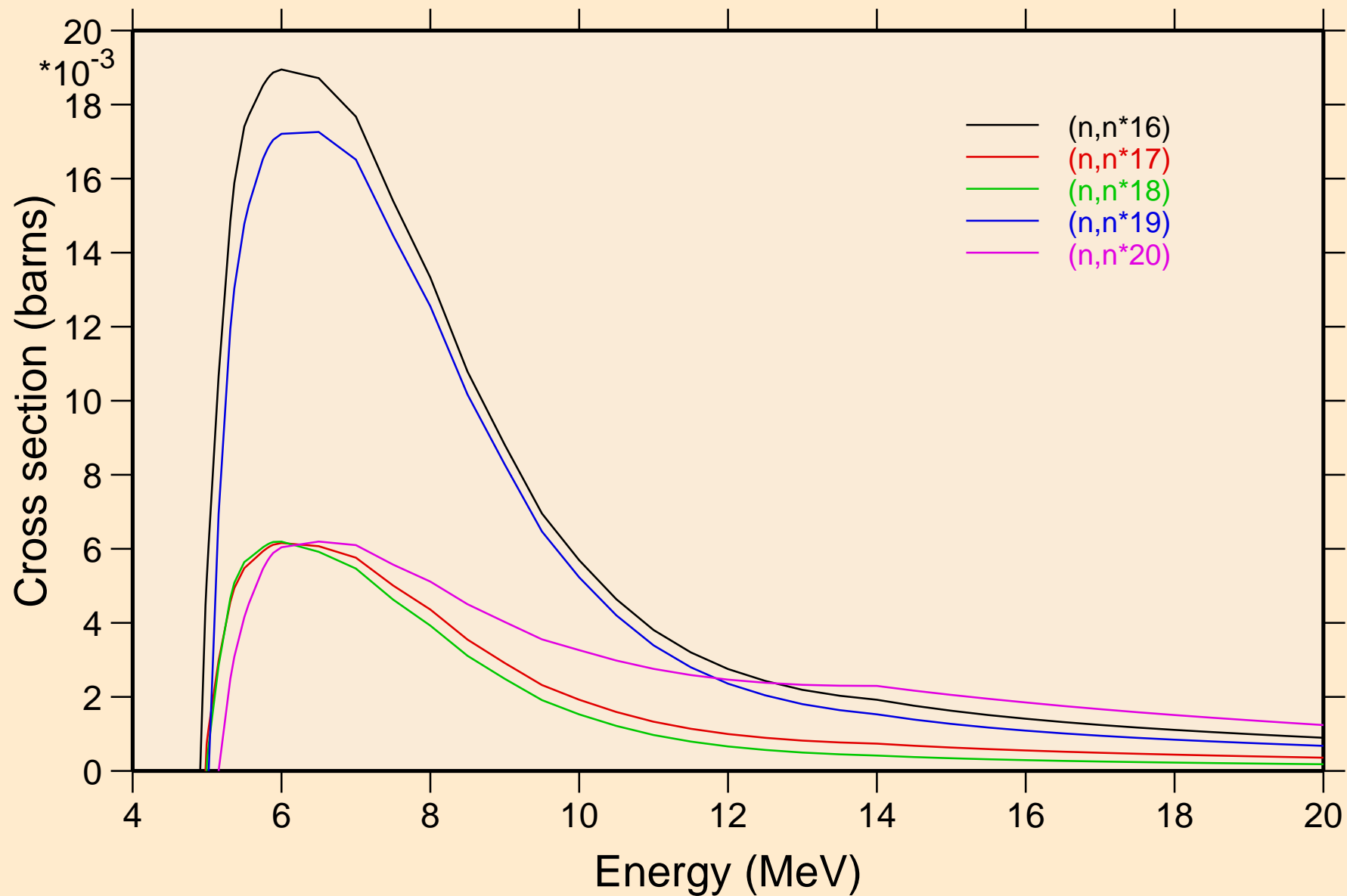

MAT=1725 ACE FILE PRODUCED AT NEA WITH NDEC
Inelastic levels

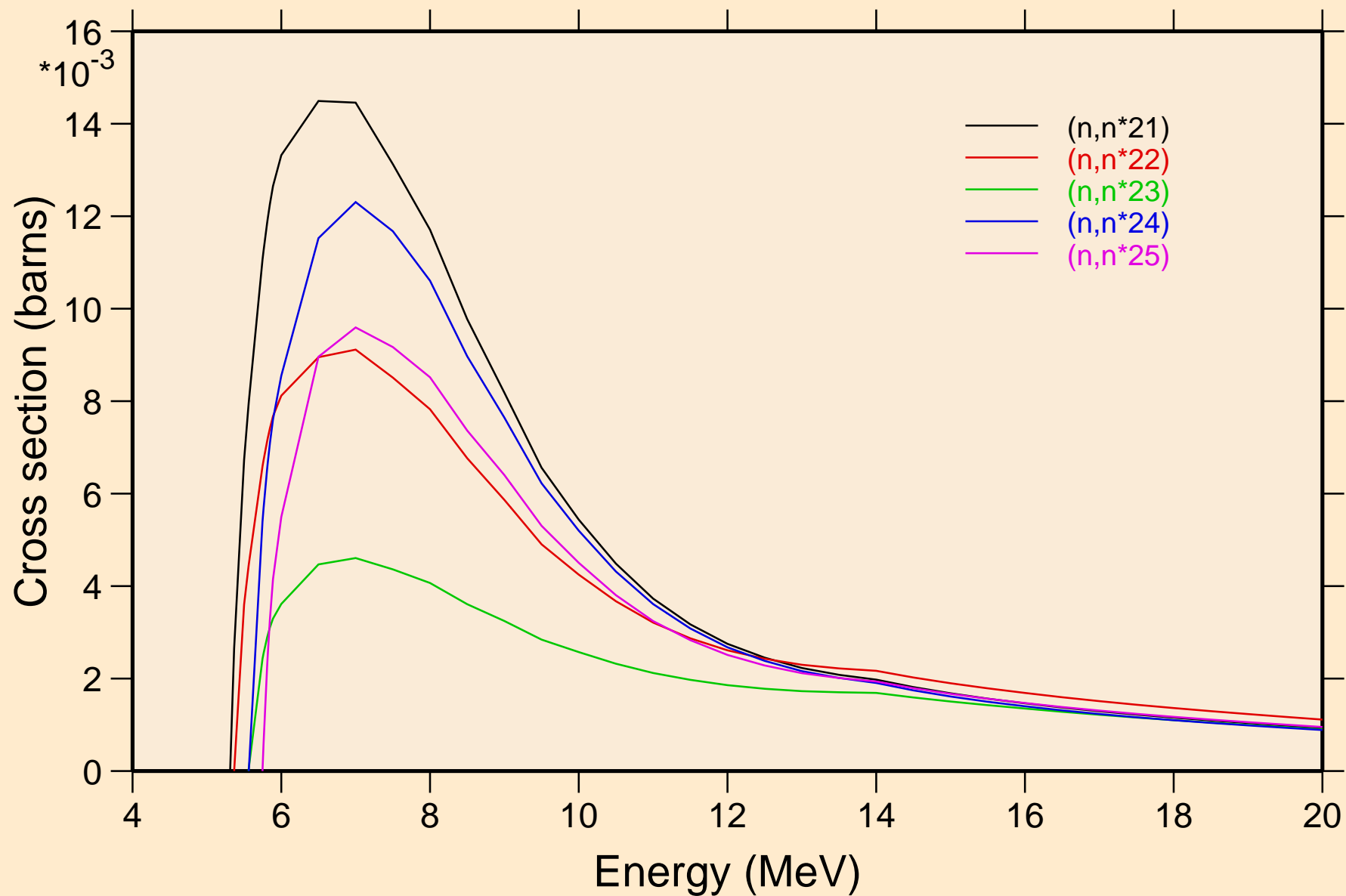

MAT=1725 ACE FILE PRODUCED AT NEA WITH NDEC
Inelastic levels

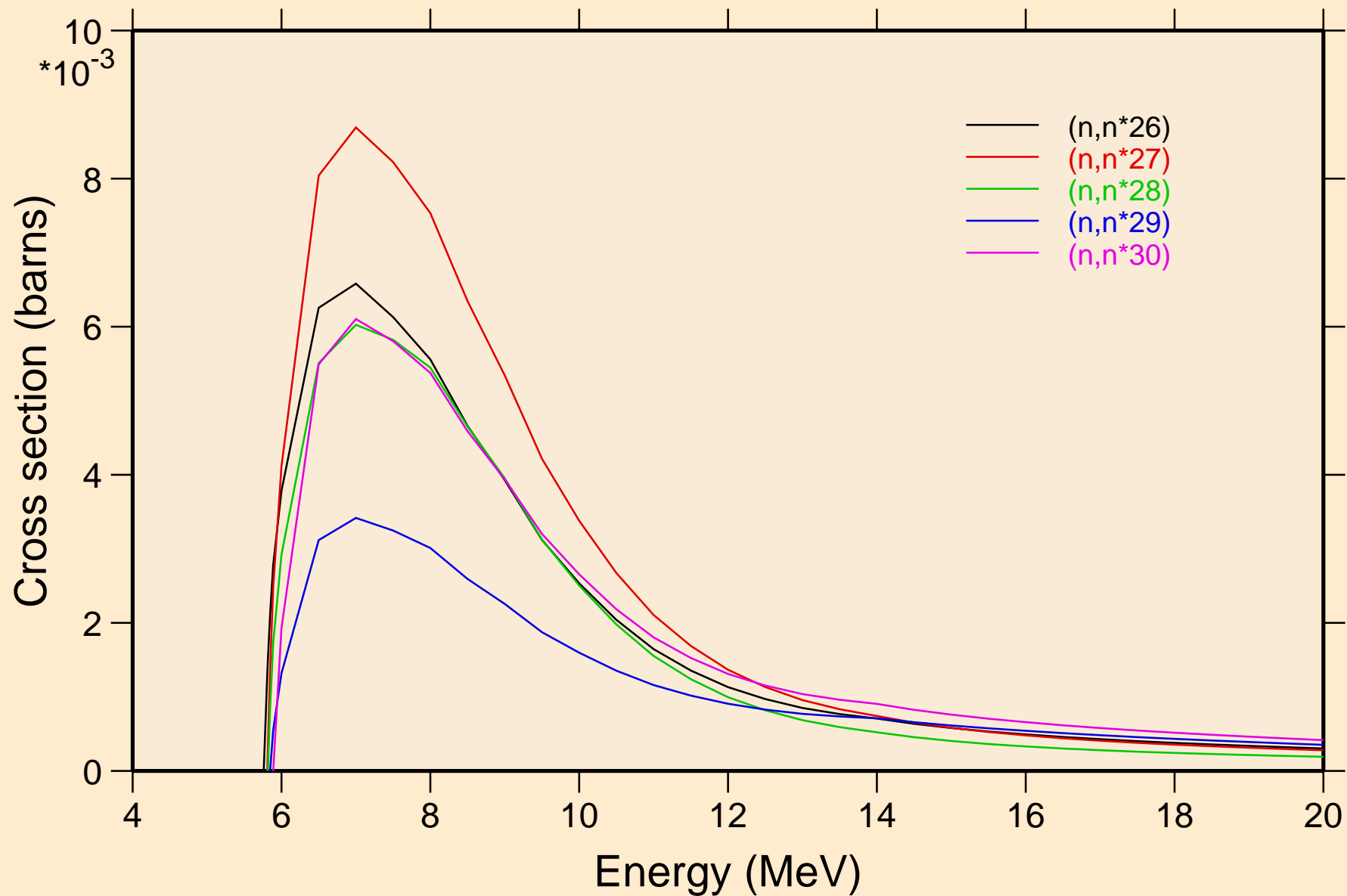

MAT=1725 ACE FILE PRODUCED AT NEA WITH NDEC
Threshold reactions

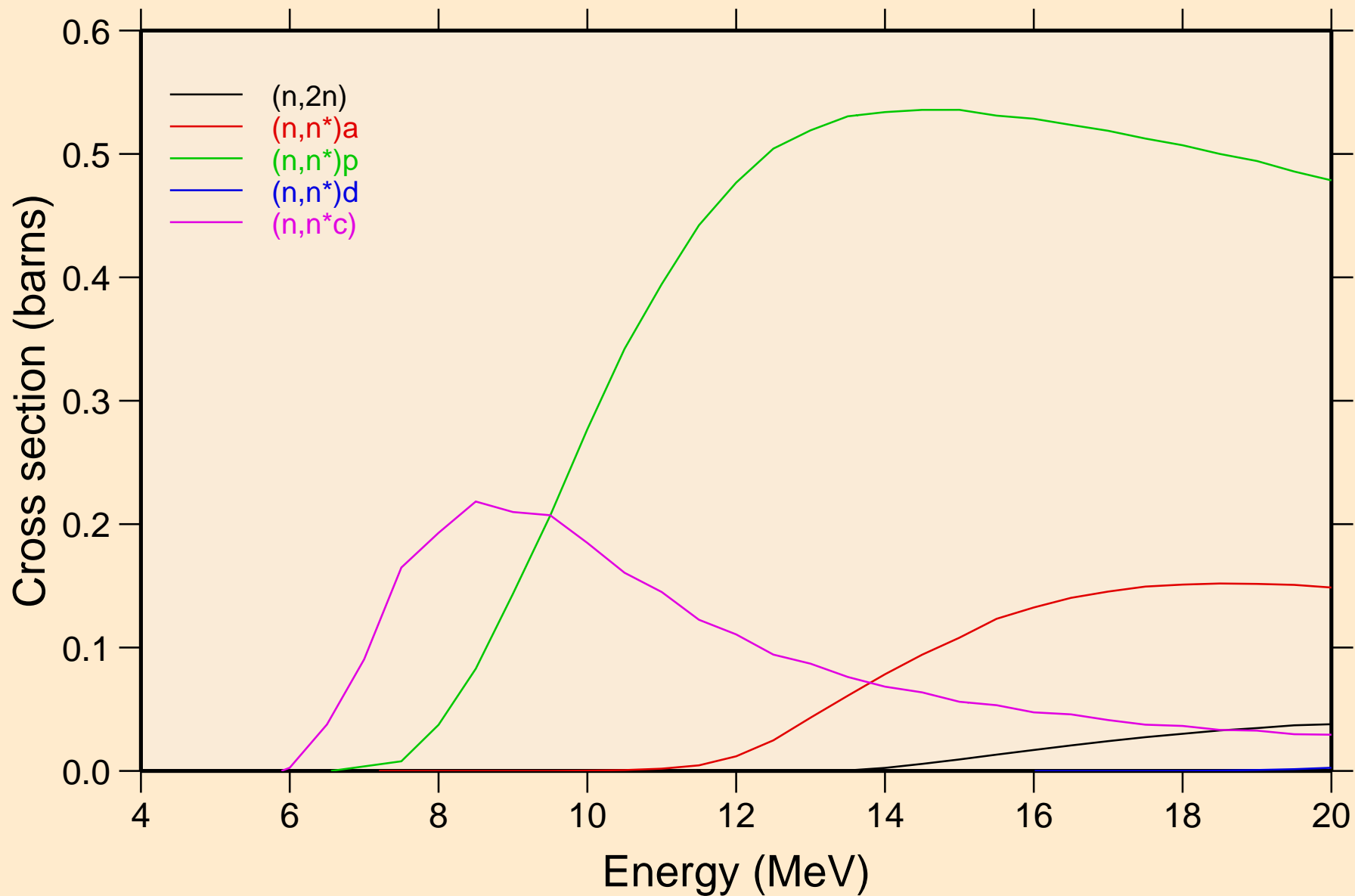

MAT=1725 ACE FILE PRODUCED AT NEA WITH NDEC
Threshold reactions

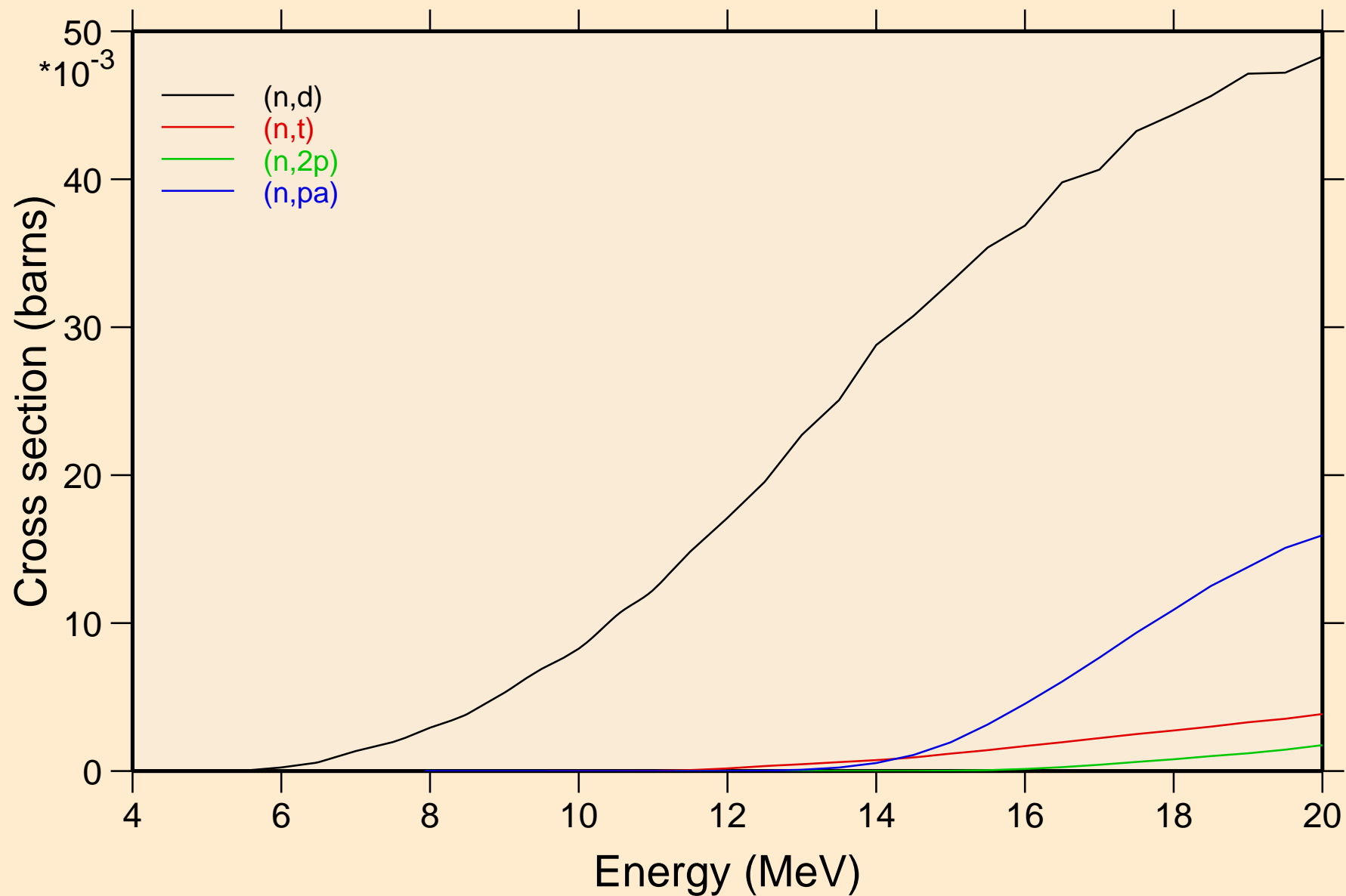

MAT=1725 ACE FILE PRODUCED AT NEA WITH NDEC
Threshold reactions

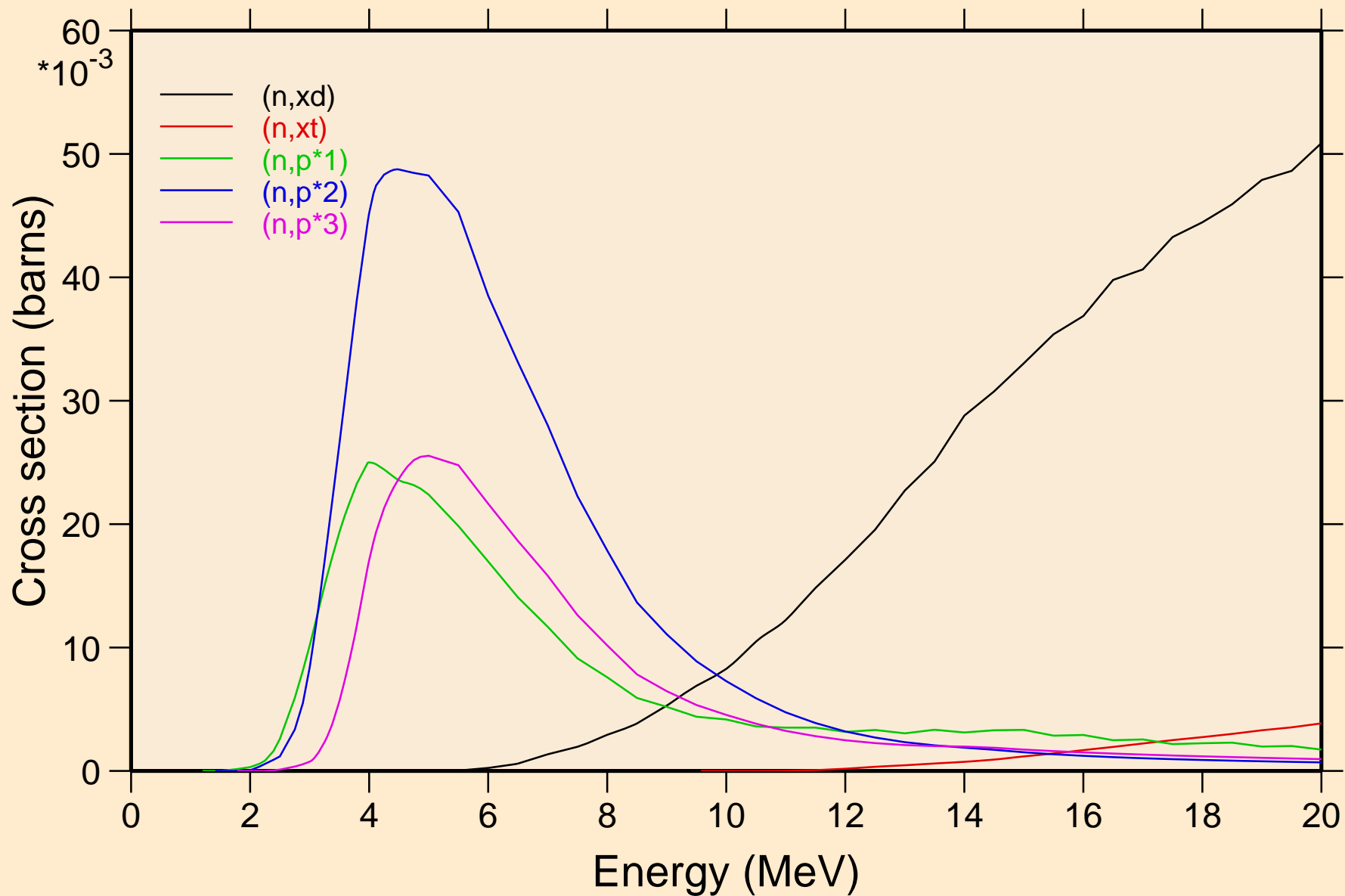

MAT=1725 ACE FILE PRODUCED AT NEA WITH NDEC
Threshold reactions

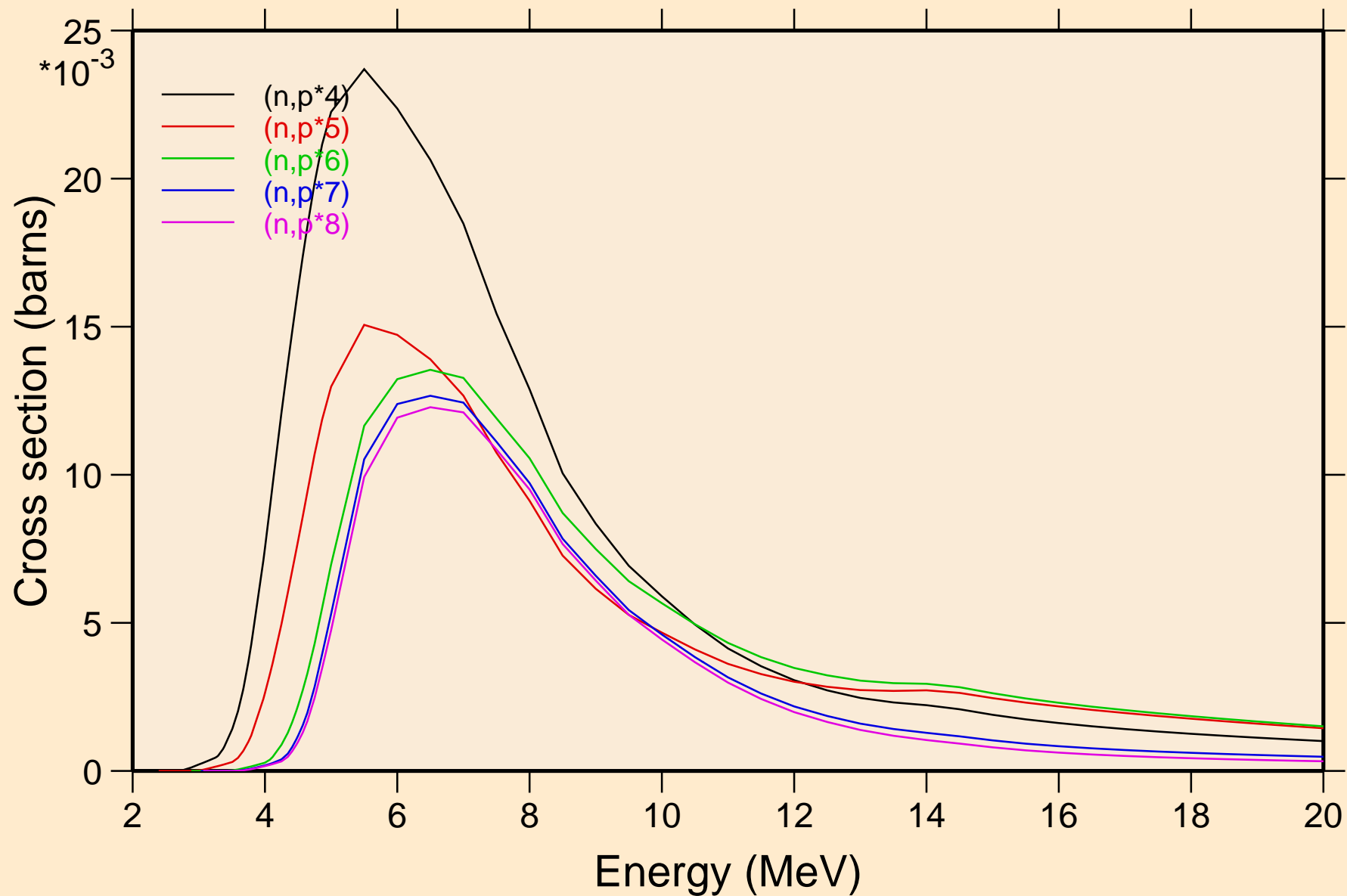

MAT=1725 ACE FILE PRODUCED AT NEA WITH NDEC
Threshold reactions

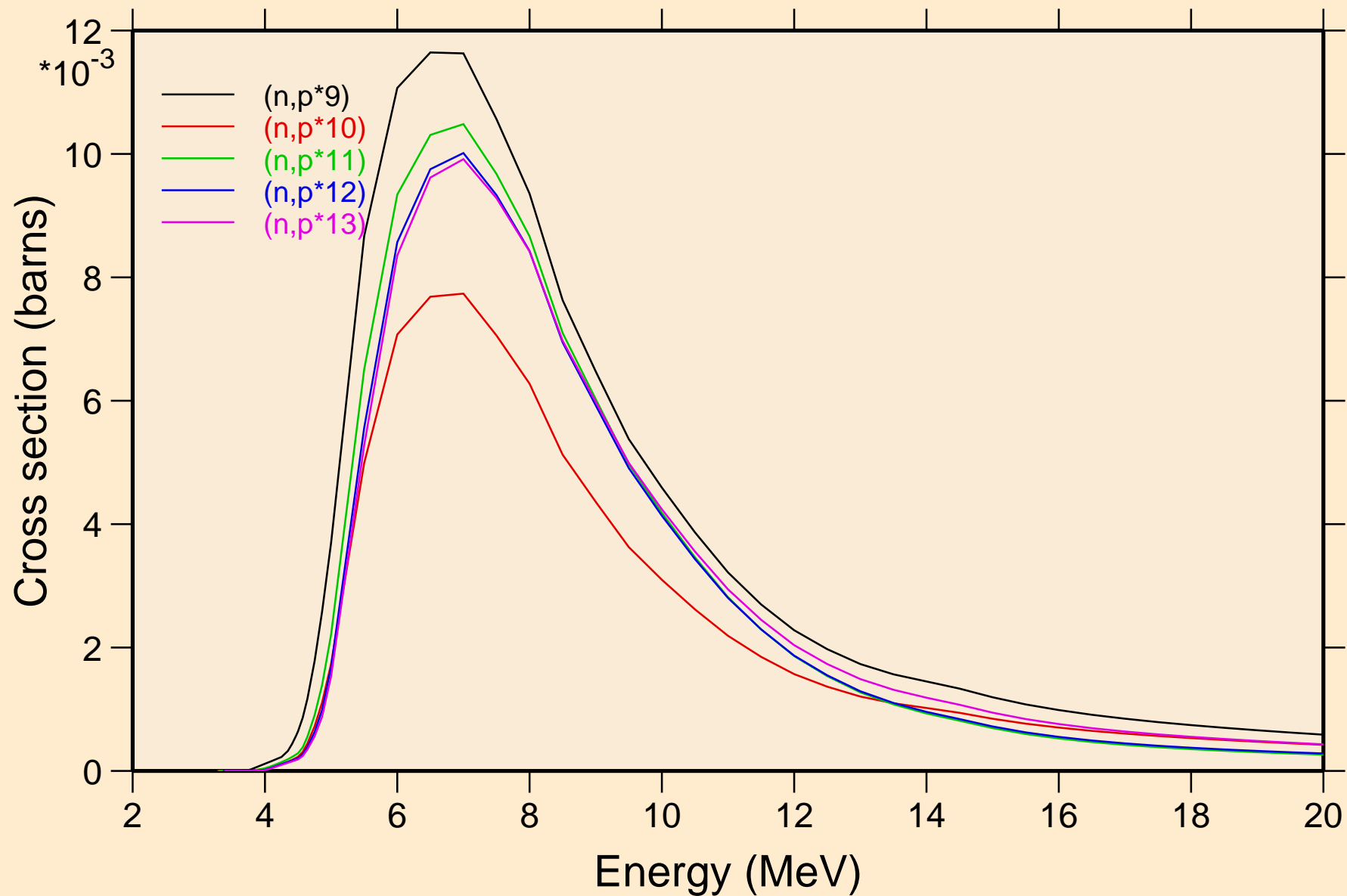

MAT=1725 ACE FILE PRODUCED AT NEA WITH NDEC
Threshold reactions

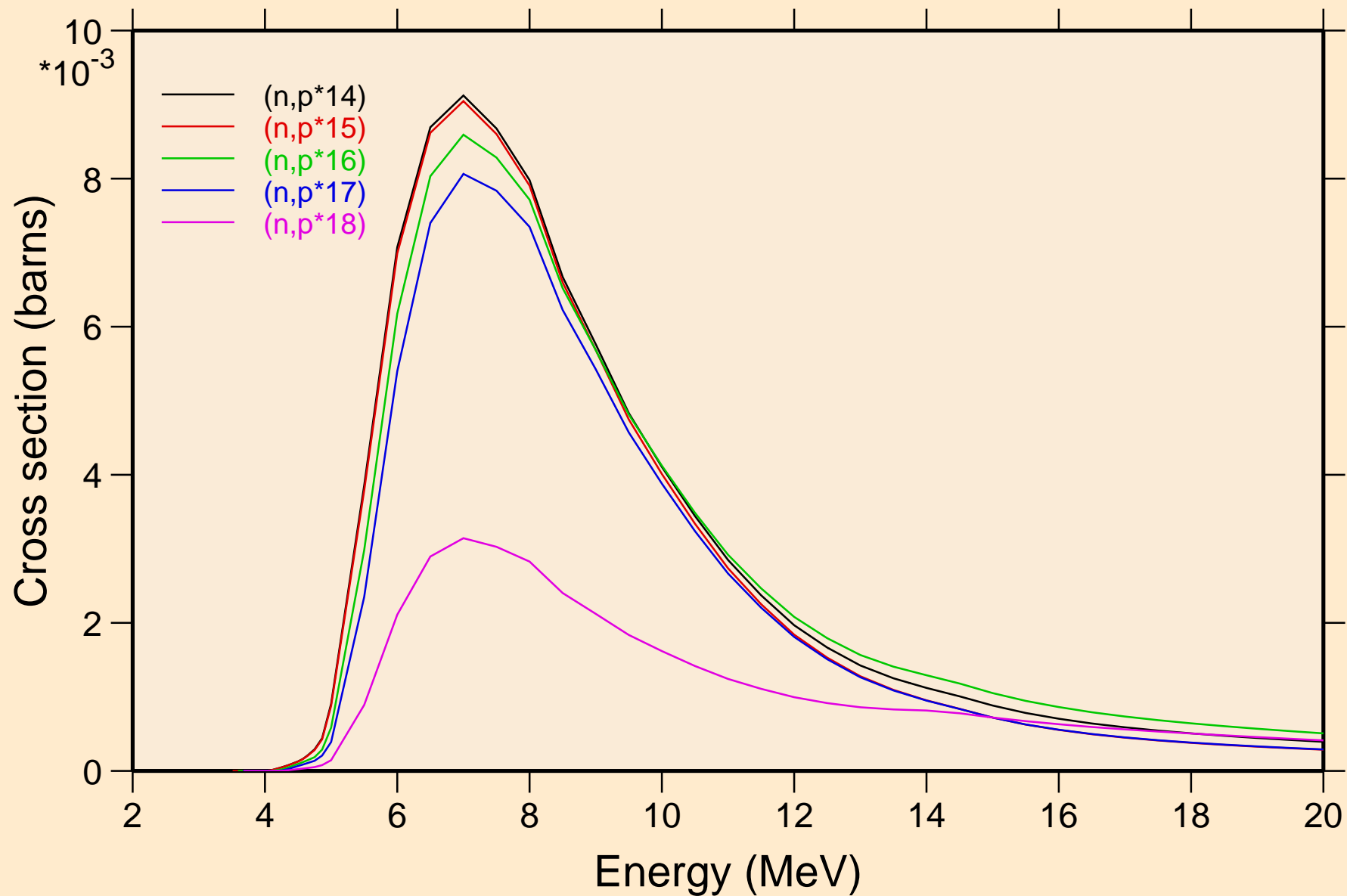

MAT=1725 ACE FILE PRODUCED AT NEA WITH NDEC
Threshold reactions

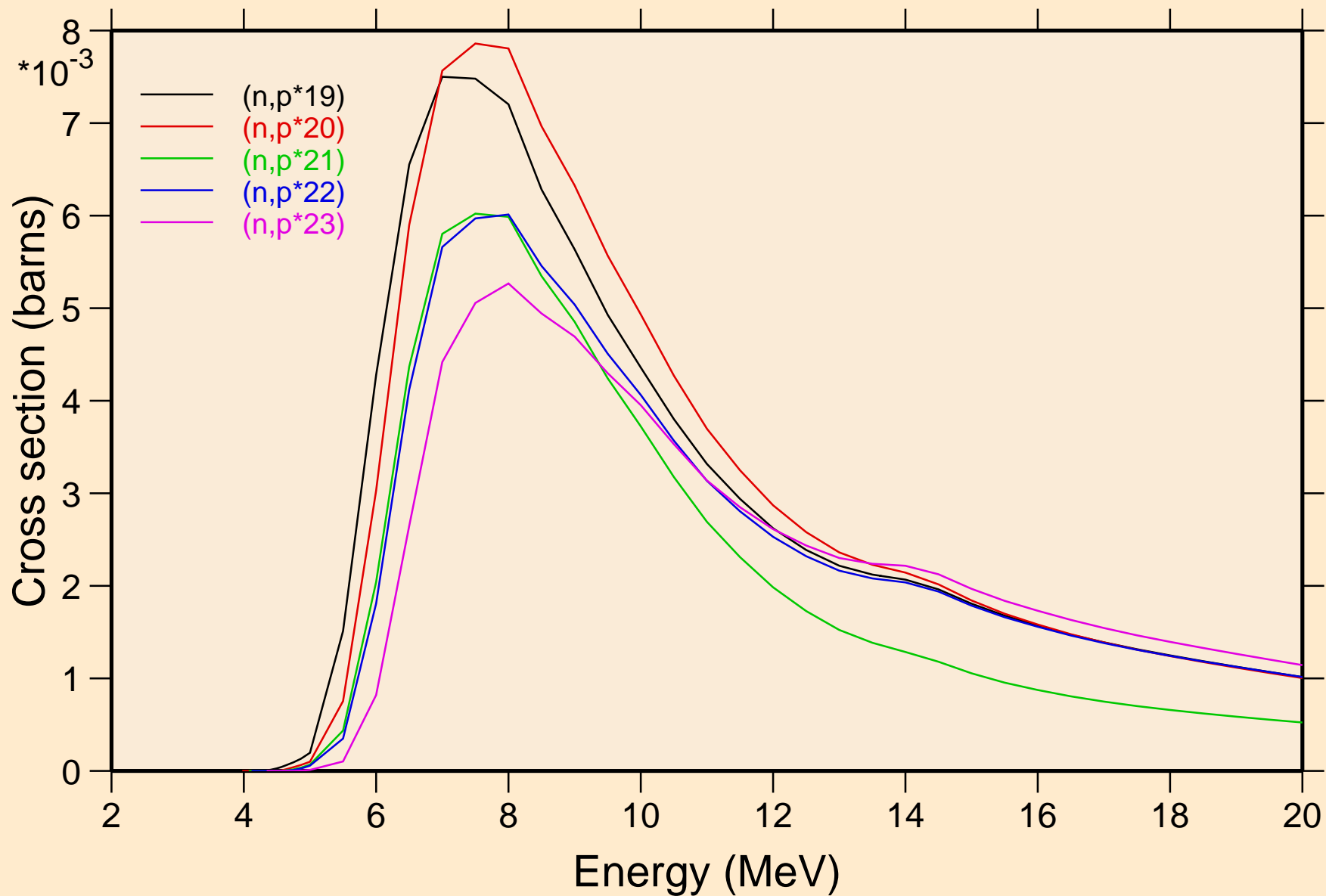

MAT=1725 ACE FILE PRODUCED AT NEA WITH NDEC
Threshold reactions

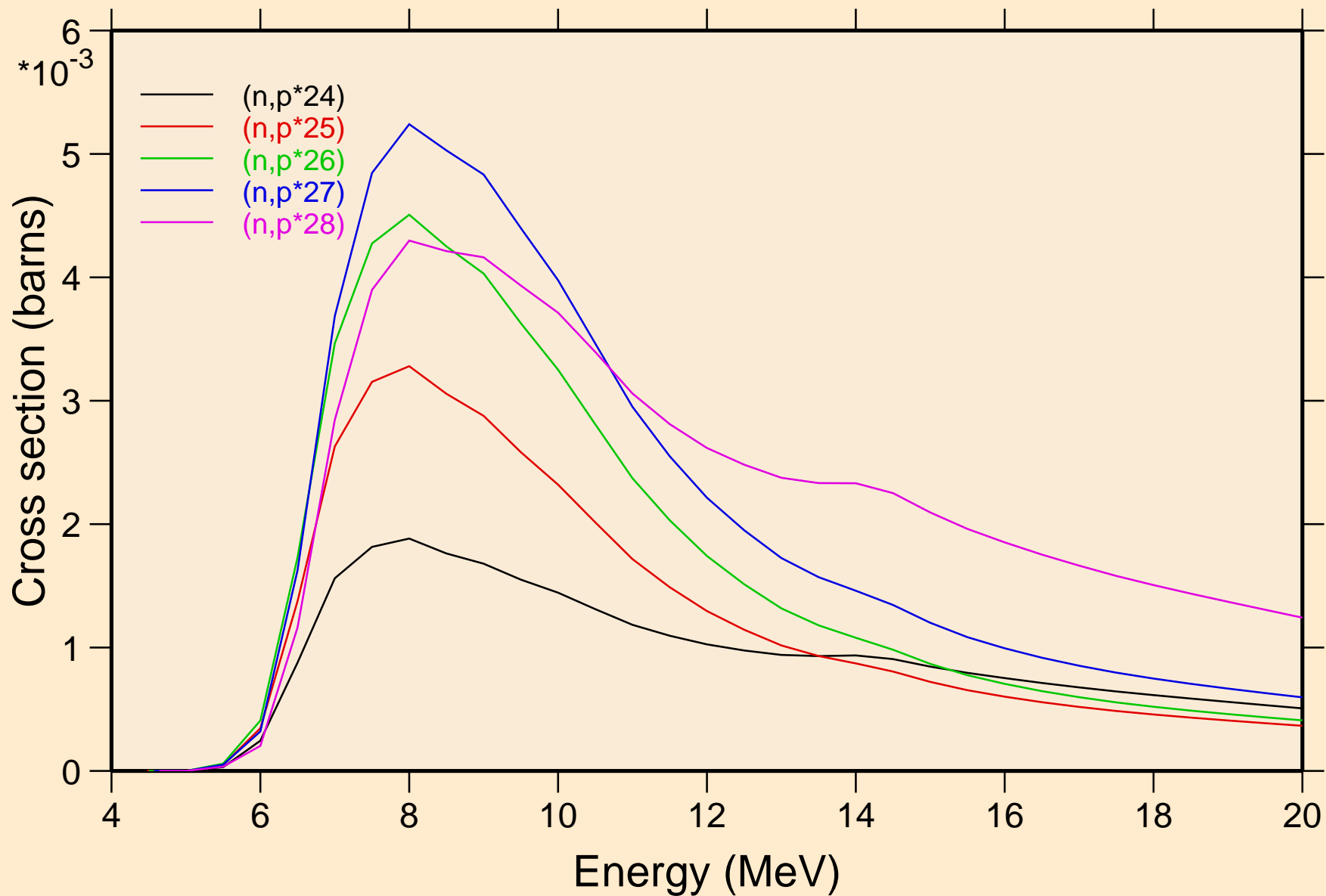

MAT=1725 ACE FILE PRODUCED AT NEA WITH NDEC
Threshold reactions

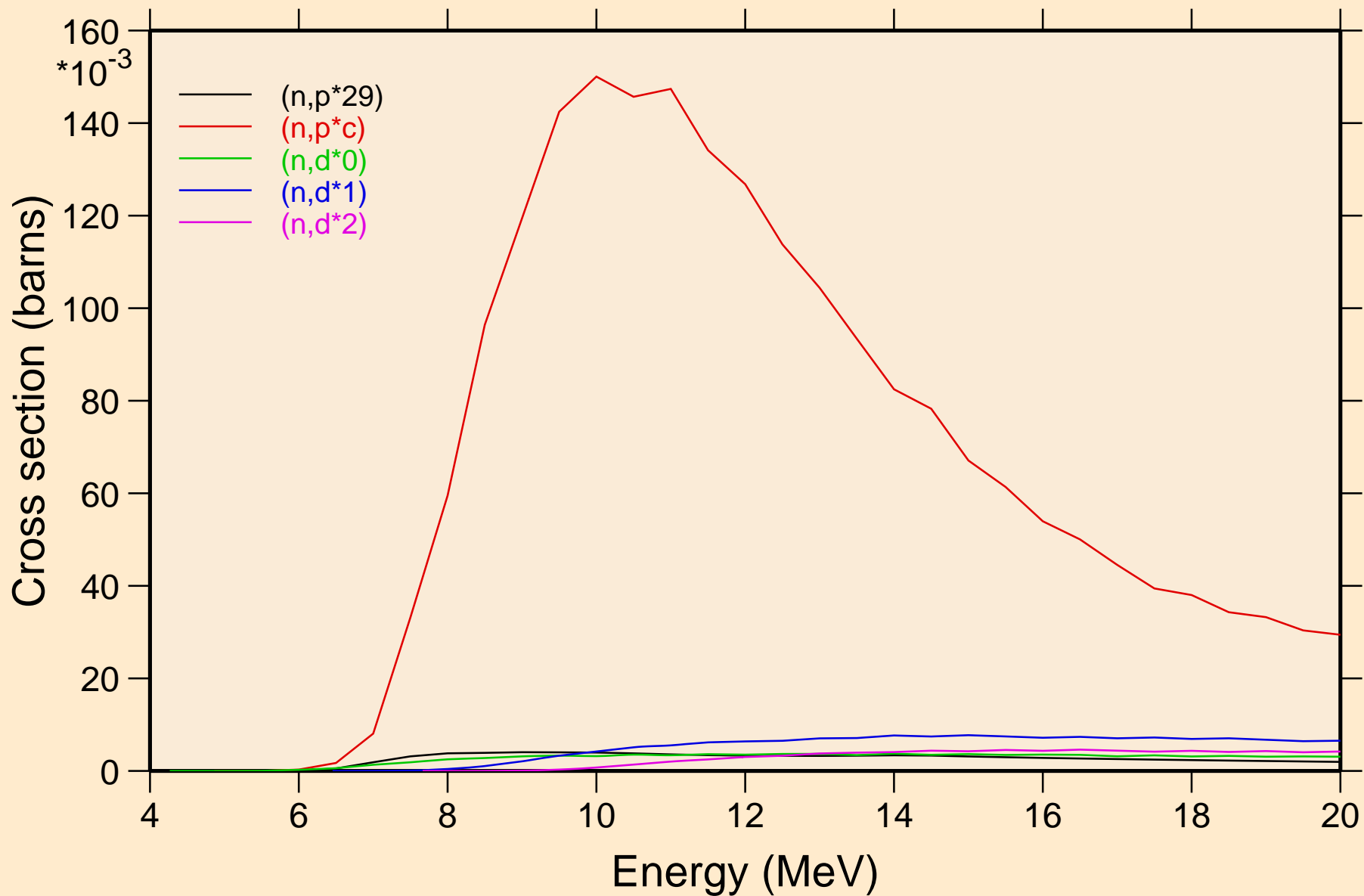

MAT=1725 ACE FILE PRODUCED AT NEA WITH NDEC
Threshold reactions

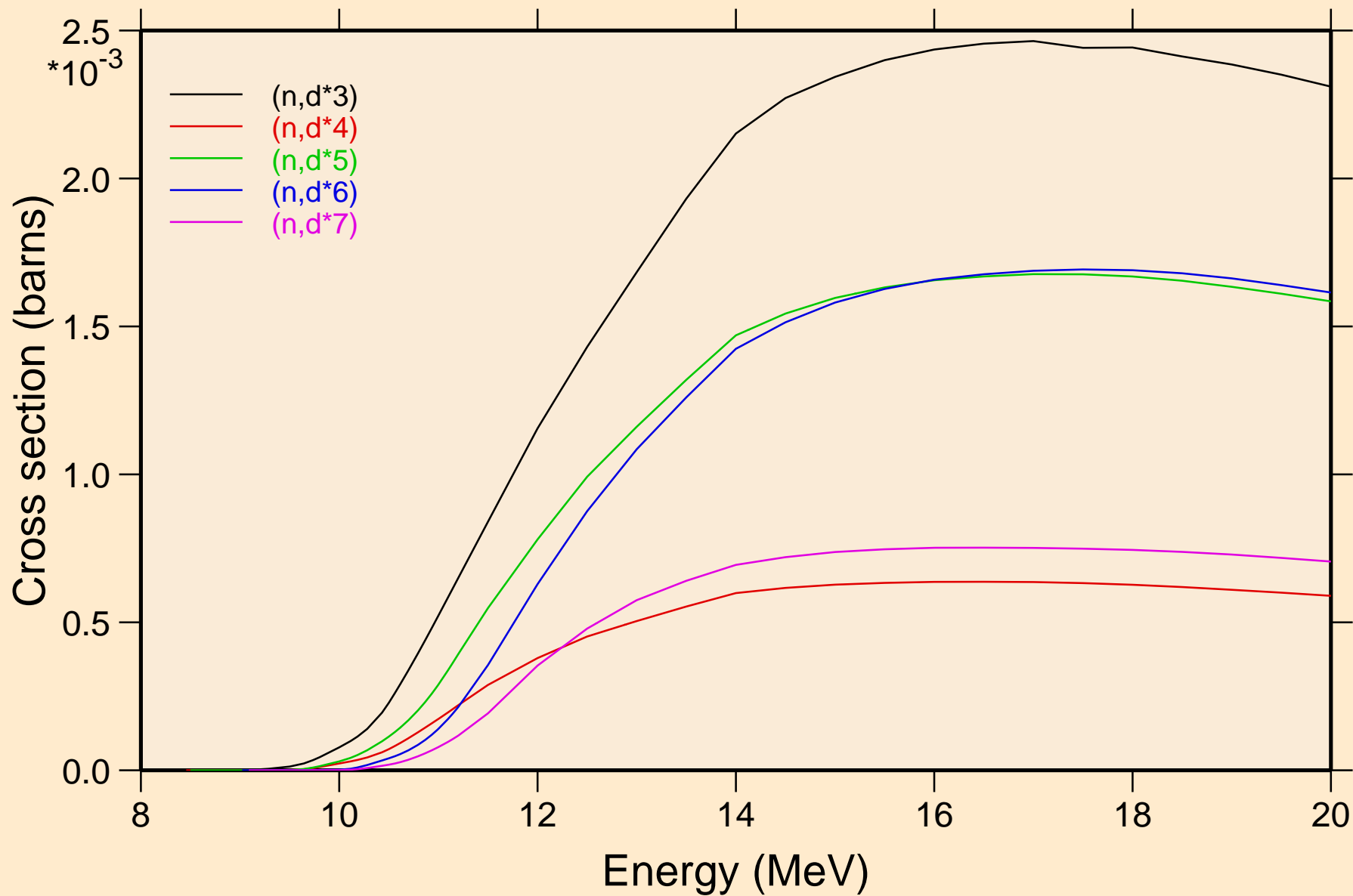

MAT=1725 ACE FILE PRODUCED AT NEA WITH NDEC
Threshold reactions

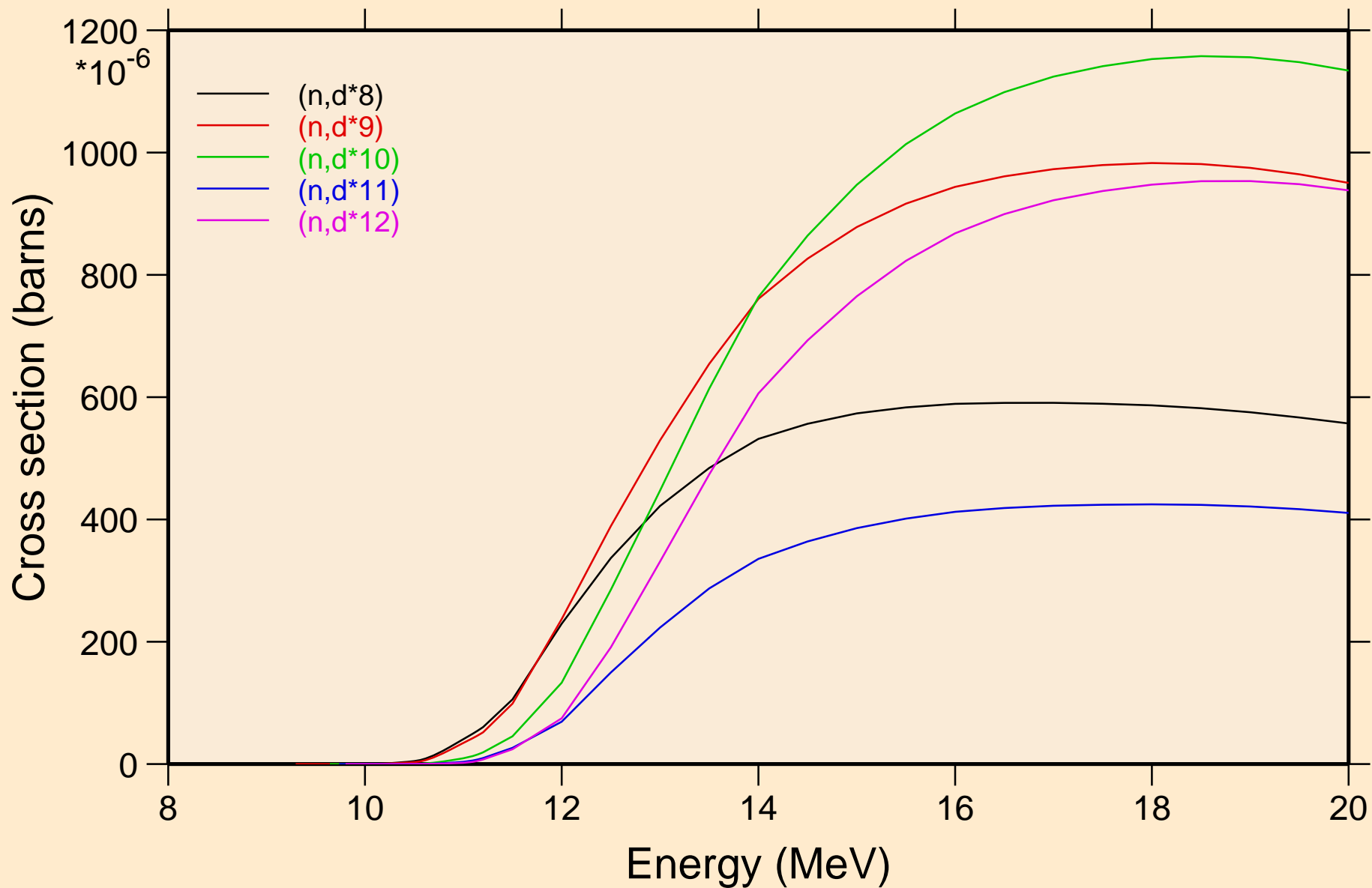

MAT=1725 ACE FILE PRODUCED AT NEA WITH NDEC
Threshold reactions

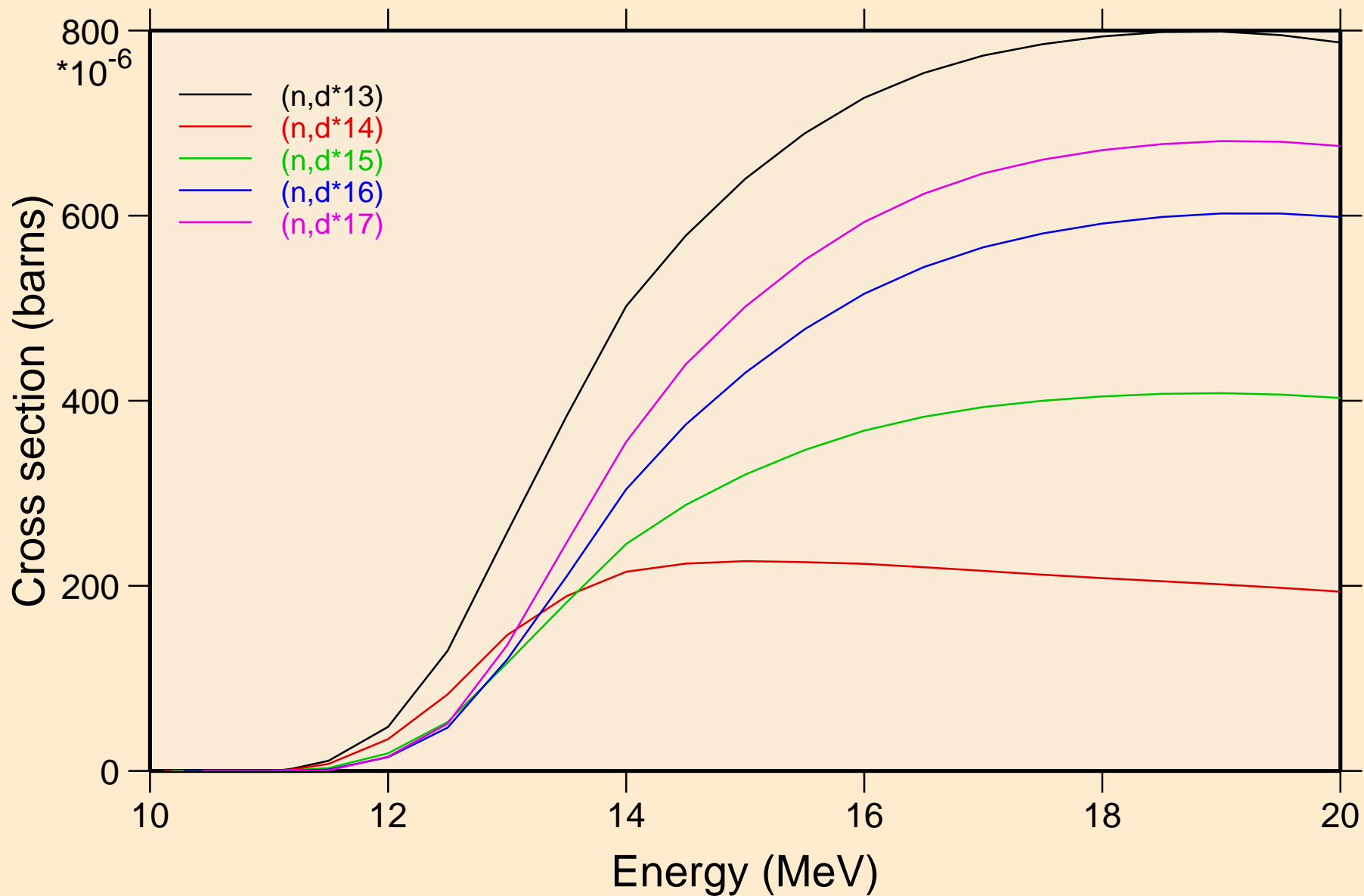

MAT=1725 ACE FILE PRODUCED AT NEA WITH NDEC
Threshold reactions

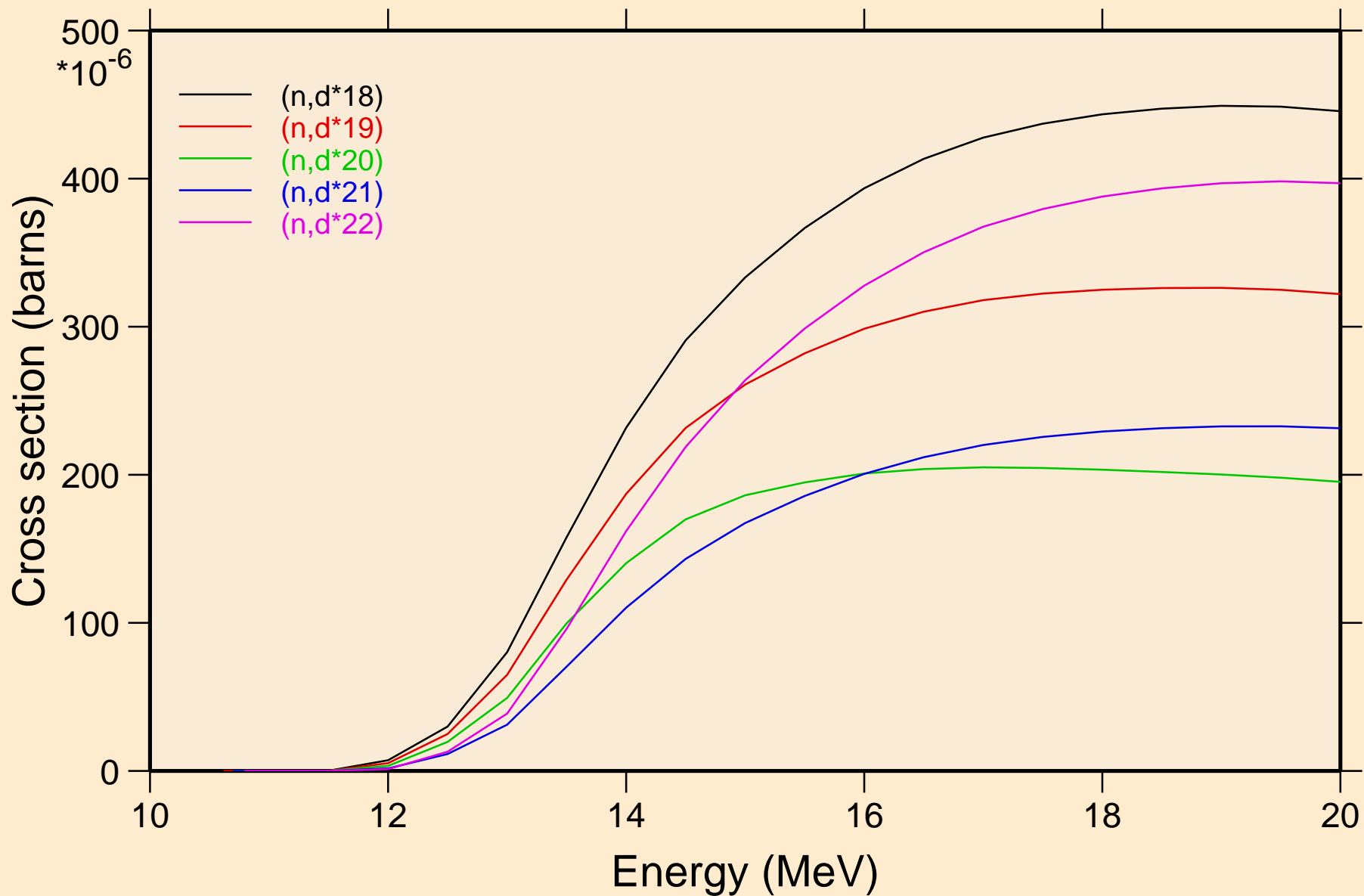

MAT=1725 ACE FILE PRODUCED AT NEA WITH NDEC
Threshold reactions

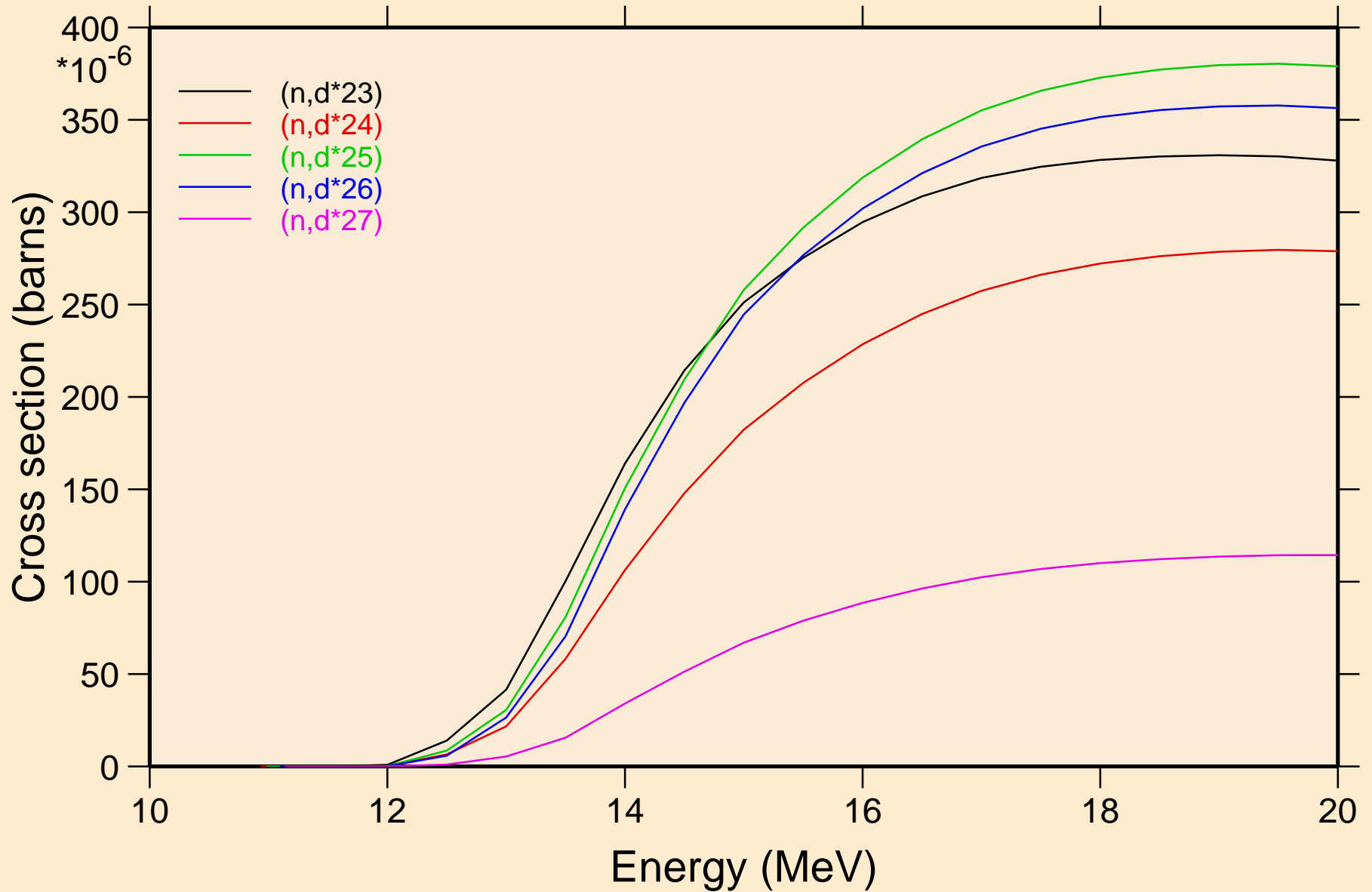

MAT=1725 ACE FILE PRODUCED AT NEA WITH NDEC
Threshold reactions

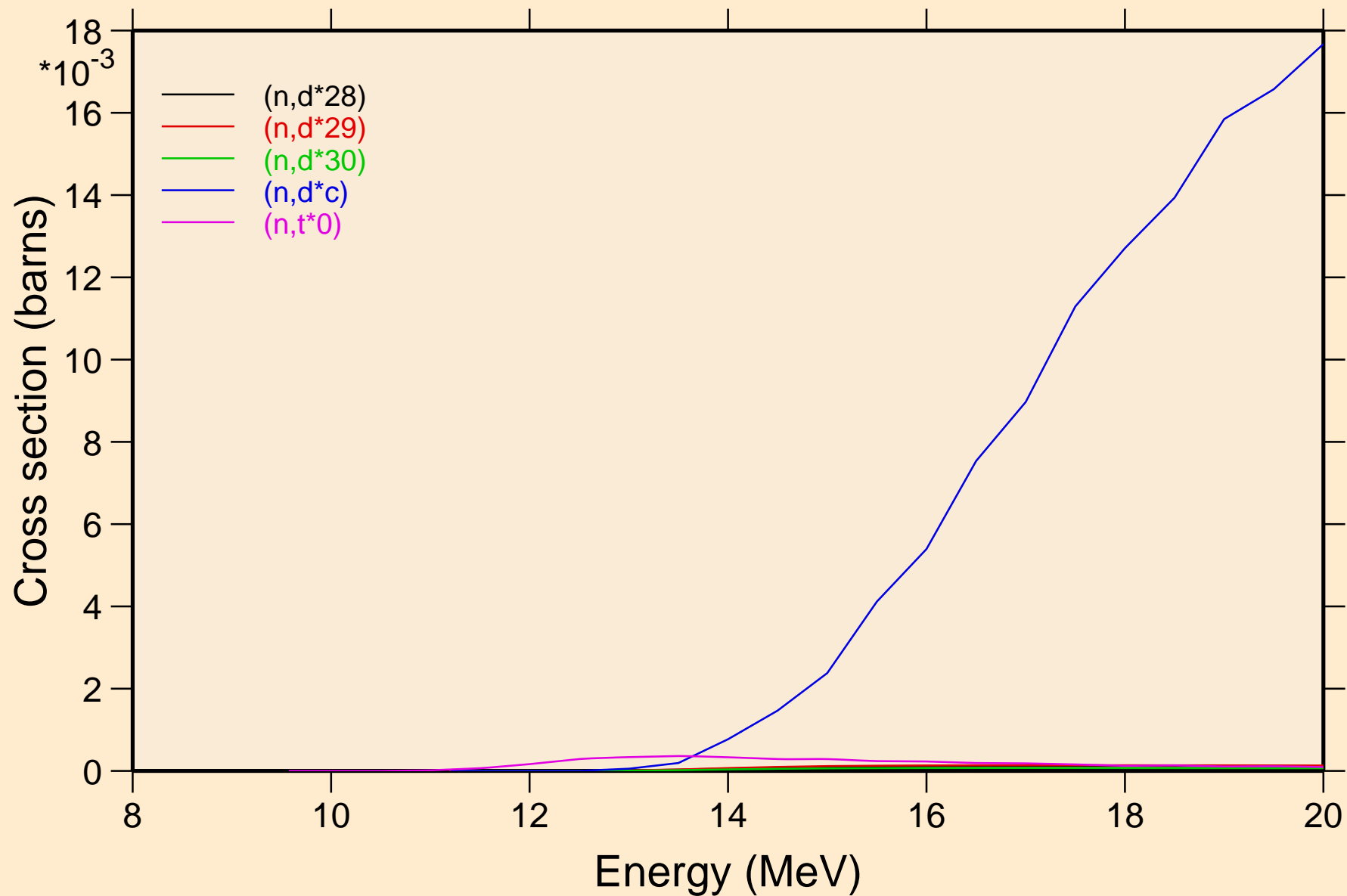

MAT=1725 ACE FILE PRODUCED AT NEA WITH NDEC
Threshold reactions

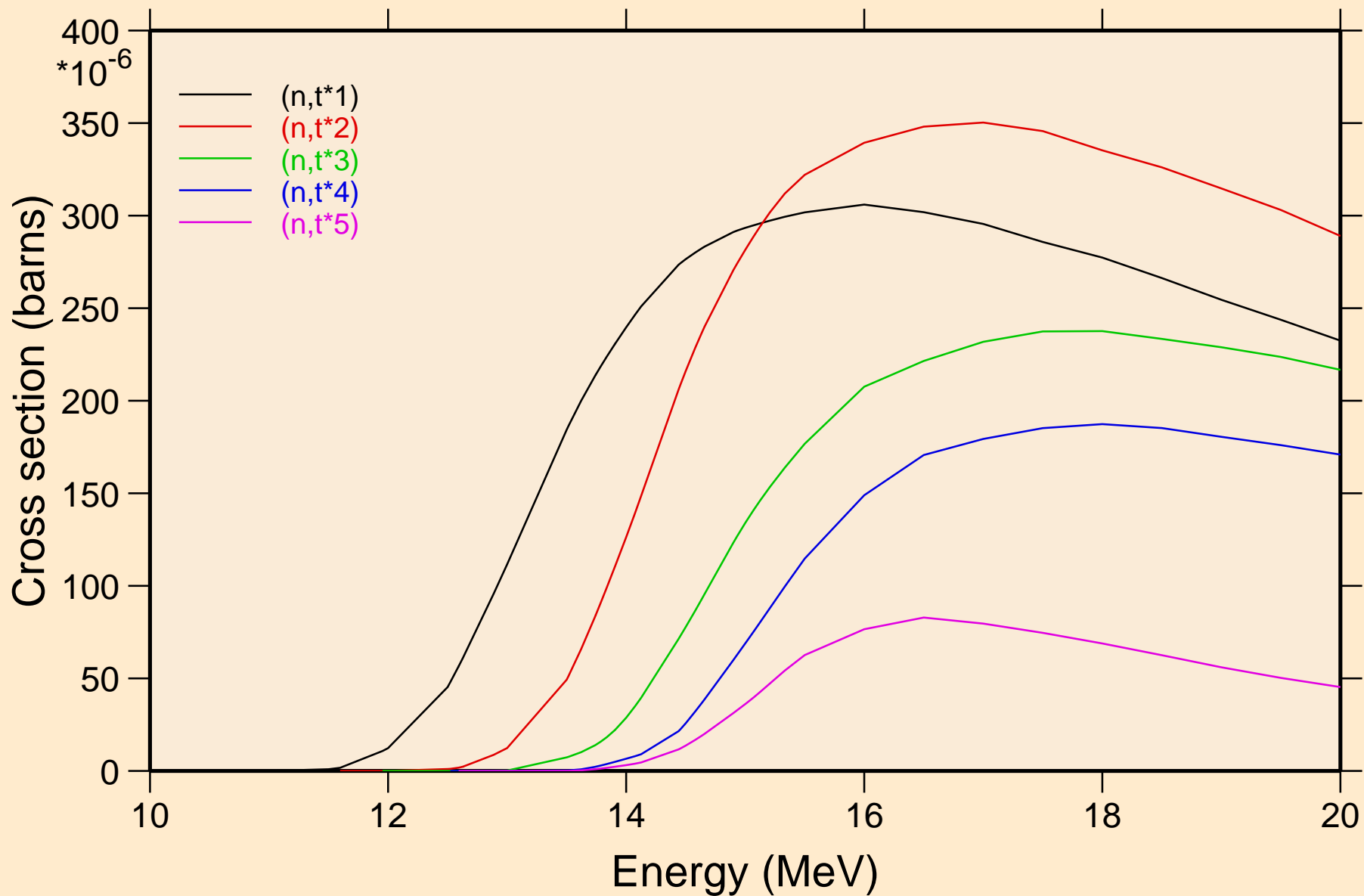

MAT=1725 ACE FILE PRODUCED AT NEA WITH NDEC
Threshold reactions

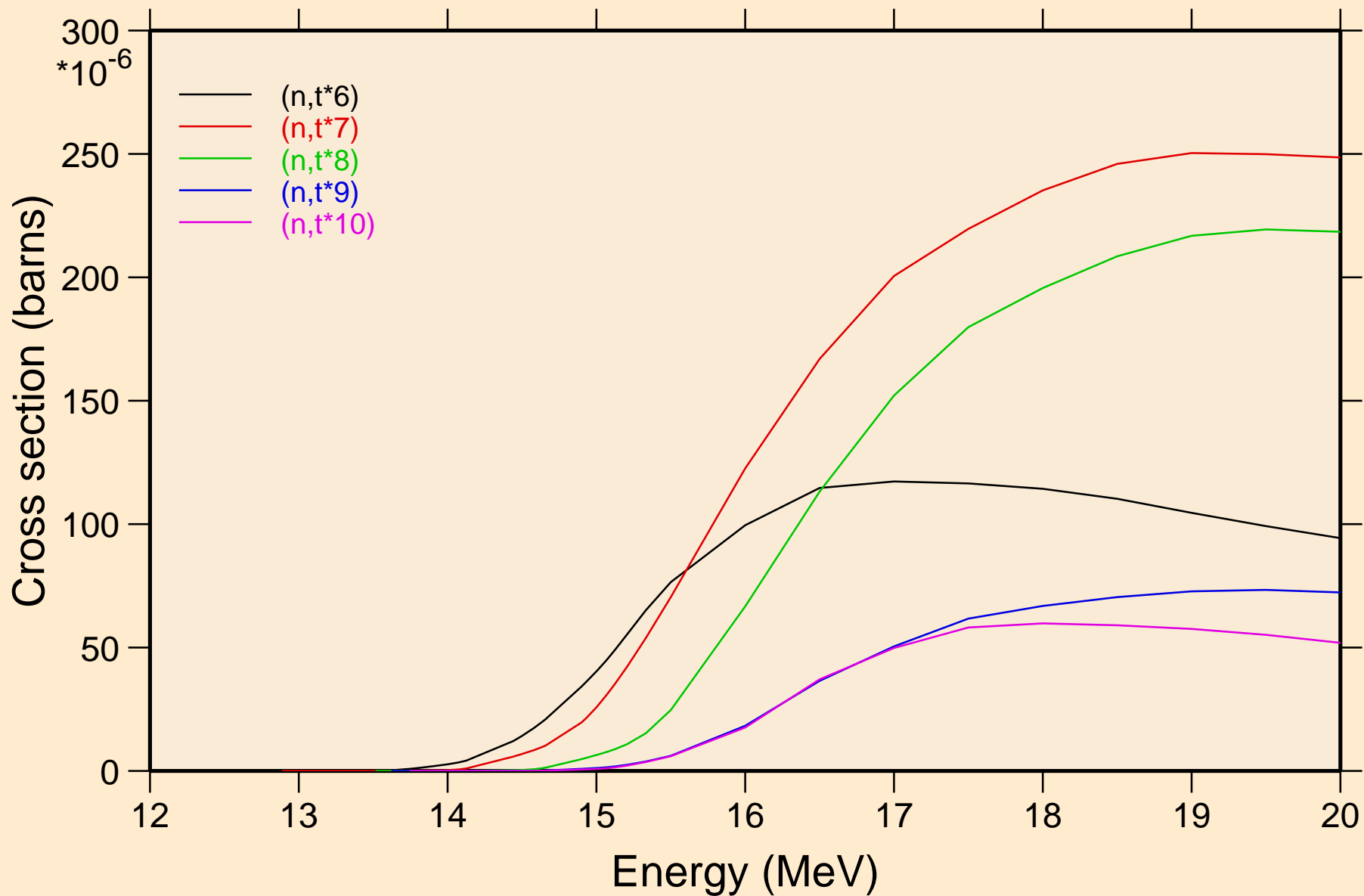

MAT=1725 ACE FILE PRODUCED AT NEA WITH NDEC
Threshold reactions

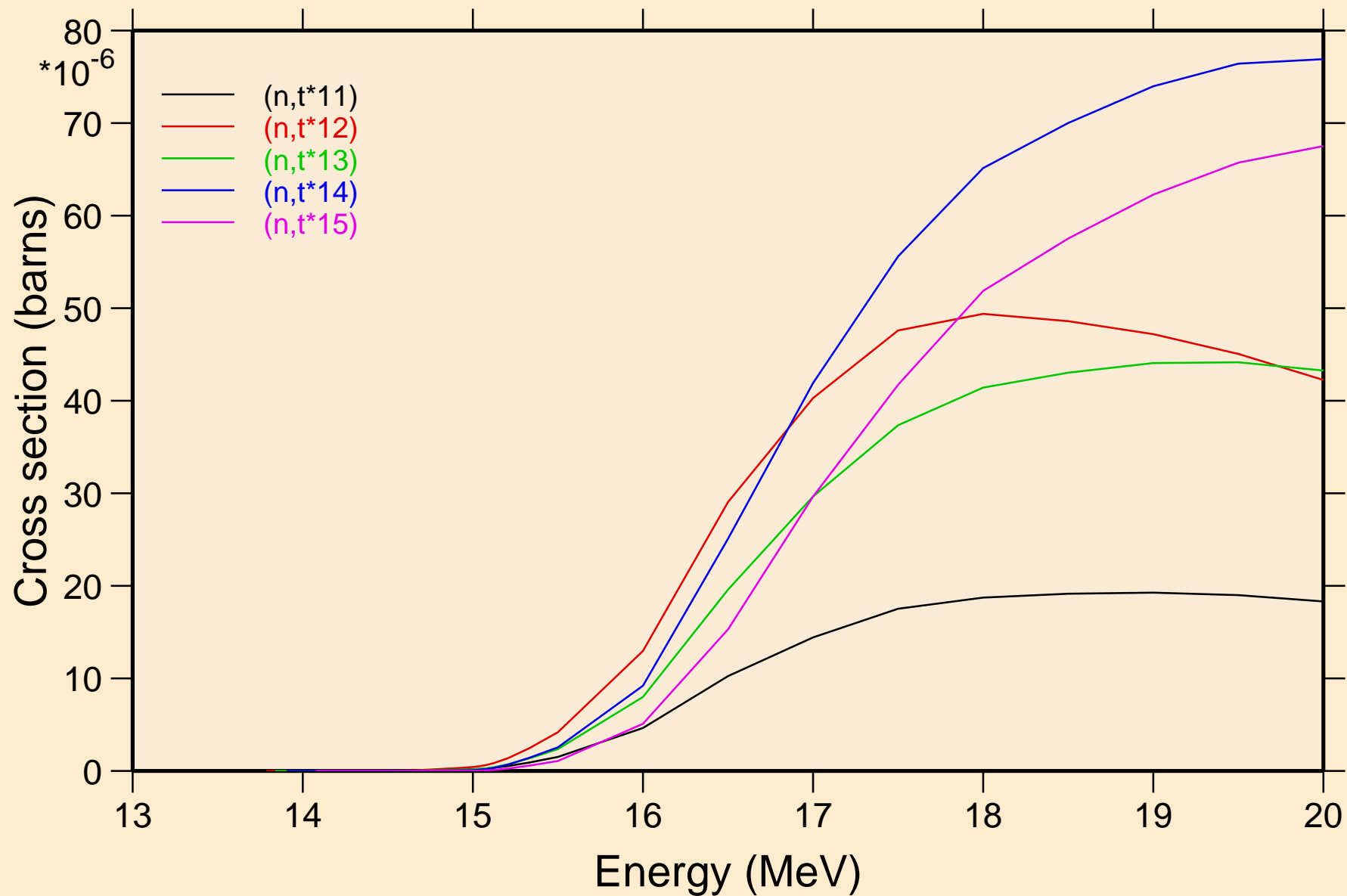

MAT=1725 ACE FILE PRODUCED AT NEA WITH NDEC
Threshold reactions

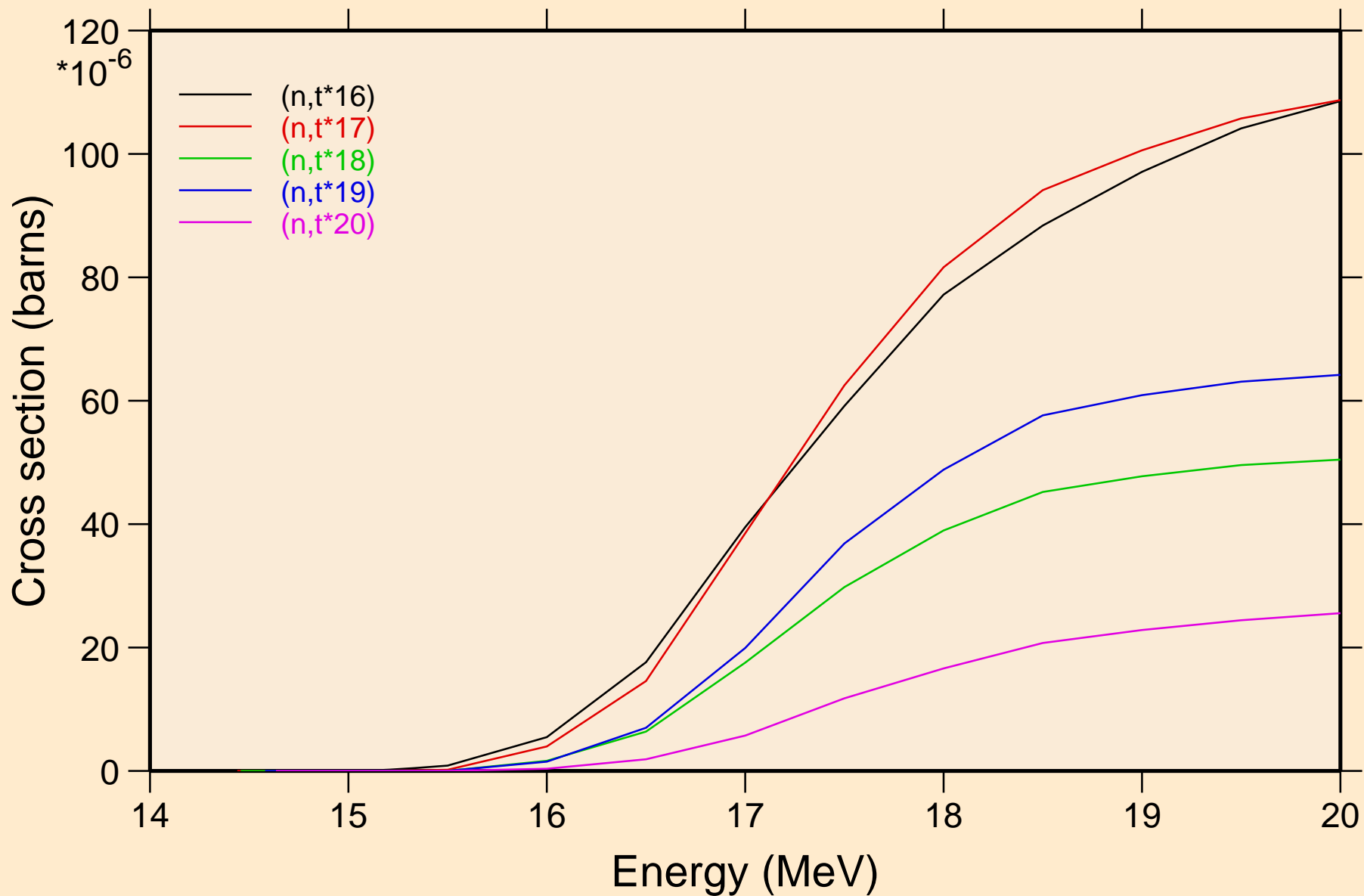

MAT=1725 ACE FILE PRODUCED AT NEA WITH NDEC
Threshold reactions

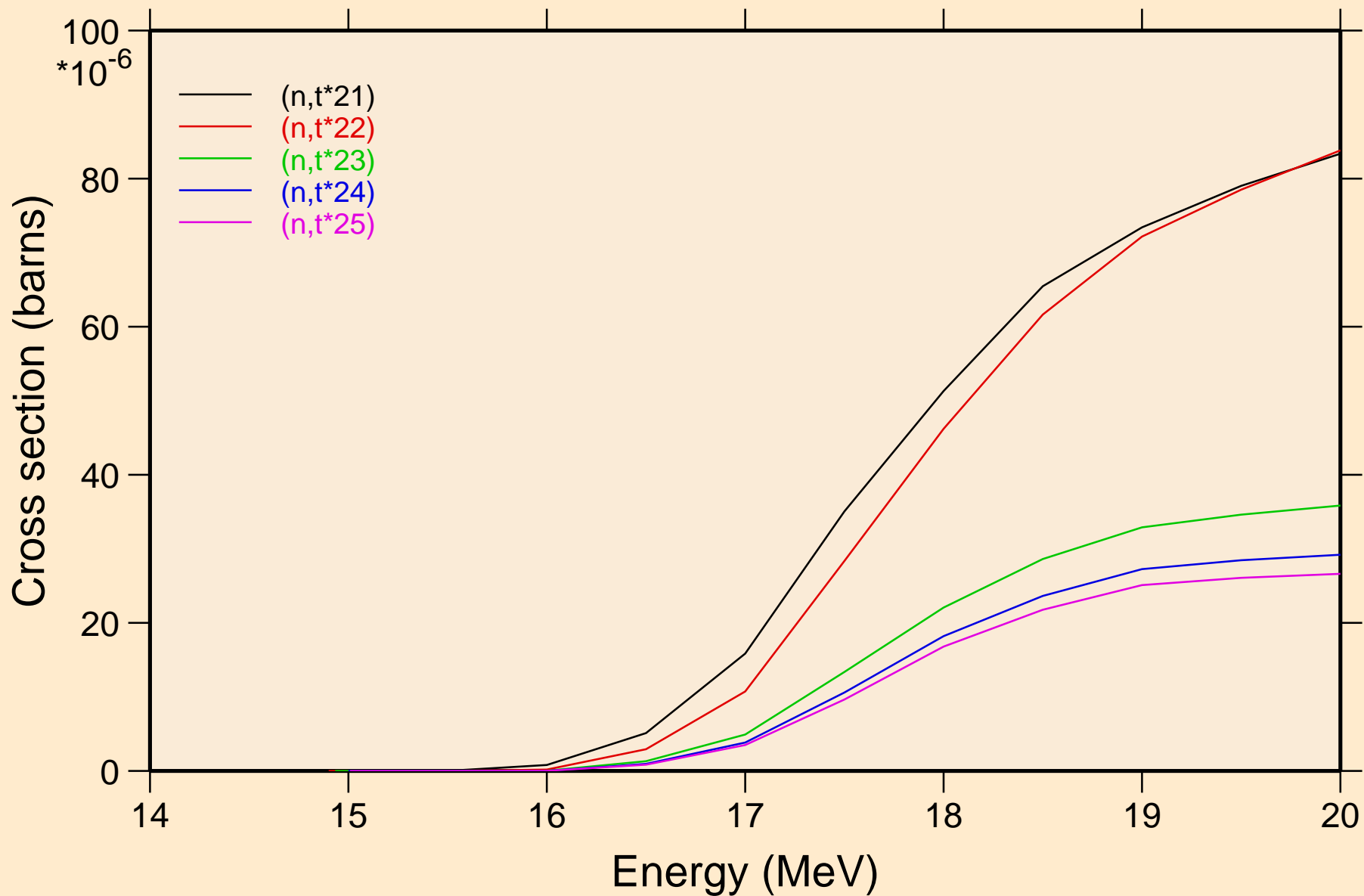

MAT=1725 ACE FILE PRODUCED AT NEA WITH NDEC
Threshold reactions

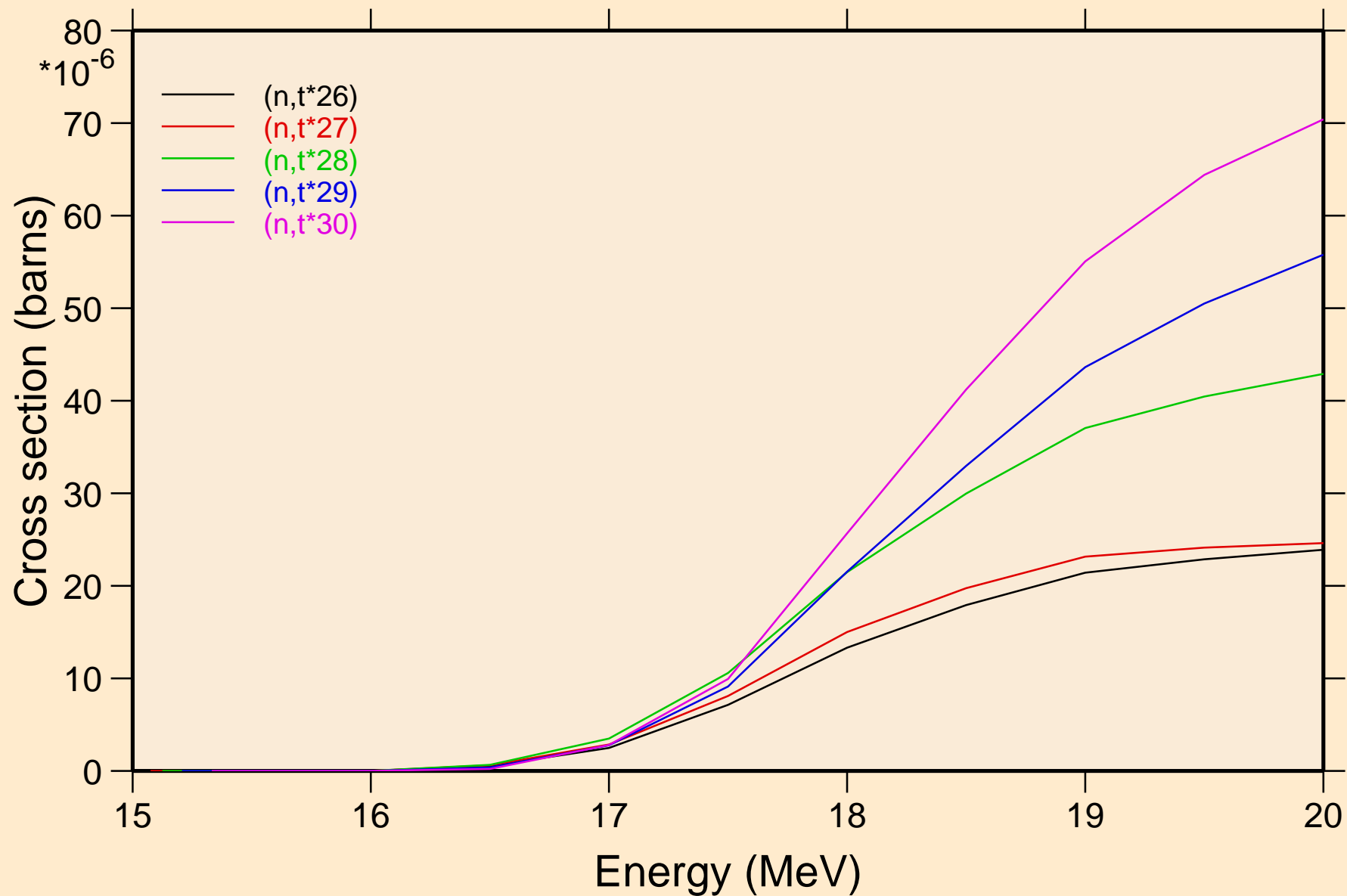

MAT=1725 ACE FILE PRODUCED AT NEA WITH NDEC
Threshold reactions

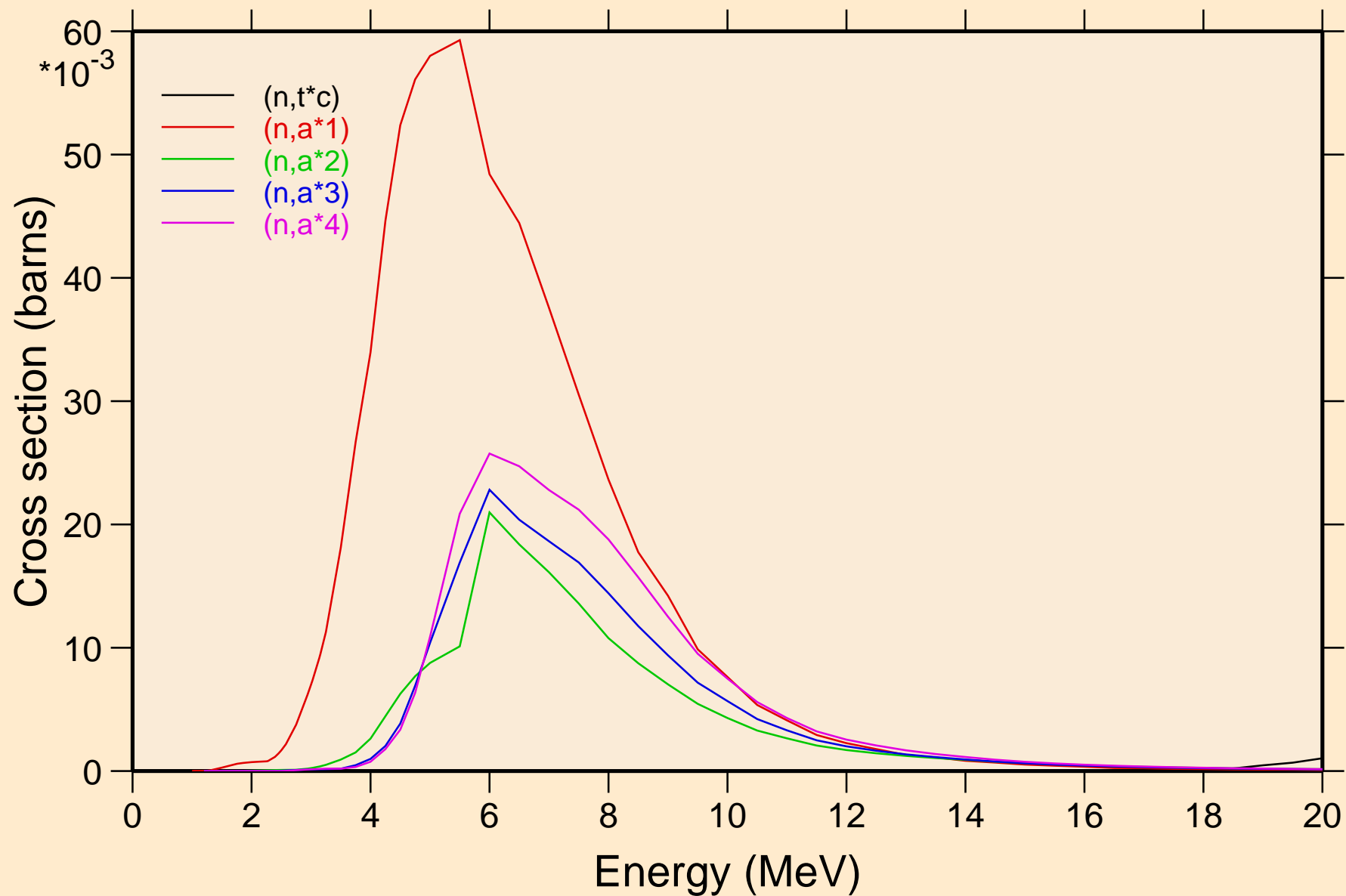

MAT=1725 ACE FILE PRODUCED AT NEA WITH NDEC
Threshold reactions

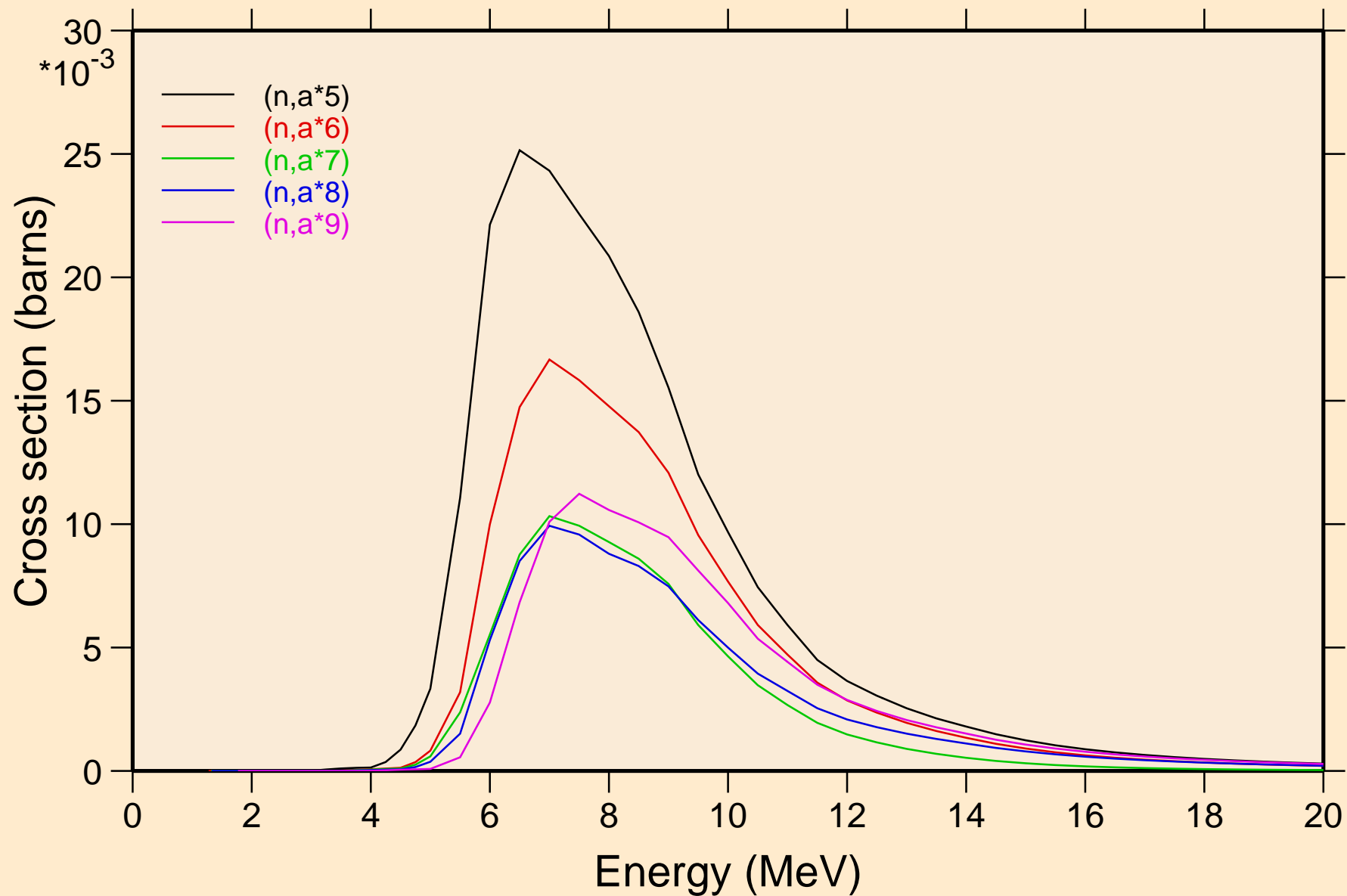

MAT=1725 ACE FILE PRODUCED AT NEA WITH NDEC
Threshold reactions

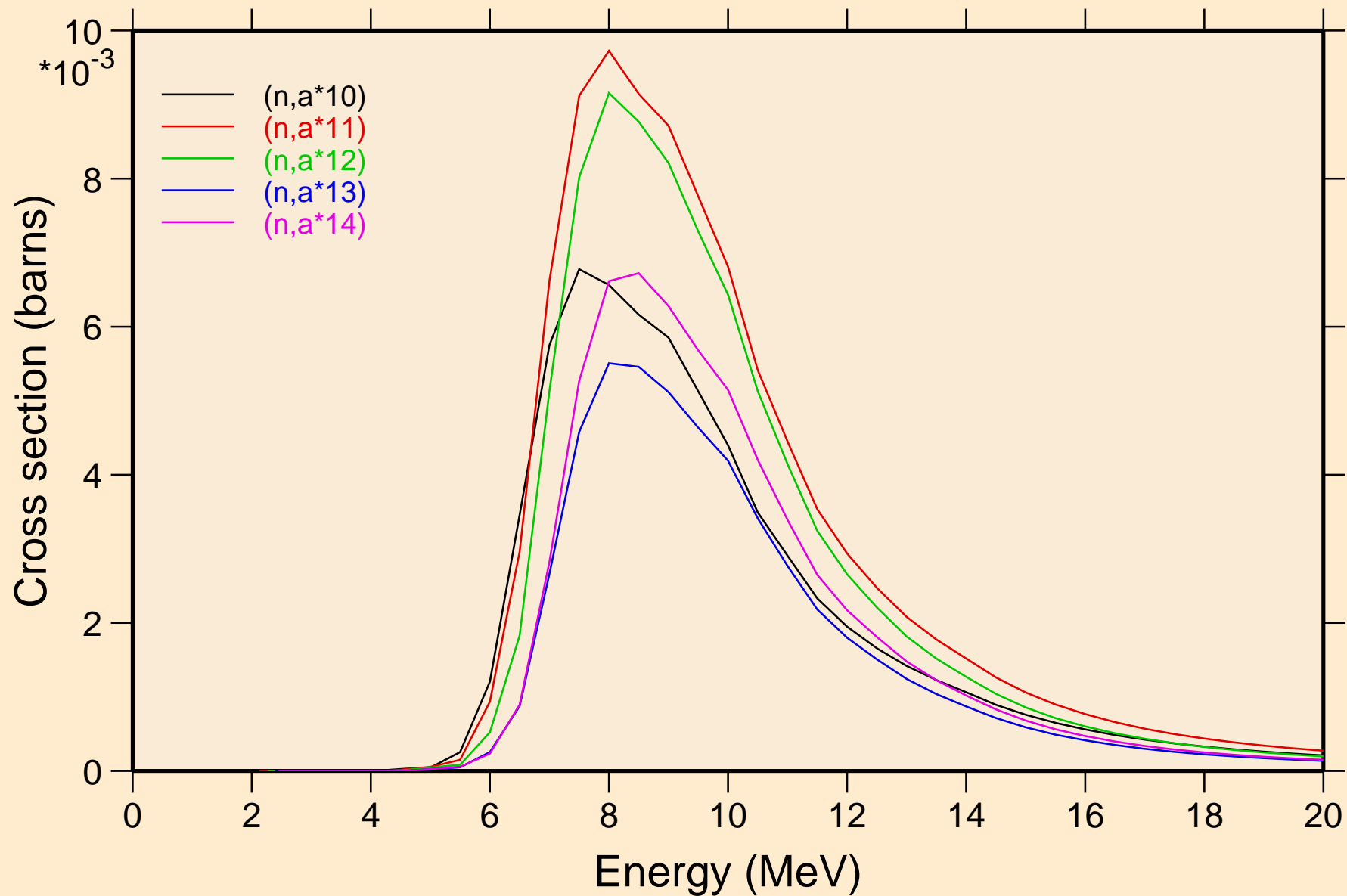

MAT=1725 ACE FILE PRODUCED AT NEA WITH NDEC
Threshold reactions

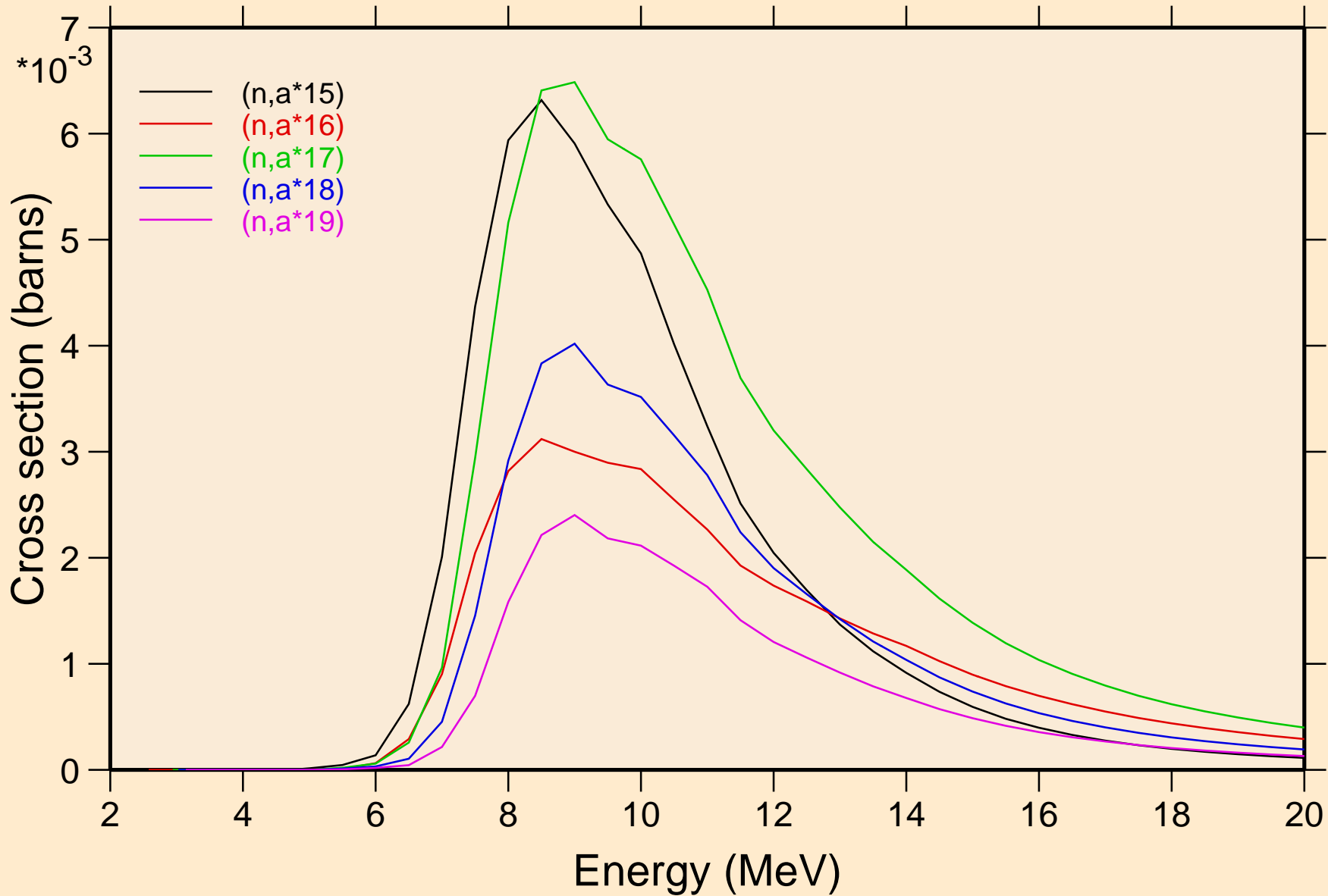

MAT=1725 ACE FILE PRODUCED AT NEA WITH NDEC
Threshold reactions

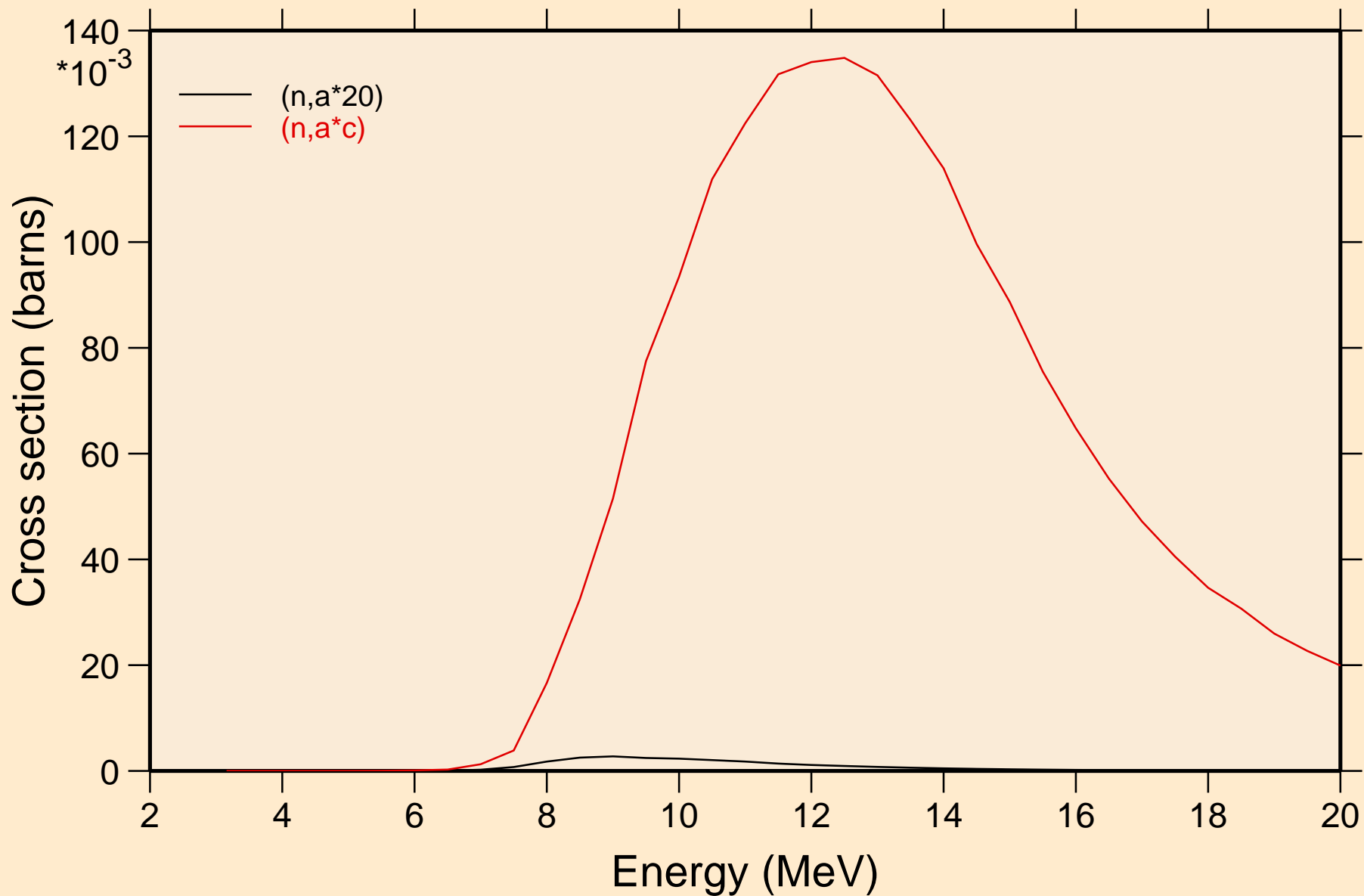

MAT=1725 ACE FILE PRODUCED AT NEA WITH NDEC
angular distribution for elastic

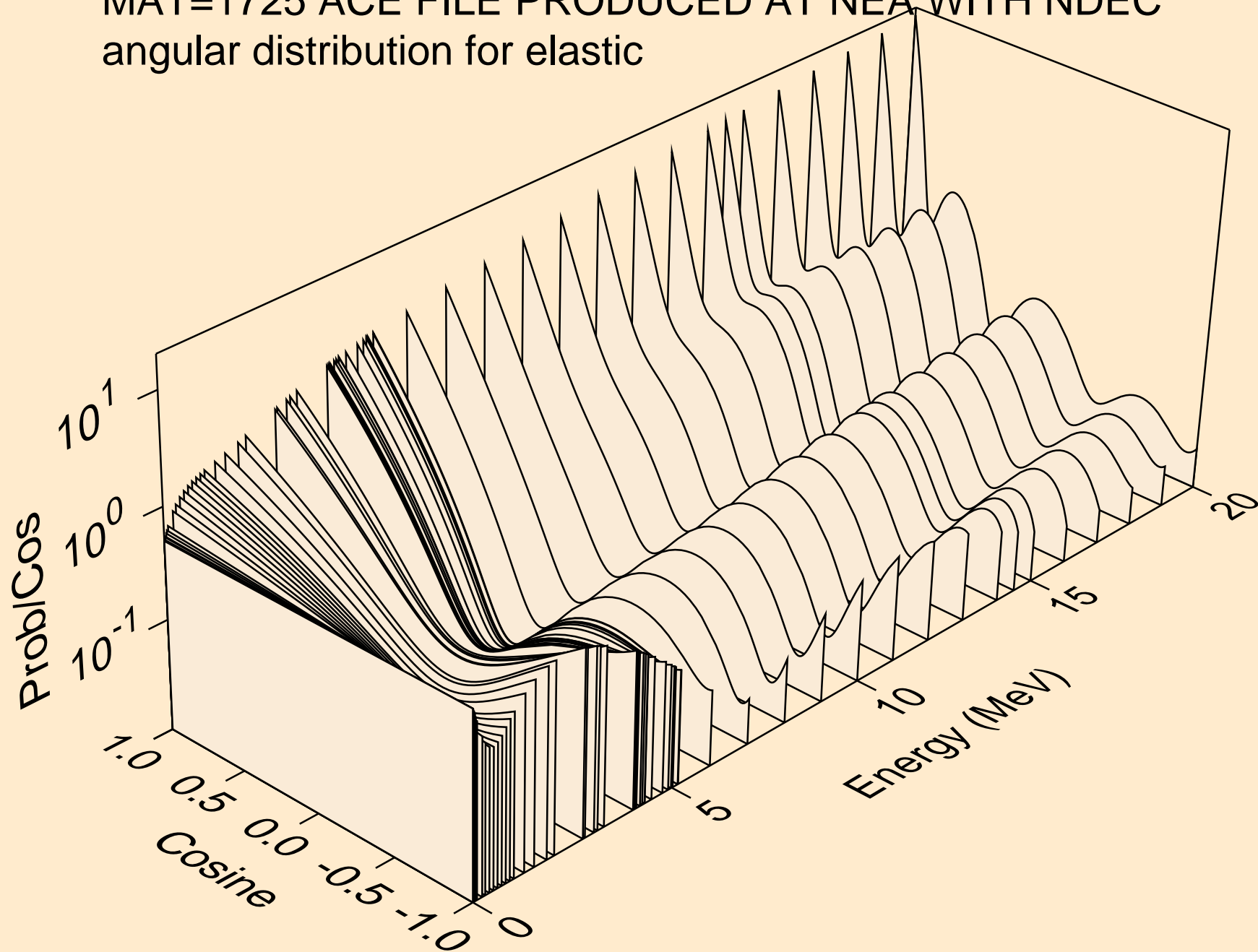

MAT=1725 ACE FILE PRODUCED AT NEA WITH NDEC
angular distribution for (n,n*1)

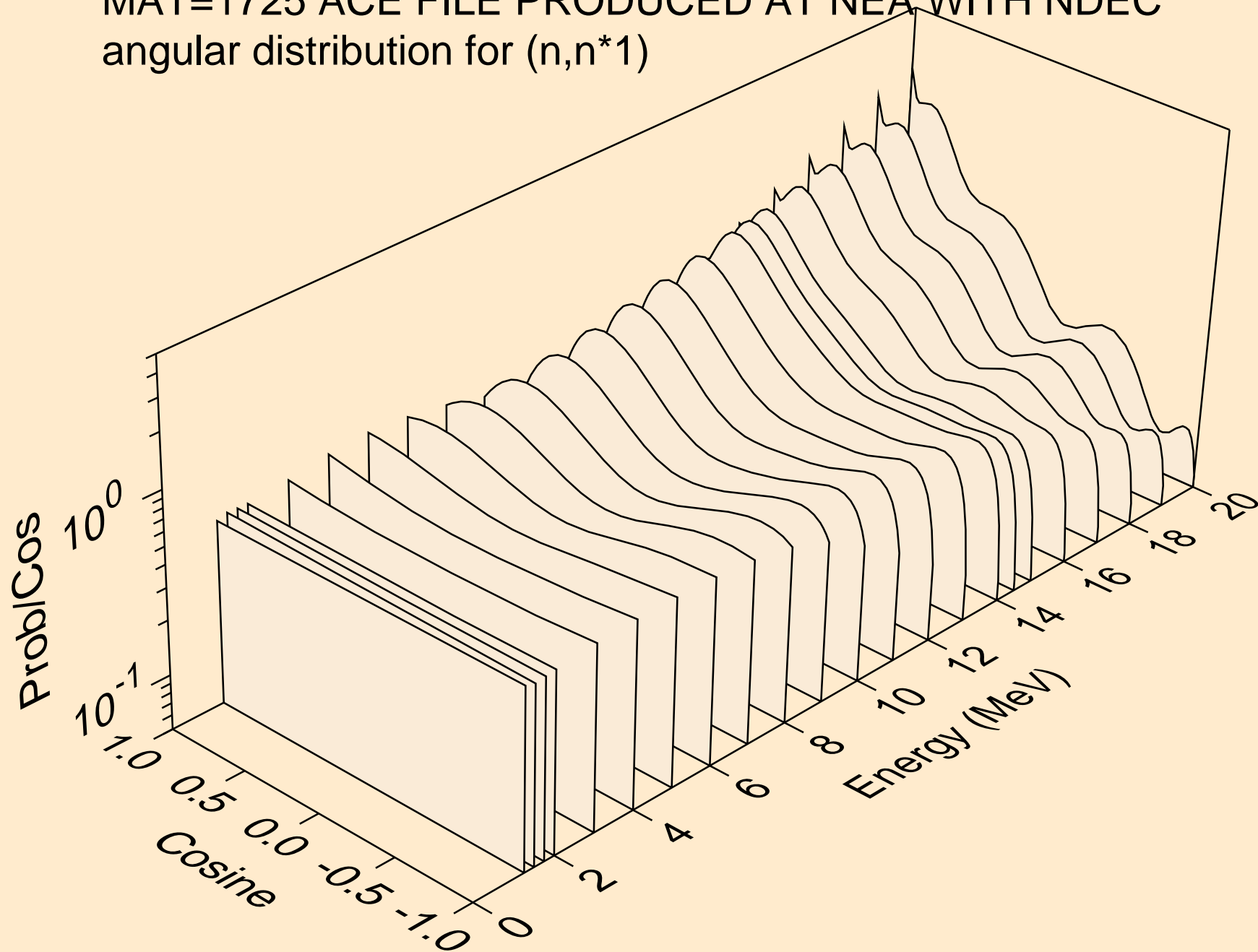

MAT=1725 ACE FILE PRODUCED AT NEA WITH NDEC
angular distribution for (n,n*2)

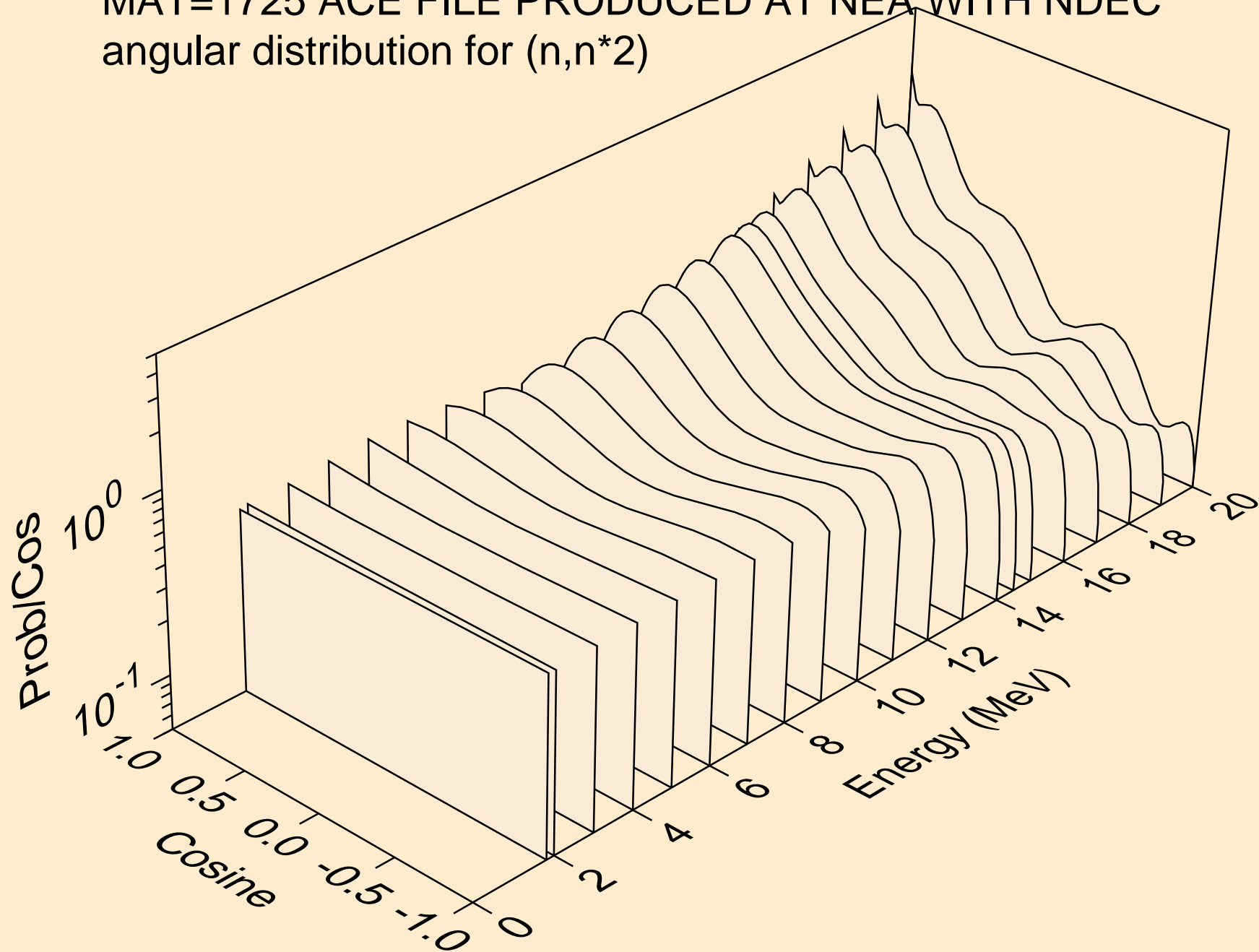

MAT=1725 ACE FILE PRODUCED AT NEA WITH NDEC
angular distribution for (n,n*3)

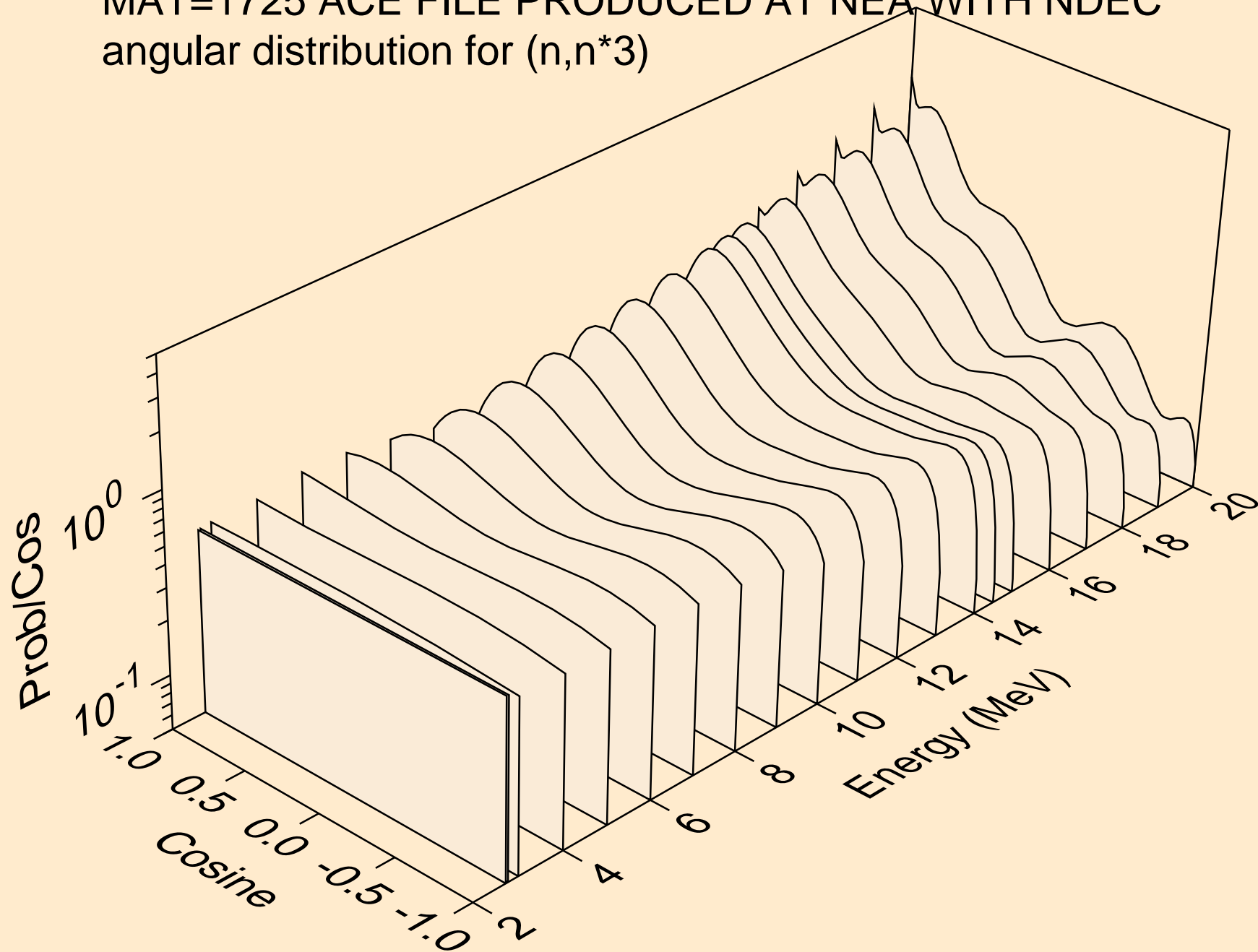

MAT=1725 ACE FILE PRODUCED AT NEA WITH NDEC
angular distribution for (n,n*4)

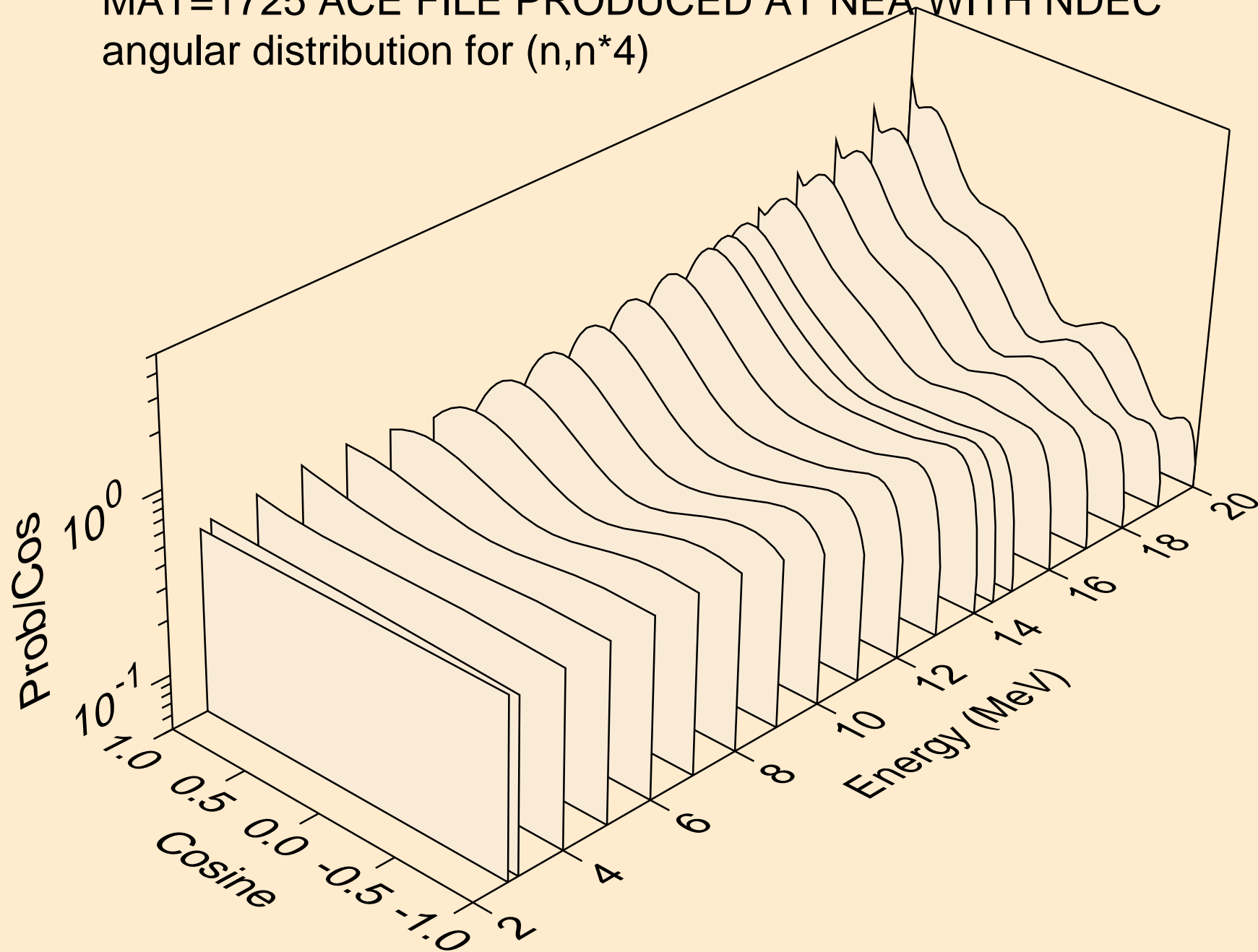

MAT=1725 ACE FILE PRODUCED AT NEA WITH NDEC
angular distribution for (n,n*5)

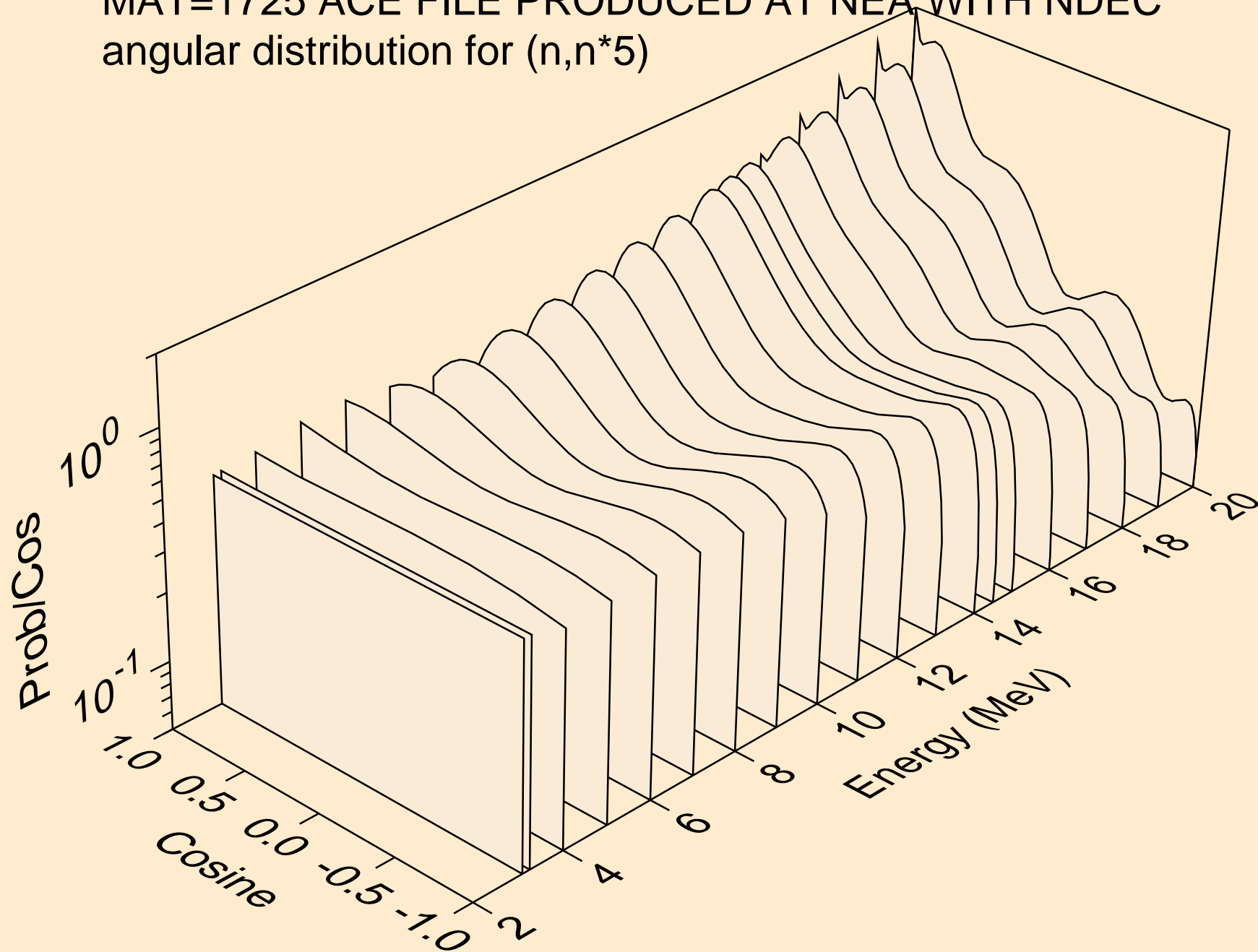

MAT=1725 ACE FILE PRODUCED AT NEA WITH NDEC
angular distribution for (n,n*6)

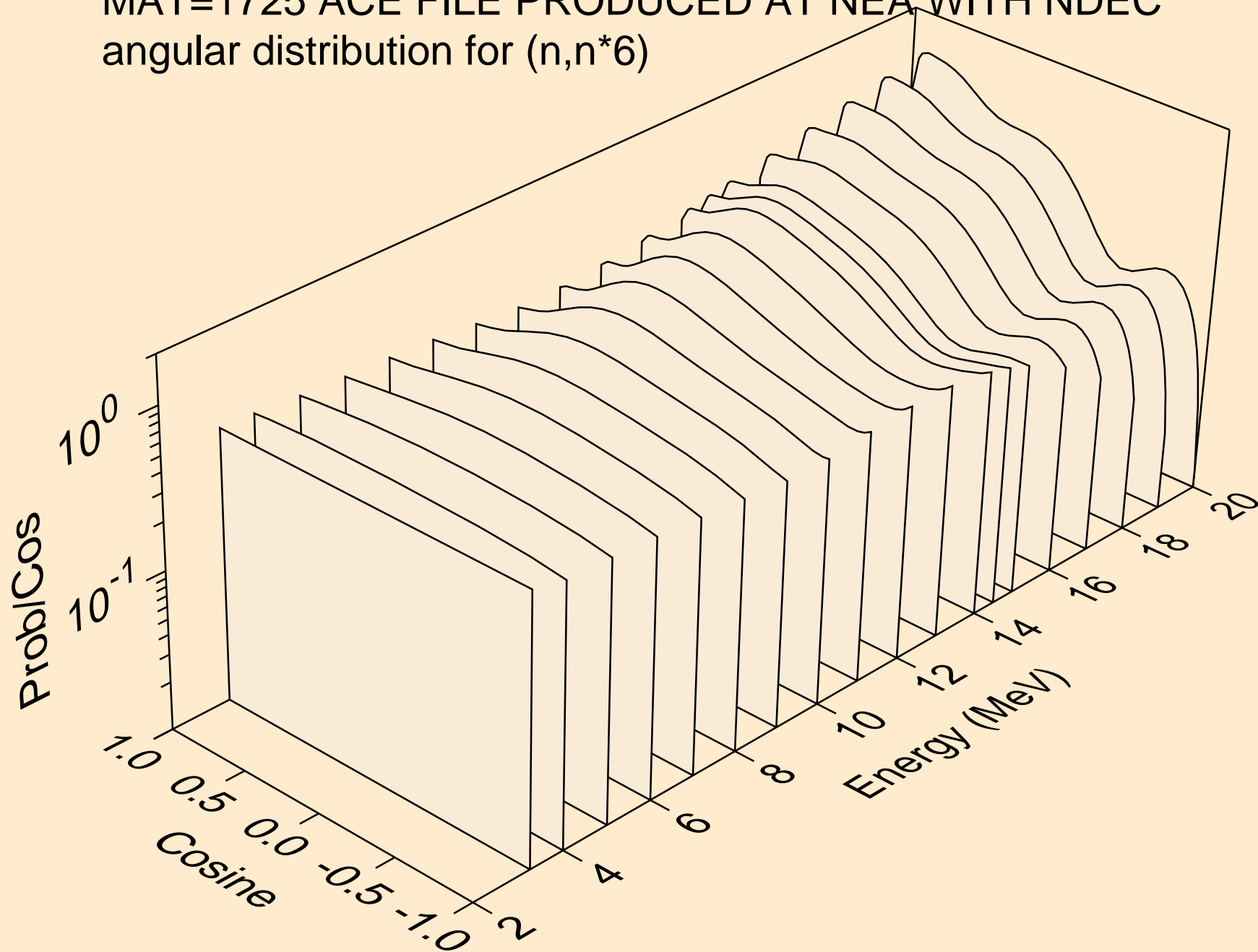

MAT=1725 ACE FILE PRODUCED AT NEA WITH NDEC
angular distribution for (n,n*7)

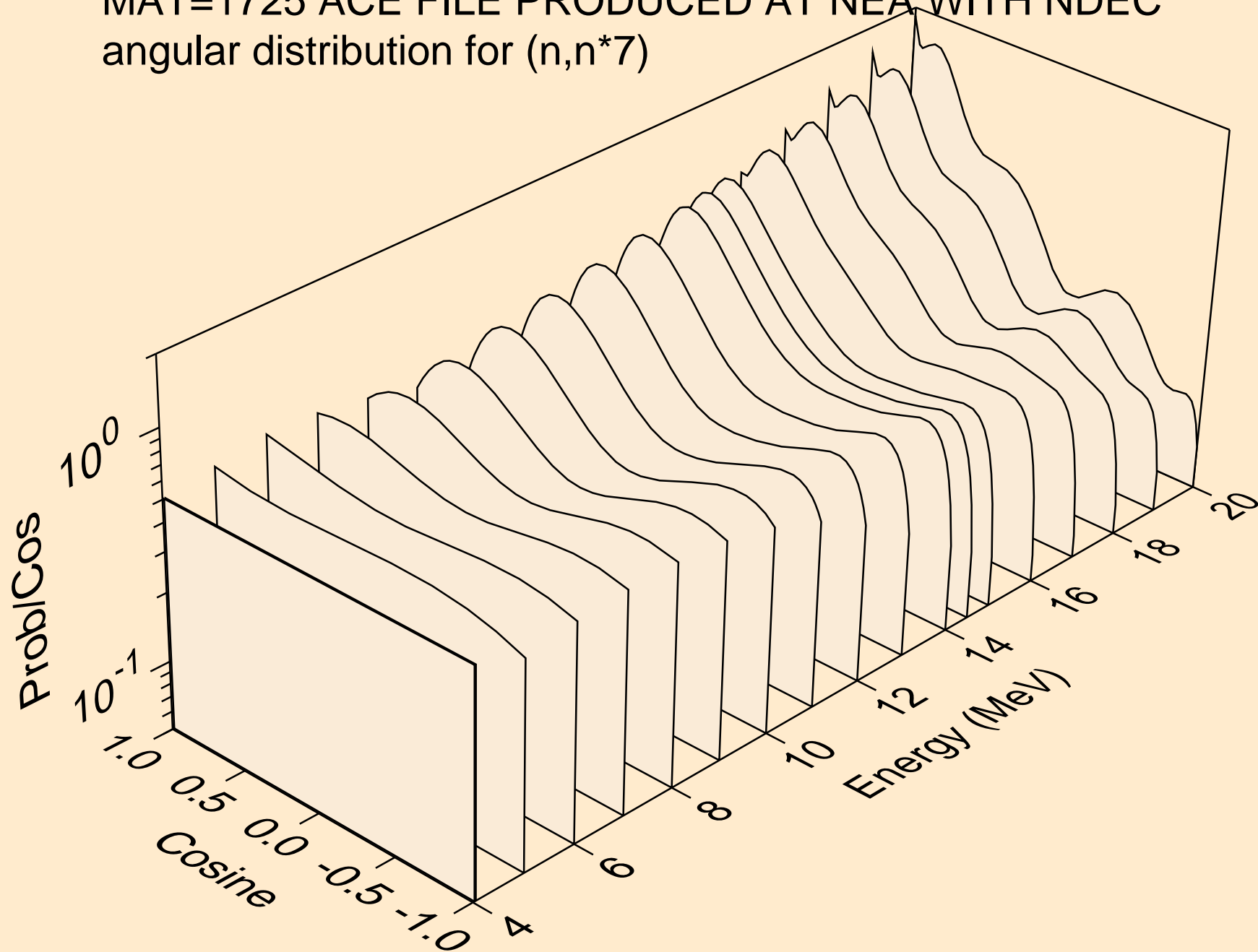

MAT=1725 ACE FILE PRODUCED AT NEA WITH NDEC
angular distribution for (n,n*8)

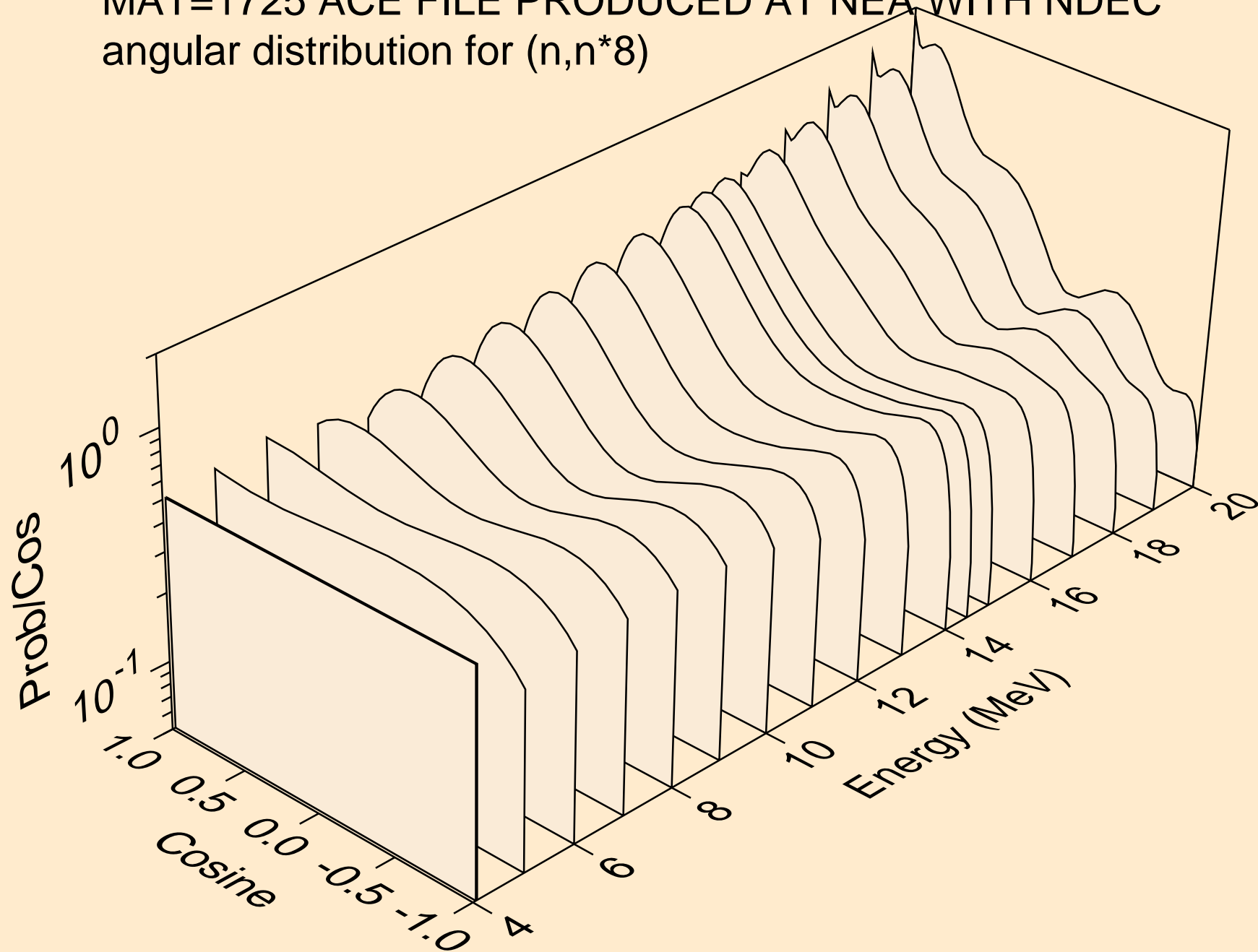

MAT=1725 ACE FILE PRODUCED AT NEA WITH NDEC
angular distribution for (n,n*9)

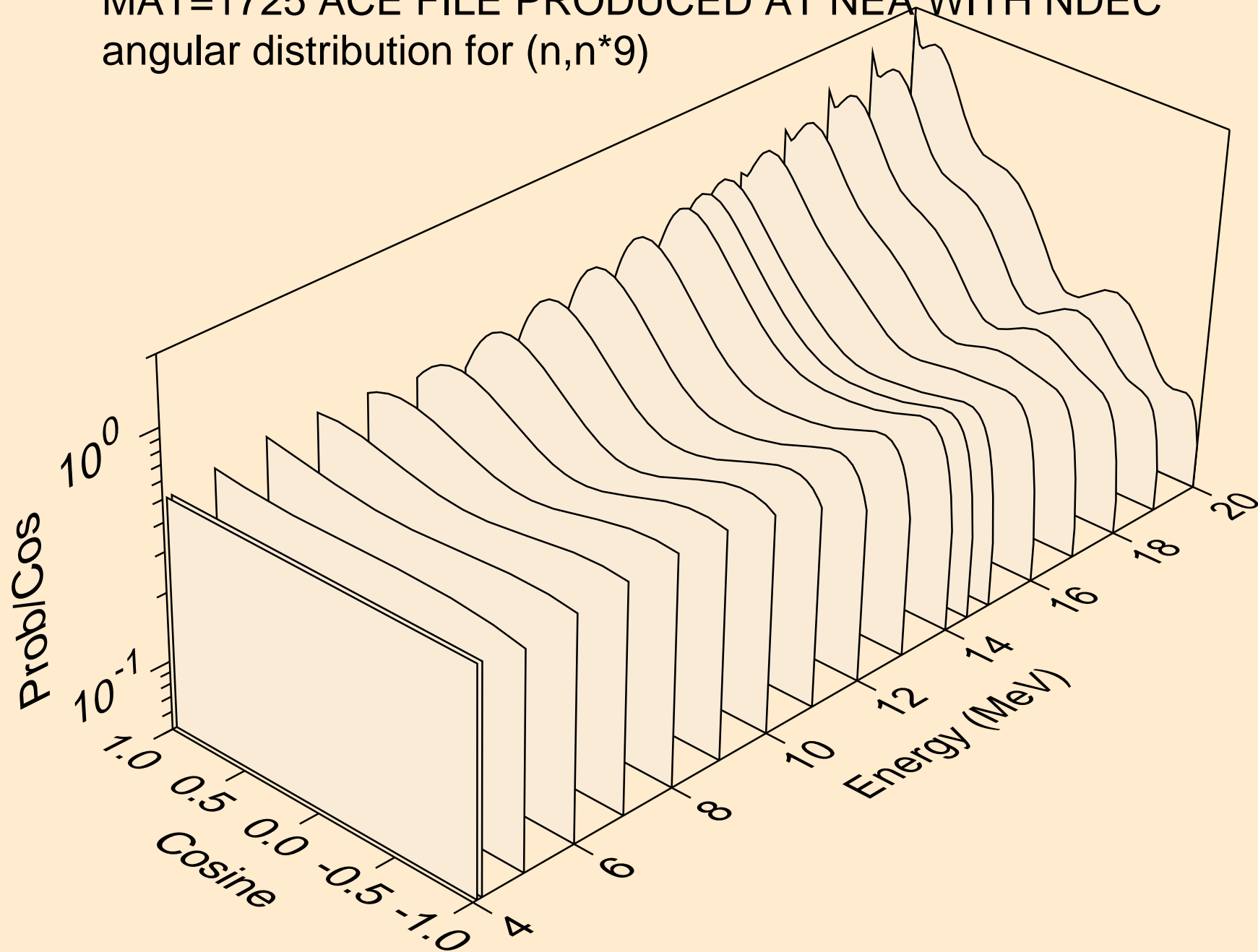

MAT=1725 ACE FILE PRODUCED AT NEA WITH NDEC
angular distribution for (n,n*10)

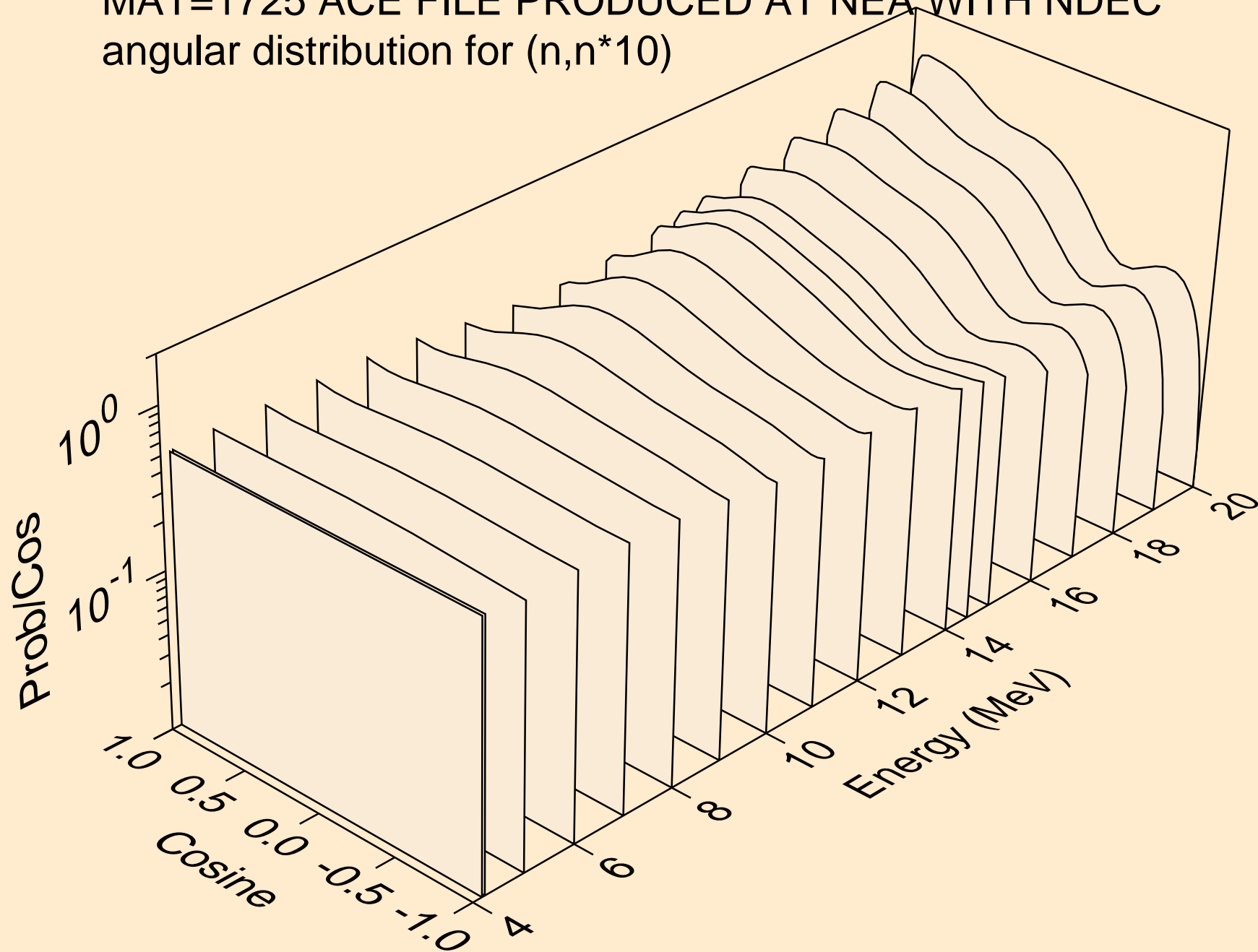

MAT=1725 ACE FILE PRODUCED AT NEA WITH NDEC
angular distribution for (n,n*11)

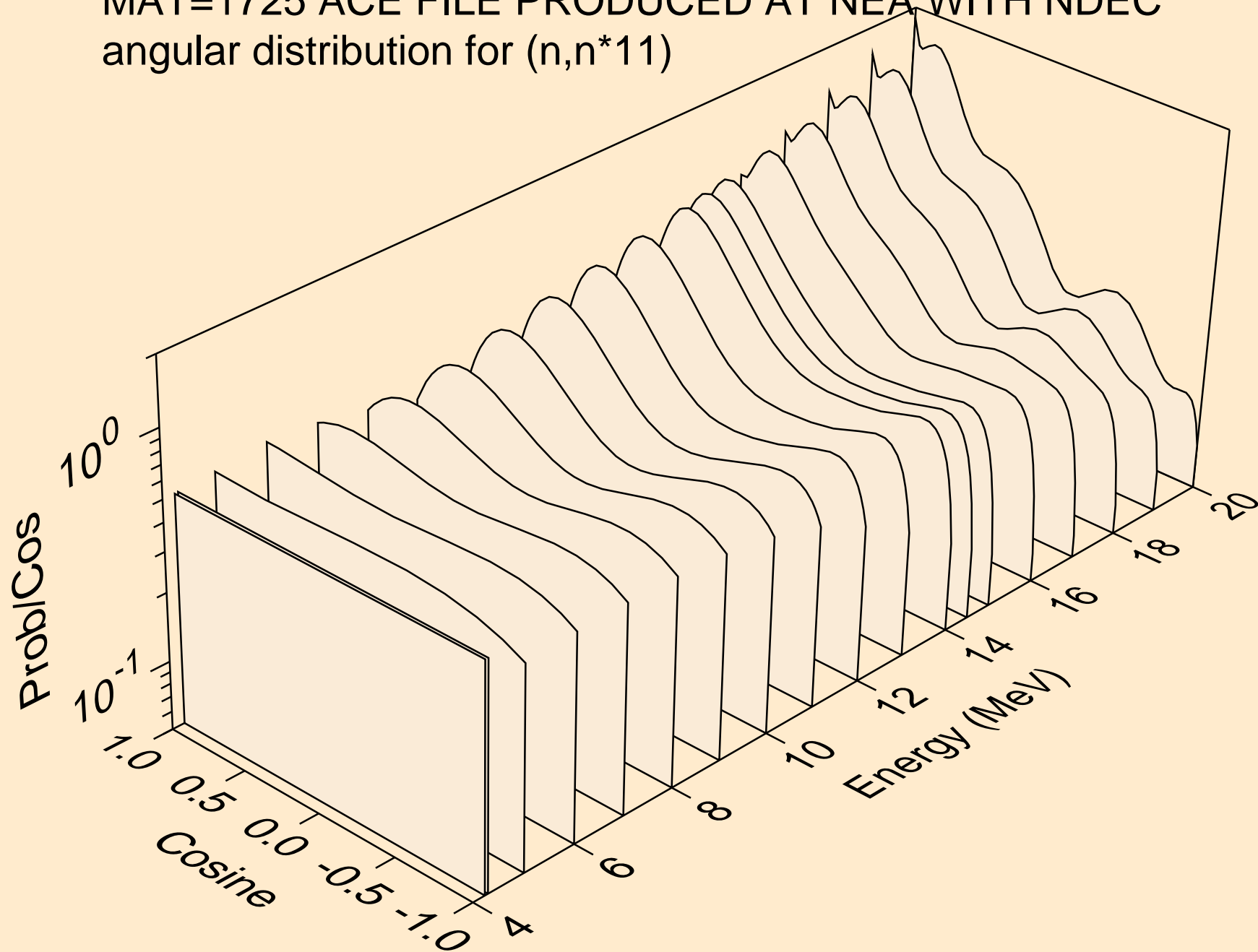

MAT=1725 ACE FILE PRODUCED AT NEA WITH NDEC
angular distribution for (n,n*12)

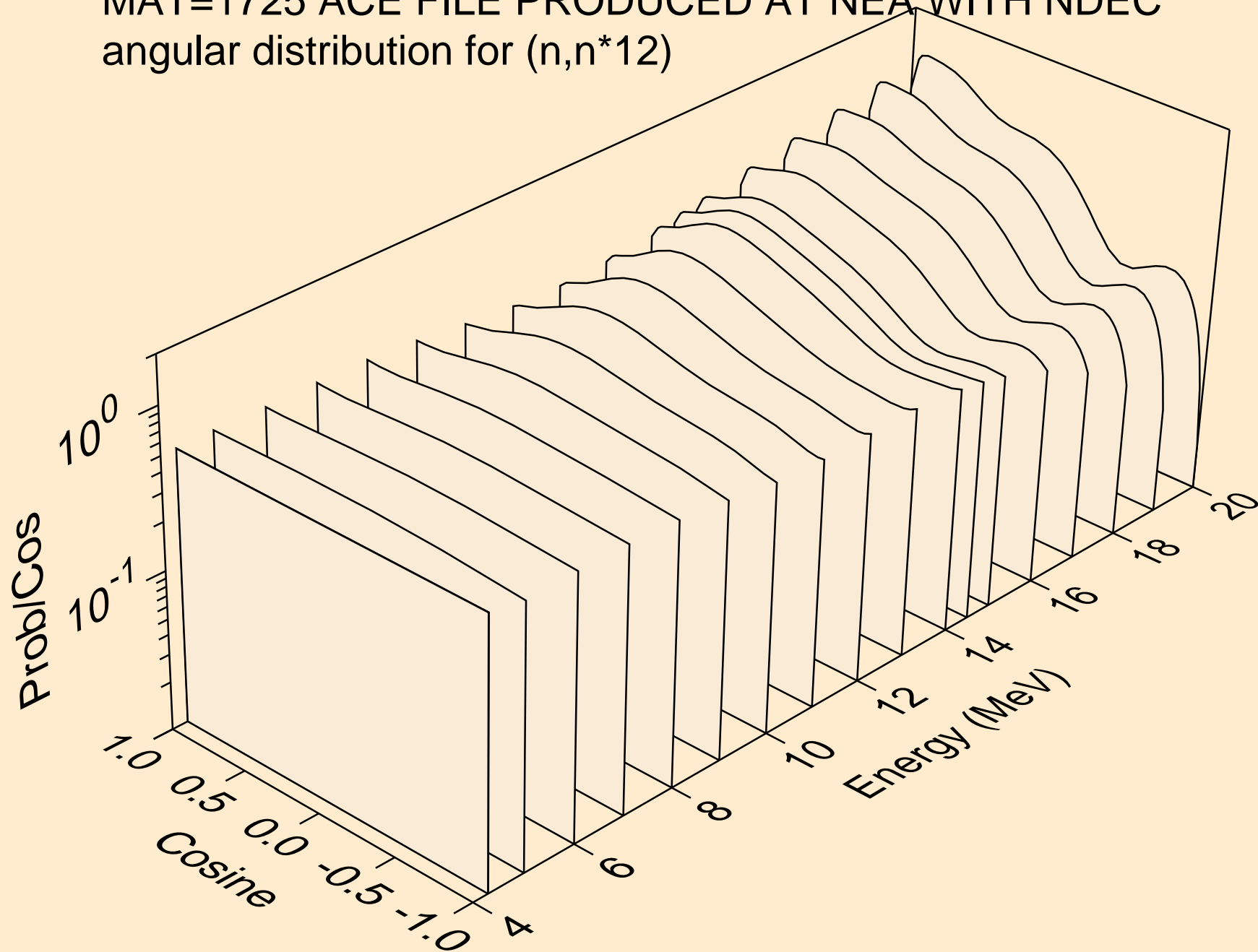

MAT=1725 ACE FILE PRODUCED AT NEA WITH NDEC
angular distribution for (n,n*13)

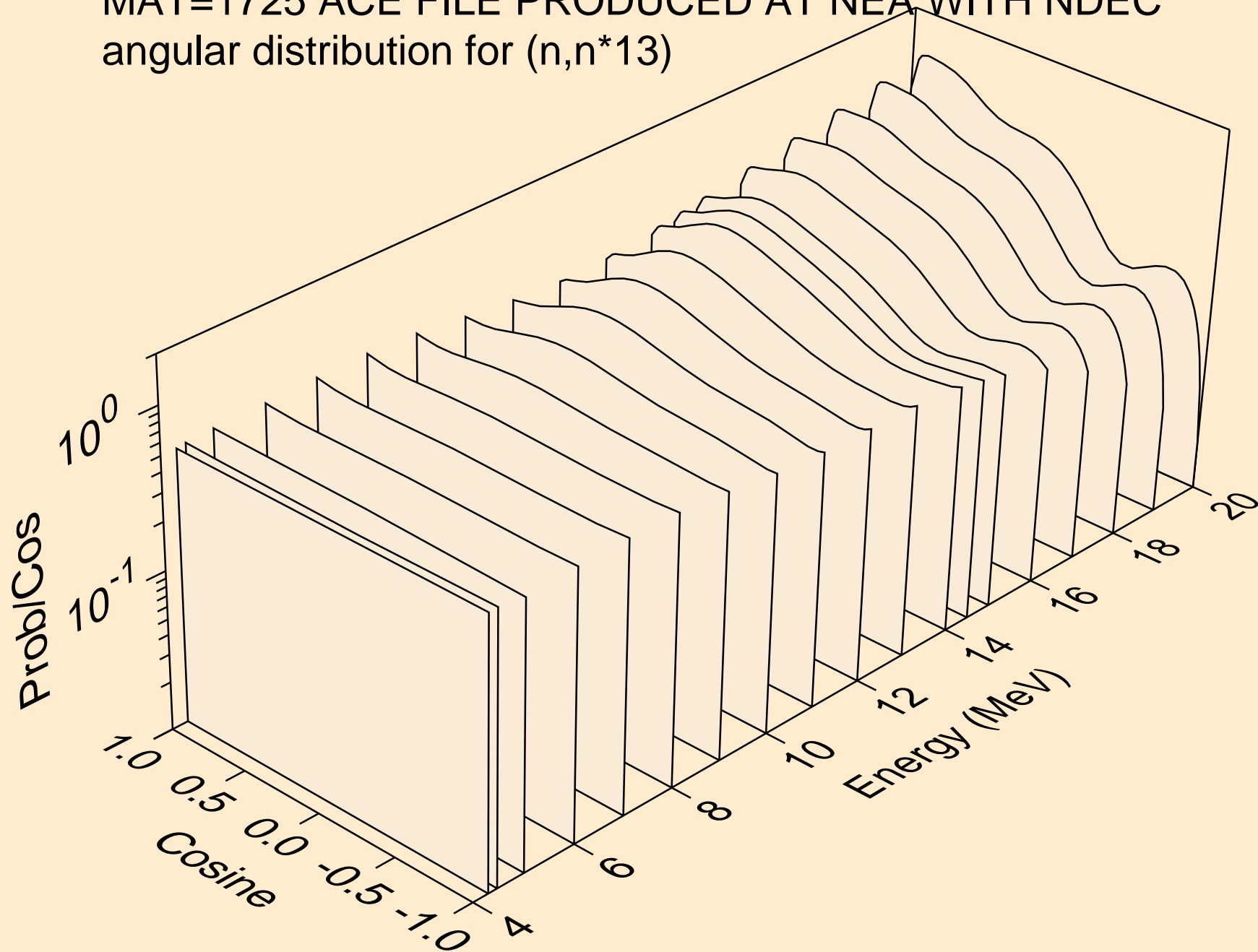

MAT=1725 ACE FILE PRODUCED AT NEA WITH NDEC
angular distribution for (n,n*14)

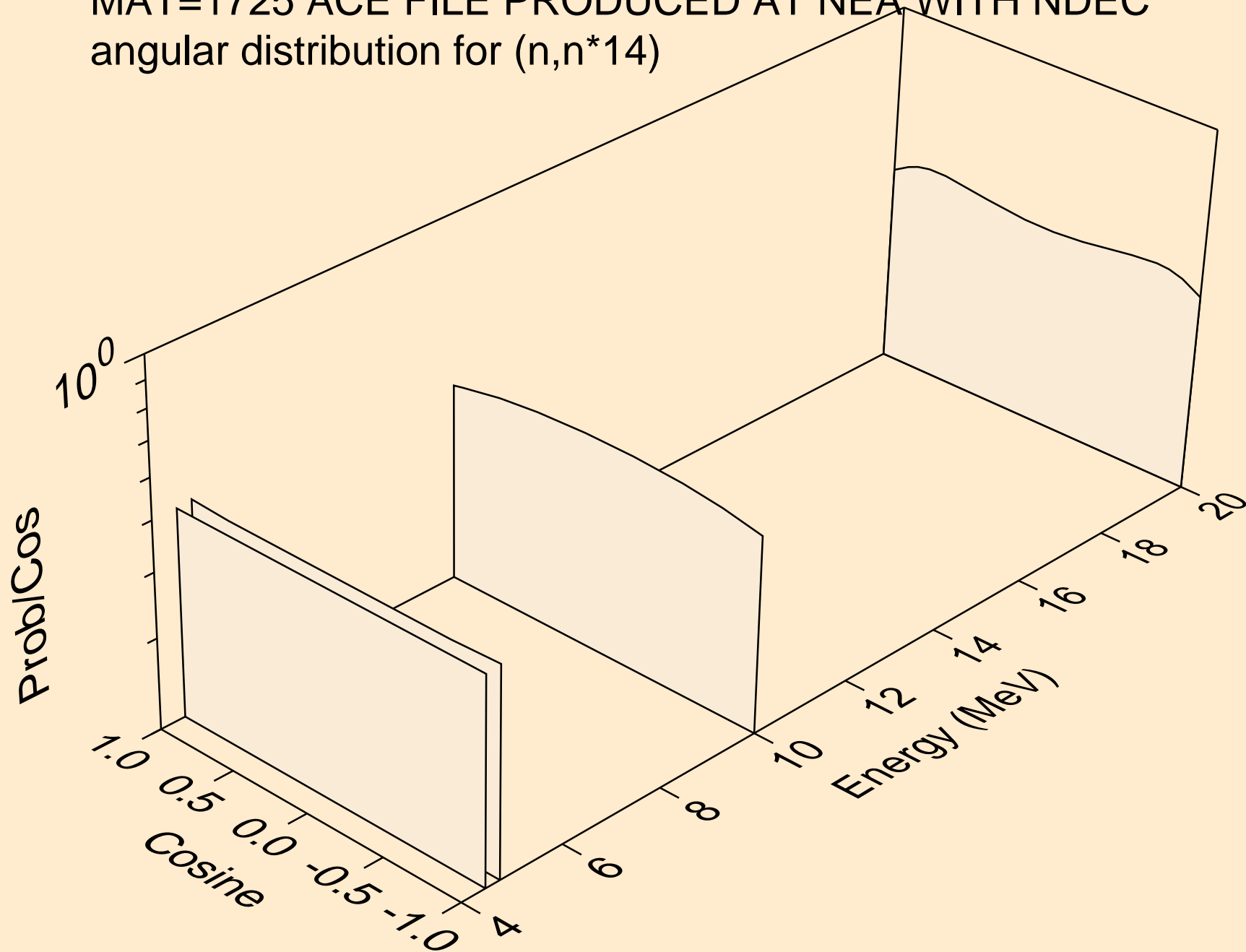

MAT=1725 ACE FILE PRODUCED AT NEA WITH NDEC
angular distribution for (n,n*15)

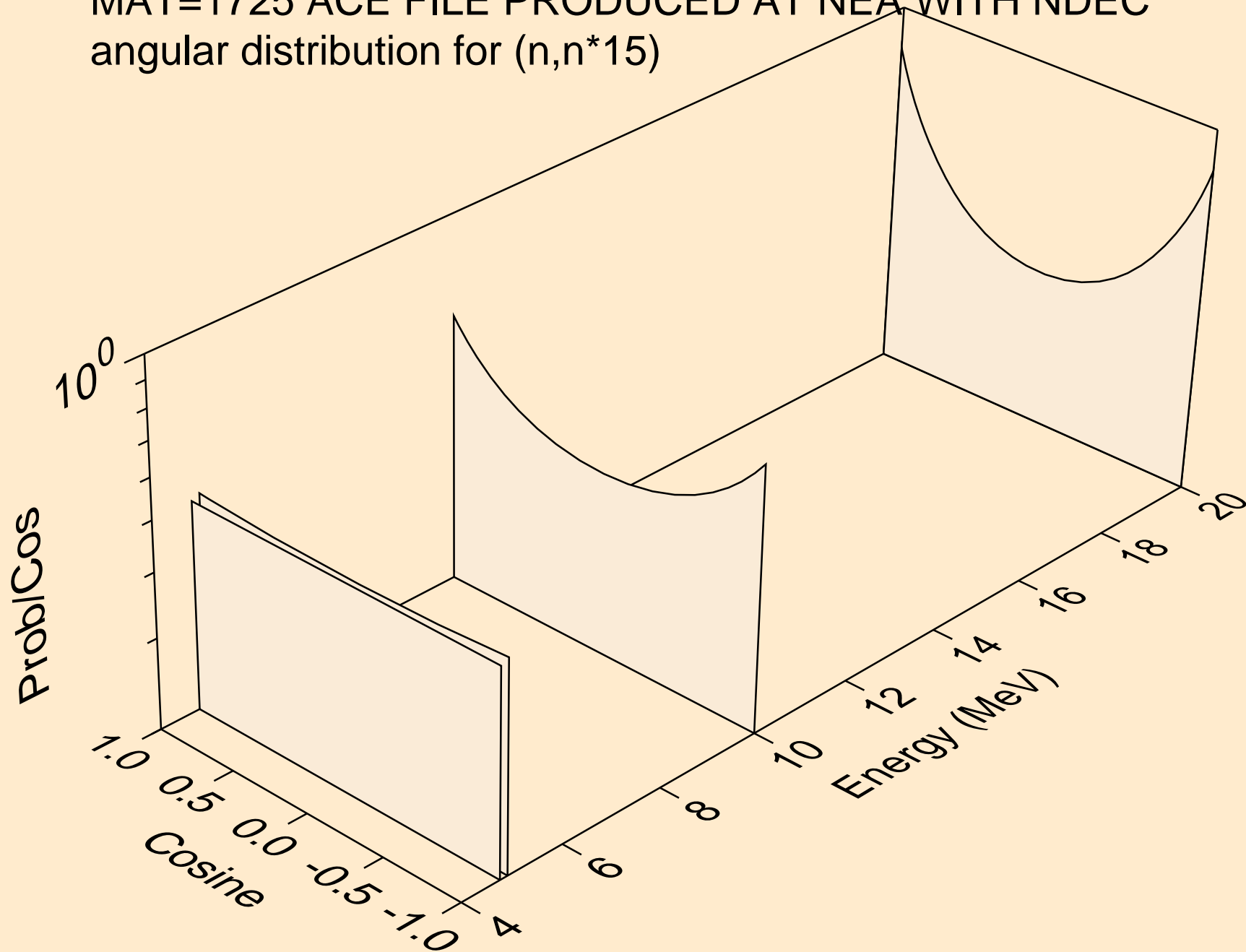

MAT=1725 ACE FILE PRODUCED AT NEA WITH NDEC
angular distribution for (n,n*16)

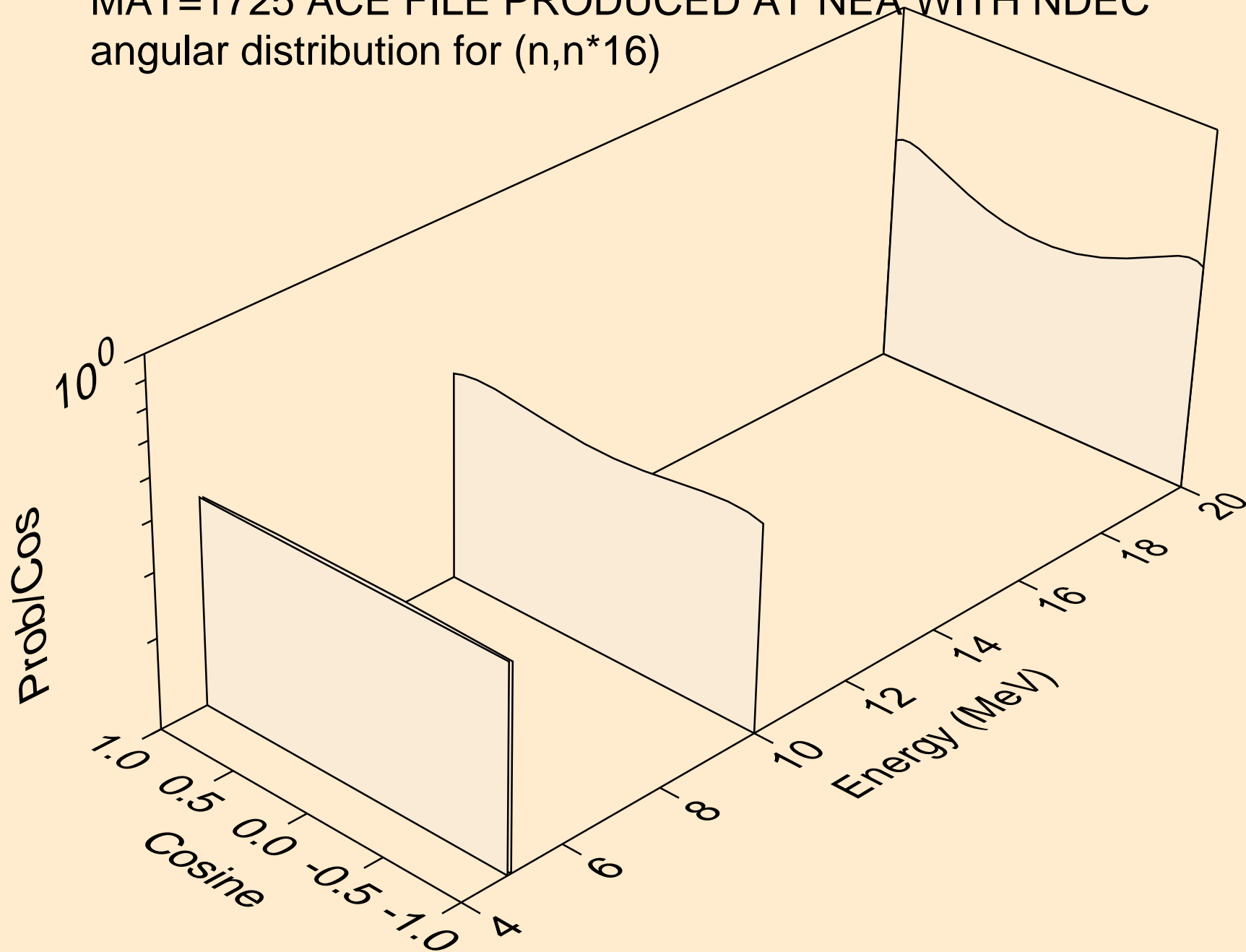

MAT=1725 ACE FILE PRODUCED AT NEA WITH NDEC
angular distribution for (n,n*17)

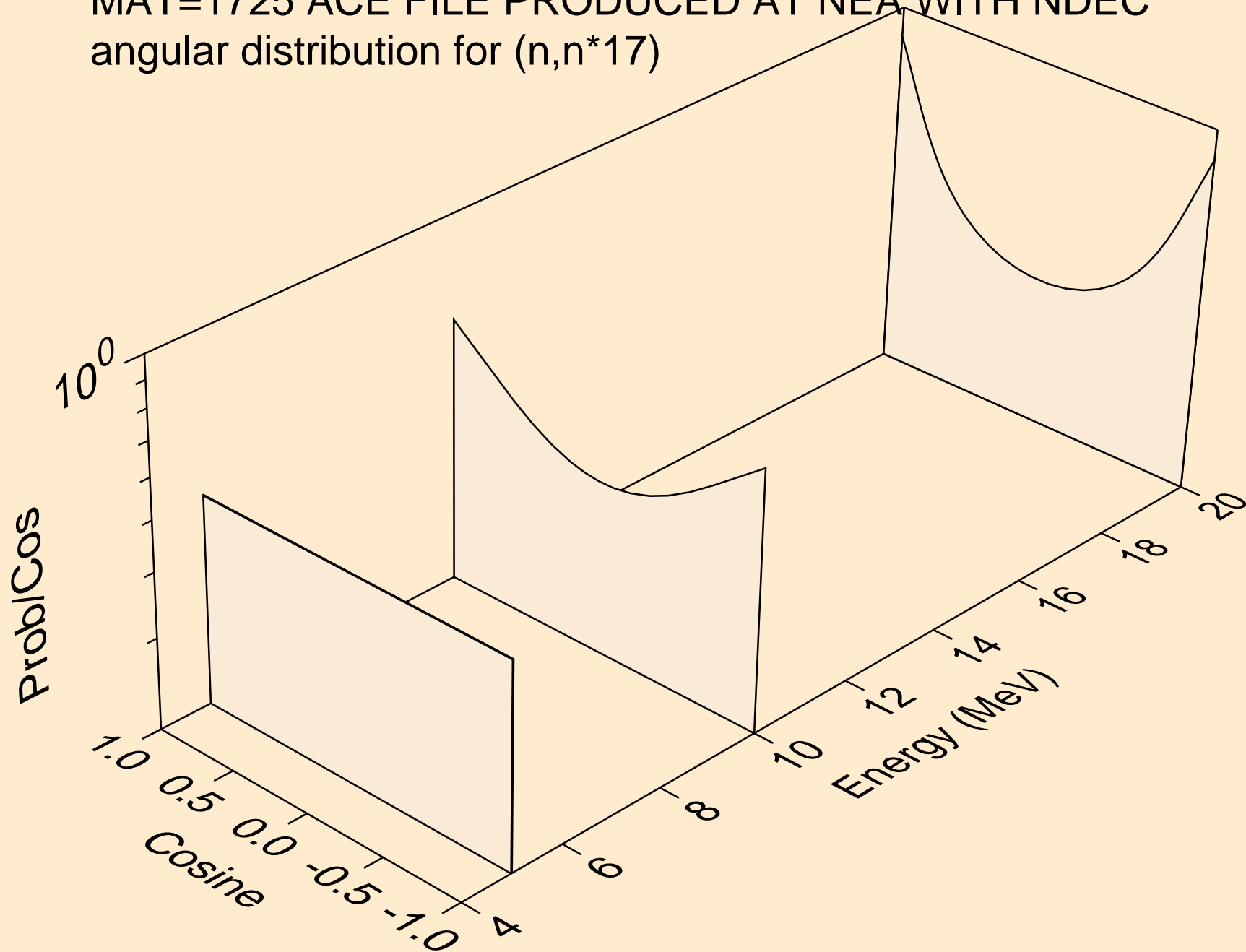

MAT=1725 ACE FILE PRODUCED AT NEA WITH NDEC
angular distribution for (n,n*18)

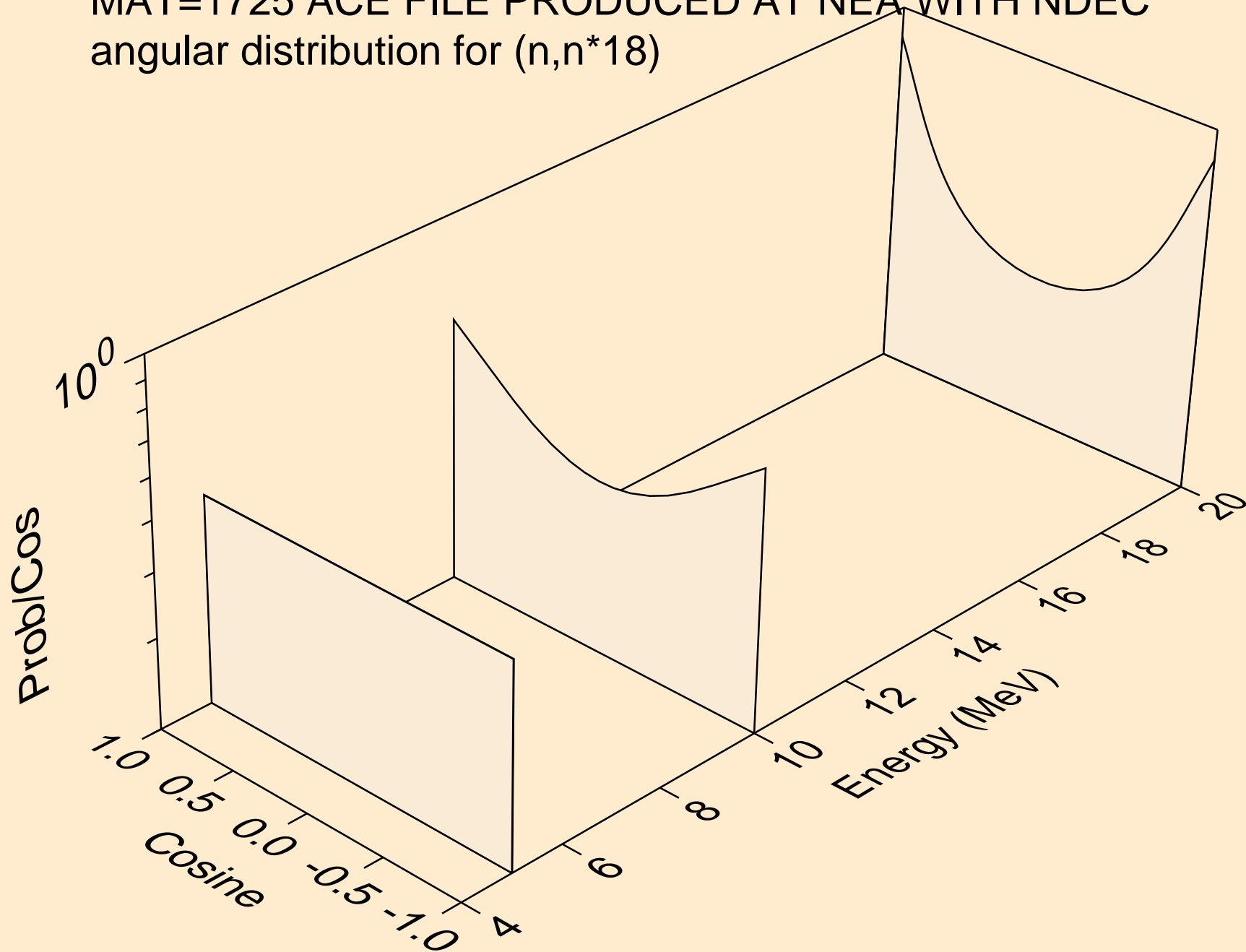

MAT=1725 ACE FILE PRODUCED AT NEA WITH NDEC
angular distribution for (n,n*19)

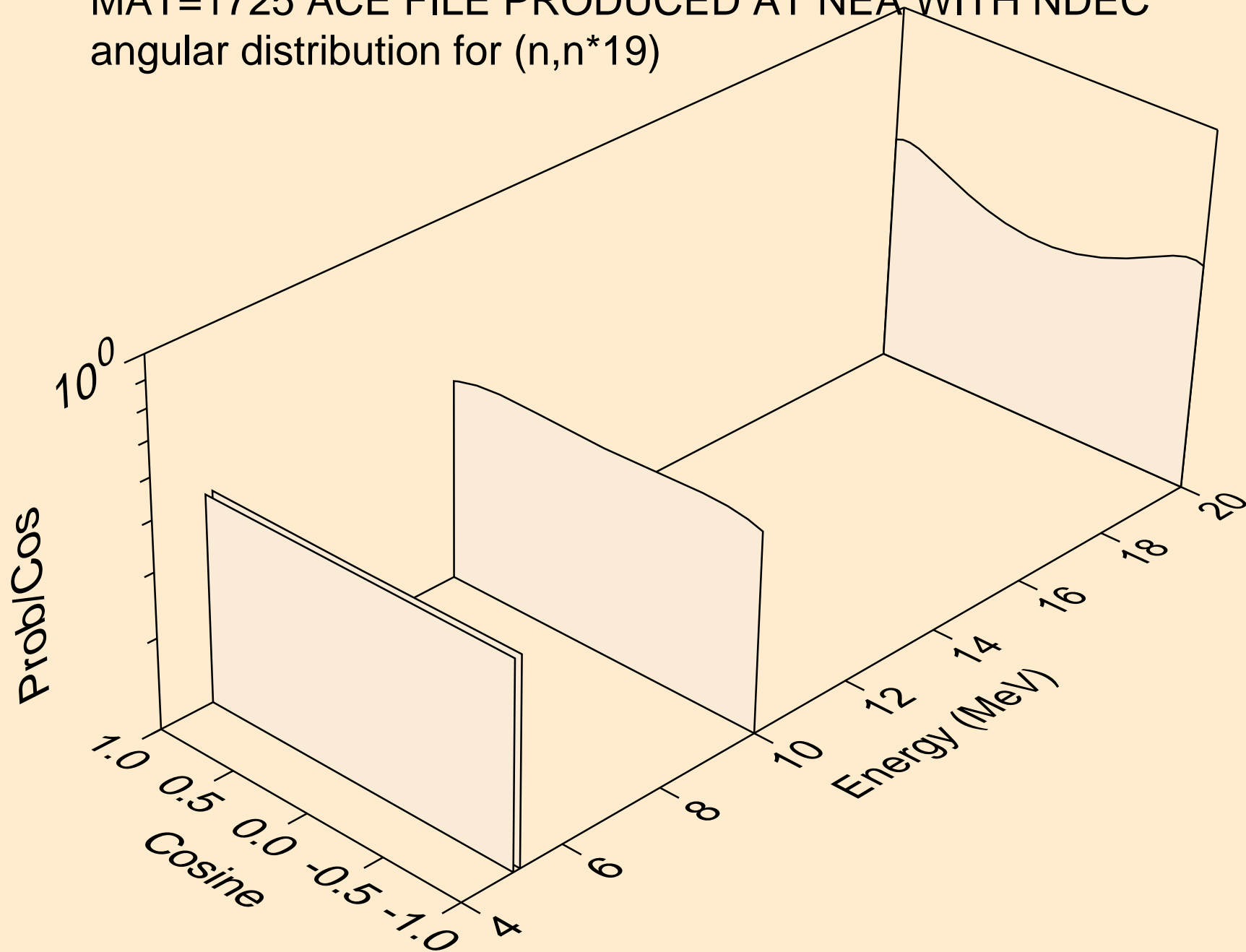

MAT=1725 ACE FILE PRODUCED AT NEA WITH NDEC
angular distribution for (n,n*20)

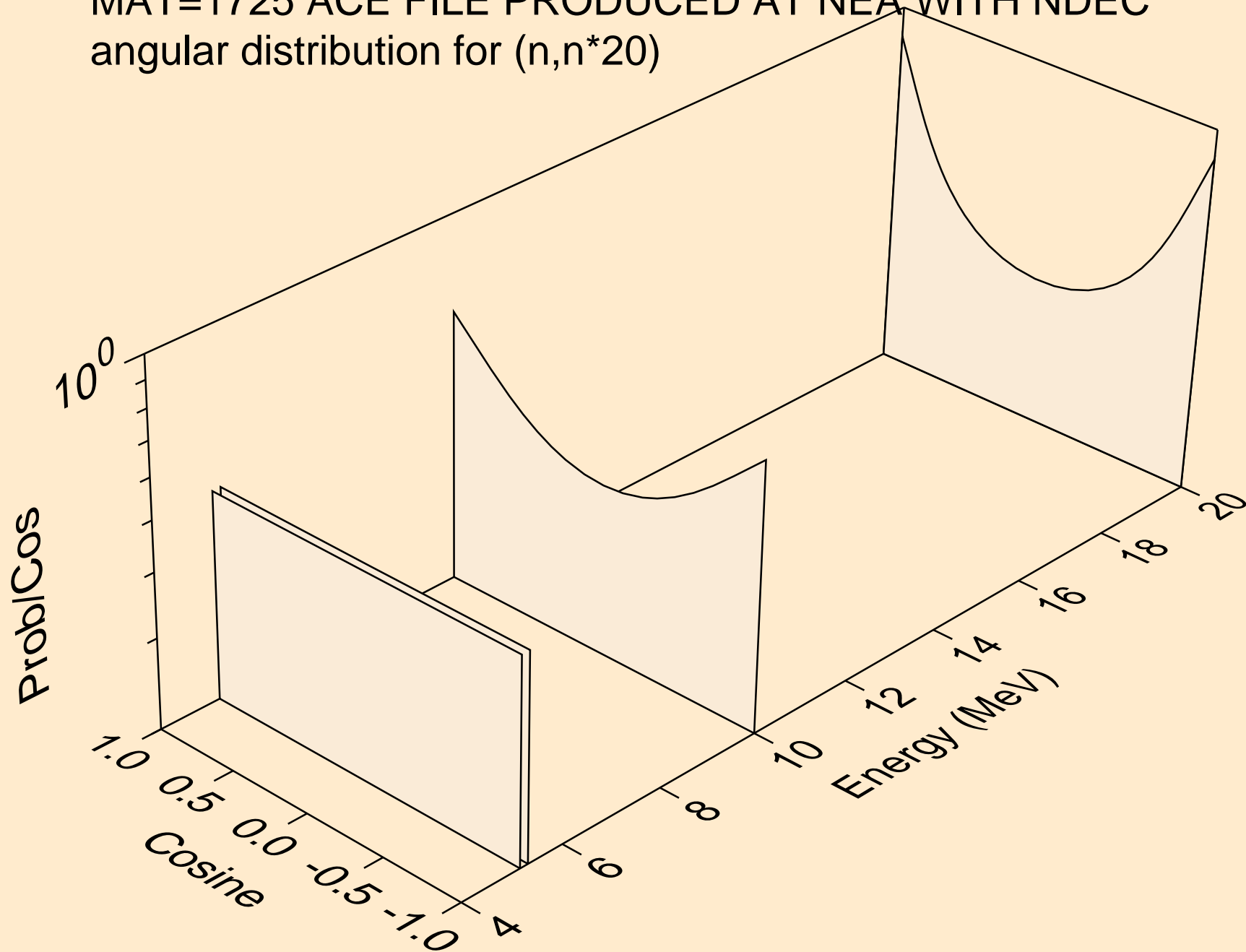

MAT=1725 ACE FILE PRODUCED AT NEA WITH NDEC
angular distribution for (n,n*21)

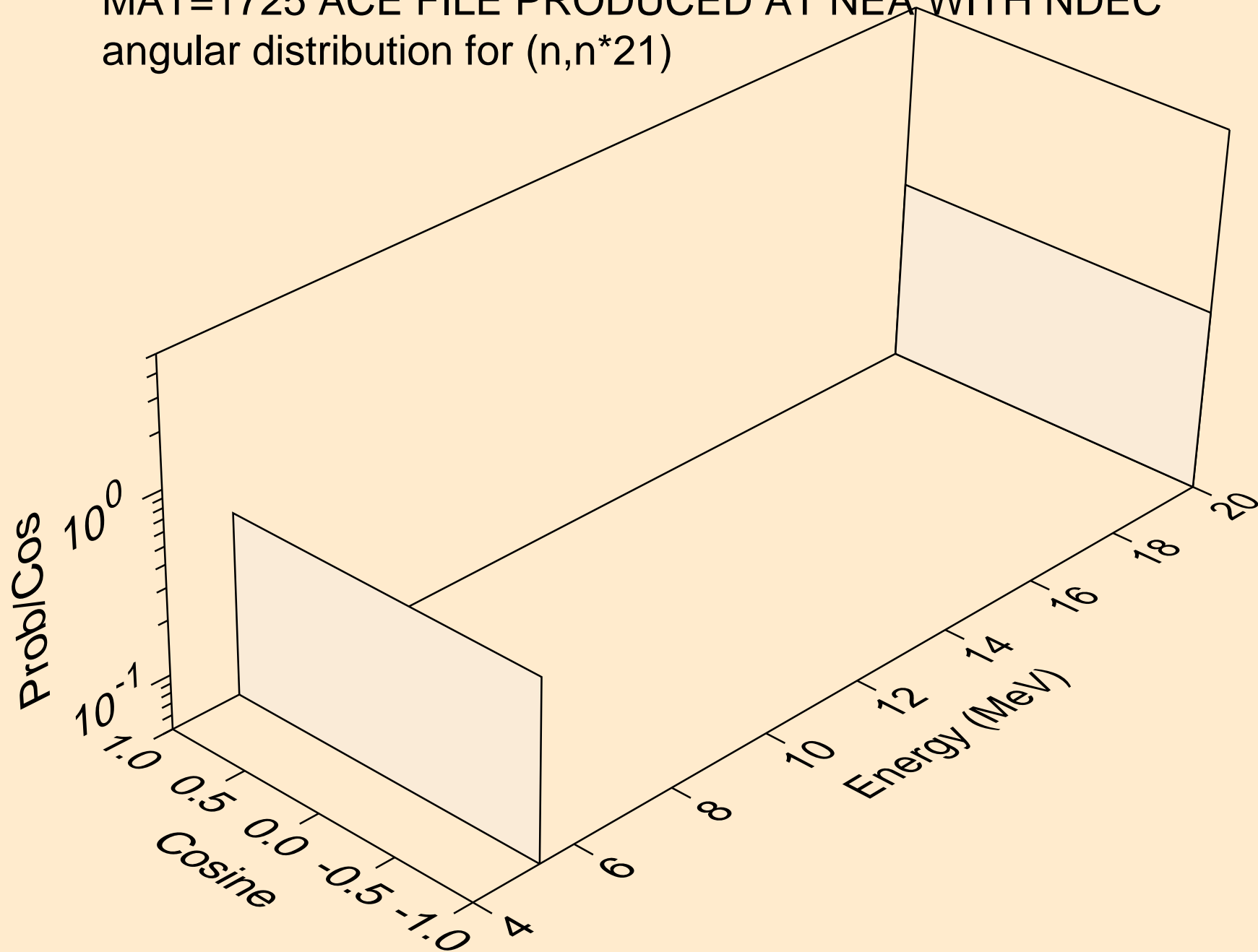

MAT=1725 ACE FILE PRODUCED AT NEA WITH NDEC
angular distribution for (n,n*22)

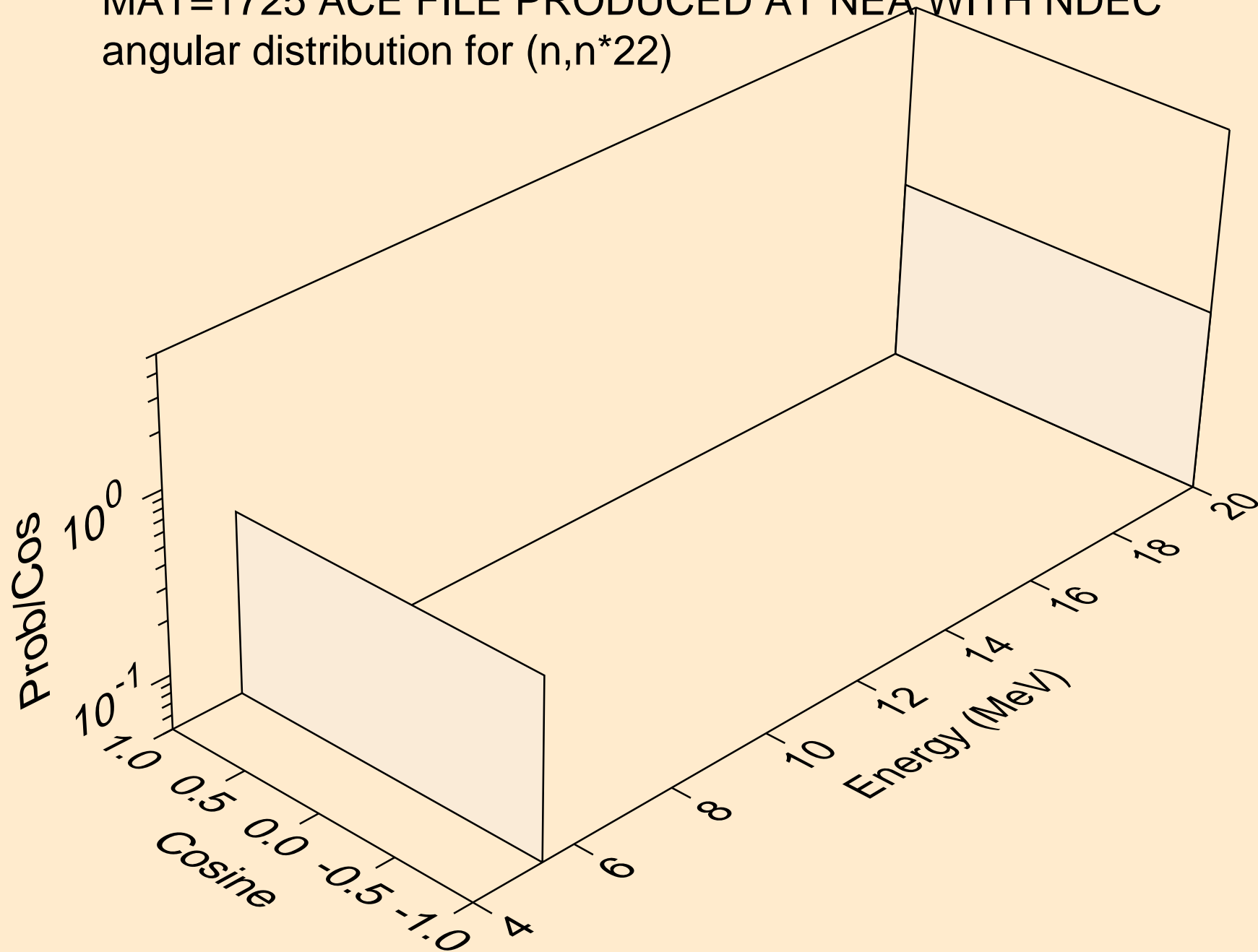

MAT=1725 ACE FILE PRODUCED AT NEA WITH NDEC
angular distribution for (n,n*23)

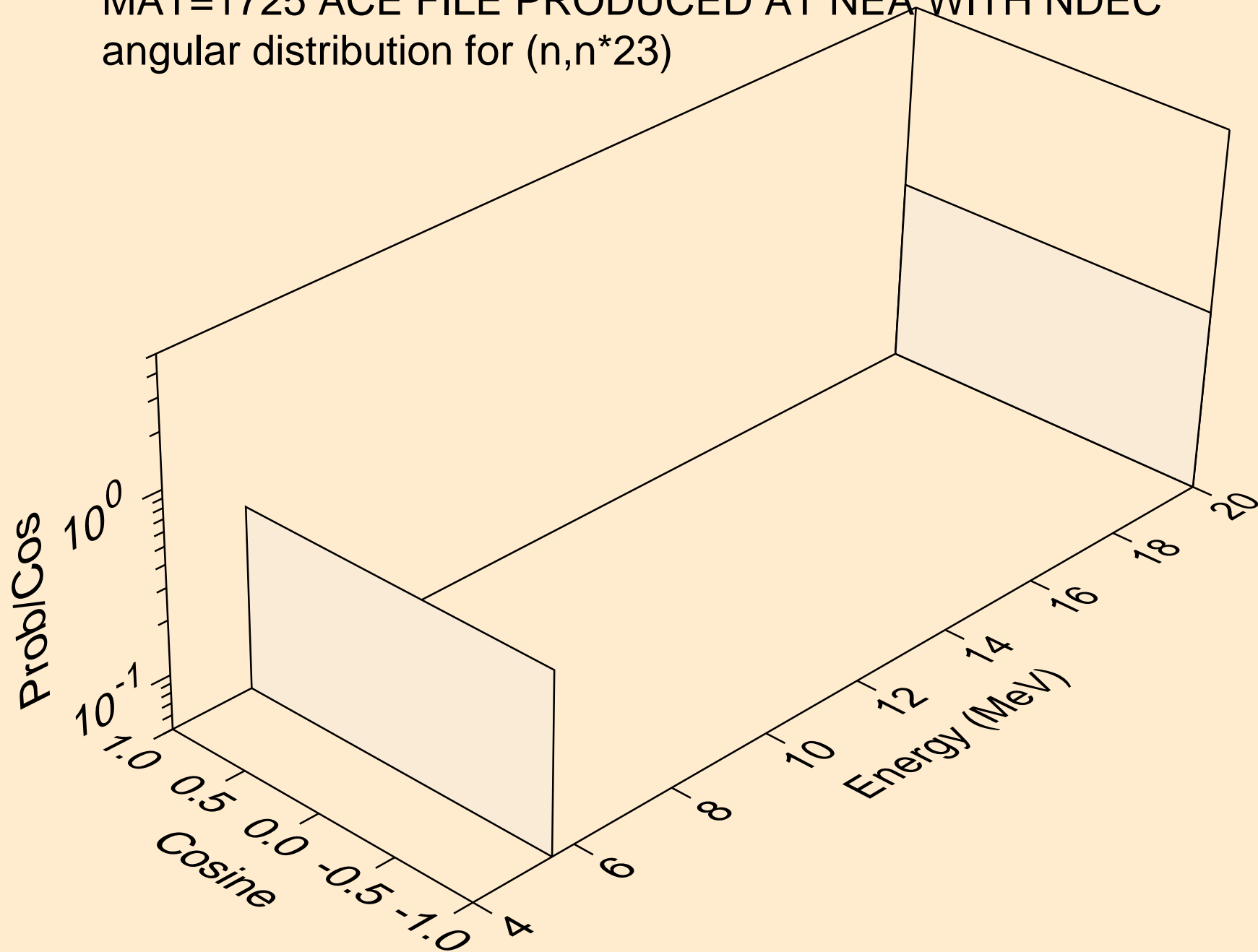

MAT=1725 ACE FILE PRODUCED AT NEA WITH NDEC
angular distribution for (n,n*24)

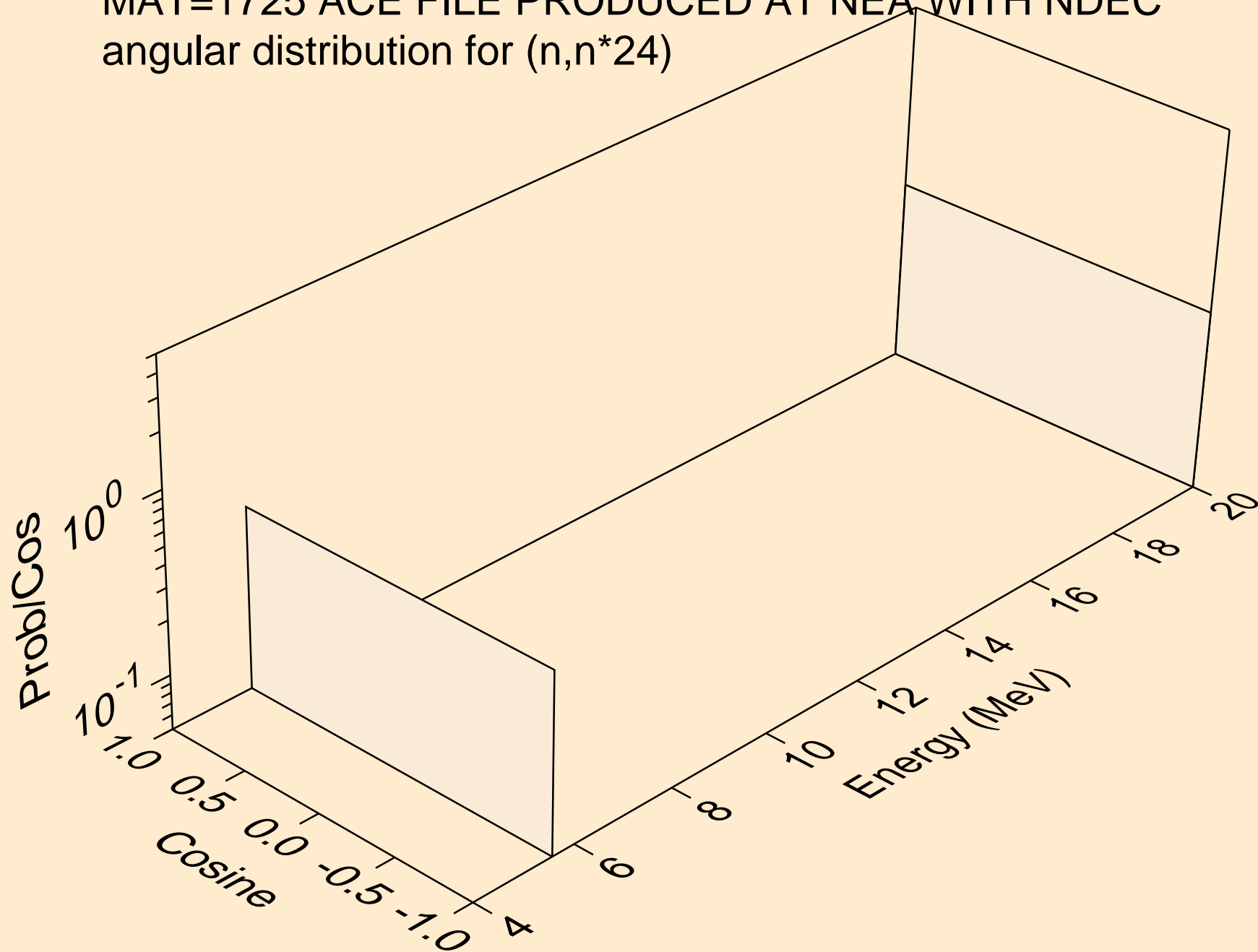

MAT=1725 ACE FILE PRODUCED AT NEA WITH NDEC
angular distribution for (n,n*25)

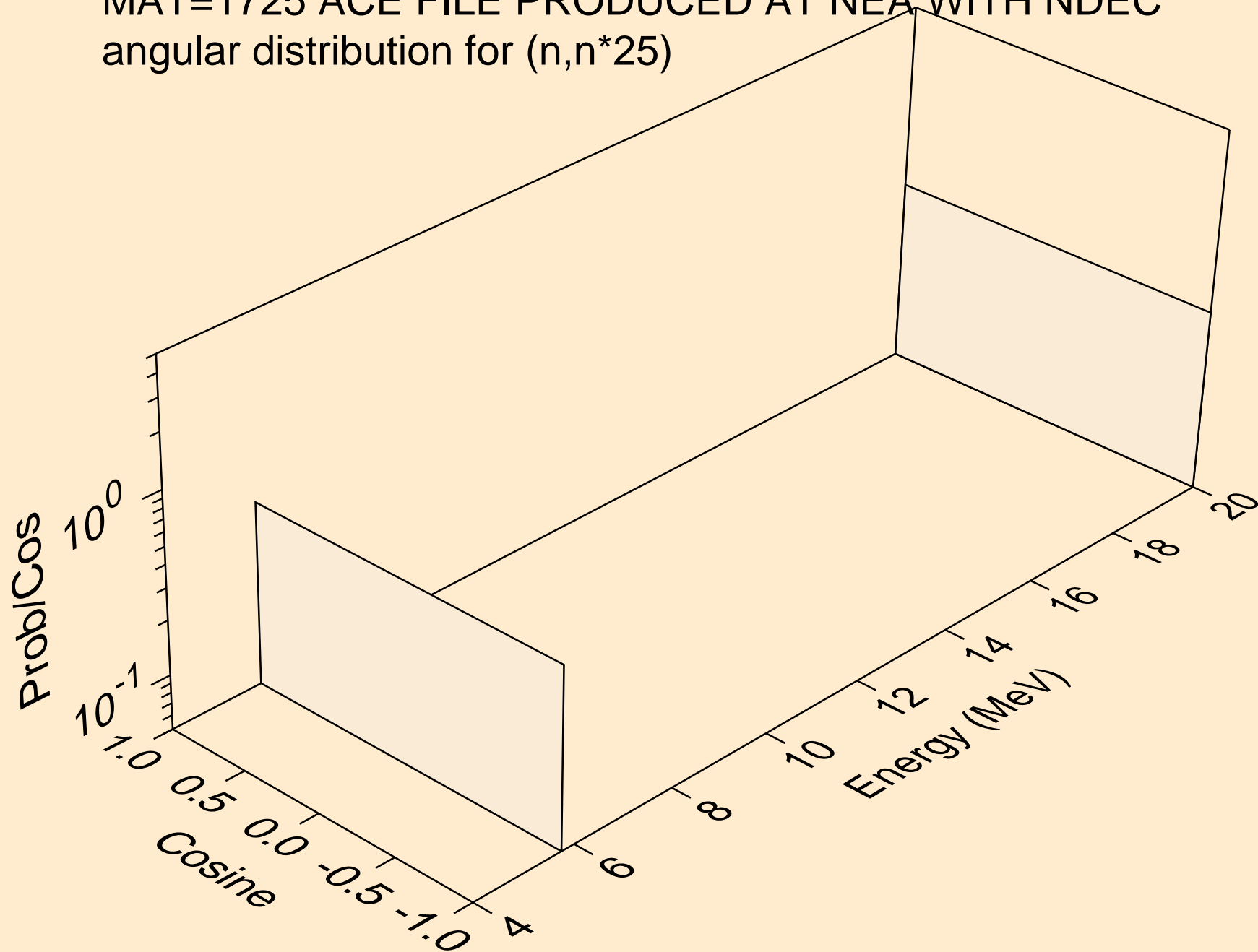

MAT=1725 ACE FILE PRODUCED AT NEA WITH NDEC
angular distribution for (n,n*26)

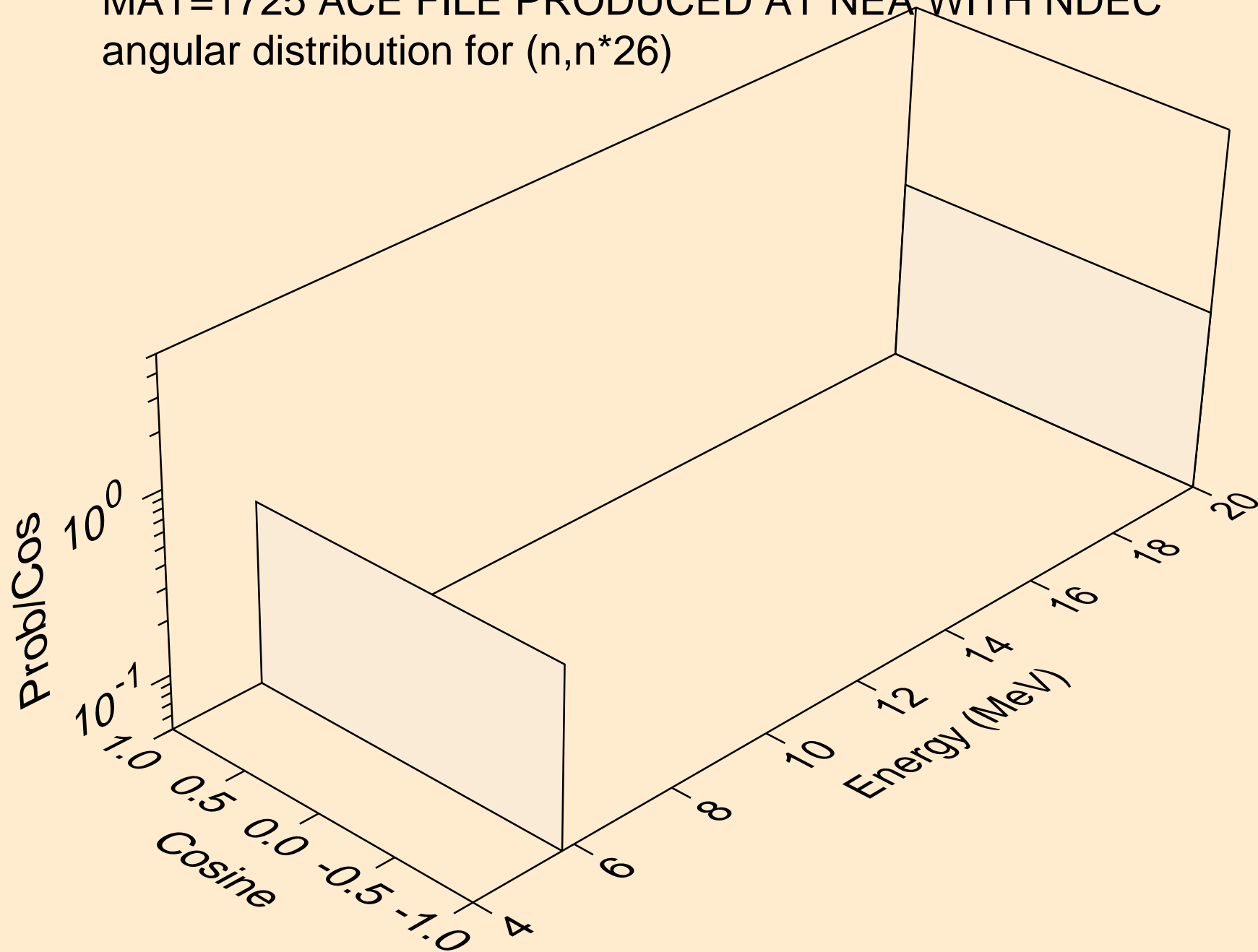

MAT=1725 ACE FILE PRODUCED AT NEA WITH NDEC
angular distribution for (n,n*27)

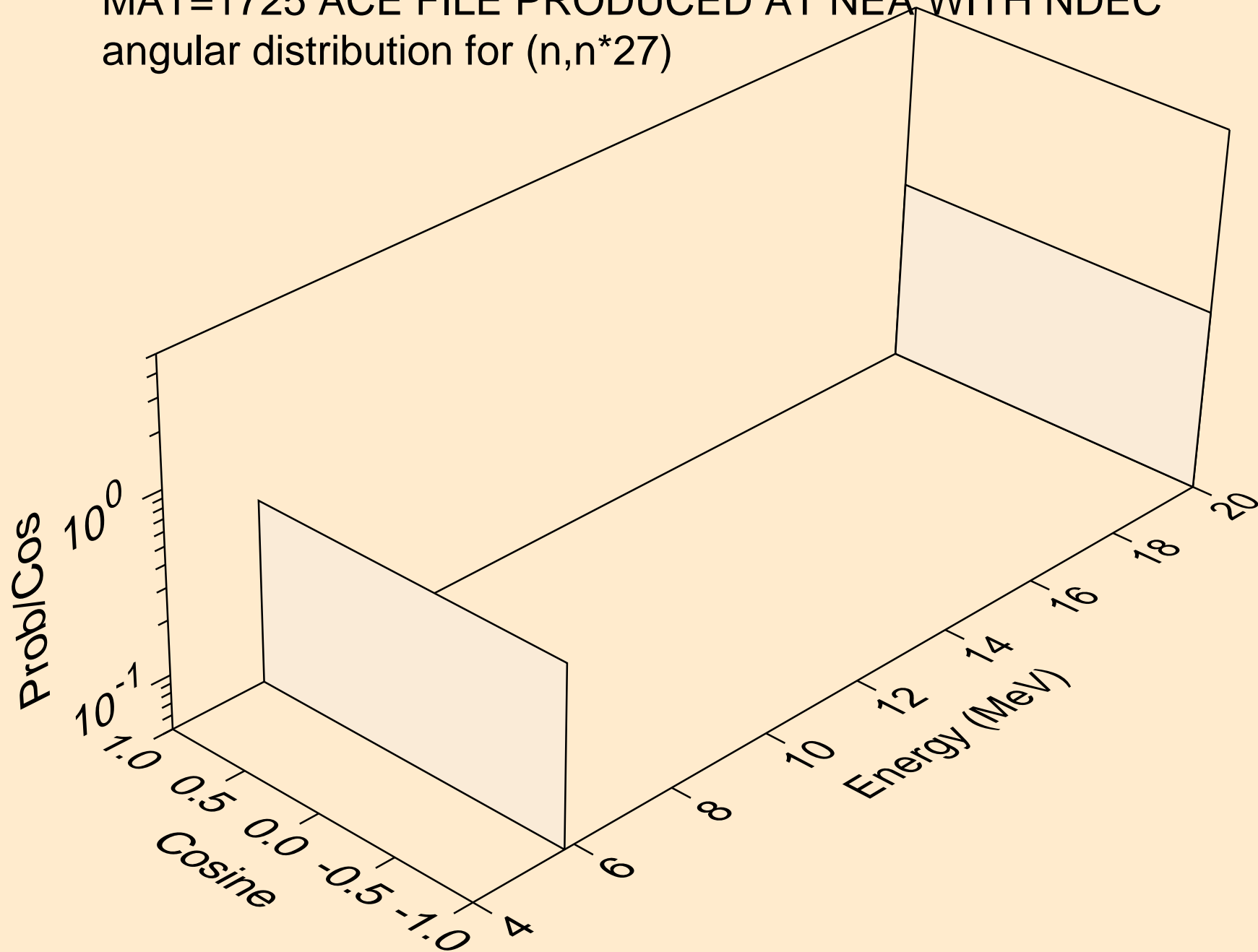

MAT=1725 ACE FILE PRODUCED AT NEA WITH NDEC
angular distribution for (n,n*28)

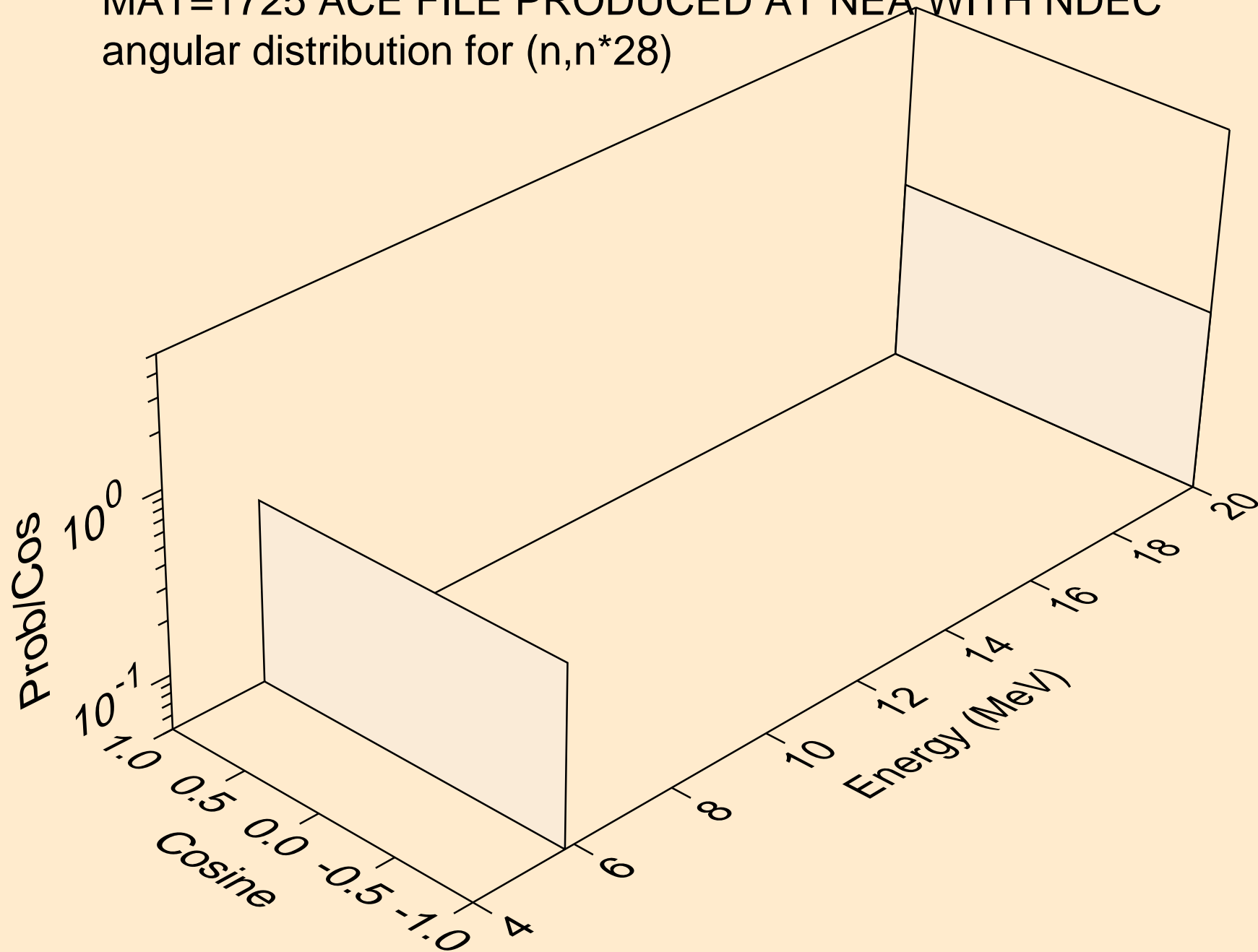

MAT=1725 ACE FILE PRODUCED AT NEA WITH NDEC
angular distribution for (n,n*29)

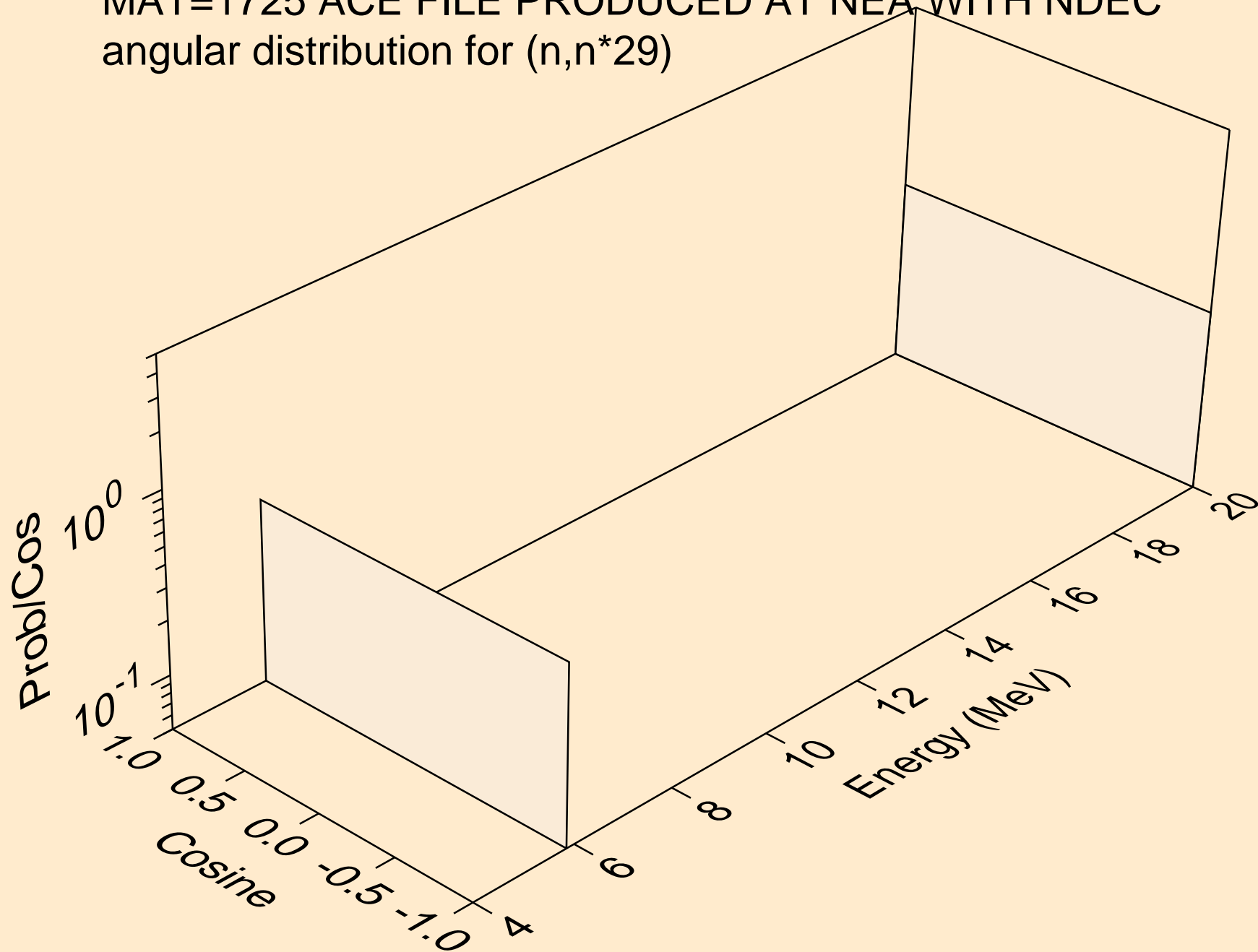

MAT=1725 ACE FILE PRODUCED AT NEA WITH NDEC
angular distribution for (n,n*30)

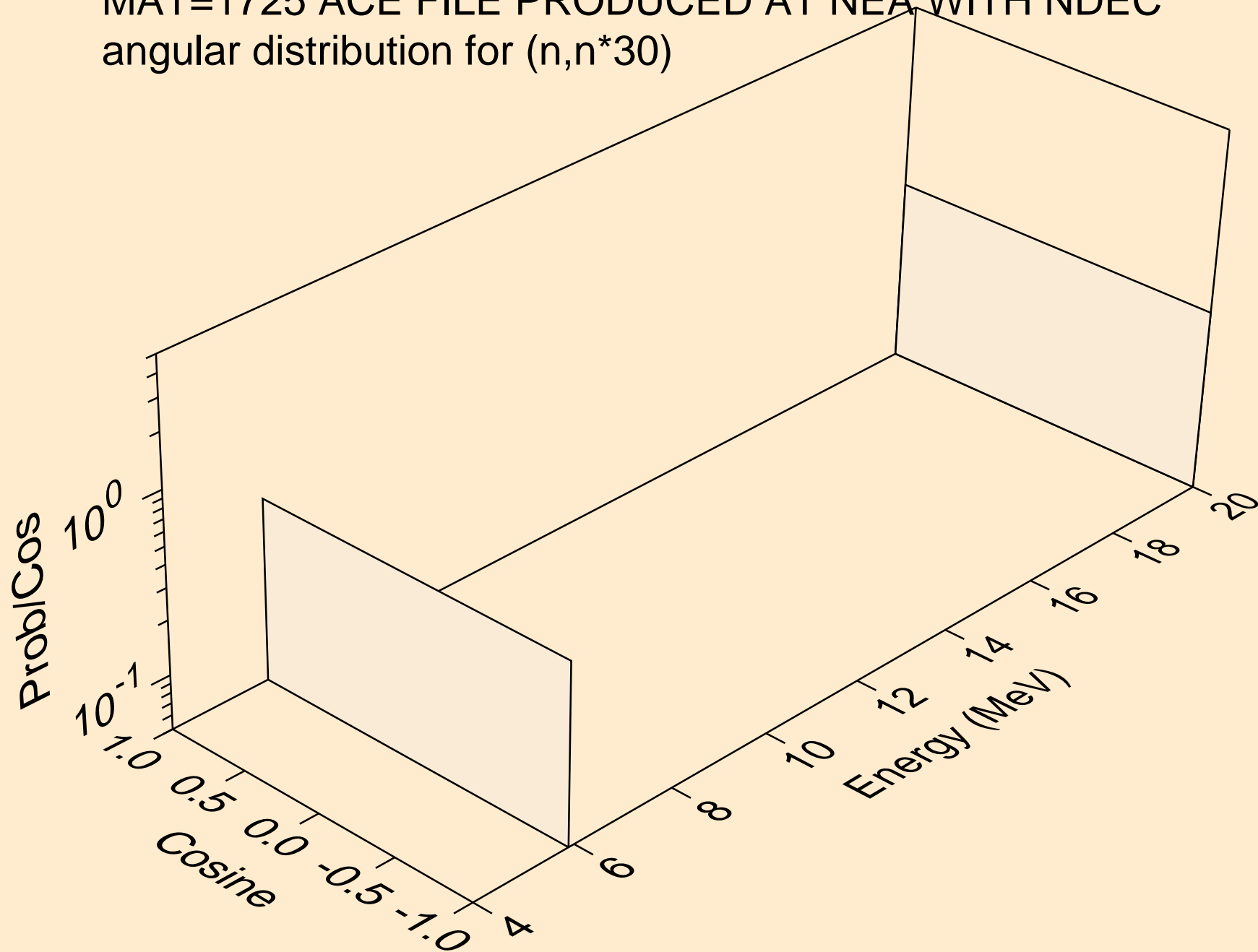

MAT=1725 ACE FILE PRODUCED AT NEA WITH NDEC
Neutron emission for (n,2n)

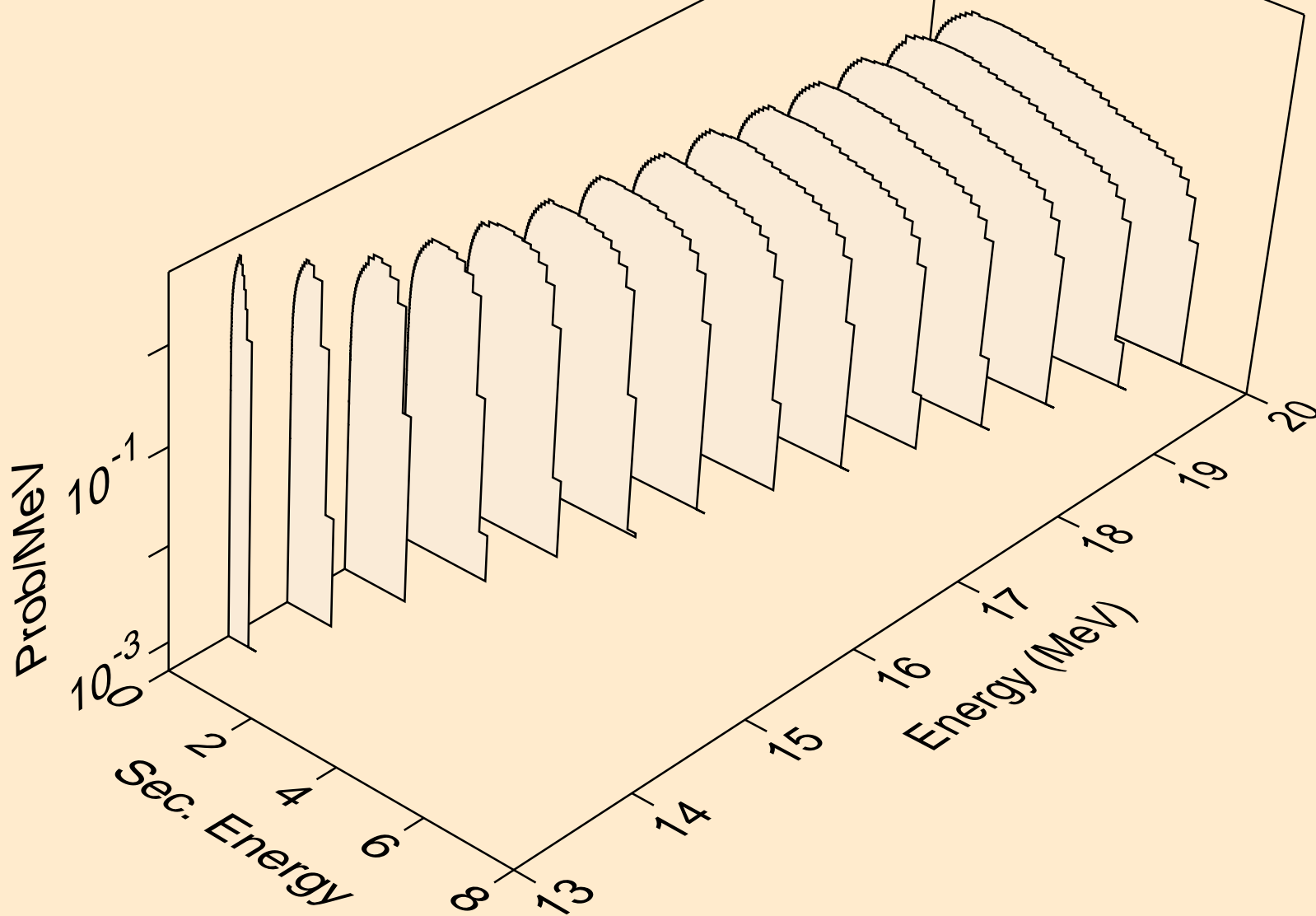

MAT=1725 ACE FILE PRODUCED AT NEA WITH NDEC
Neutron emission for (n,n*)a

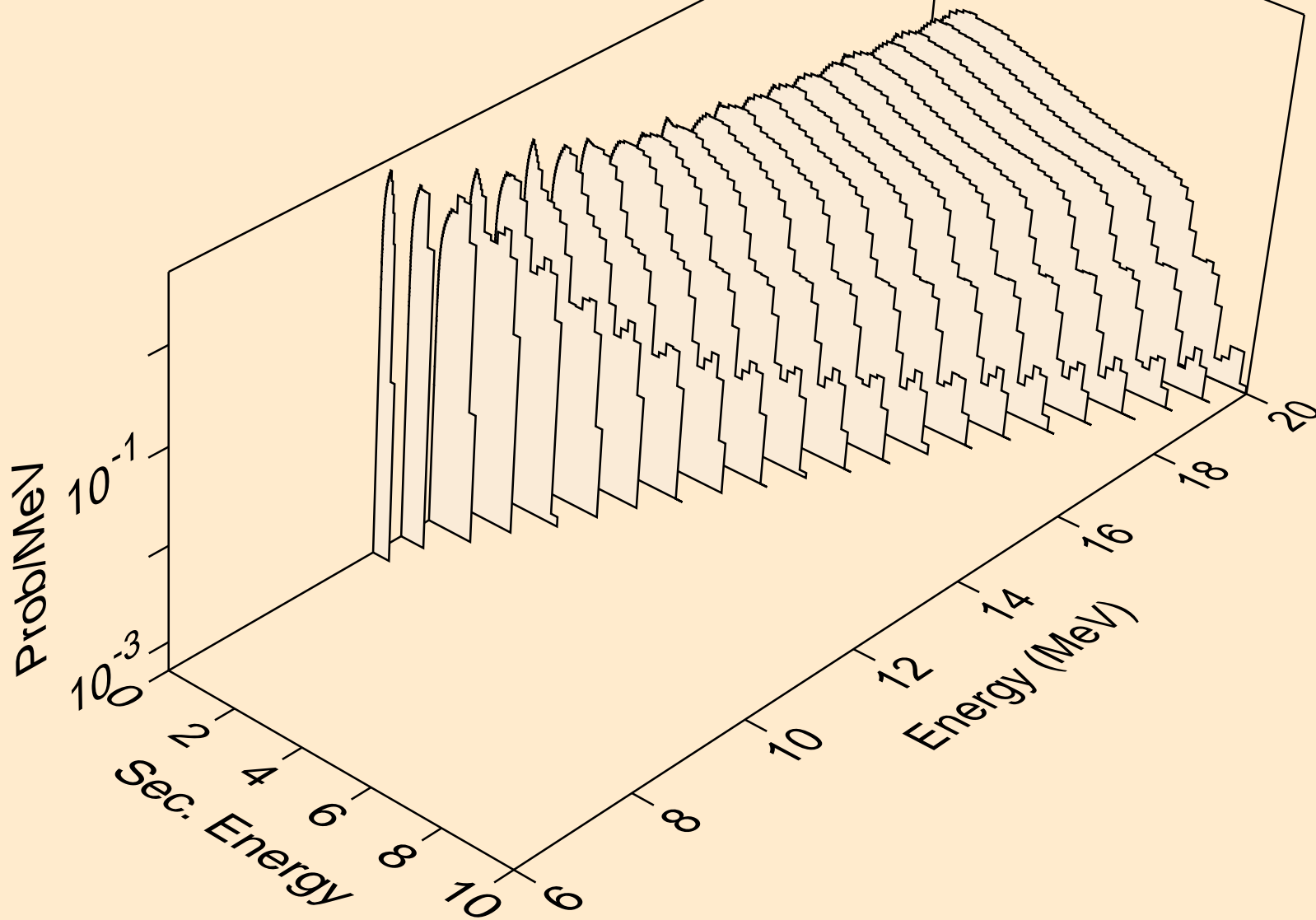

MAT=1725 ACE FILE PRODUCED AT NEA WITH NDEC
Neutron emission for (n,n*)p

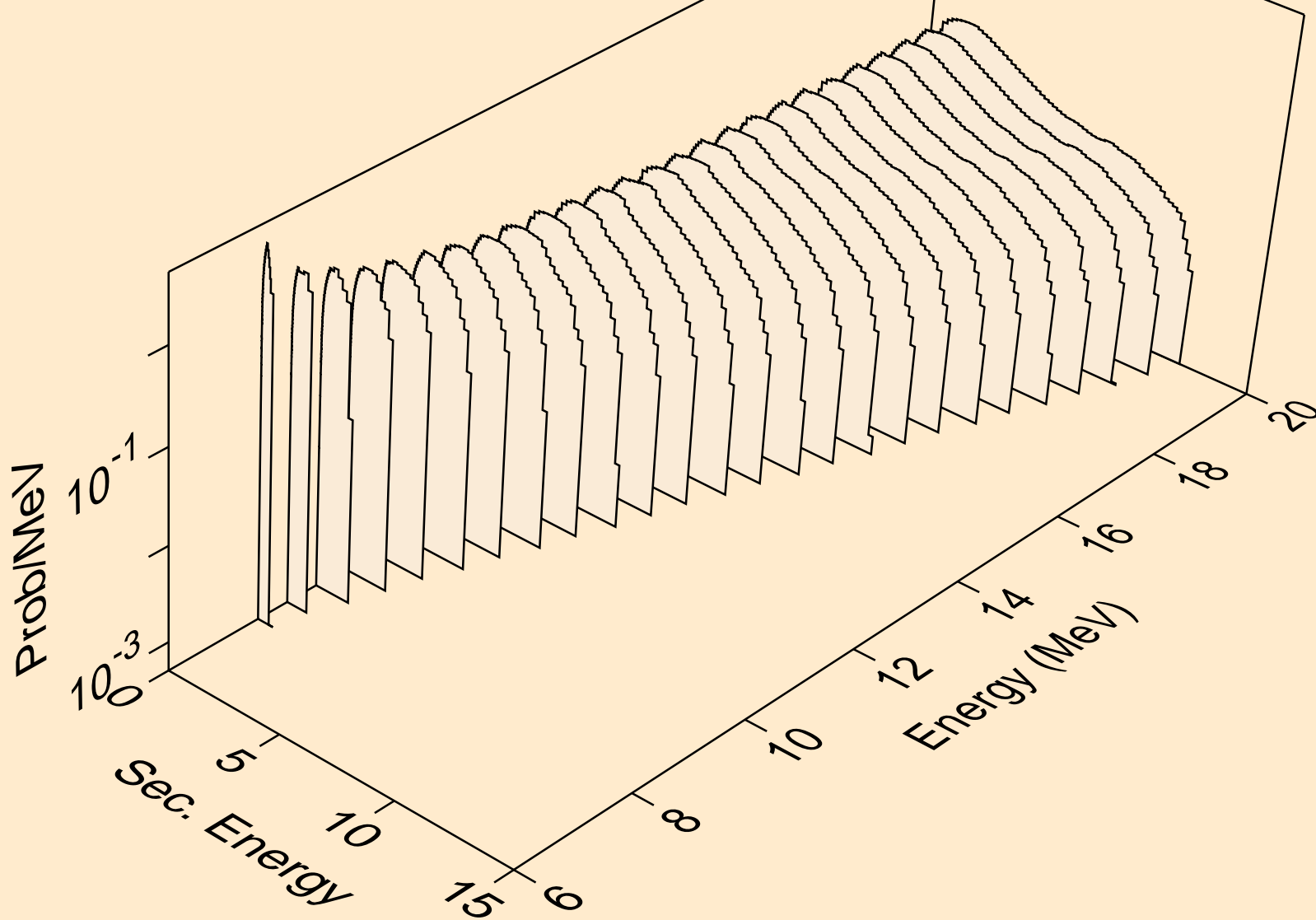

MAT=1725 ACE FILE PRODUCED AT NEA WITH NDEC
Neutron emission for (n,n*)d

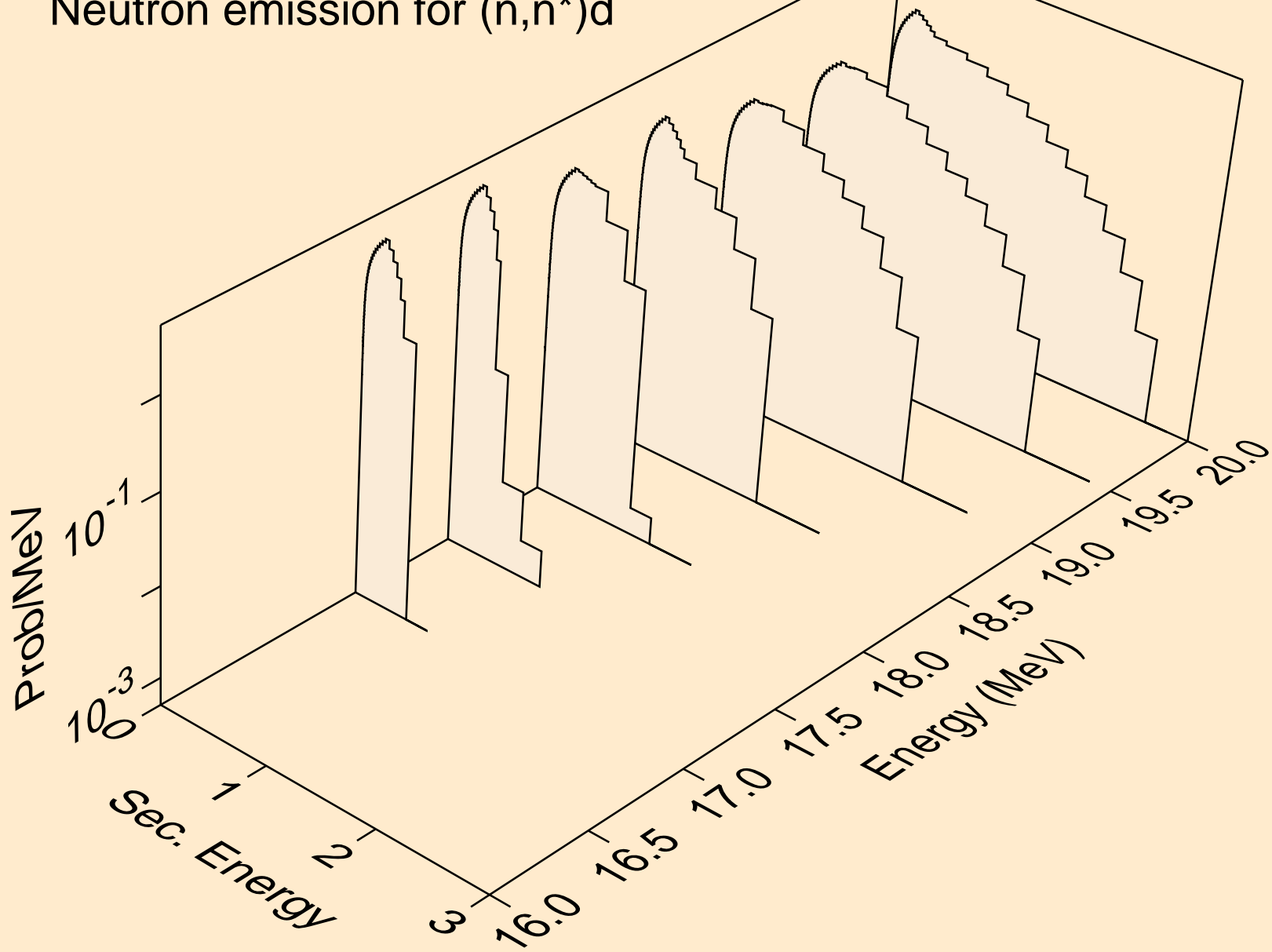

MAT=1725 ACE FILE PRODUCED AT NEA WITH NDEC
Neutron emission for (n,n*c)

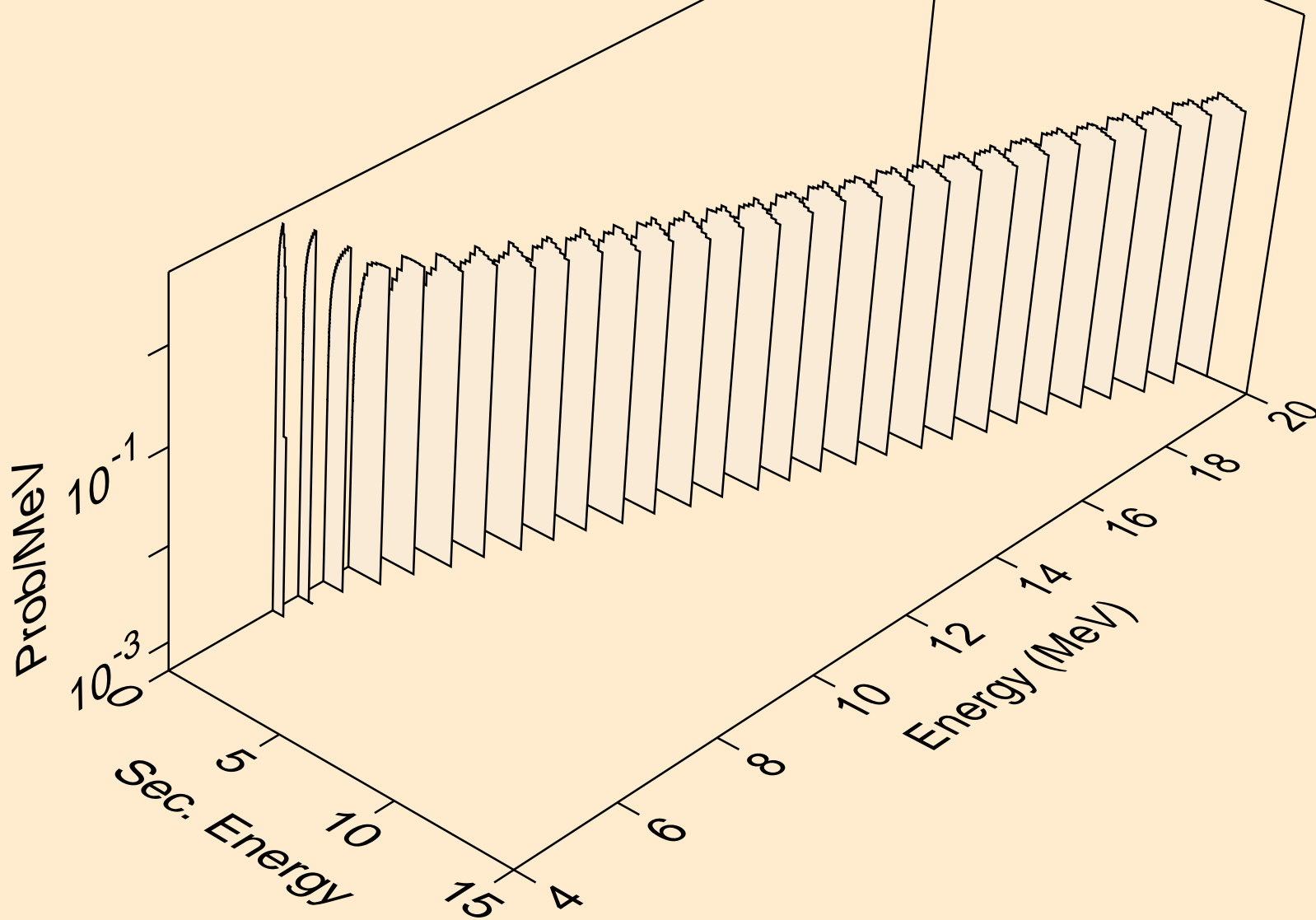

MAT=1725 ACE FILE PRODUCED AT NEA WITH NDEC
Photon emission for (n,gma)

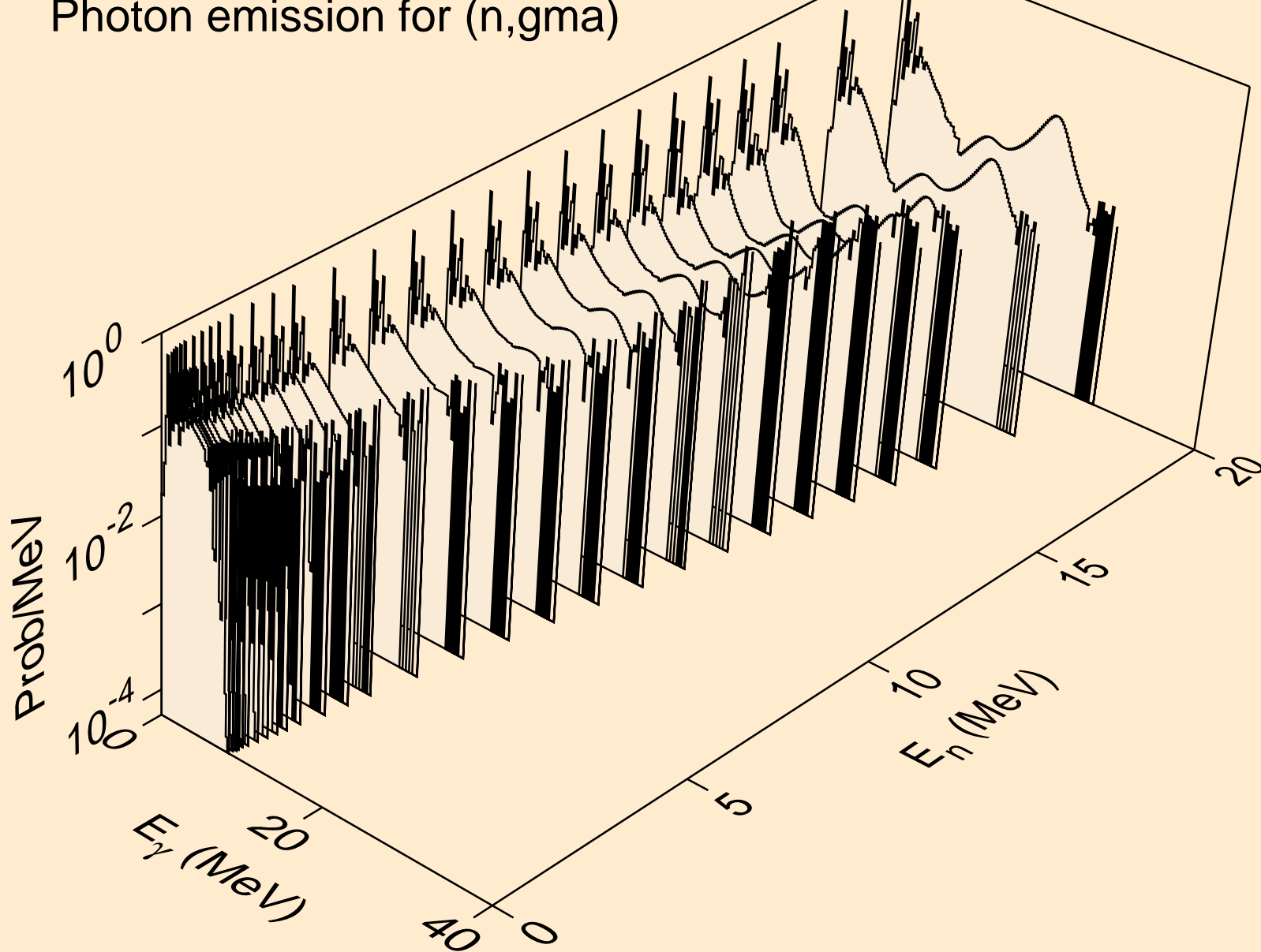

MAT=1725 ACE FILE PRODUCED AT NEA WITH NDEC
Photon emission for (n,2n)

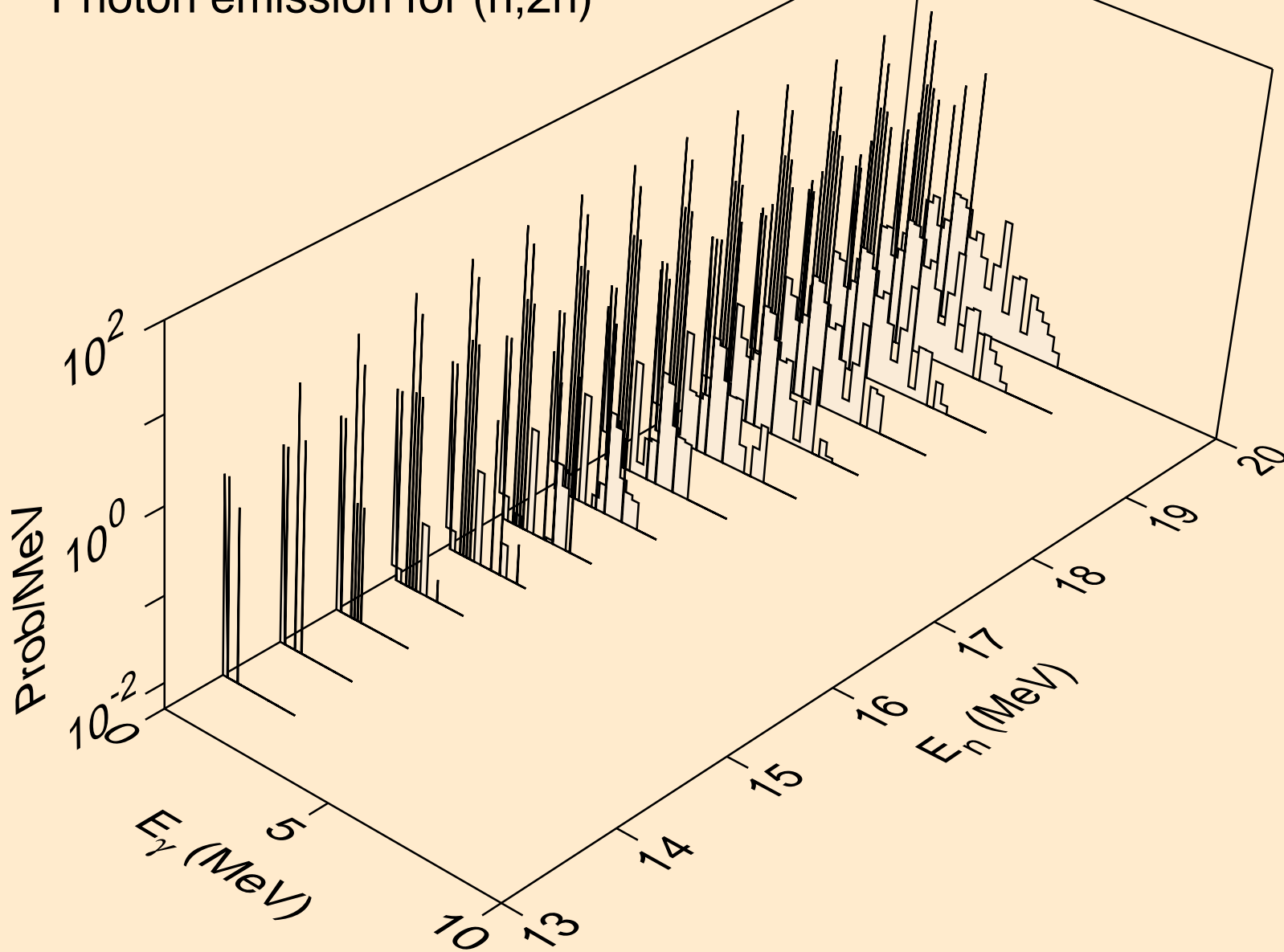

MAT=1725 ACE FILE PRODUCED AT NEA WITH NDEC
Photon emission for (n,n*)a

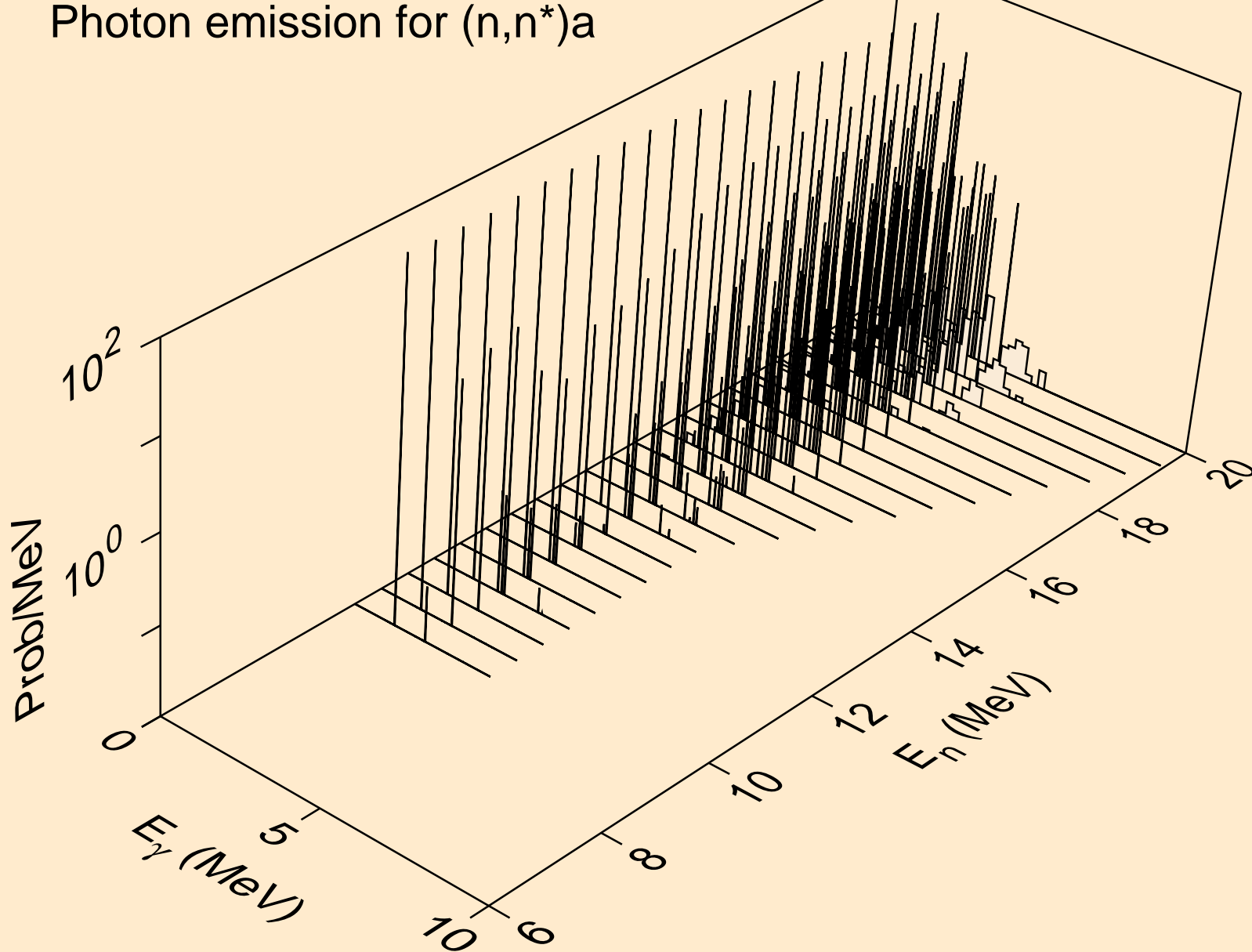

MAT=1725 ACE FILE PRODUCED AT NEA WITH NDEC
Photon emission for (n,n*)p

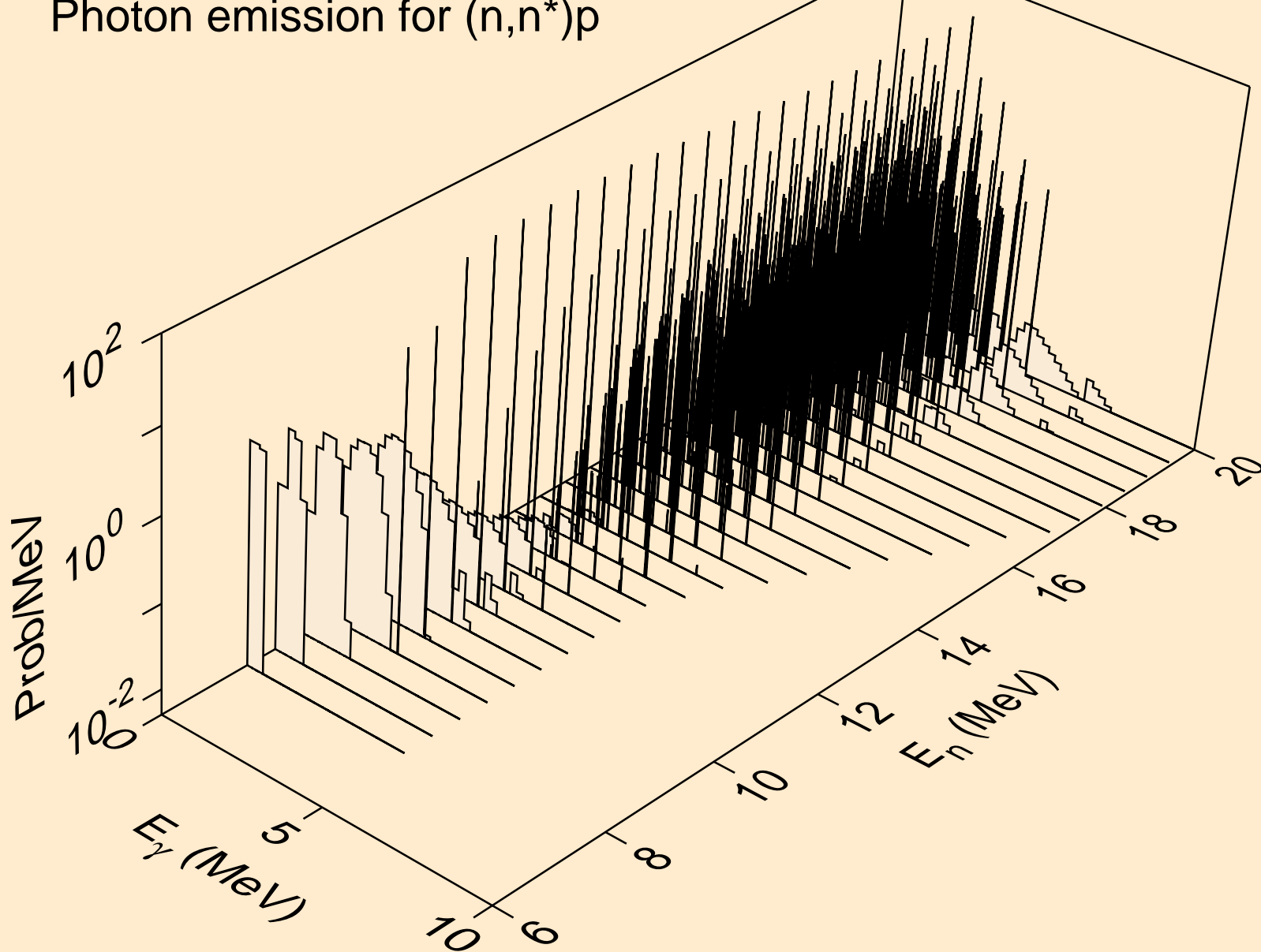

MAT=1725 ACE FILE PRODUCED AT NEA WITH NDEC
Photon emission for (n,n*)d

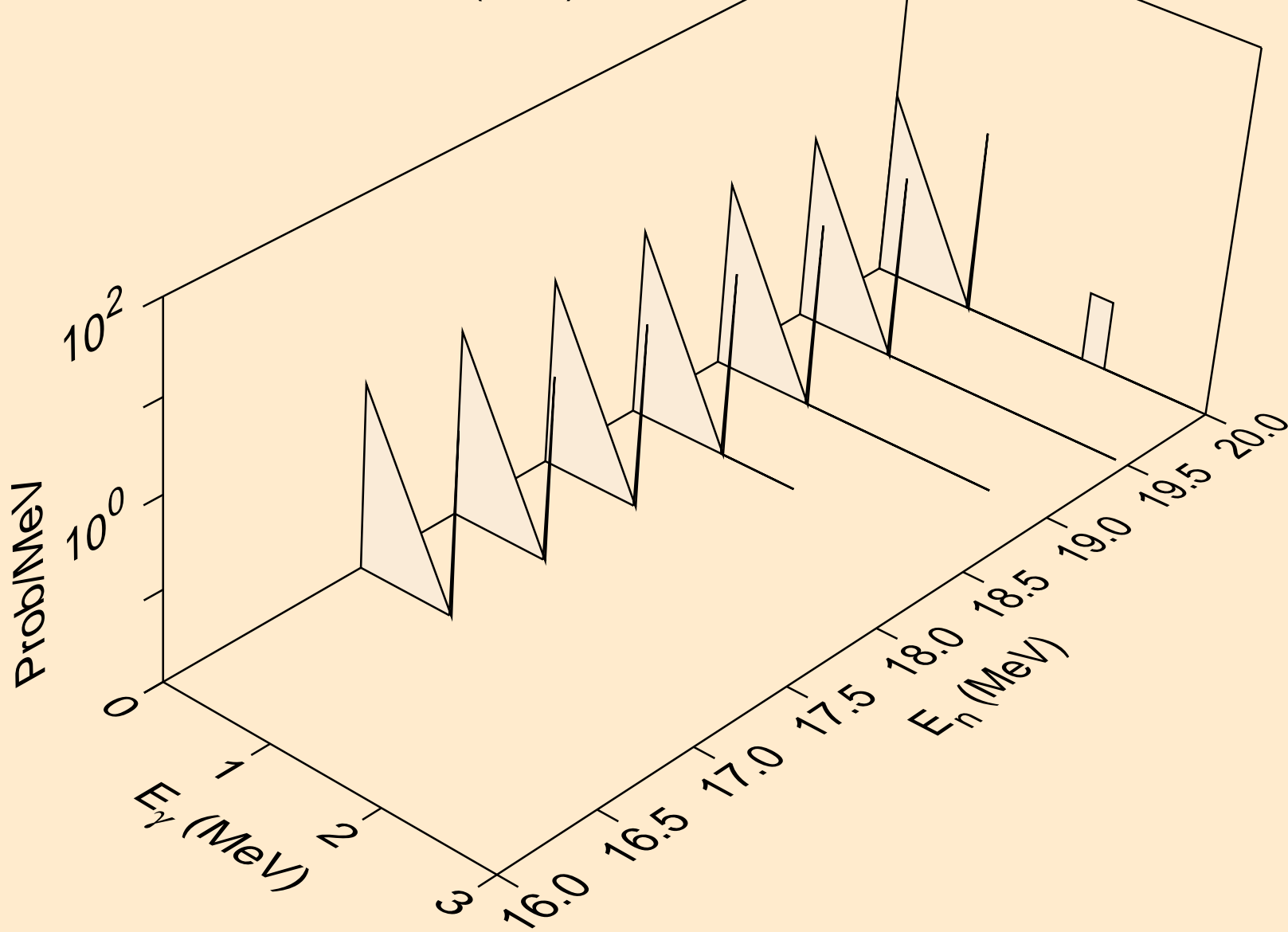

MAT=1725 ACE FILE PRODUCED AT NEA WITH NDEC
Photon emission for (n,n*1)

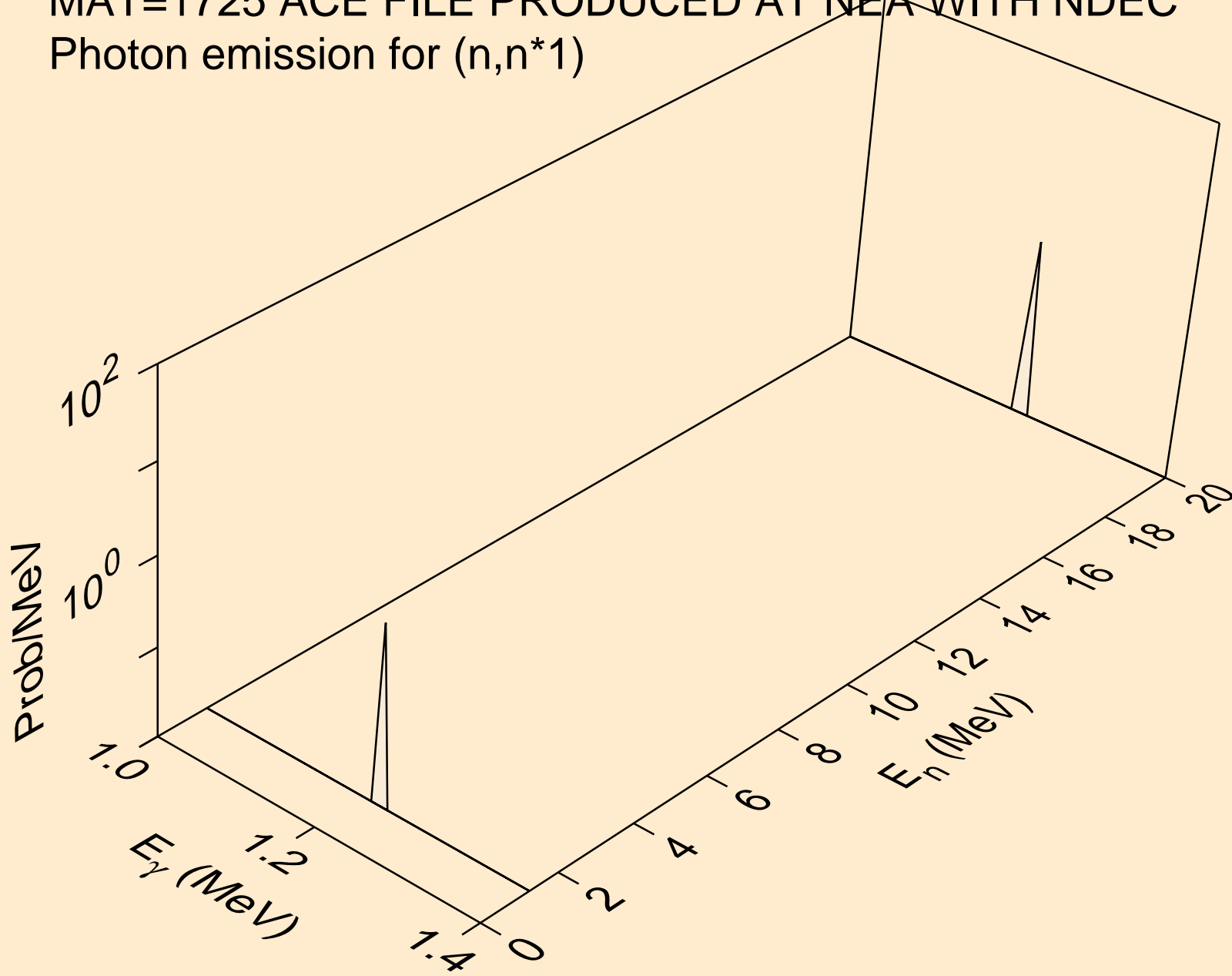

MAT=1725 ACE FILE PRODUCED AT NEA WITH NDEC
Photon emission for (n,n*2)

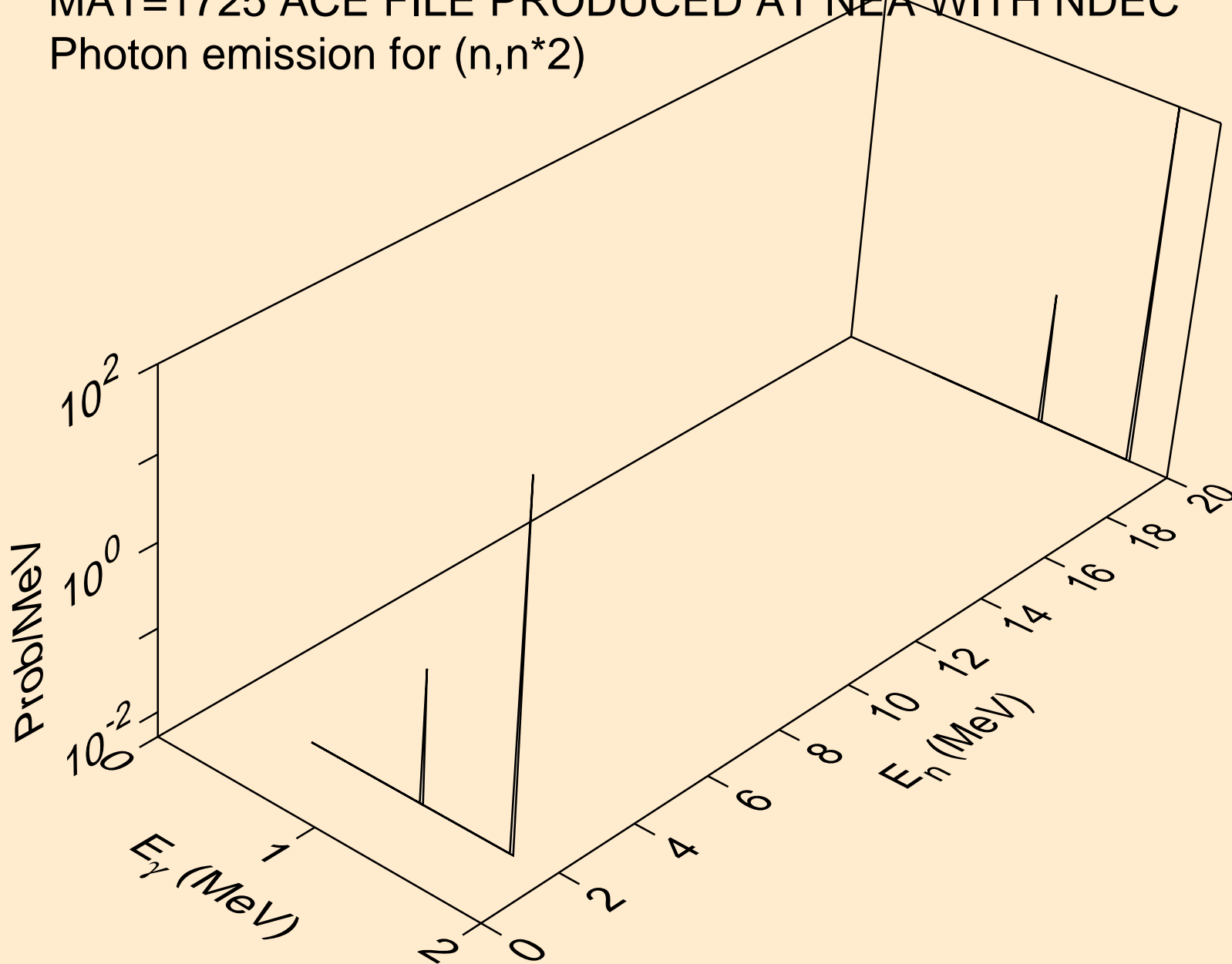

MAT=1725 ACE FILE PRODUCED AT NEA WITH NDEC
Photon emission for (n,n*3)

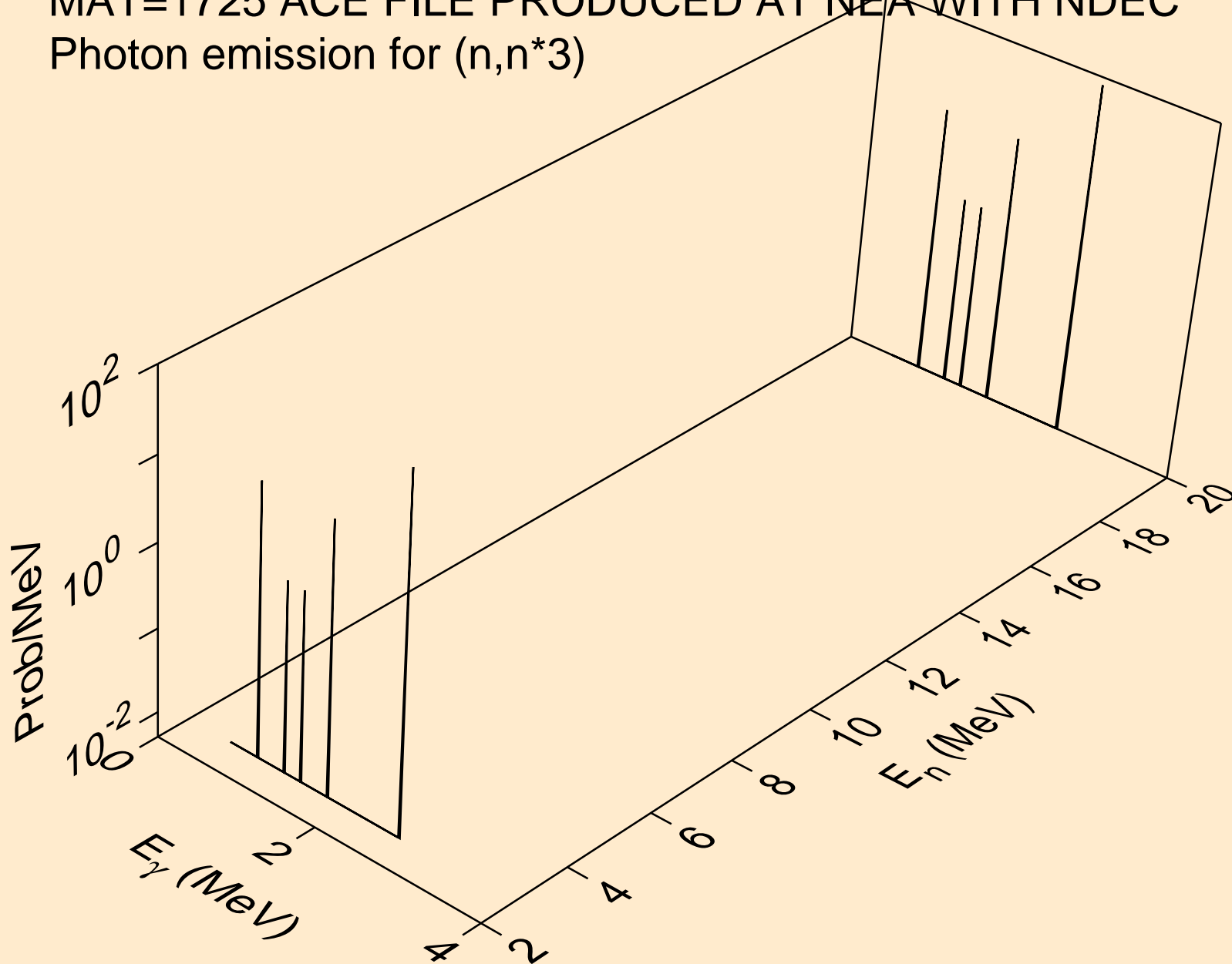

MAT=1725 ACE FILE PRODUCED AT NEA WITH NDEC
Photon emission for (n,n*4)

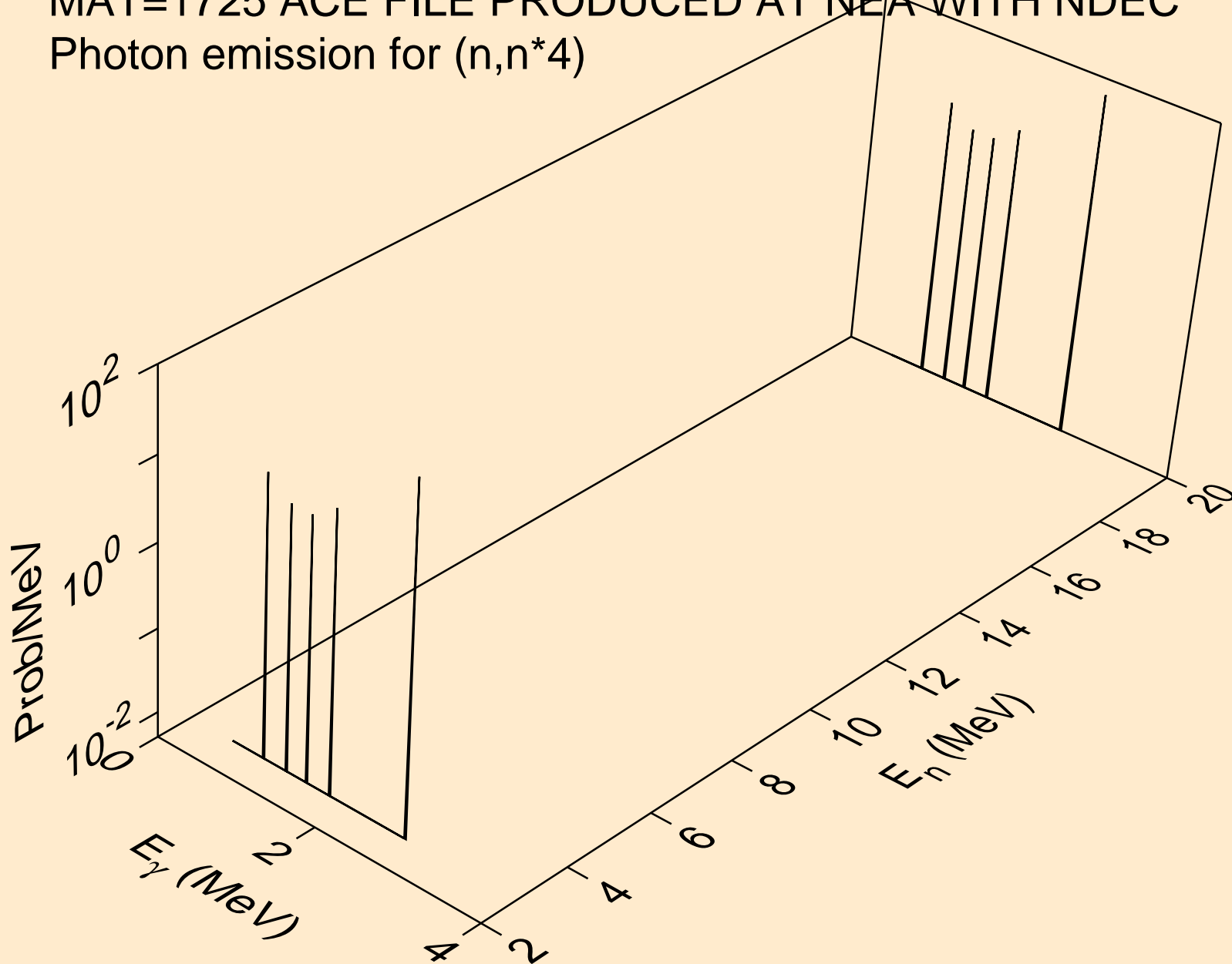

MAT=1725 ACE FILE PRODUCED AT NEA WITH NDEC
Photon emission for (n,n*5)

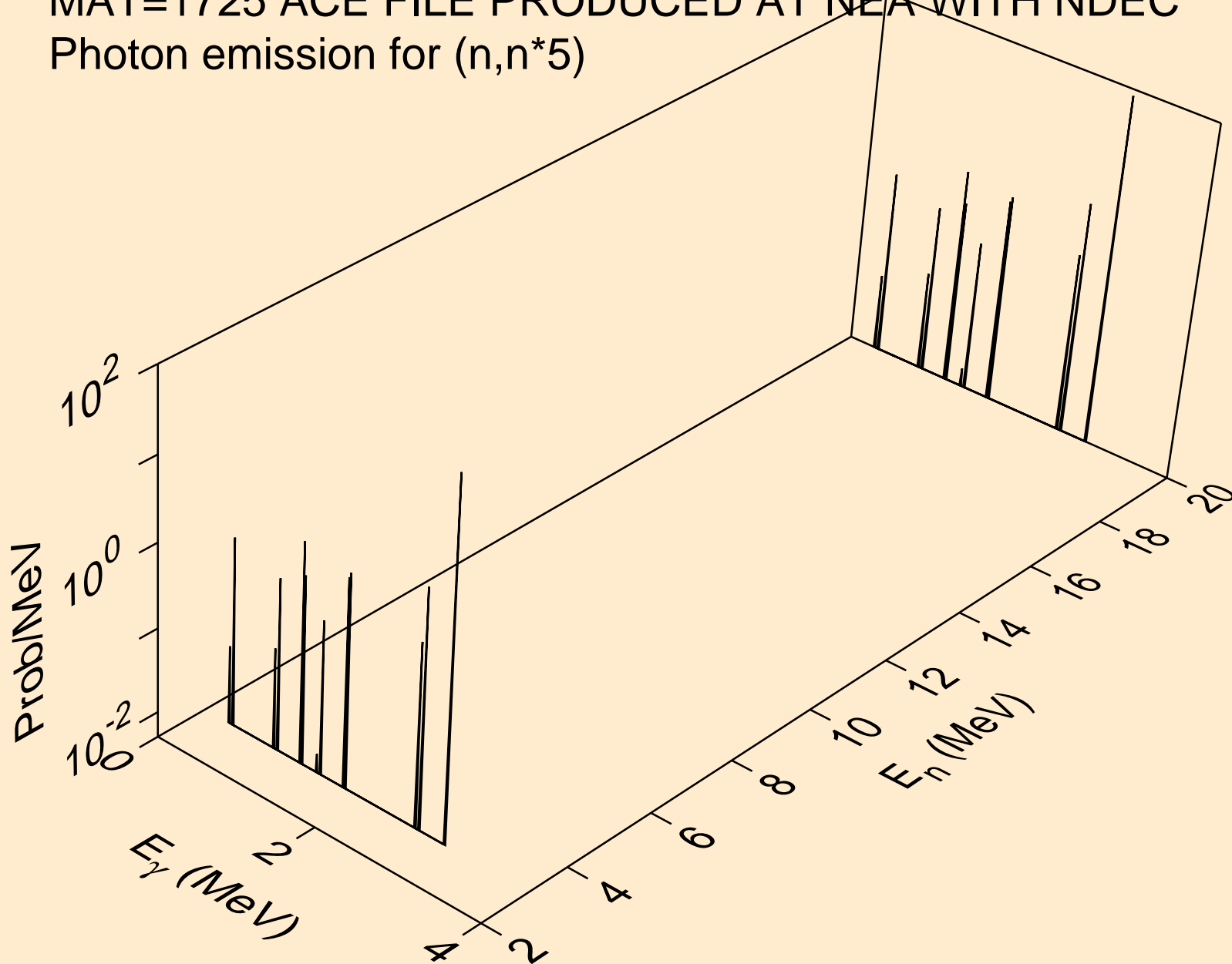

MAT=1725 ACE FILE PRODUCED AT NEA WITH NDEC
Photon emission for (n,n*6)

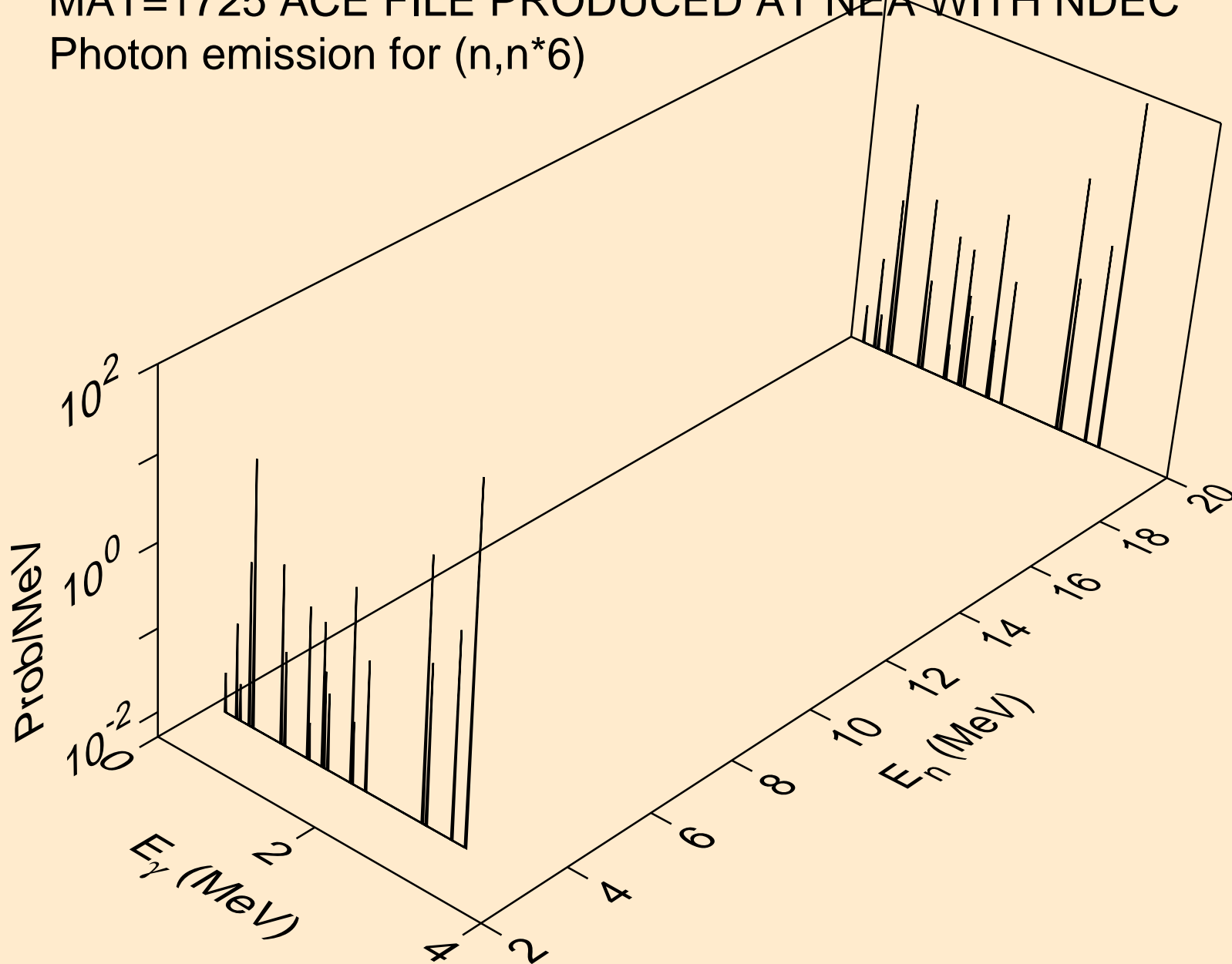

MAT=1725 ACE FILE PRODUCED AT NEA WITH NDEC
Photon emission for (n,n*7)

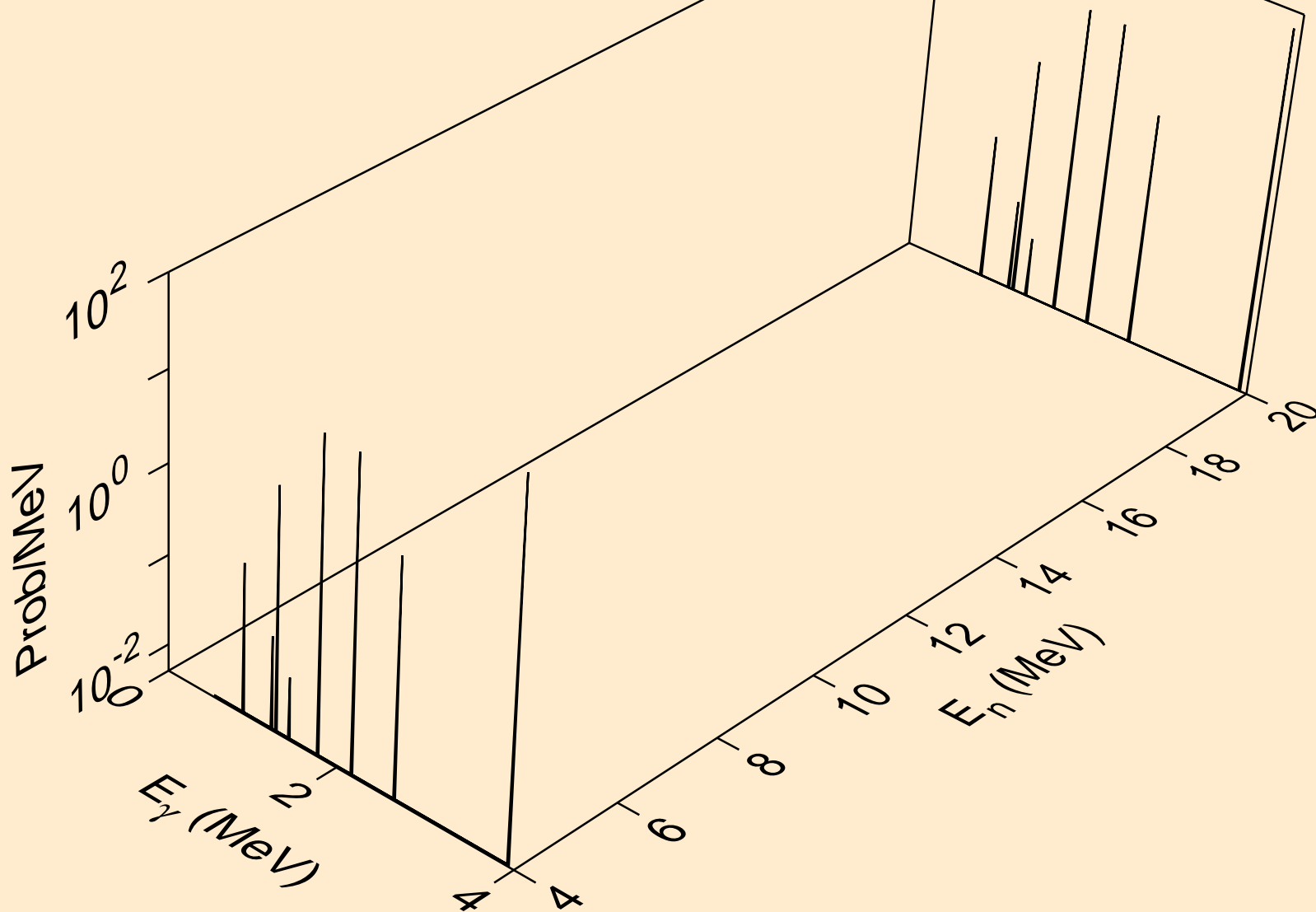

MAT=1725 ACE FILE PRODUCED AT NEA WITH NDEC
Photon emission for (n,n*8)

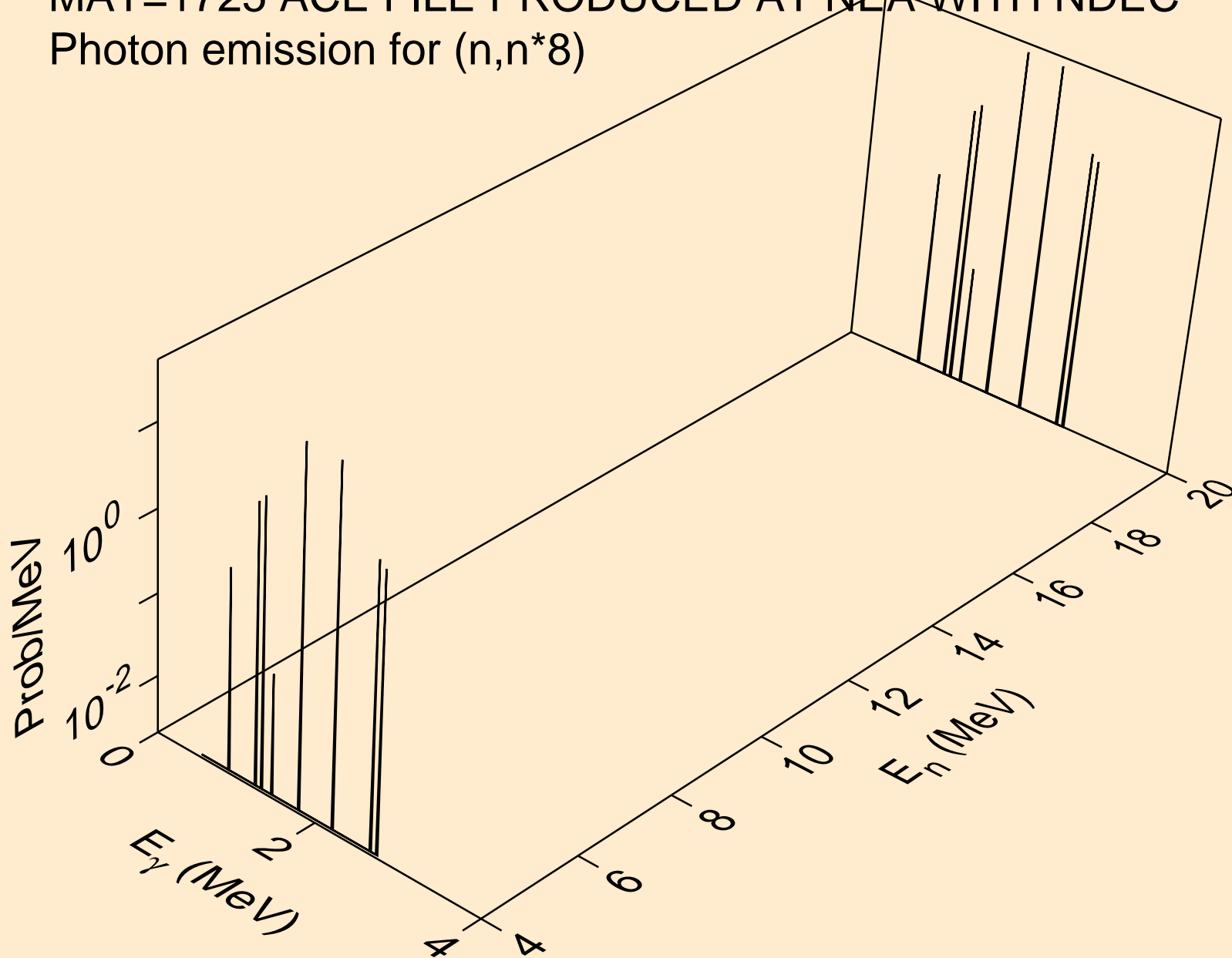

MAT=1725 ACE FILE PRODUCED AT NEA WITH NDEC
Photon emission for (n,n*9)

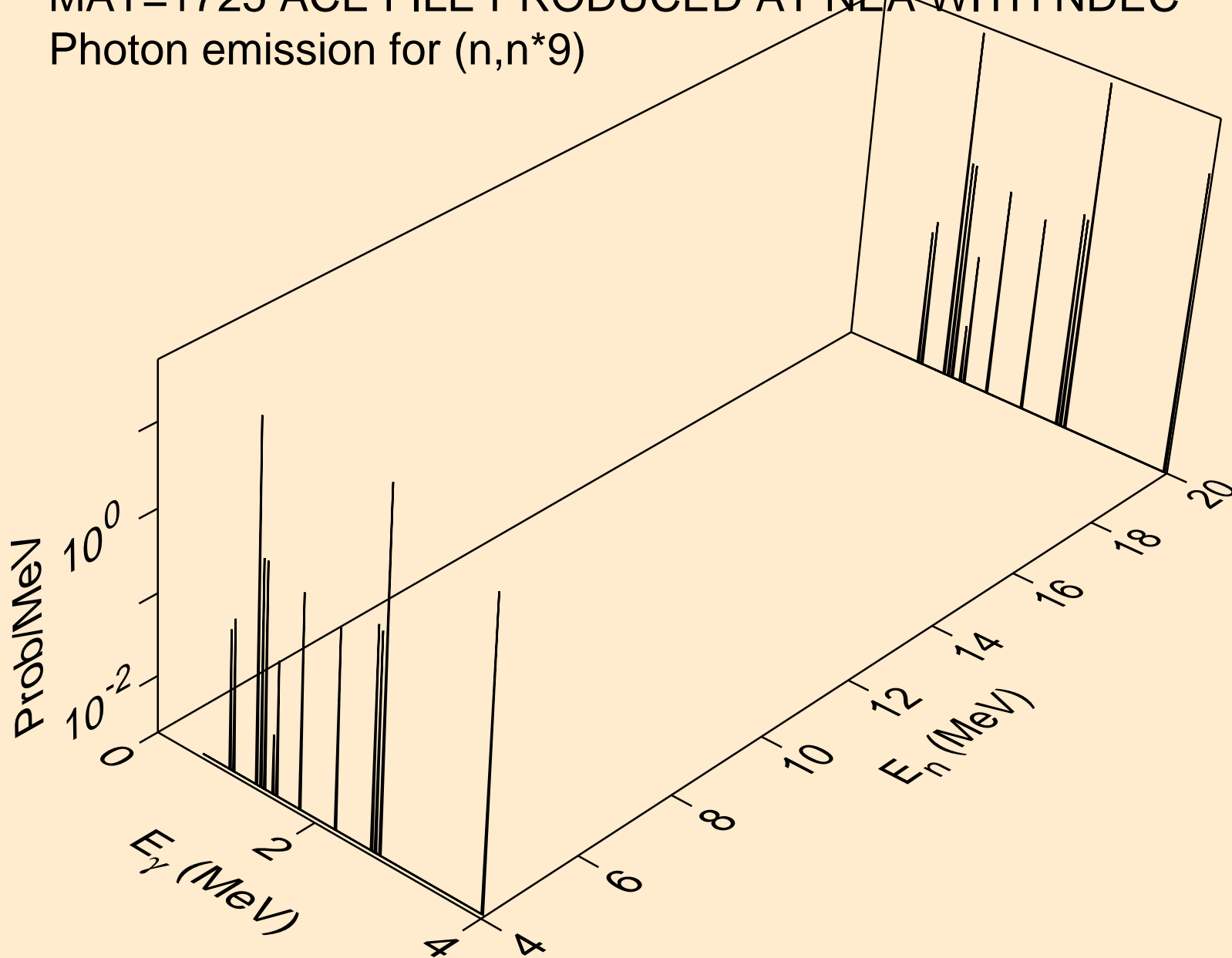

MAT=1725 ACE FILE PRODUCED AT NEA WITH NDEC
Photon emission for (n,n*10)

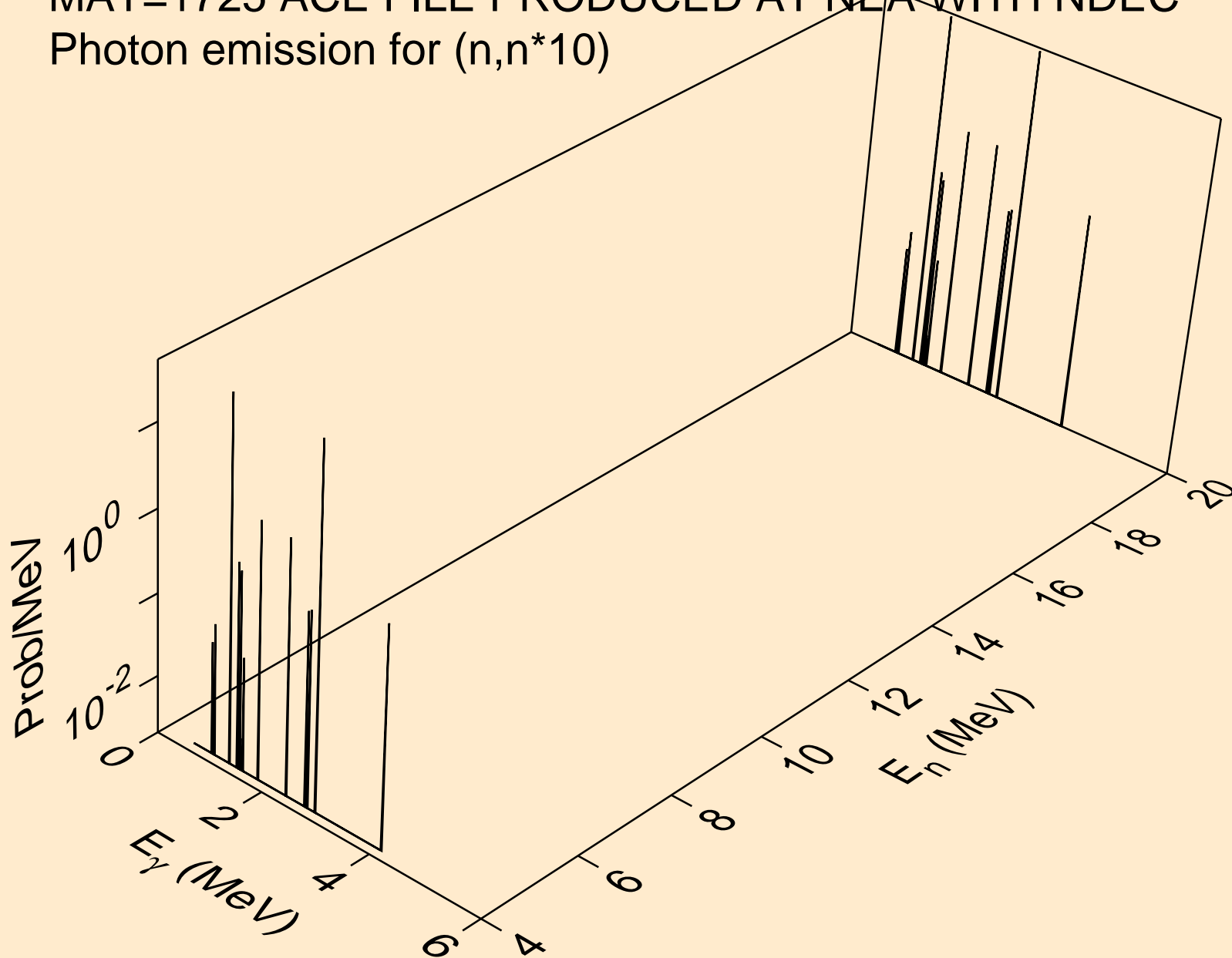

MAT=1725 ACE FILE PRODUCED AT NEA WITH NDEC
Photon emission for (n,n*11)

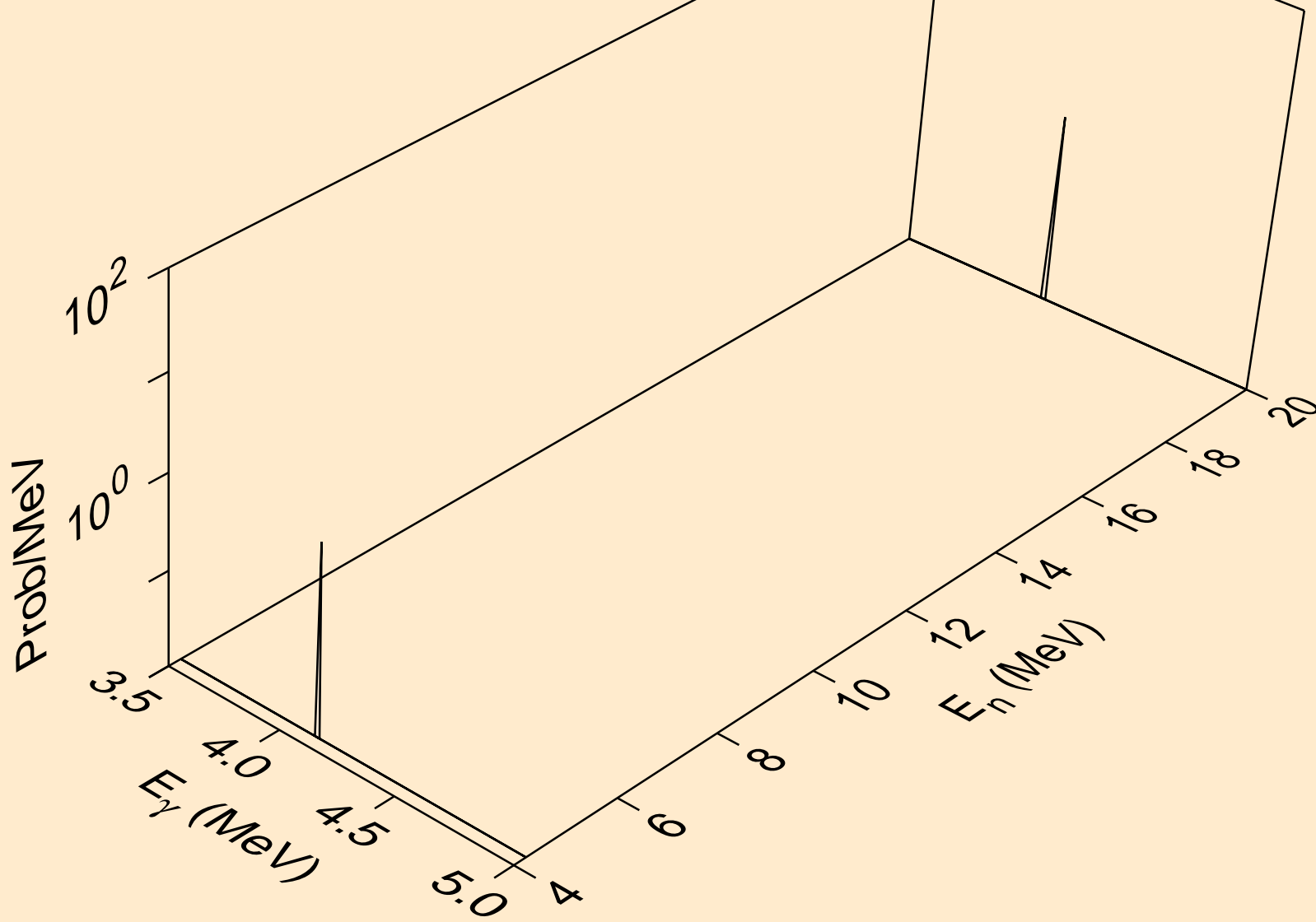

MAT=1725 ACE FILE PRODUCED AT NEA WITH NDEC
Photon emission for (n,n*12)

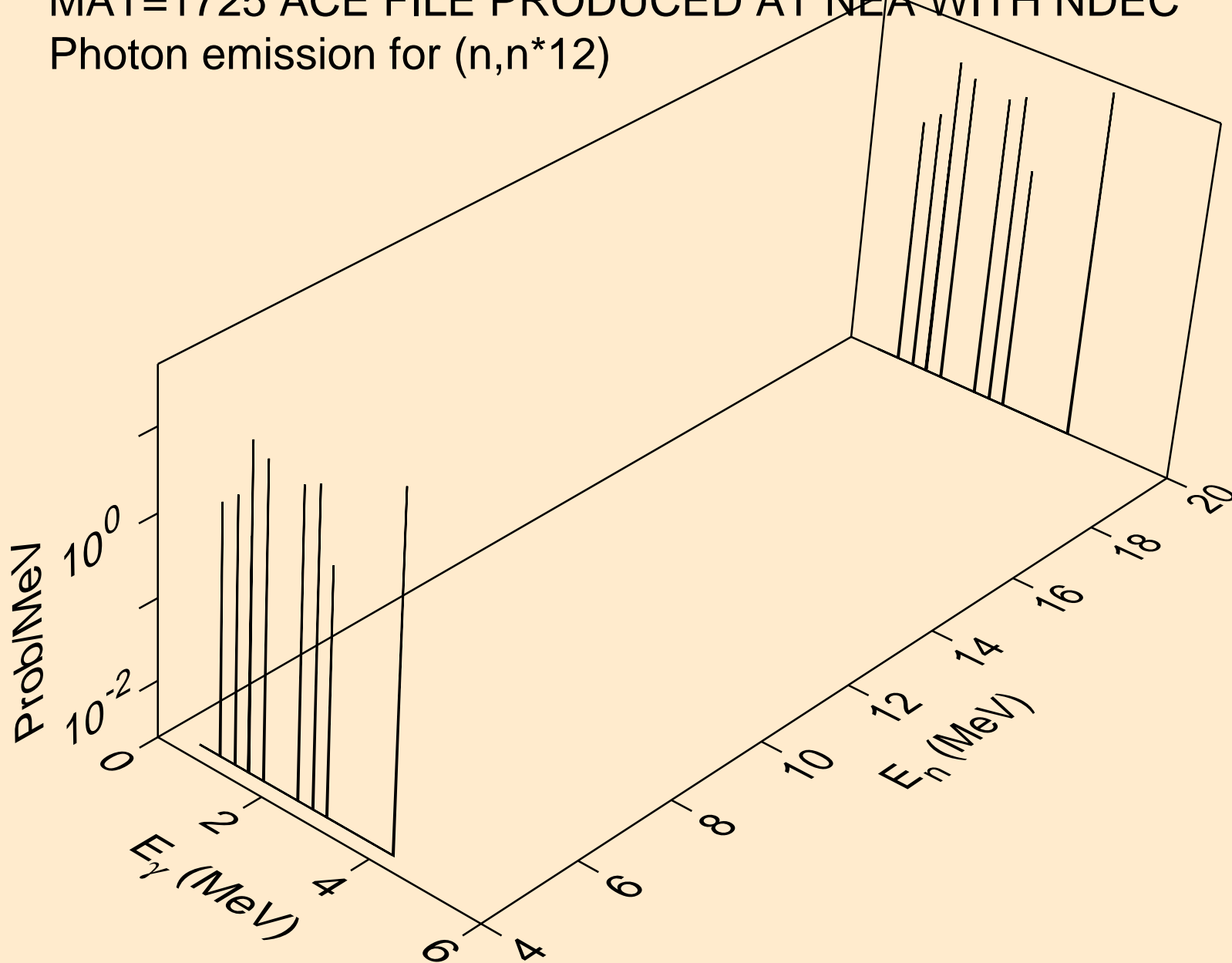

MAT=1725 ACE FILE PRODUCED AT NEA WITH NDEC
Photon emission for (n,n*13)

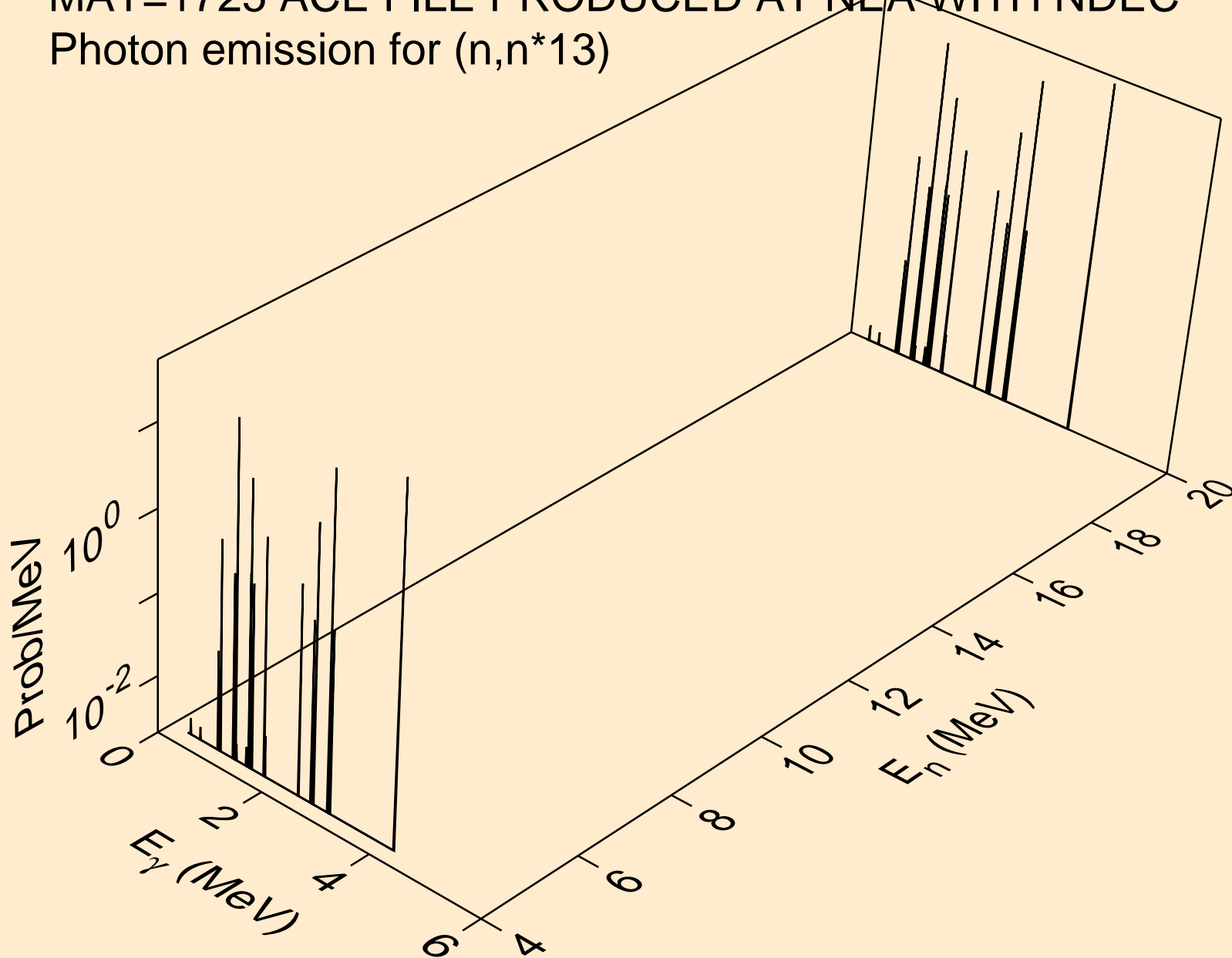

MAT=1725 ACE FILE PRODUCED AT NEA WITH NDEC
Photon emission for (n,n*14)

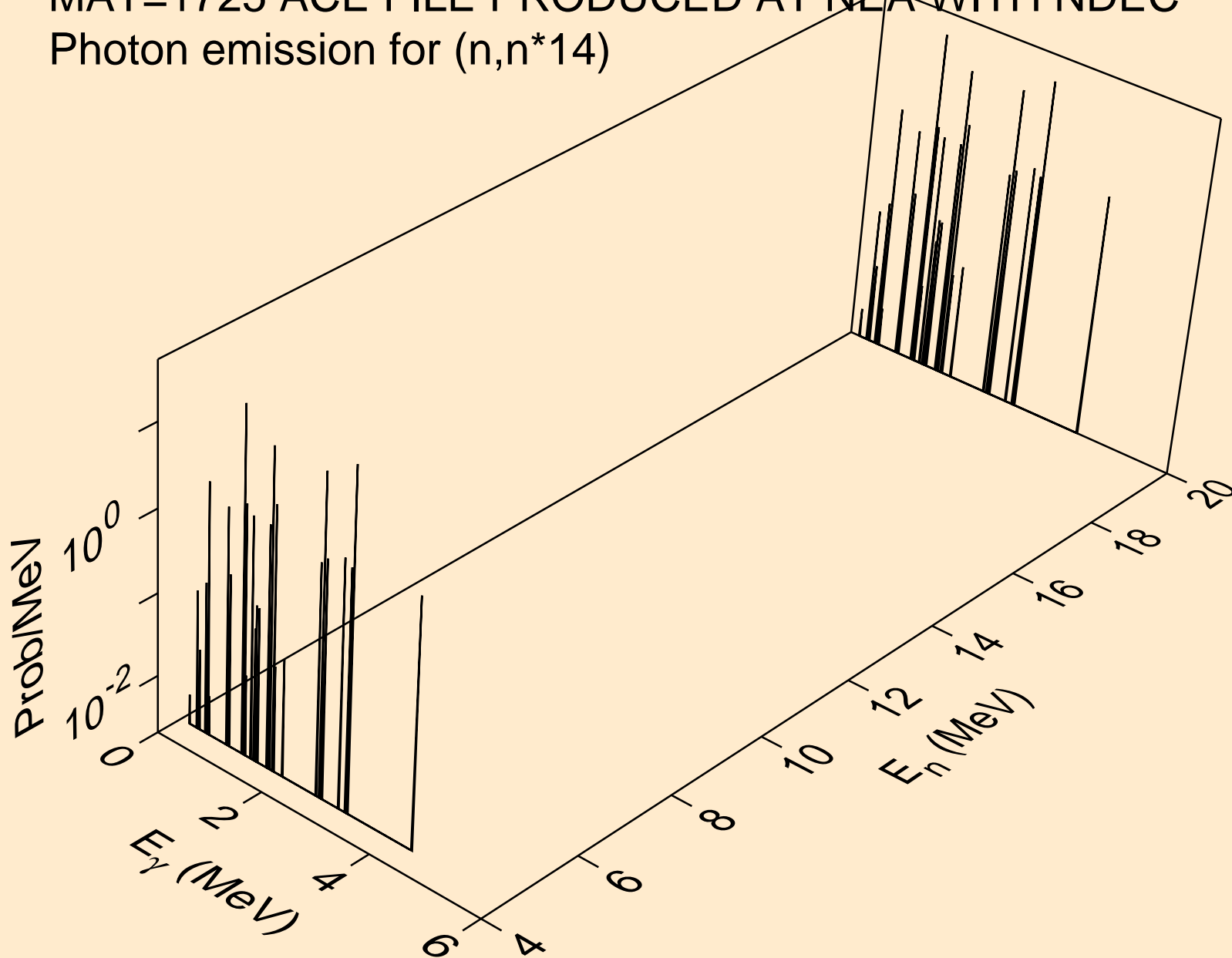

MAT=1725 ACE FILE PRODUCED AT NEA WITH NDEC
Photon emission for (n,n*15)

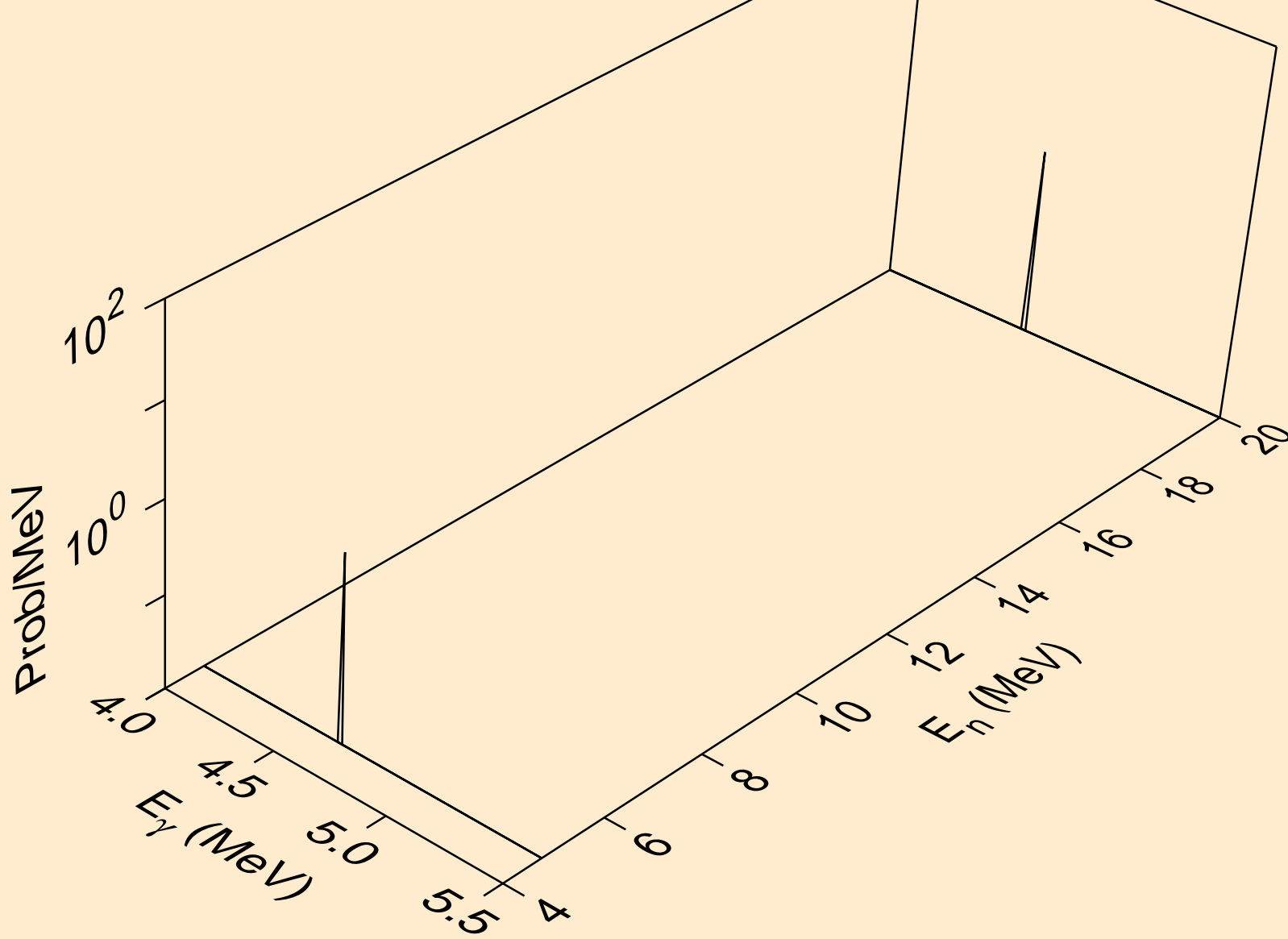

MAT=1725 ACE FILE PRODUCED AT NEA WITH NDEC
Photon emission for (n,n*16)

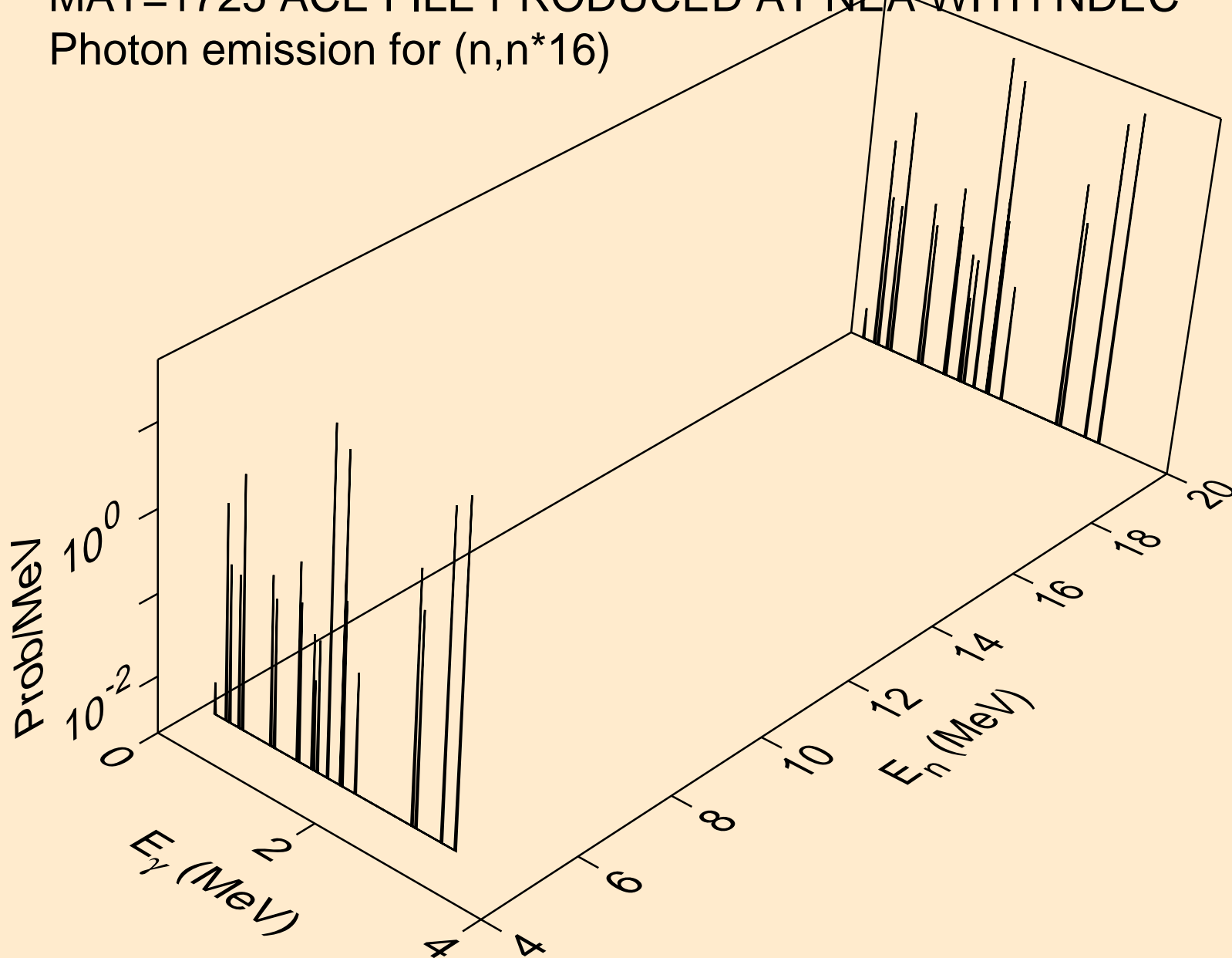

MAT=1725 ACE FILE PRODUCED AT NEA WITH NDEC
Photon emission for (n,n*17)

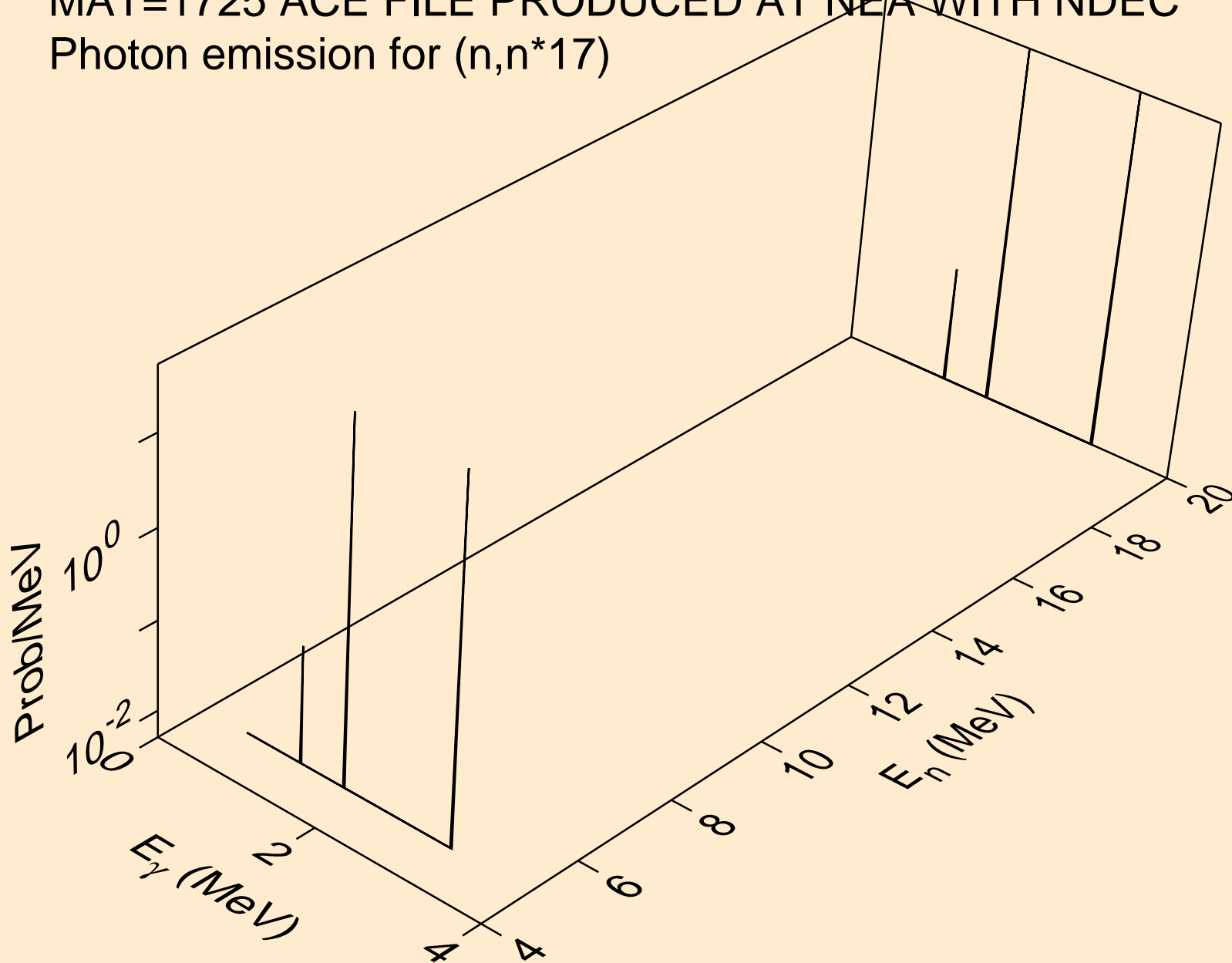

MAT=1725 ACE FILE PRODUCED AT NEA WITH NDEC
Photon emission for (n,n*18)

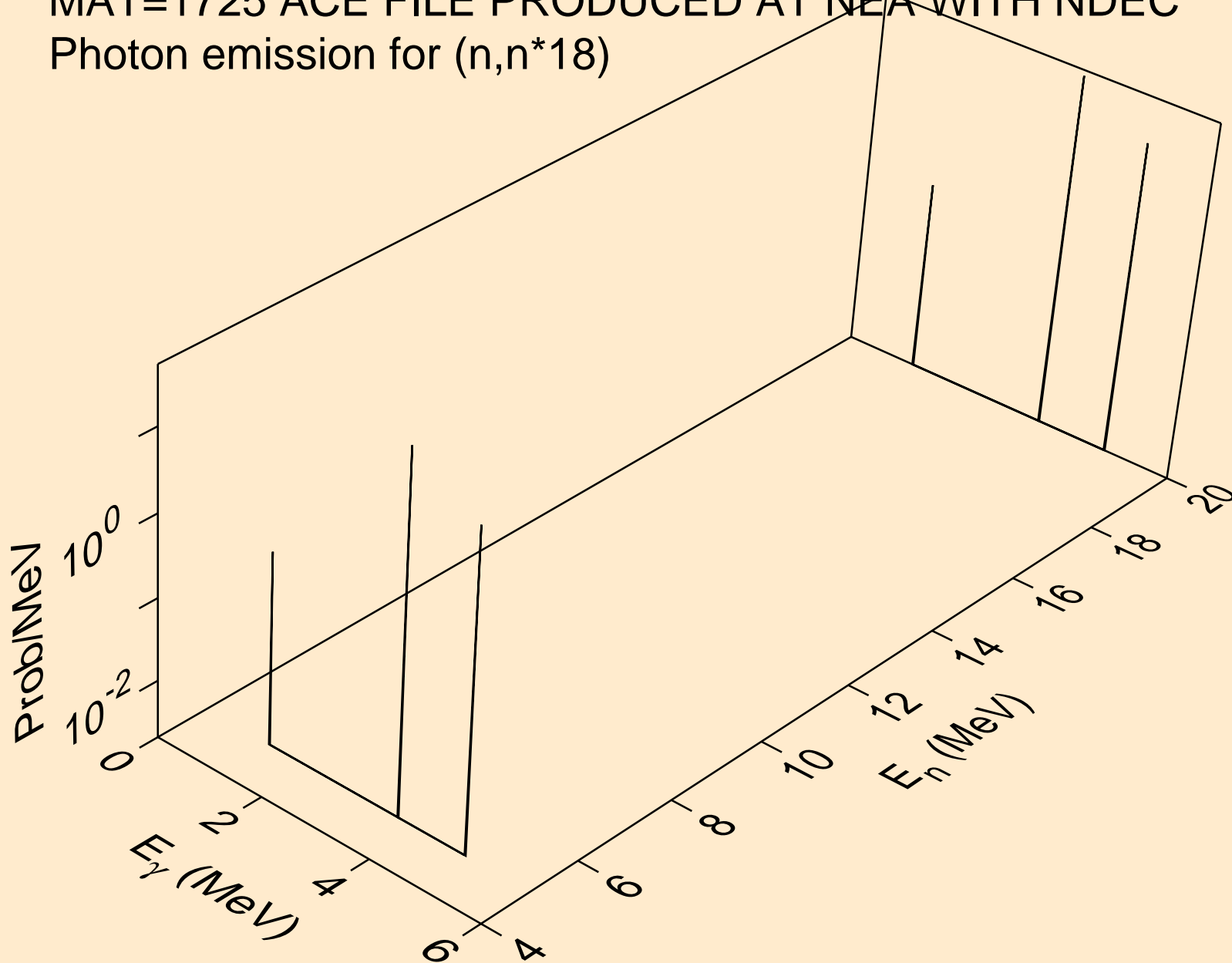

MAT=1725 ACE FILE PRODUCED AT NEA WITH NDEC
Photon emission for (n,n*19)

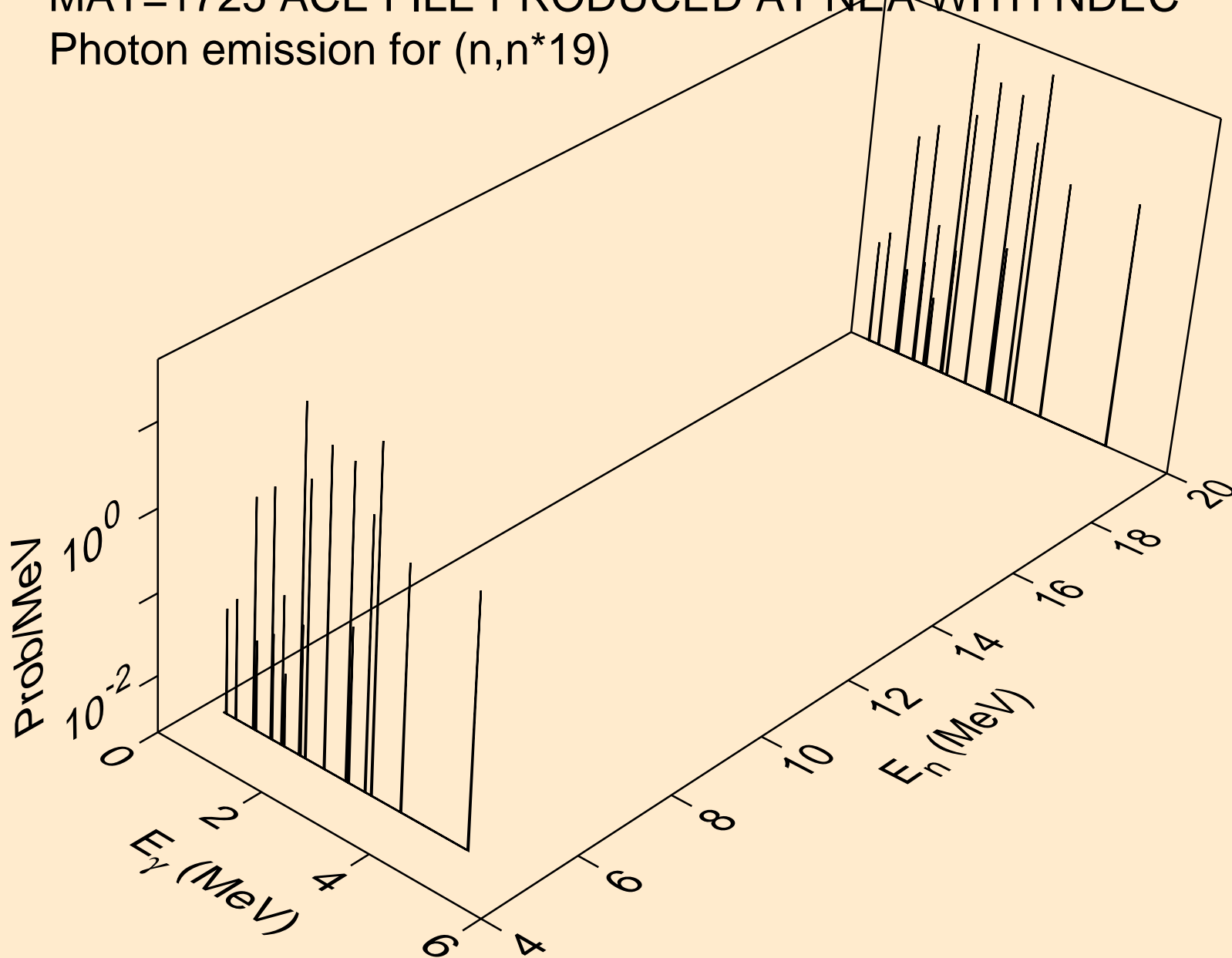

MAT=1725 ACE FILE PRODUCED AT NEA WITH NDEC
Photon emission for (n,n*20)

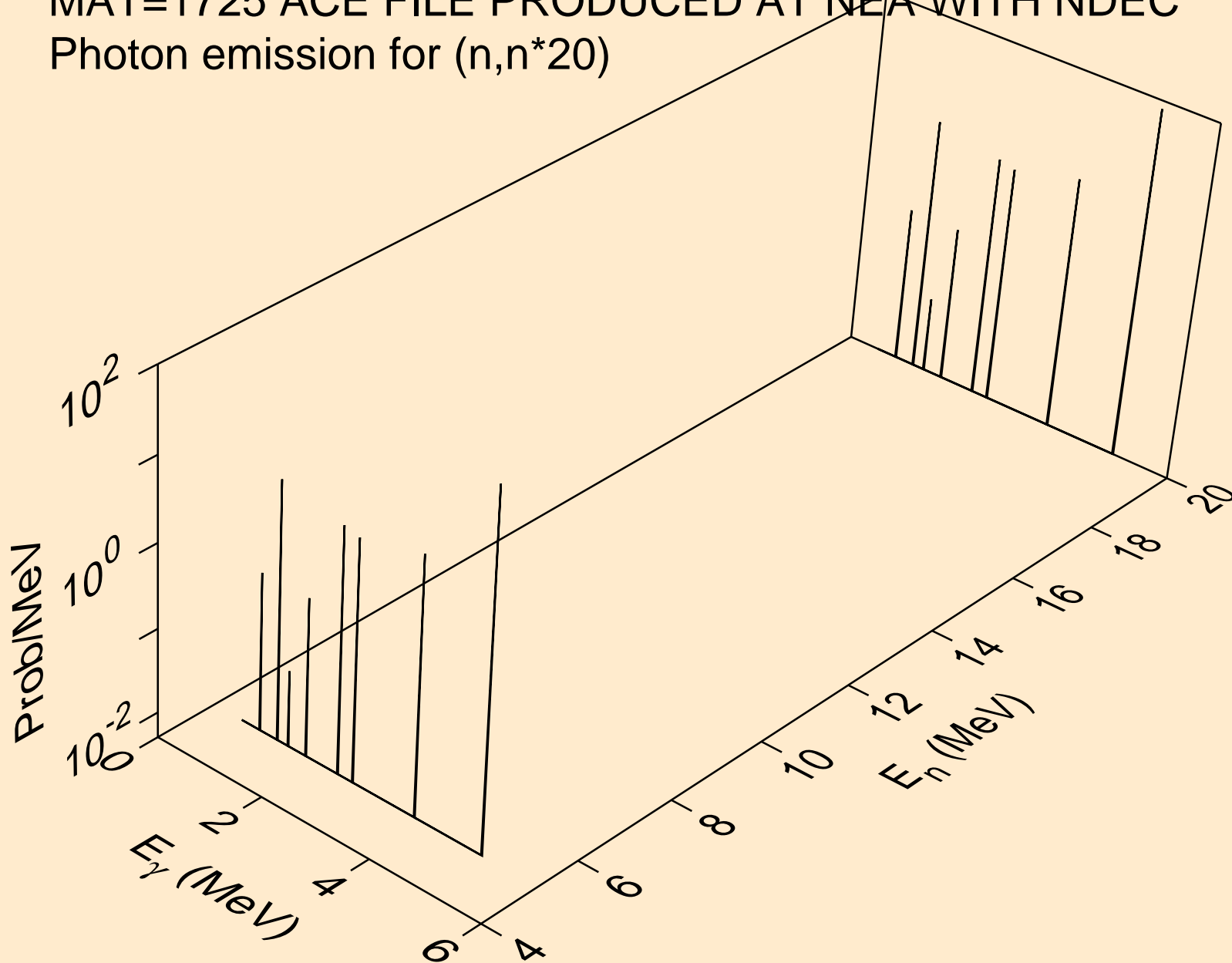

MAT=1725 ACE FILE PRODUCED AT NEA WITH NDEC
Photon emission for (n,n*21)

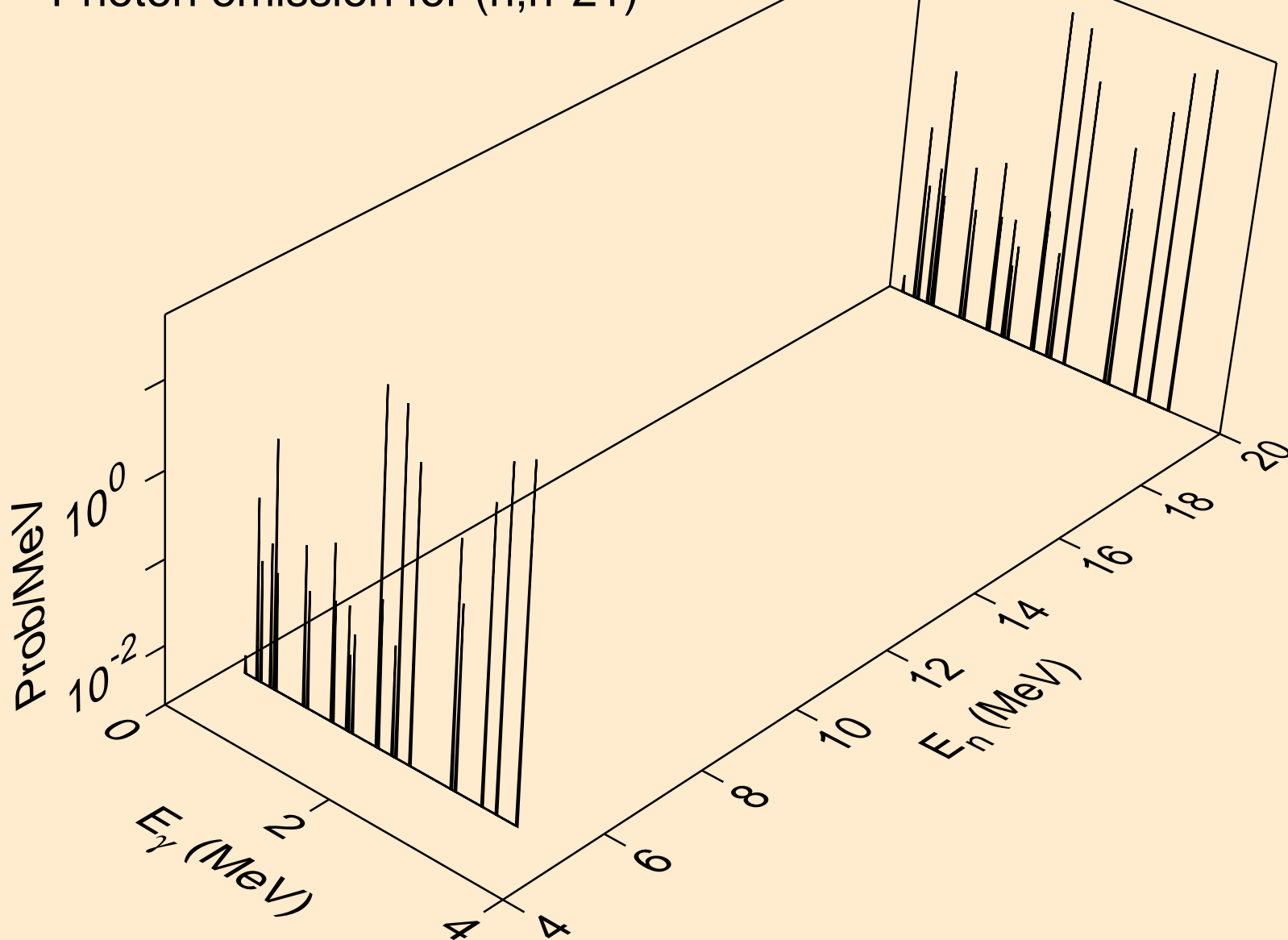

MAT=1725 ACE FILE PRODUCED AT NEA WITH NDEC
Photon emission for (n,n*22)

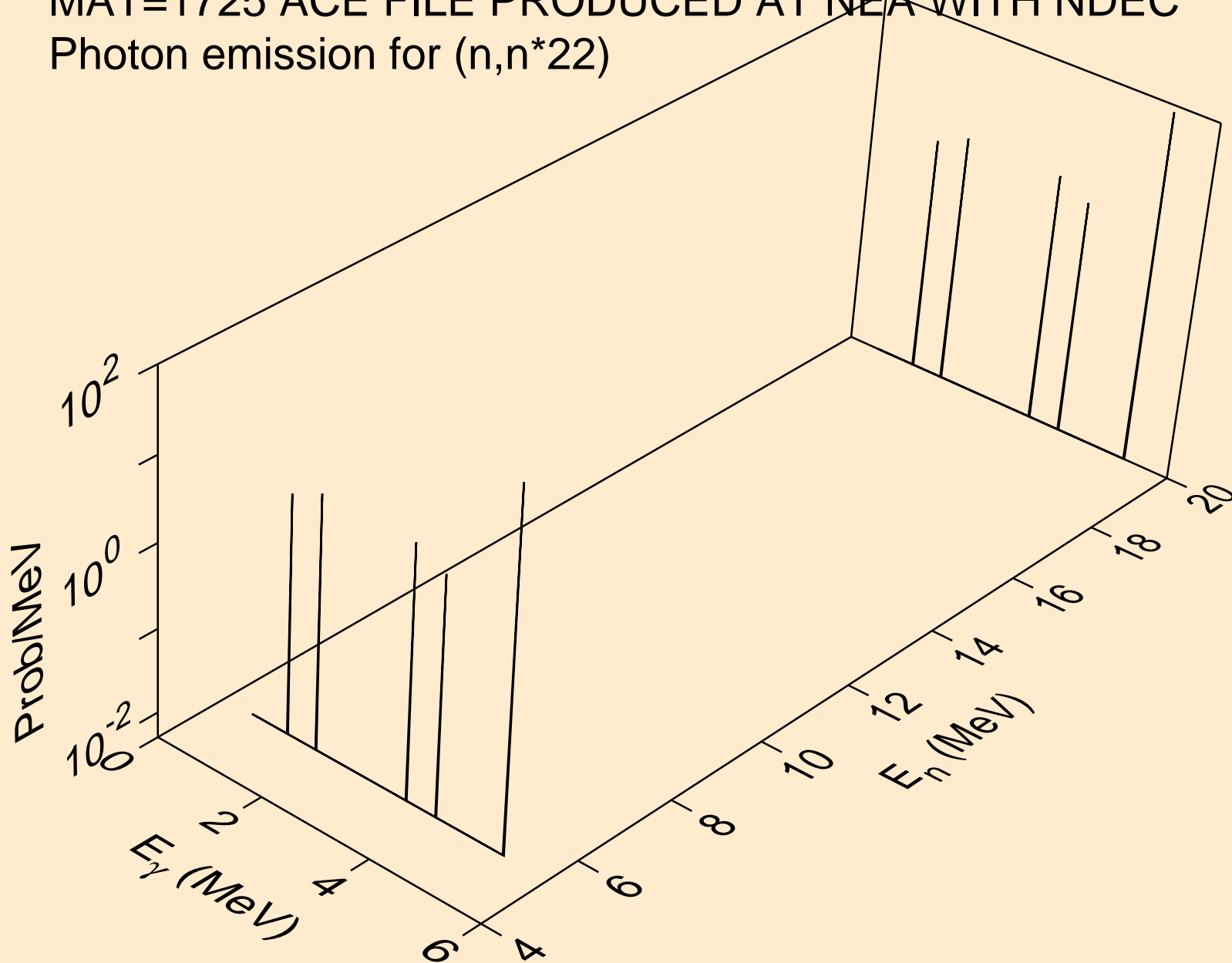

MAT=1725 ACE FILE PRODUCED AT NEA WITH NDEC
Photon emission for (n,n*23)

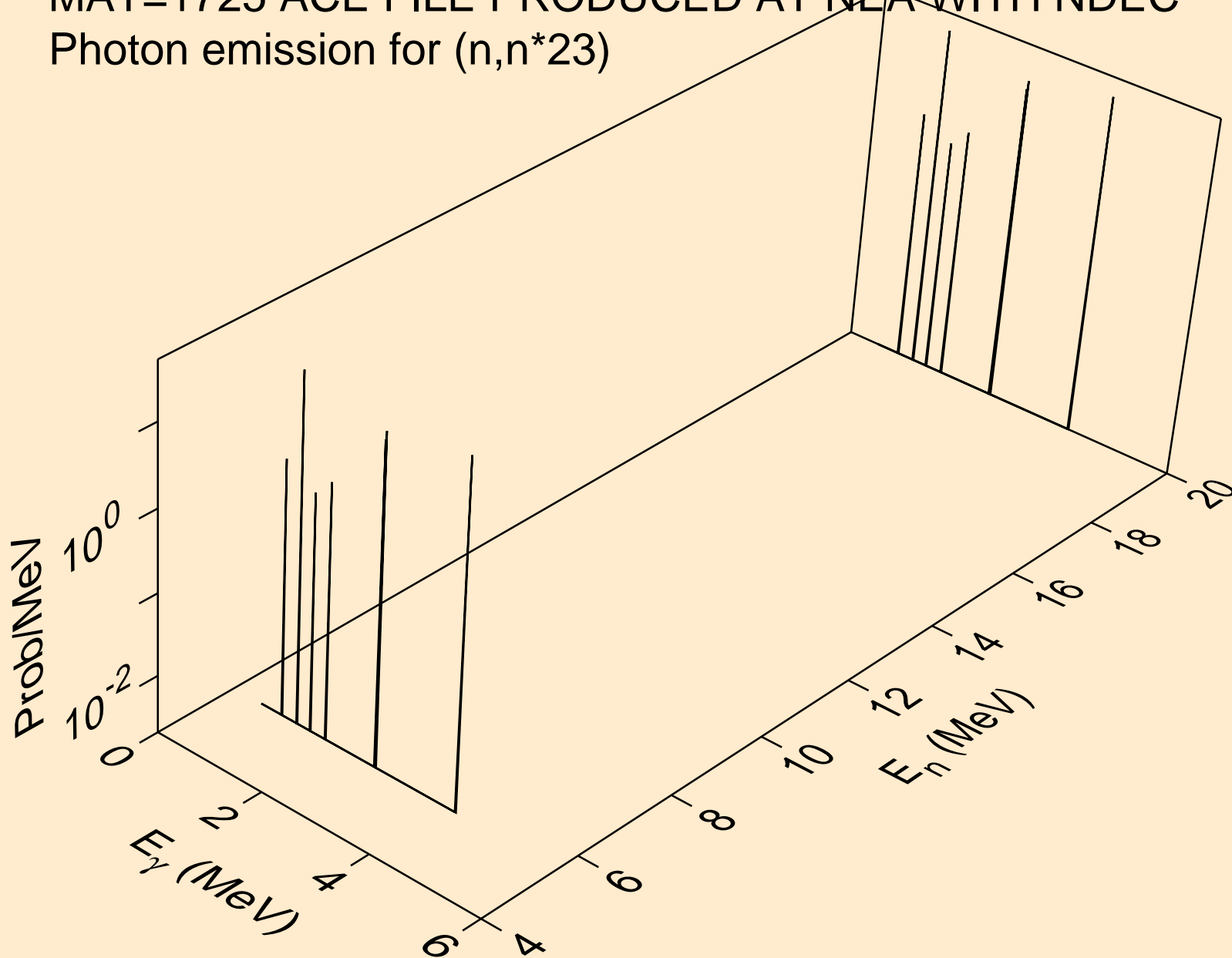

MAT=1725 ACE FILE PRODUCED AT NEA WITH NDEC
Photon emission for (n,n*24)

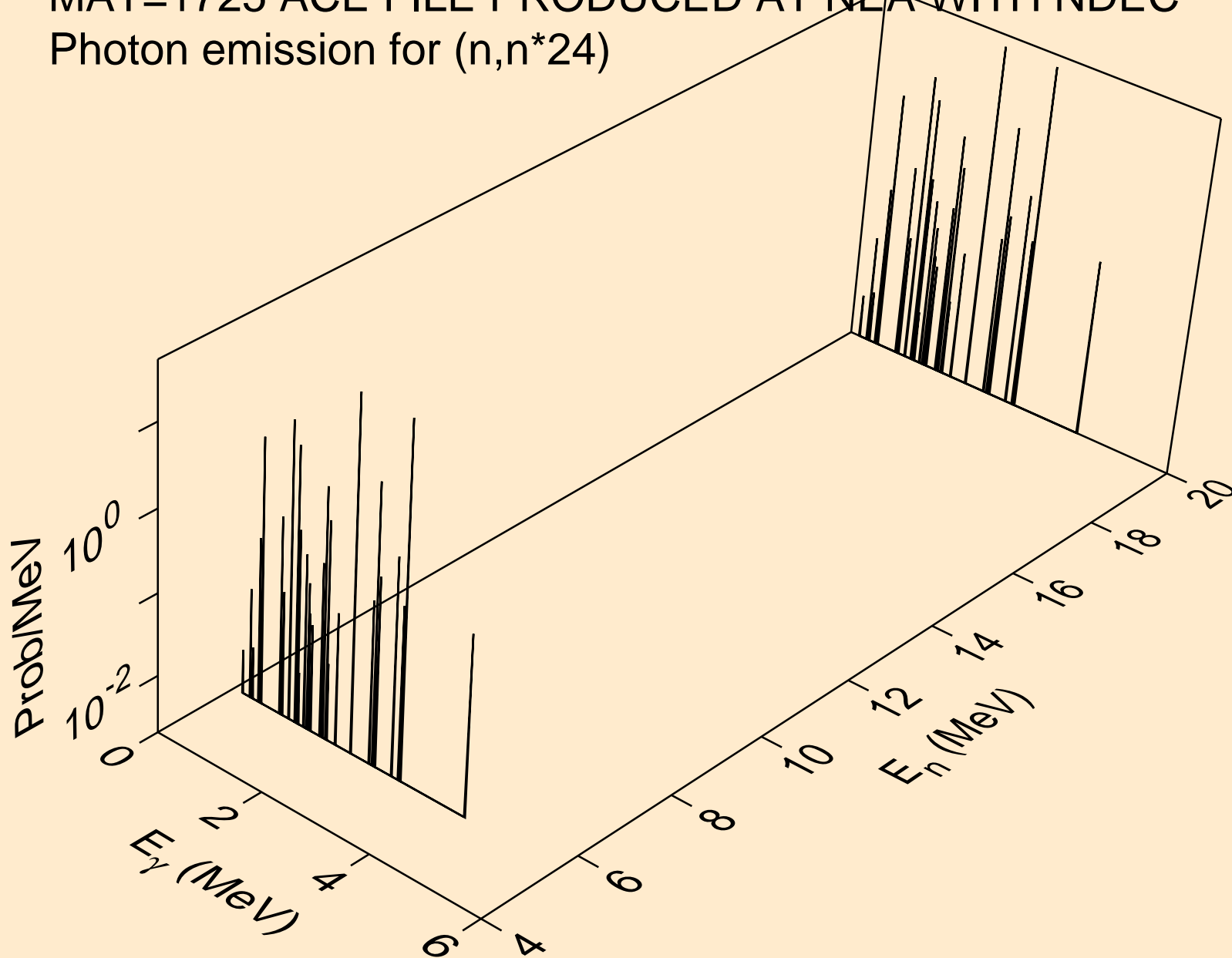

MAT=1725 ACE FILE PRODUCED AT NEA WITH NDEC
Photon emission for (n,n*25)

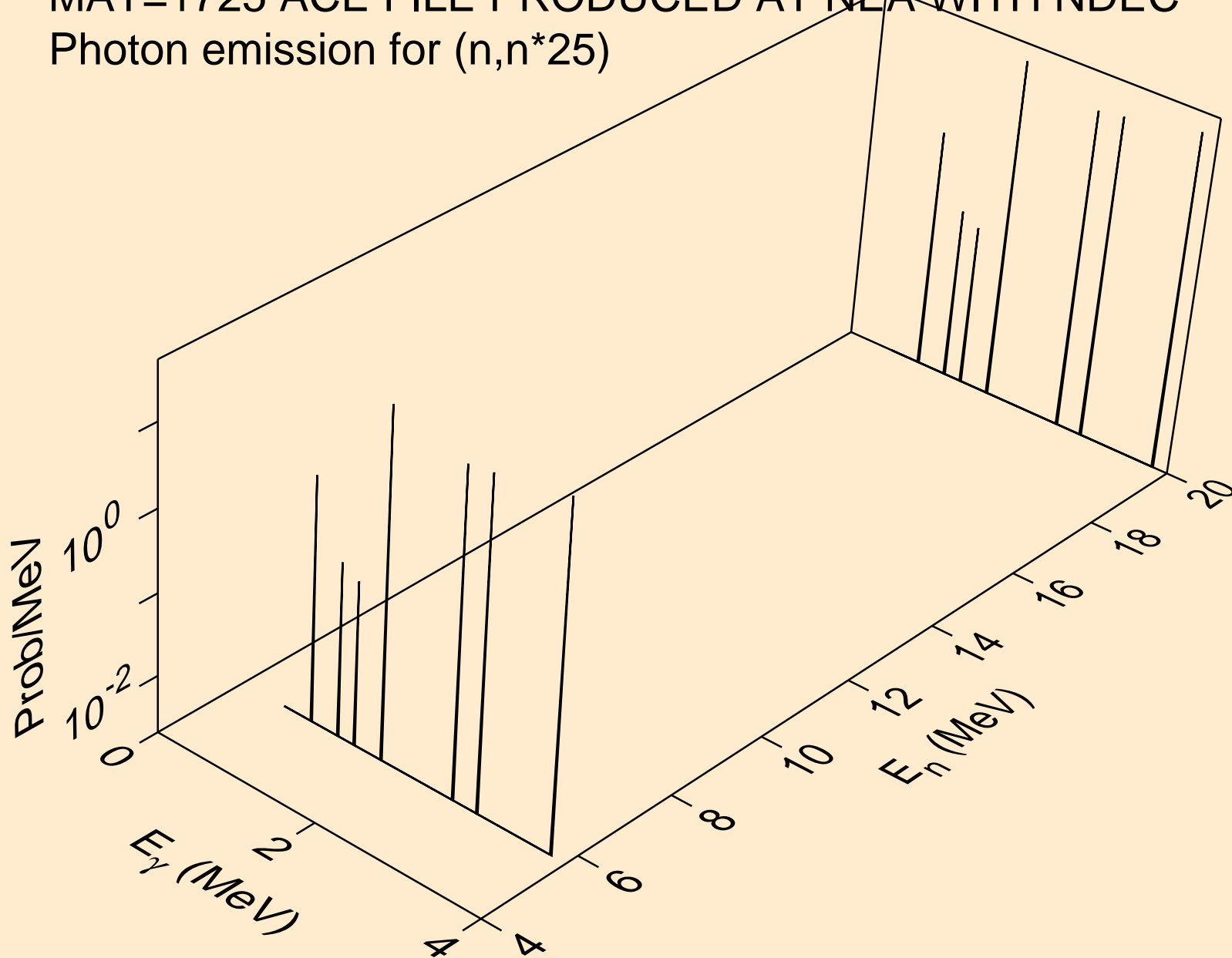

MAT=1725 ACE FILE PRODUCED AT NEA WITH NDEC
Photon emission for (n,n*26)

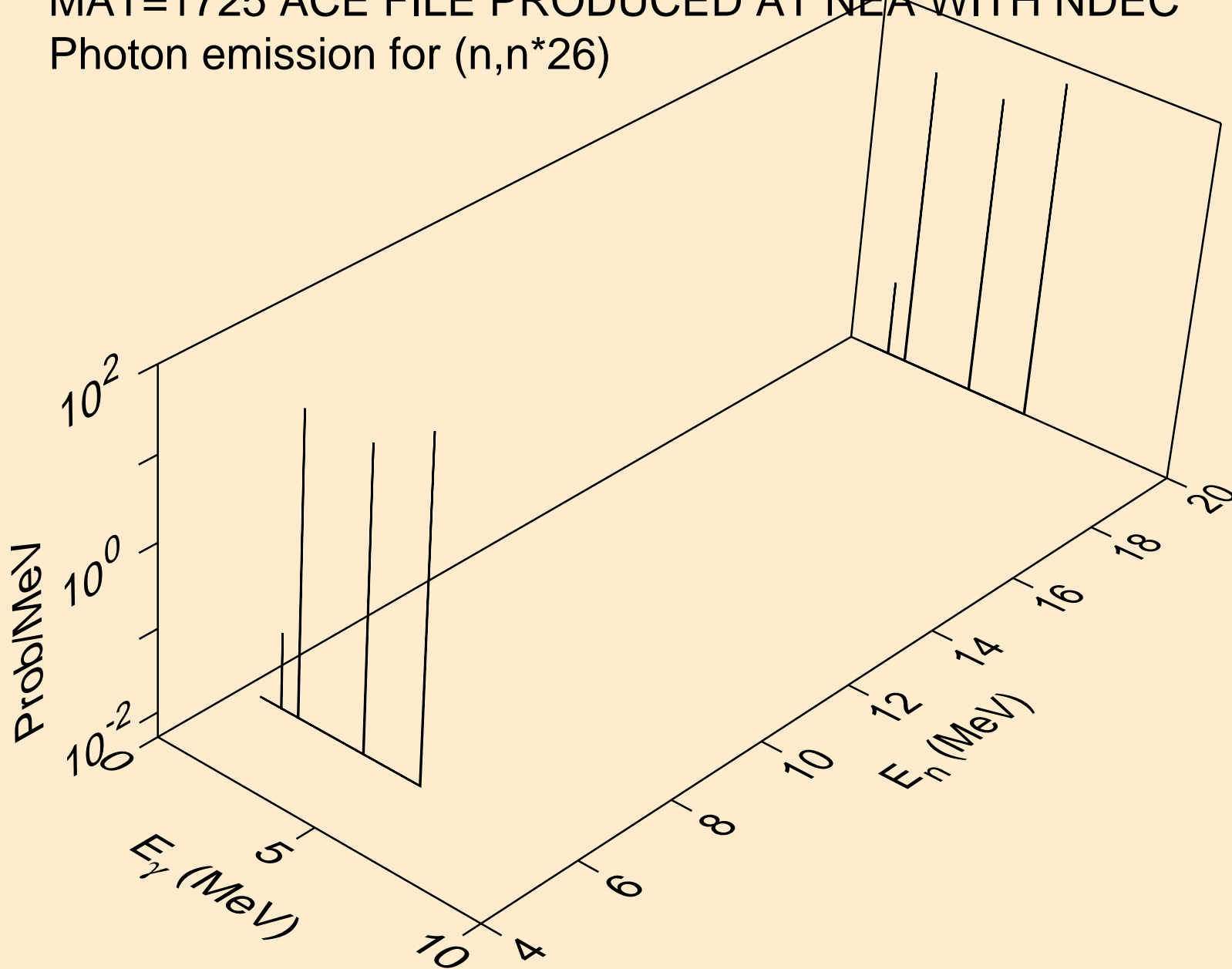

MAT=1725 ACE FILE PRODUCED AT NEA WITH NDEC
Photon emission for (n,n*27)

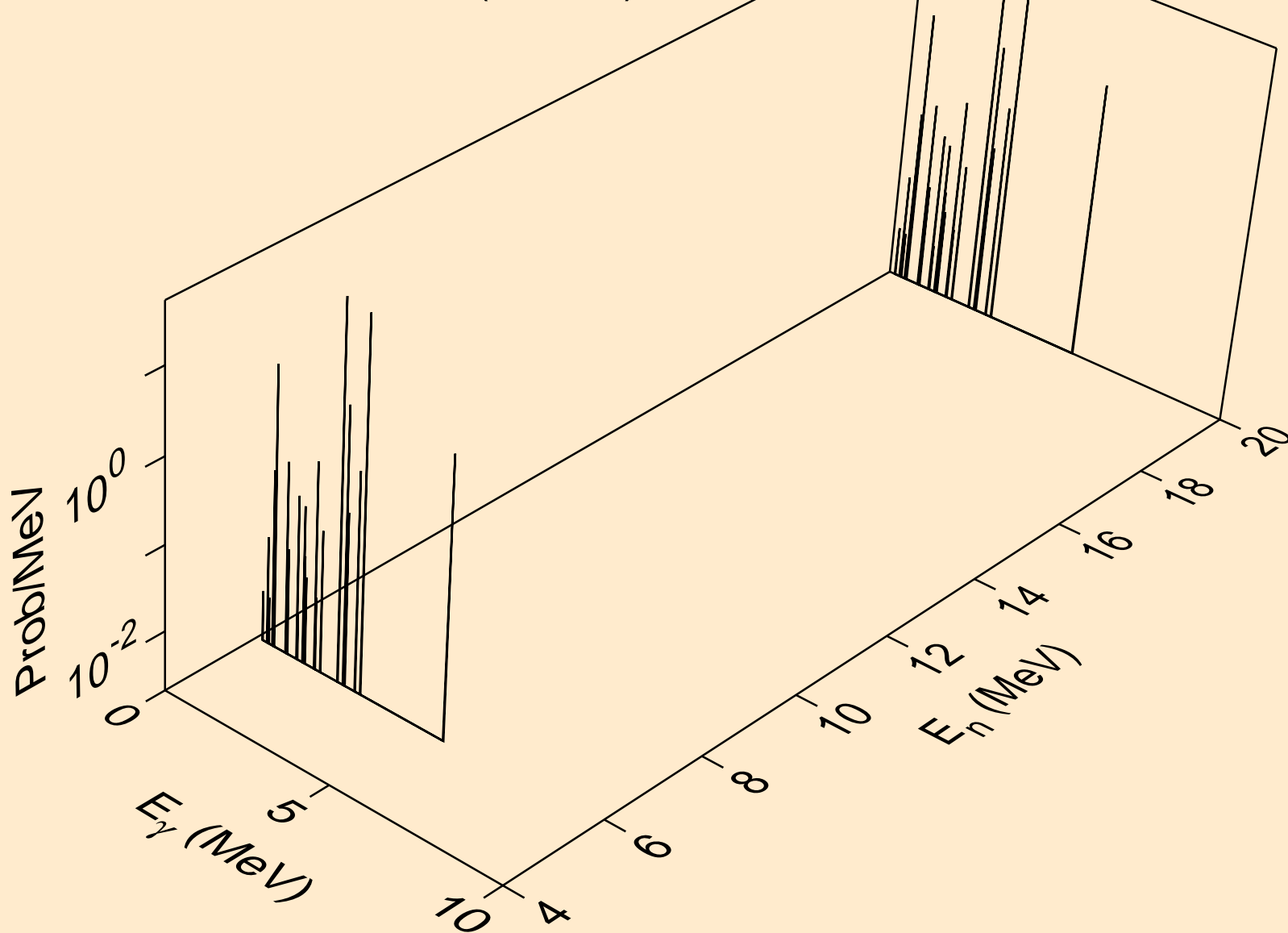

MAT=1725 ACE FILE PRODUCED AT NEA WITH NDEC
Photon emission for (n,n*28)

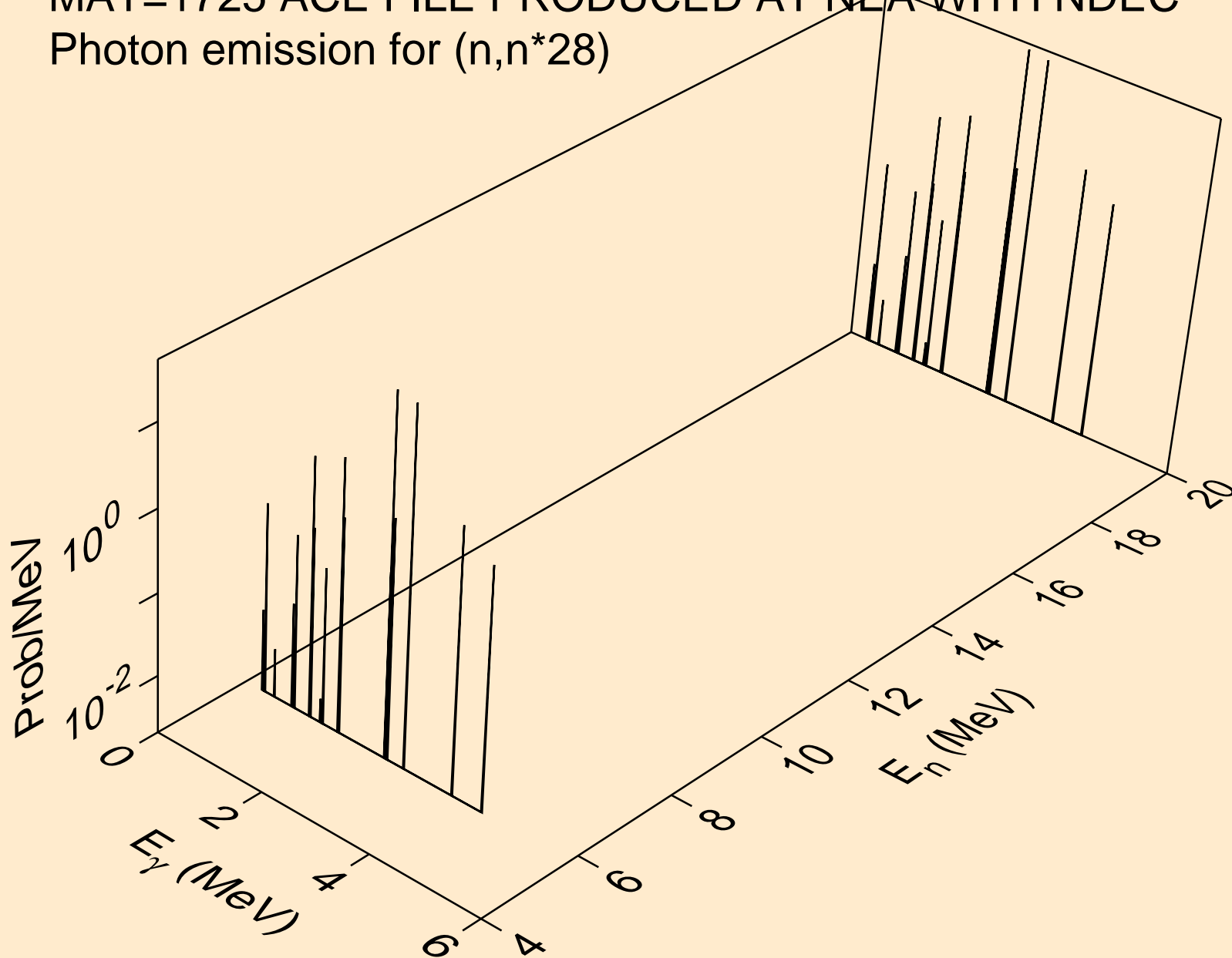

MAT=1725 ACE FILE PRODUCED AT NEA WITH NDEC
Photon emission for (n,n*29)

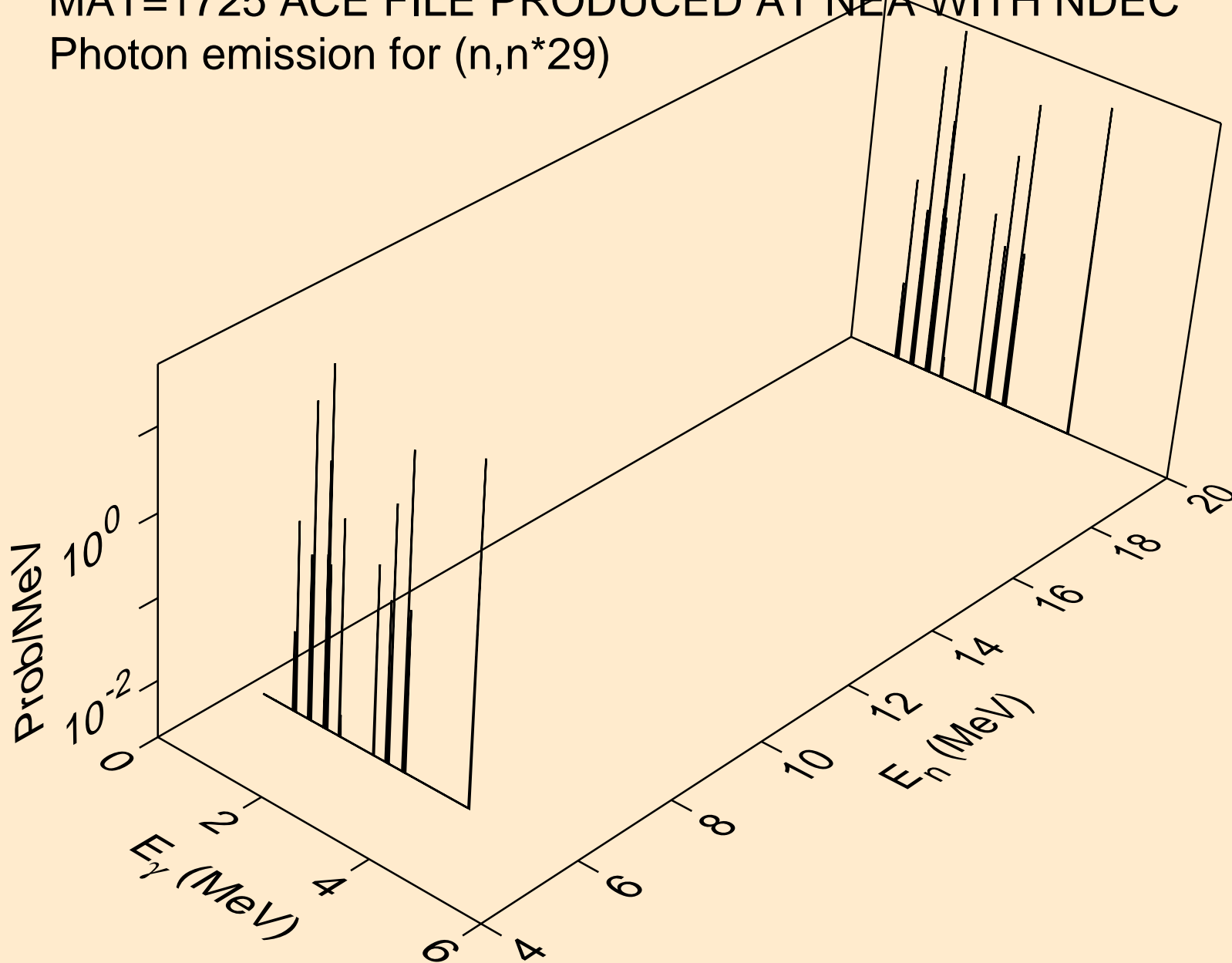

MAT=1725 ACE FILE PRODUCED AT NEA WITH NDEC
Photon emission for (n,n*30)

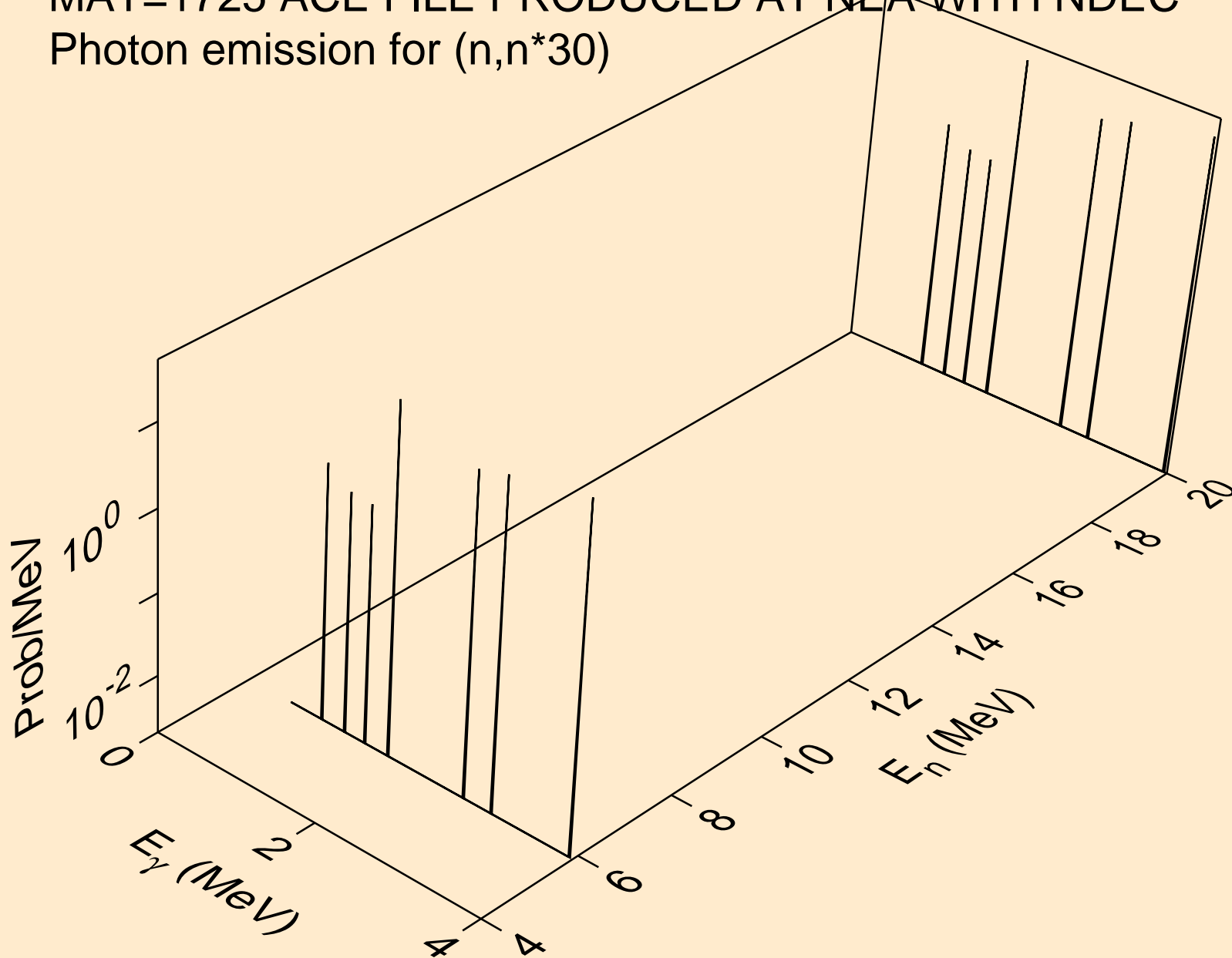

MAT=1725 ACE FILE PRODUCED AT NEA WITH NDEC
Photon emission for (n,n*c)

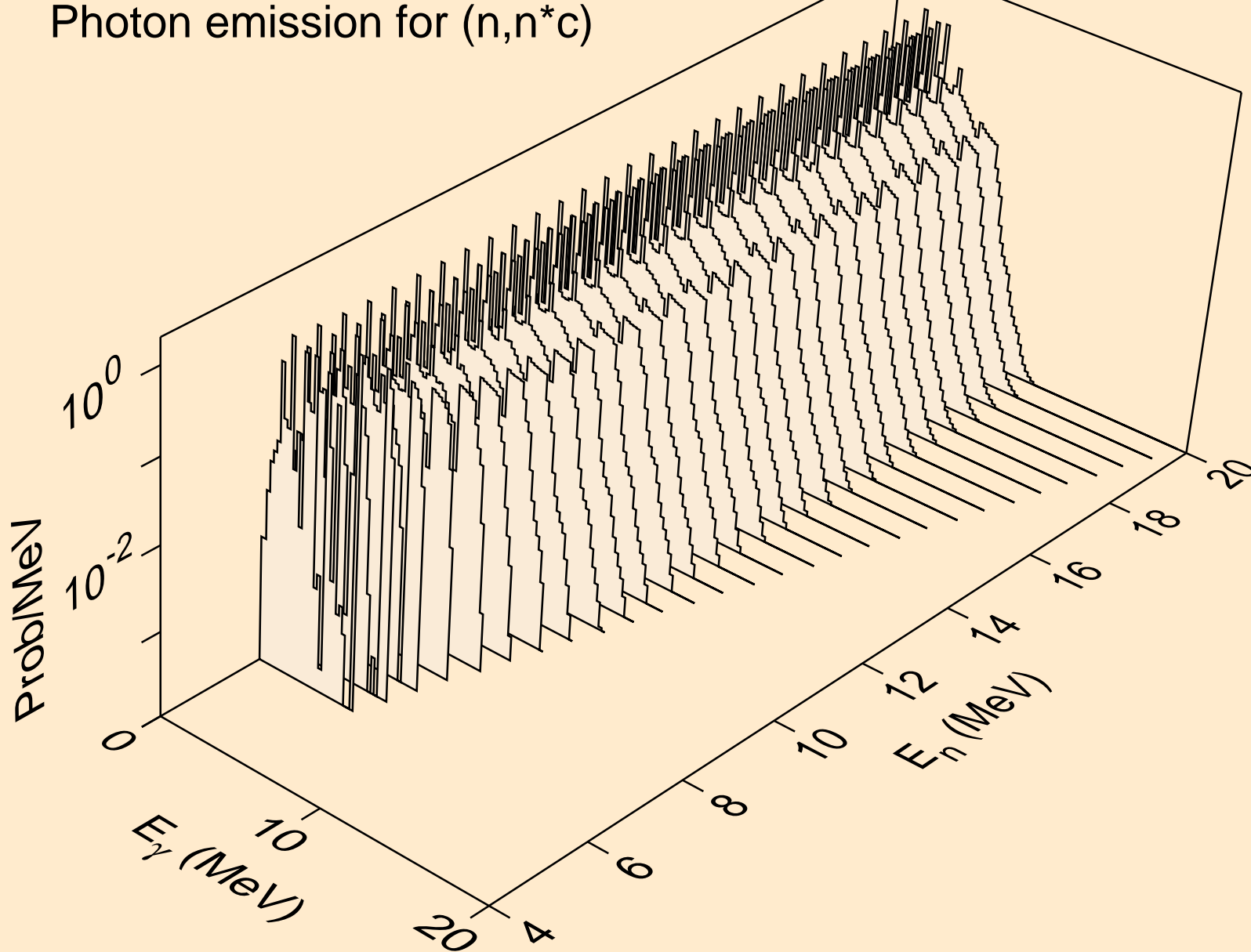

MAT=1725 ACE FILE PRODUCED AT NEA WITH NDEC
Photon emission for (n,2p)

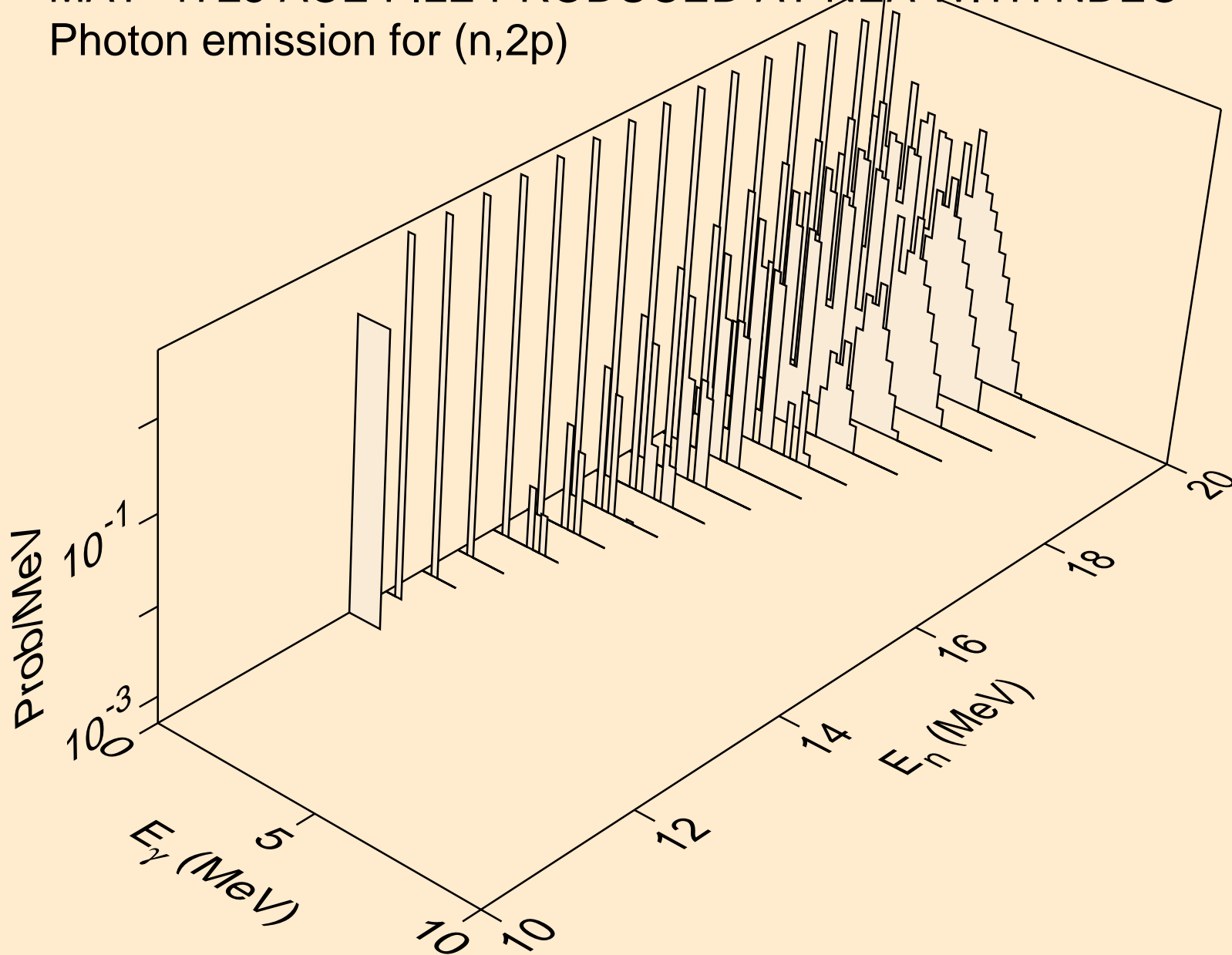

MAT=1725 ACE FILE PRODUCED AT NEA WITH NDEC
Photon emission for (n,pa)

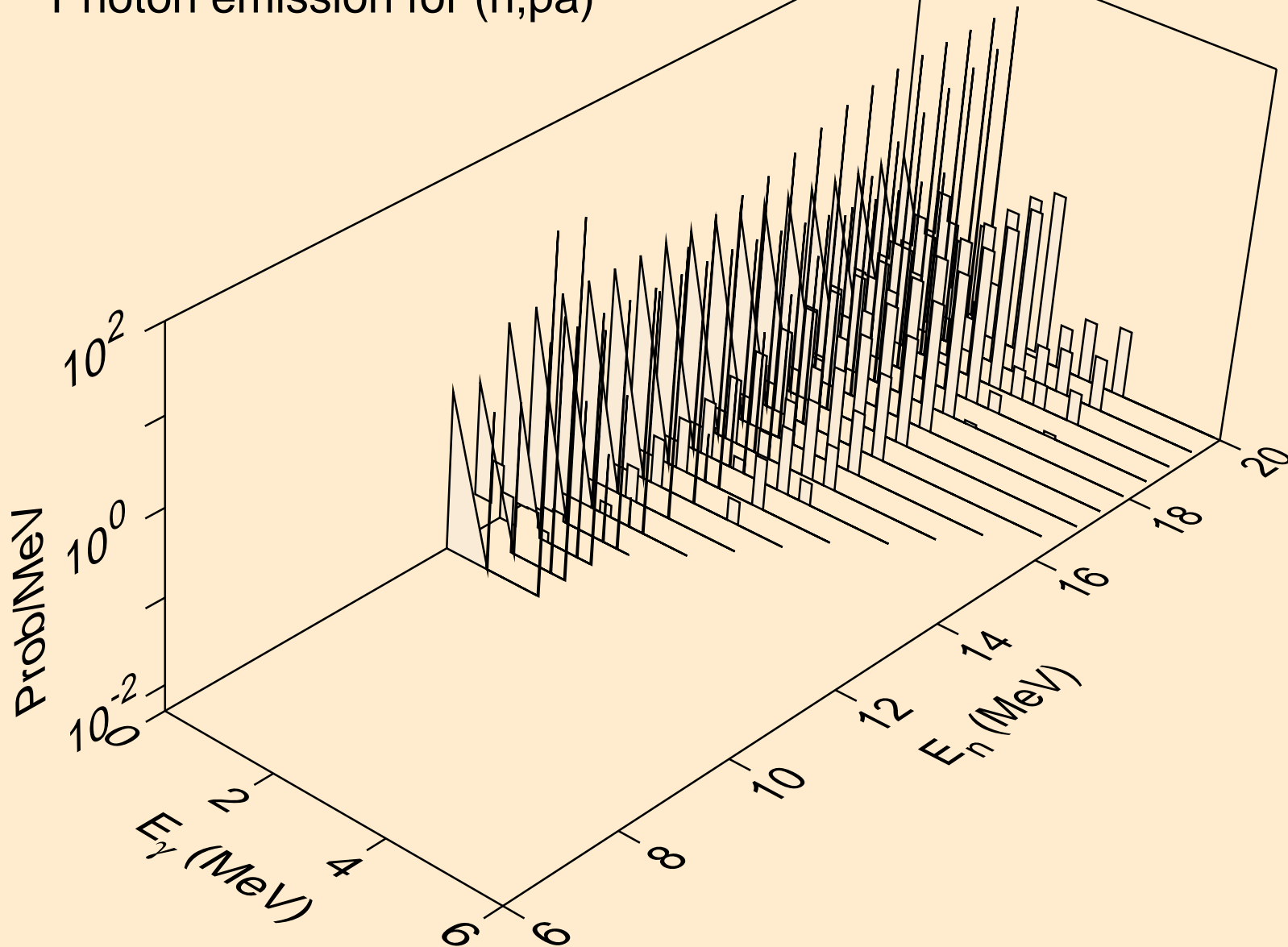

MAT=1725 ACE FILE PRODUCED AT NEA WITH NDEC
Photon emission for (n,p*1)

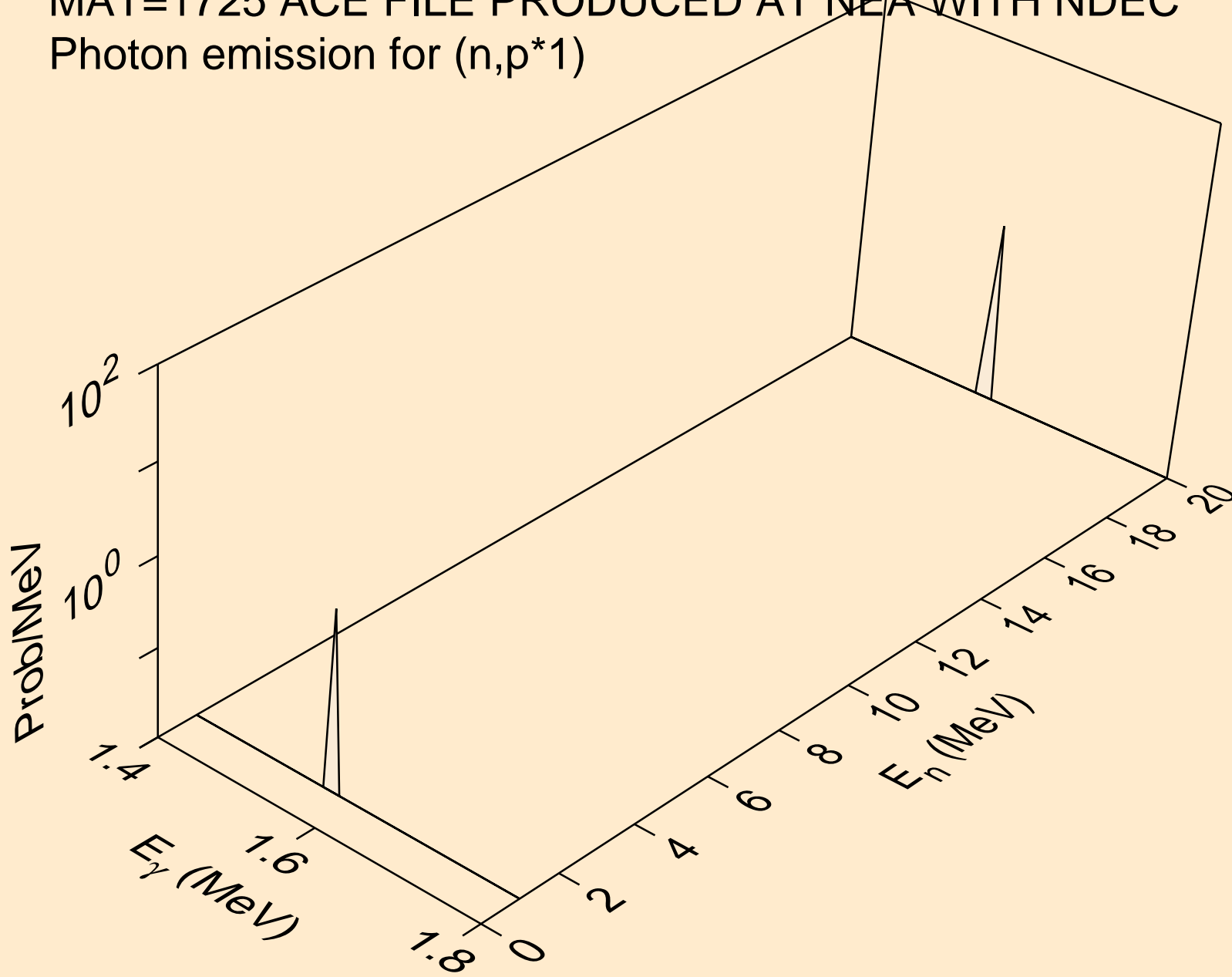

MAT=1725 ACE FILE PRODUCED AT NEA WITH NDEC
Photon emission for (n,p*2)

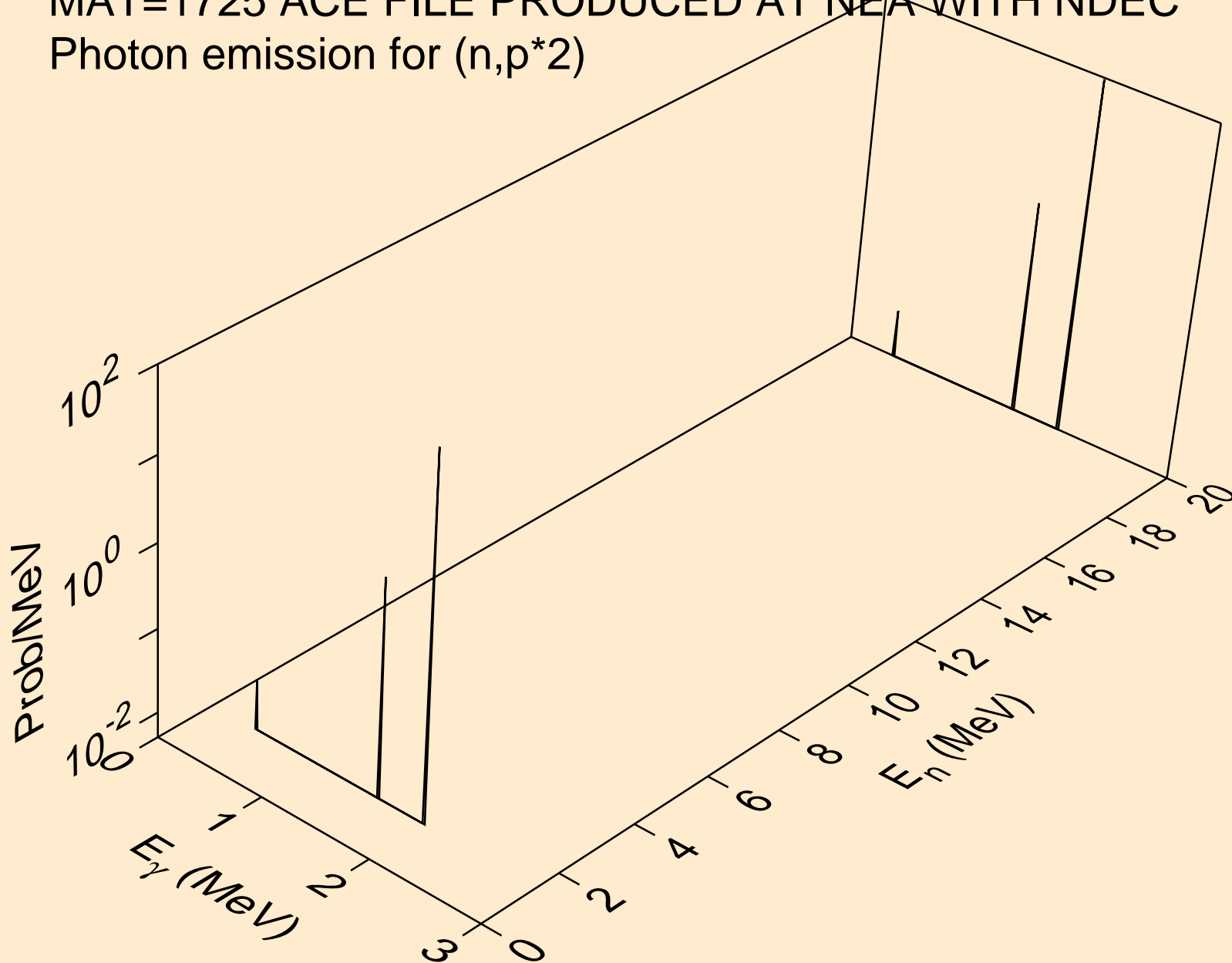

MAT=1725 ACE FILE PRODUCED AT NEA WITH NDEC
Photon emission for (n,p*3)

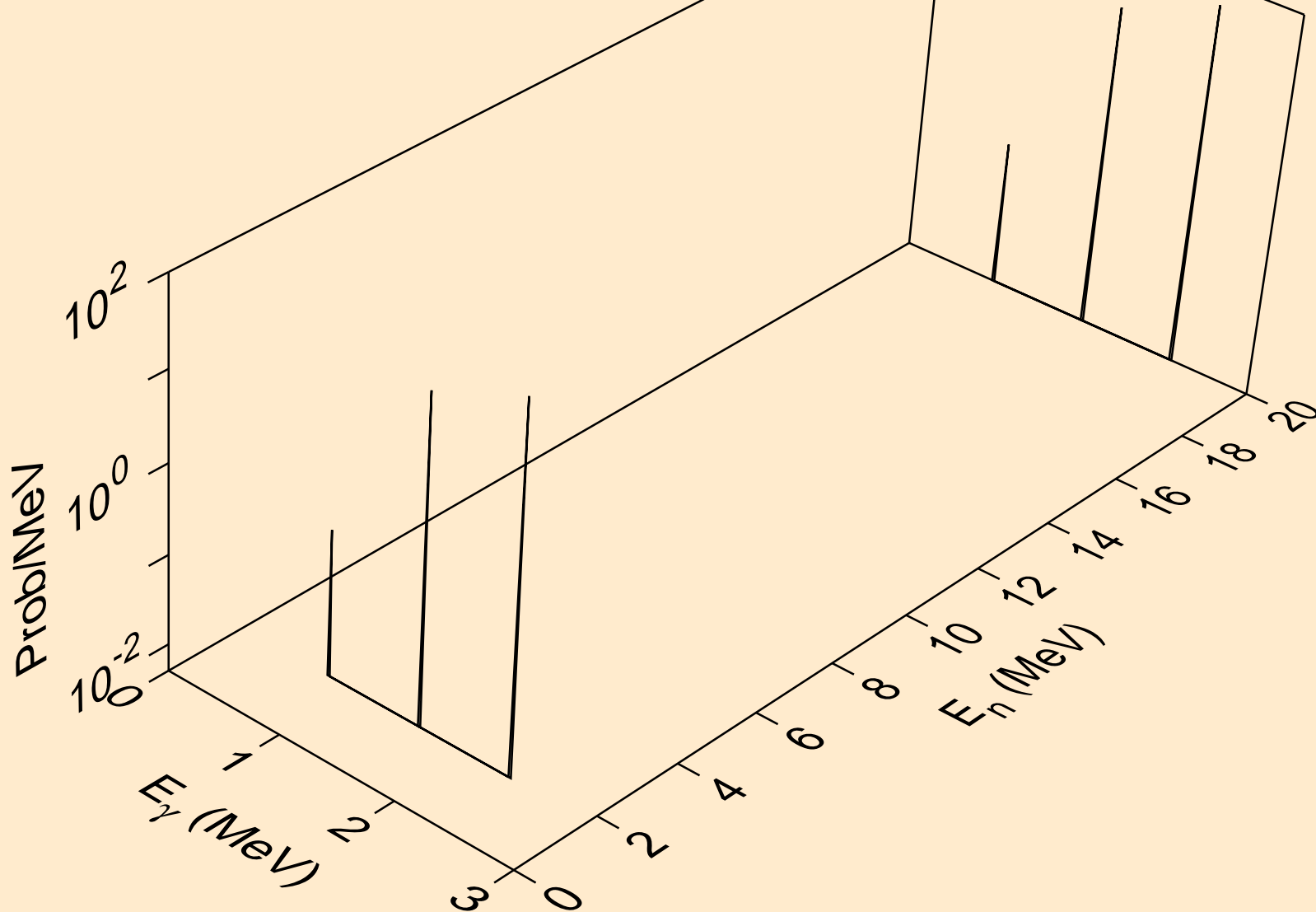

MAT=1725 ACE FILE PRODUCED AT NEA WITH NDEC
Photon emission for (n,p*4)

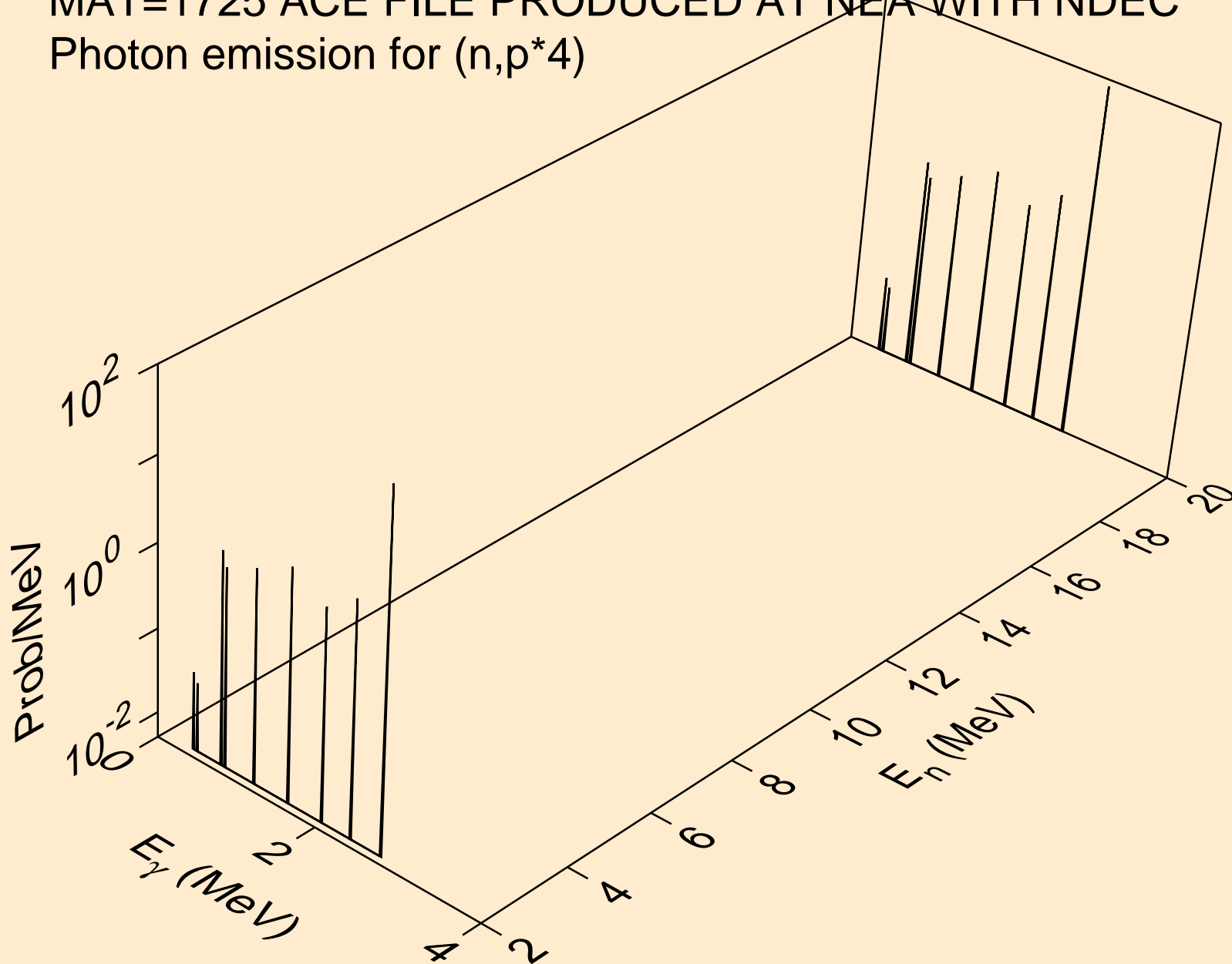

MAT=1725 ACE FILE PRODUCED AT NEA WITH NDEC
Photon emission for (n,p*5)

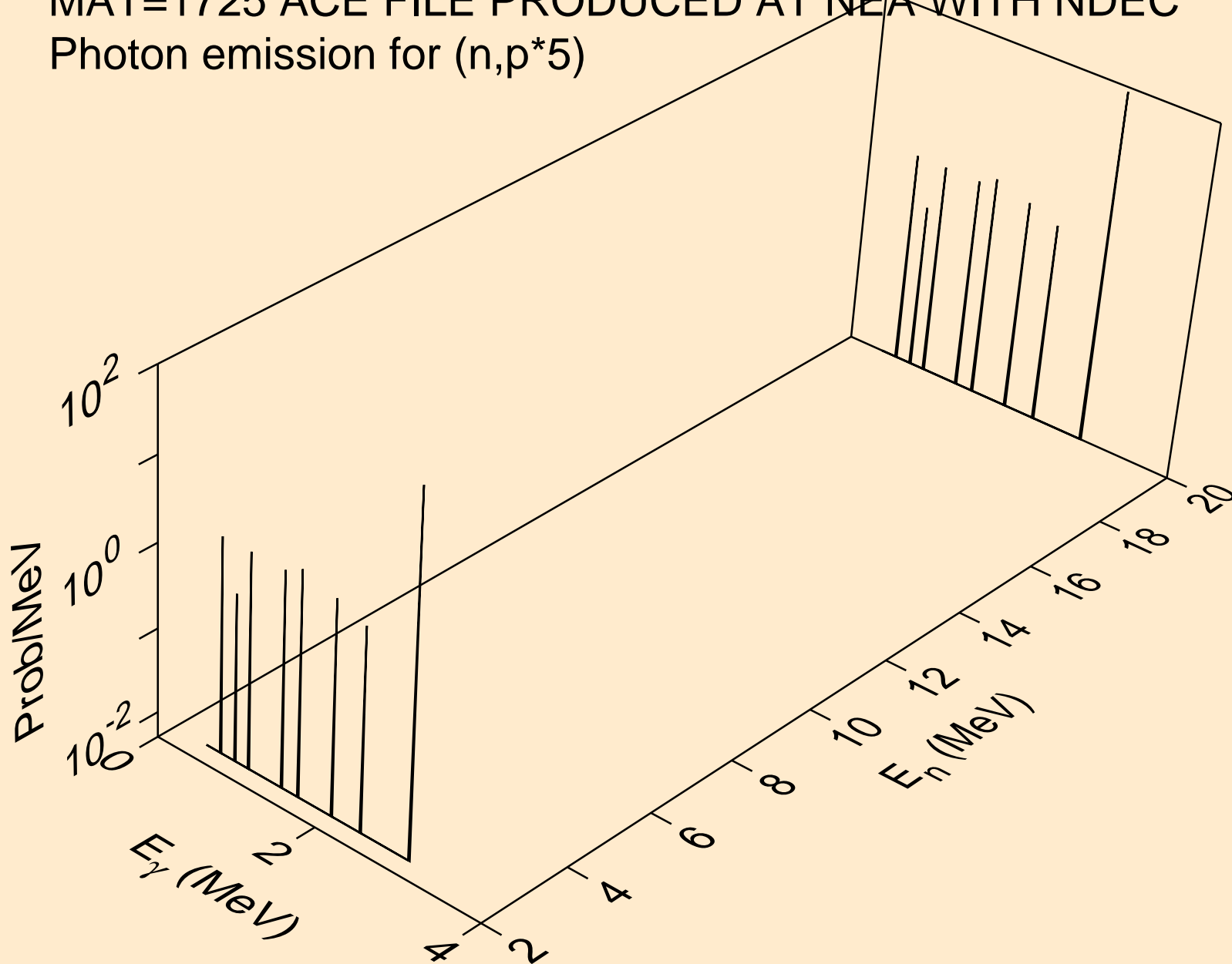

MAT=1725 ACE FILE PRODUCED AT NEA WITH NDEC
Photon emission for (n,p*6)

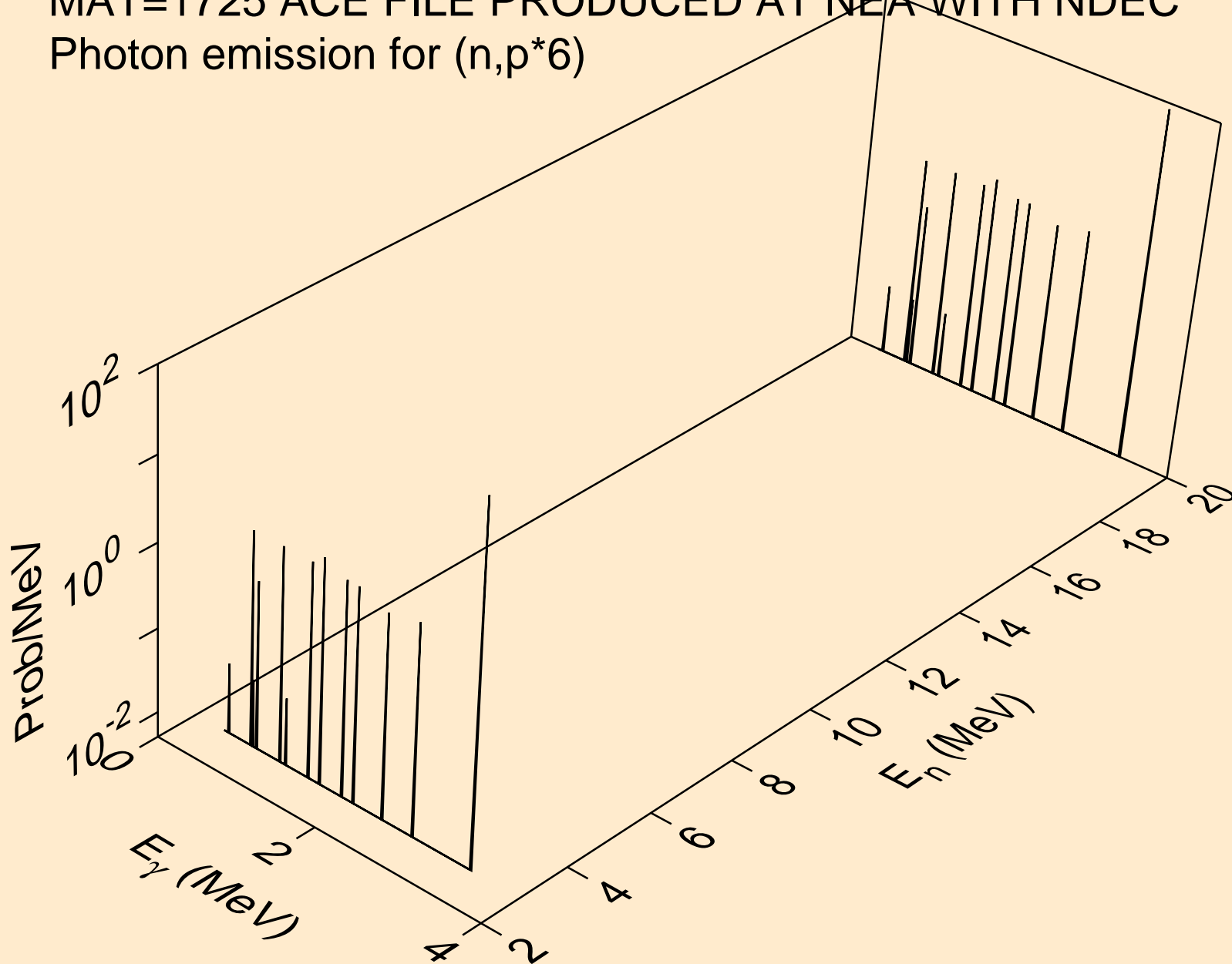

MAT=1725 ACE FILE PRODUCED AT NEA WITH NDEC
Photon emission for (n,p*7)

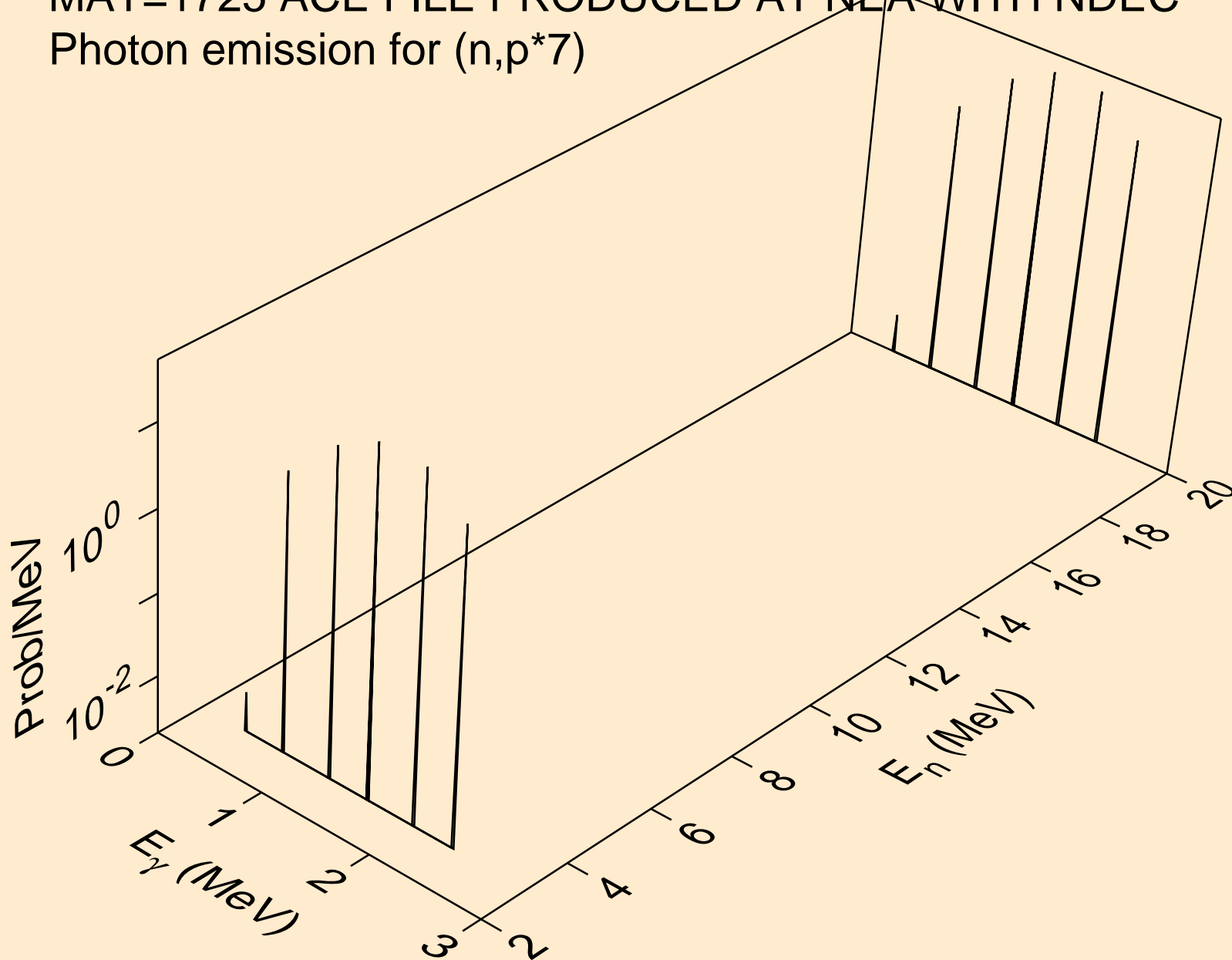

MAT=1725 ACE FILE PRODUCED AT NEA WITH NDEC
Photon emission for (n,p*8)

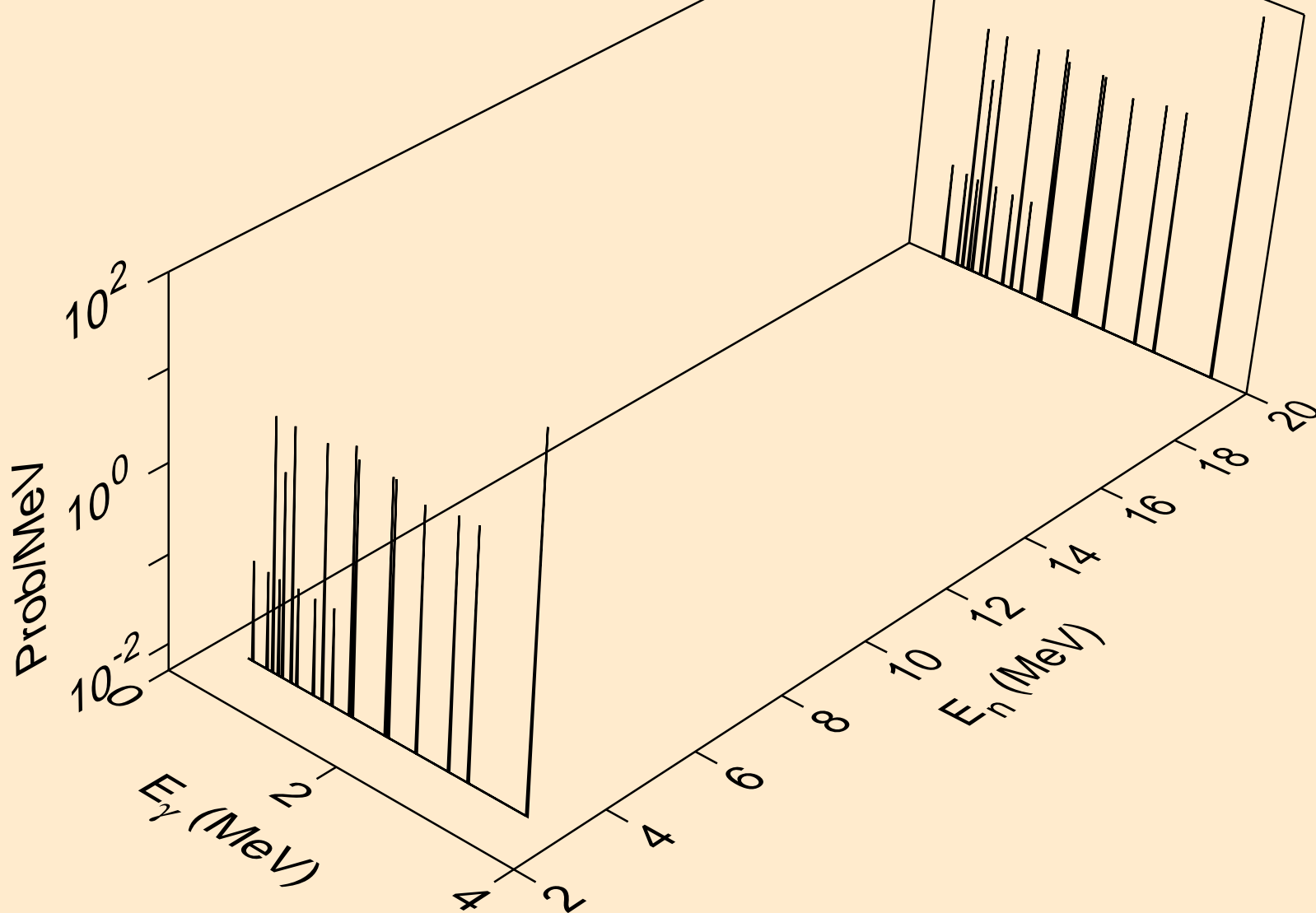

MAT=1725 ACE FILE PRODUCED AT NEA WITH NDEC
Photon emission for (n,p*9)

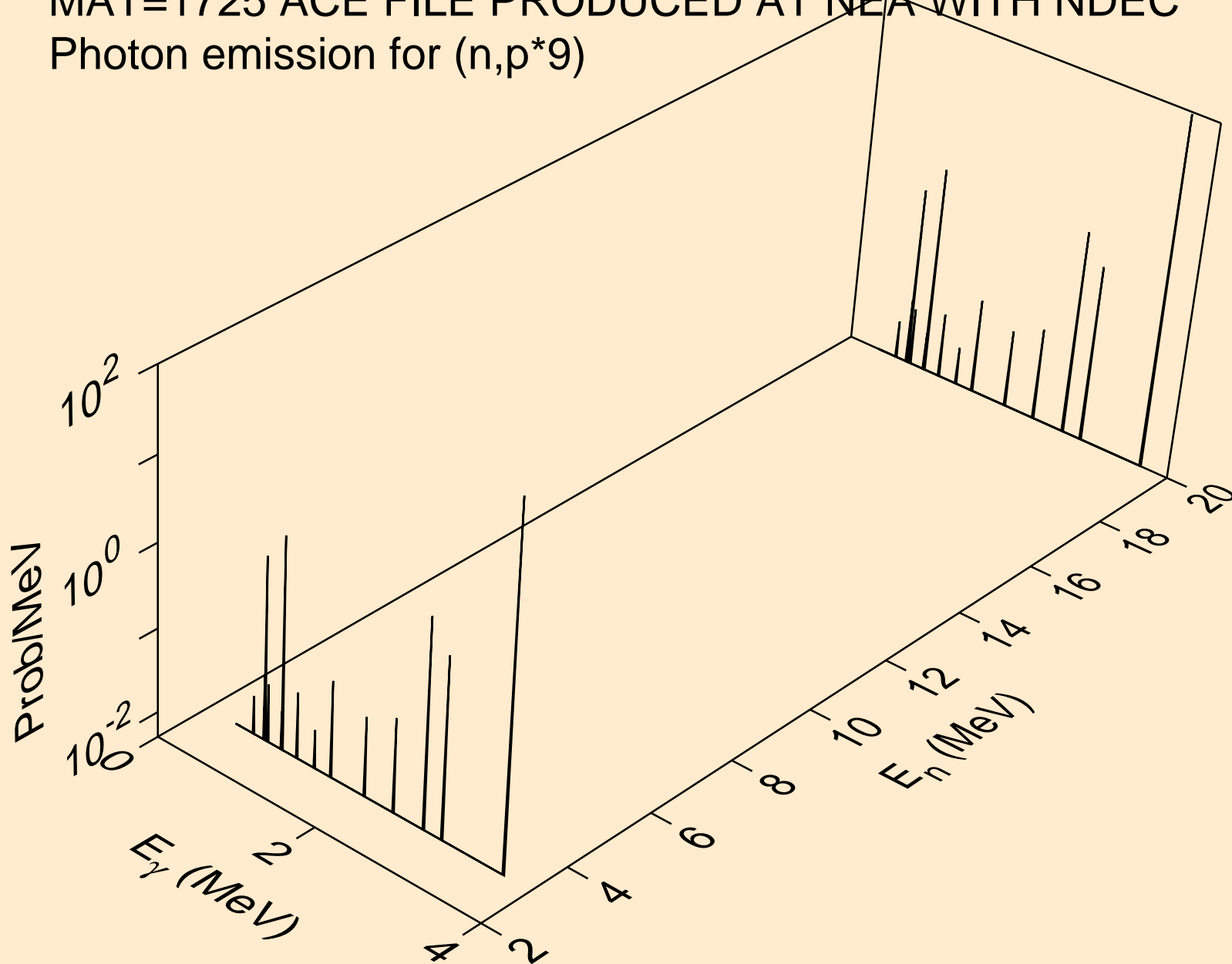

MAT=1725 ACE FILE PRODUCED AT NEA WITH NDEC
Photon emission for (n,p*10)

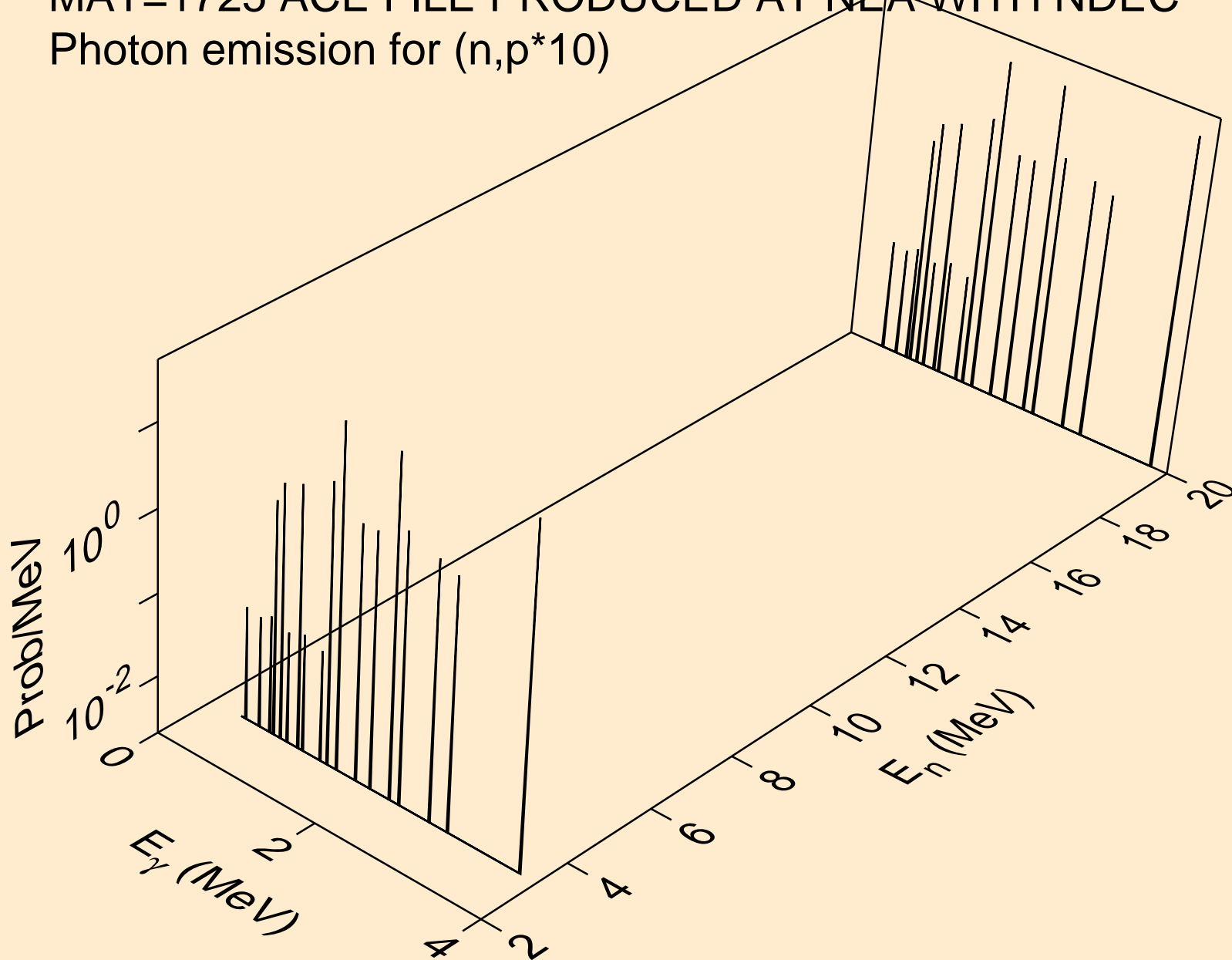

MAT=1725 ACE FILE PRODUCED AT NEA WITH NDEC
Photon emission for (n,p*11)

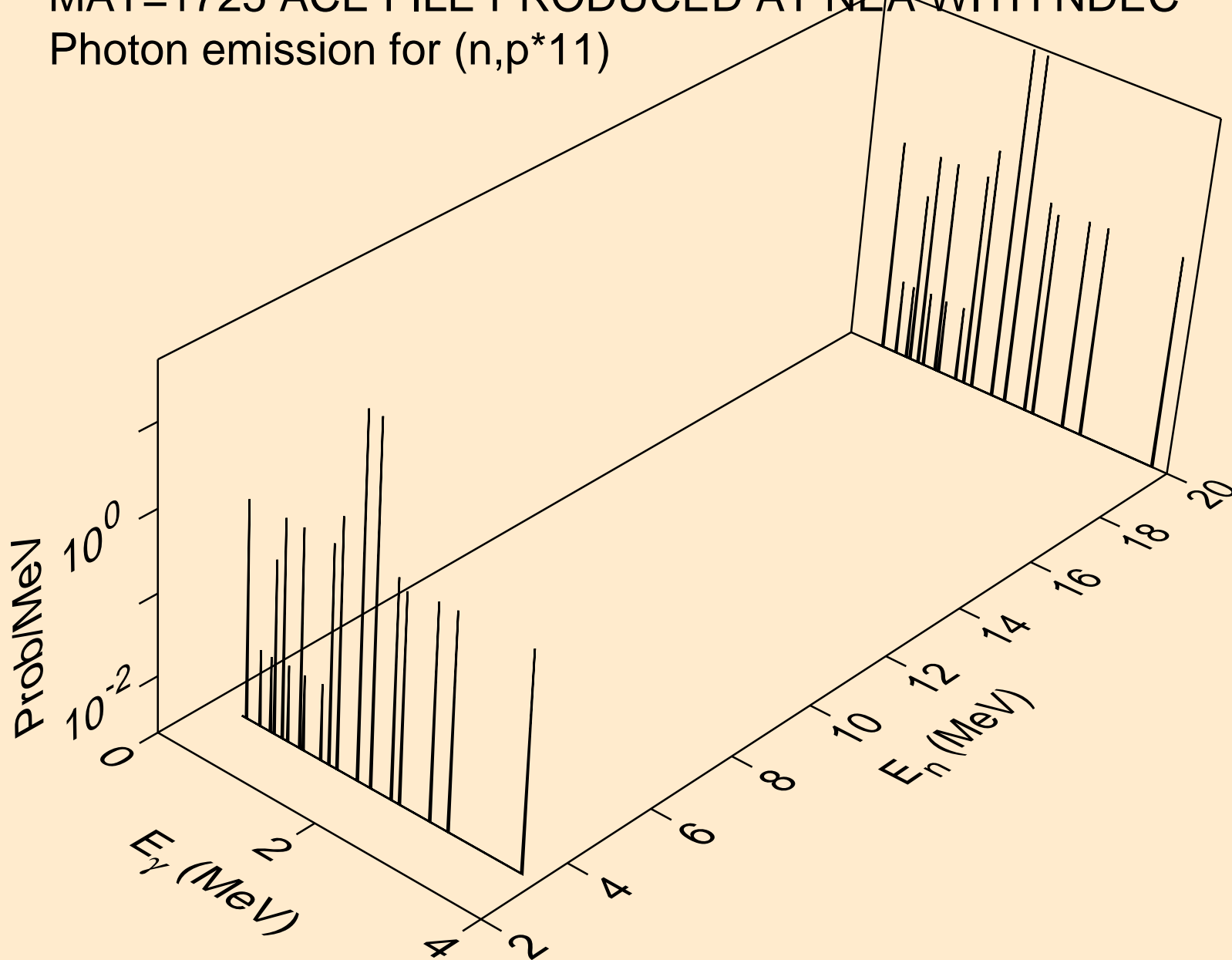

MAT=1725 ACE FILE PRODUCED AT NEA WITH NDEC
Photon emission for (n,p*12)

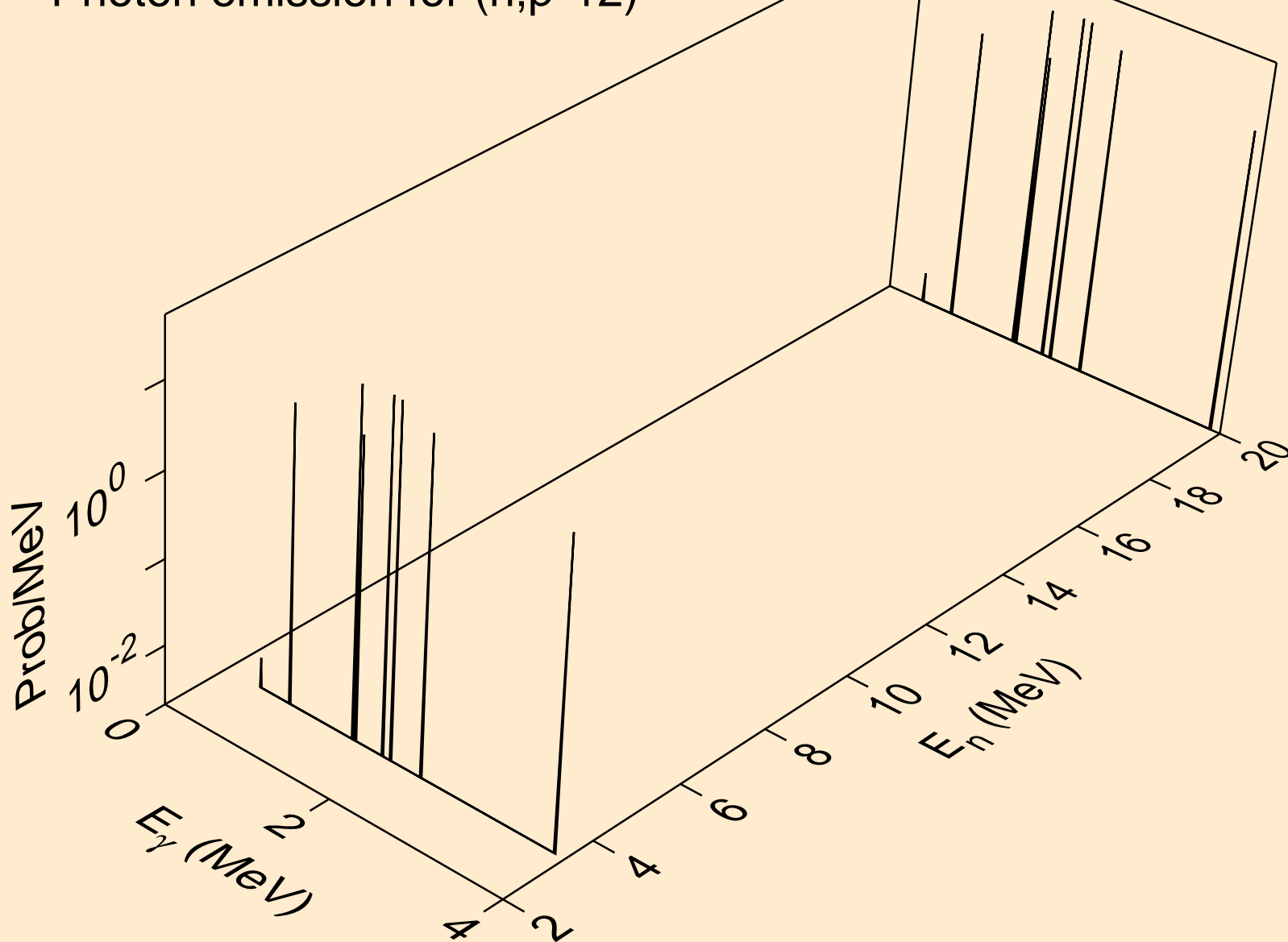

MAT=1725 ACE FILE PRODUCED AT NEA WITH NDEC
Photon emission for (n,p*13)

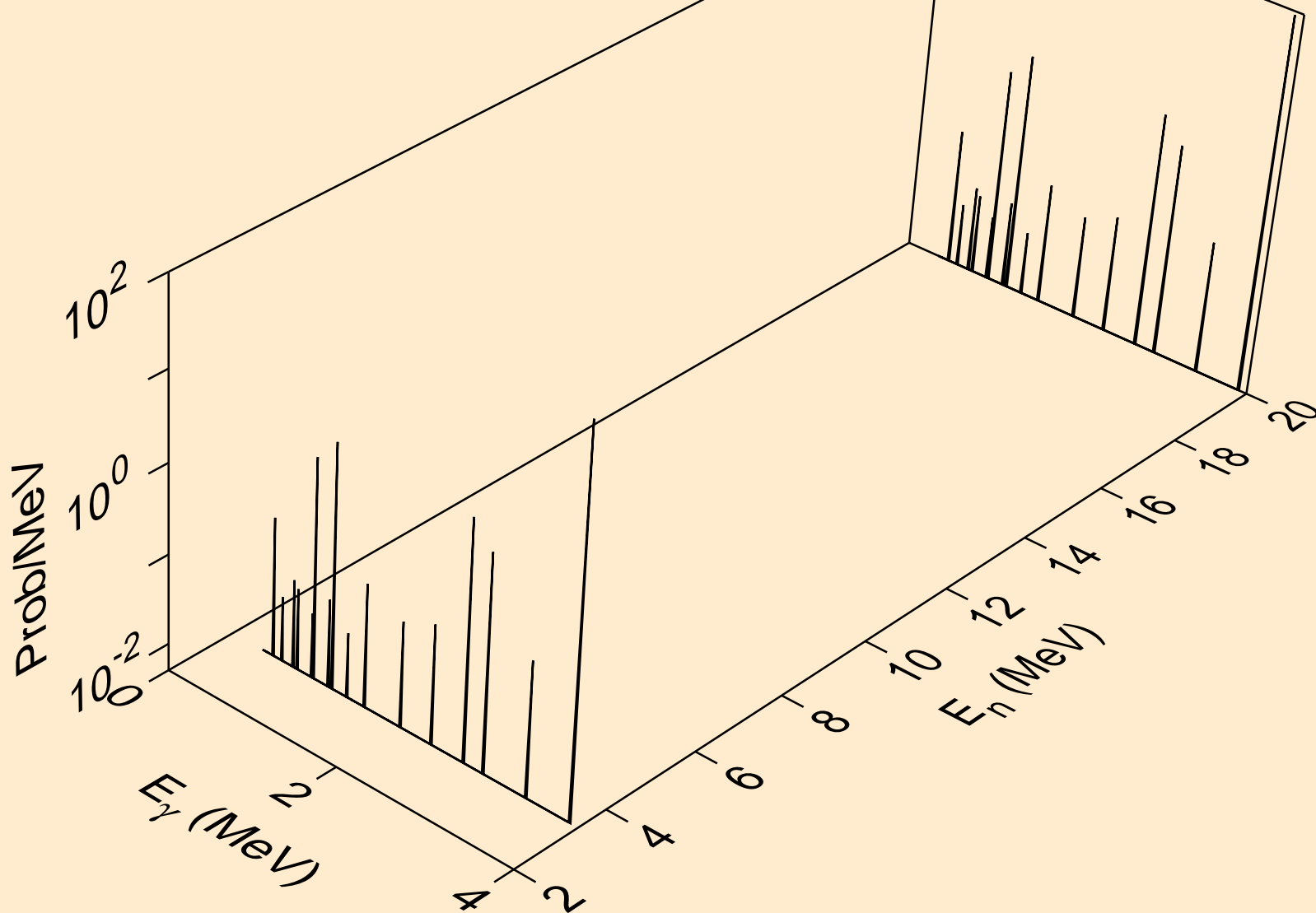

MAT=1725 ACE FILE PRODUCED AT NEA WITH NDEC
Photon emission for (n,p*14)

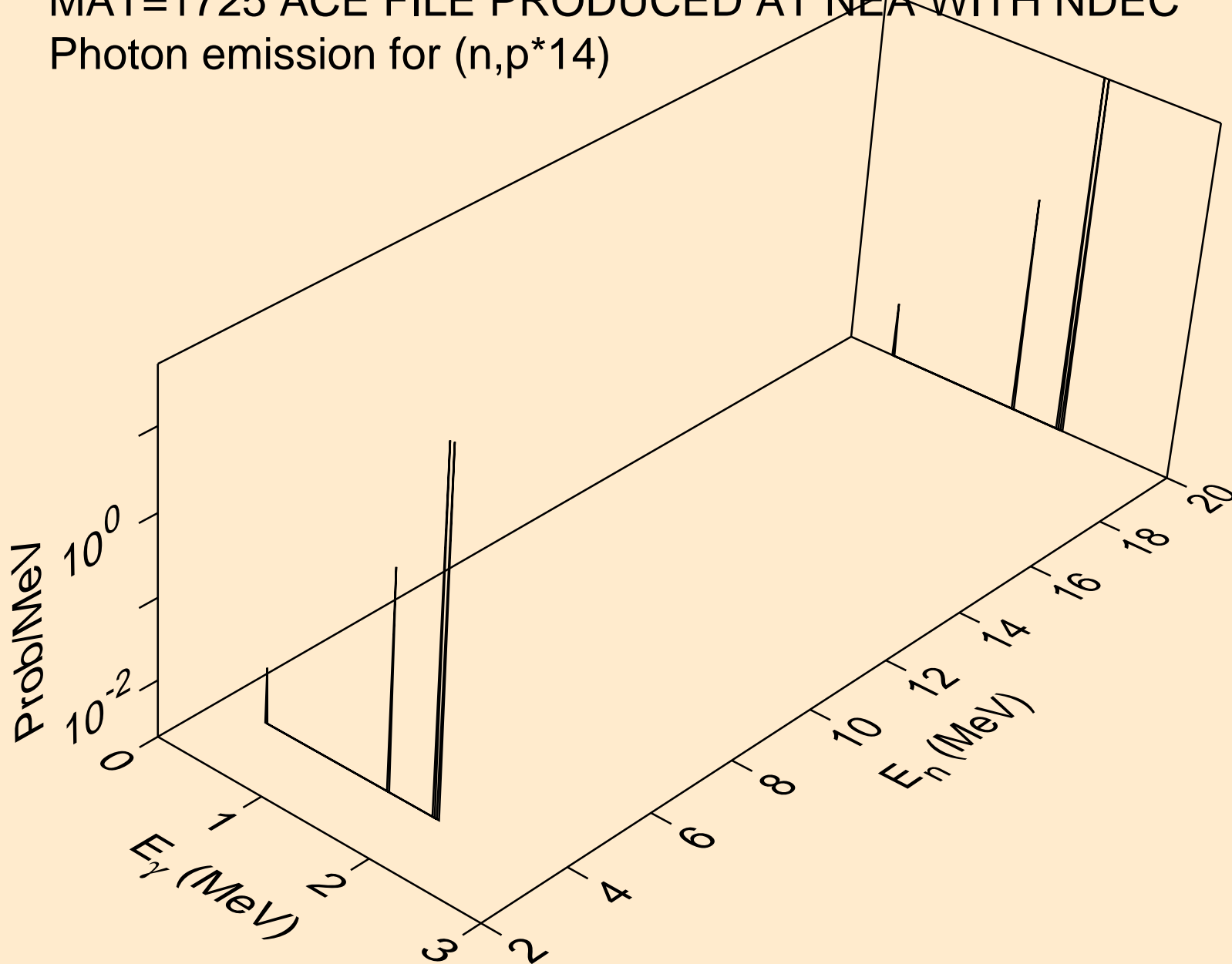

MAT=1725 ACE FILE PRODUCED AT NEA WITH NDEC
Photon emission for (n,p*15)

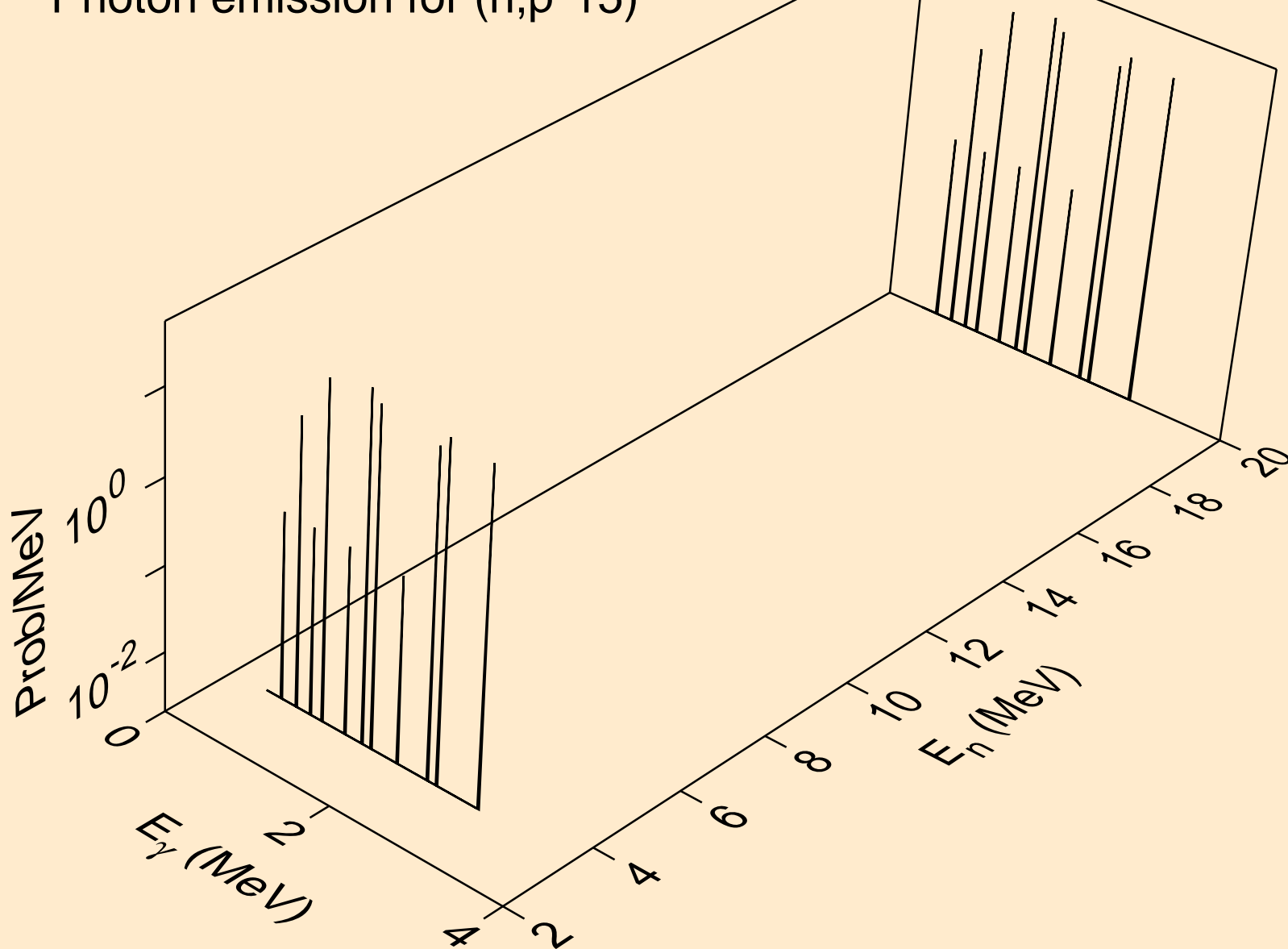

MAT=1725 ACE FILE PRODUCED AT NEA WITH NDEC
Photon emission for (n,p*16)

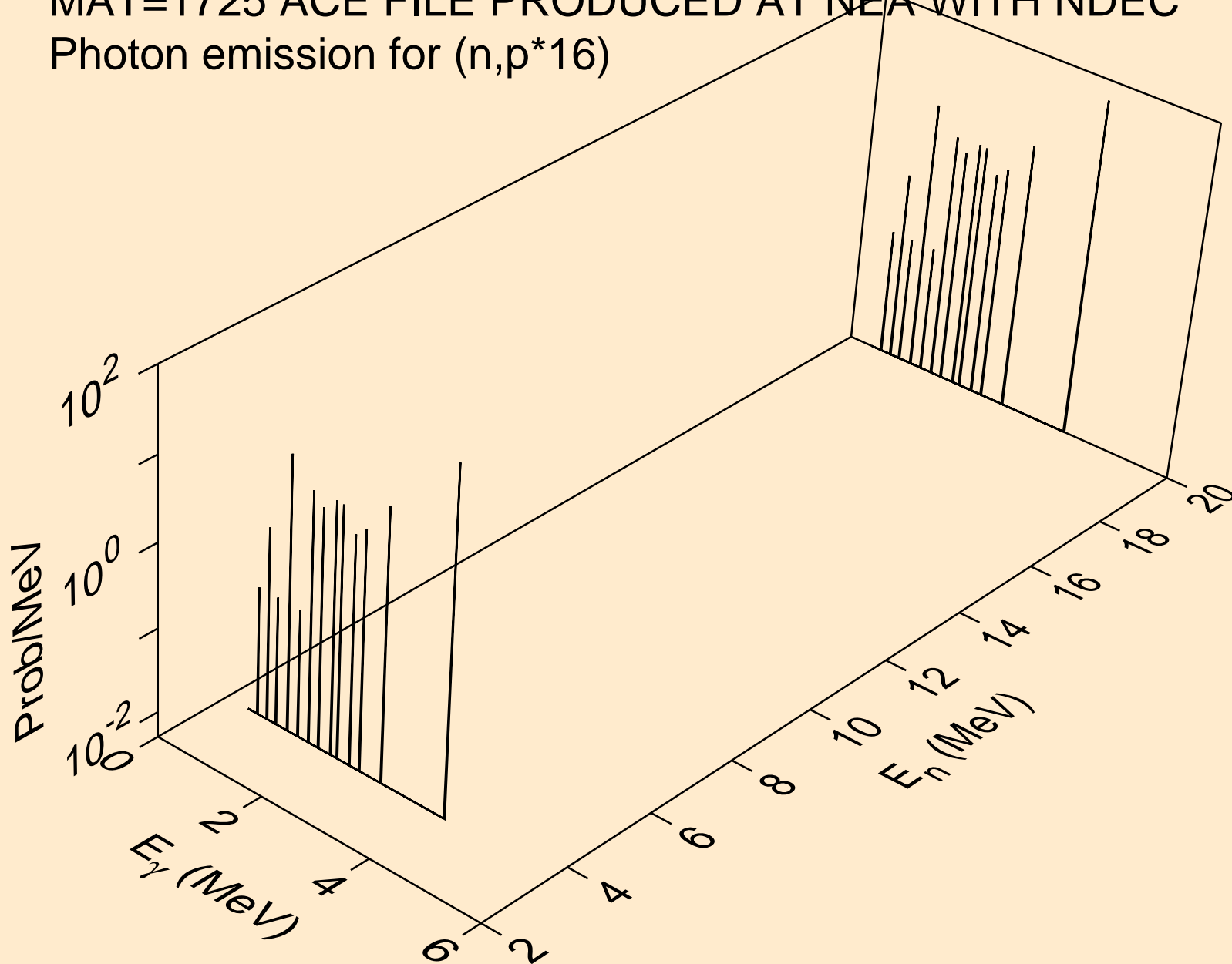

MAT=1725 ACE FILE PRODUCED AT NEA WITH NDEC
Photon emission for (n,p*17)

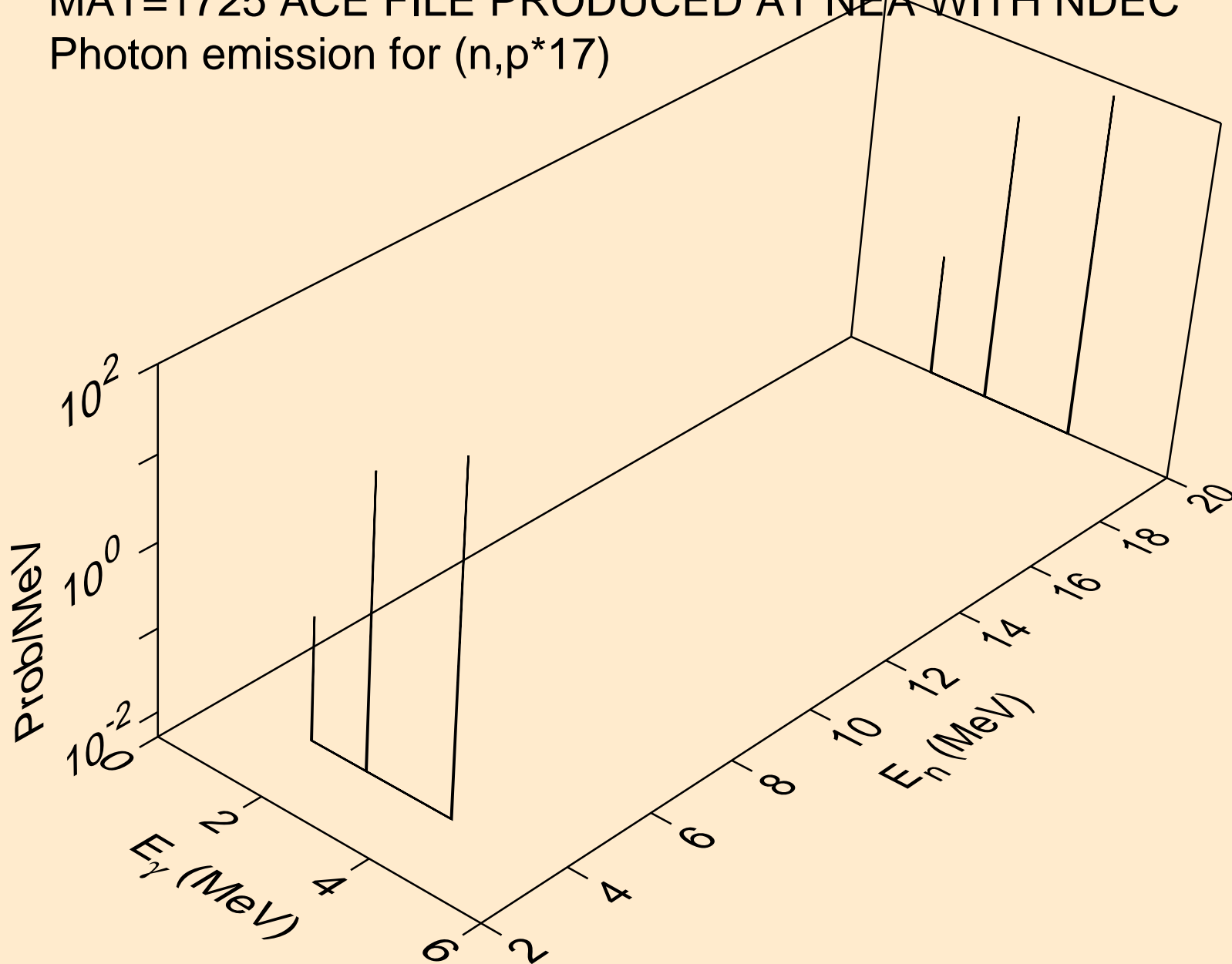

MAT=1725 ACE FILE PRODUCED AT NEA WITH NDEC
Photon emission for (n,p*18)

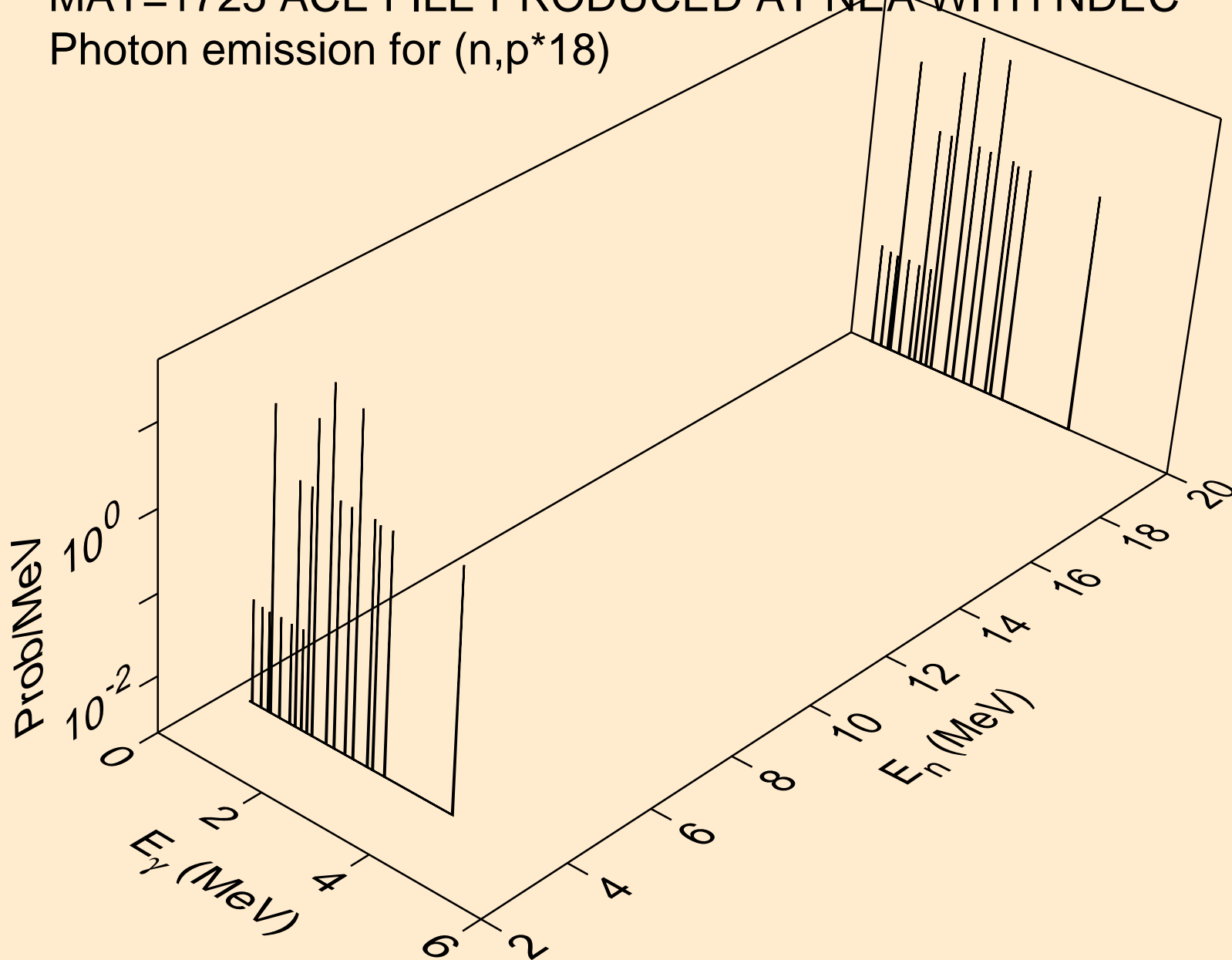

MAT=1725 ACE FILE PRODUCED AT NEA WITH NDEC
Photon emission for (n,p*19)

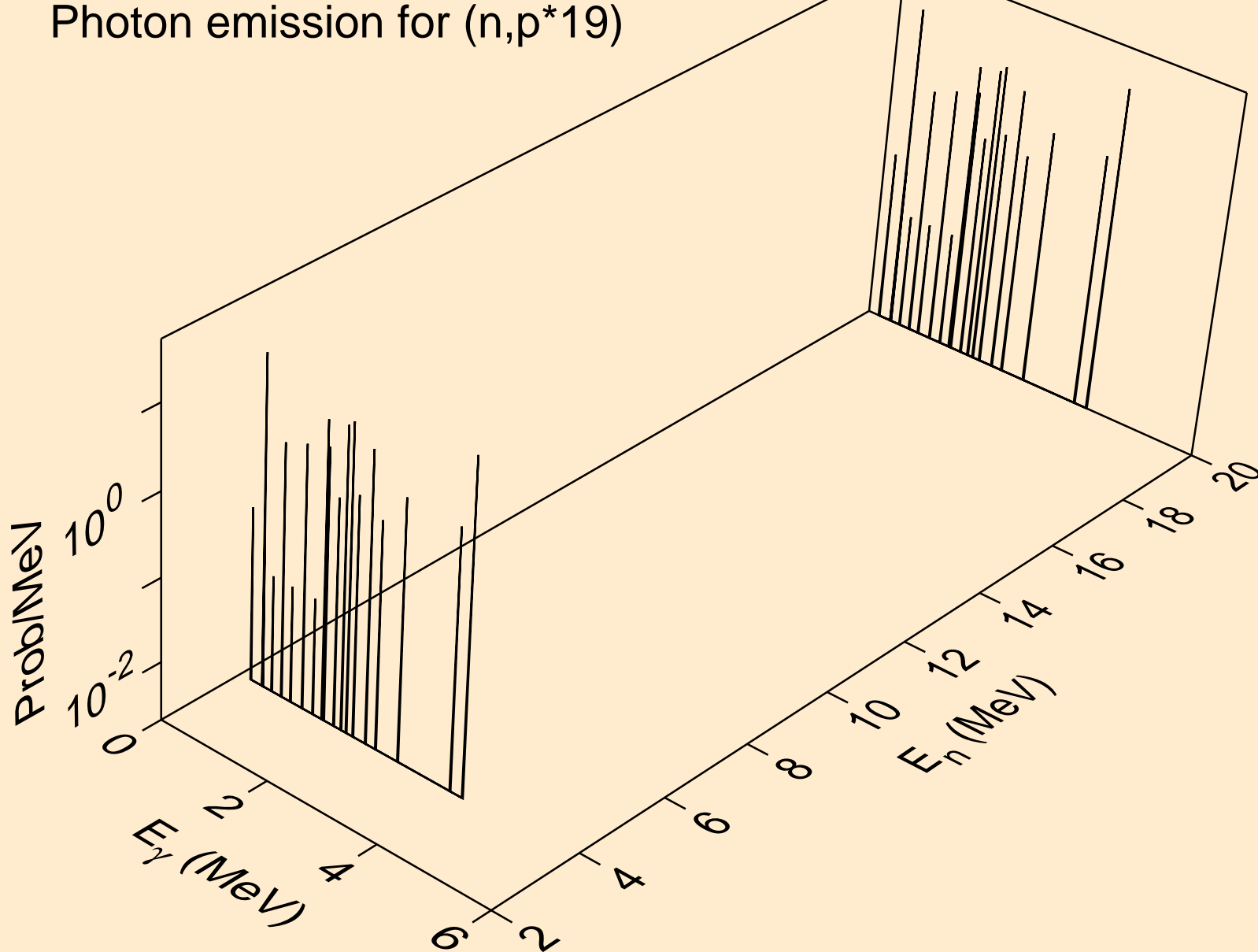

MAT=1725 ACE FILE PRODUCED AT NEA WITH NDEC
Photon emission for (n,p*20)

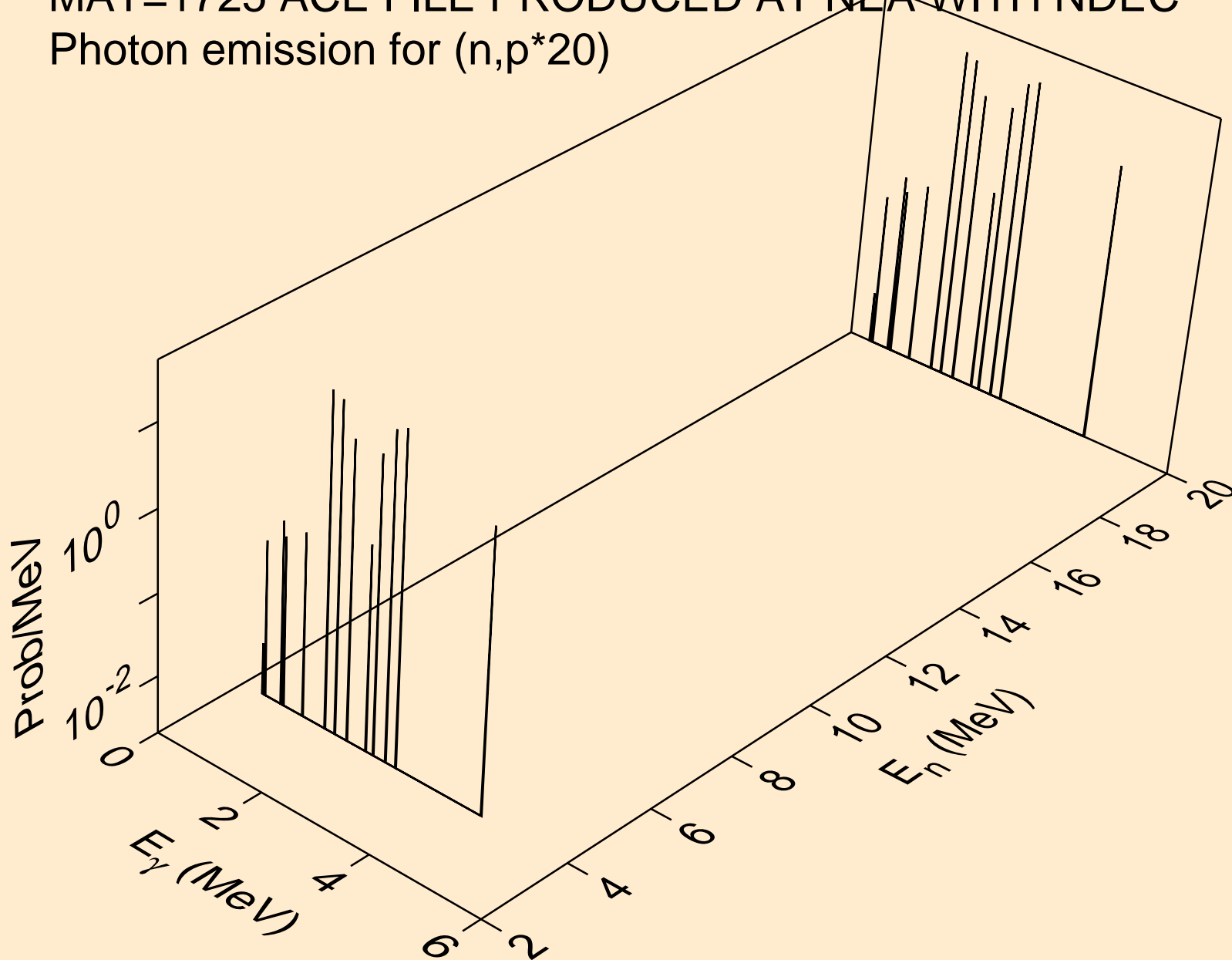

MAT=1725 ACE FILE PRODUCED AT NEA WITH NDEC
Photon emission for (n,p*21)

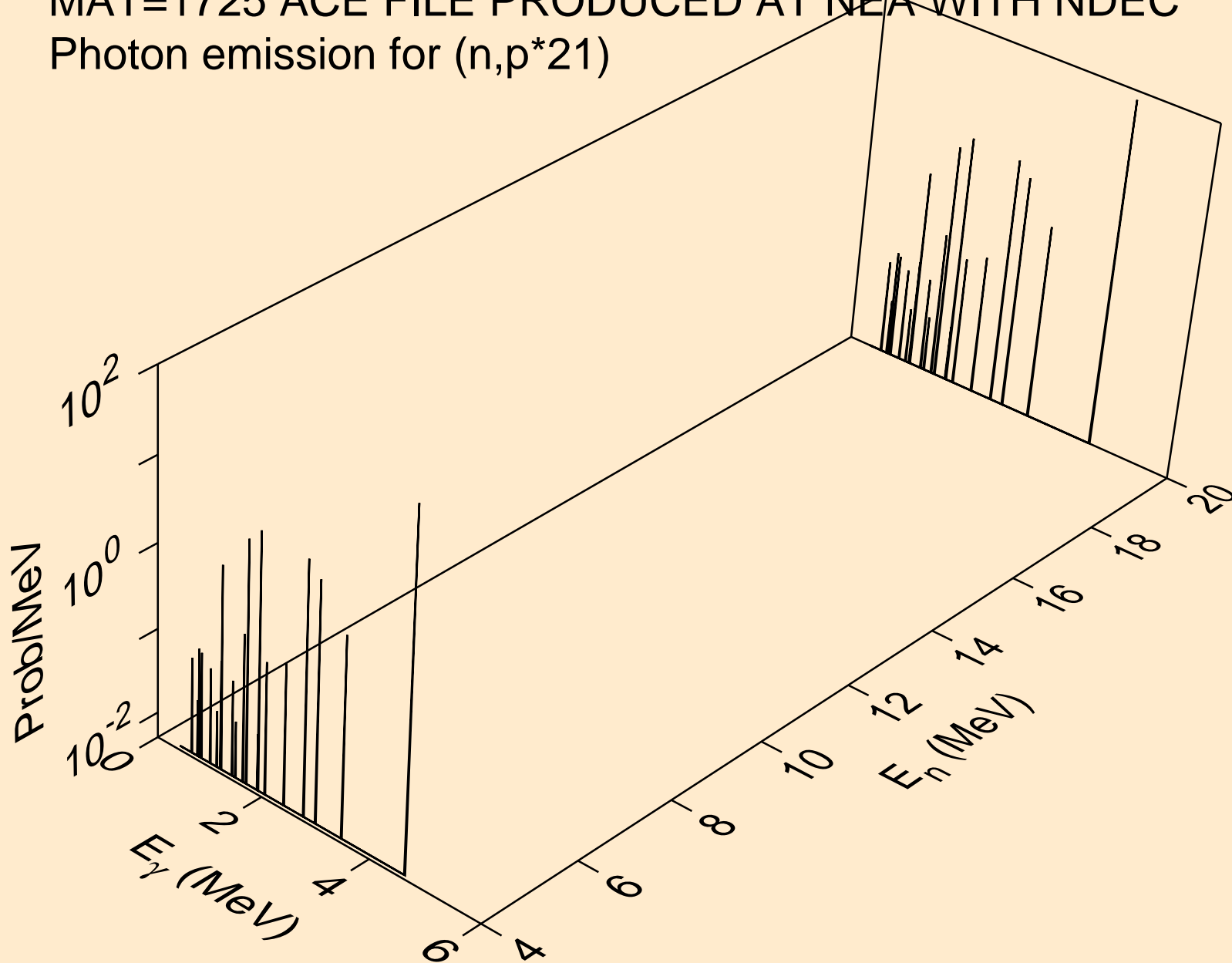

MAT=1725 ACE FILE PRODUCED AT NEA WITH NDEC
Photon emission for (n,p*22)

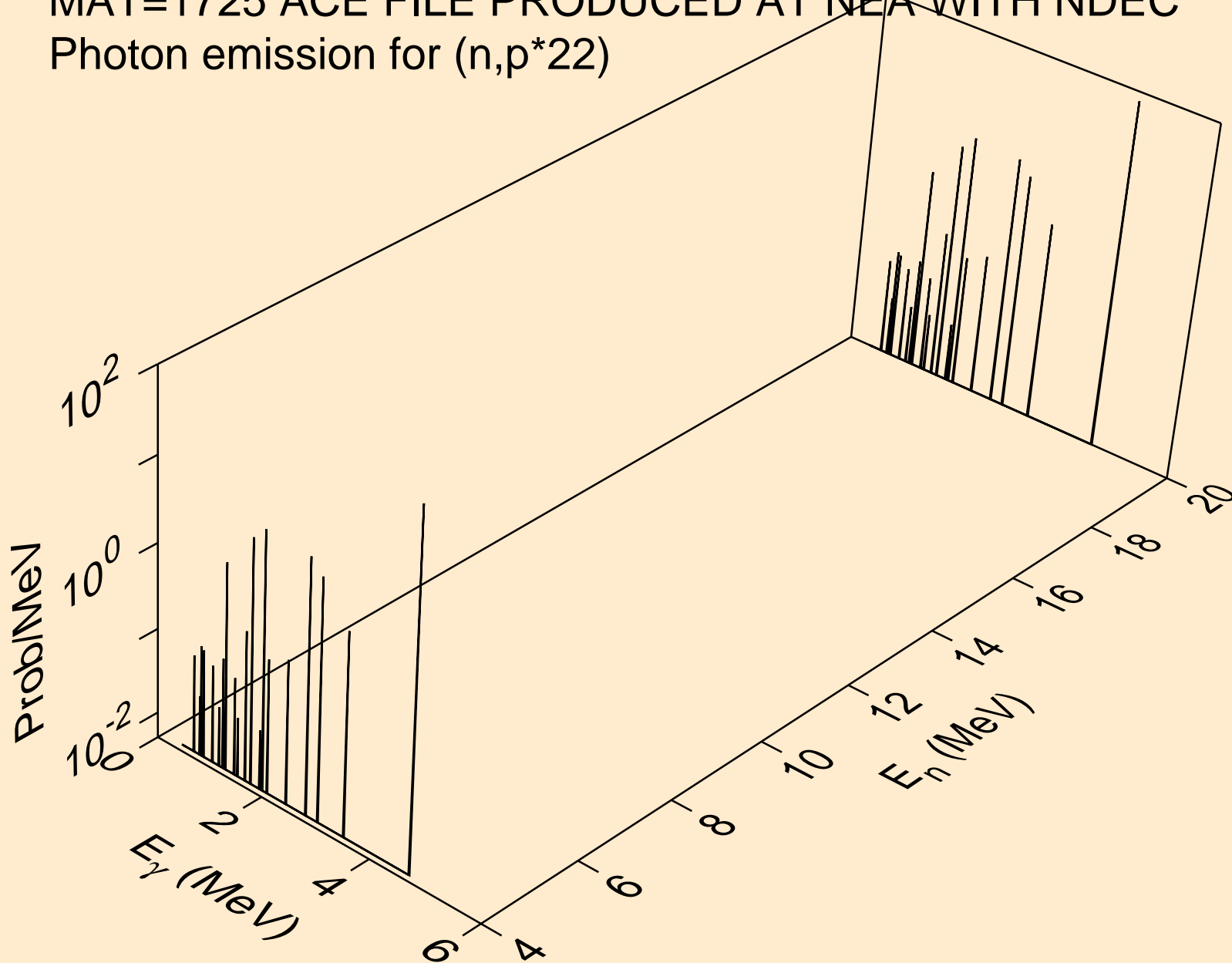

MAT=1725 ACE FILE PRODUCED AT NEA WITH NDEC
Photon emission for (n,p*23)

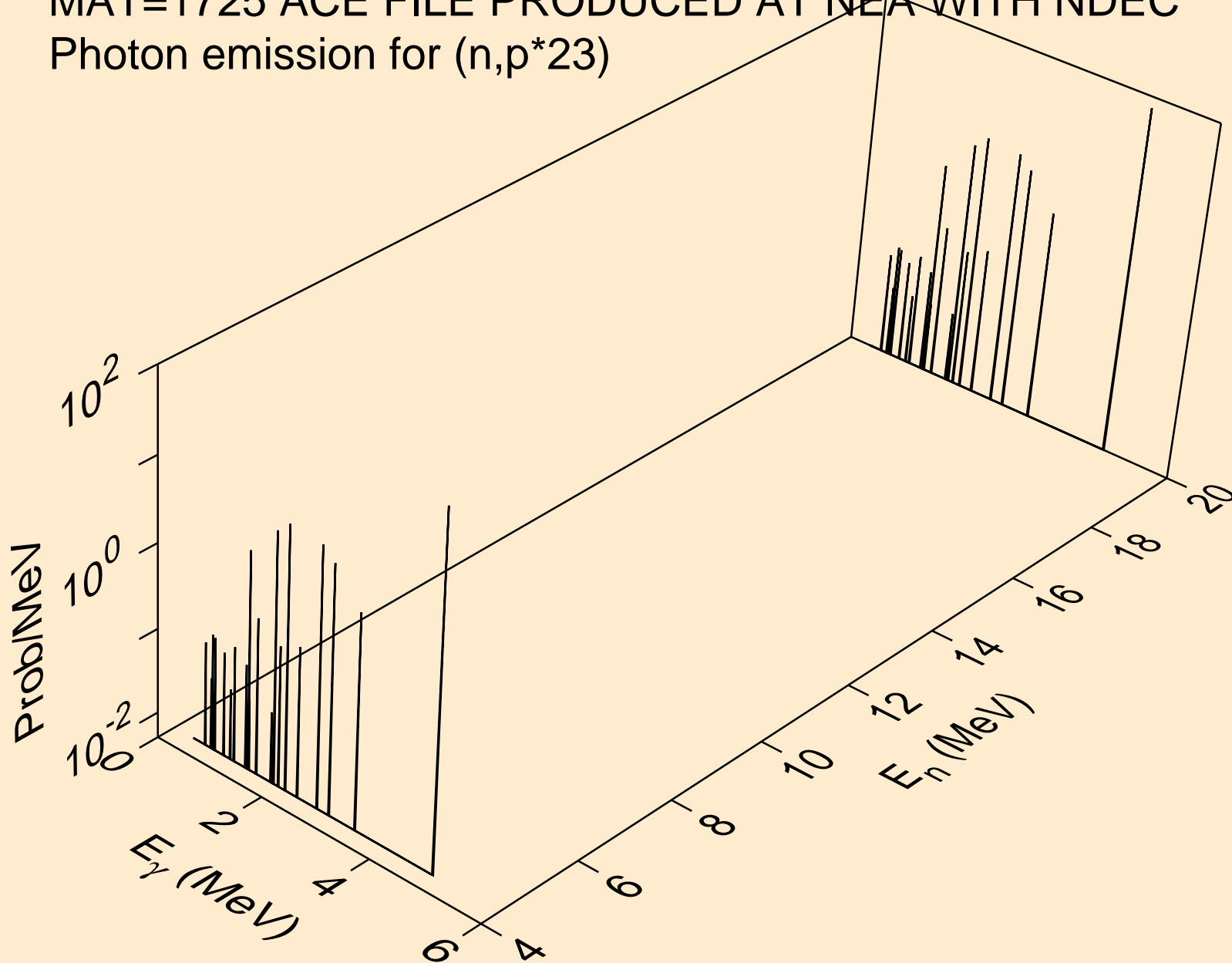

MAT=1725 ACE FILE PRODUCED AT NEA WITH NDEC
Photon emission for (n,p*24)

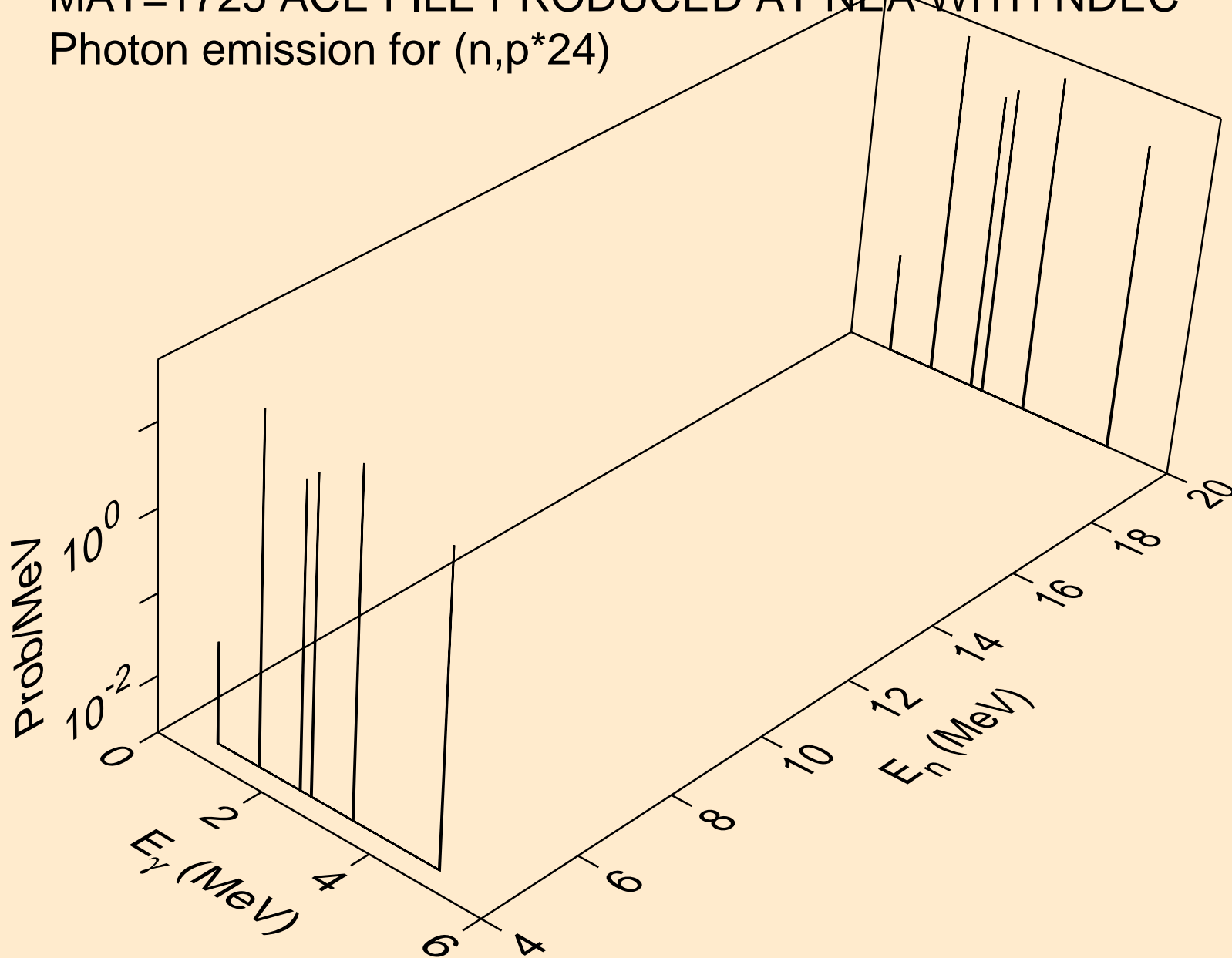

MAT=1725 ACE FILE PRODUCED AT NEA WITH NDEC
Photon emission for (n,p*25)

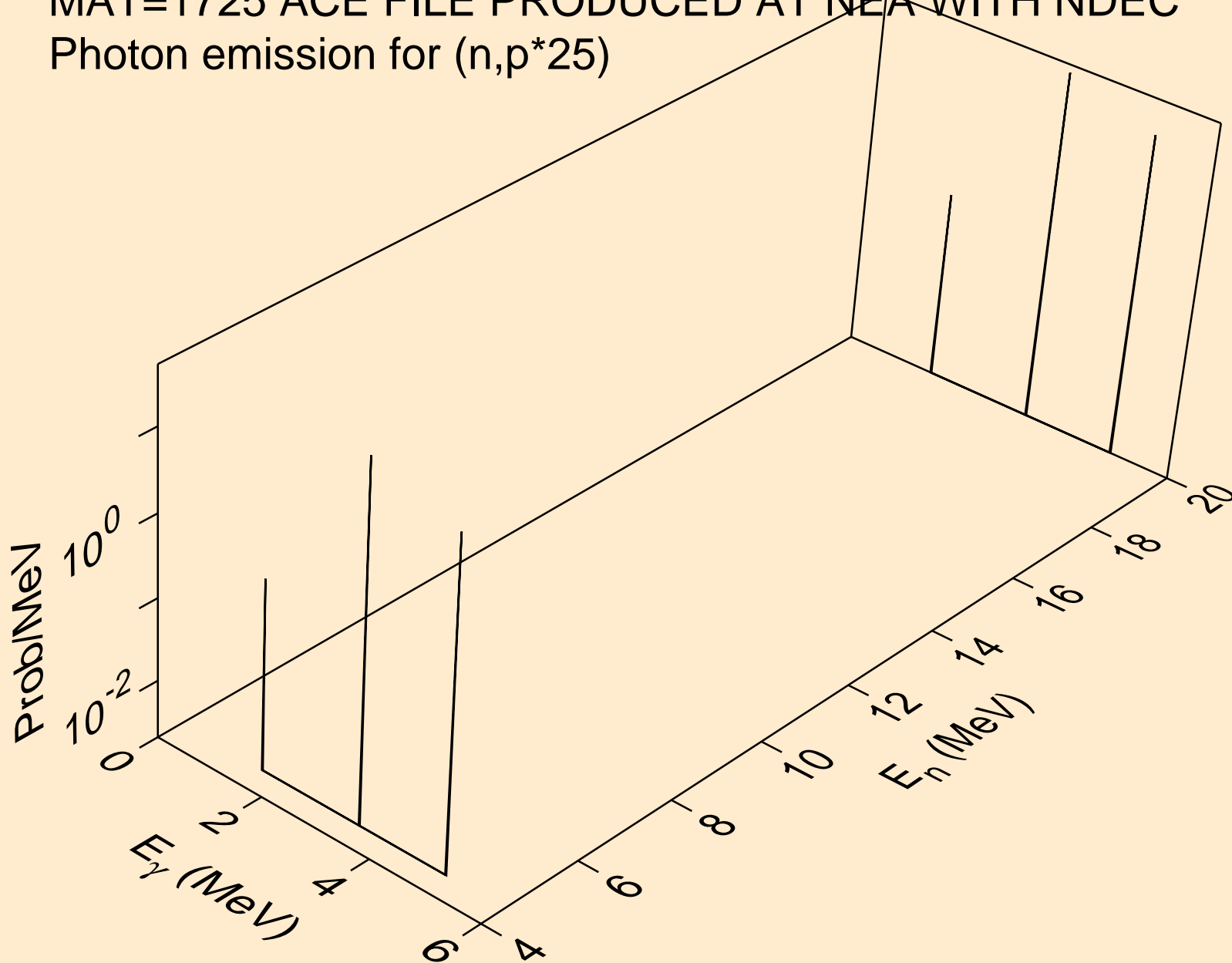

MAT=1725 ACE FILE PRODUCED AT NEA WITH NDEC
Photon emission for (n,p*26)

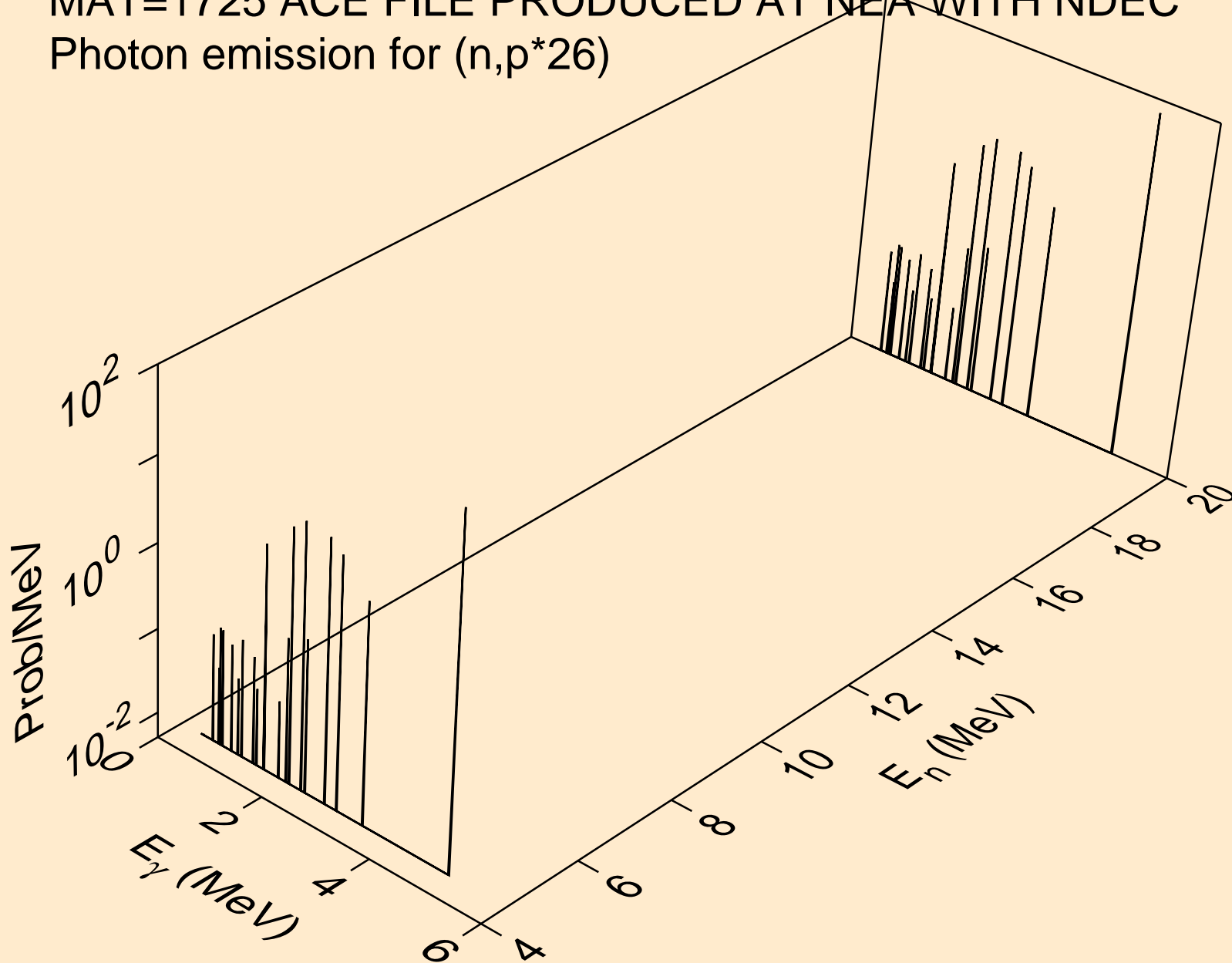

MAT=1725 ACE FILE PRODUCED AT NEA WITH NDEC
Photon emission for (n,p*27)

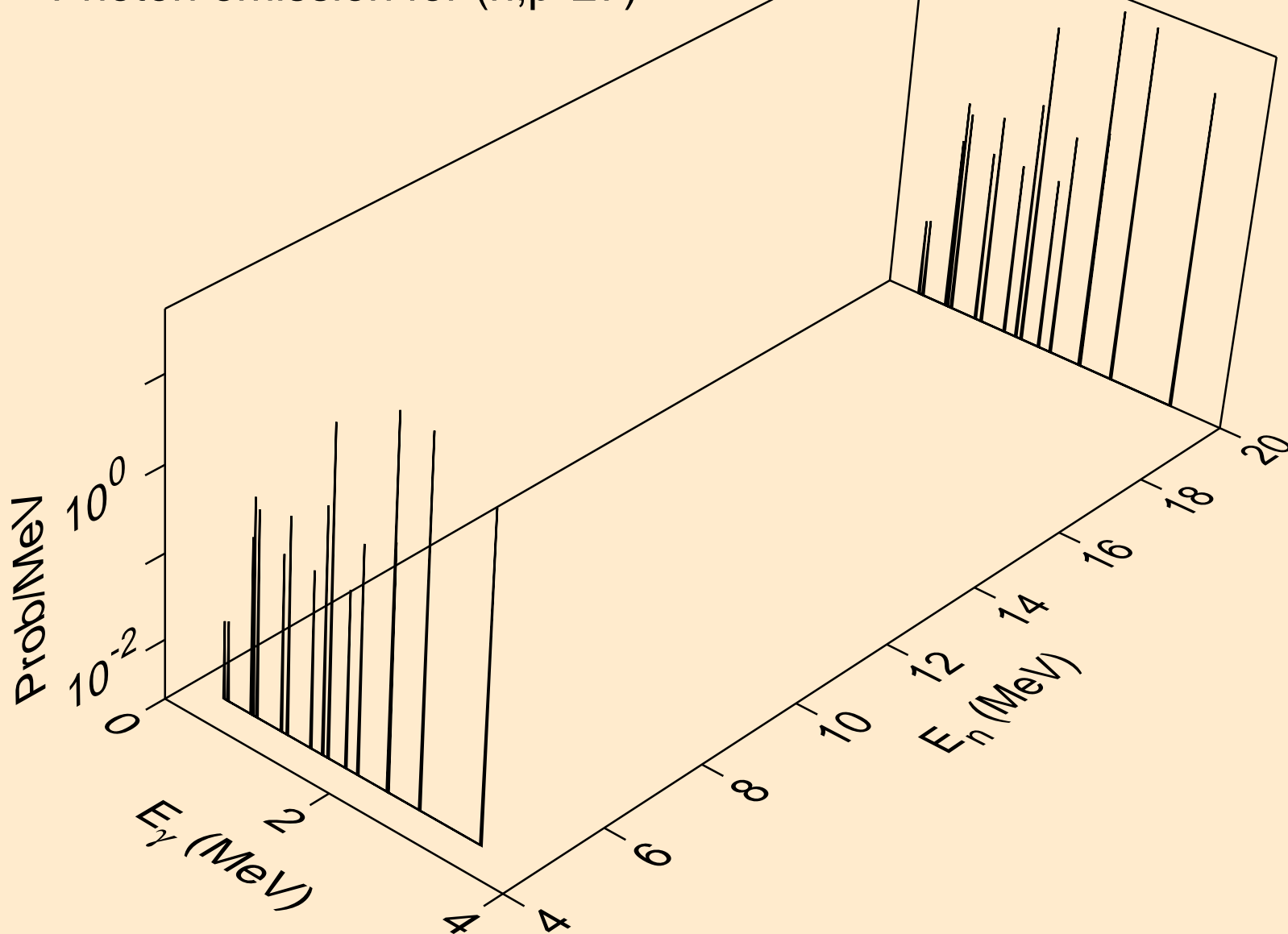

MAT=1725 ACE FILE PRODUCED AT NEA WITH NDEC
Photon emission for (n,p*28)

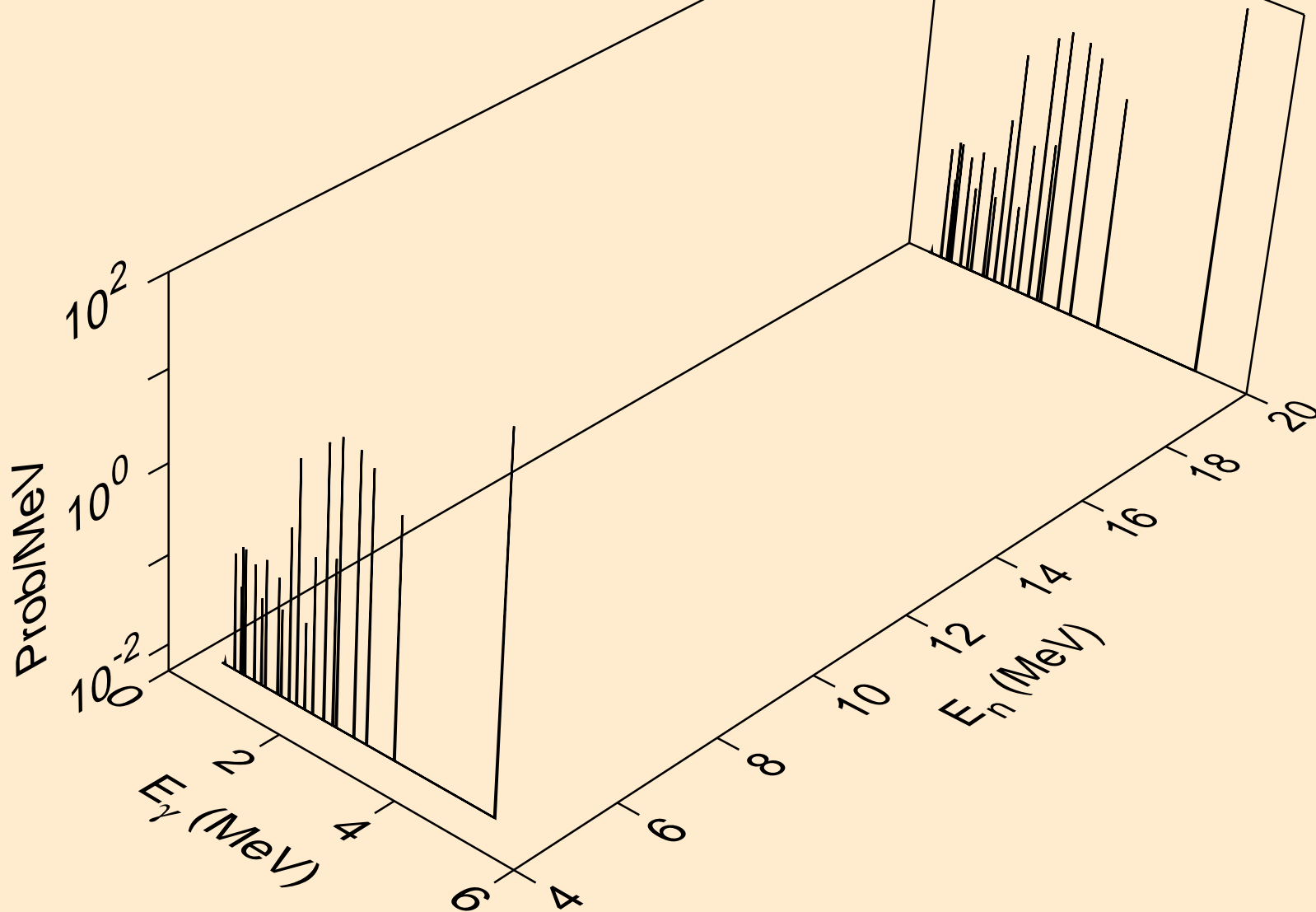

MAT=1725 ACE FILE PRODUCED AT NEA WITH NDEC
Photon emission for (n,p*29)

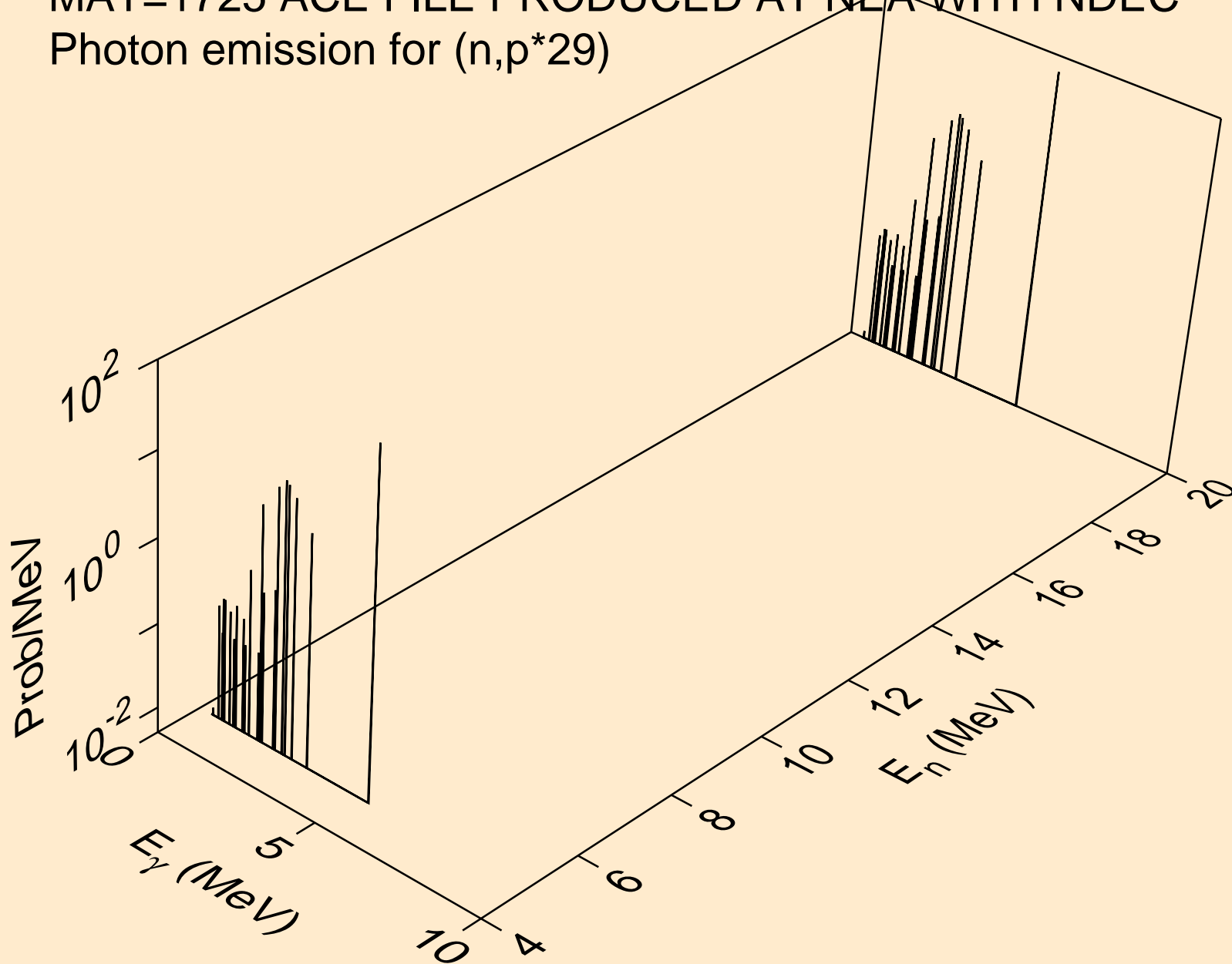

MAT=1725 ACE FILE PRODUCED AT NEA WITH NDEC
Photon emission for (n,p*c)

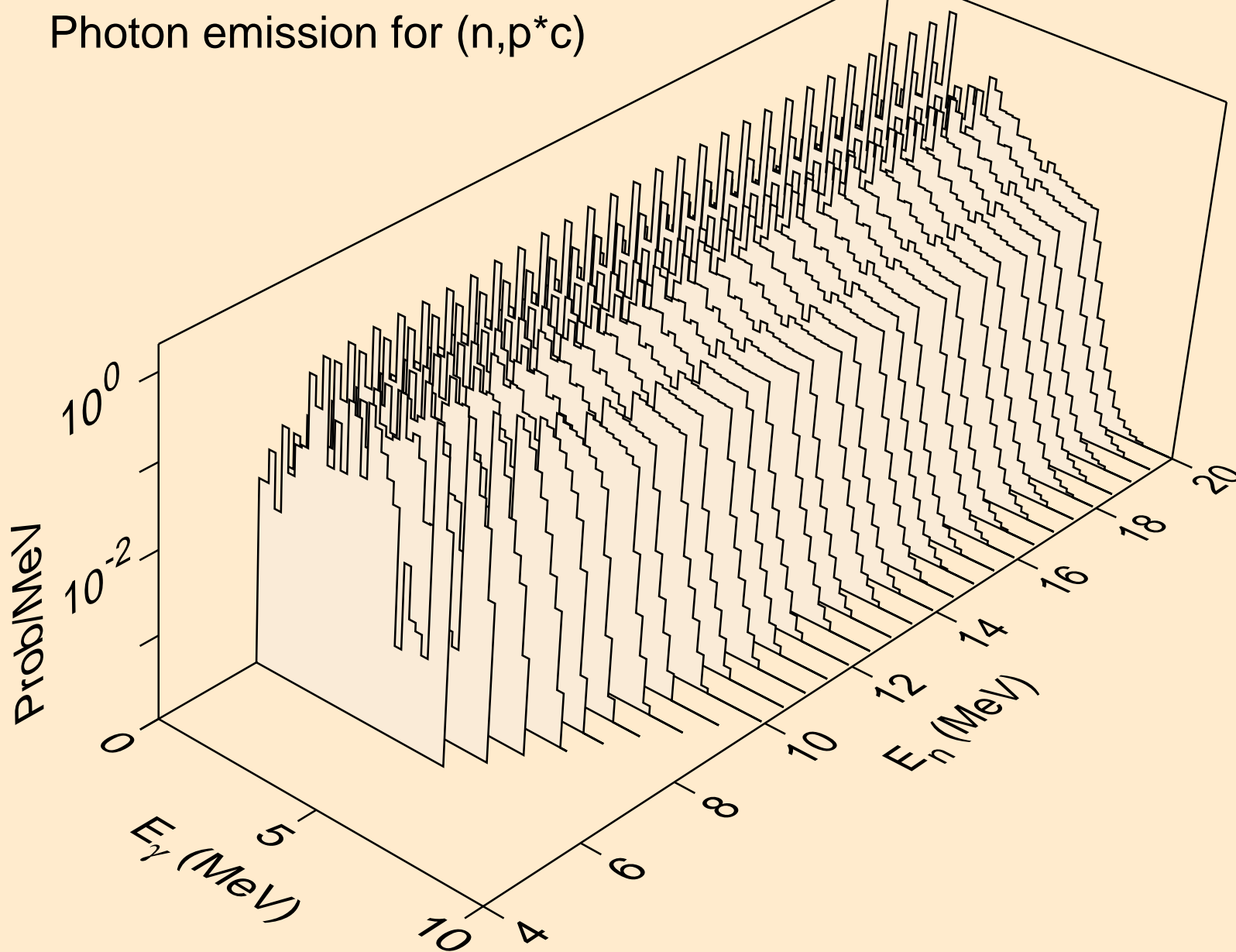

MAT=1725 ACE FILE PRODUCED AT NEA WITH NDEC
Photon emission for (n,d*1)

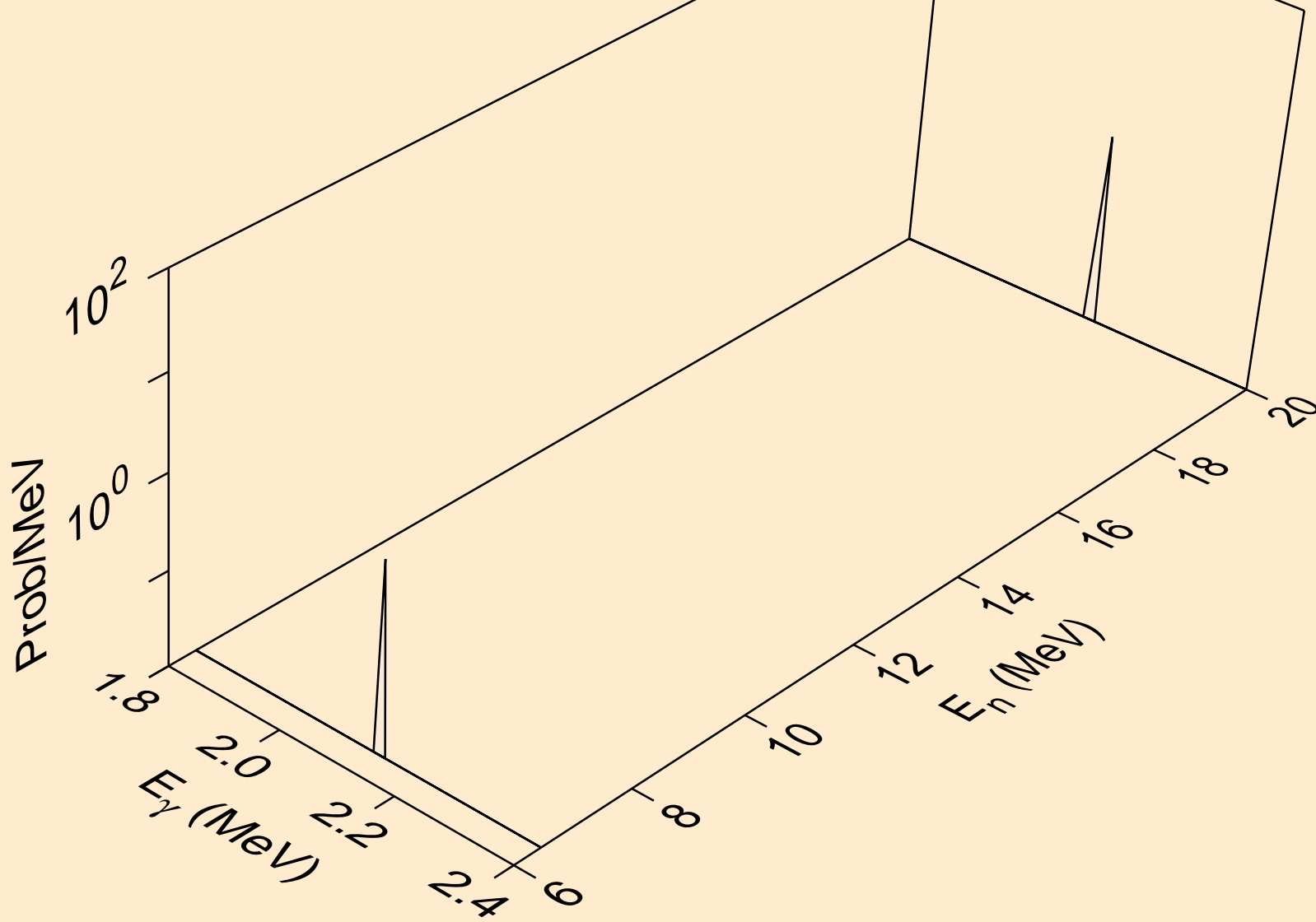

MAT=1725 ACE FILE PRODUCED AT NEA WITH NDEC
Photon emission for (n,d*2)

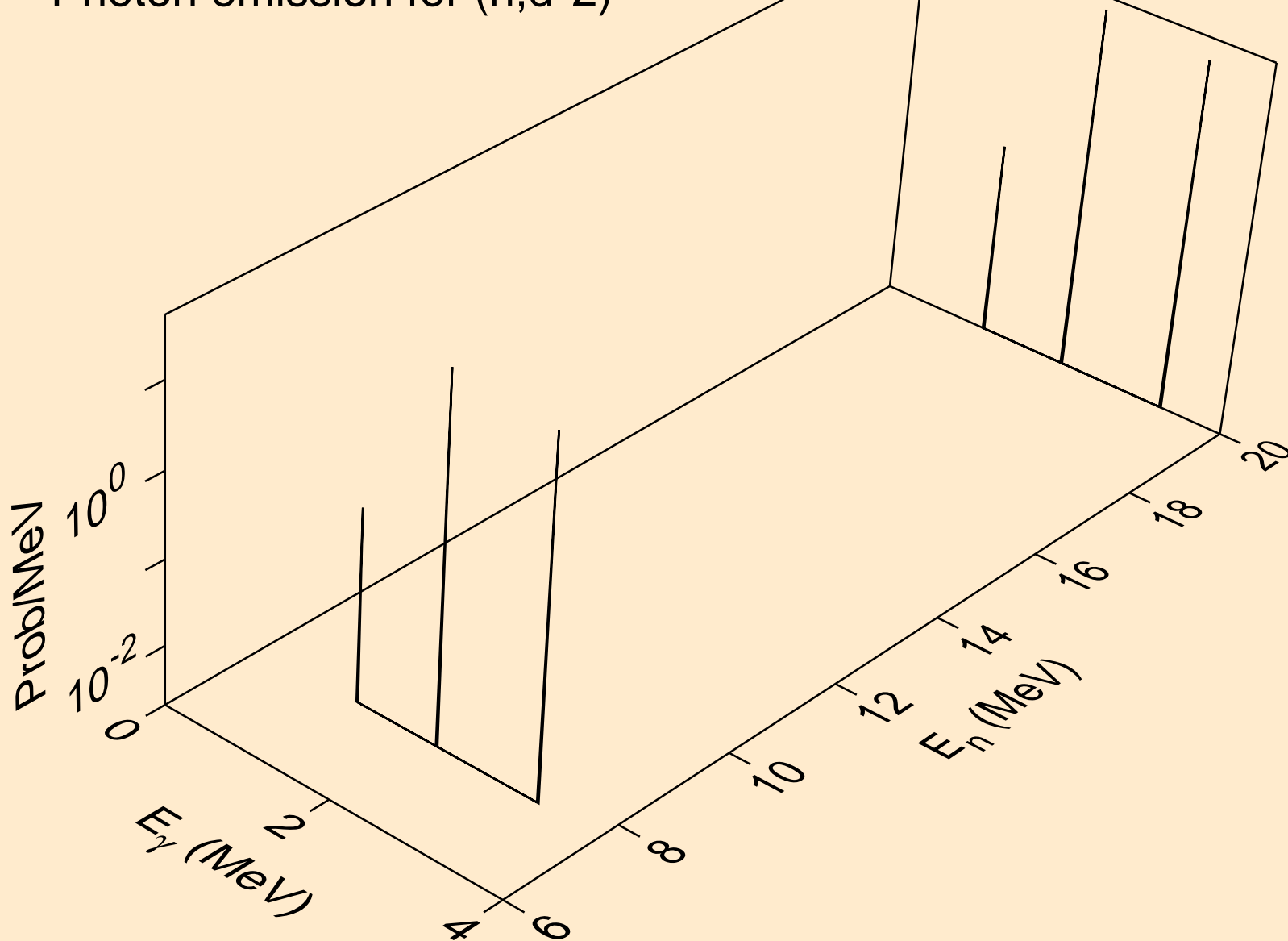

MAT=1725 ACE FILE PRODUCED AT NEA WITH NDEC
Photon emission for (n,d*3)

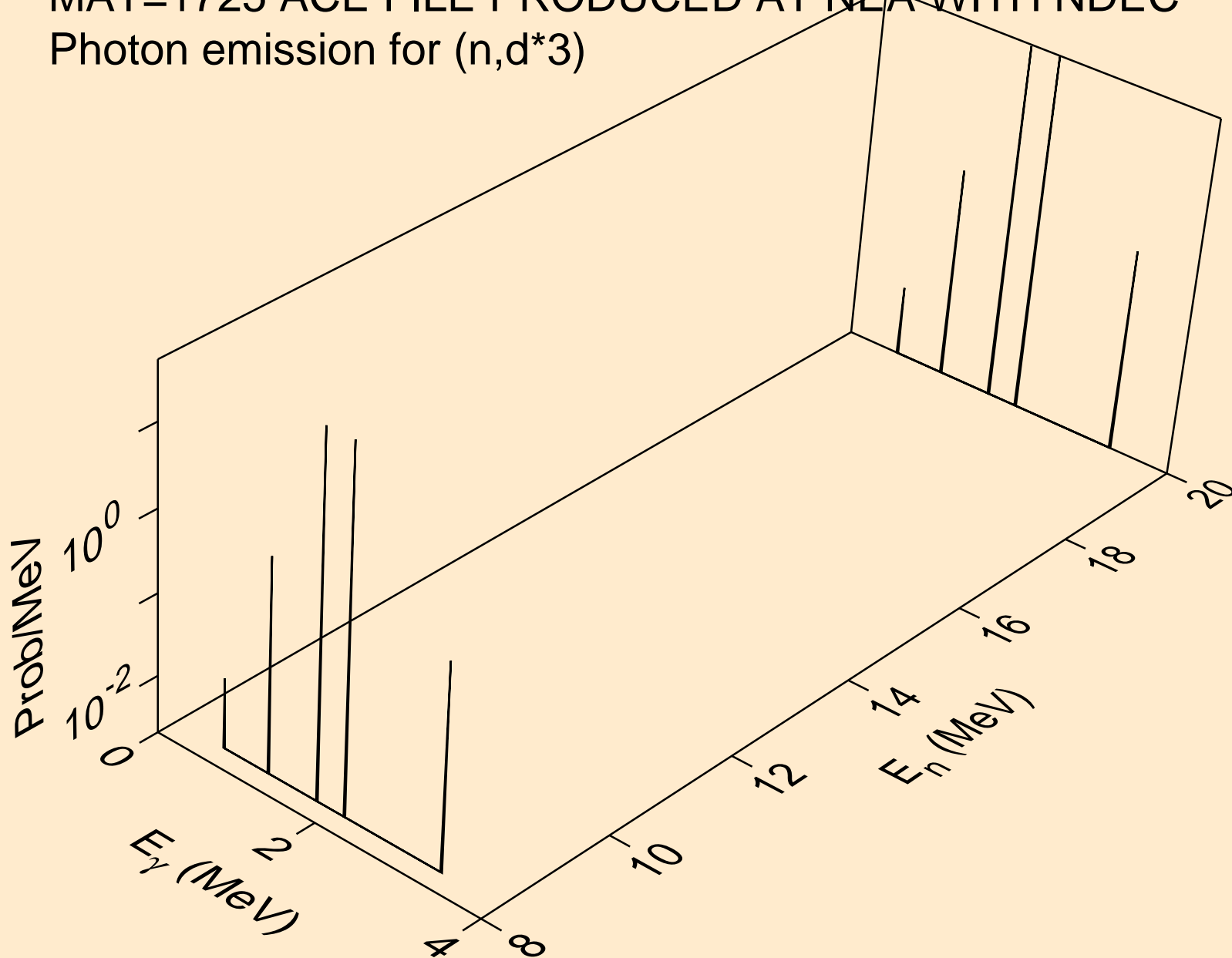

MAT=1725 ACE FILE PRODUCED AT NEA WITH NDEC
Photon emission for (n,d*4)

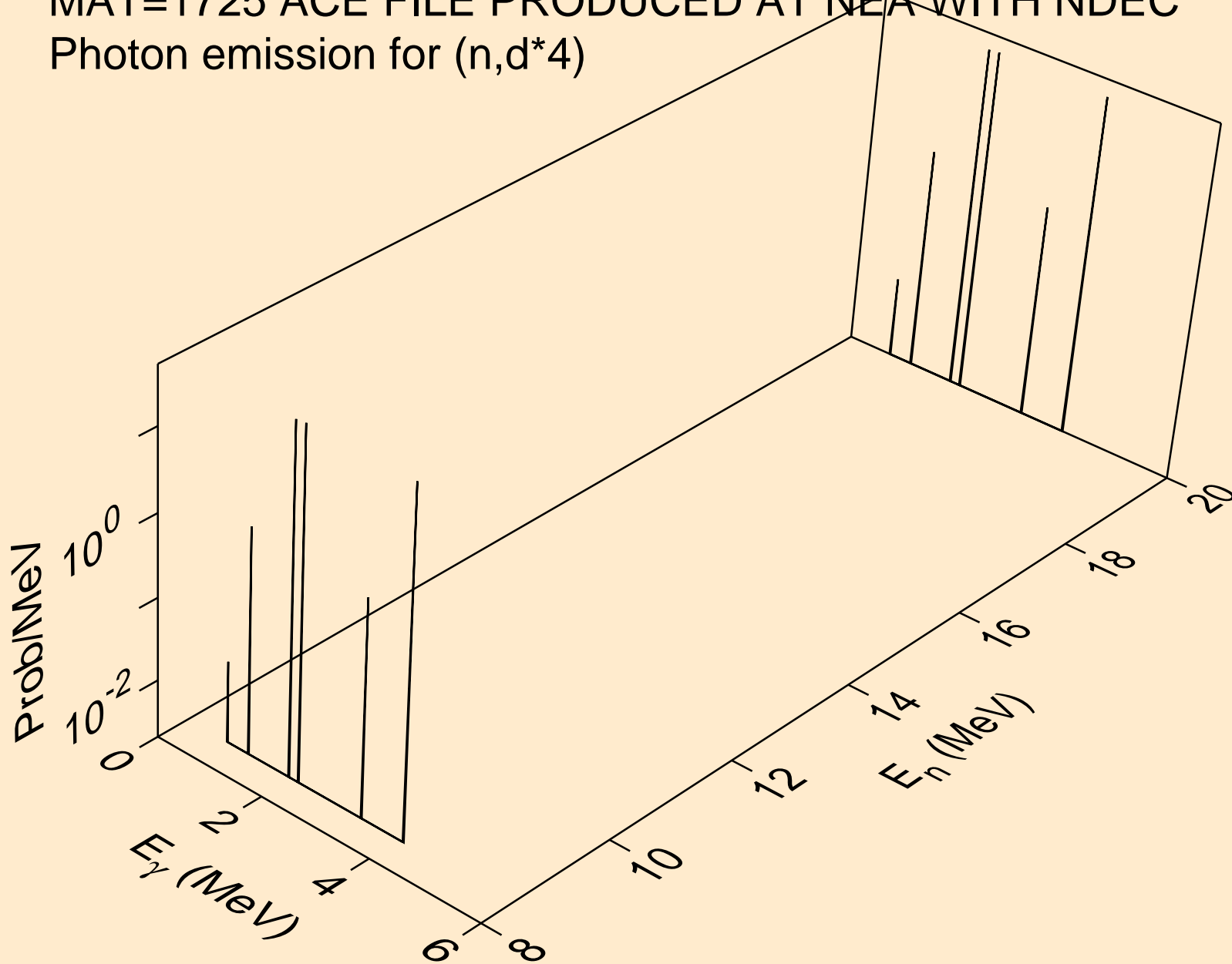

MAT=1725 ACE FILE PRODUCED AT NEA WITH NDEC
Photon emission for (n,d*5)

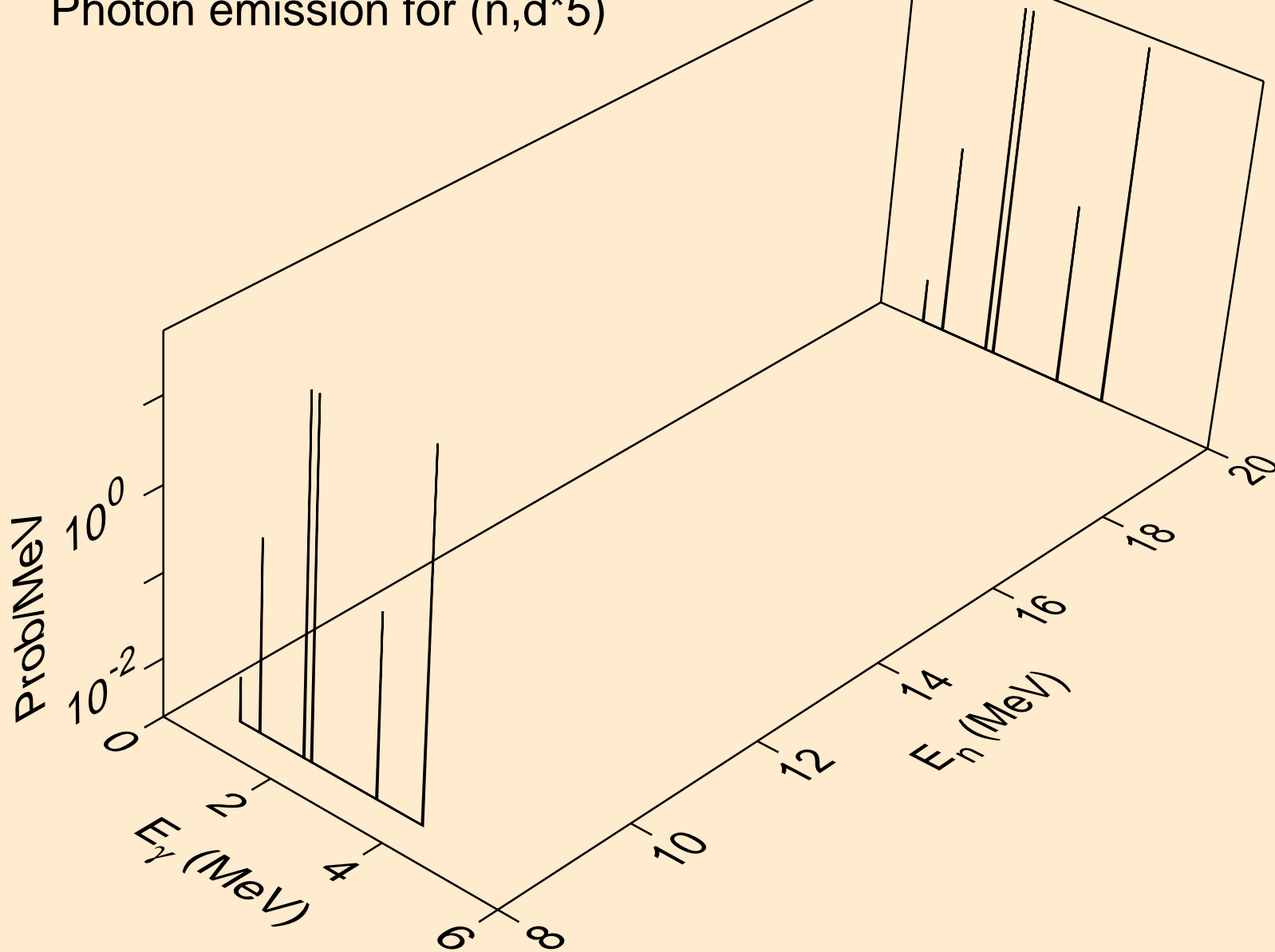

MAT=1725 ACE FILE PRODUCED AT NEA WITH NDEC
Photon emission for (n,d*6)

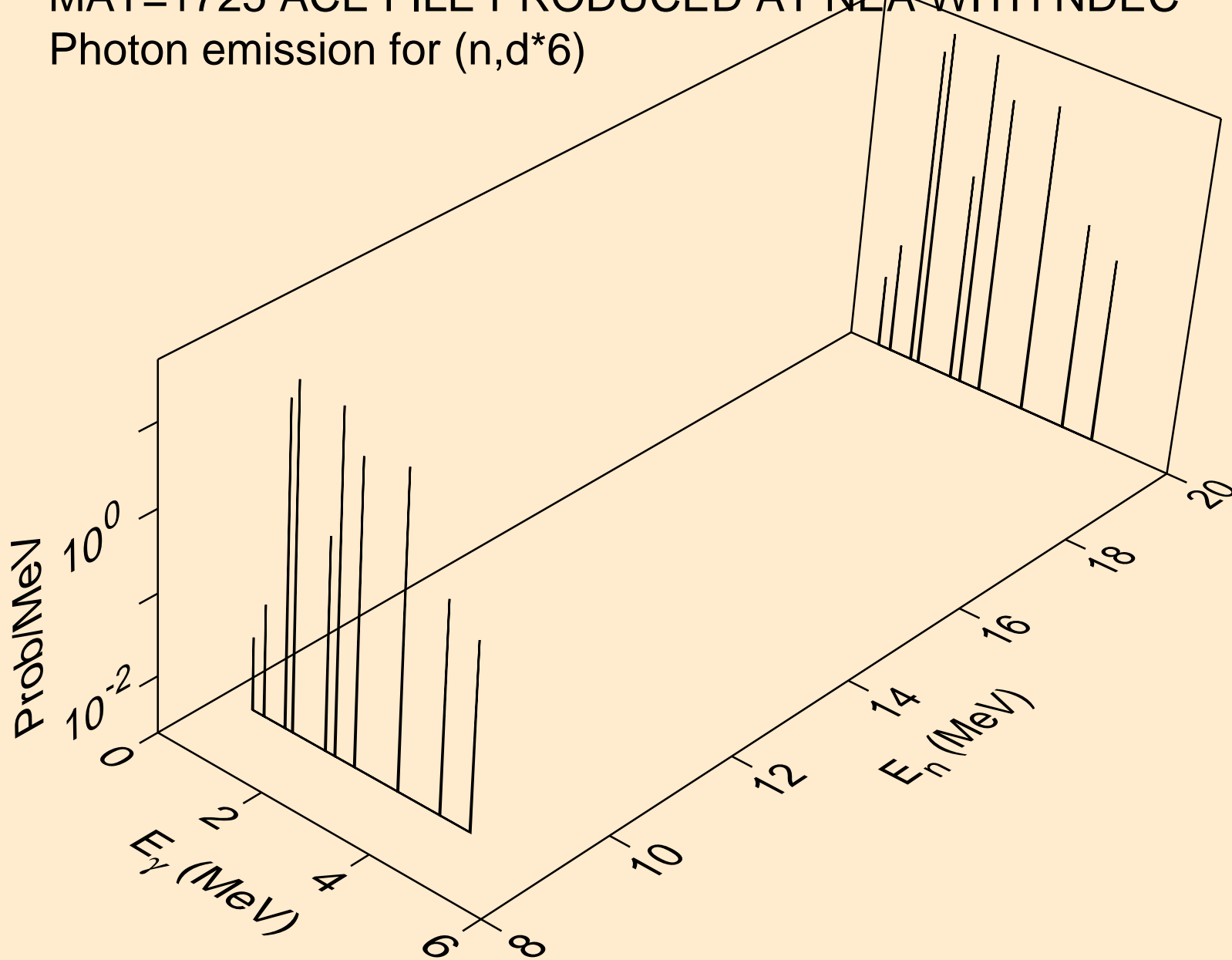

MAT=1725 ACE FILE PRODUCED AT NEA WITH NDEC
Photon emission for (n,d*7)

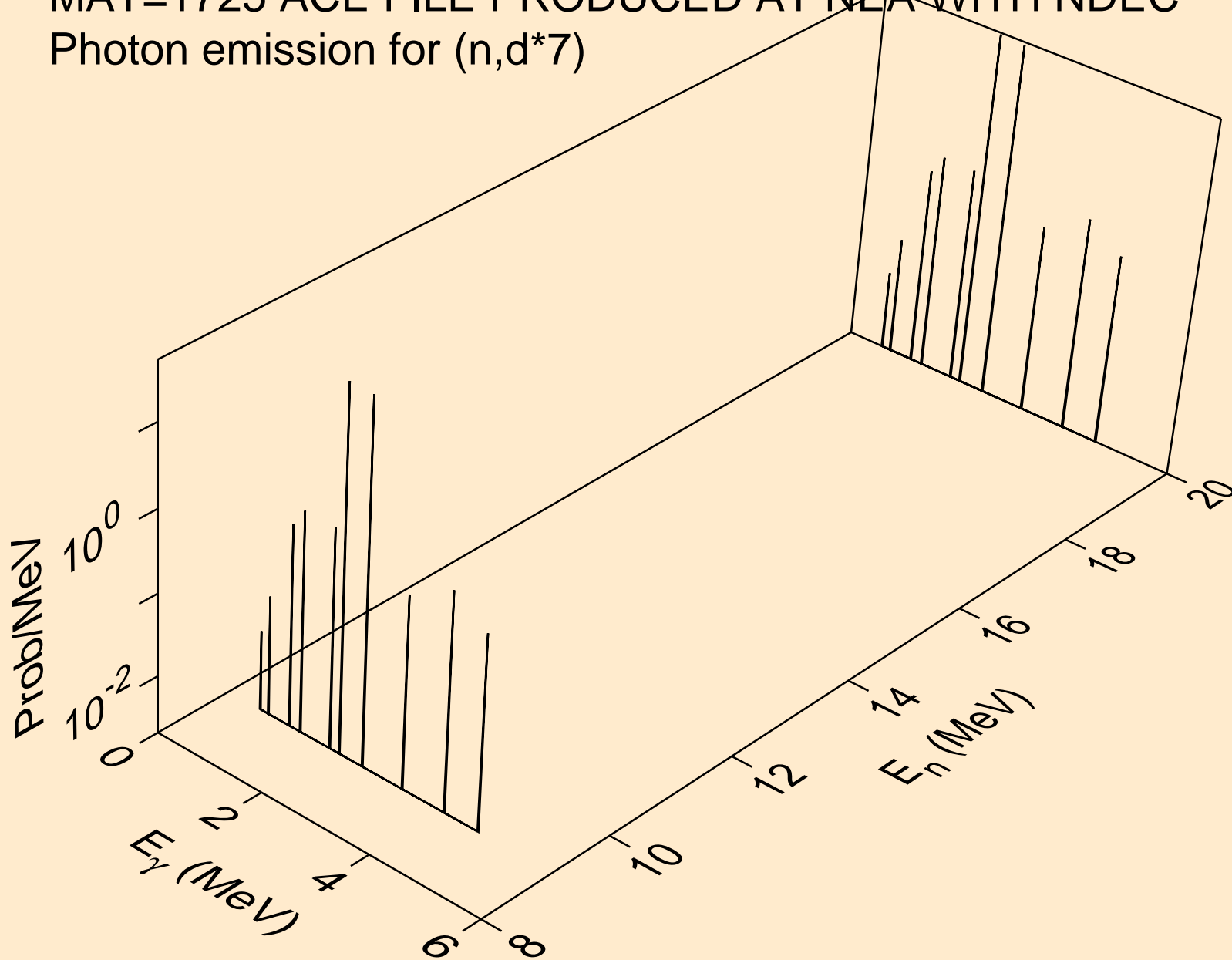

MAT=1725 ACE FILE PRODUCED AT NEA WITH NDEC
Photon emission for (n,d*8)

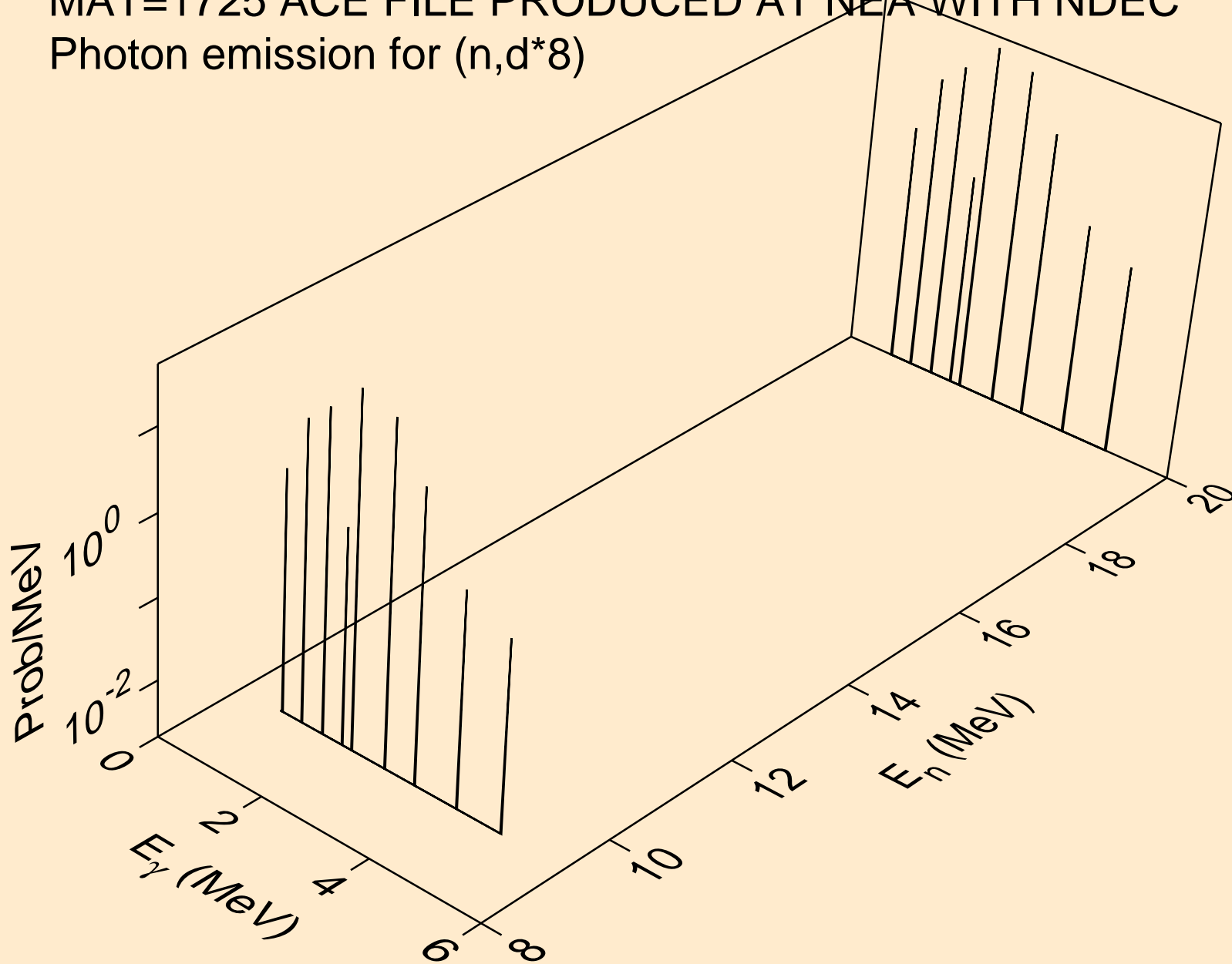

MAT=1725 ACE FILE PRODUCED AT NEA WITH NDEC
Photon emission for (n,d*9)

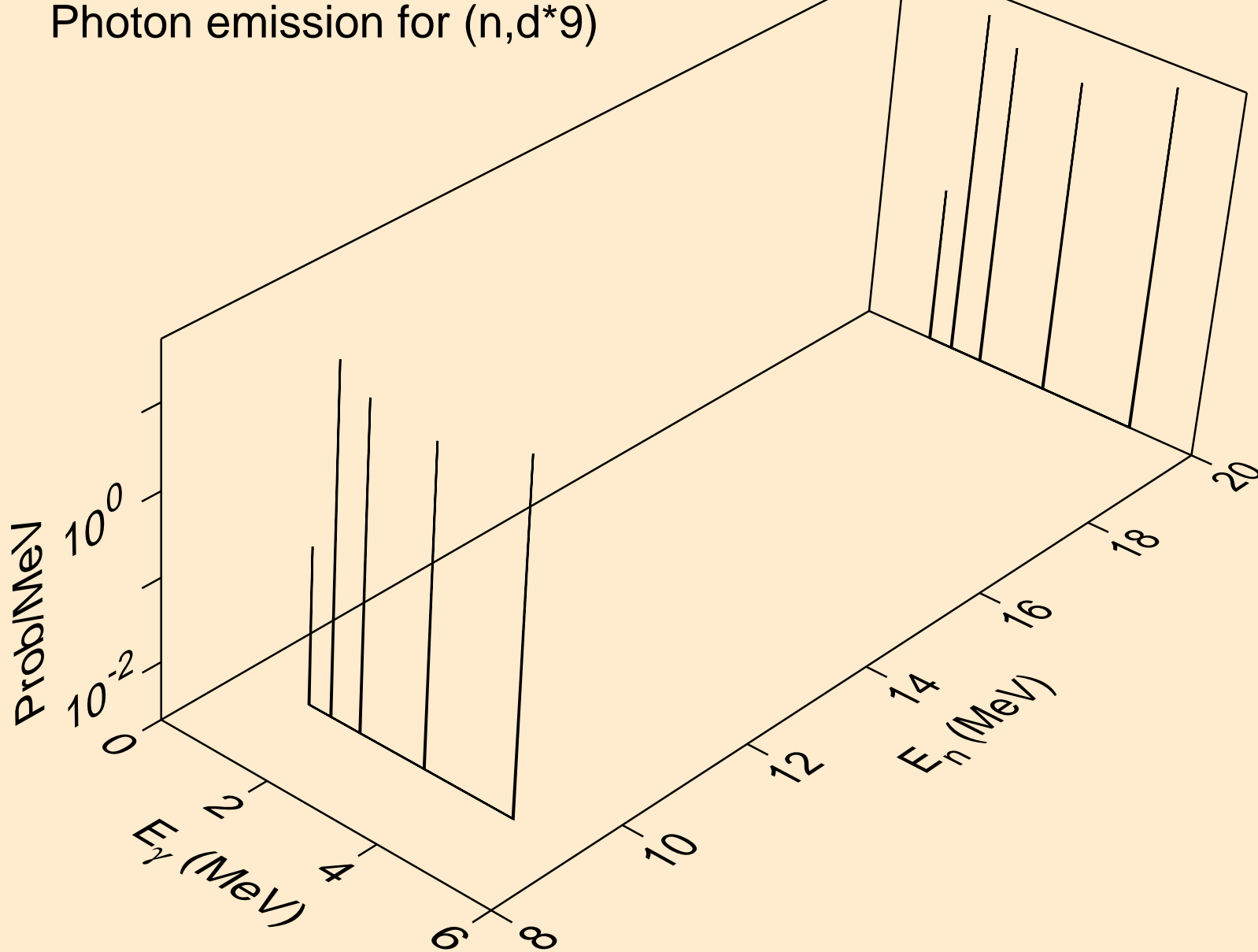

MAT=1725 ACE FILE PRODUCED AT NEA WITH NDEC
Photon emission for (n,d*10)

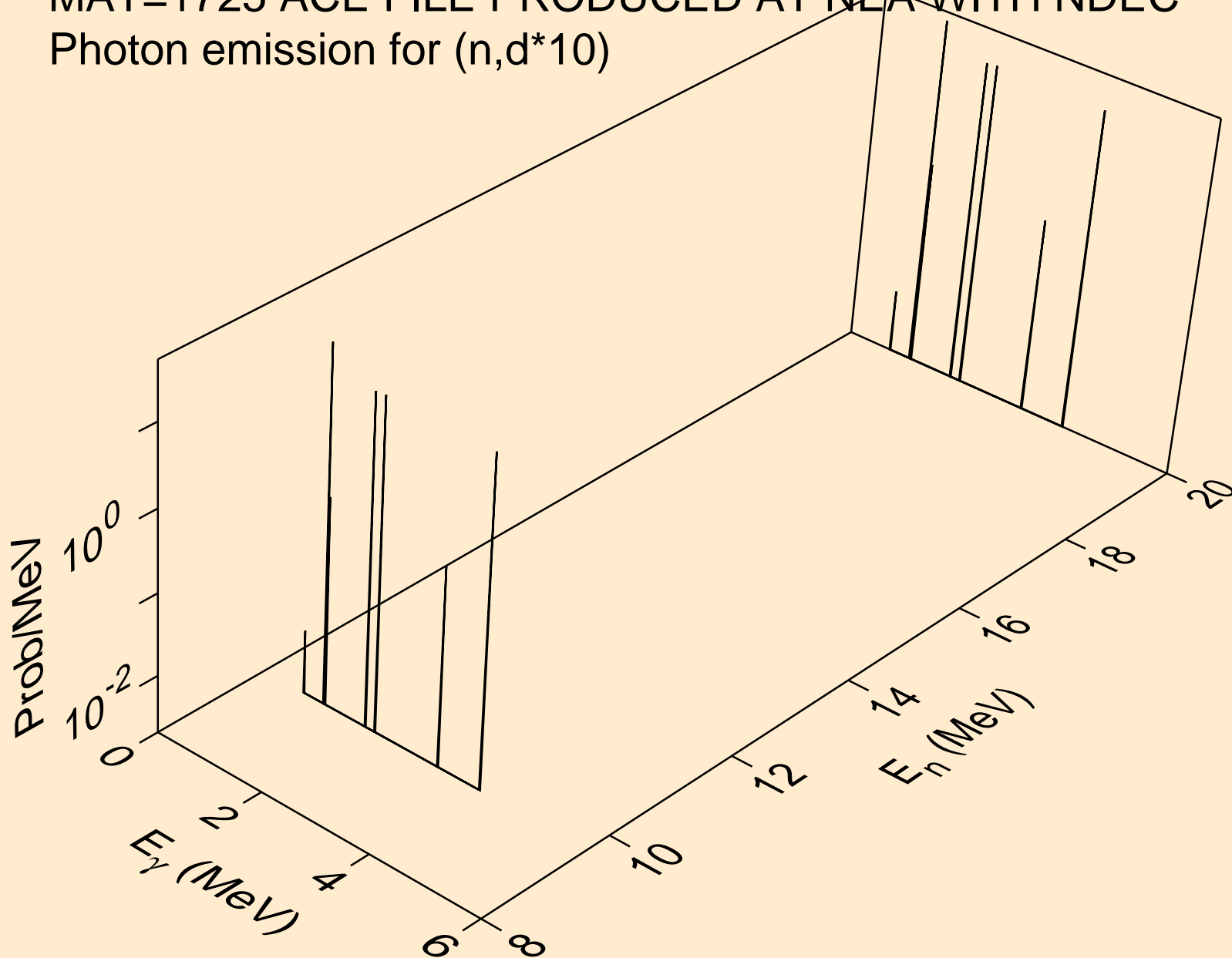

MAT=1725 ACE FILE PRODUCED AT NEA WITH NDEC
Photon emission for (n,d*11)

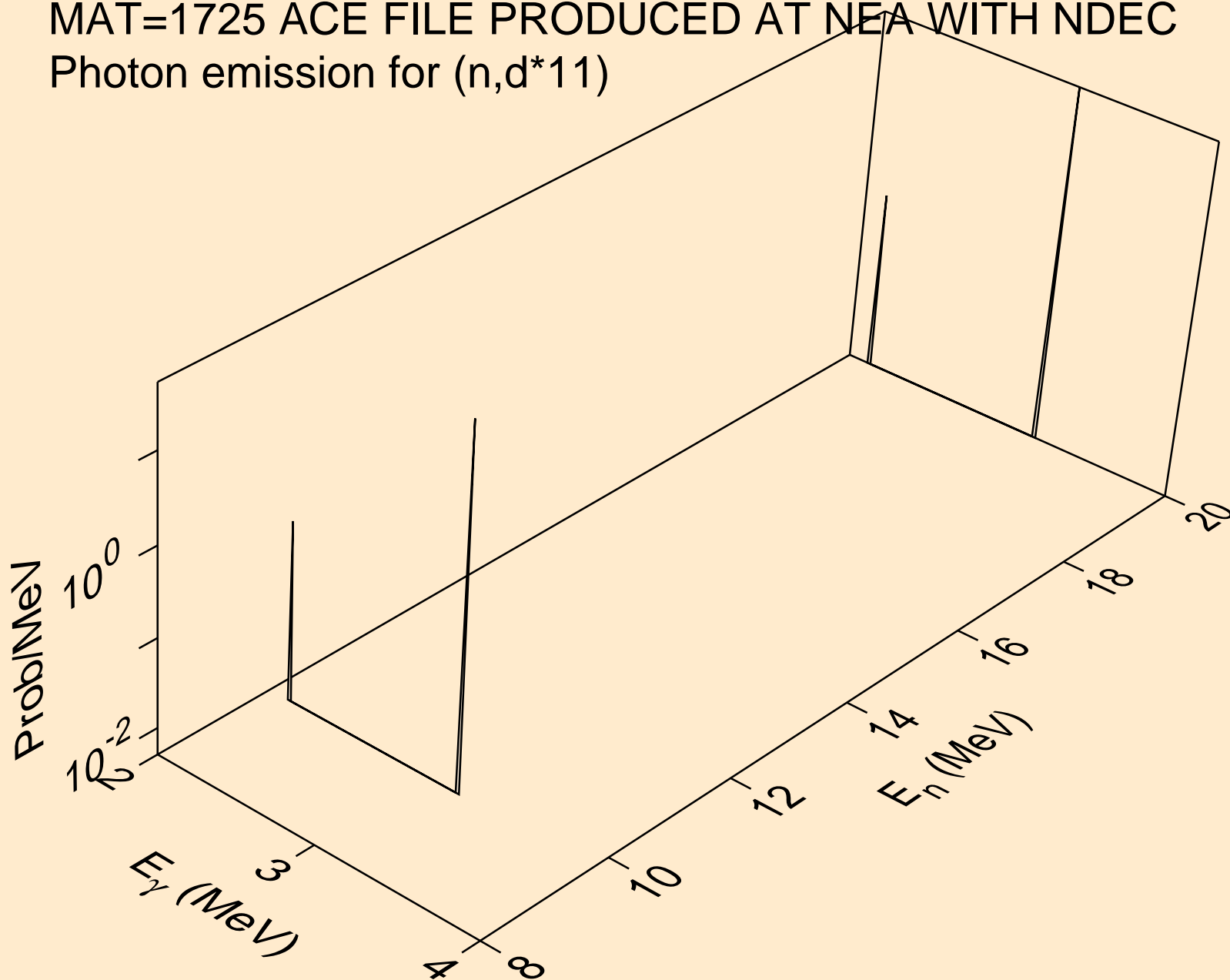

MAT=1725 ACE FILE PRODUCED AT NEA WITH NDEC
Photon emission for (n,d*12)

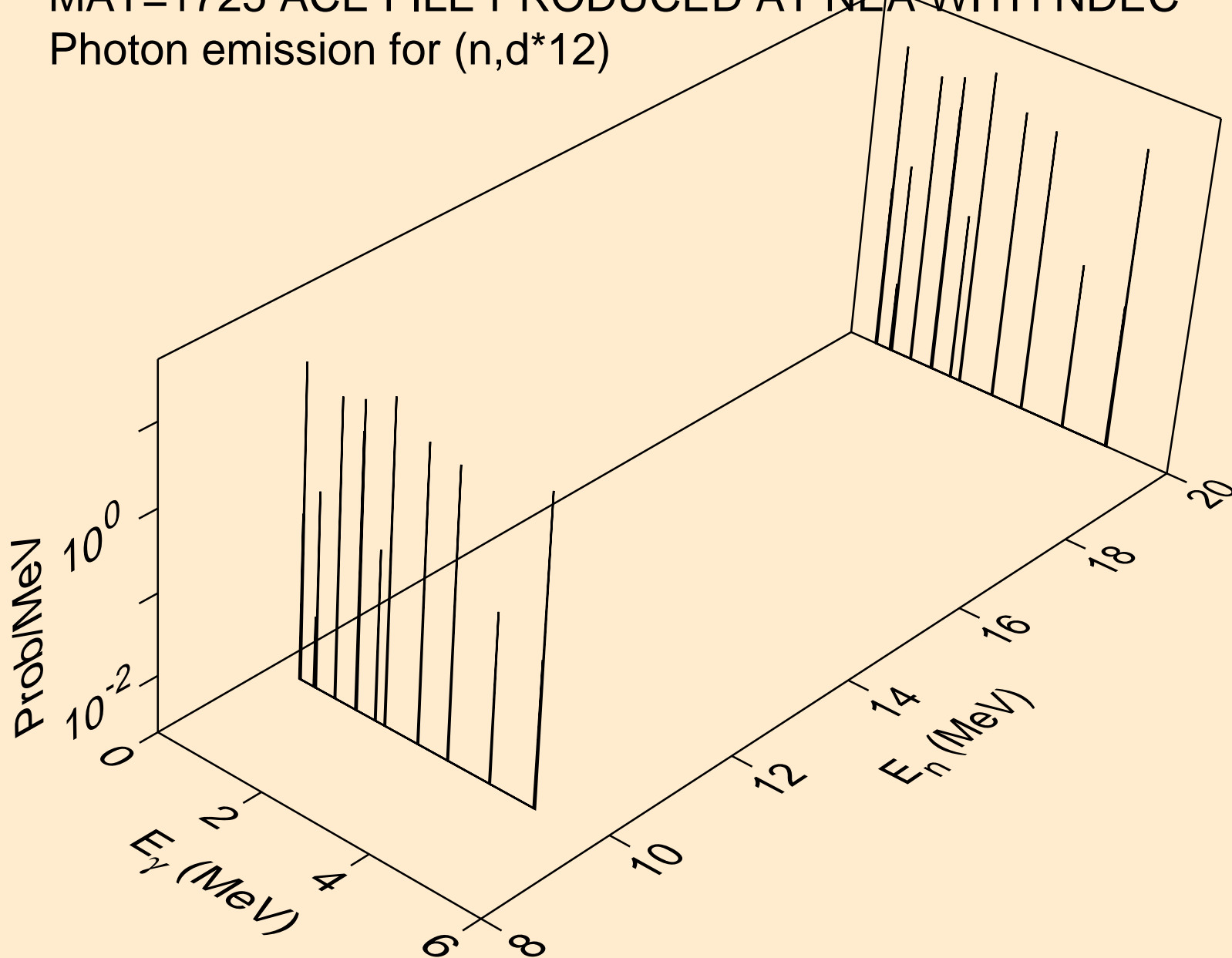

MAT=1725 ACE FILE PRODUCED AT NEA WITH NDEC
Photon emission for (n,d*13)

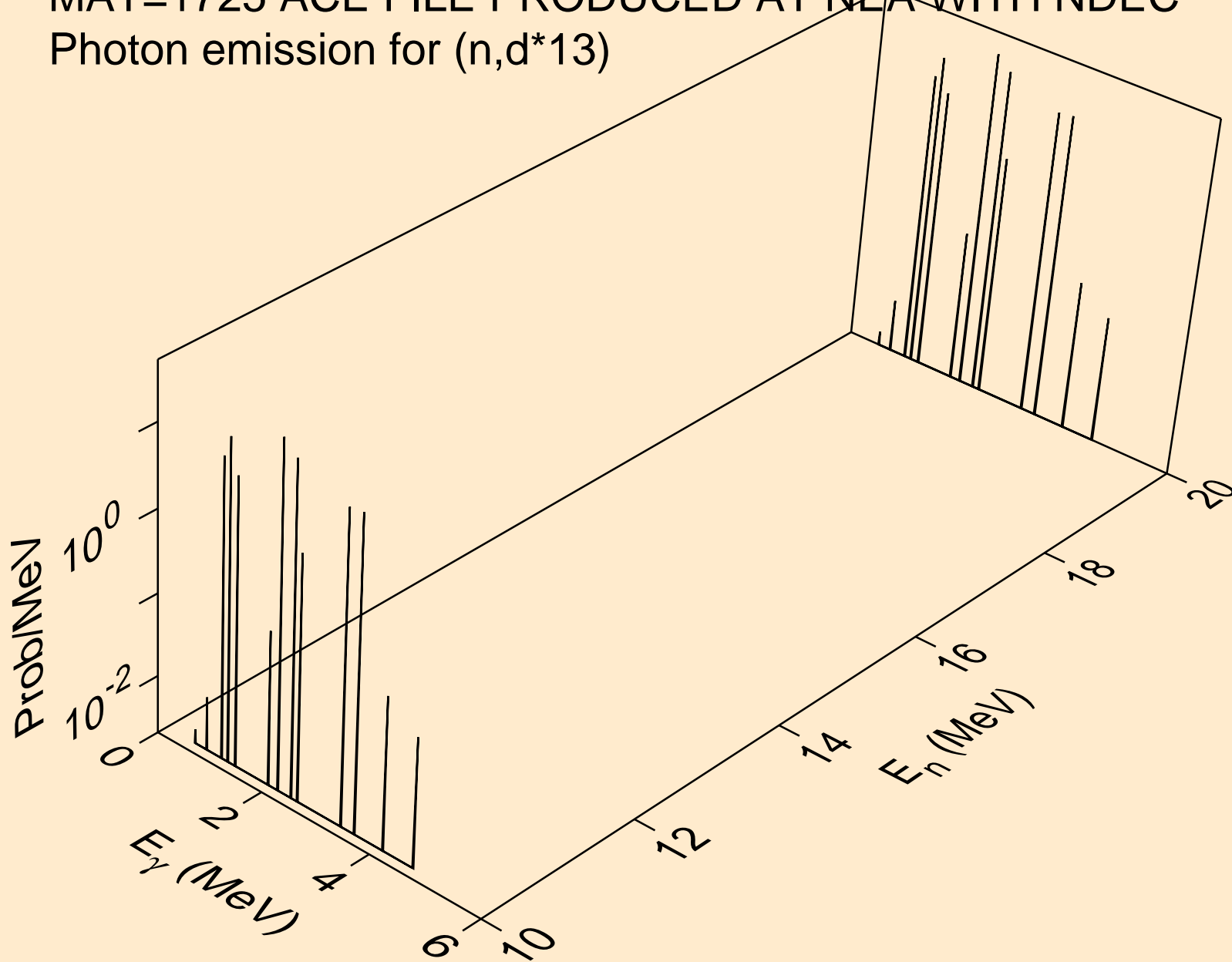

MAT=1725 ACE FILE PRODUCED AT NEA WITH NDEC
Photon emission for (n,d*14)

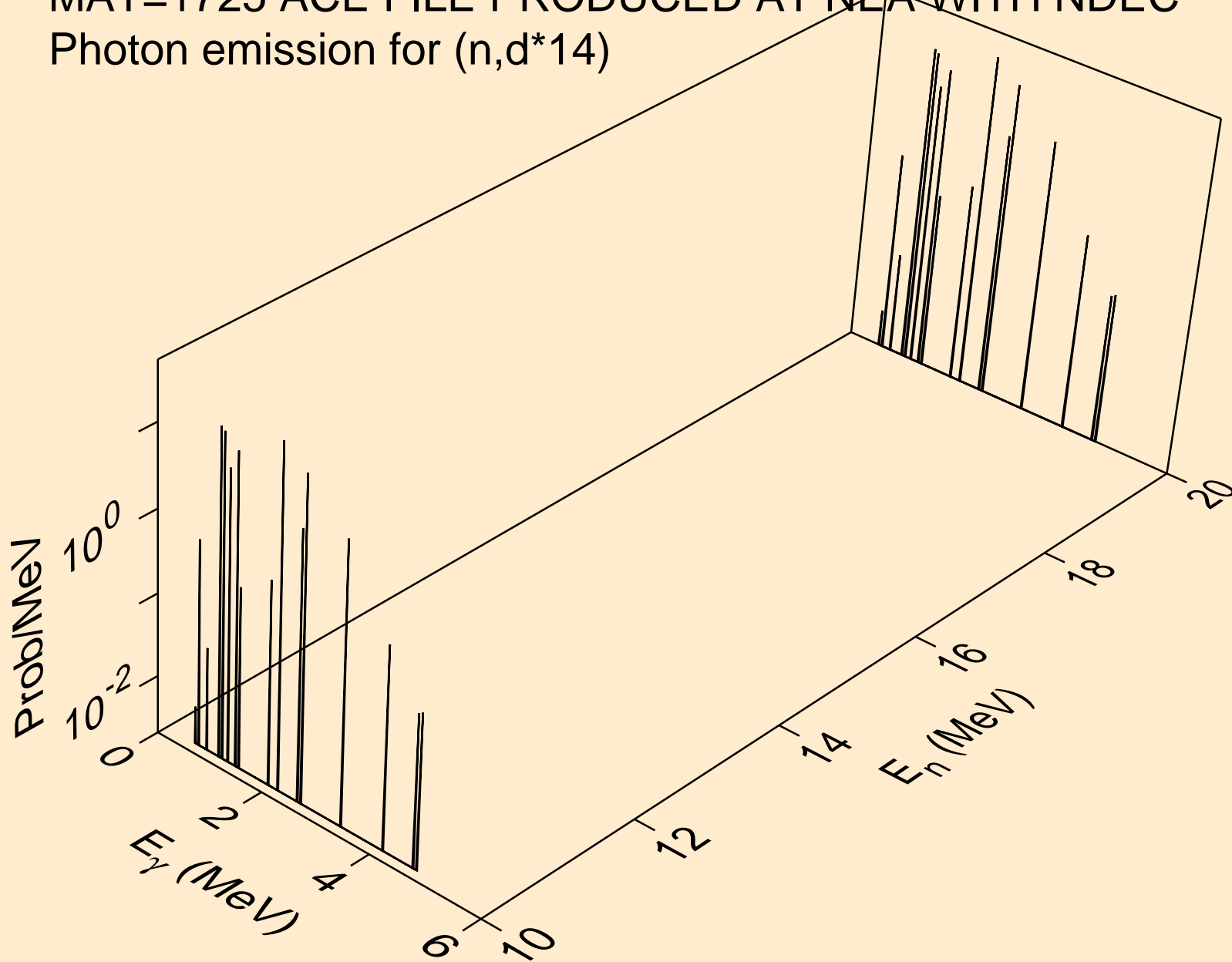

MAT=1725 ACE FILE PRODUCED AT NEA WITH NDEC
Photon emission for (n,d*15)

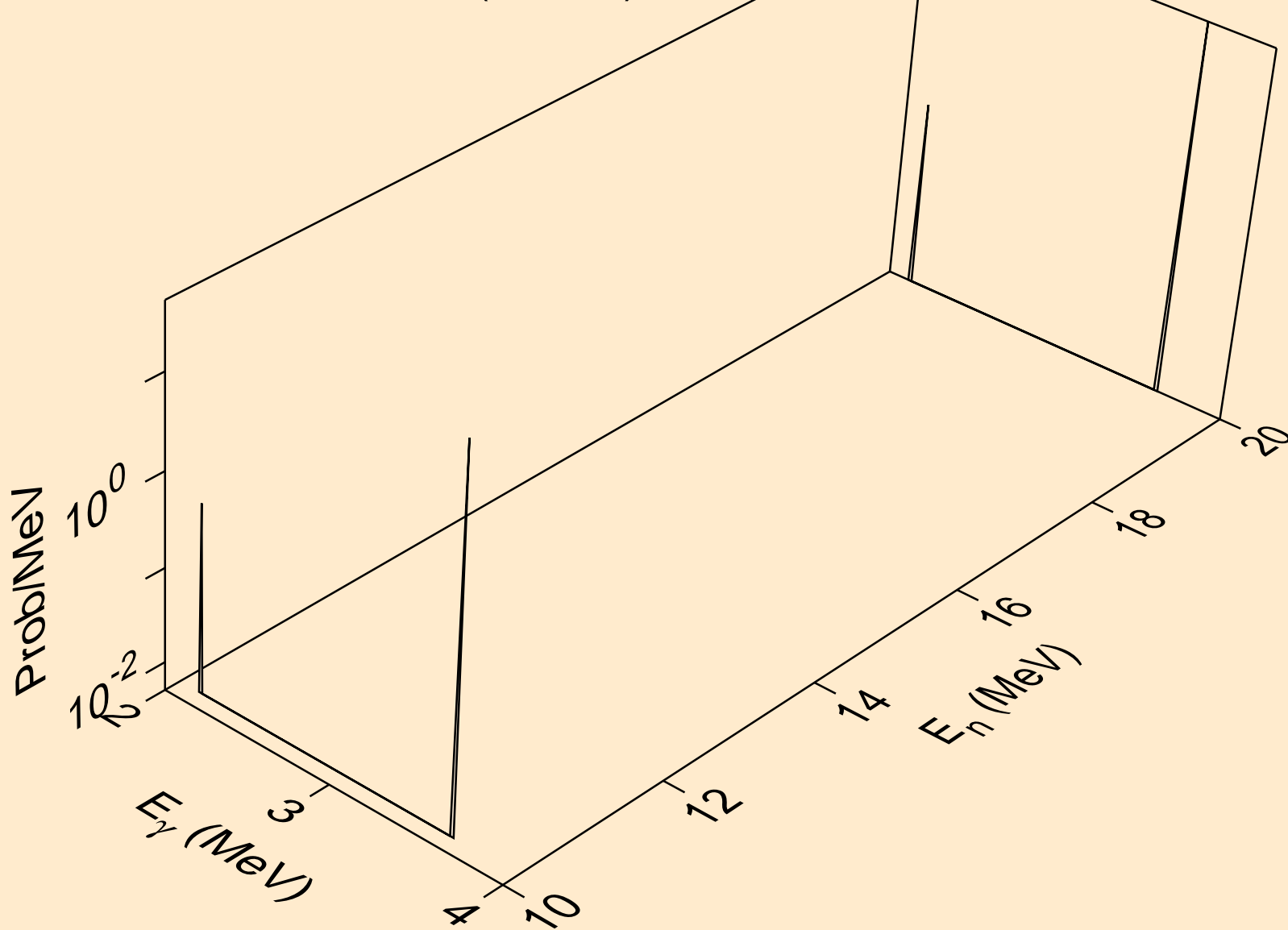

MAT=1725 ACE FILE PRODUCED AT NEA WITH NDEC
Photon emission for (n,d*16)

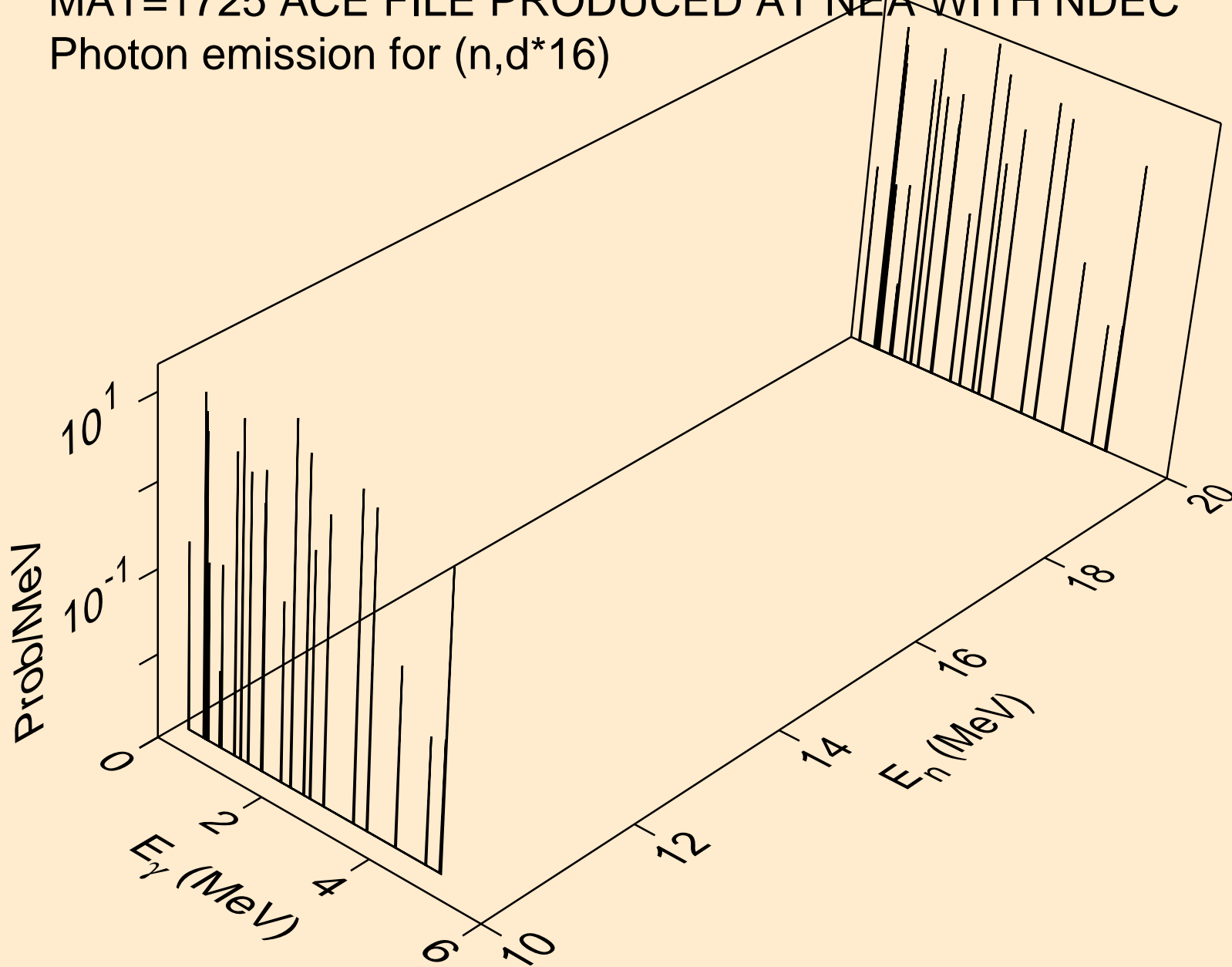

MAT=1725 ACE FILE PRODUCED AT NEA WITH NDEC
Photon emission for (n,d*17)

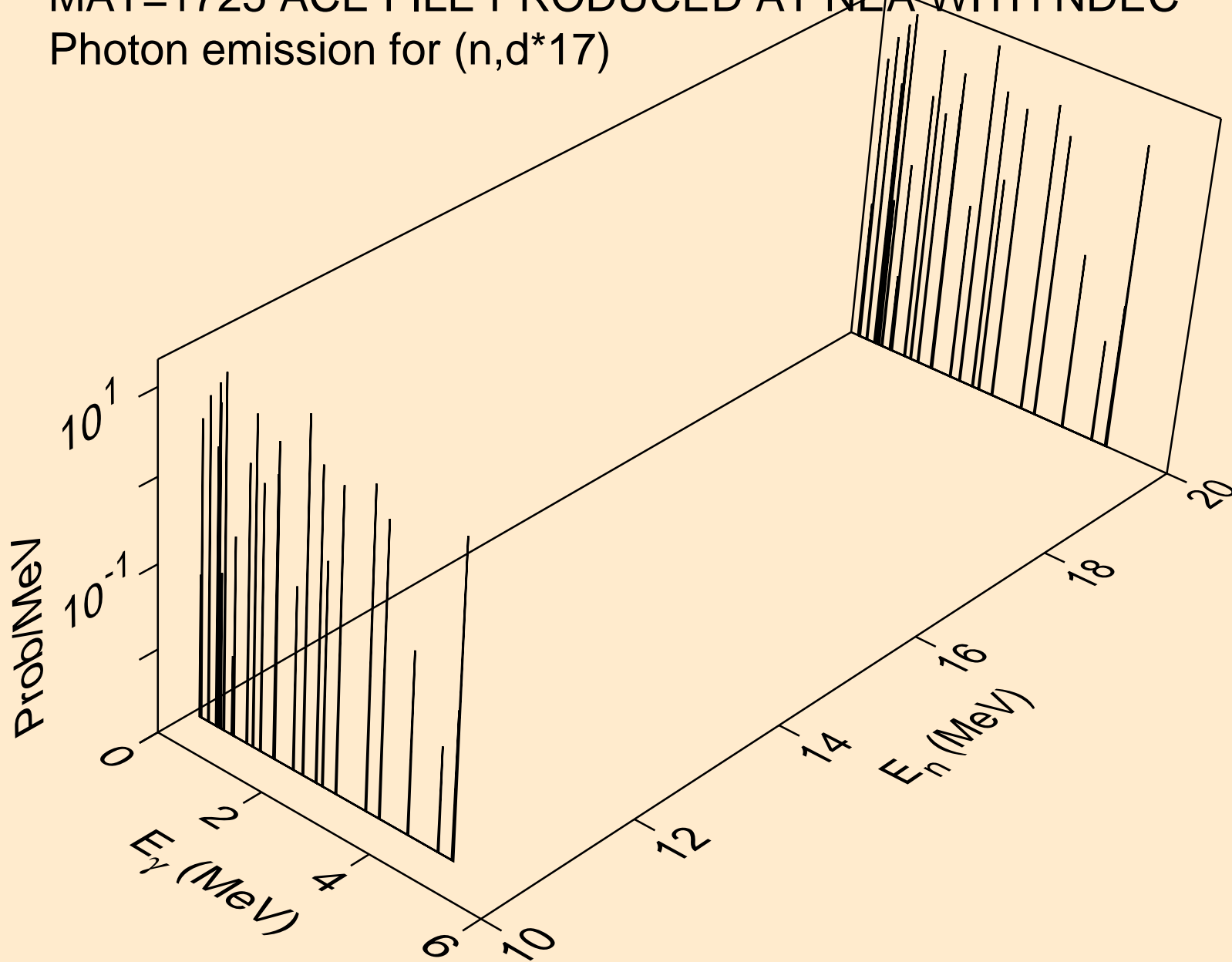

MAT=1725 ACE FILE PRODUCED AT NEA WITH NDEC
Photon emission for (n,d*18)

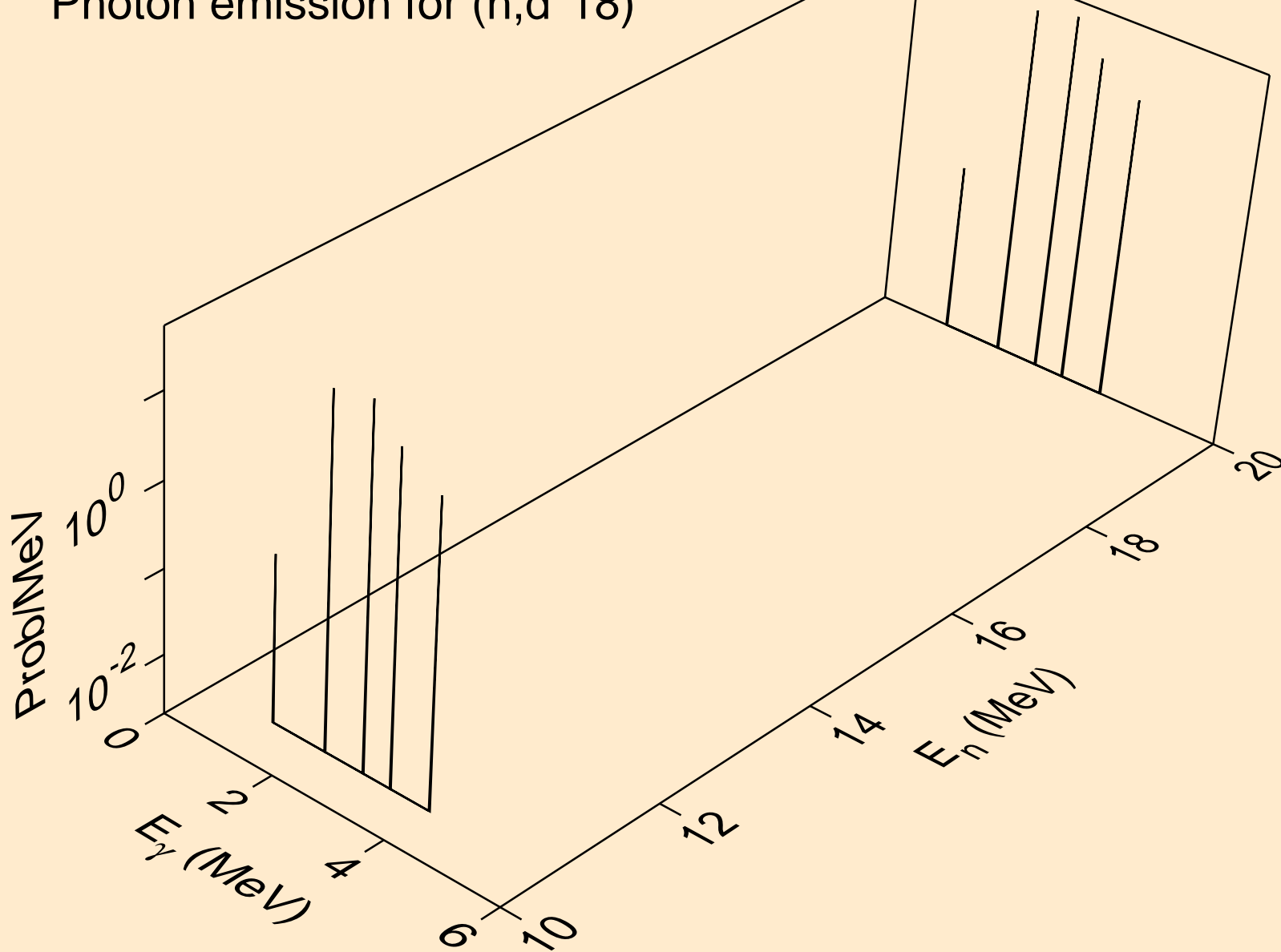

MAT=1725 ACE FILE PRODUCED AT NEA WITH NDEC
Photon emission for (n,d*19)

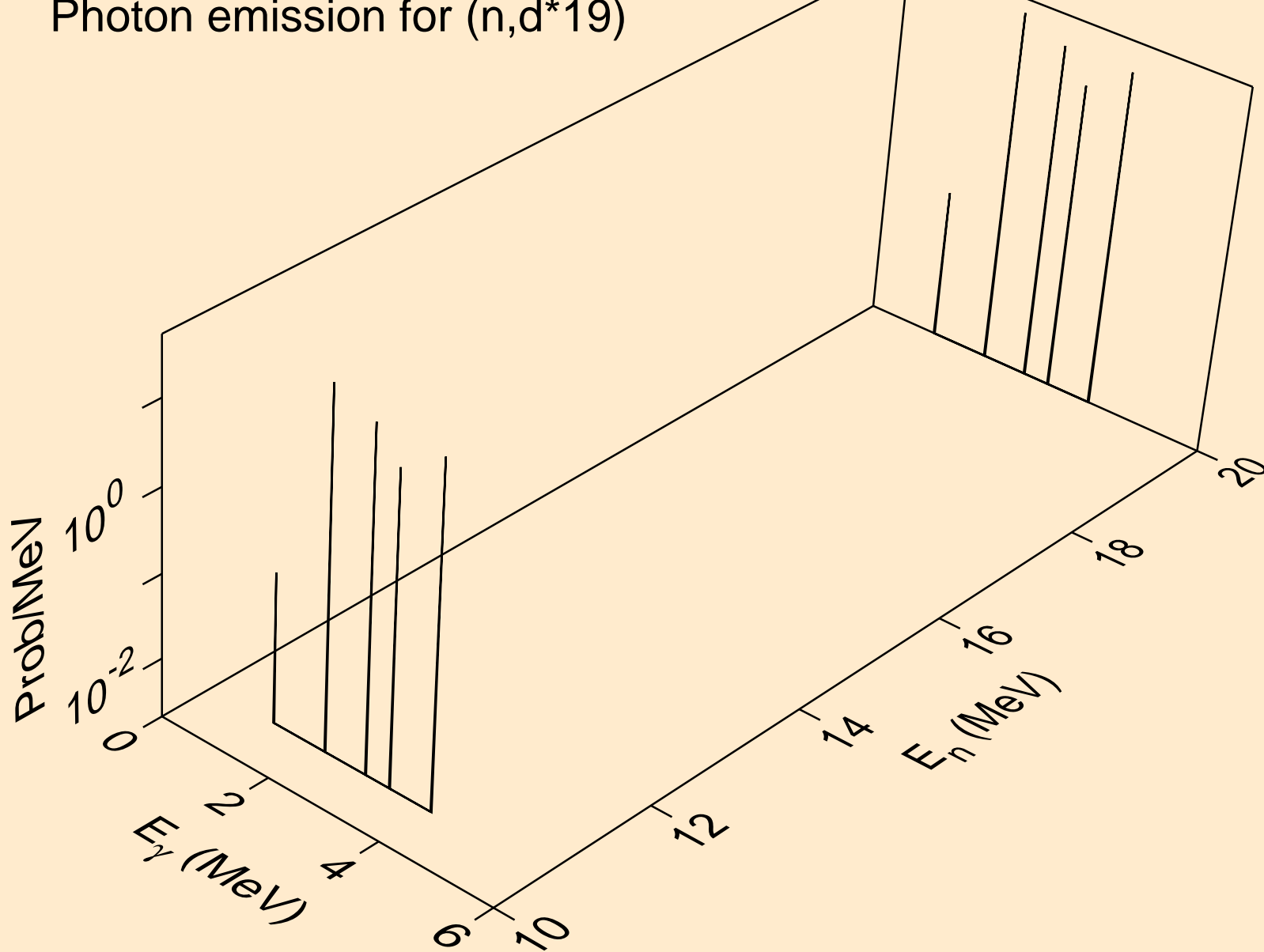

MAT=1725 ACE FILE PRODUCED AT NEA WITH NDEC
Photon emission for (n,d*20)

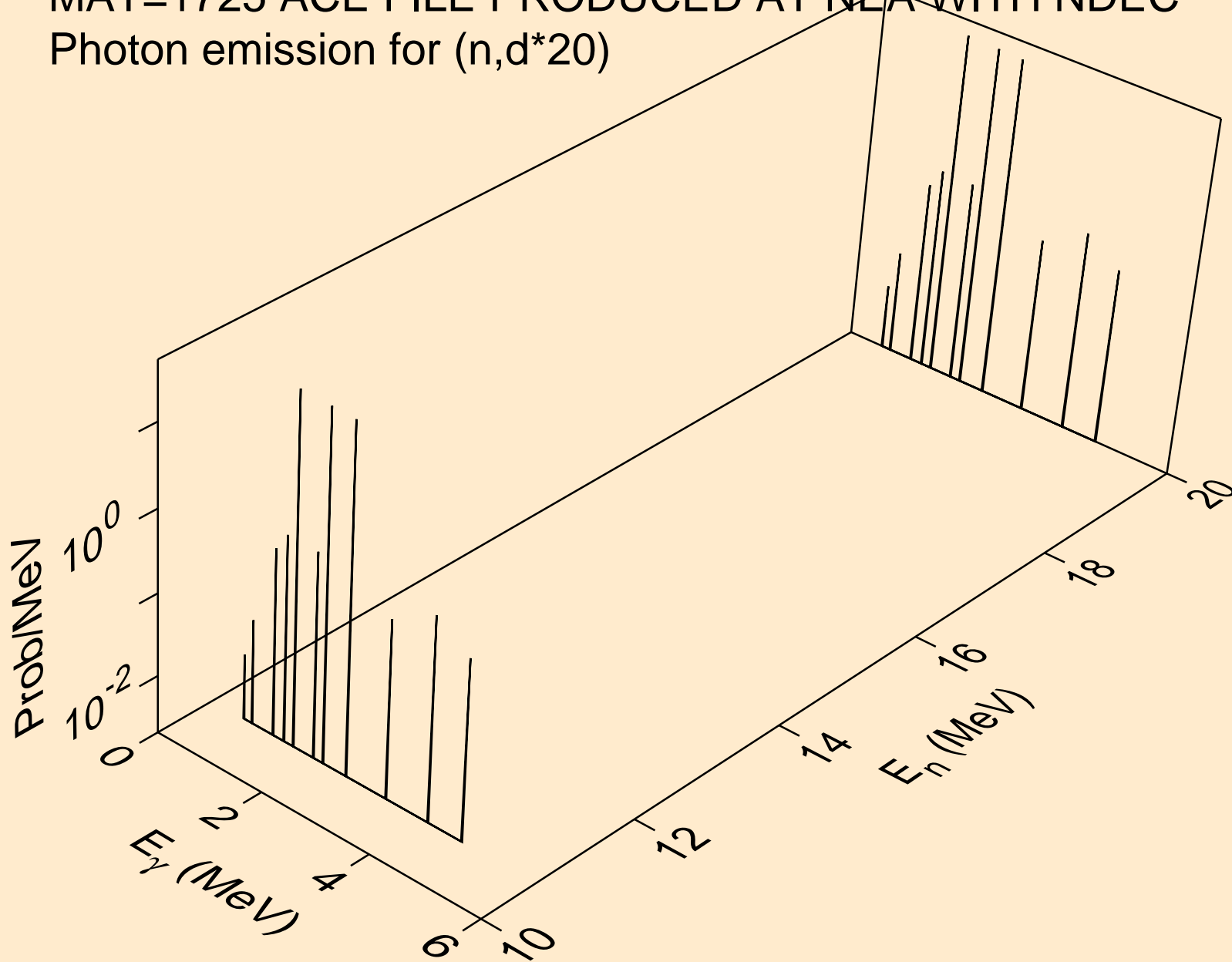

MAT=1725 ACE FILE PRODUCED AT NEA WITH NDEC
Photon emission for (n,d*21)

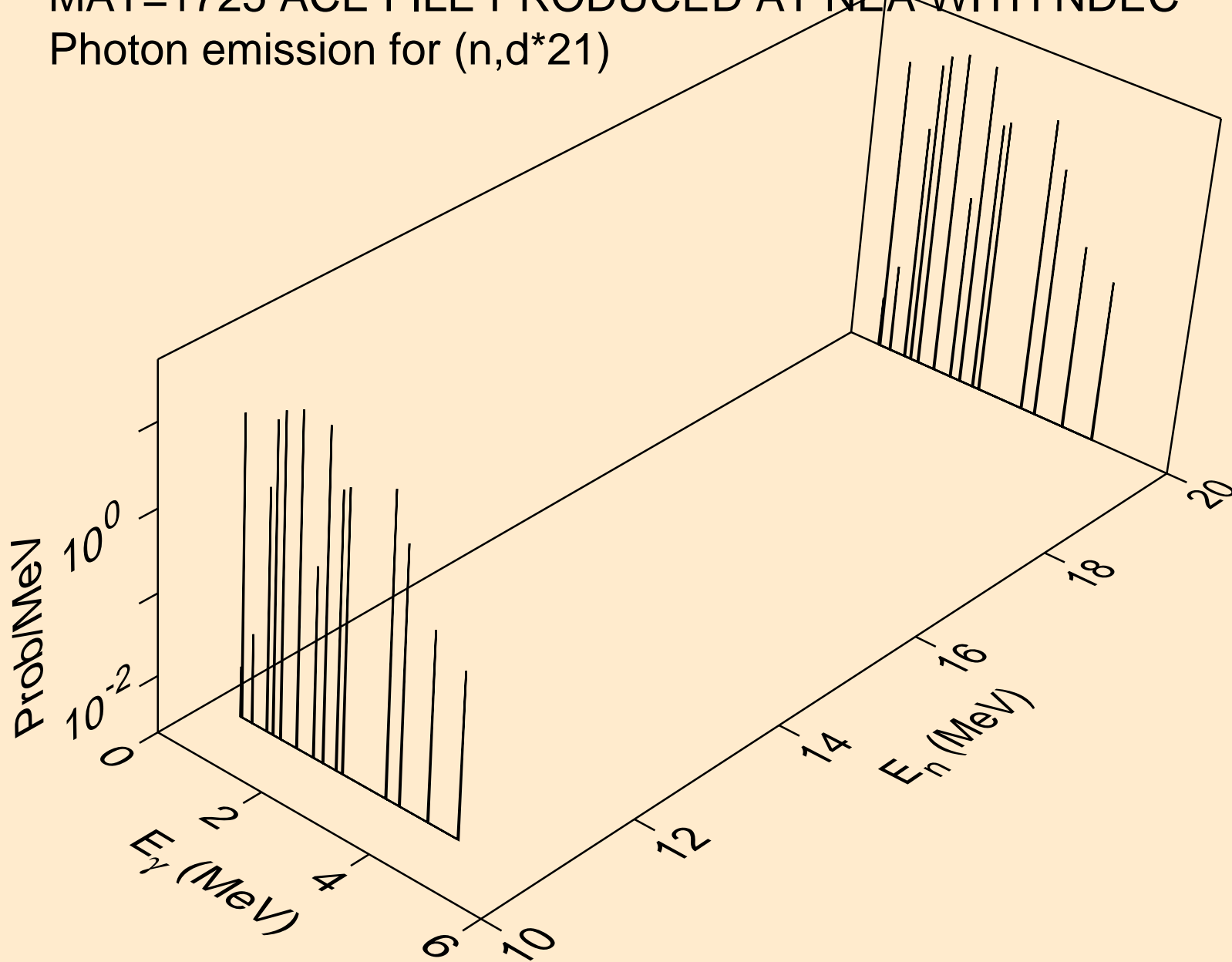

MAT=1725 ACE FILE PRODUCED AT NEA WITH NDEC
Photon emission for (n,d*22)

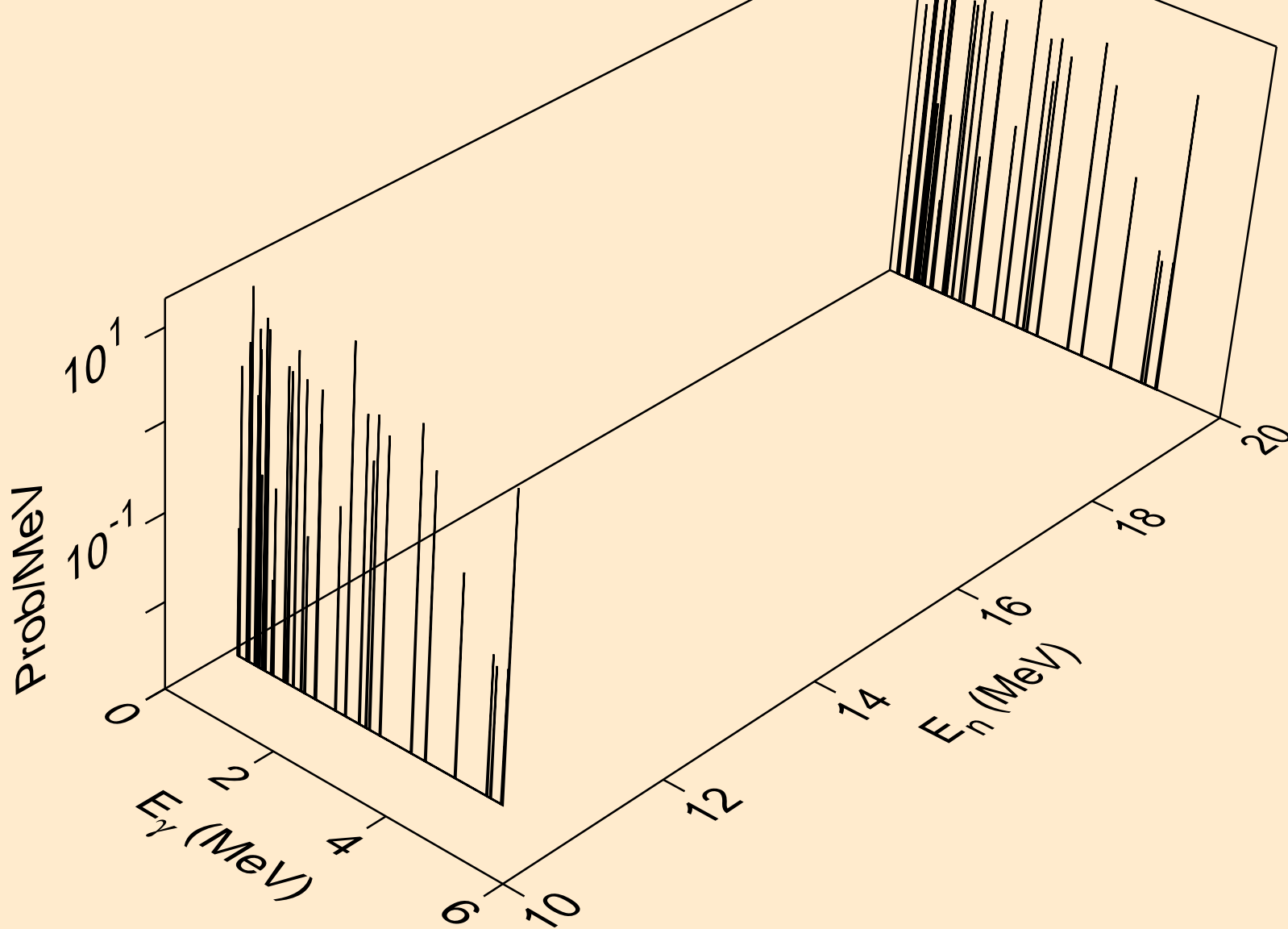

MAT=1725 ACE FILE PRODUCED AT NEA WITH NDEC
Photon emission for (n,d*23)

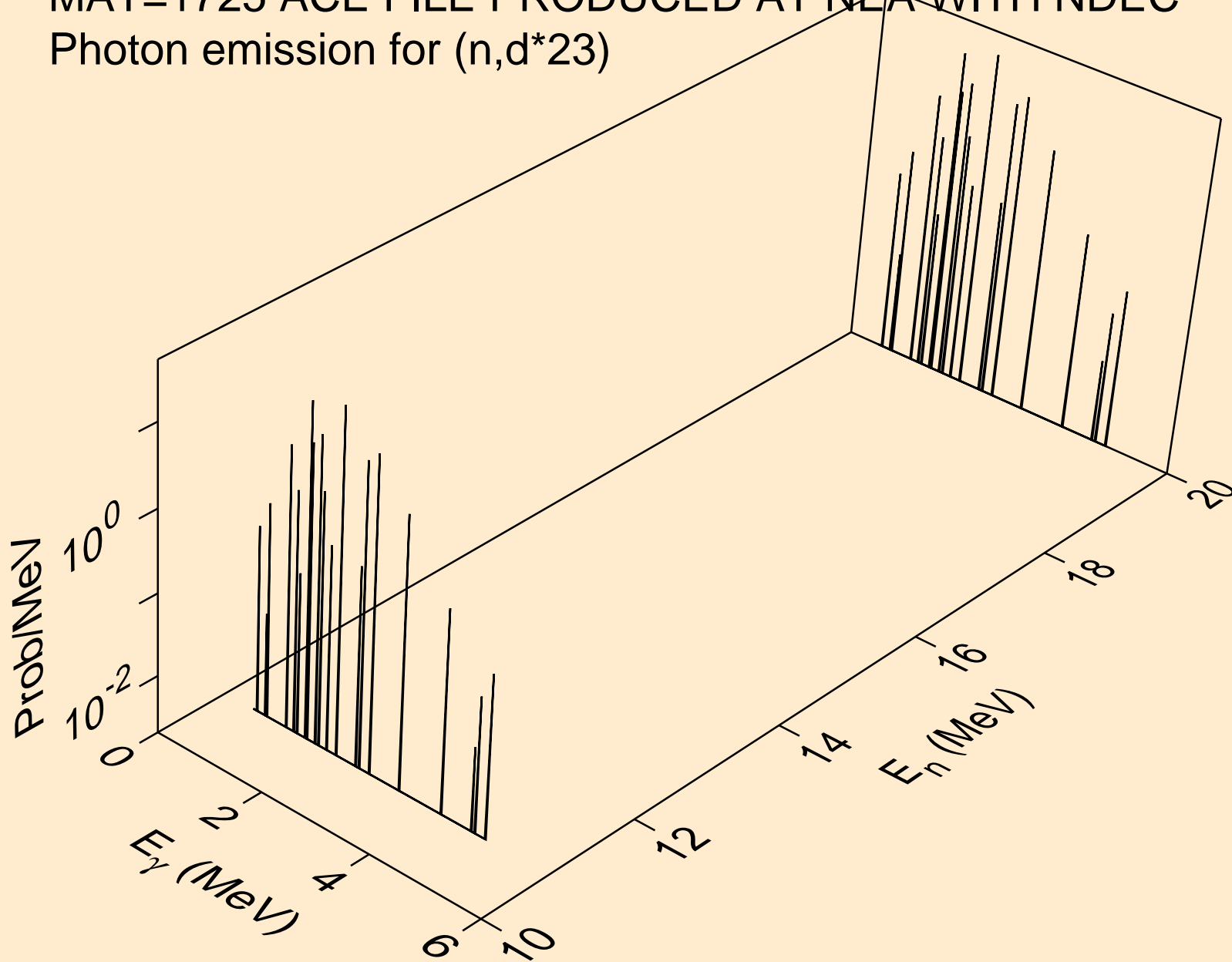

MAT=1725 ACE FILE PRODUCED AT NEA WITH NDEC
Photon emission for (n,d*24)

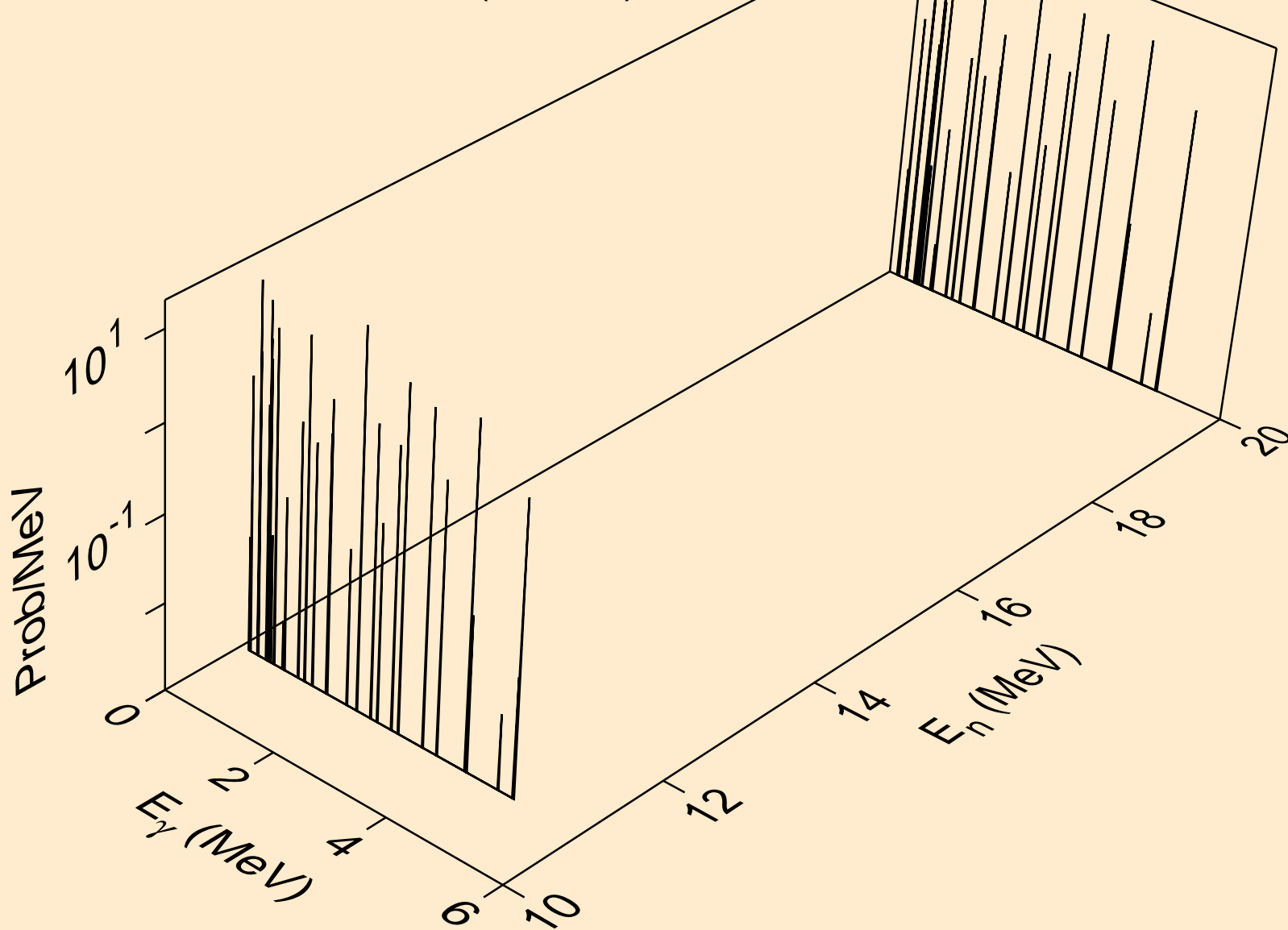

MAT=1725 ACE FILE PRODUCED AT NEA WITH NDEC
Photon emission for (n,d*25)

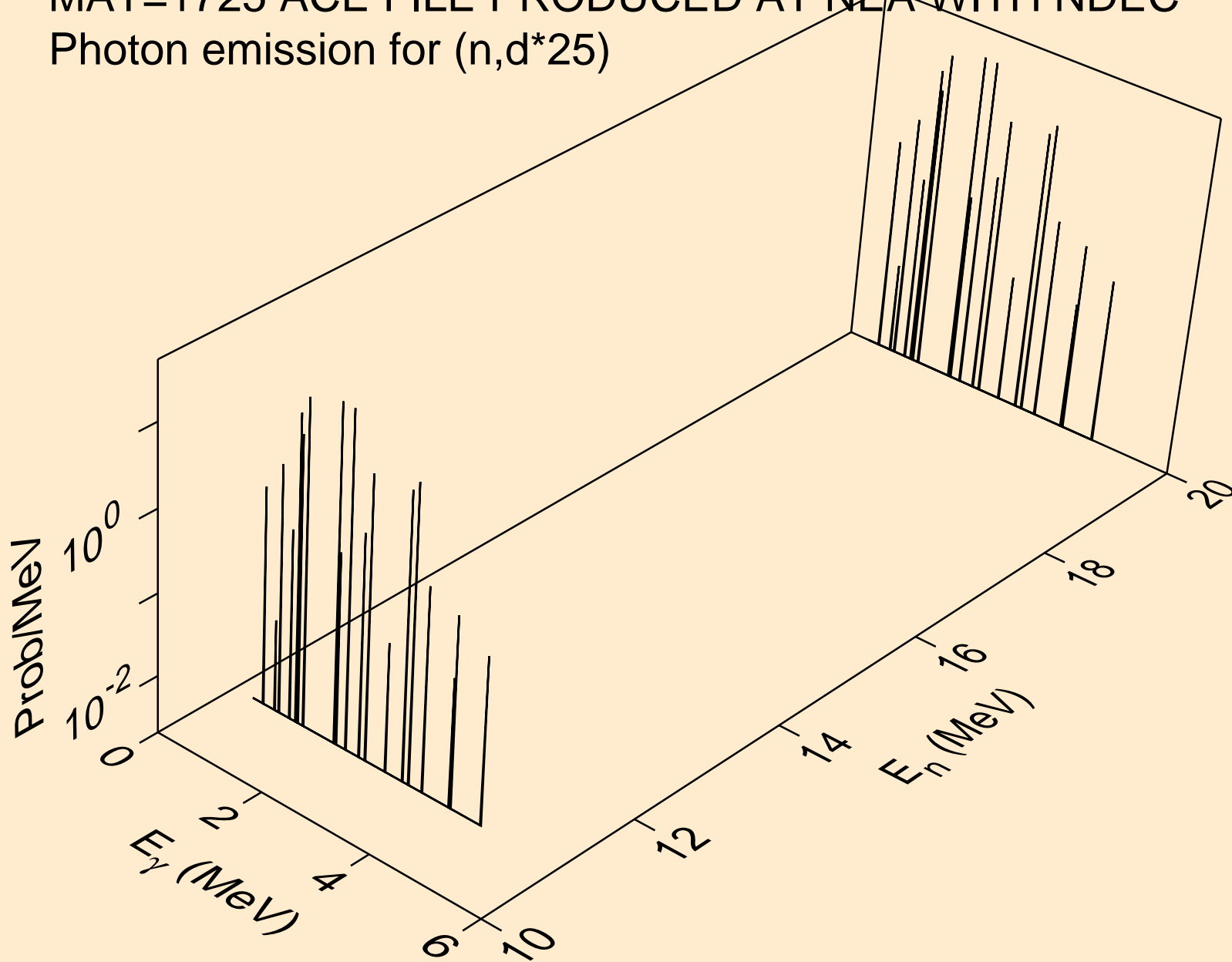

MAT=1725 ACE FILE PRODUCED AT NEA WITH NDEC
Photon emission for (n,d*26)

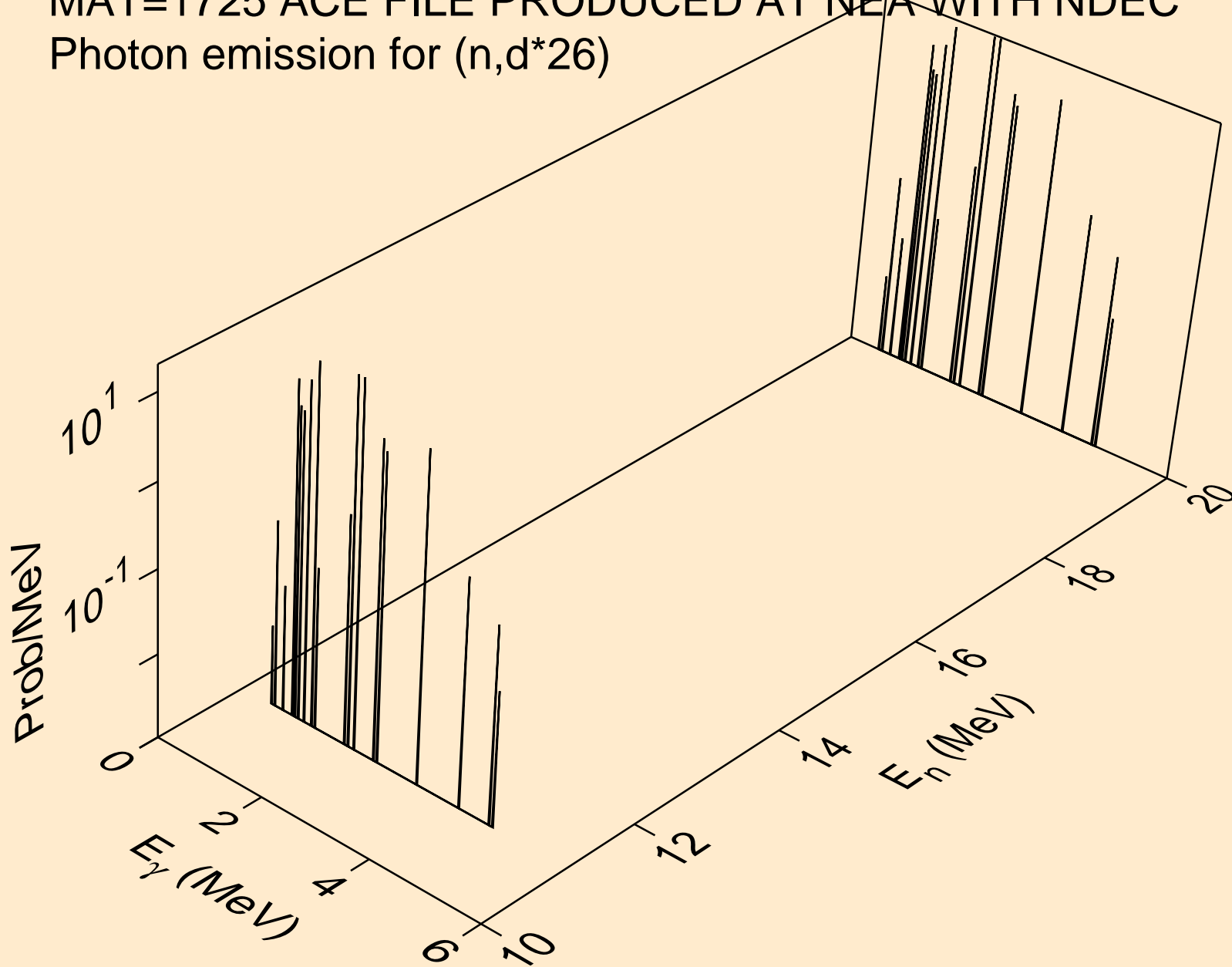

MAT=1725 ACE FILE PRODUCED AT NEA WITH NDEC
Photon emission for (n,d*27)

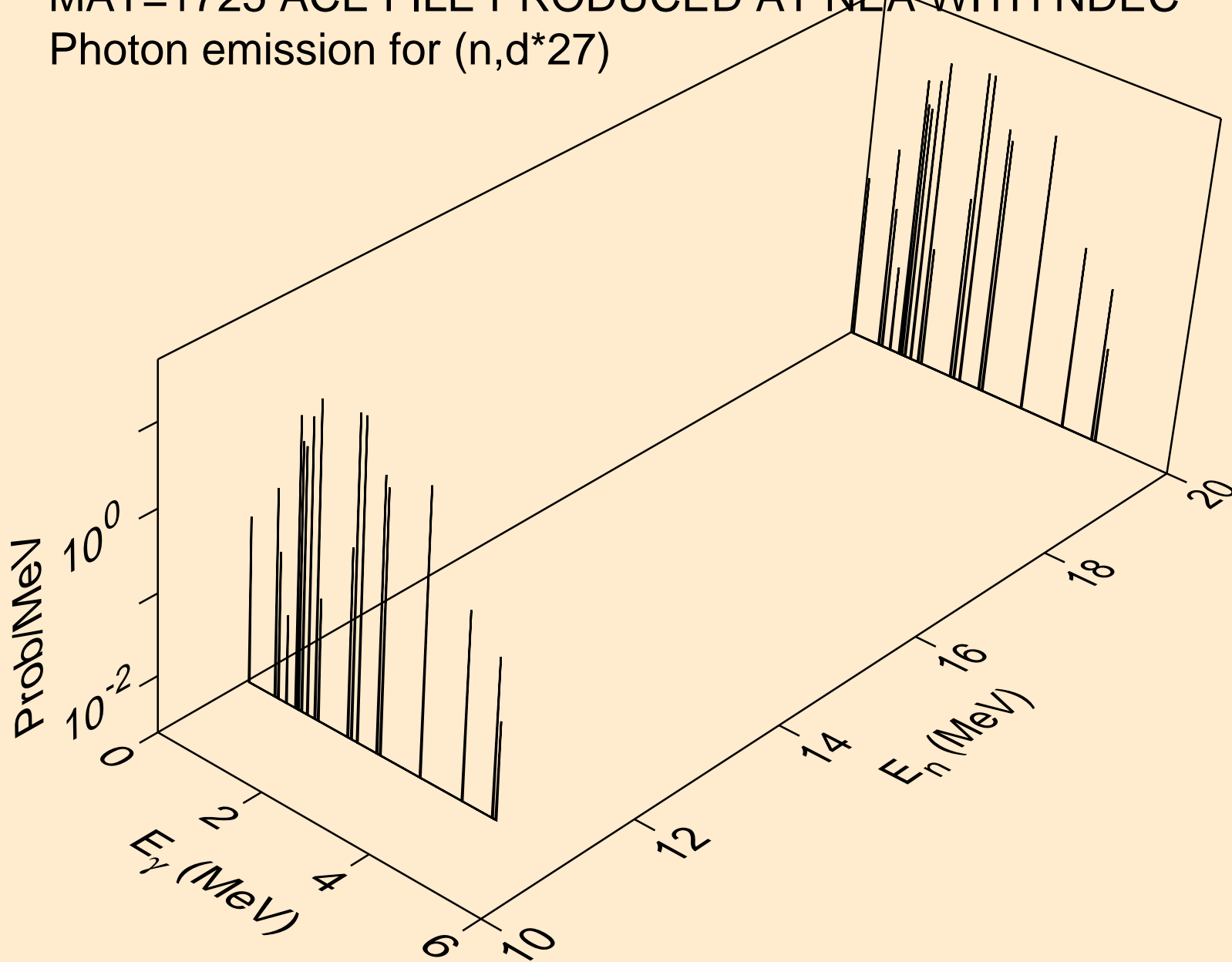

MAT=1725 ACE FILE PRODUCED AT NEA WITH NDEC
Photon emission for (n,d*28)

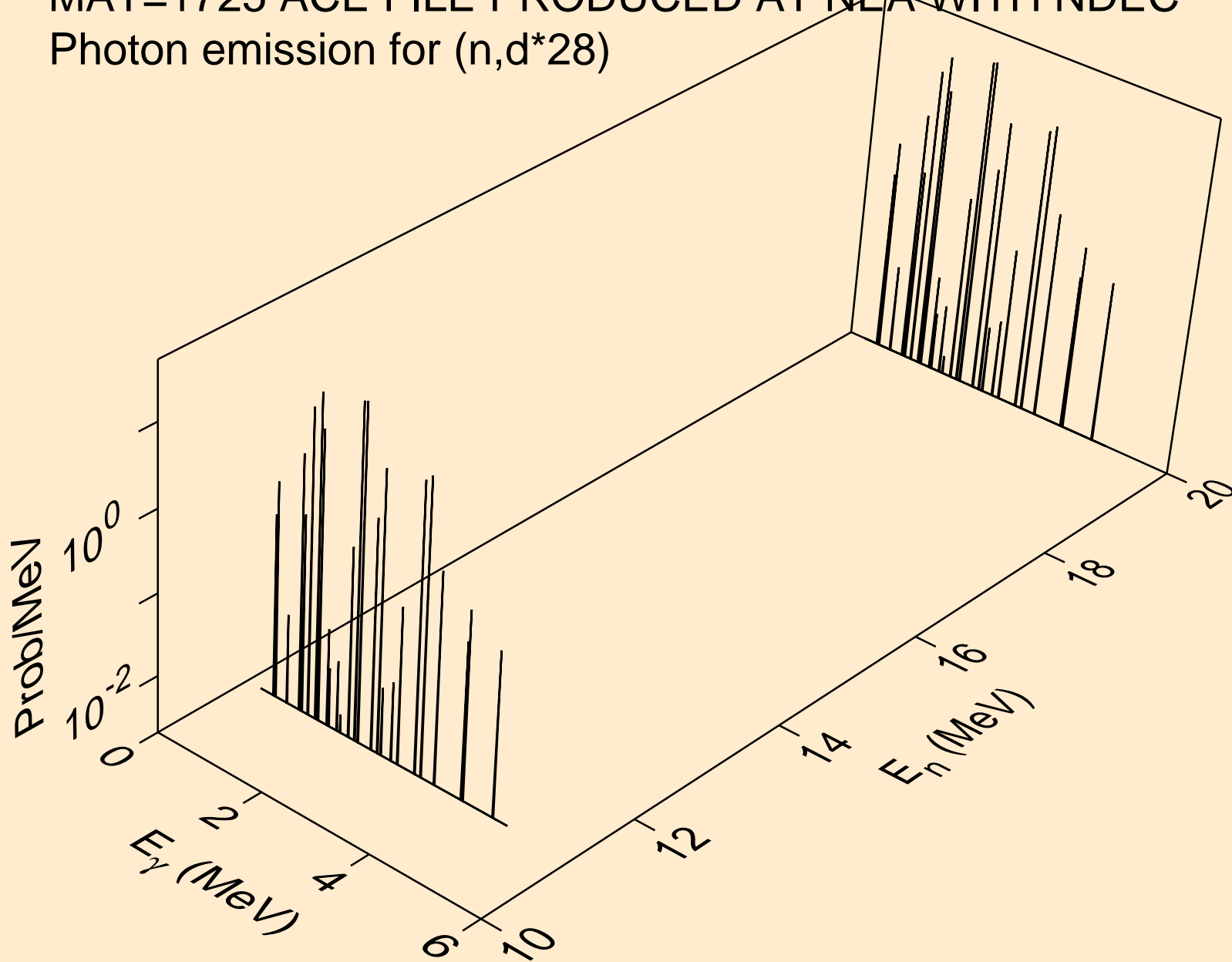

MAT=1725 ACE FILE PRODUCED AT NEA WITH NDEC
Photon emission for (n,d*29)

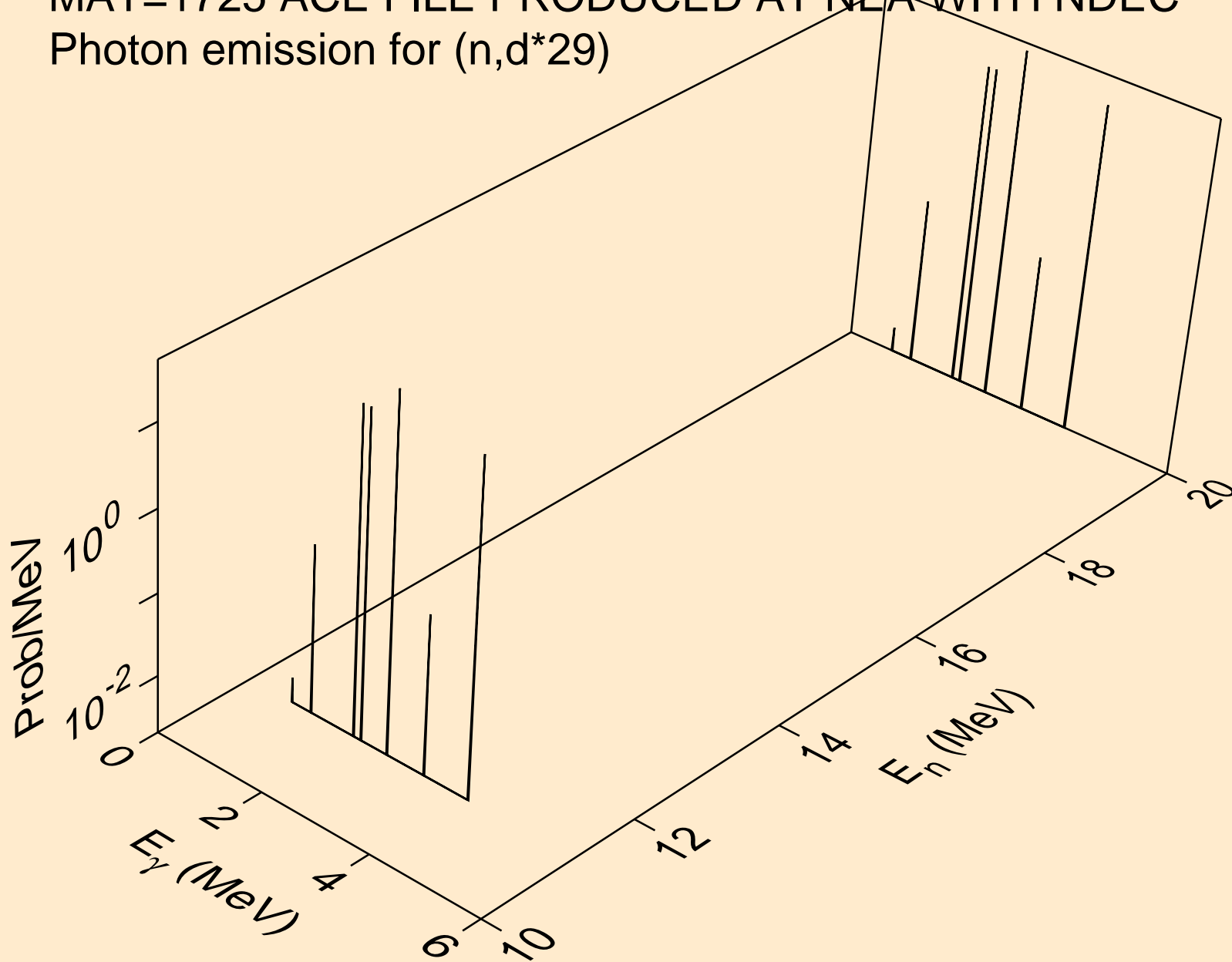

MAT=1725 ACE FILE PRODUCED AT NEA WITH NDEC
Photon emission for (n,d*30)

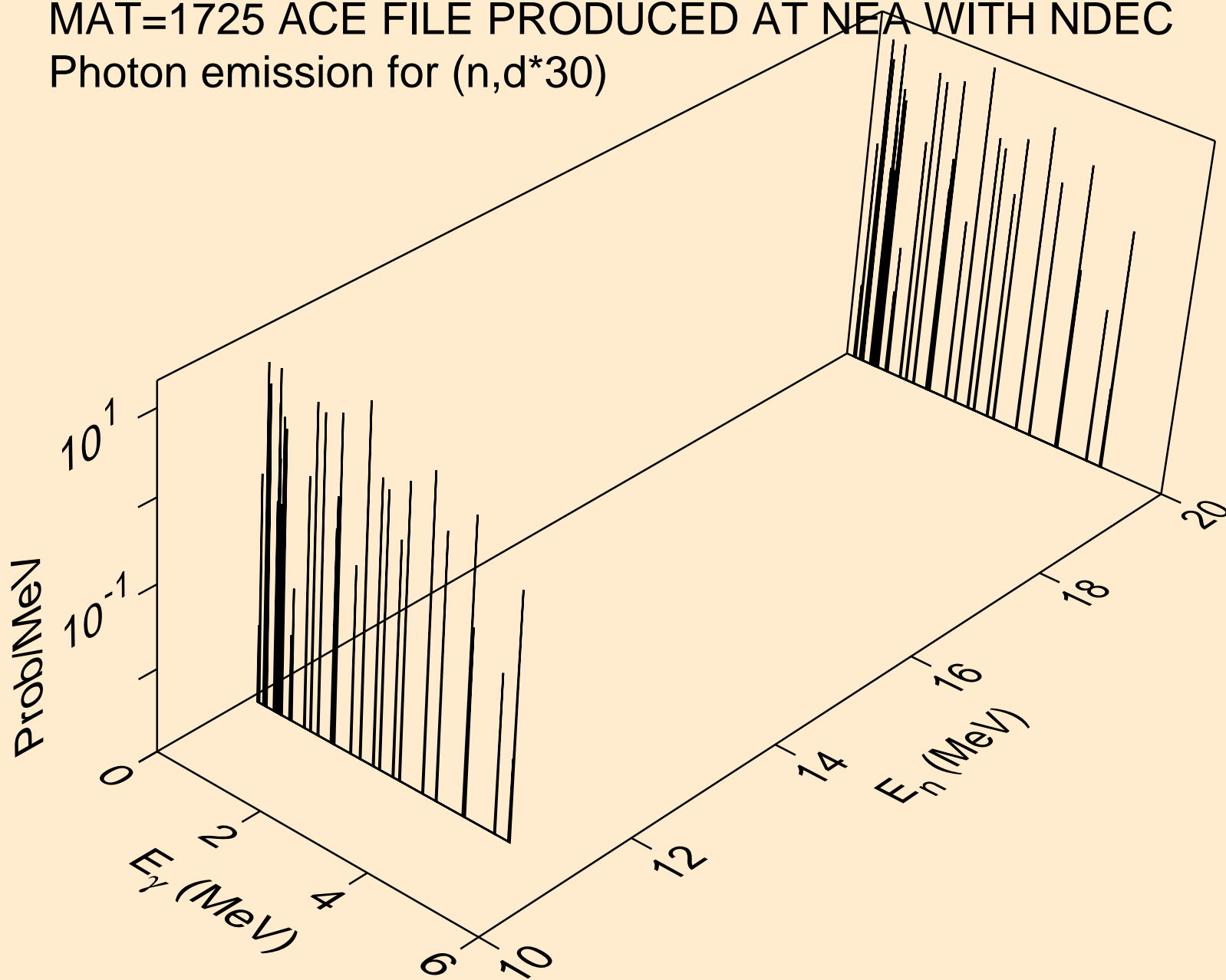

MAT=1725 ACE FILE PRODUCED AT NEA WITH NDEC
Photon emission for (n,d*c)

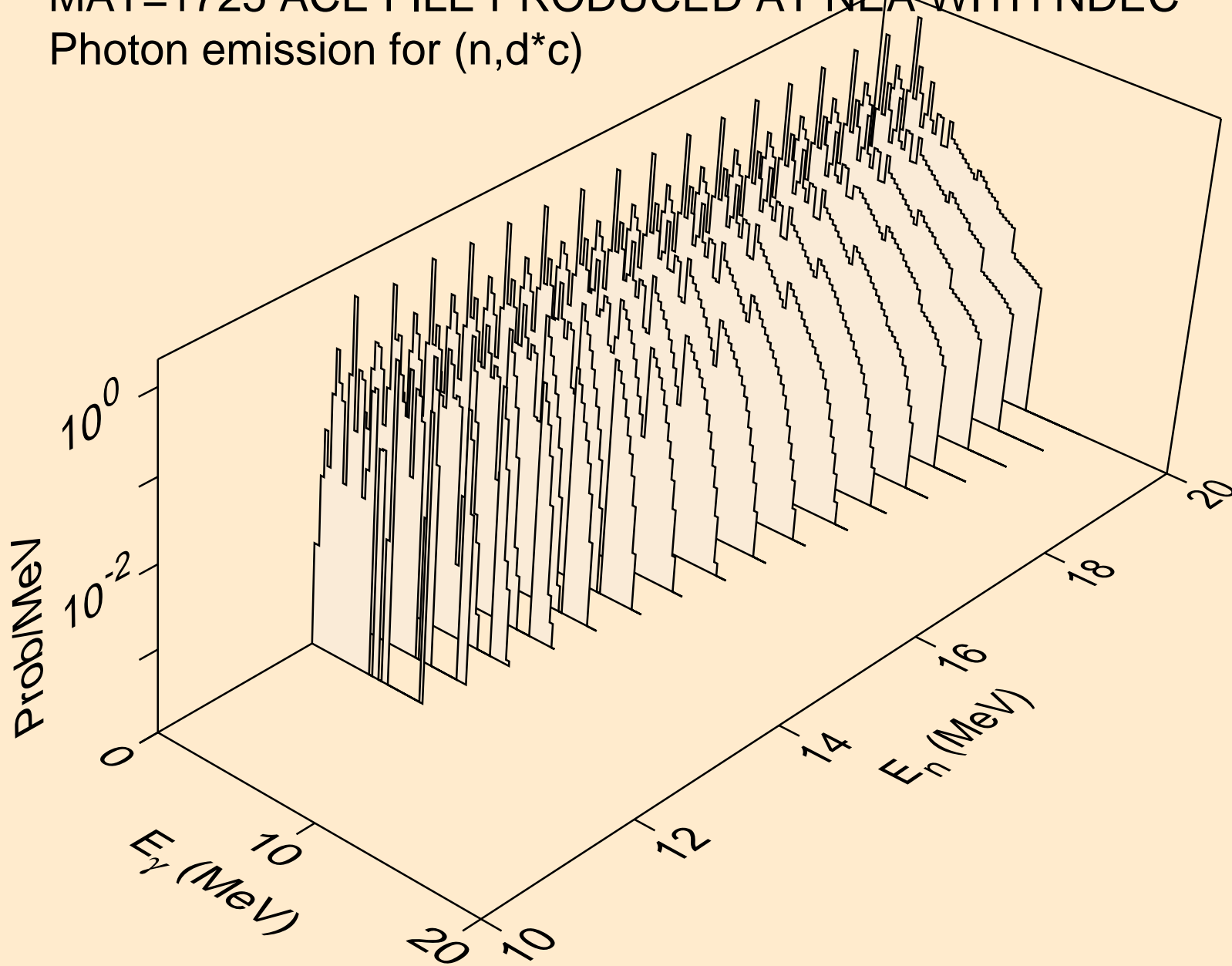

MAT=1725 ACE FILE PRODUCED AT NEA WITH NDEC
Photon emission for (n,t*1)

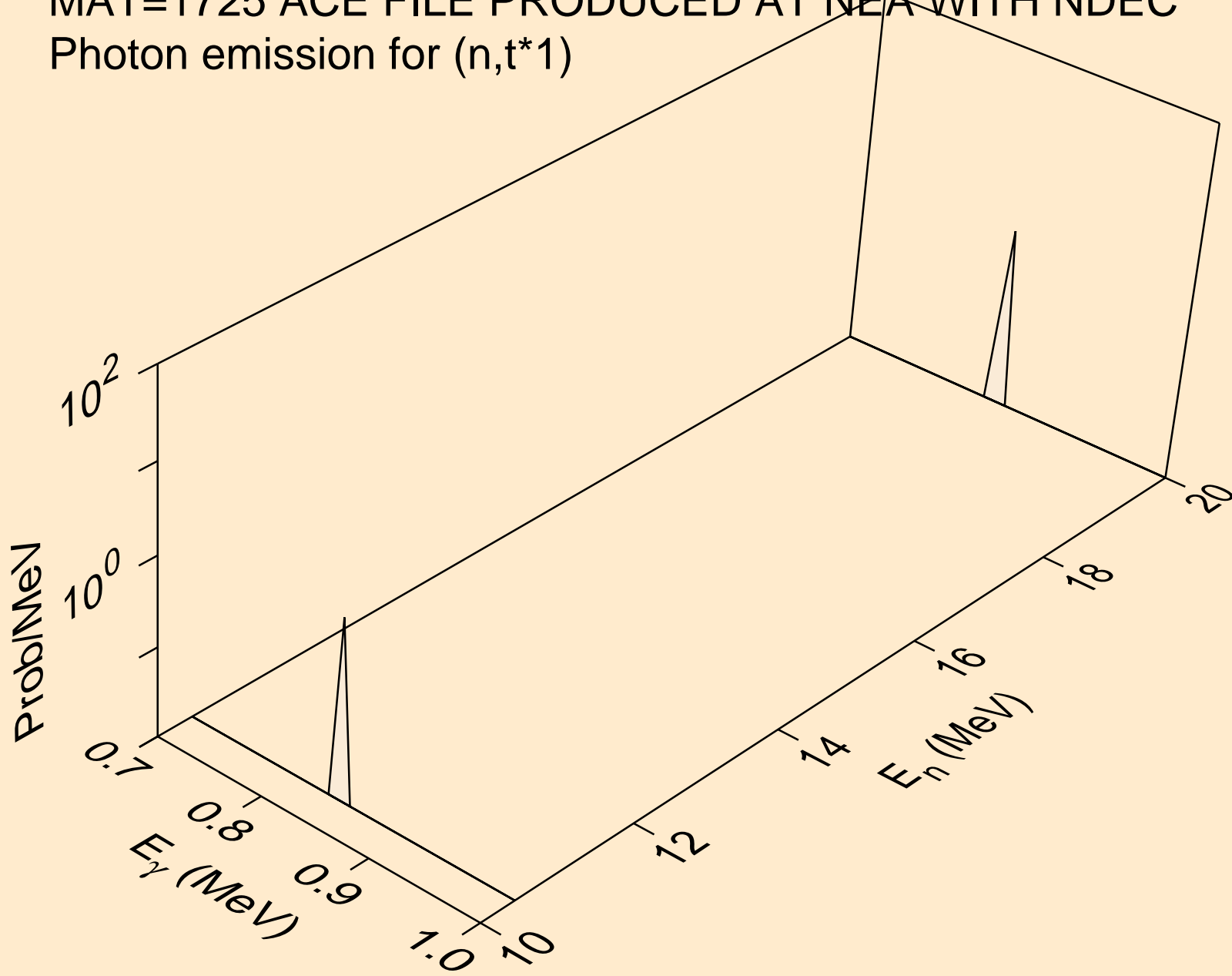

MAT=1725 ACE FILE PRODUCED AT NEA WITH NDEC
Photon emission for (n,t*2)

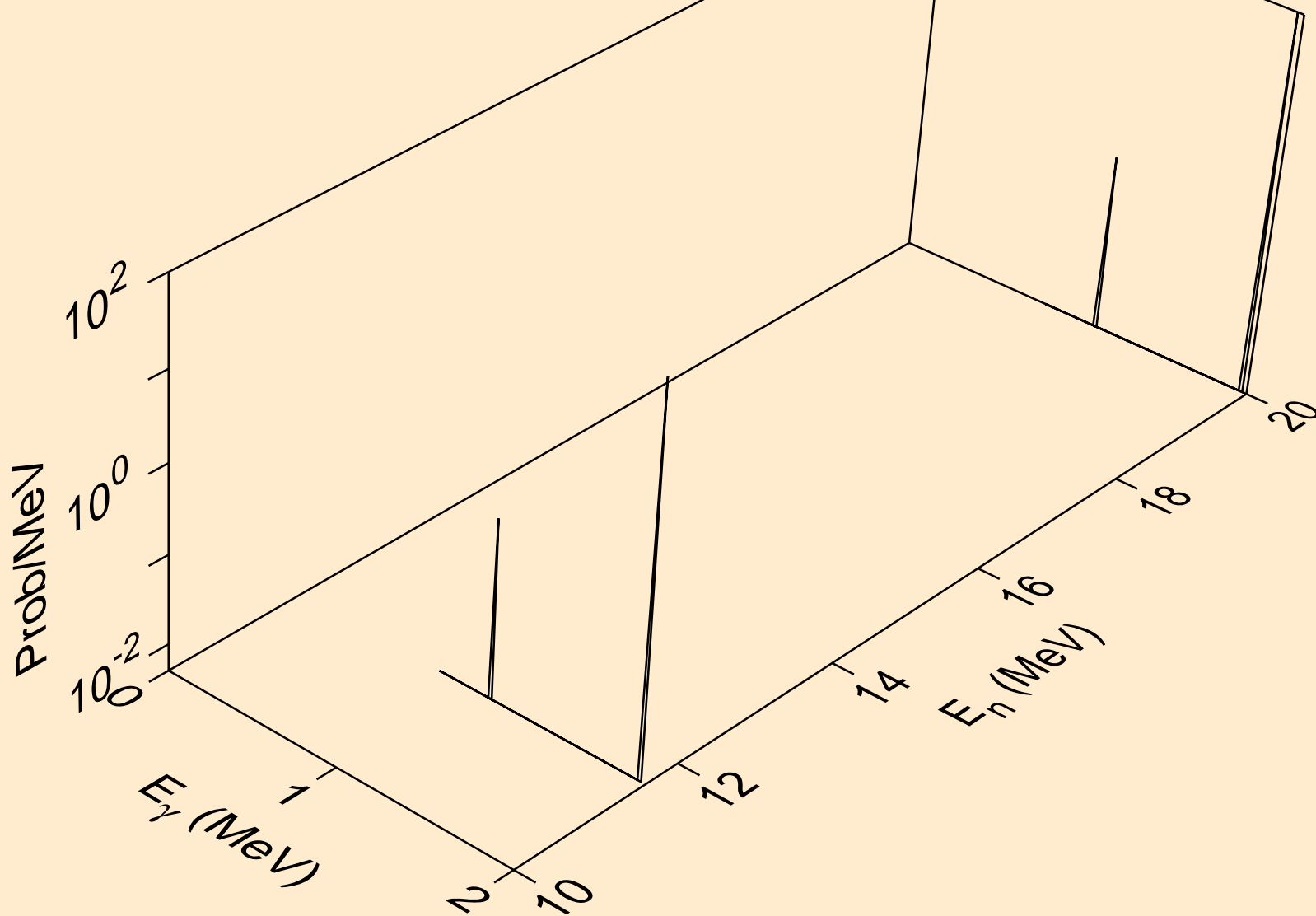

MAT=1725 ACE FILE PRODUCED AT NEA WITH NDEC
Photon emission for (n,t*3)

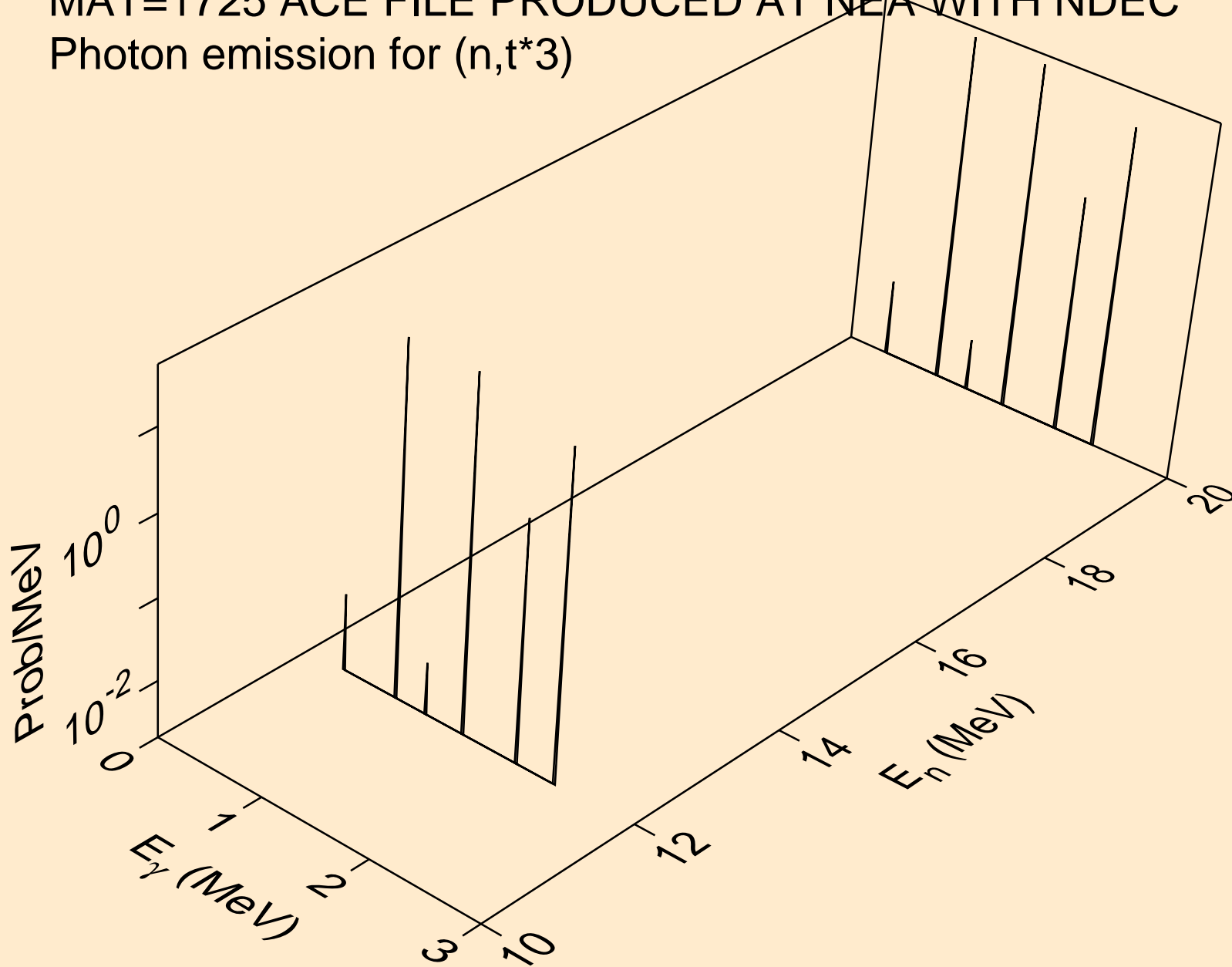

MAT=1725 ACE FILE PRODUCED AT NEA WITH NDEC
Photon emission for (n,t*4)

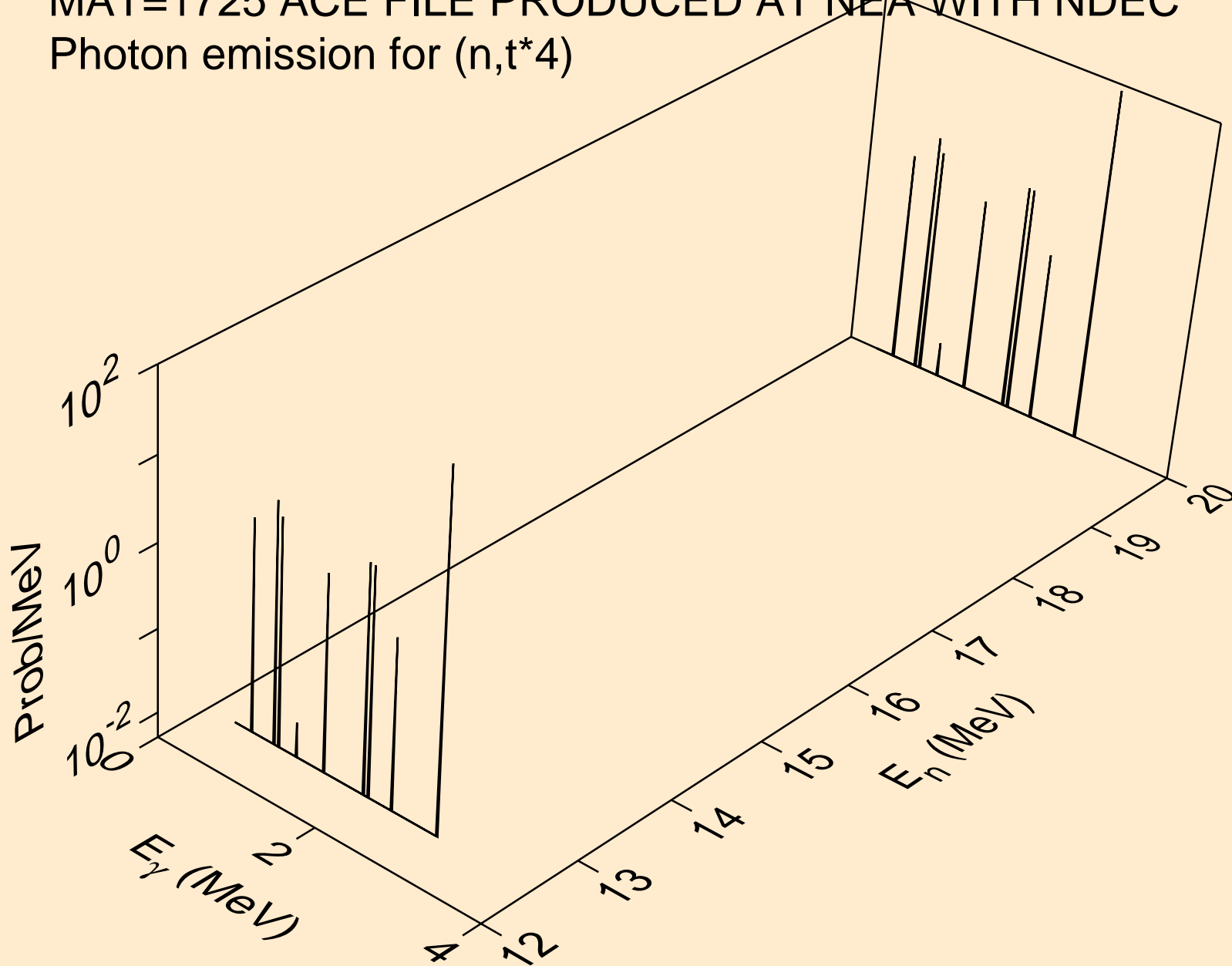

MAT=1725 ACE FILE PRODUCED AT NEA WITH NDEC
Photon emission for (n,t*5)

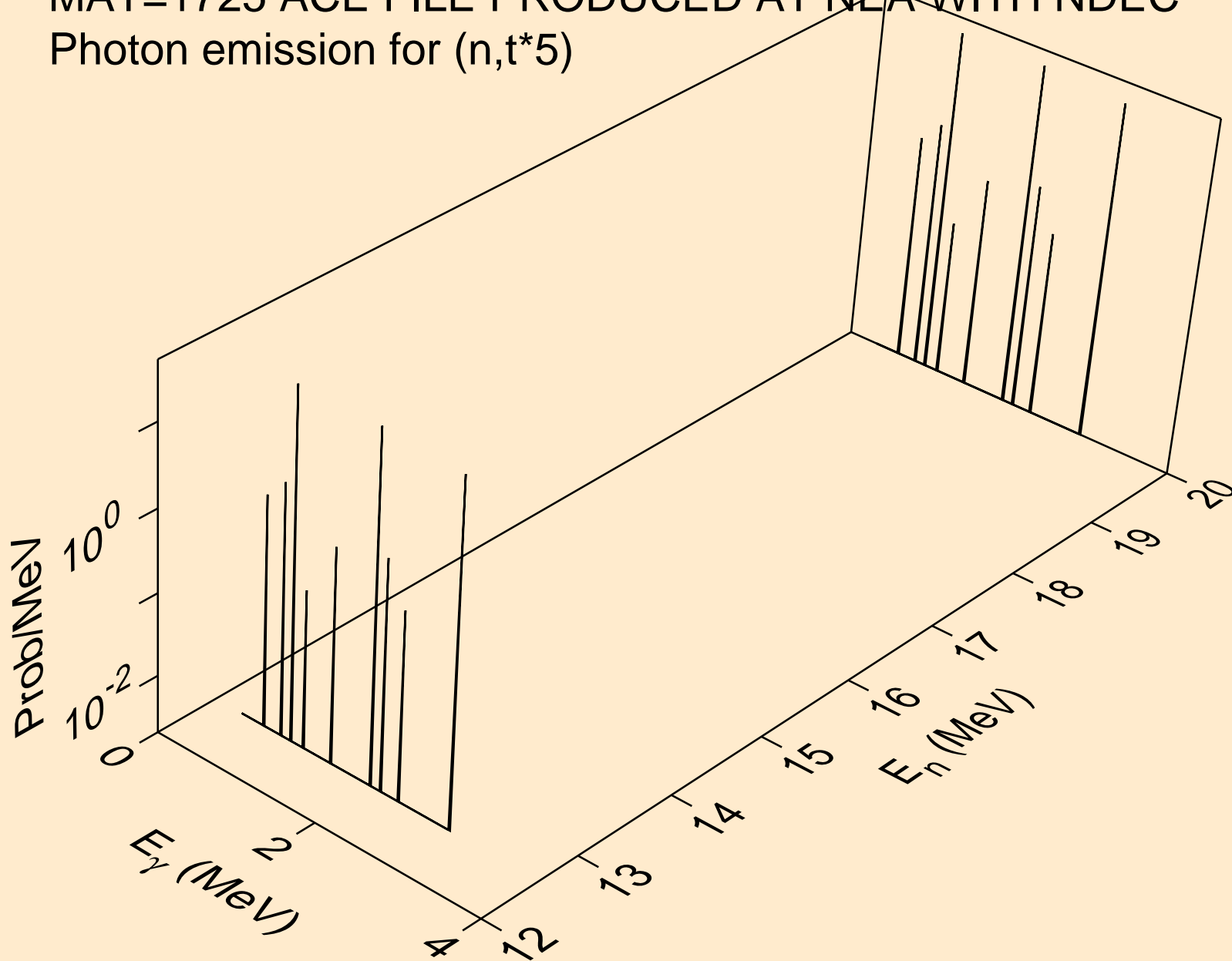

MAT=1725 ACE FILE PRODUCED AT NEA WITH NDEC
Photon emission for (n,t*6)

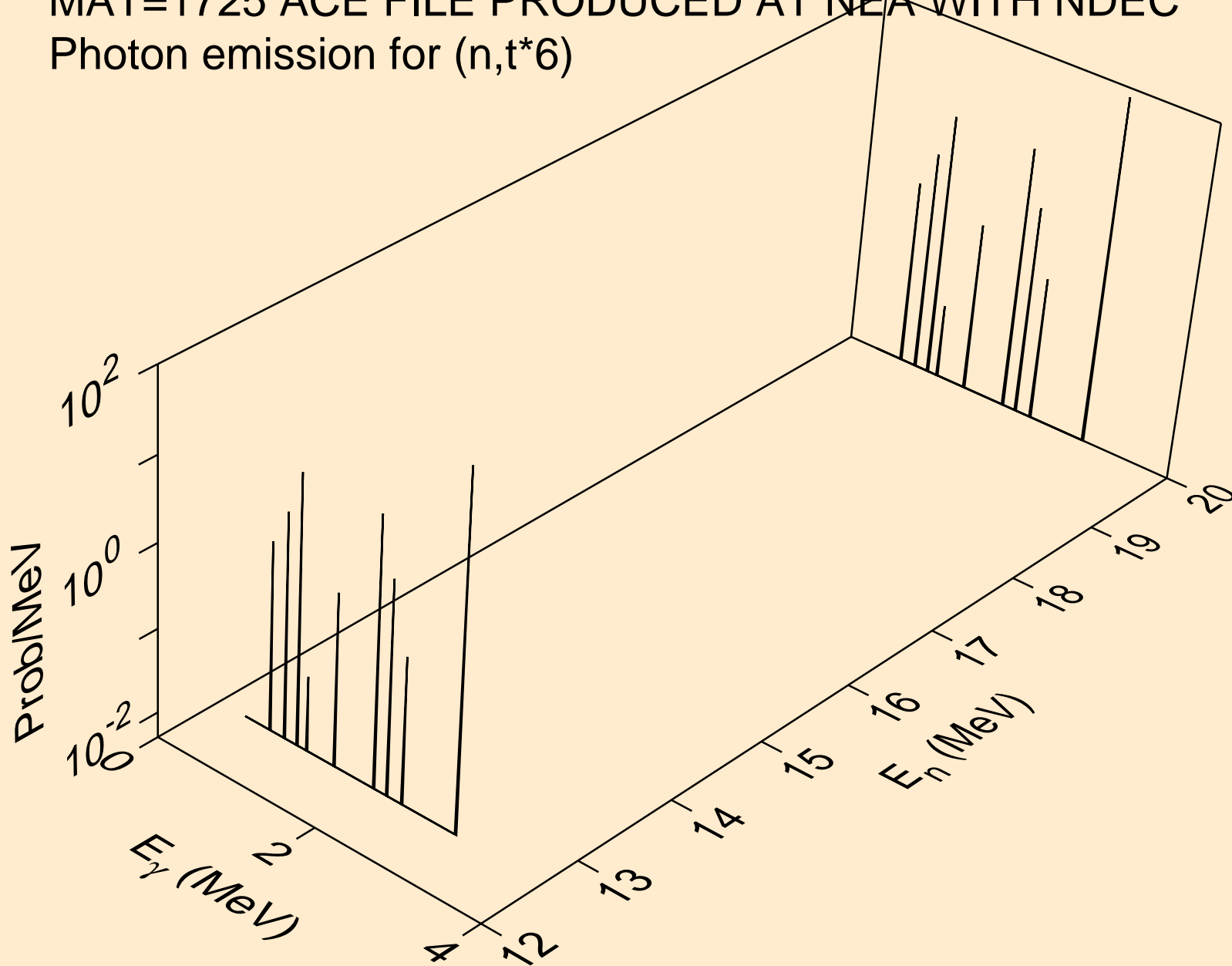

MAT=1725 ACE FILE PRODUCED AT NEA WITH NDEC
Photon emission for (n,t*7)

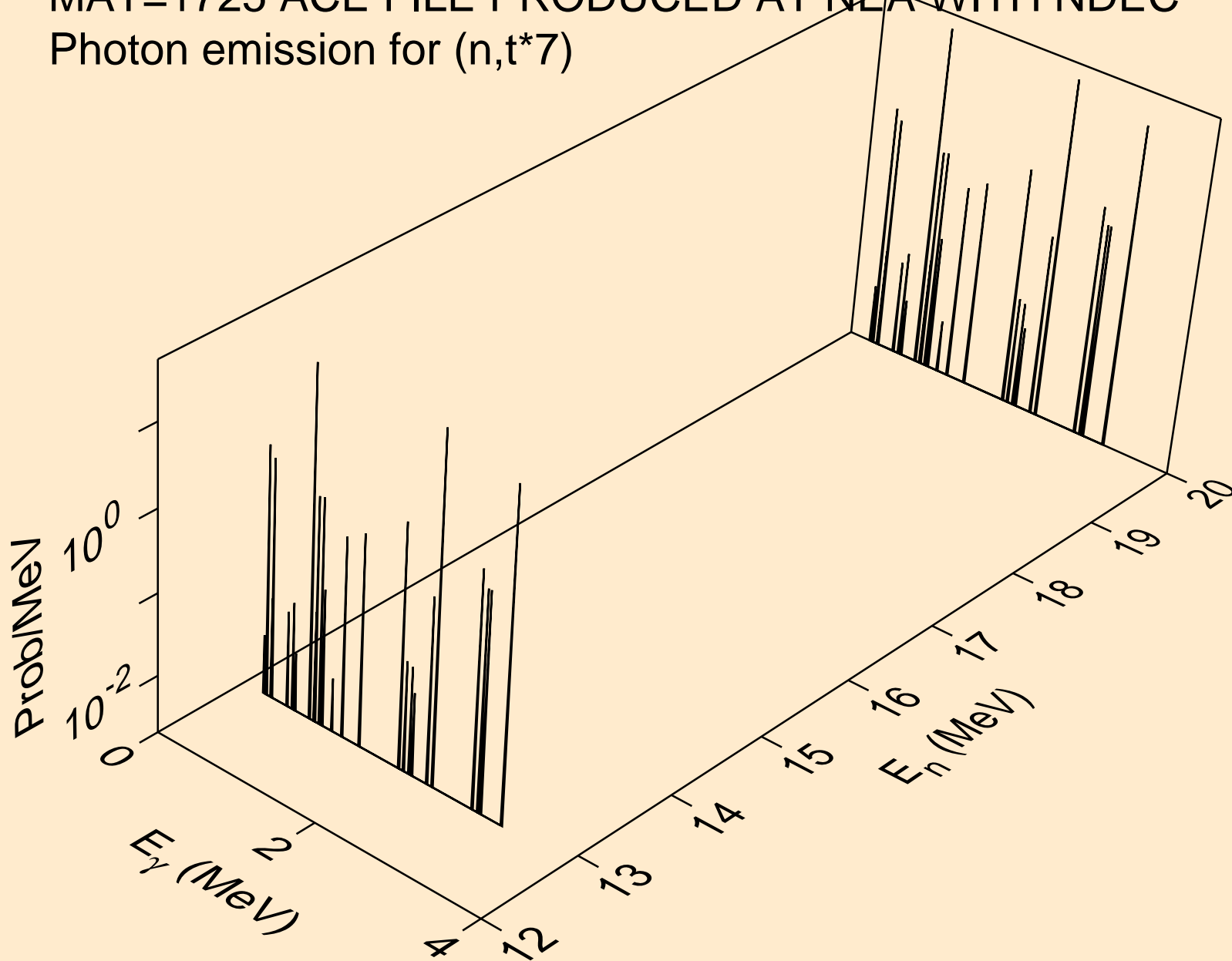

MAT=1725 ACE FILE PRODUCED AT NEA WITH NDEC
Photon emission for (n,t*8)

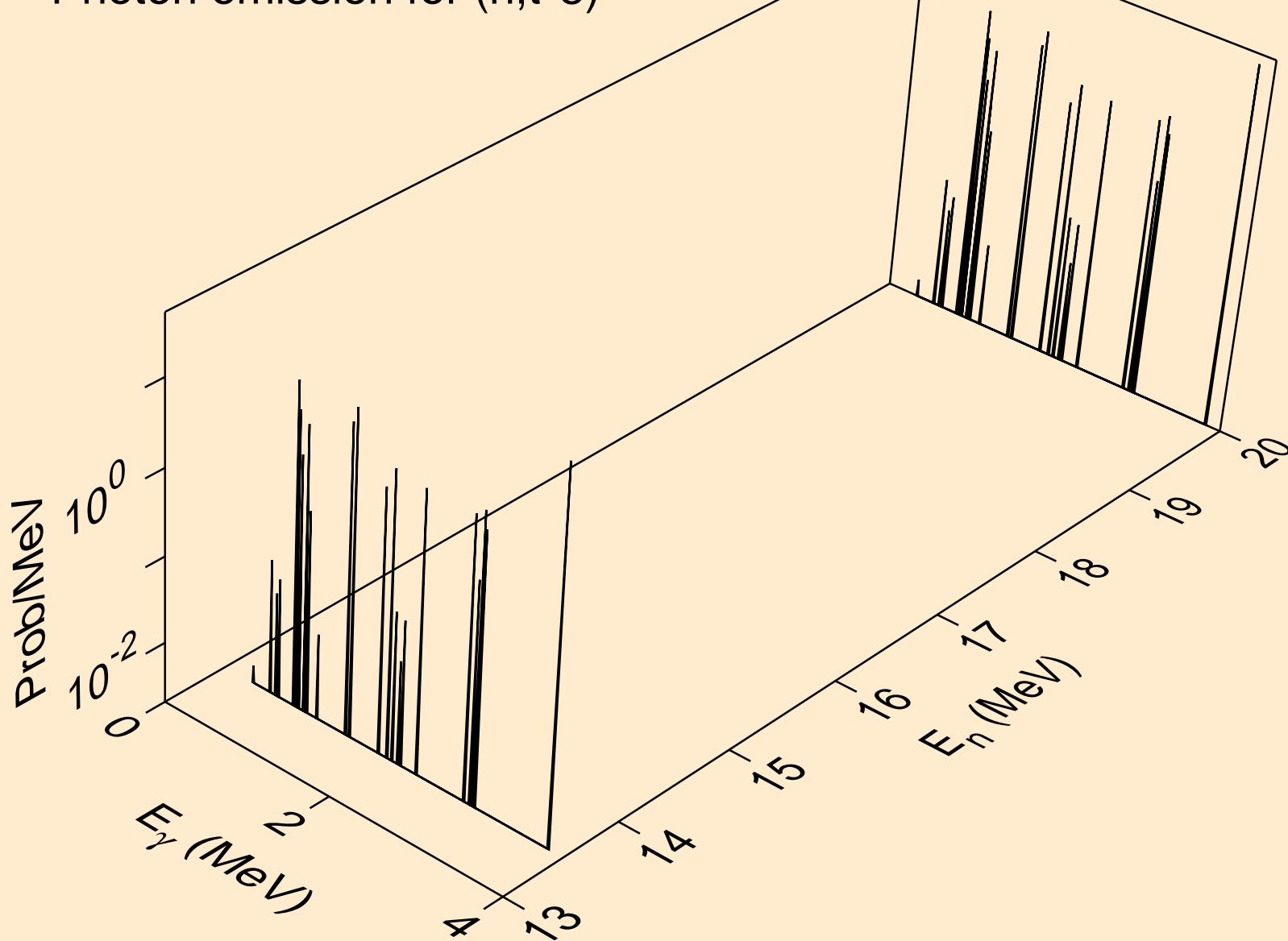

MAT=1725 ACE FILE PRODUCED AT NEA WITH NDEC
Photon emission for (n,t*9)

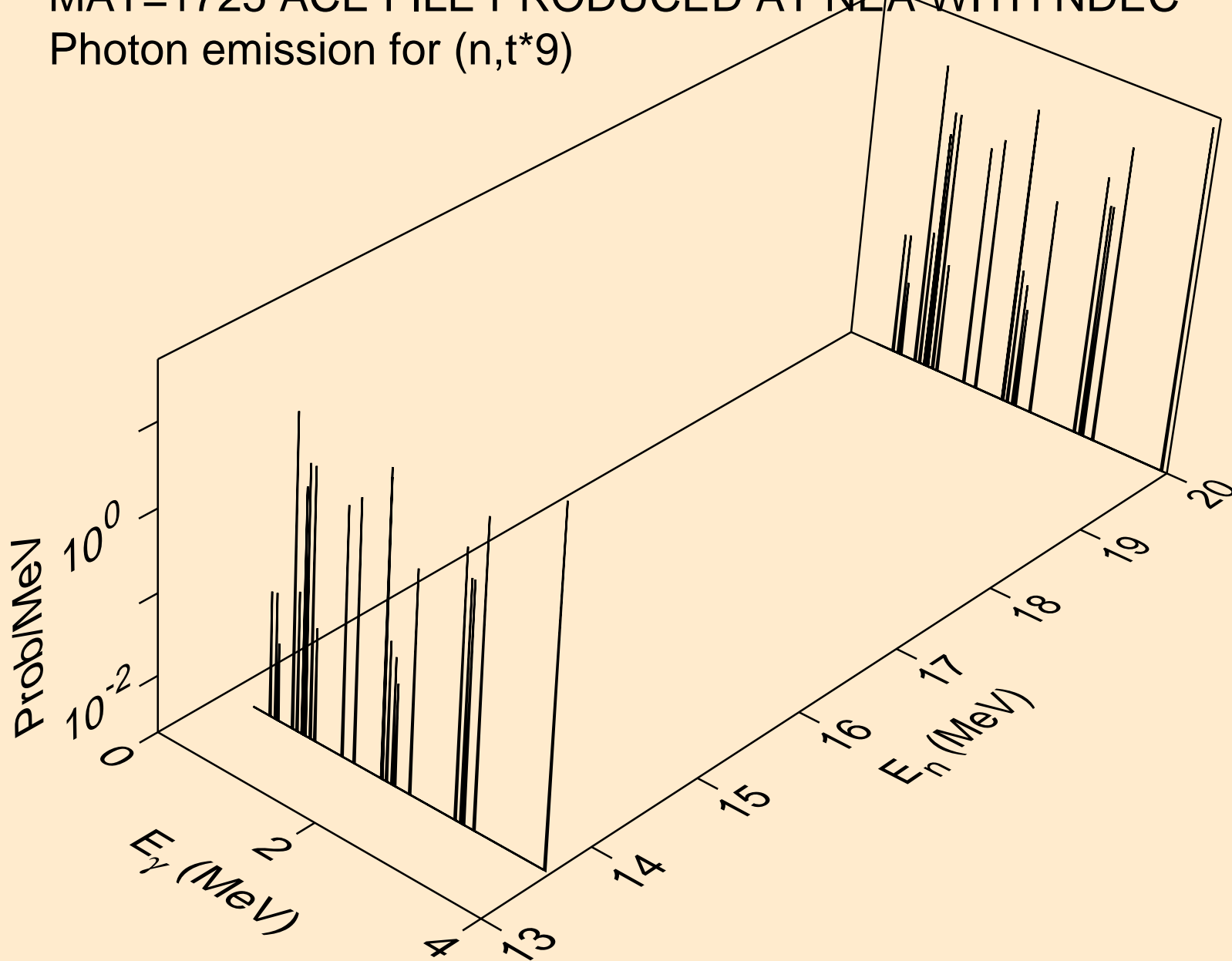

MAT=1725 ACE FILE PRODUCED AT NEA WITH NDEC
Photon emission for (n,t*10)

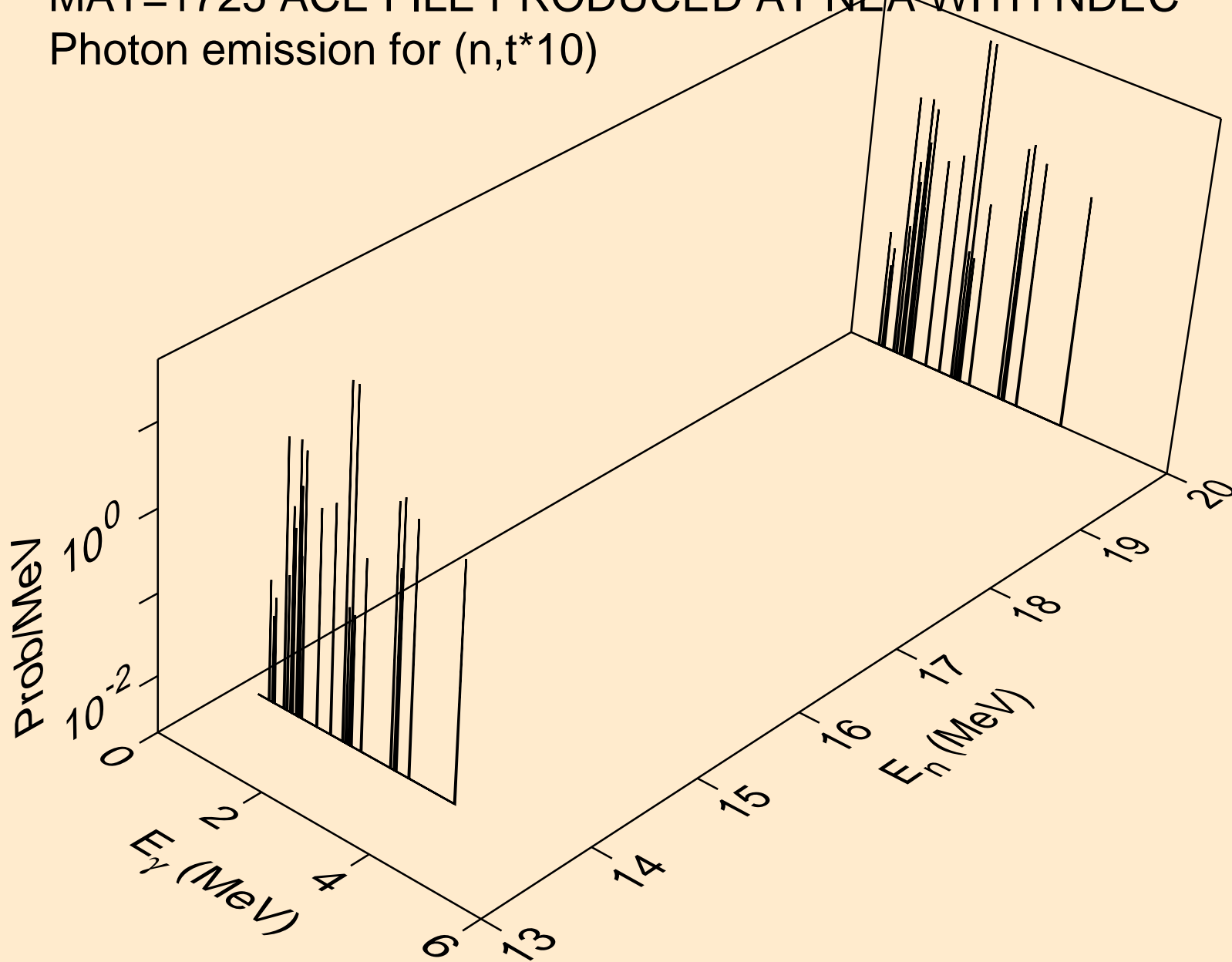

MAT=1725 ACE FILE PRODUCED AT NEA WITH NDEC
Photon emission for (n,t*11)

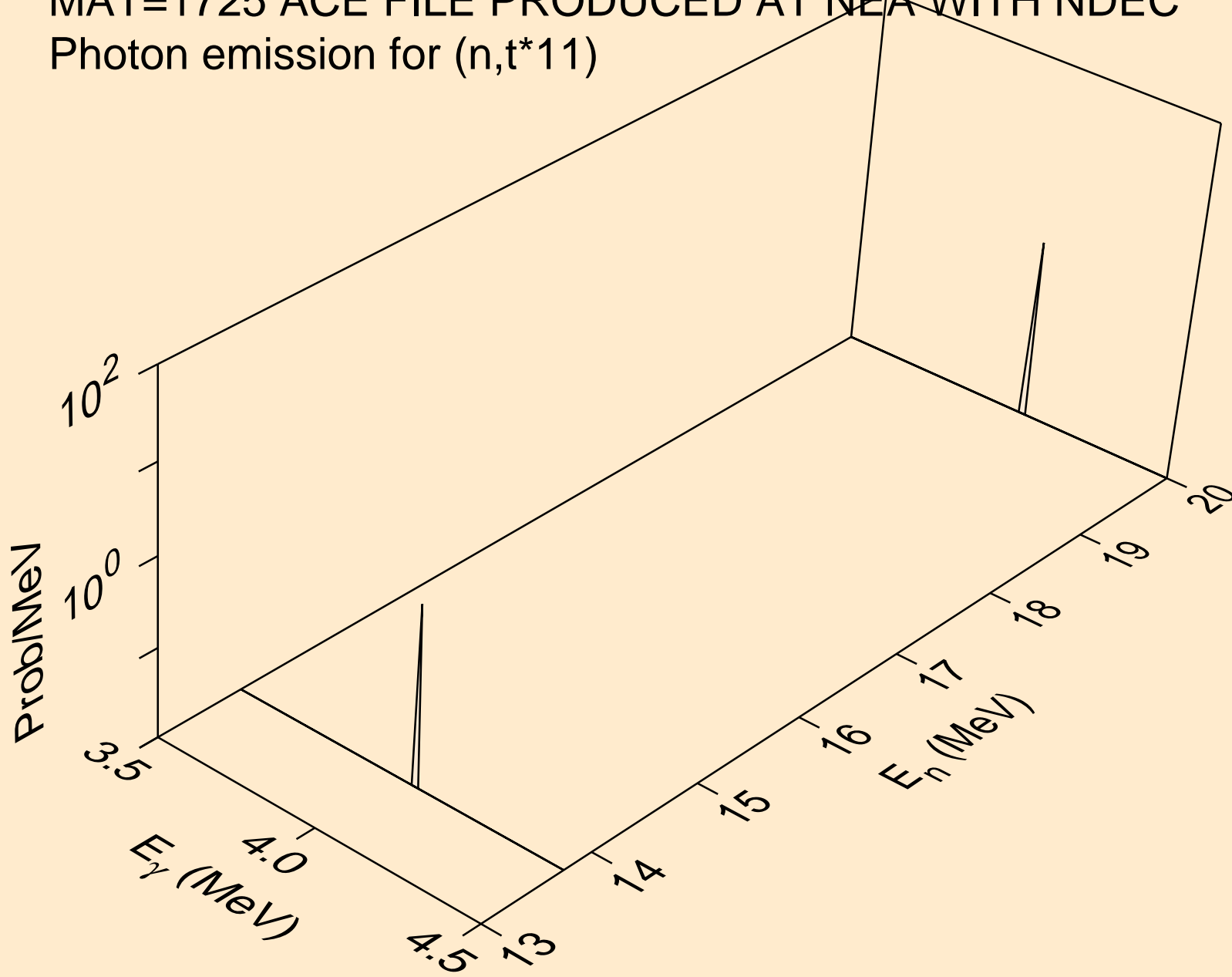

MAT=1725 ACE FILE PRODUCED AT NEA WITH NDEC
Photon emission for (n,t*12)

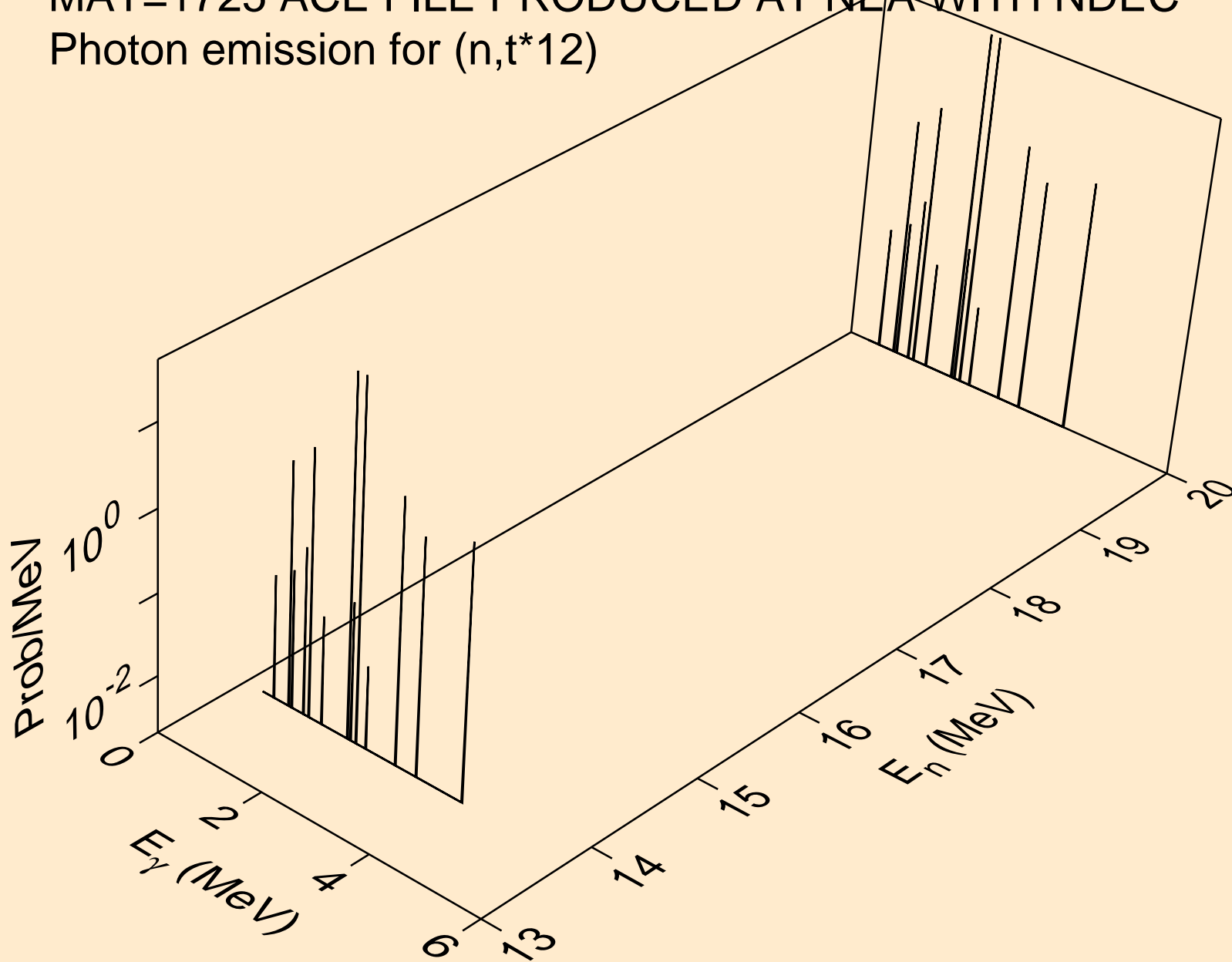

MAT=1725 ACE FILE PRODUCED AT NEA WITH NDEC
Photon emission for (n,t*13)

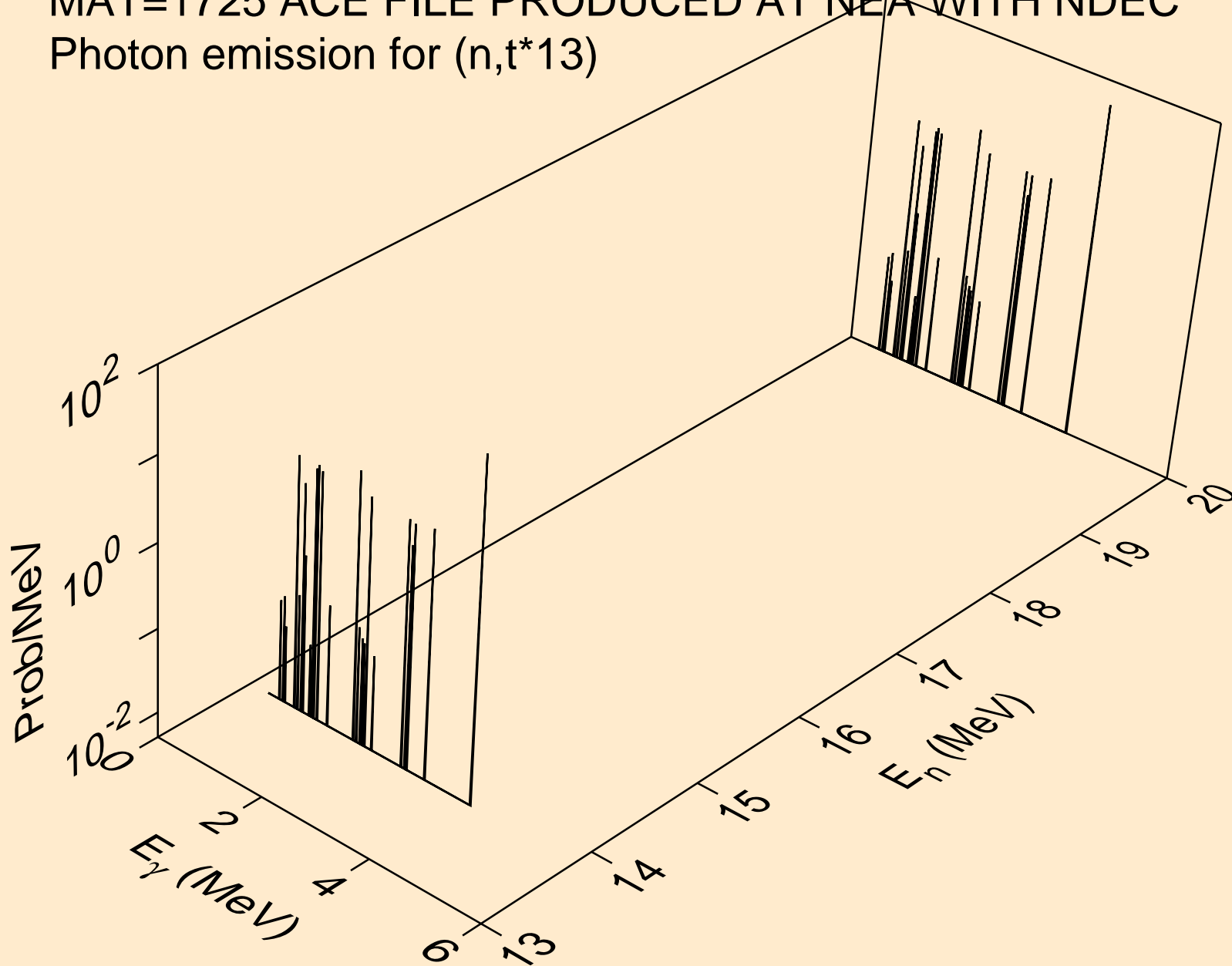

MAT=1725 ACE FILE PRODUCED AT NEA WITH NDEC
Photon emission for (n,t*14)

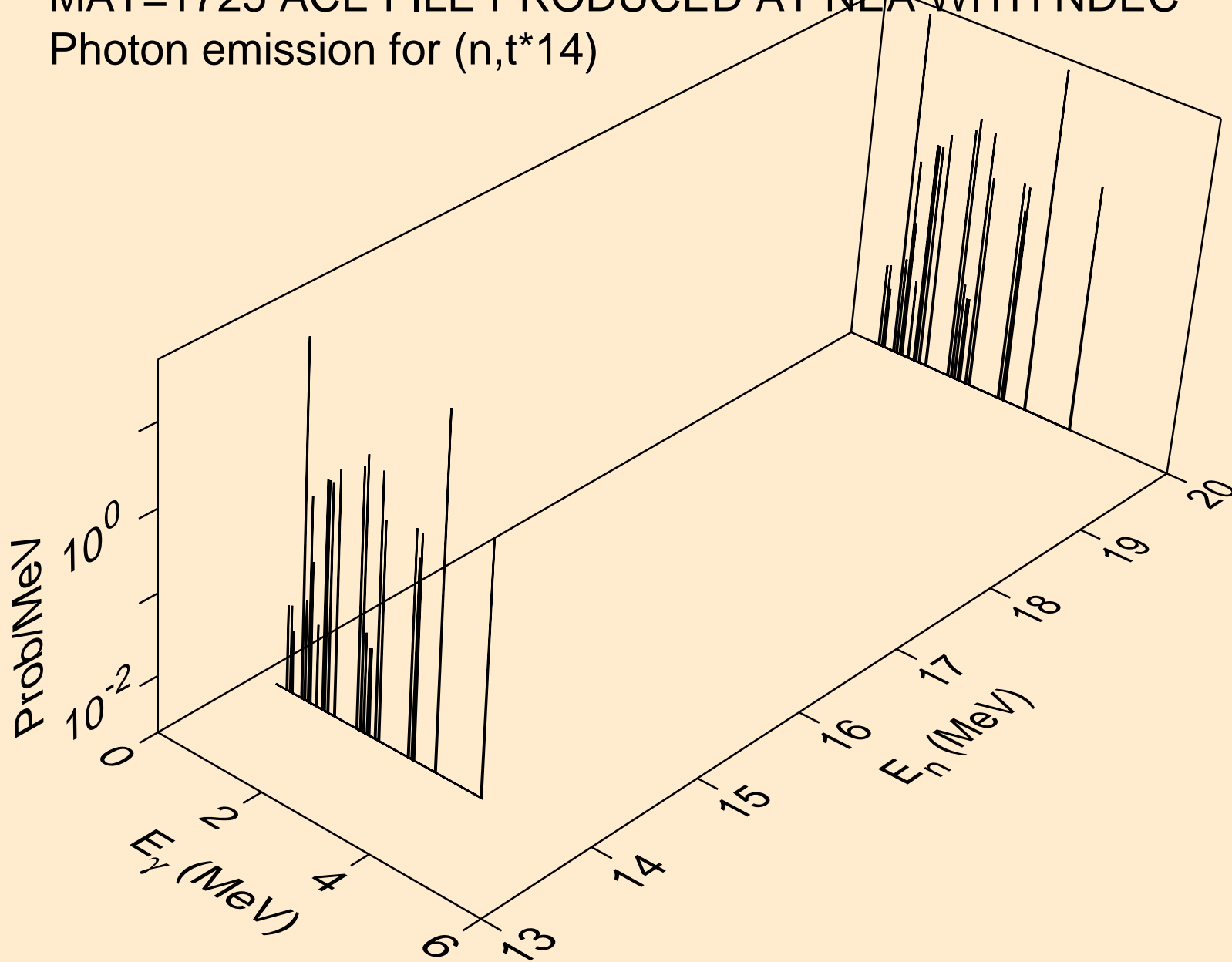

MAT=1725 ACE FILE PRODUCED AT NEA WITH NDEC
Photon emission for (n,t*15)

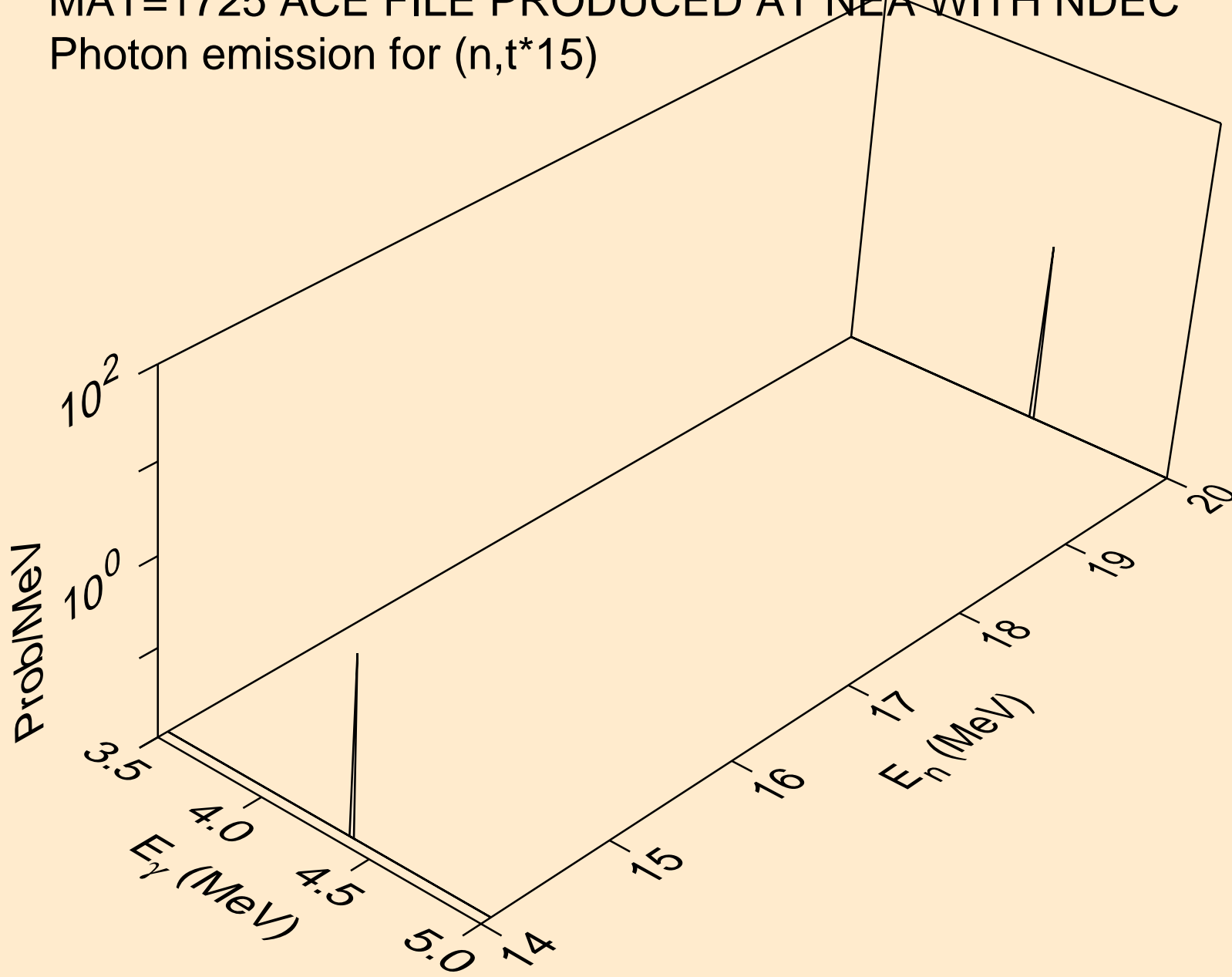

MAT=1725 ACE FILE PRODUCED AT NEA WITH NDEC
Photon emission for (n,t*16)

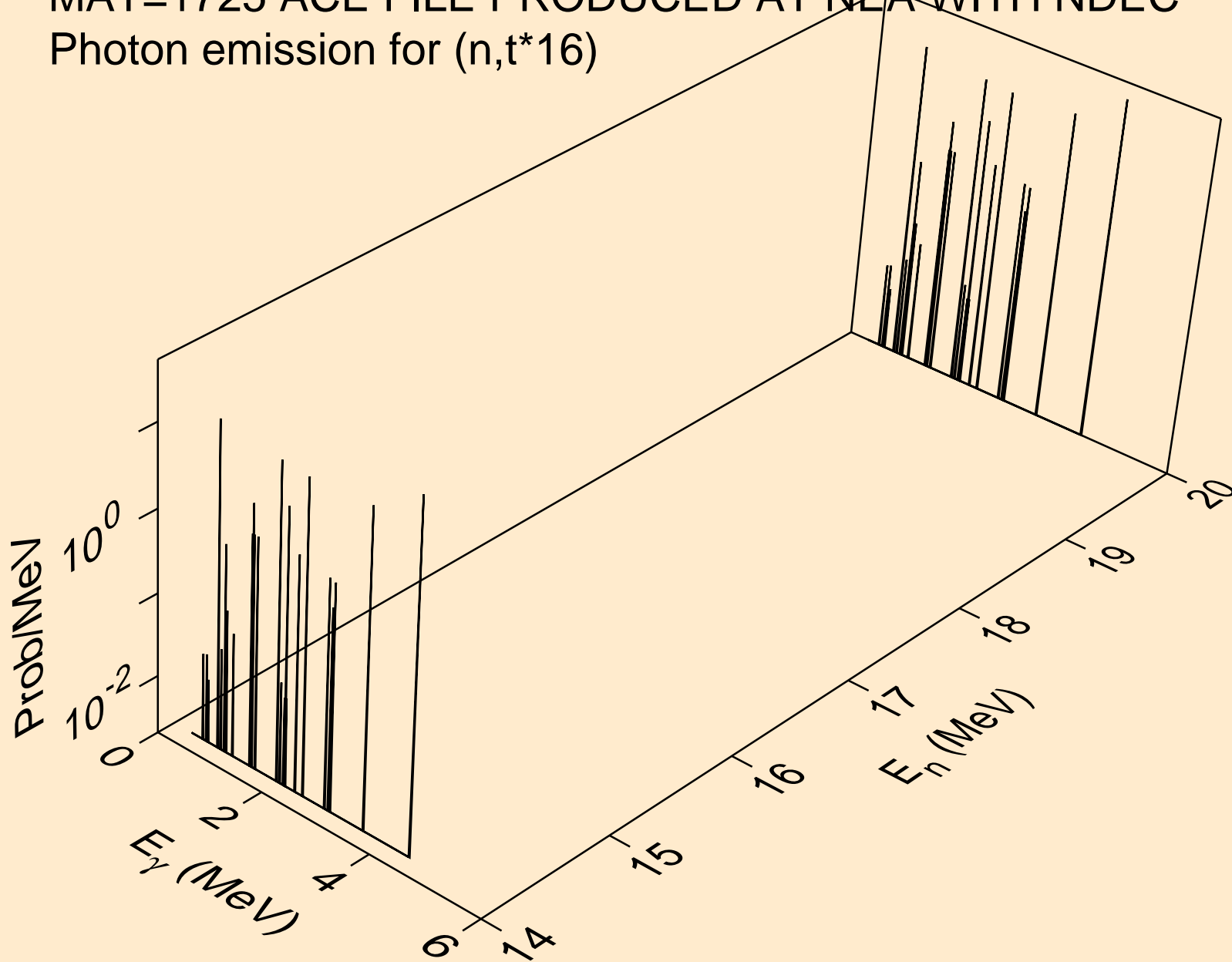

MAT=1725 ACE FILE PRODUCED AT NEA WITH NDEC
Photon emission for (n,t*17)

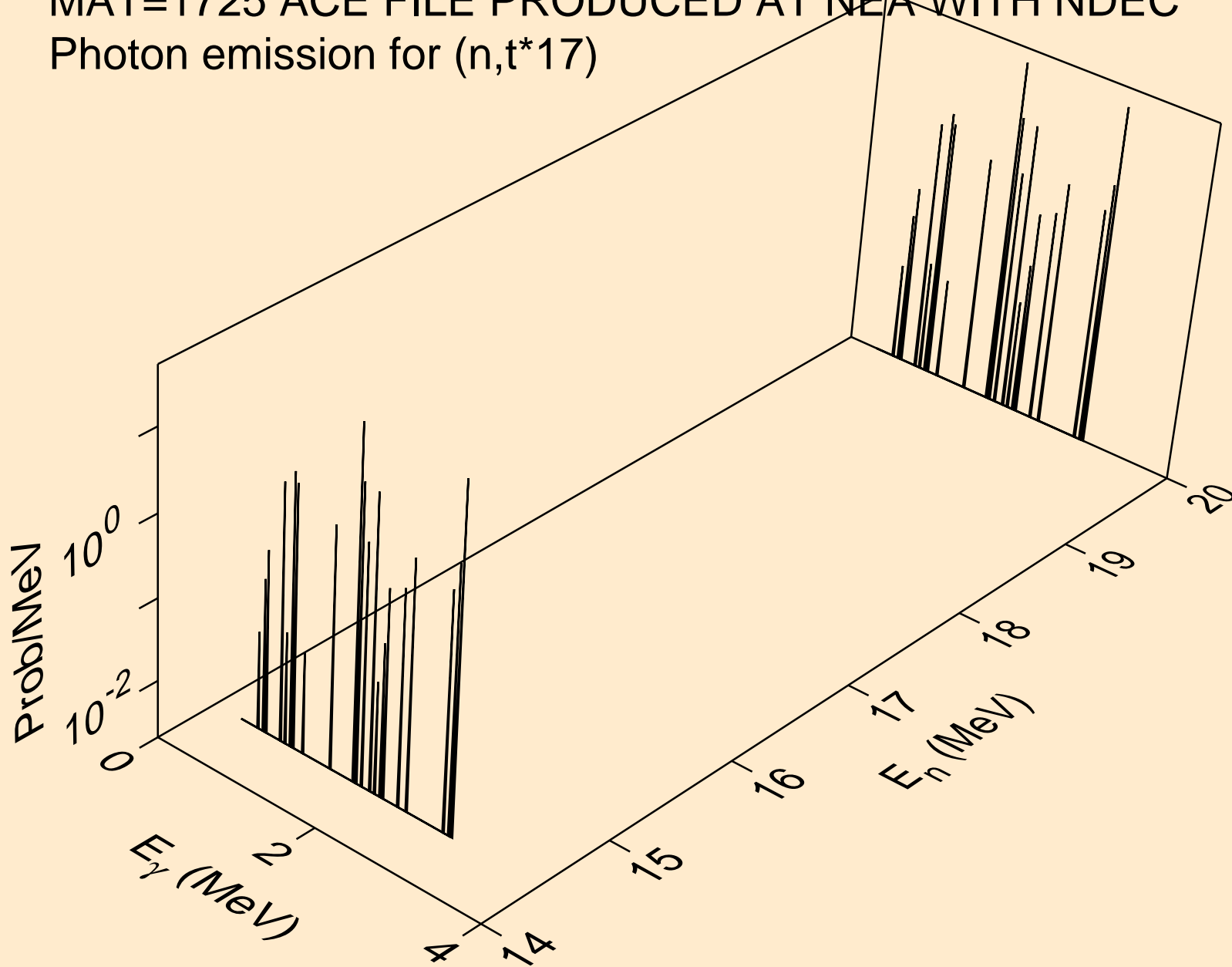

MAT=1725 ACE FILE PRODUCED AT NEA WITH NDEC
Photon emission for (n,t*18)

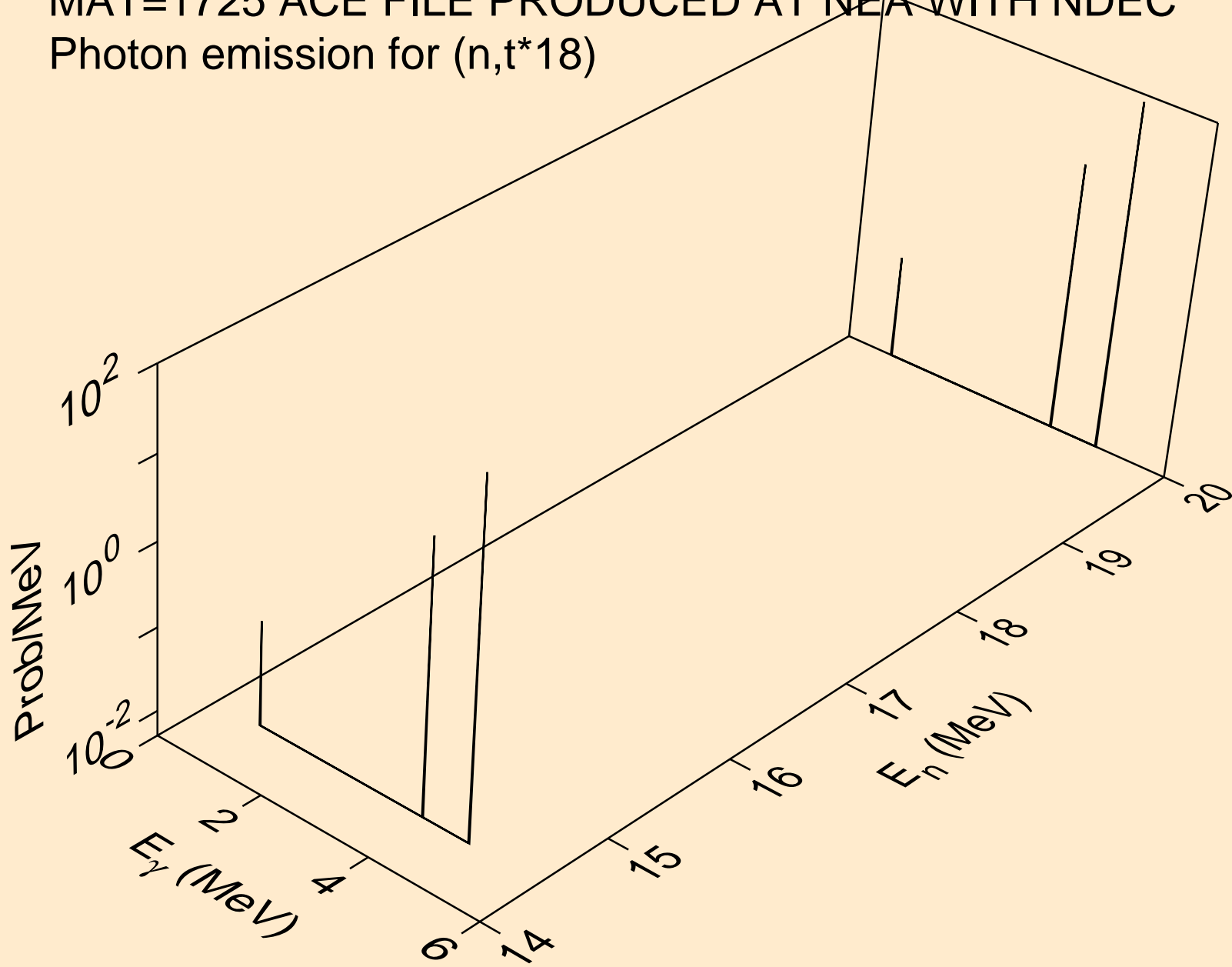

MAT=1725 ACE FILE PRODUCED AT NEA WITH NDEC
Photon emission for (n,t*19)

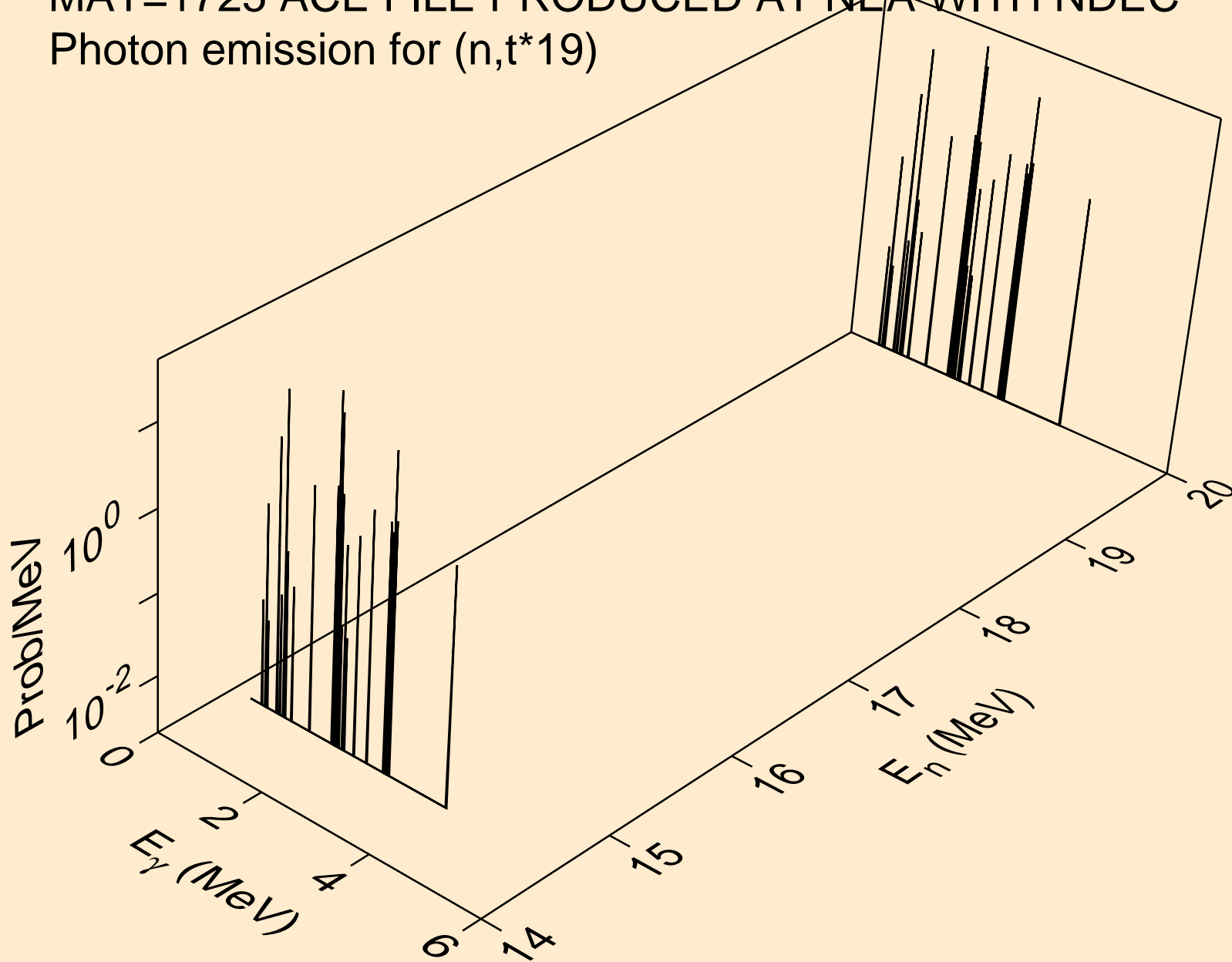

MAT=1725 ACE FILE PRODUCED AT NEA WITH NDEC
Photon emission for (n,t*20)

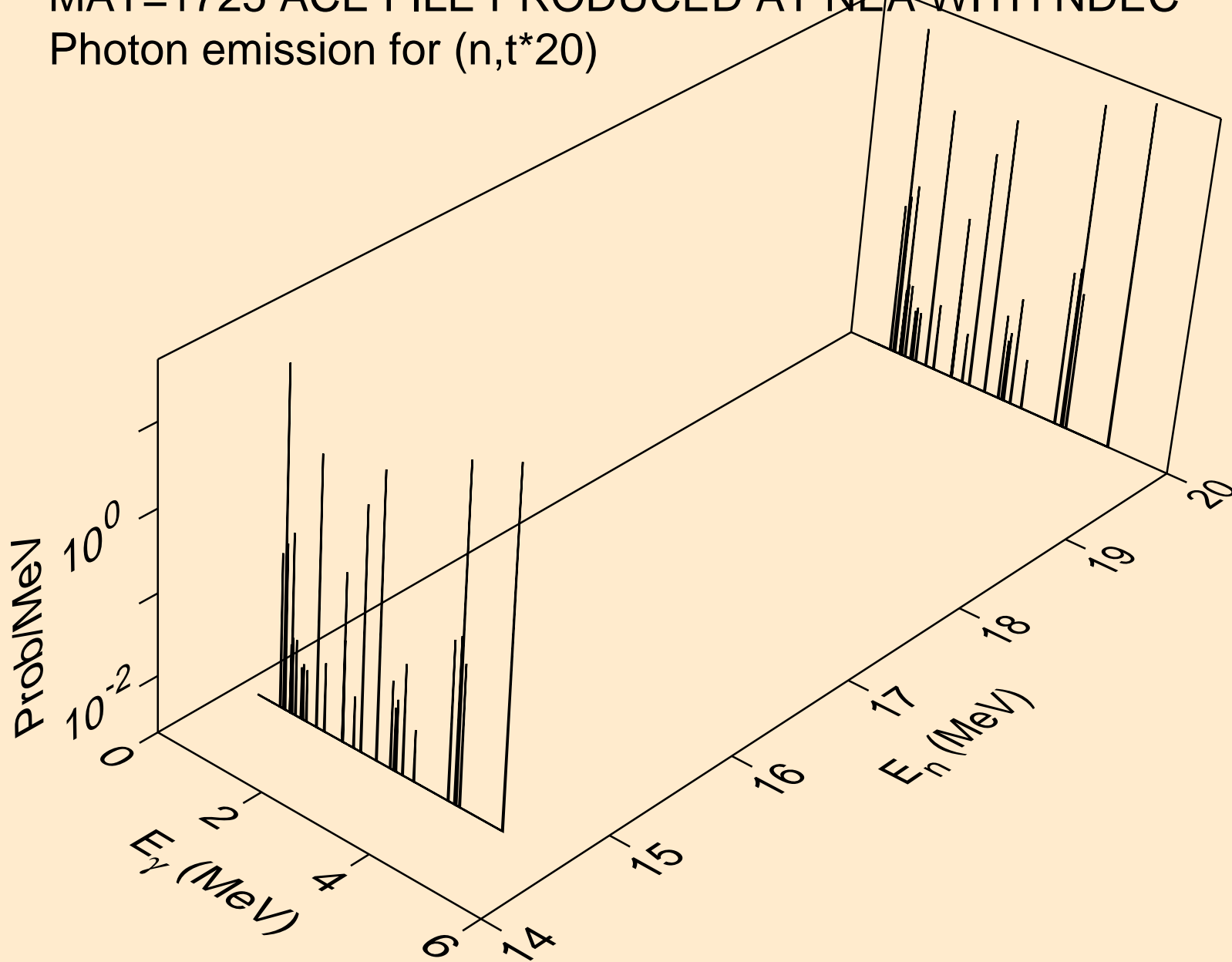

MAT=1725 ACE FILE PRODUCED AT NEA WITH NDEC
Photon emission for (n,t*21)

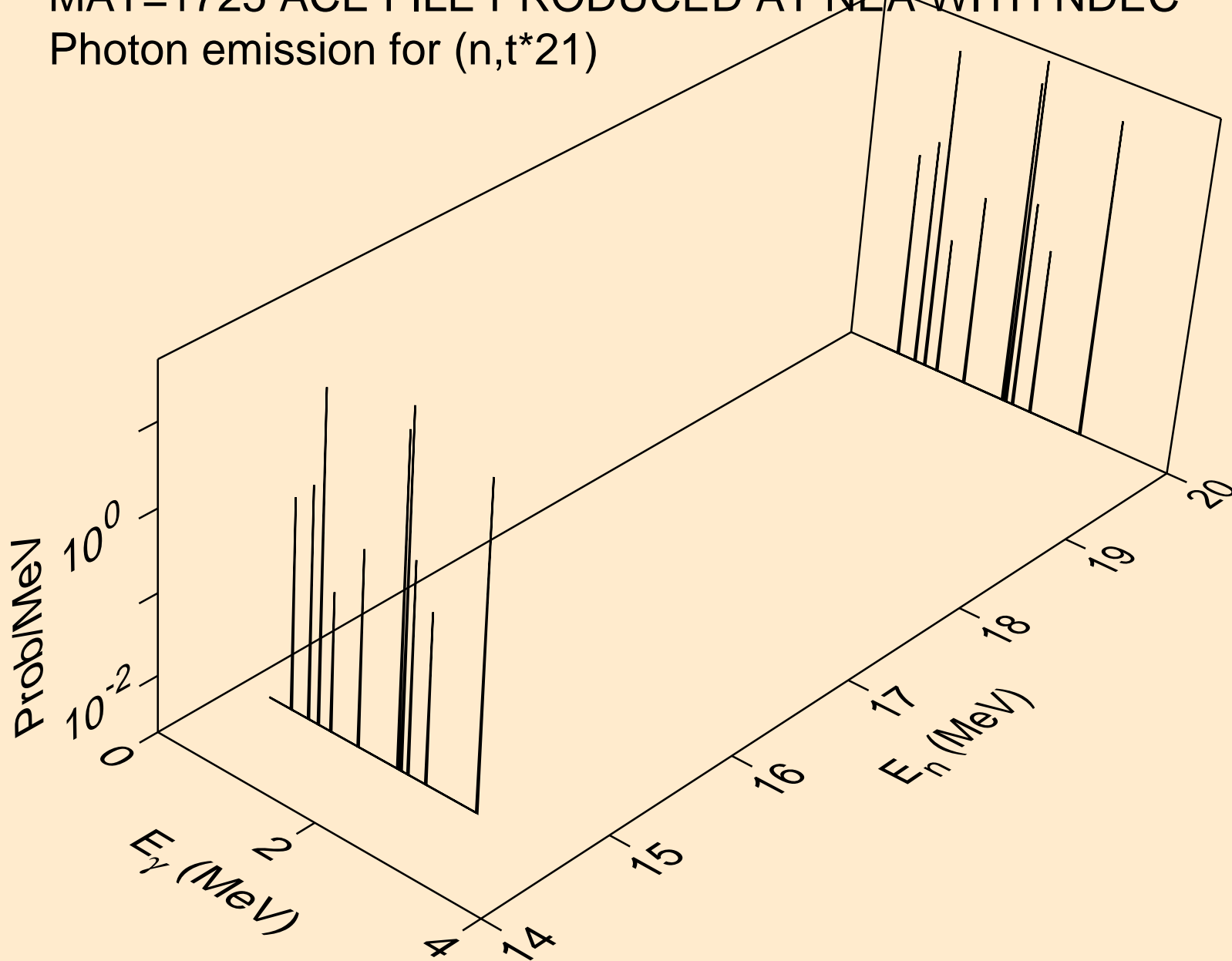

MAT=1725 ACE FILE PRODUCED AT NEA WITH NDEC
Photon emission for (n,t*22)

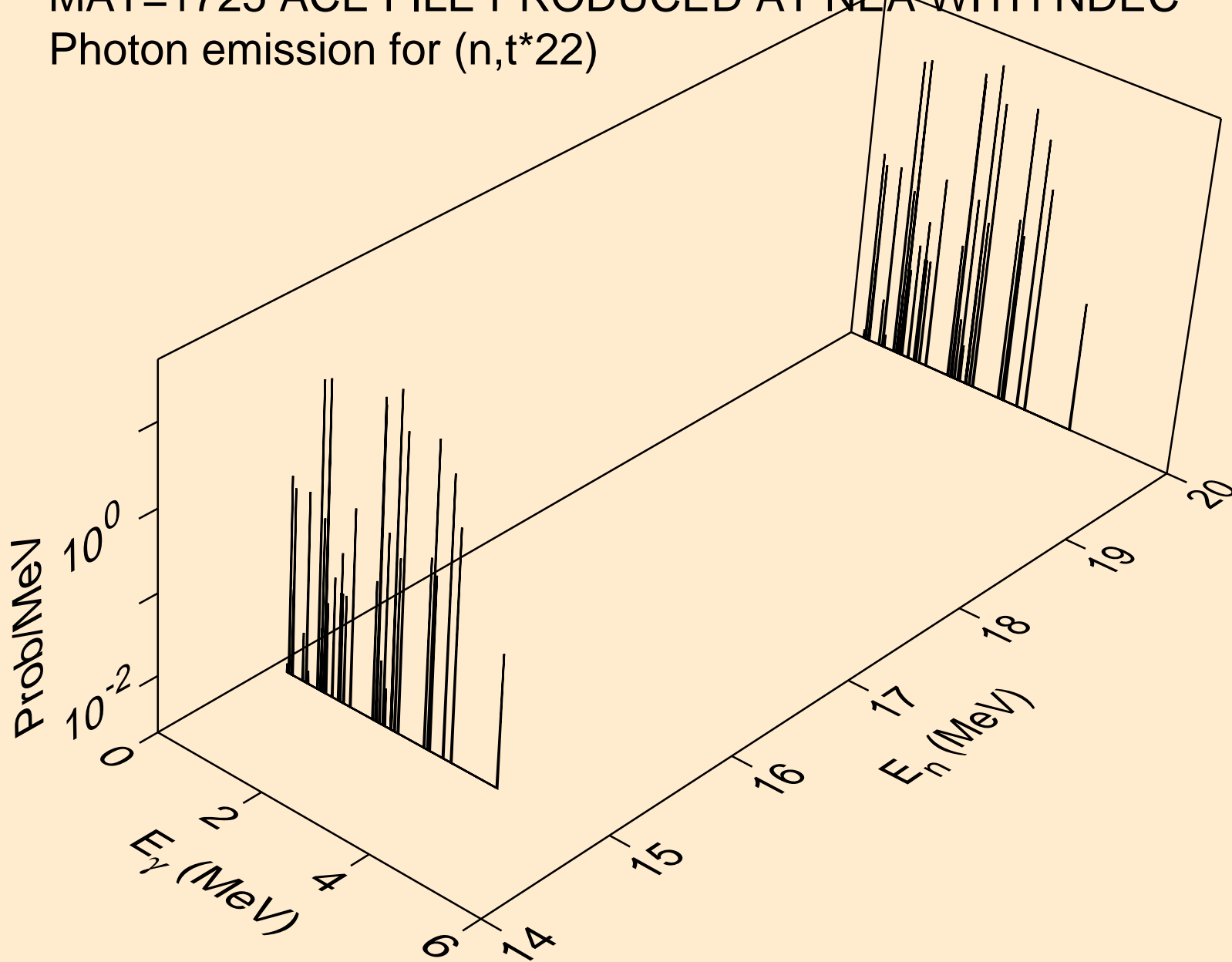

MAT=1725 ACE FILE PRODUCED AT NEA WITH NDEC
Photon emission for (n,t*23)

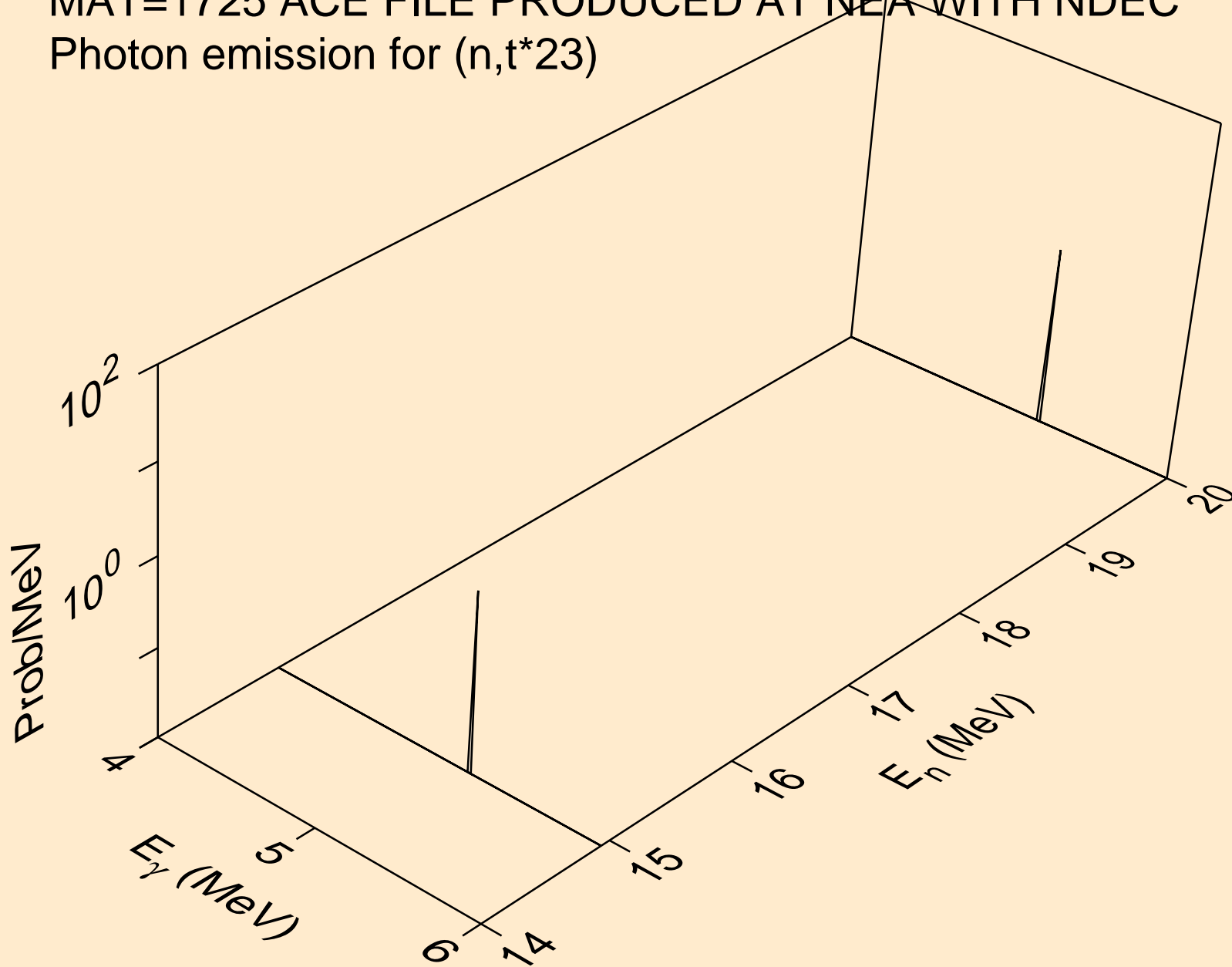

MAT=1725 ACE FILE PRODUCED AT NEA WITH NDEC
Photon emission for (n,t*24)

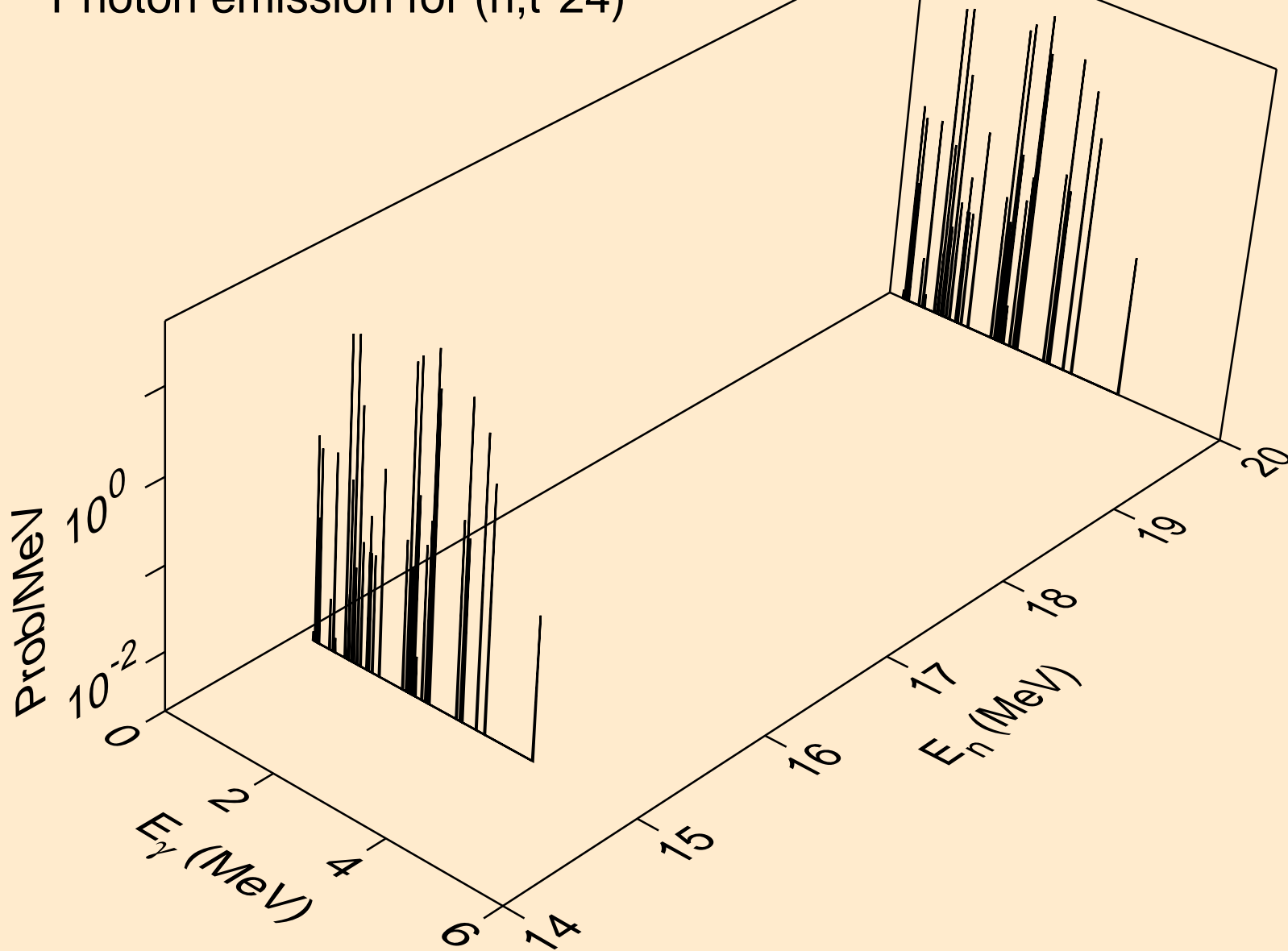

MAT=1725 ACE FILE PRODUCED AT NEA WITH NDEC
Photon emission for (n,t*25)

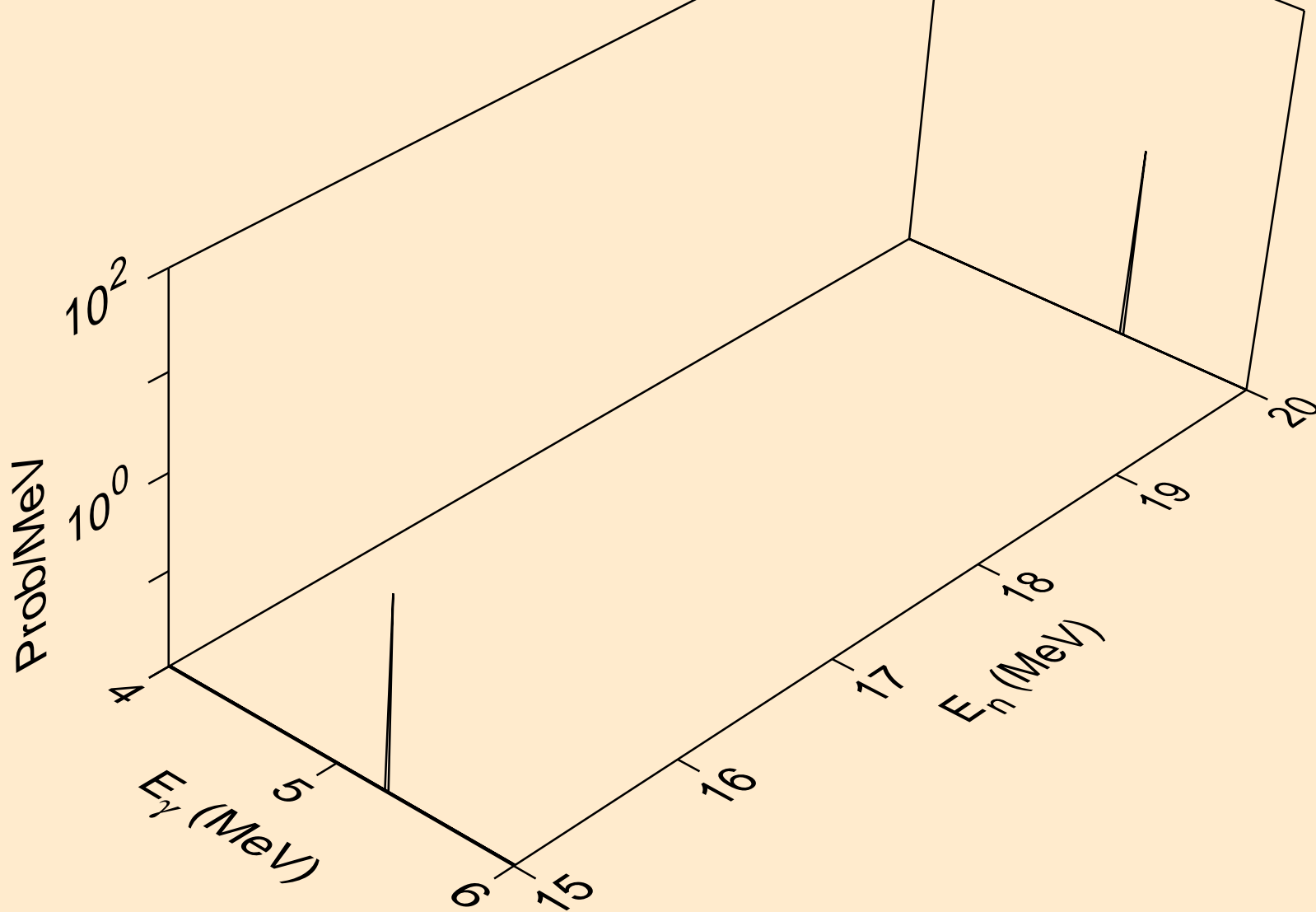

MAT=1725 ACE FILE PRODUCED AT NEA WITH NDEC
Photon emission for (n,t*26)

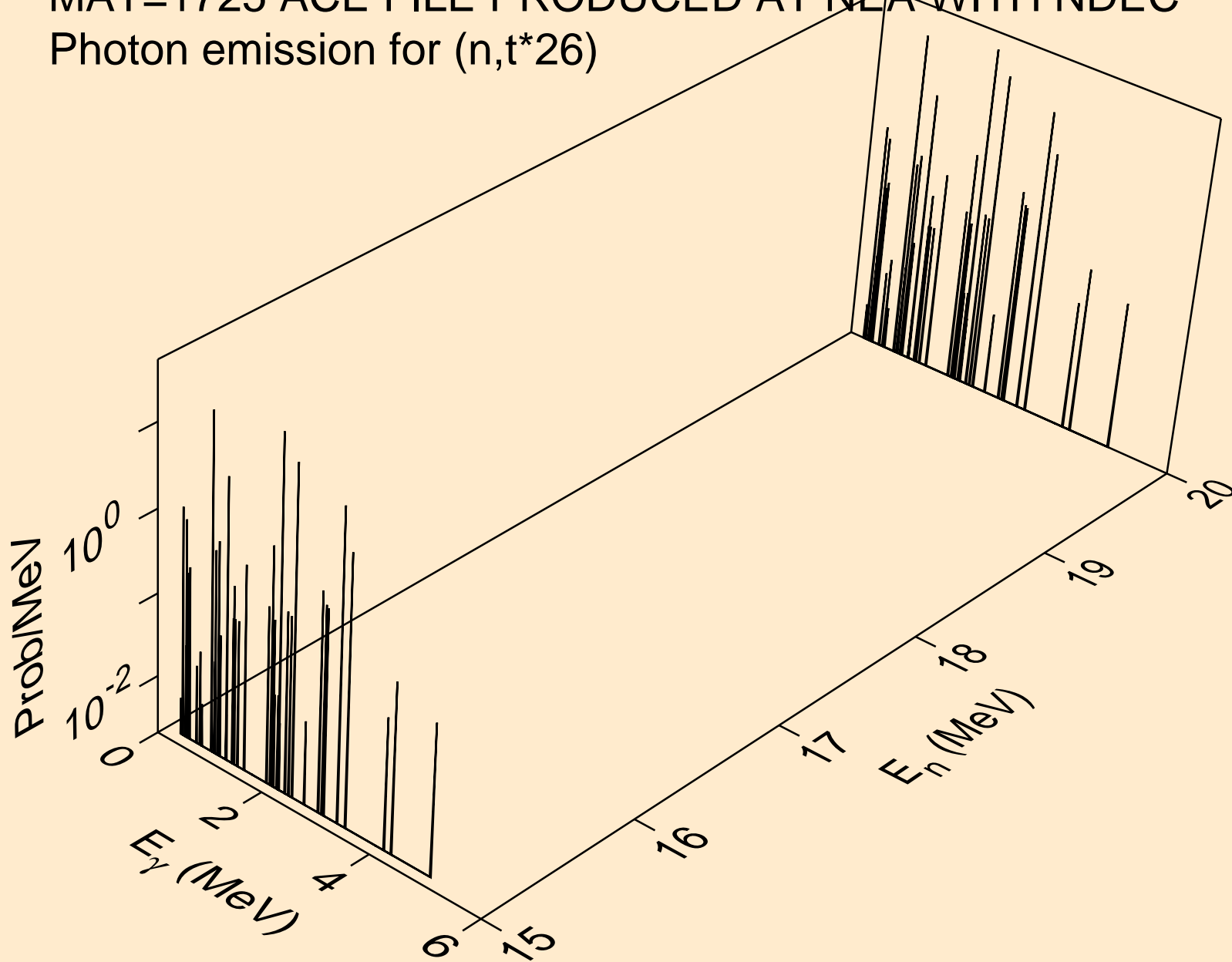

MAT=1725 ACE FILE PRODUCED AT NEA WITH NDEC
Photon emission for (n,t*27)

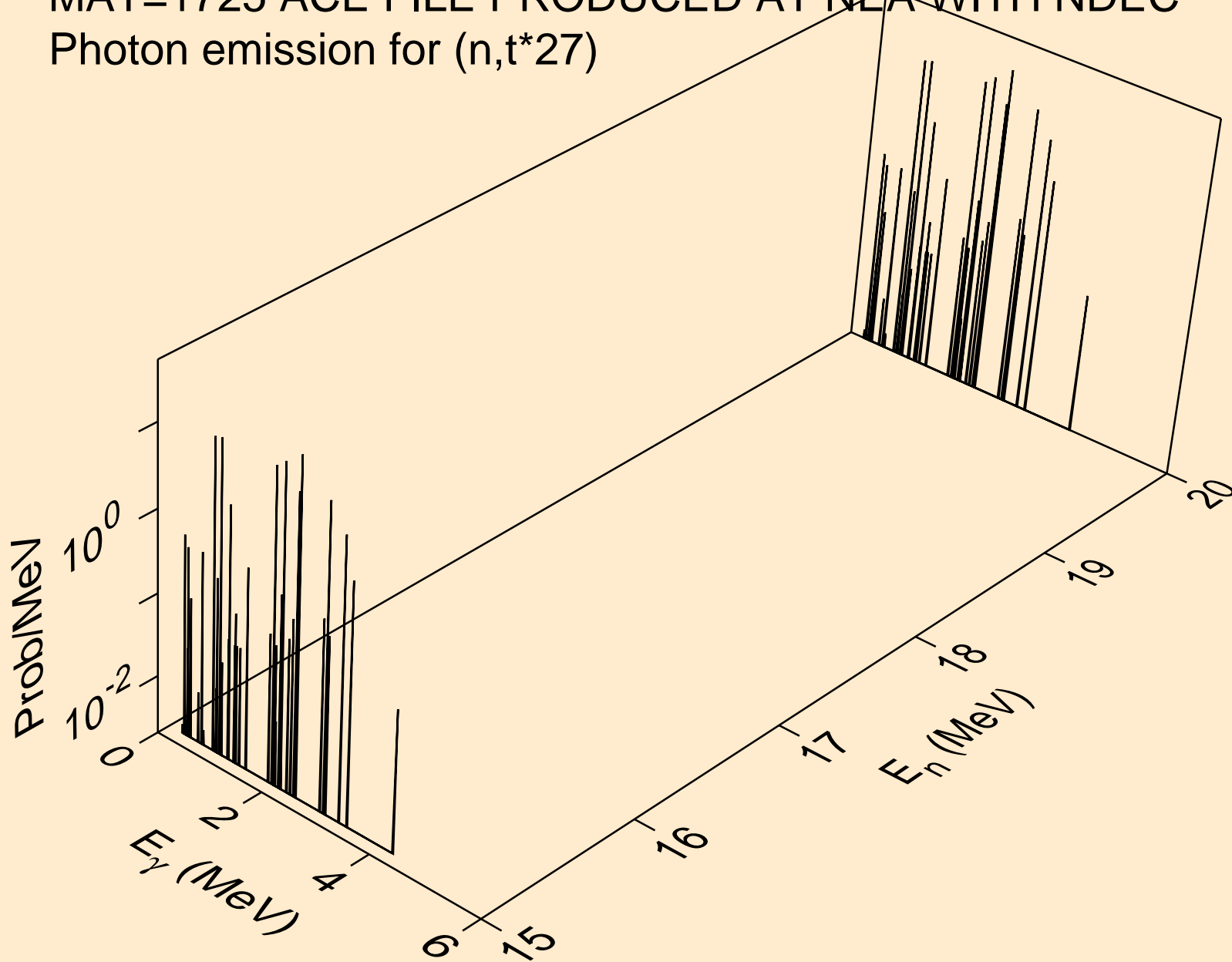

MAT=1725 ACE FILE PRODUCED AT NEA WITH NDEC
Photon emission for (n,t*28)

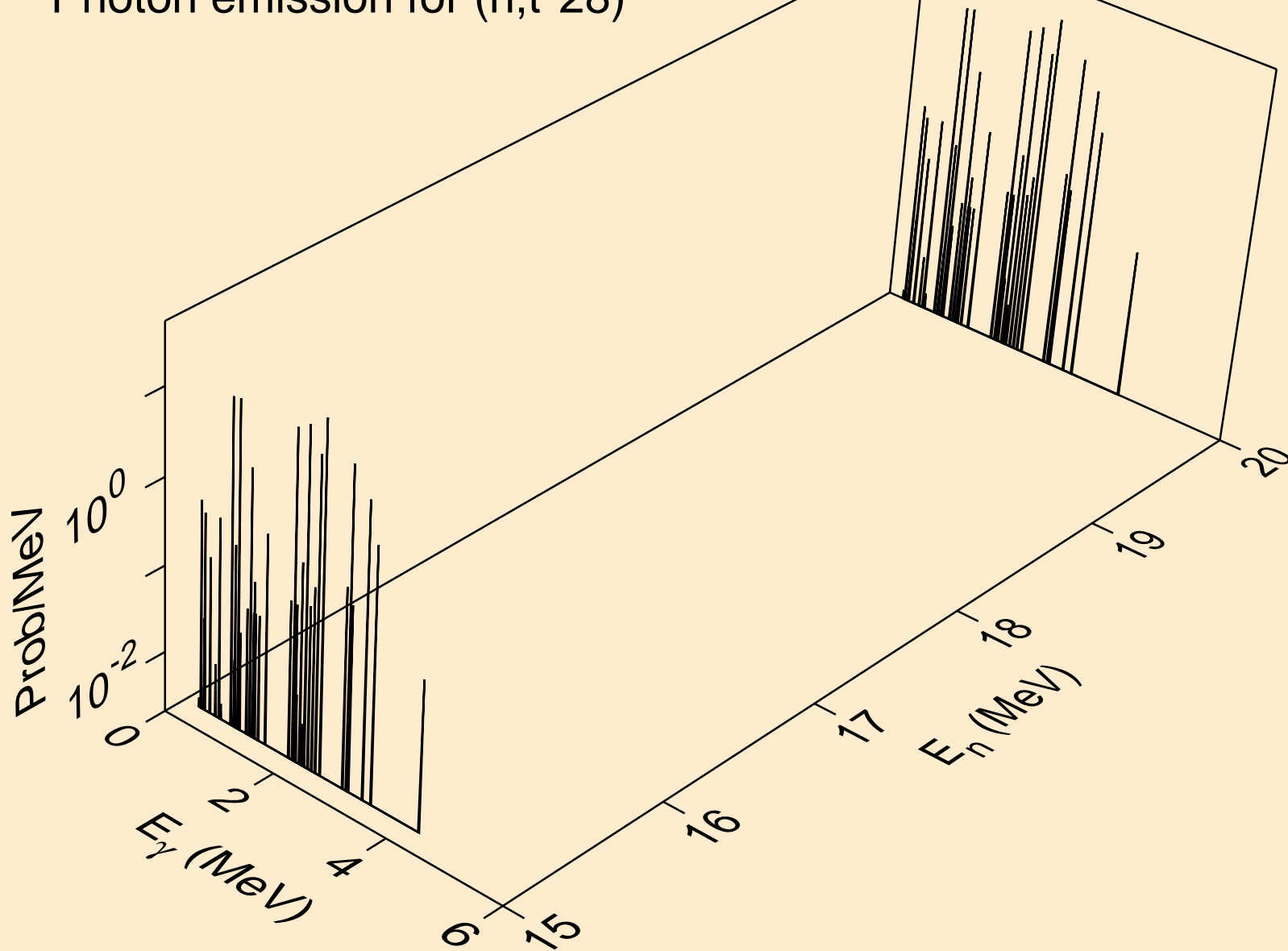

MAT=1725 ACE FILE PRODUCED AT NEA WITH NDEC
Photon emission for (n,t*29)

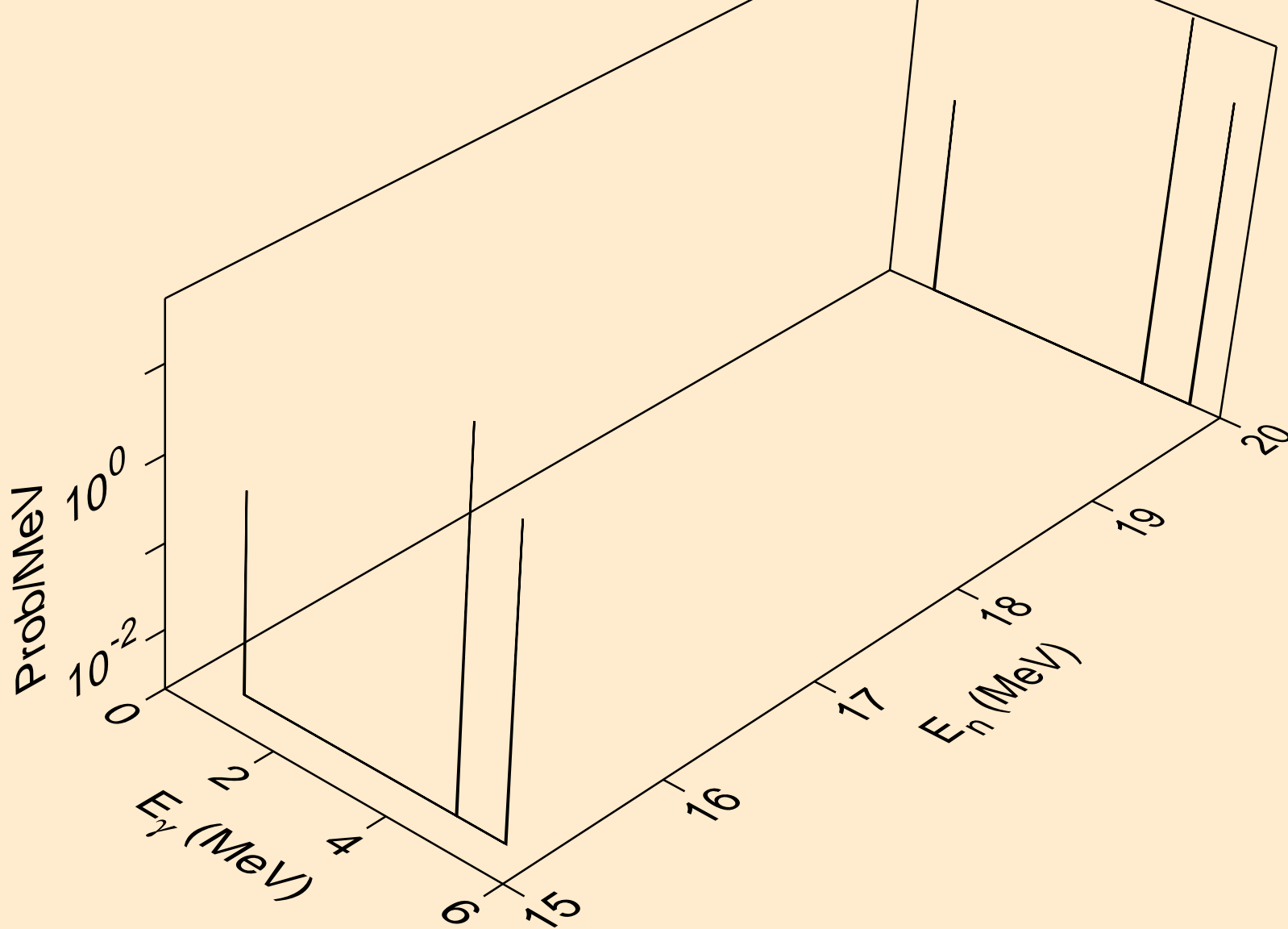

MAT=1725 ACE FILE PRODUCED AT NEA WITH NDEC
Photon emission for (n,t*30)

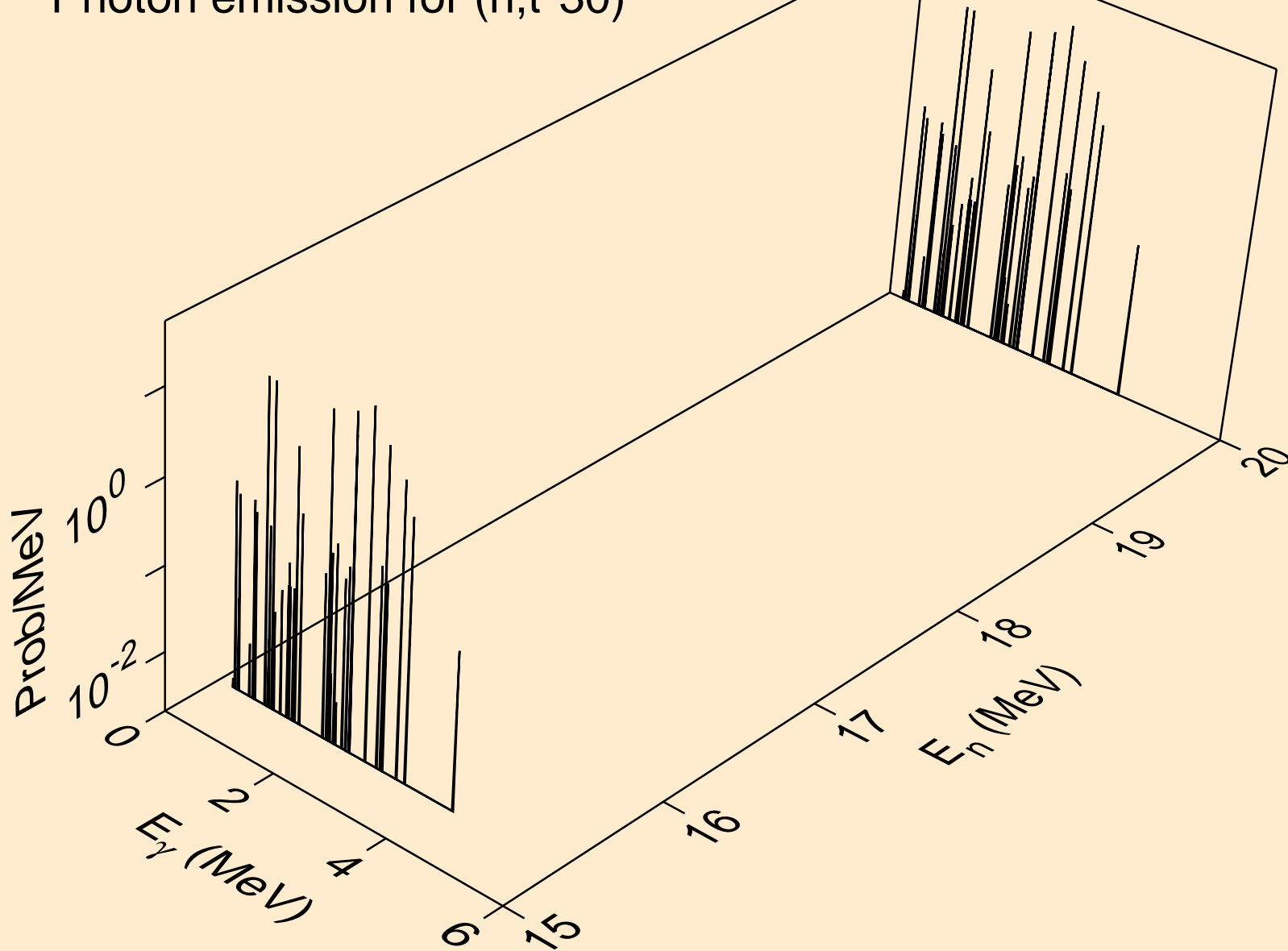

MAT=1725 ACE FILE PRODUCED AT NEA WITH NDEC
Photon emission for (n,t*c)

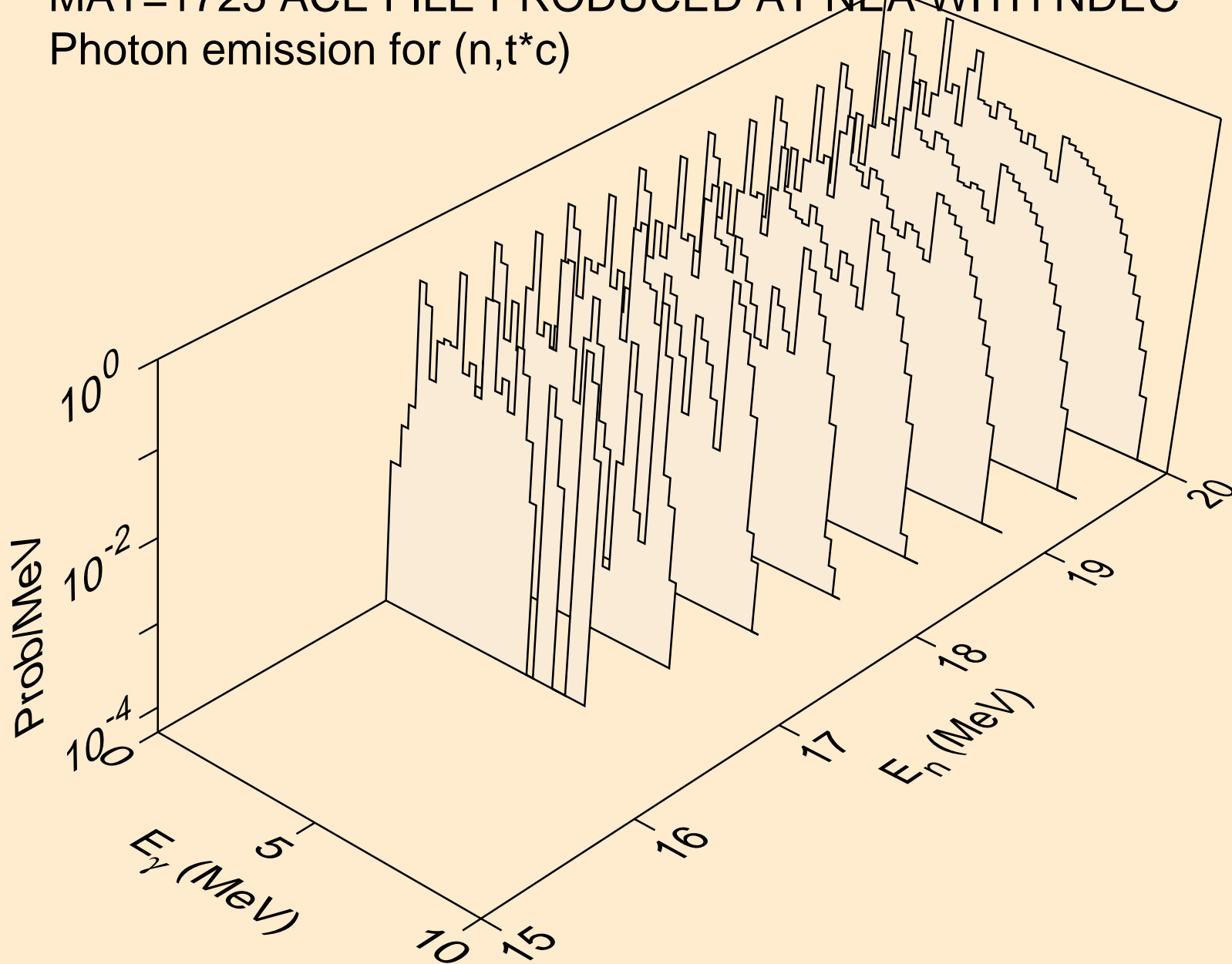

MAT=1725 ACE FILE PRODUCED AT NEA WITH NDEC
Photon emission for (n,a*1)

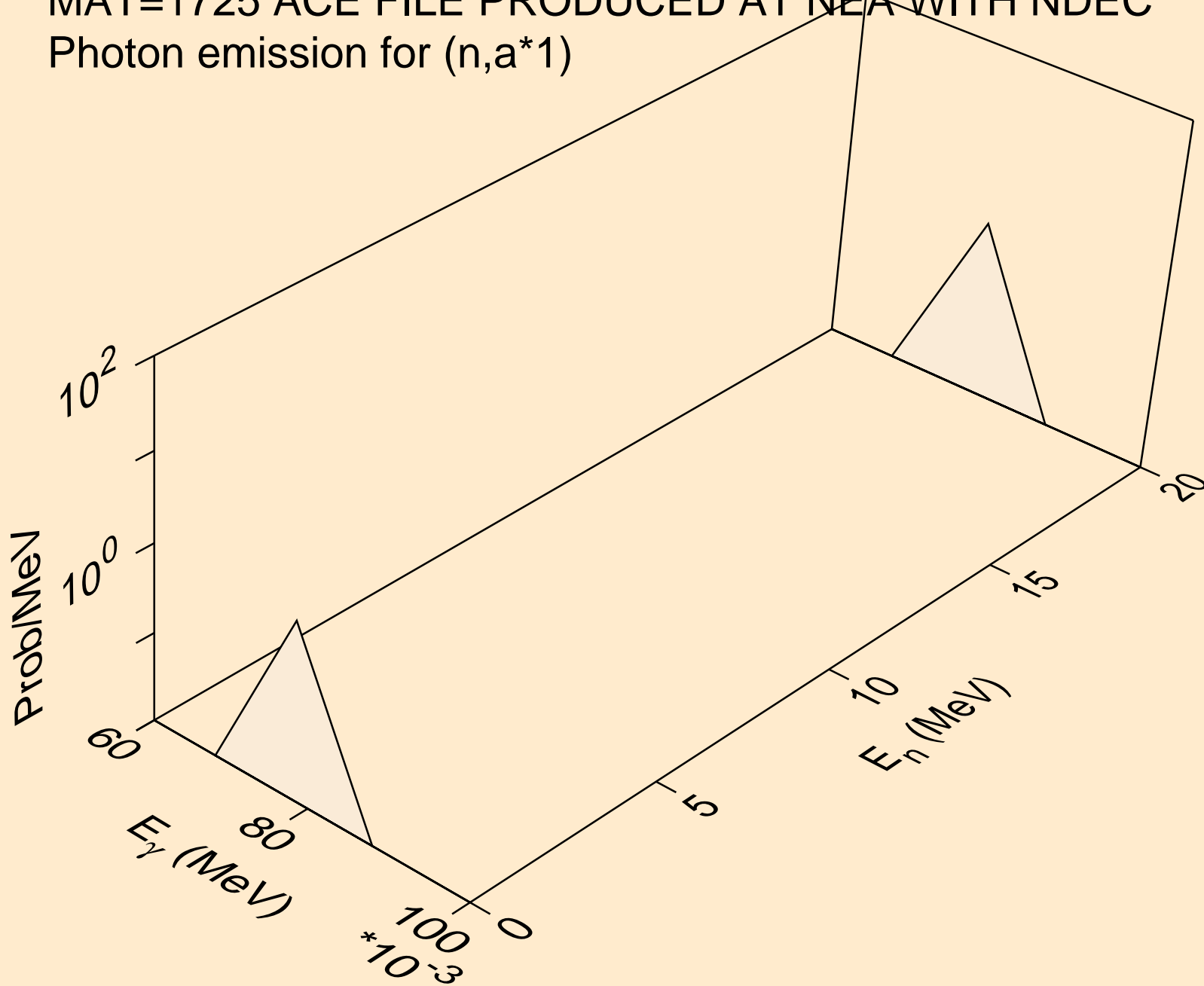

MAT=1725 ACE FILE PRODUCED AT NEA WITH NDEC
Photon emission for (n,a*2)

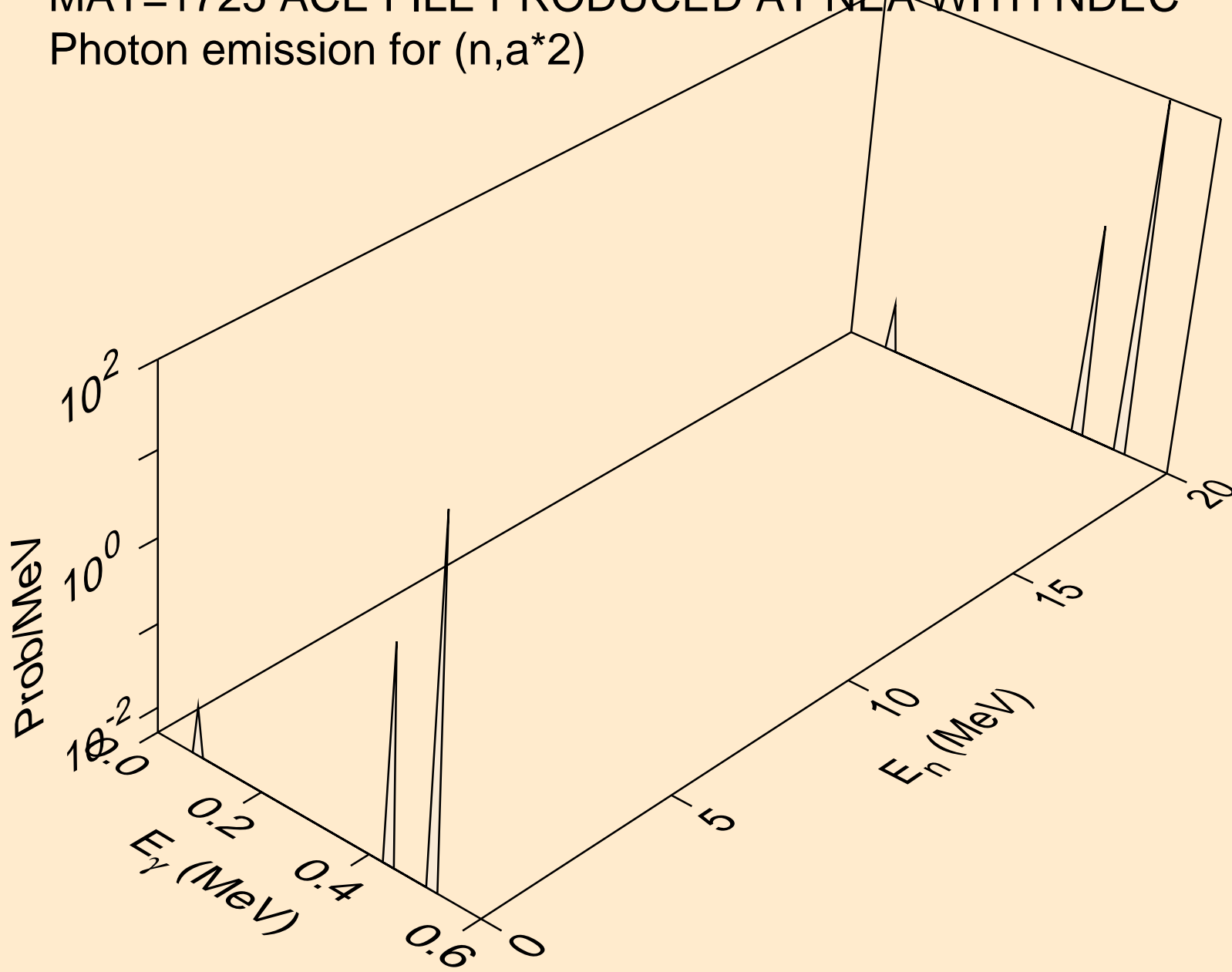

MAT=1725 ACE FILE PRODUCED AT NEA WITH NDEC
Photon emission for (n,a*3)

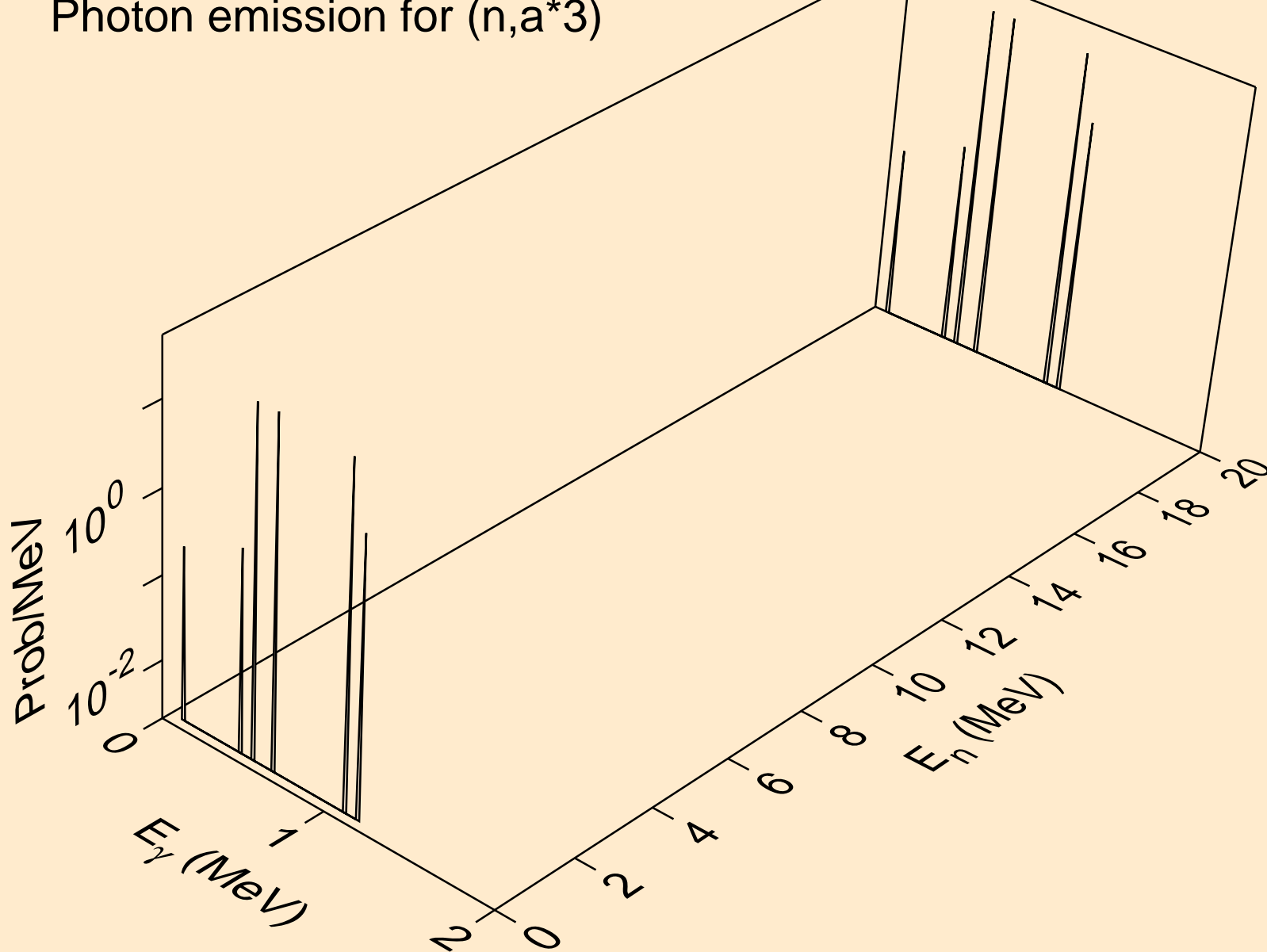

MAT=1725 ACE FILE PRODUCED AT NEA WITH NDEC
Photon emission for (n,a*4)

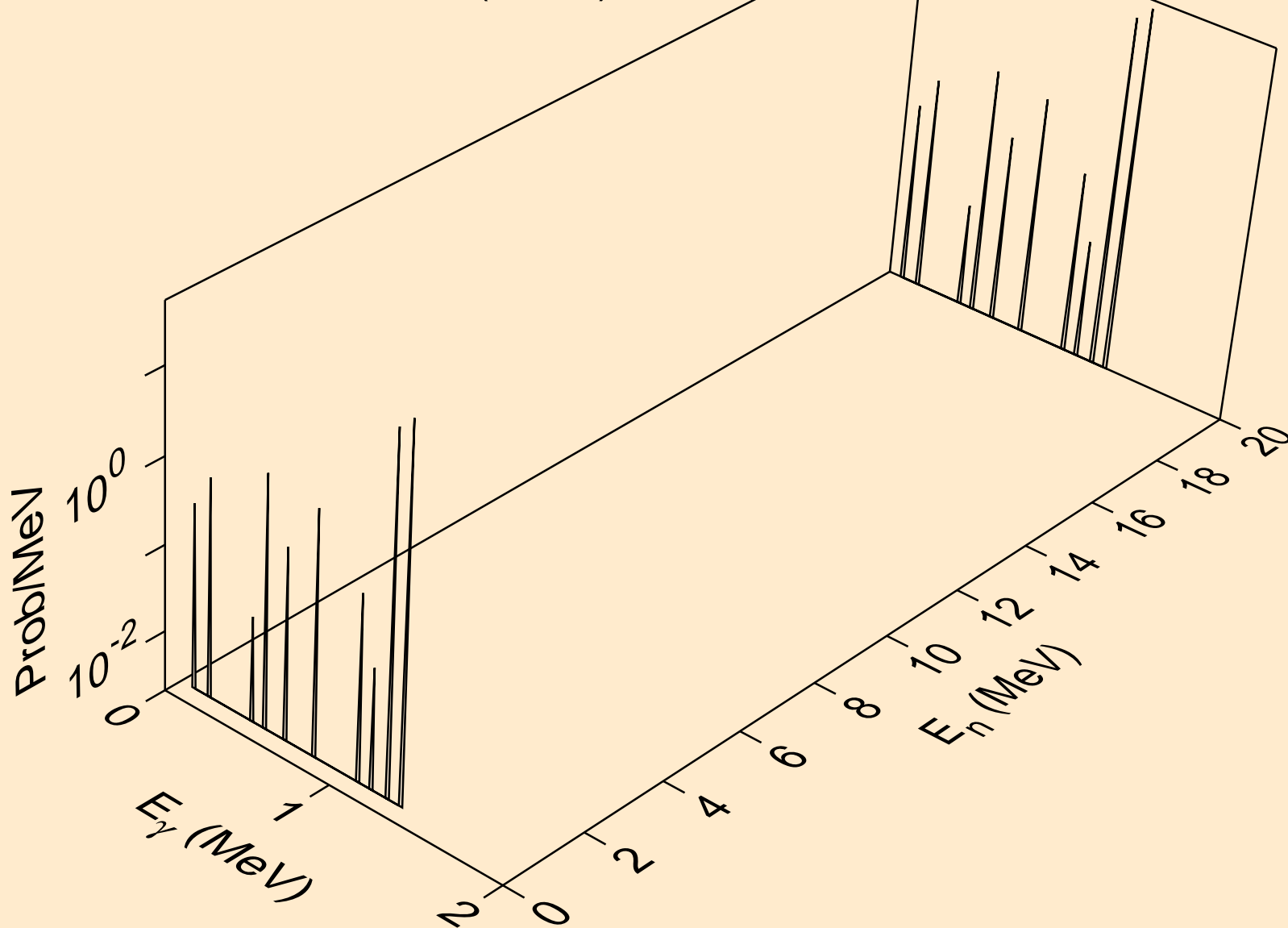

MAT=1725 ACE FILE PRODUCED AT NEA WITH NDEC
Photon emission for (n,a*5)

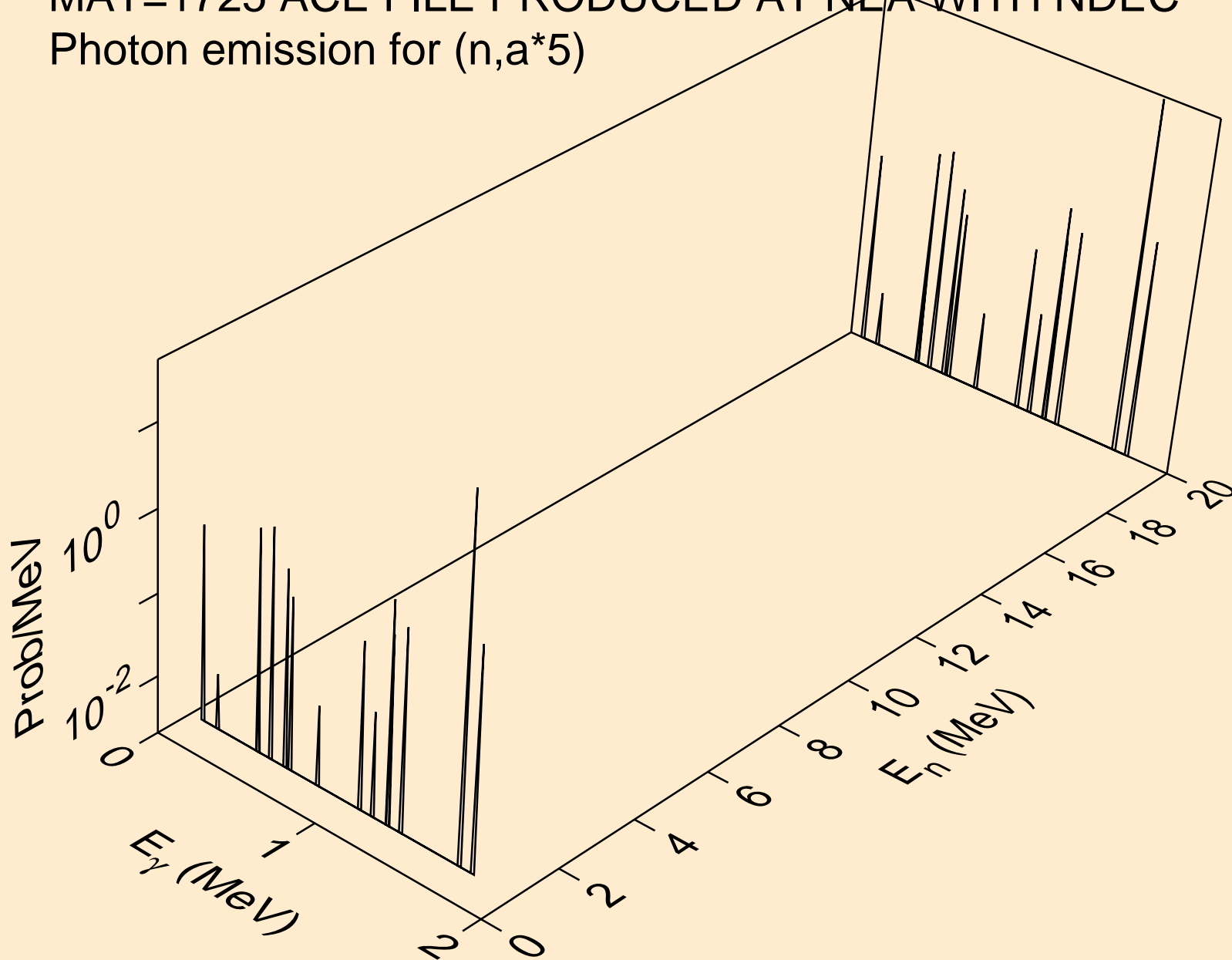

MAT=1725 ACE FILE PRODUCED AT NEA WITH NDEC
Photon emission for (n,a*6)

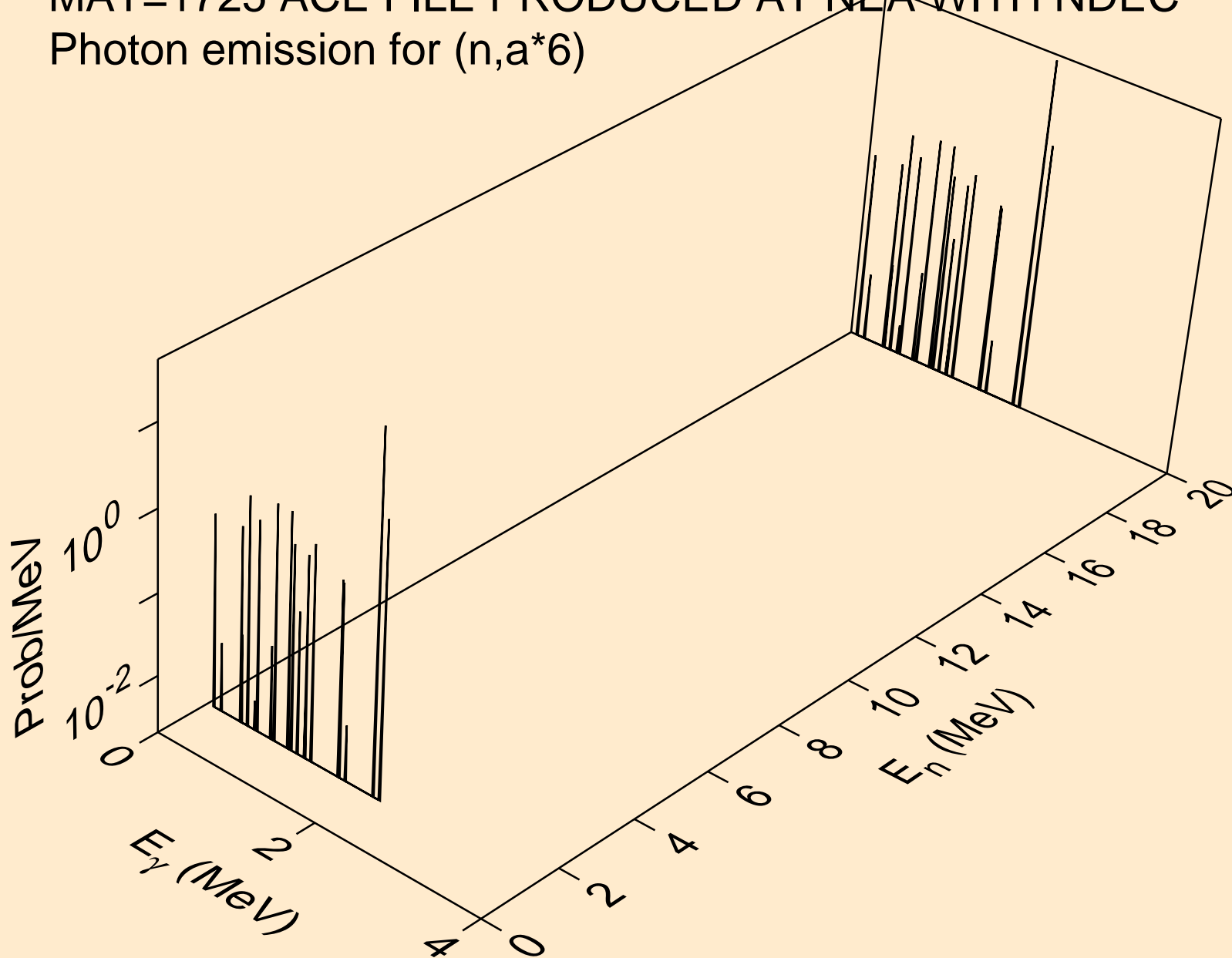

MAT=1725 ACE FILE PRODUCED AT NEA WITH NDEC
Photon emission for (n,a*7)

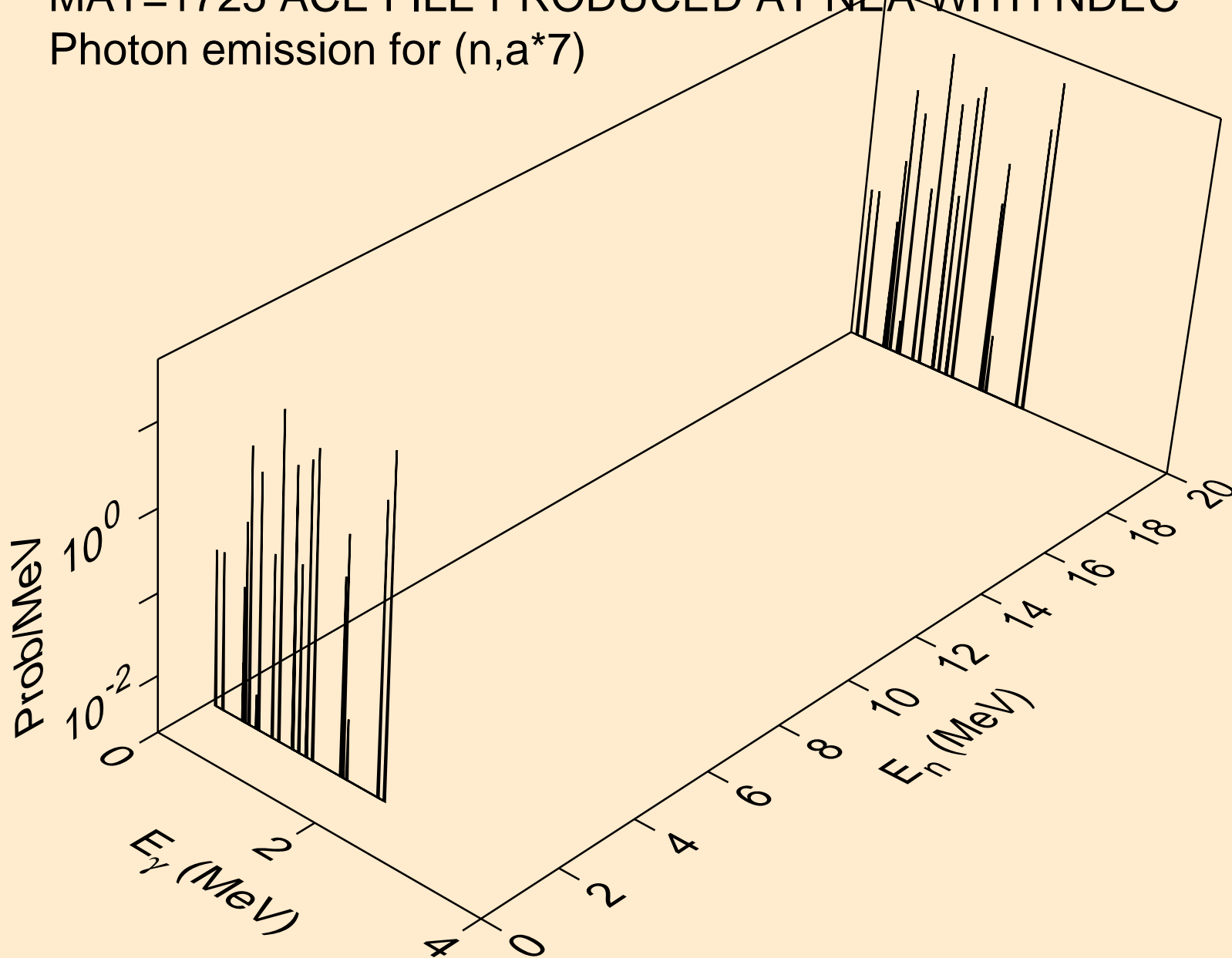

MAT=1725 ACE FILE PRODUCED AT NEA WITH NDEC
Photon emission for (n,a*8)

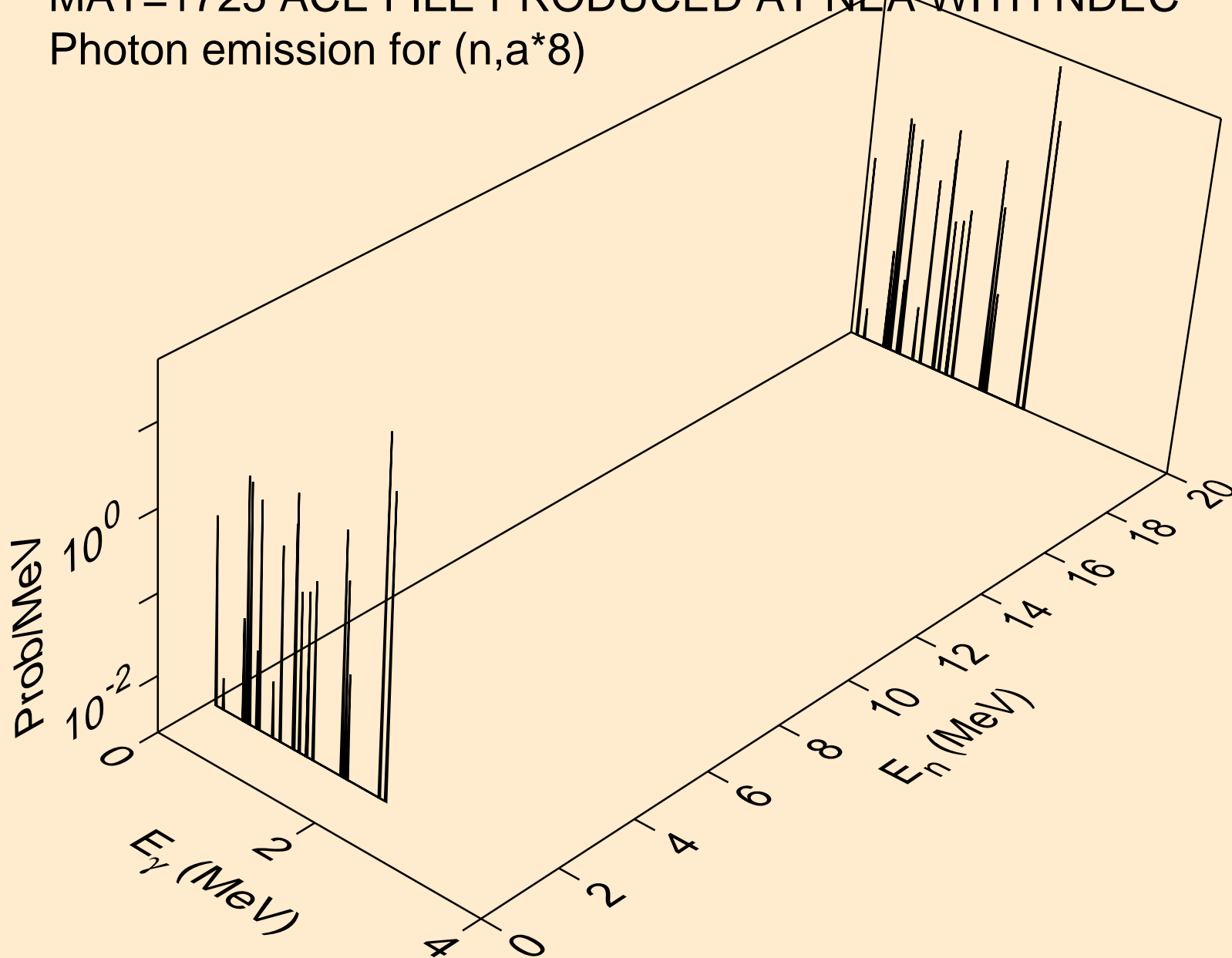

MAT=1725 ACE FILE PRODUCED AT NEA WITH NDEC
Photon emission for (n,a*9)

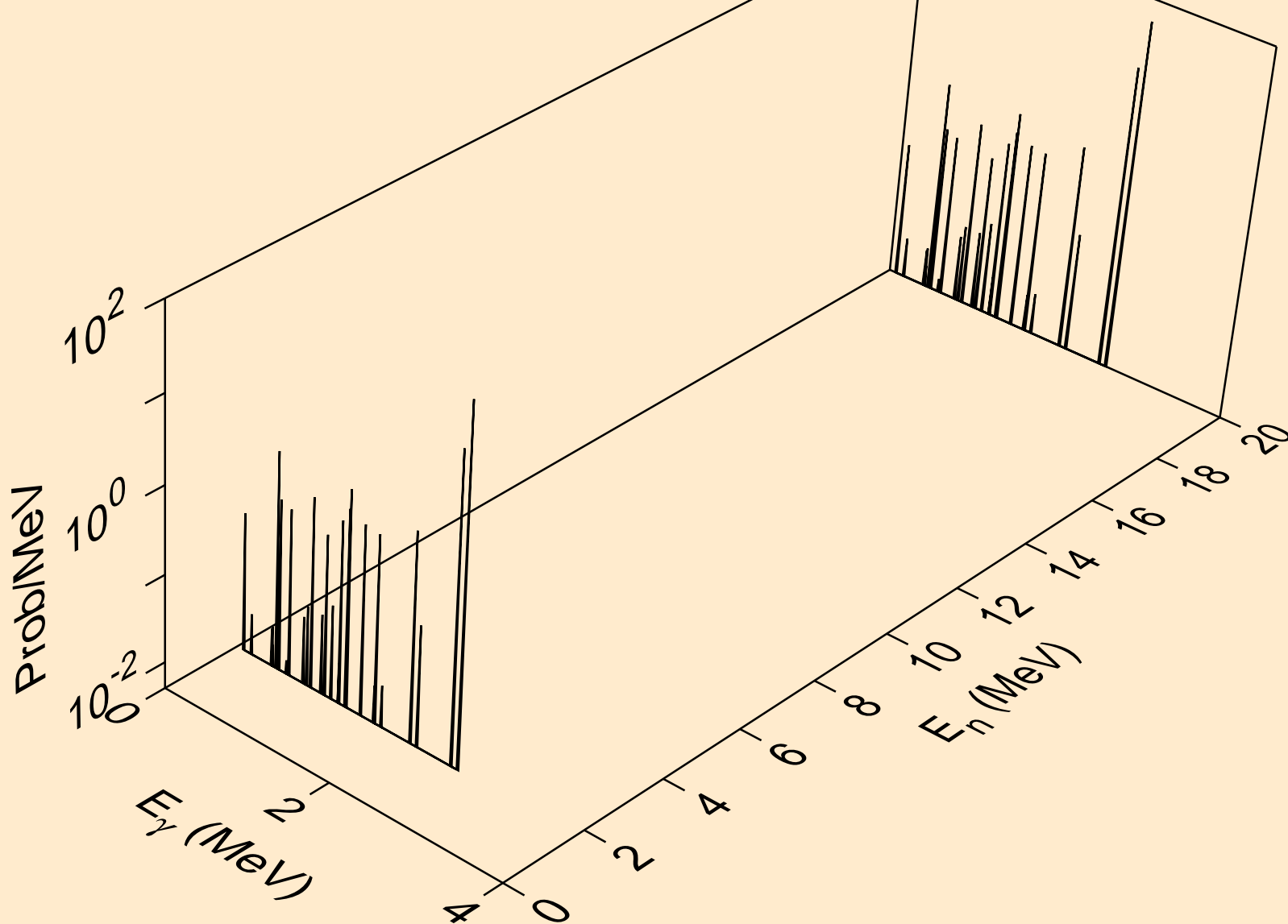

MAT=1725 ACE FILE PRODUCED AT NEA WITH NDEC
Photon emission for (n,a*10)

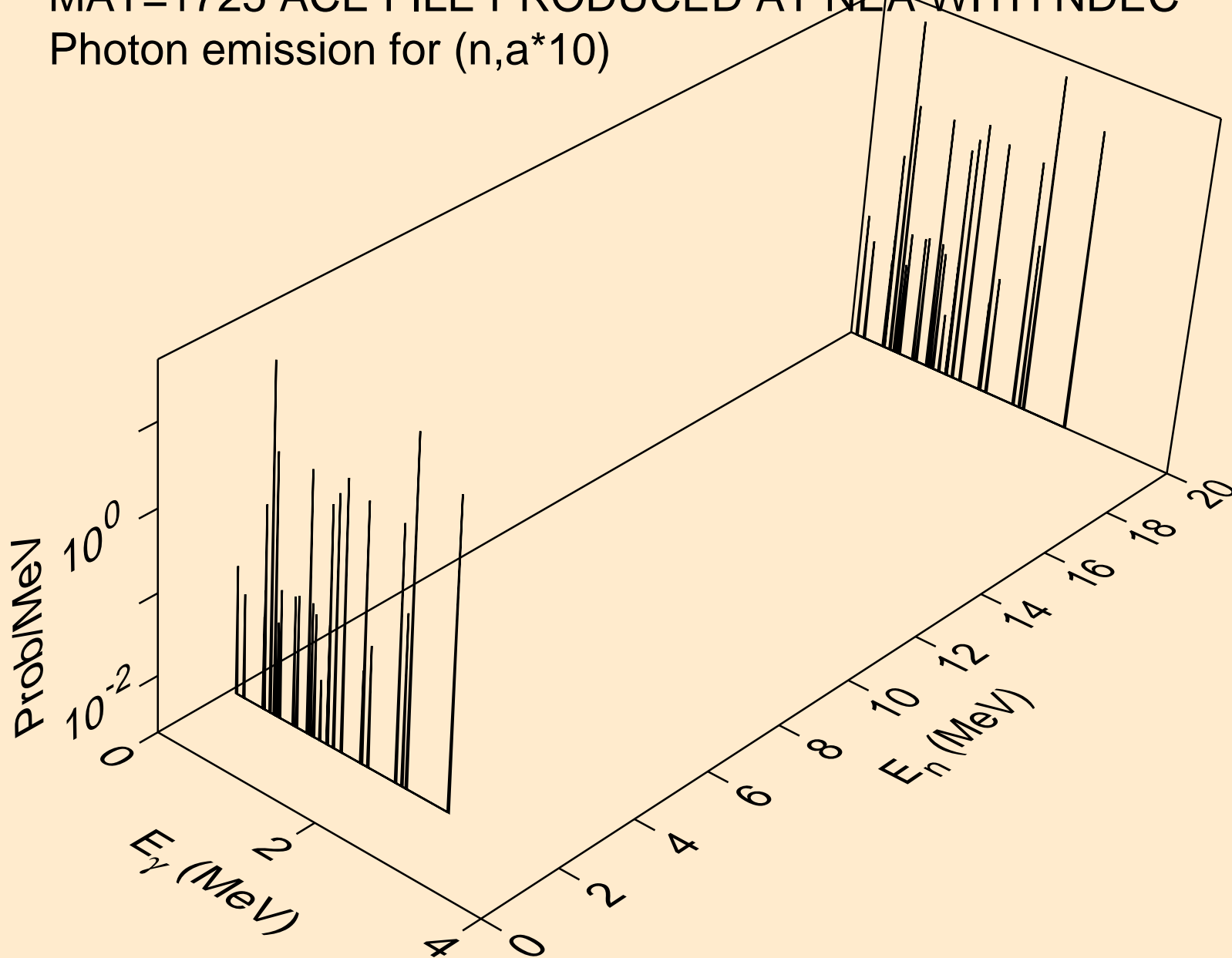

MAT=1725 ACE FILE PRODUCED AT NEA WITH NDEC
Photon emission for (n,a*11)

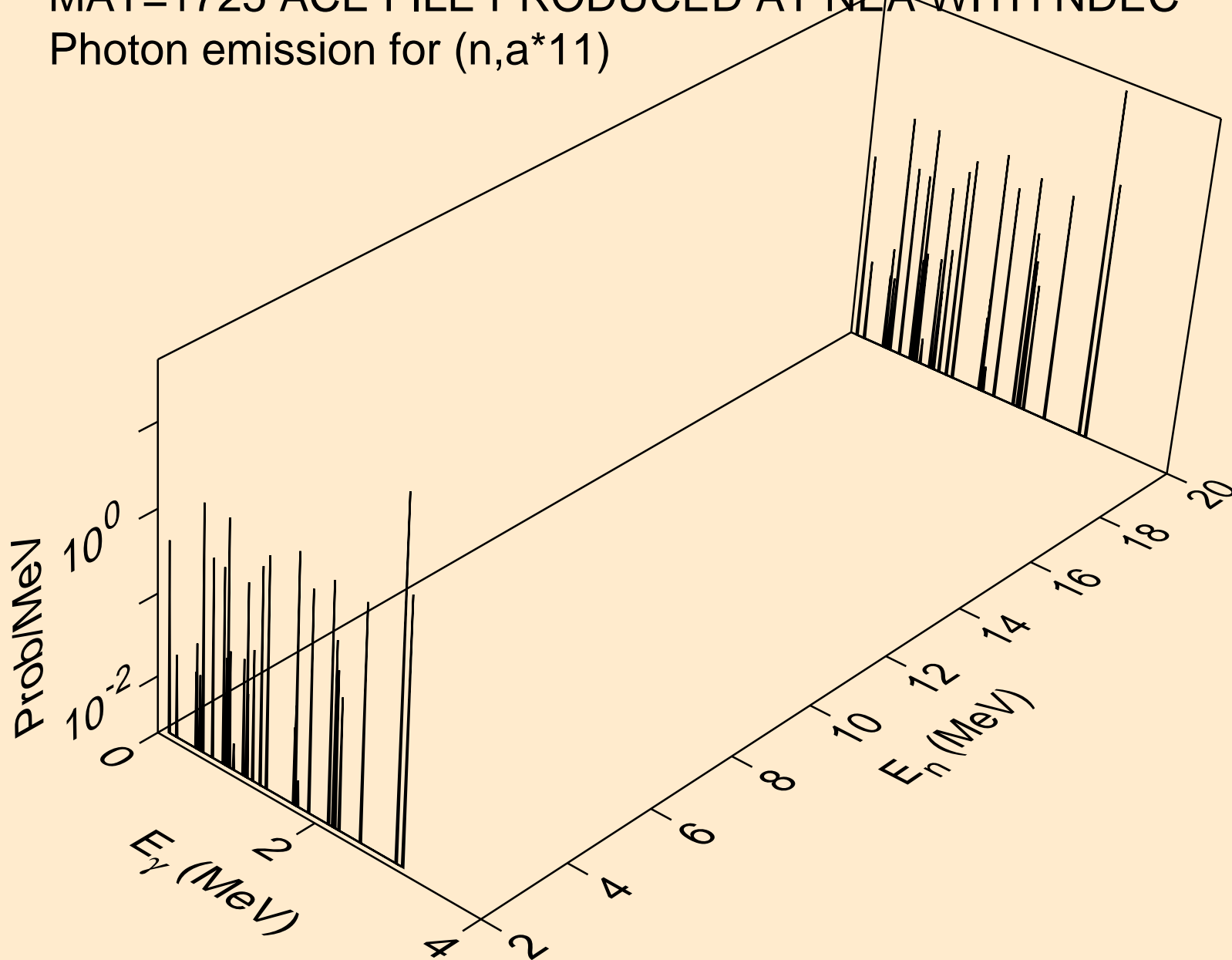

MAT=1725 ACE FILE PRODUCED AT NEA WITH NDEC
Photon emission for (n,a*12)

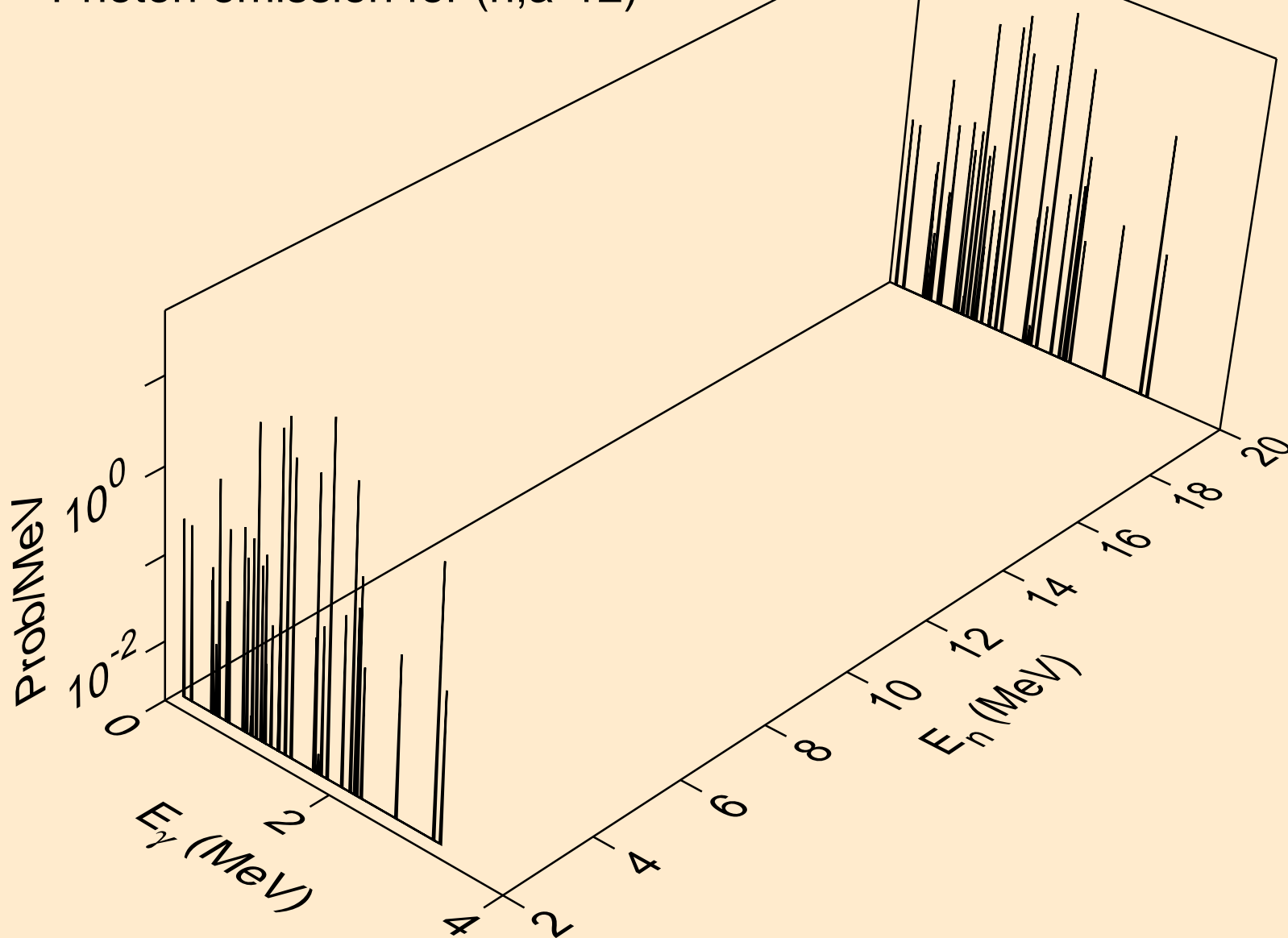

MAT=1725 ACE FILE PRODUCED AT NEA WITH NDEC
Photon emission for (n,a*13)

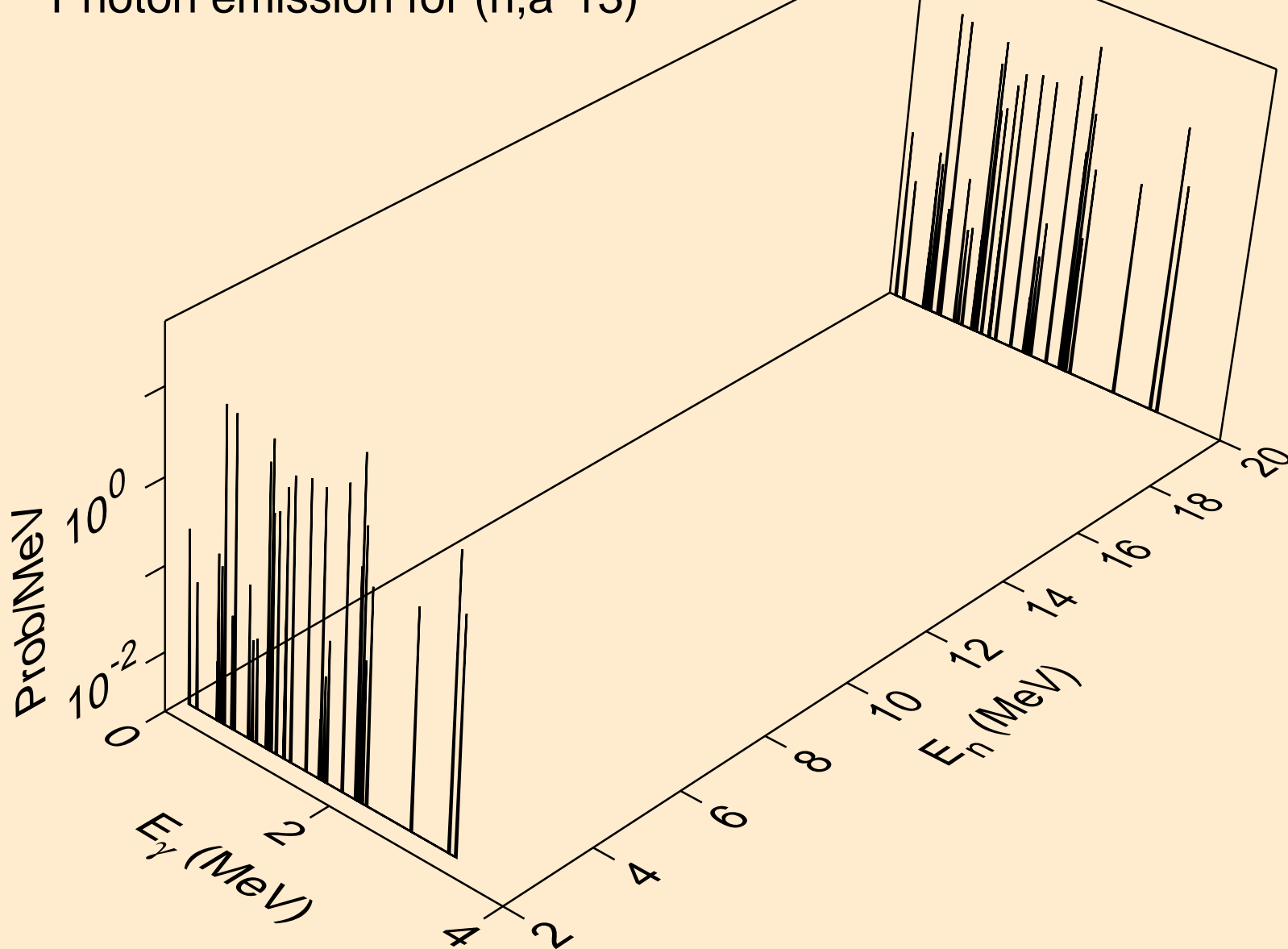

MAT=1725 ACE FILE PRODUCED AT NEA WITH NDEC
Photon emission for (n,a*14)

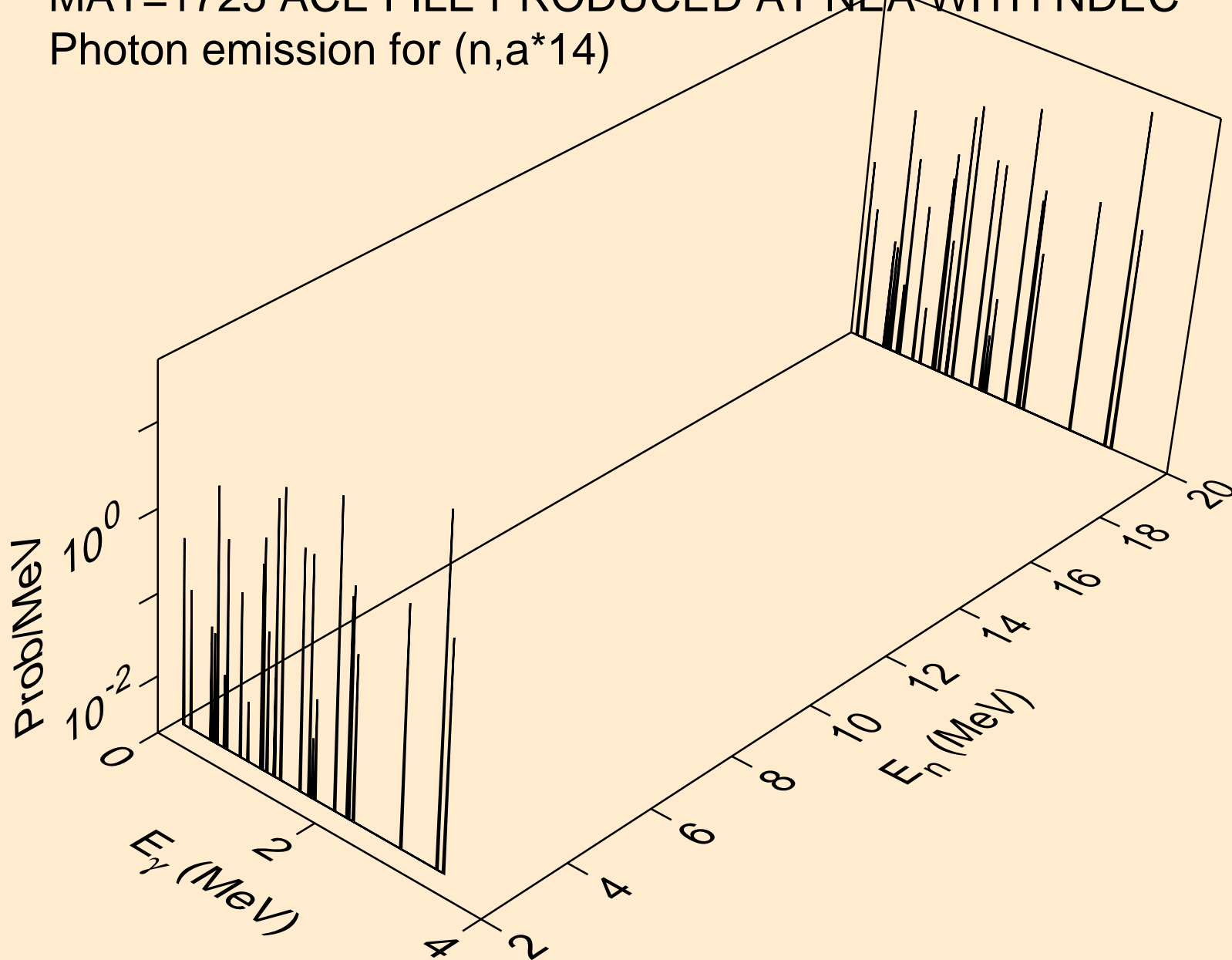

MAT=1725 ACE FILE PRODUCED AT NEA WITH NDEC
Photon emission for (n,a*15)

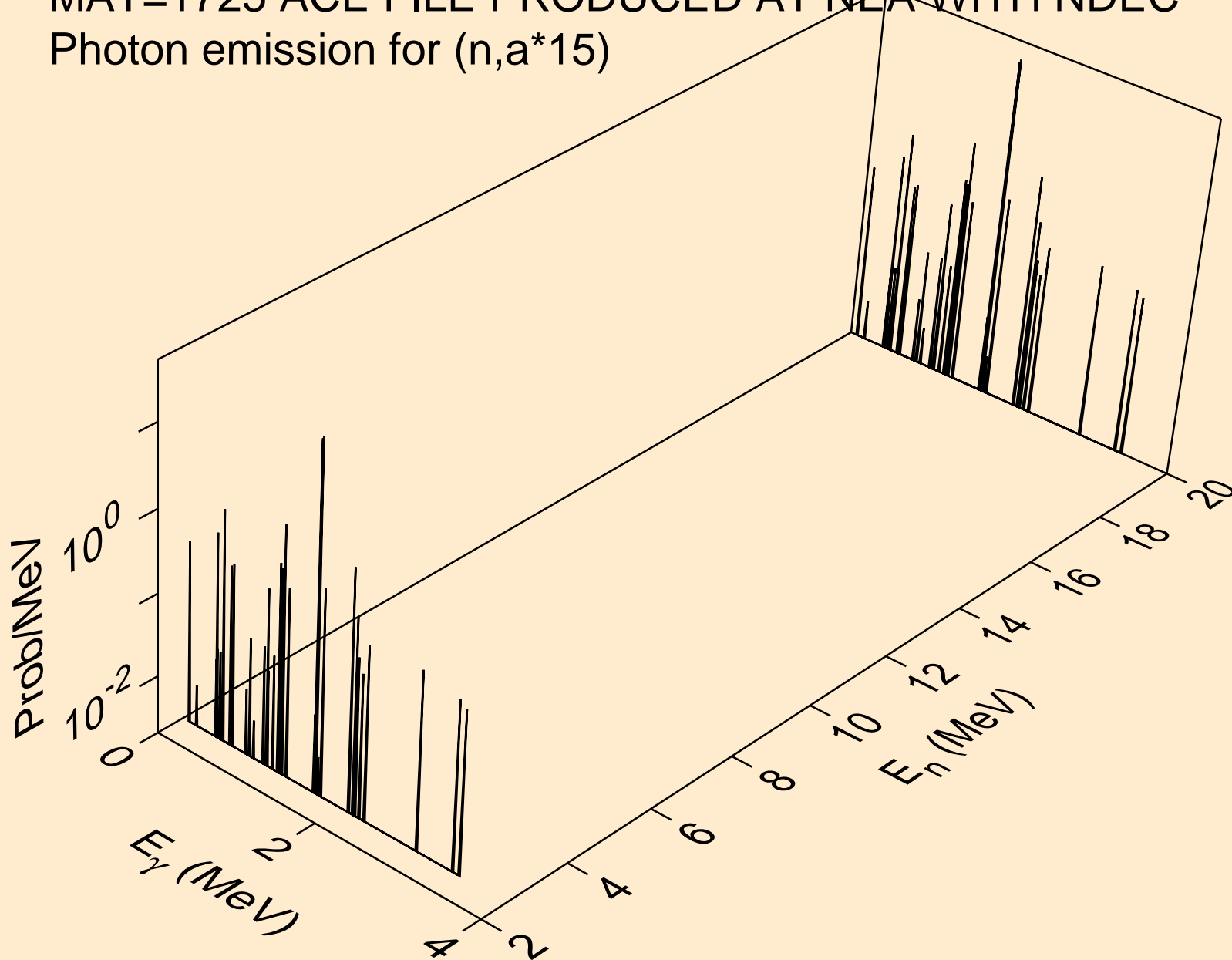

MAT=1725 ACE FILE PRODUCED AT NEA WITH NDEC
Photon emission for (n,a*16)

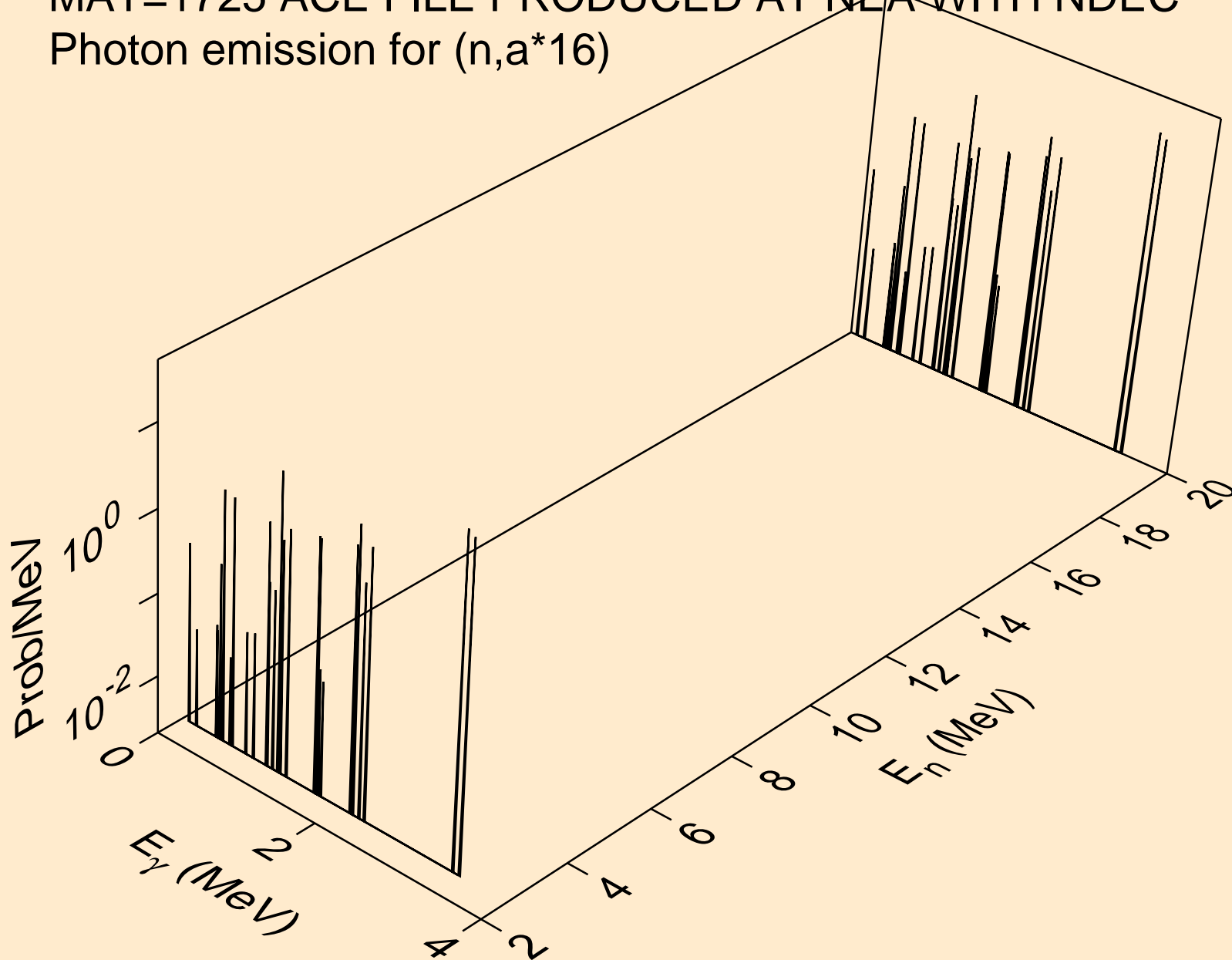

MAT=1725 ACE FILE PRODUCED AT NEA WITH NDEC
Photon emission for (n,a*17)

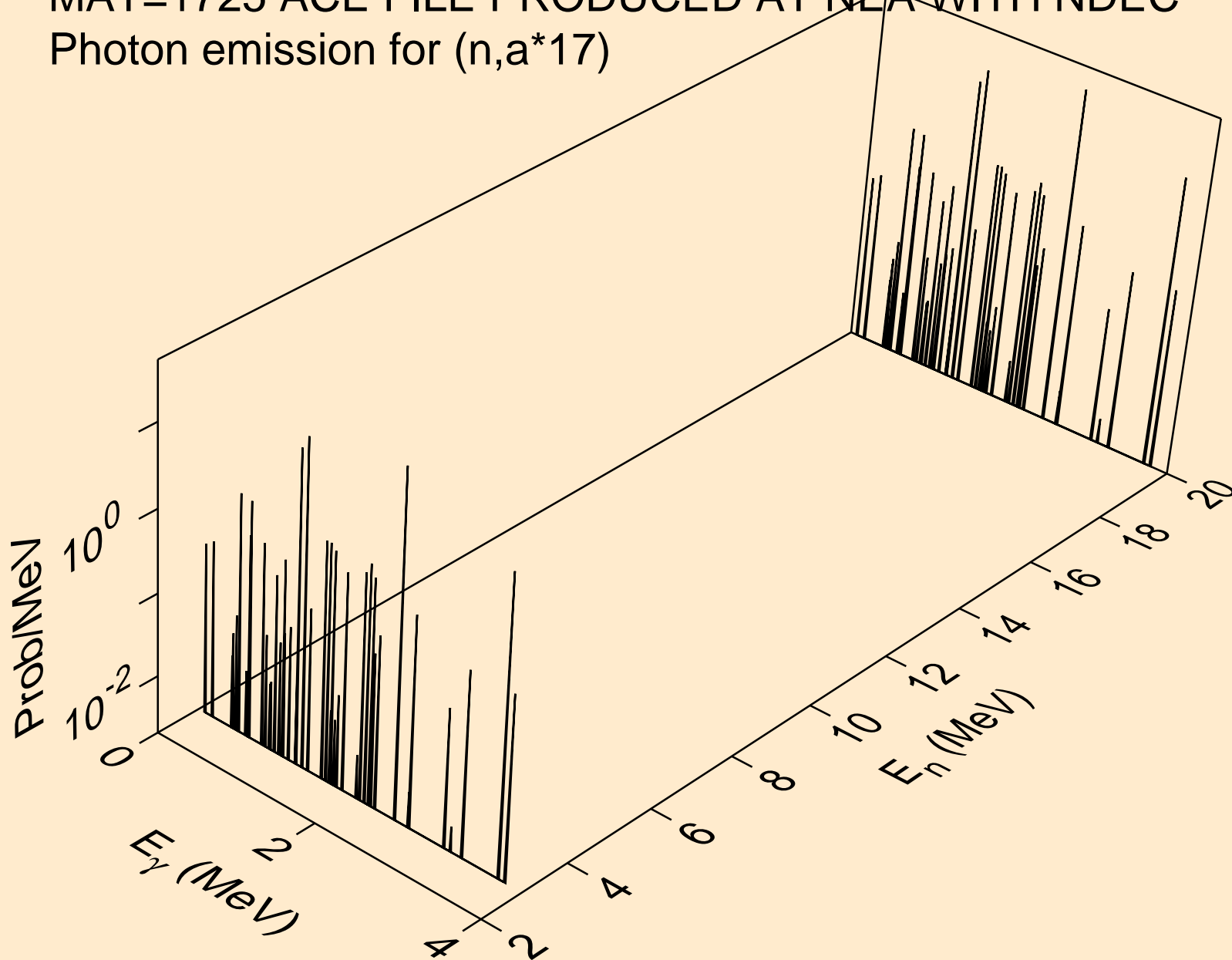

MAT=1725 ACE FILE PRODUCED AT NEA WITH NDEC
Photon emission for (n,a*18)

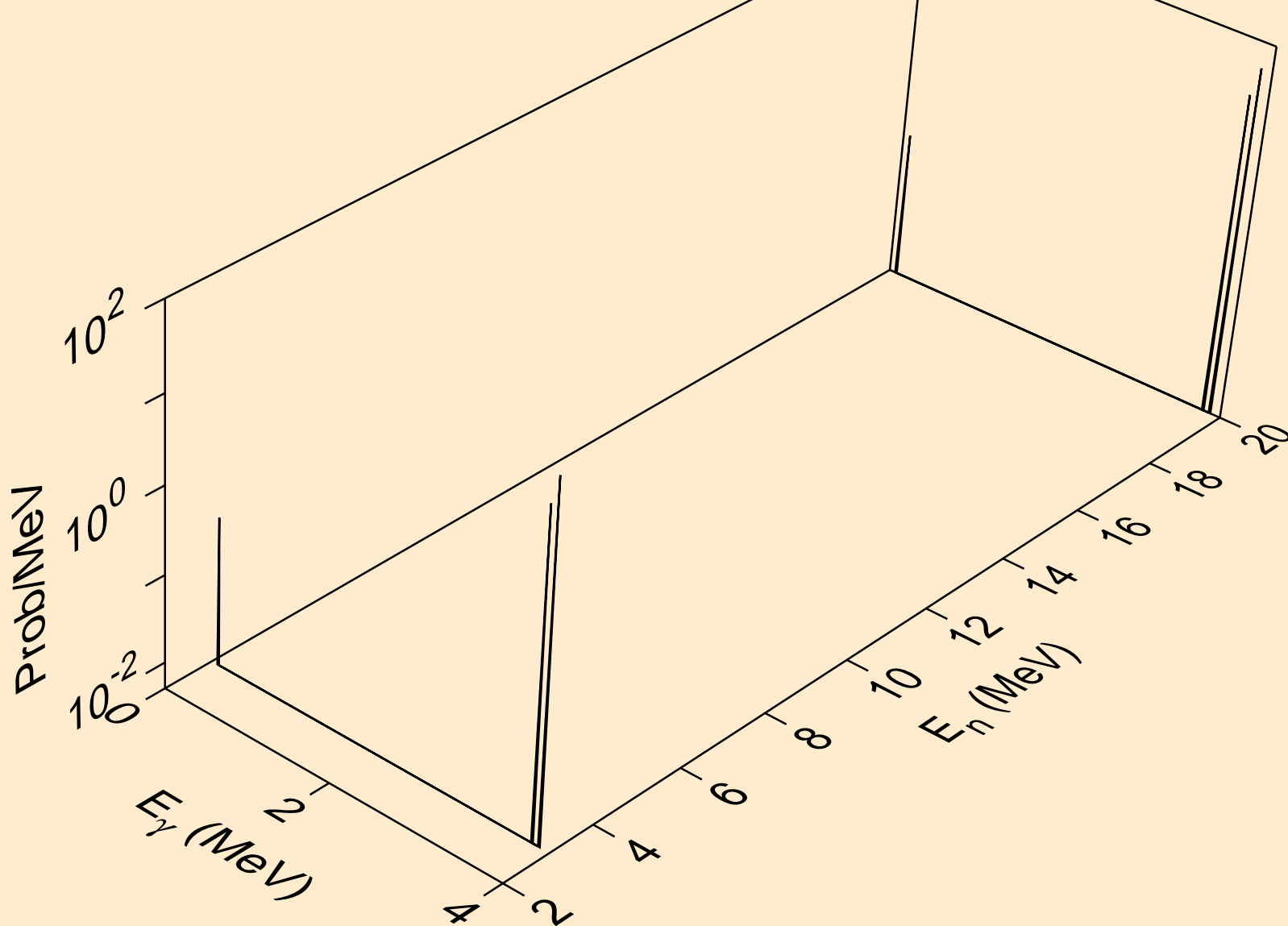

MAT=1725 ACE FILE PRODUCED AT NEA WITH NDEC
Photon emission for (n,a*19)

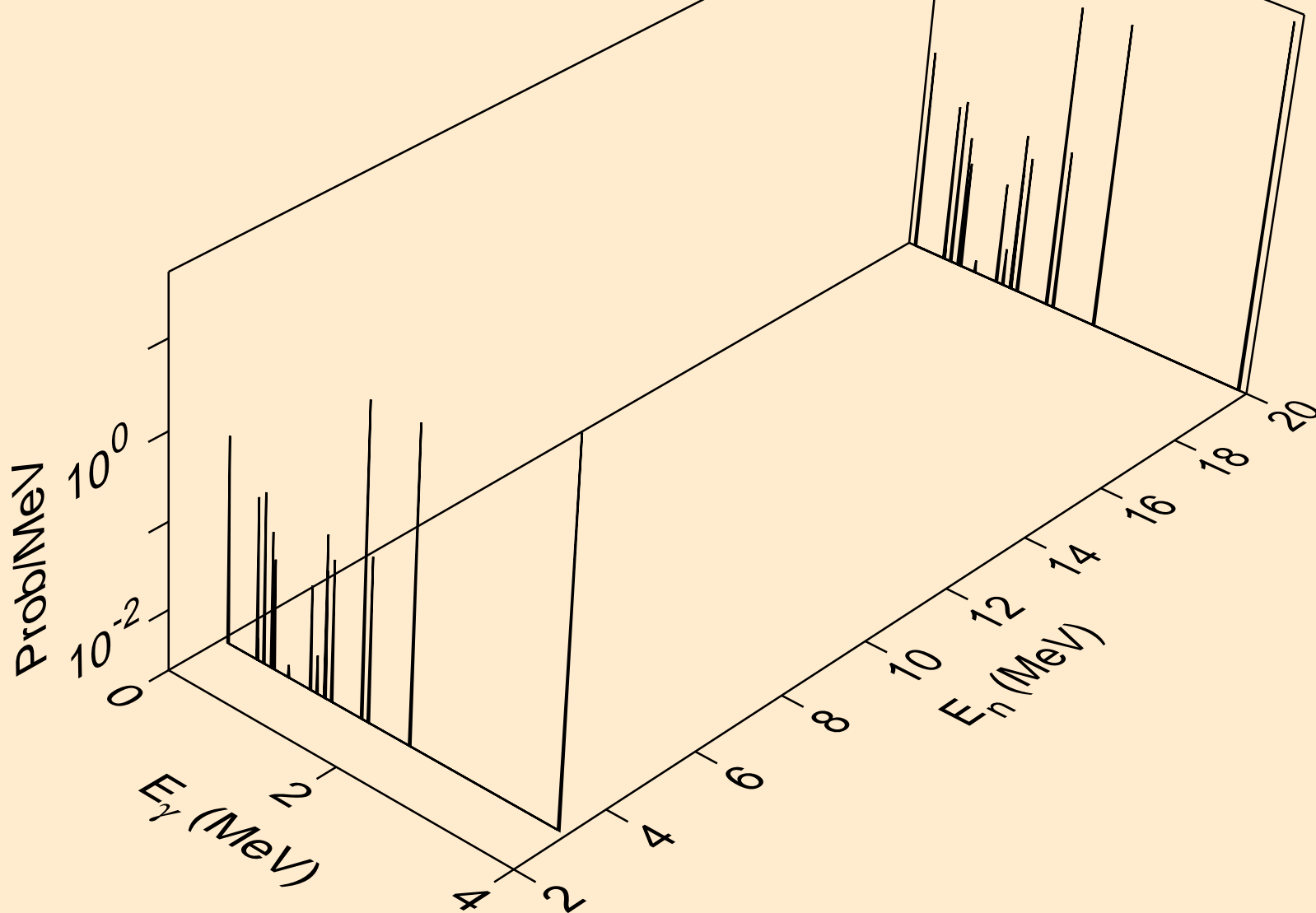

MAT=1725 ACE FILE PRODUCED AT NEA WITH NDEC
Photon emission for (n,a*20)

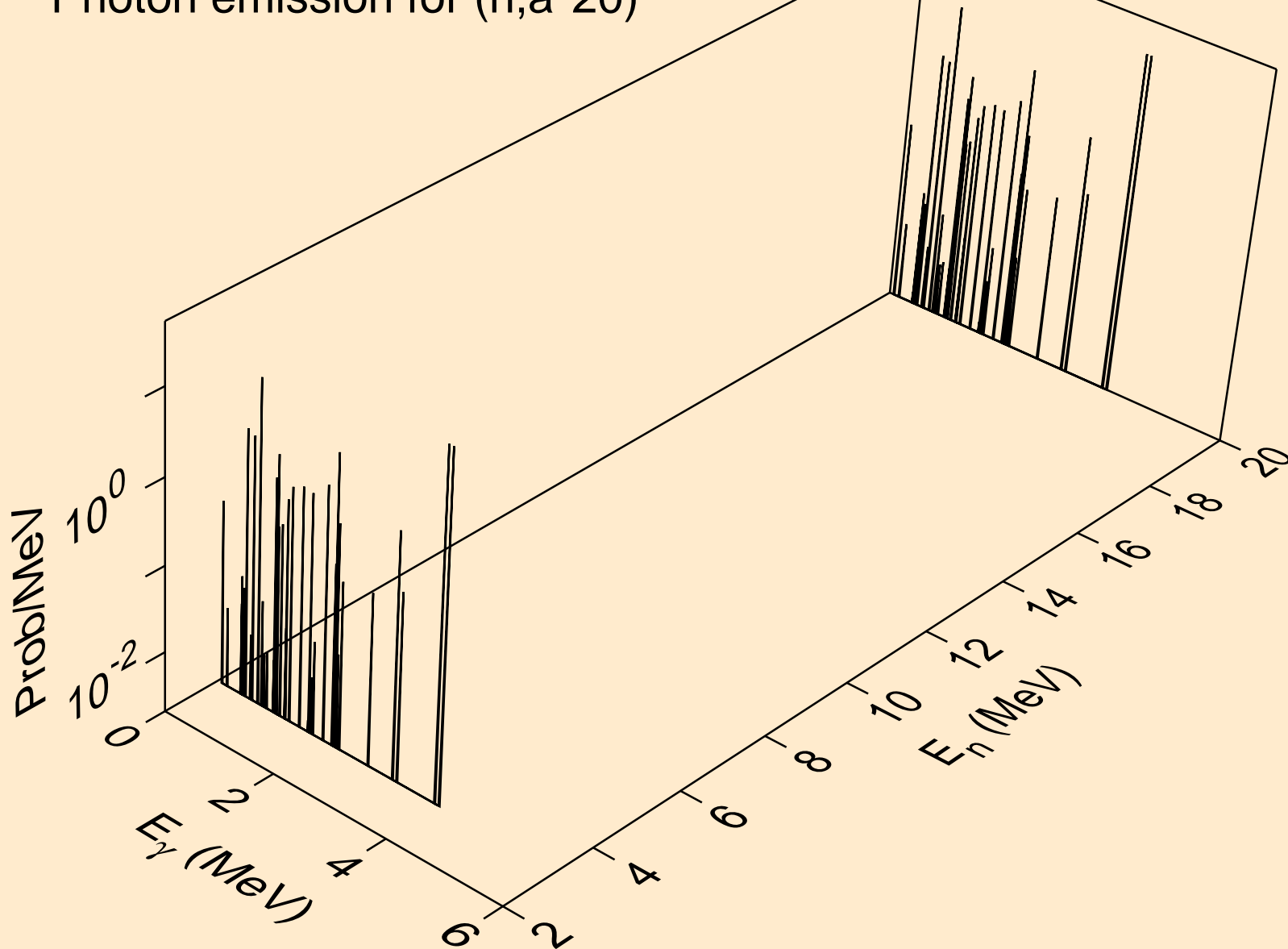

MAT=1725 ACE FILE PRODUCED AT NEA WITH NDEC
Photon emission for (n,a*c)

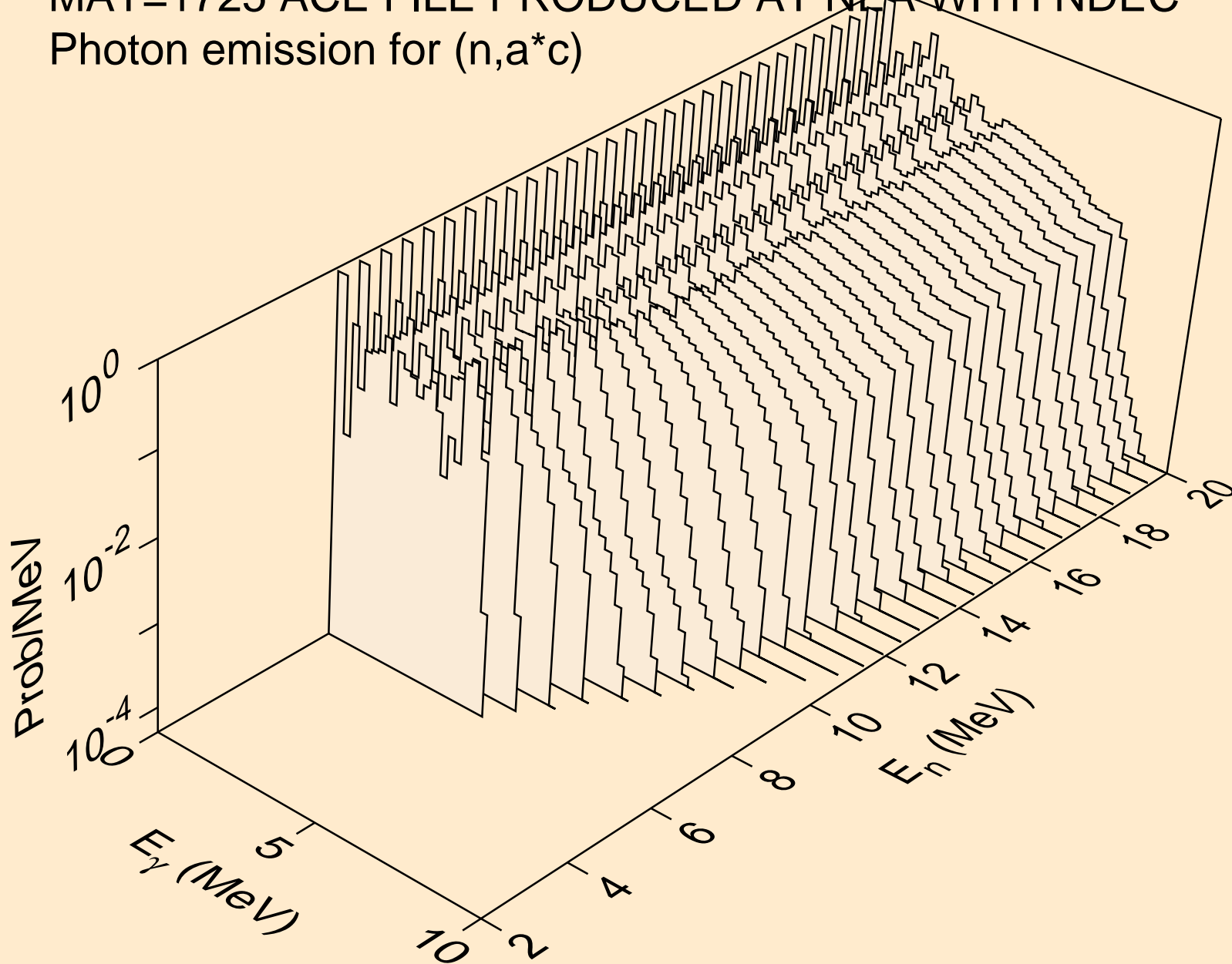

MAT=1725 ACE FILE PRODUCED AT NEA WITH NDEC
thermal capture photon spectrum

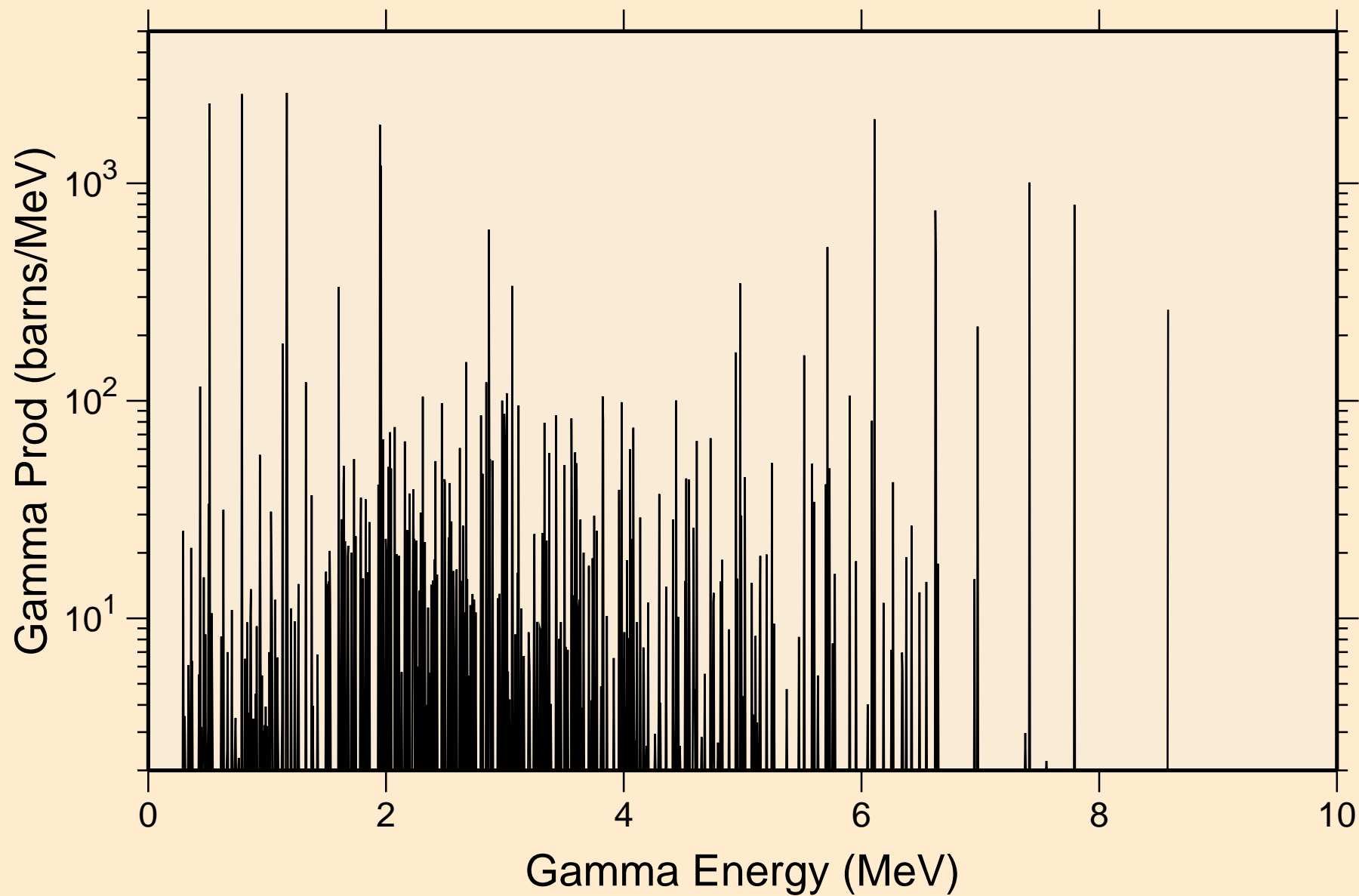

MAT=1725 ACE FILE PRODUCED AT NEA WITH NDEC
14 MeV photon spectrum

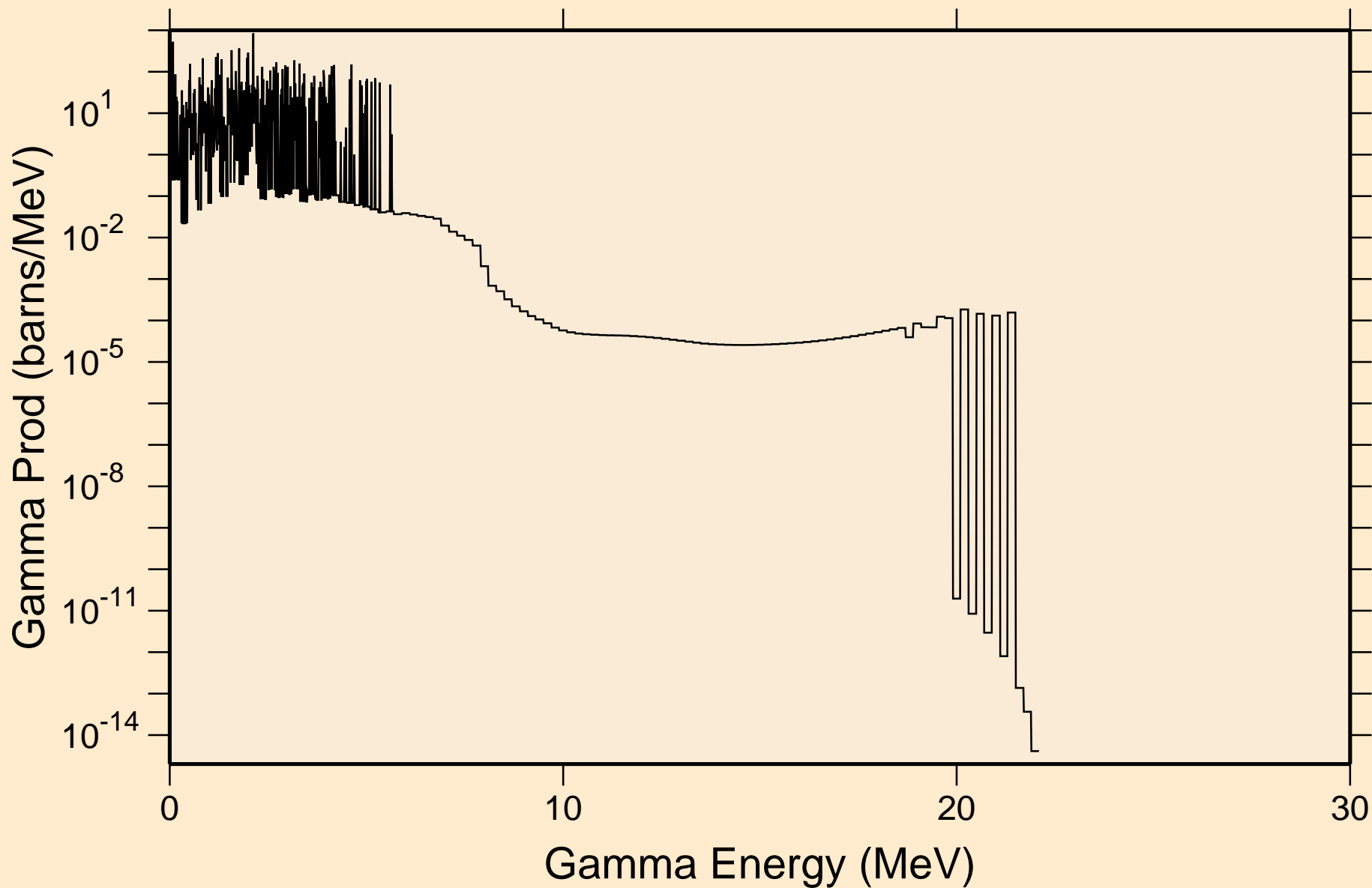

MAT=1725 ACE FILE PRODUCED AT NEA WITH NDEC
Particle heating contributions

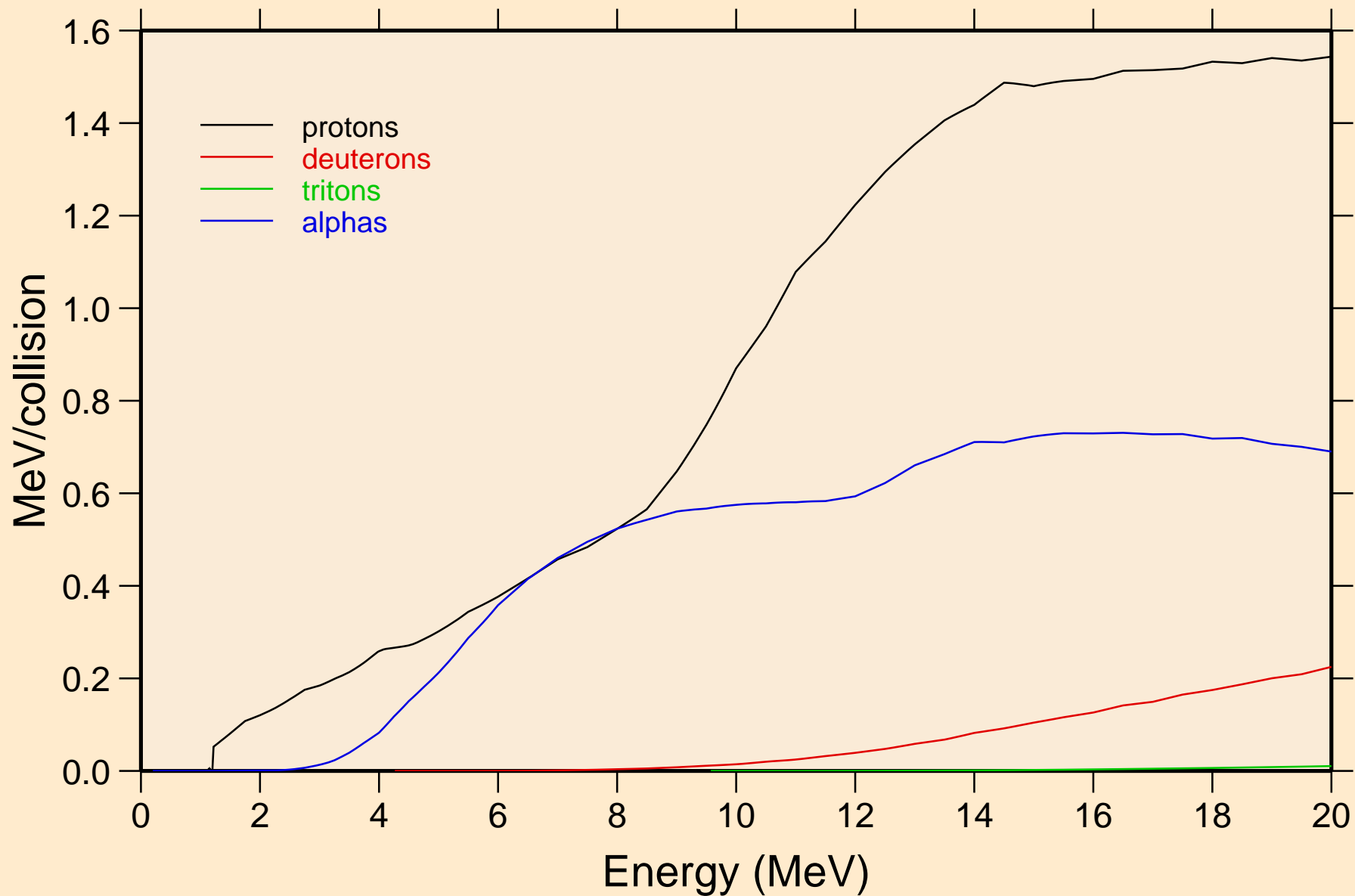

MAT=1725 ACE FILE PRODUCED AT NEA WITH NDEC
Recoil Heating

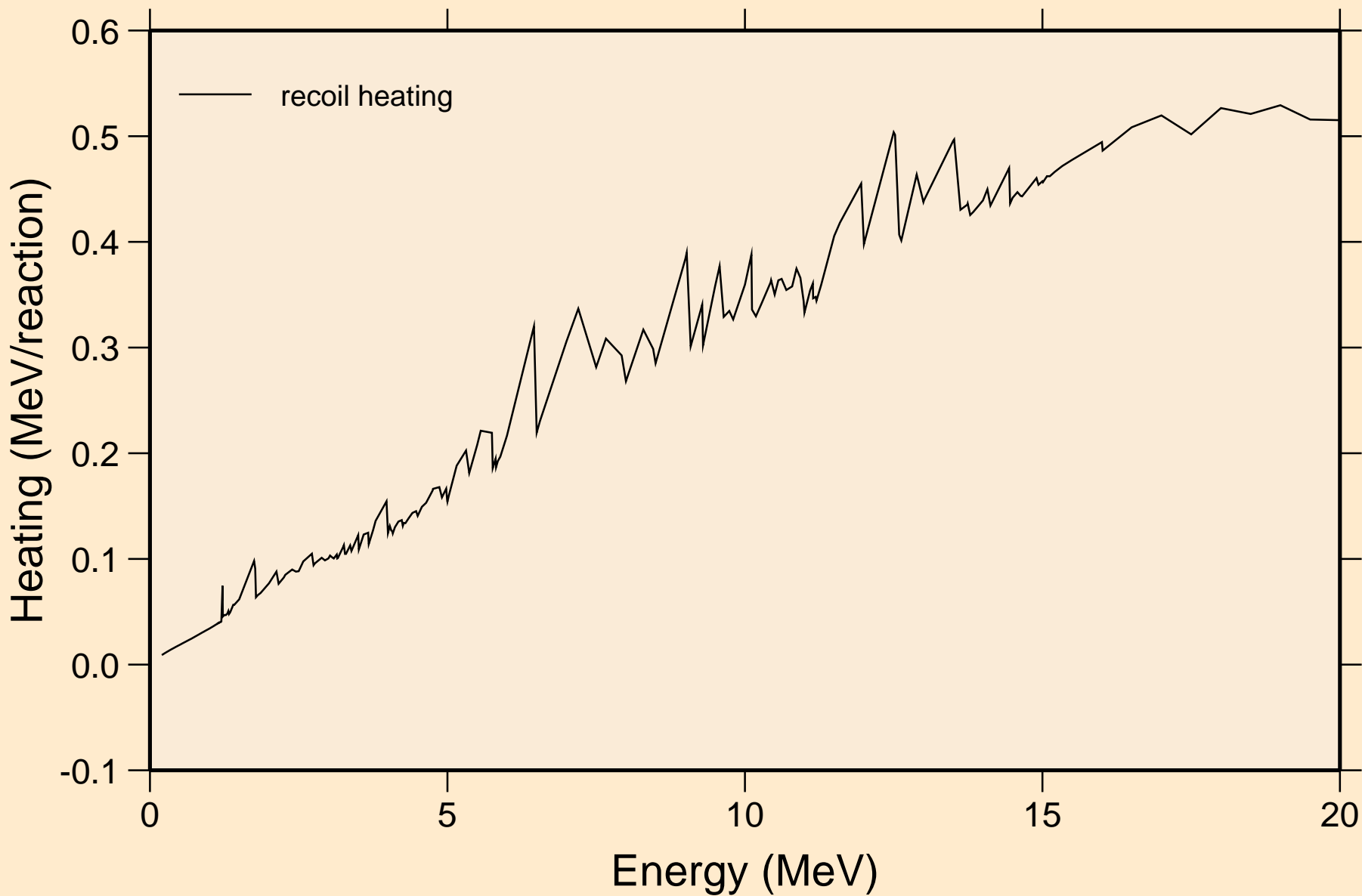

MAT=1725 ACE FILE PRODUCED AT NEA WITH NDEC
Particle production cross sections

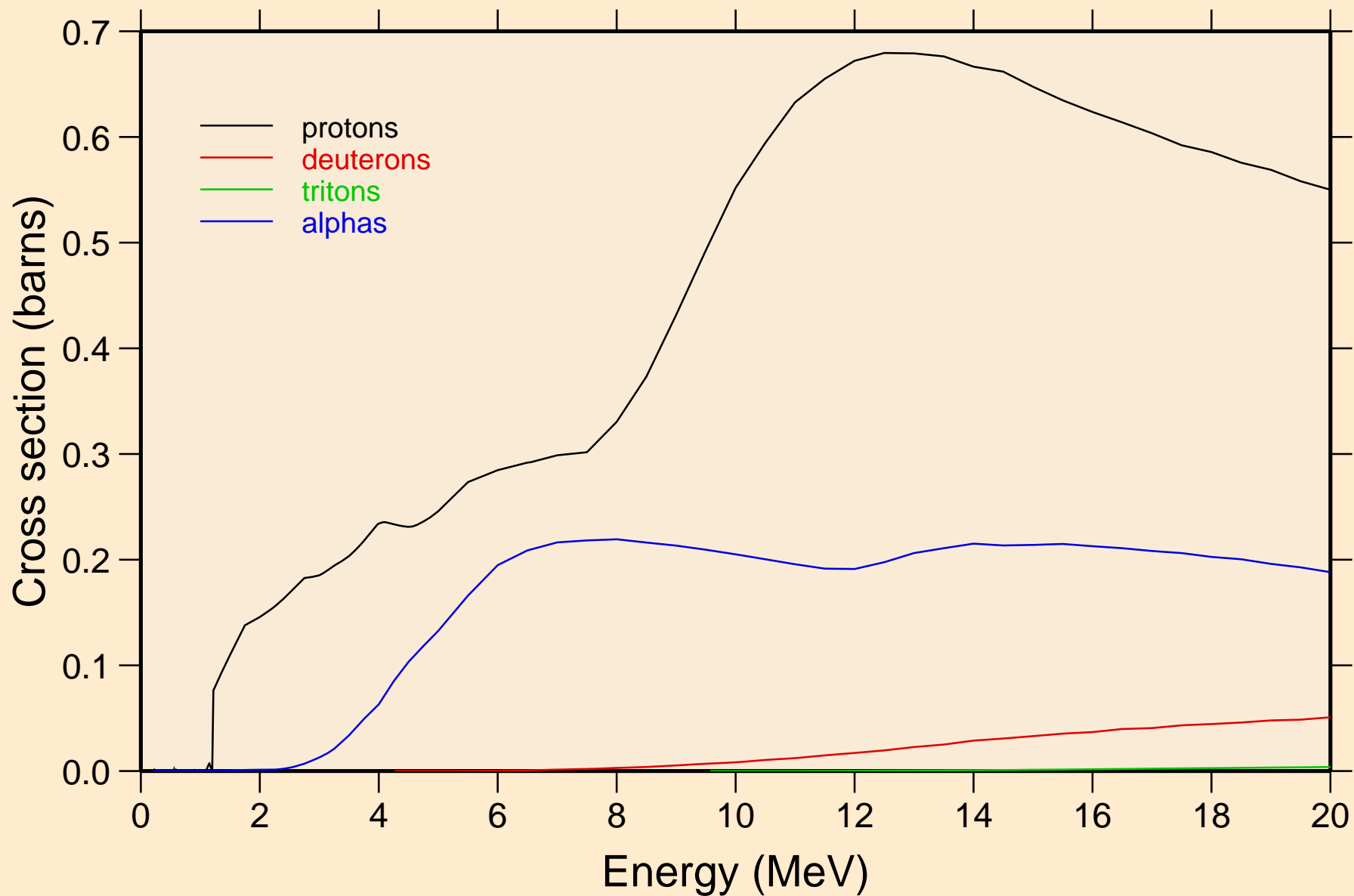

MAT=1725 ACE FILE PRODUCED AT NEA WITH NDEC
protons from (n,n*)p

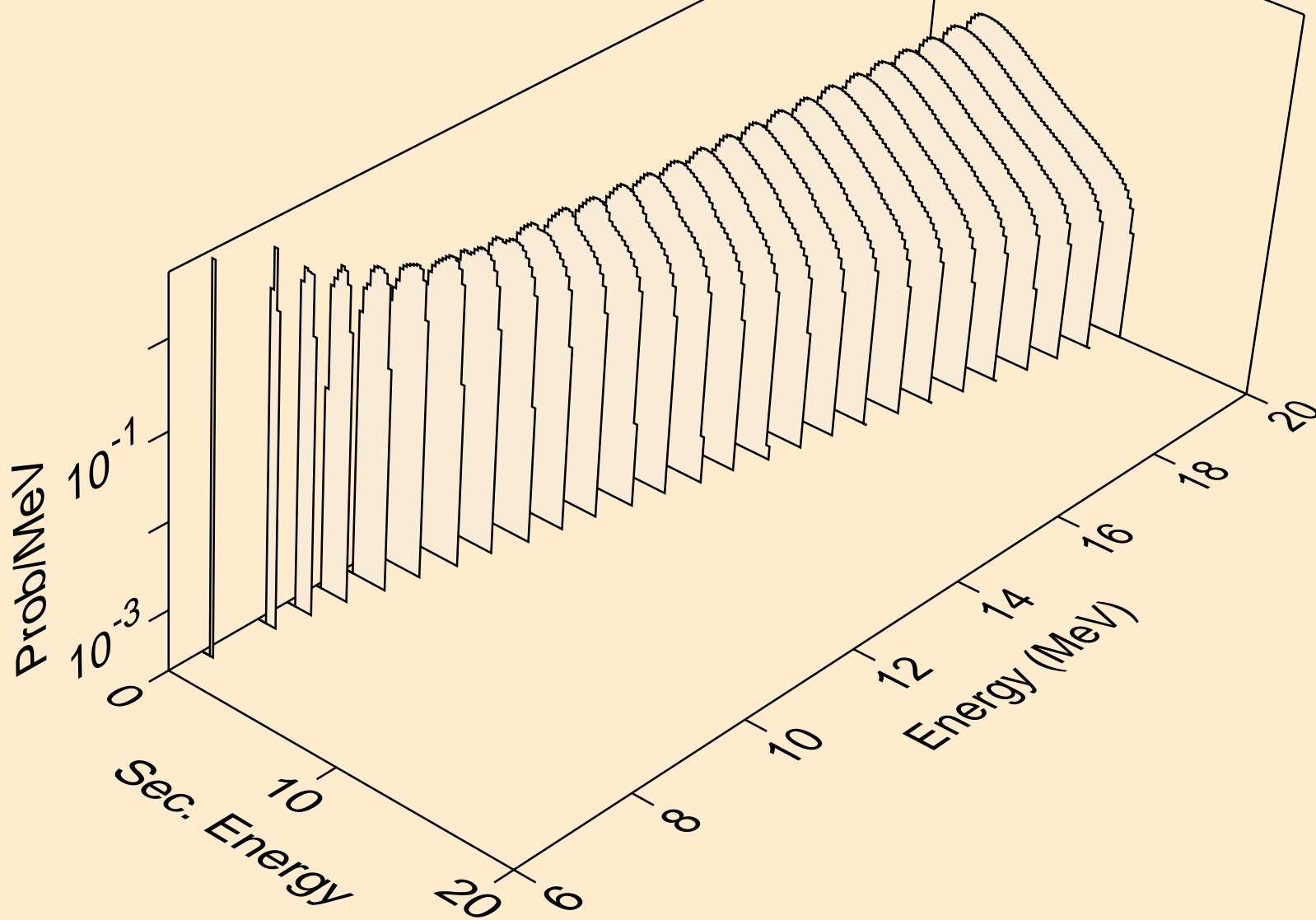

MAT=1725 ACE FILE PRODUCED AT NEA WITH NDEC
protons from (n,2p)

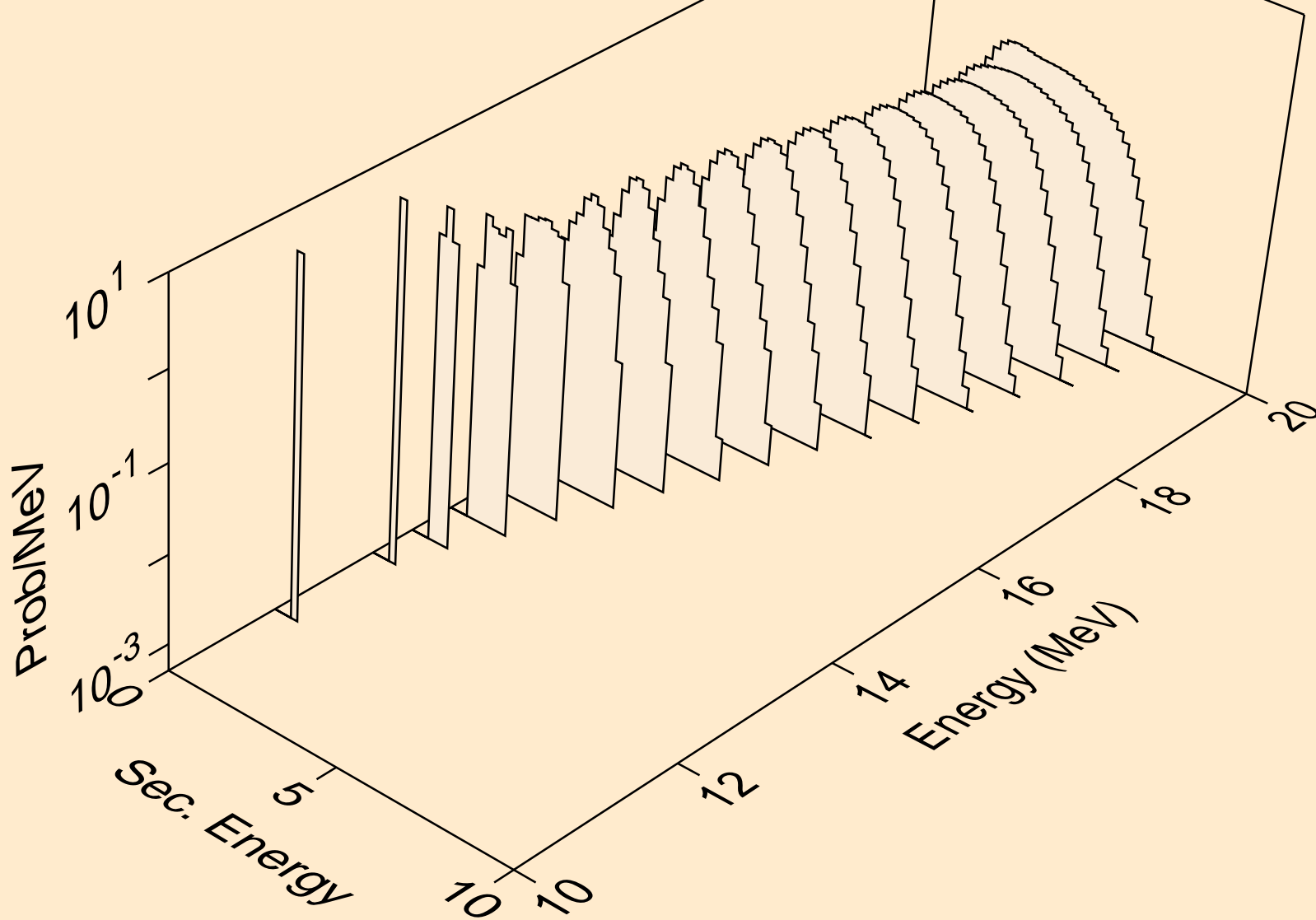

MAT=1725 ACE FILE PRODUCED AT NEA WITH NDEC
protons from (n,pa)

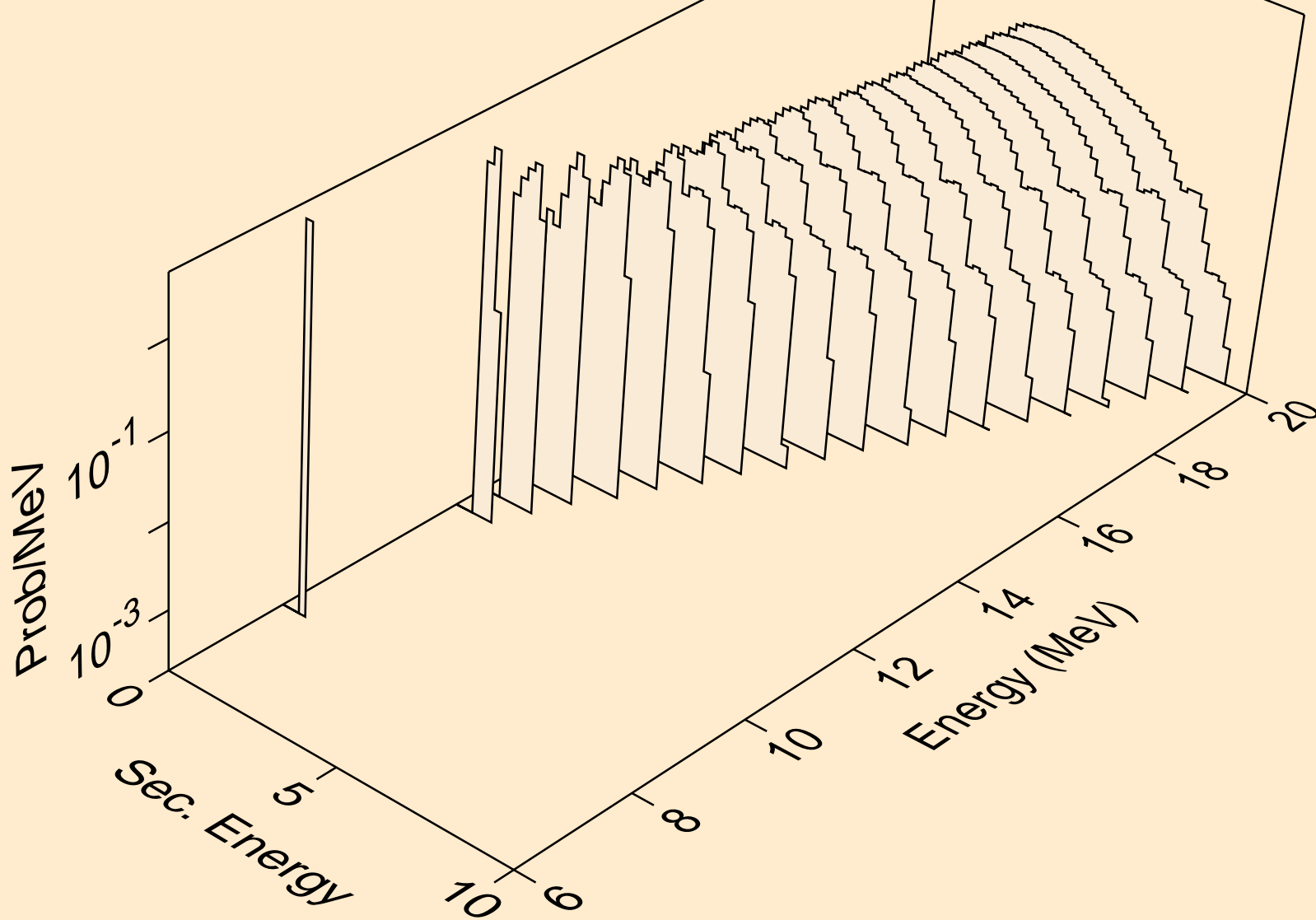

MAT=1725 ACE FILE PRODUCED AT NEA WITH NDEC
angular distribution for (n,p*0) proton

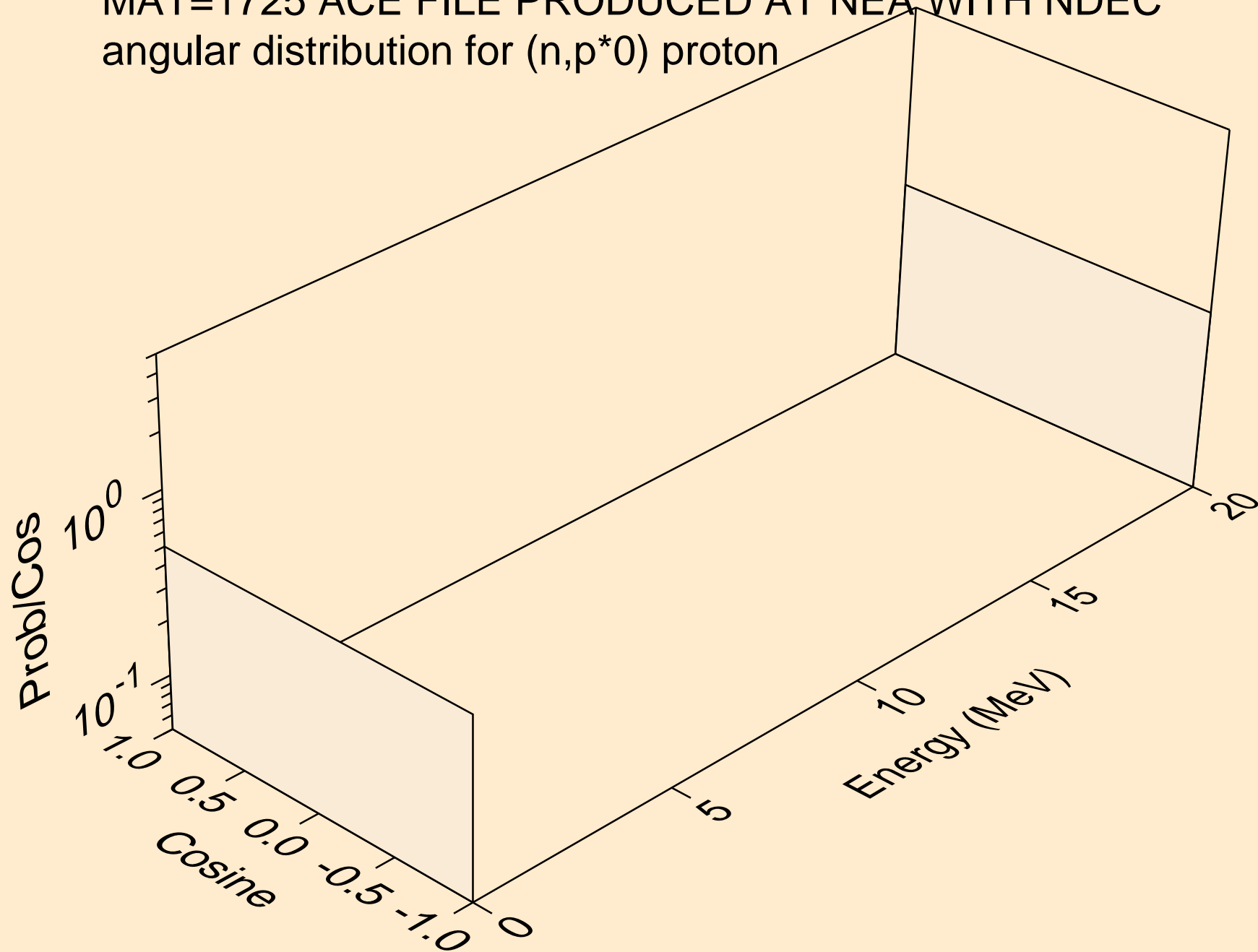

MAT=1725 ACE FILE PRODUCED AT NEA WITH NDEC
angular distribution for (n,p*1) proton

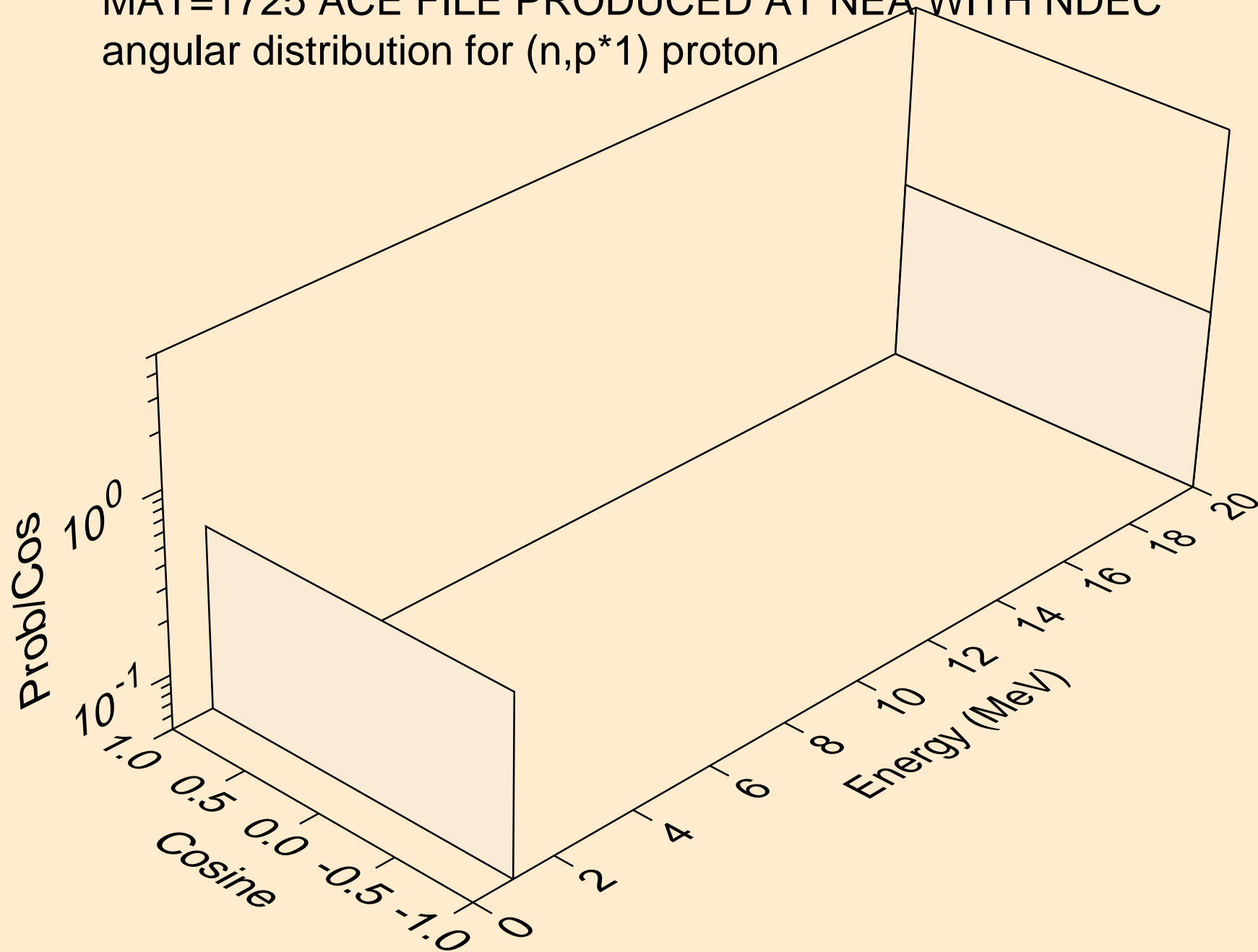

MAT=1725 ACE FILE PRODUCED AT NEA WITH NDEC
angular distribution for (n,p*2) proton

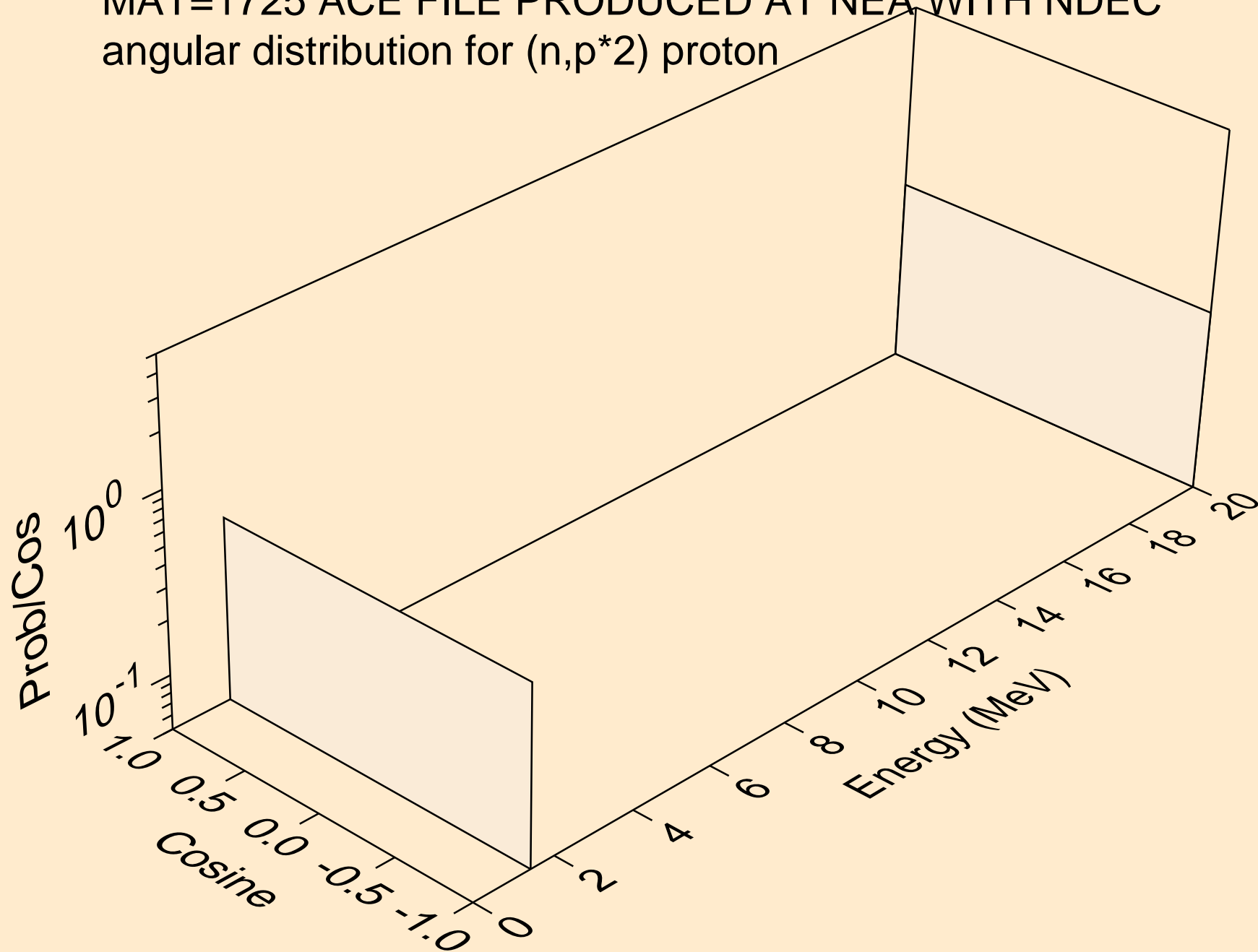

MAT=1725 ACE FILE PRODUCED AT NEA WITH NDEC
angular distribution for (n,p*3) proton

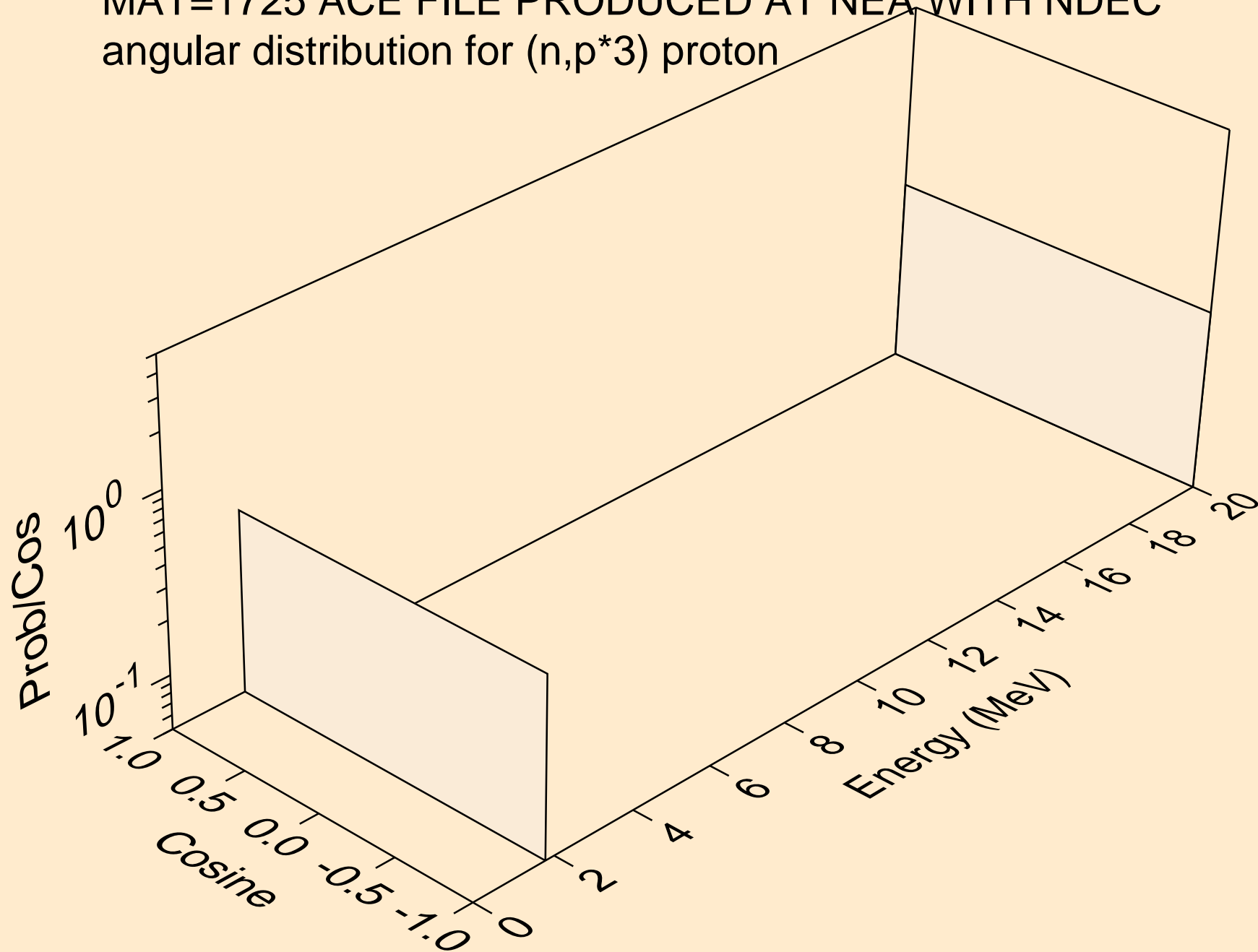

MAT=1725 ACE FILE PRODUCED AT NEA WITH NDEC
angular distribution for (n,p*4) proton

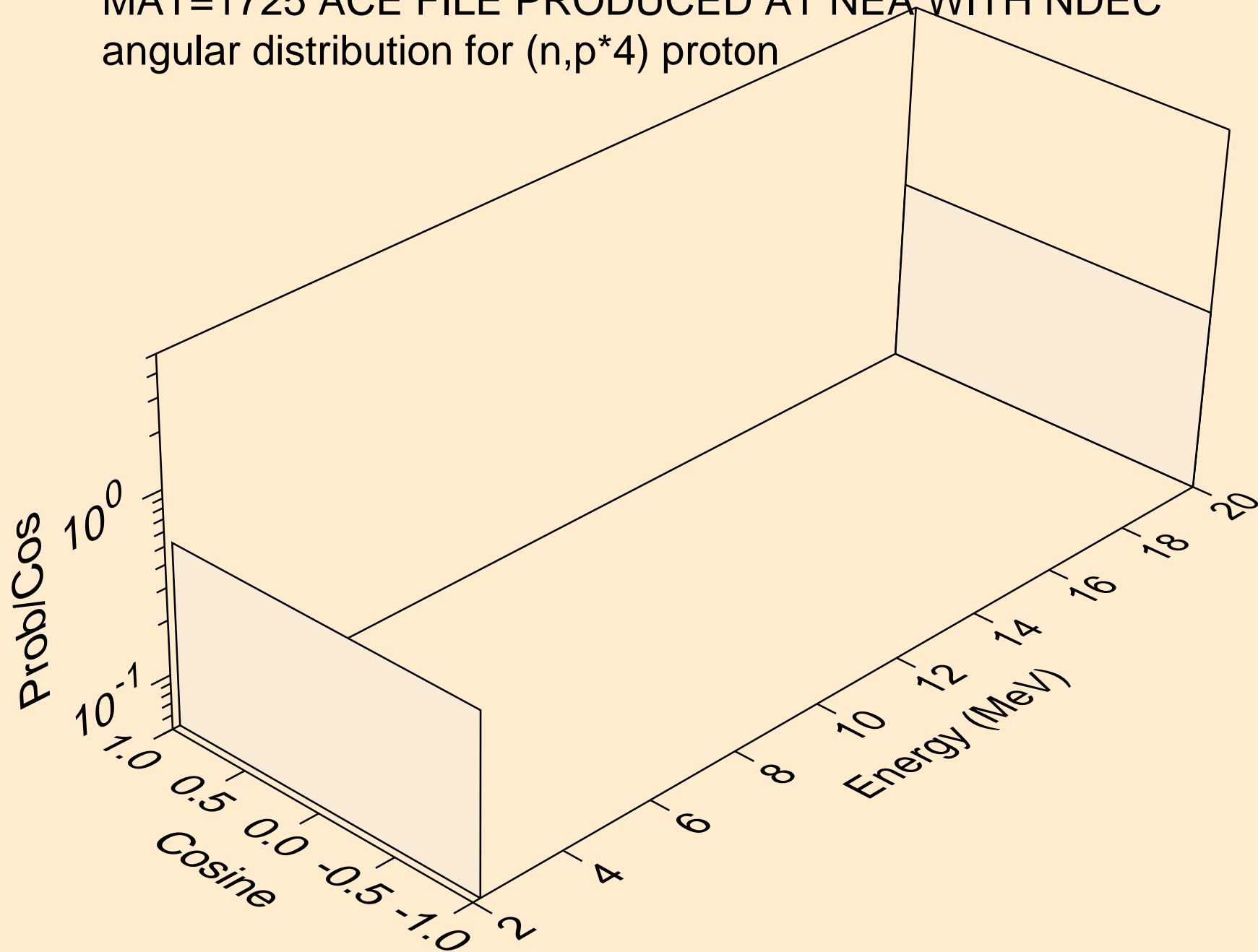

MAT=1725 ACE FILE PRODUCED AT NEA WITH NDEC
angular distribution for (n,p*5) proton

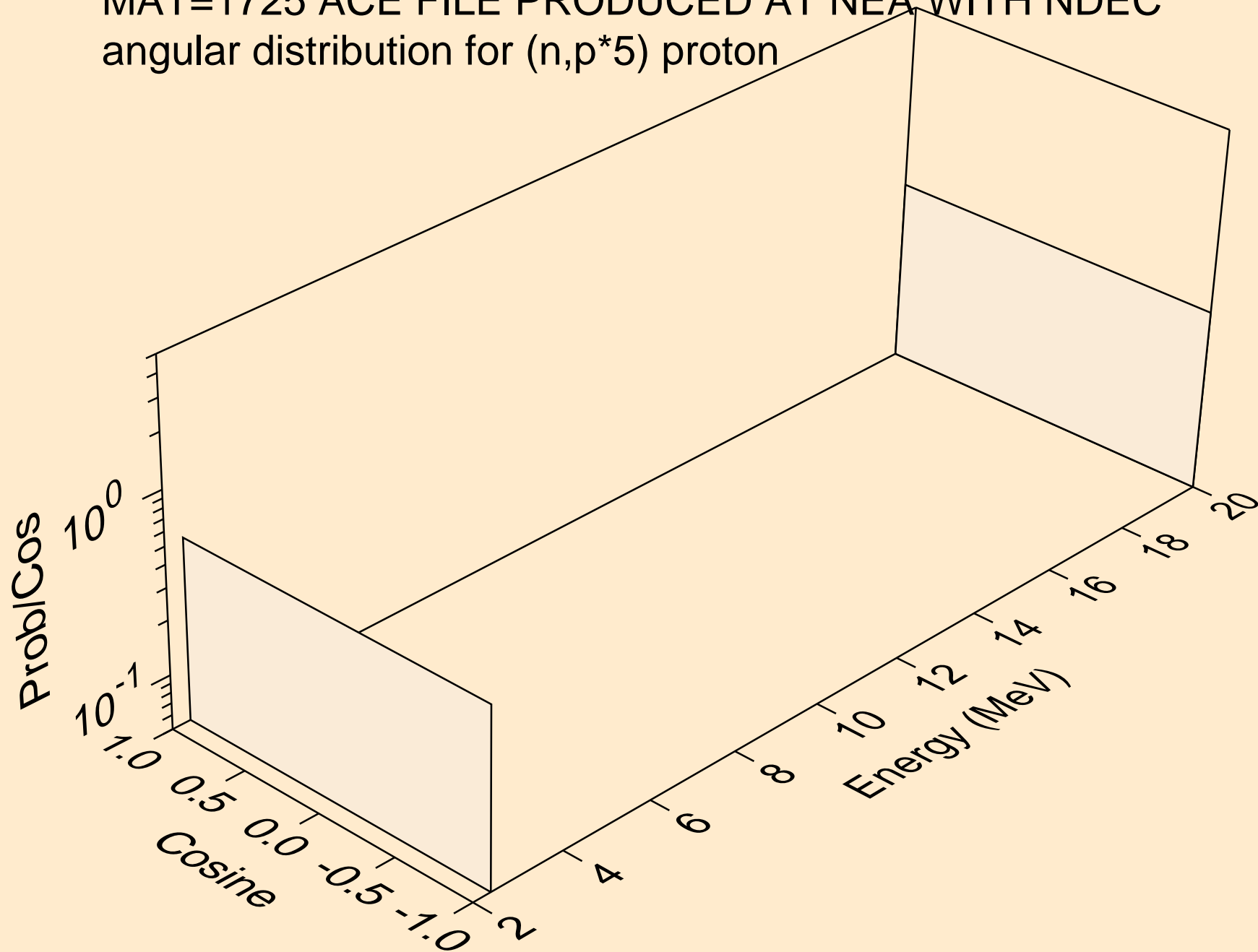

MAT=1725 ACE FILE PRODUCED AT NEA WITH NDEC
angular distribution for (n,p*6) proton

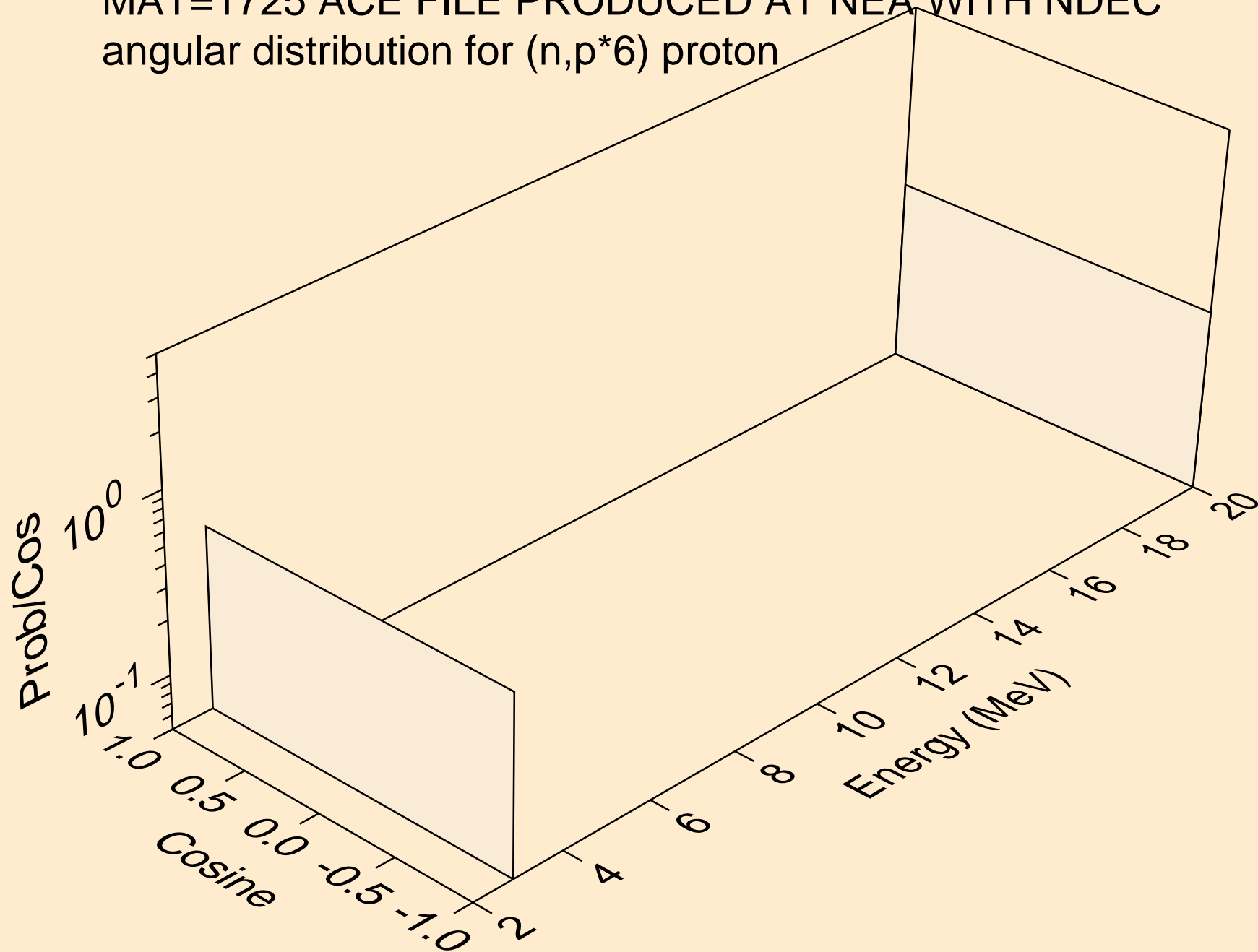

MAT=1725 ACE FILE PRODUCED AT NEA WITH NDEC
angular distribution for (n,p*7) proton

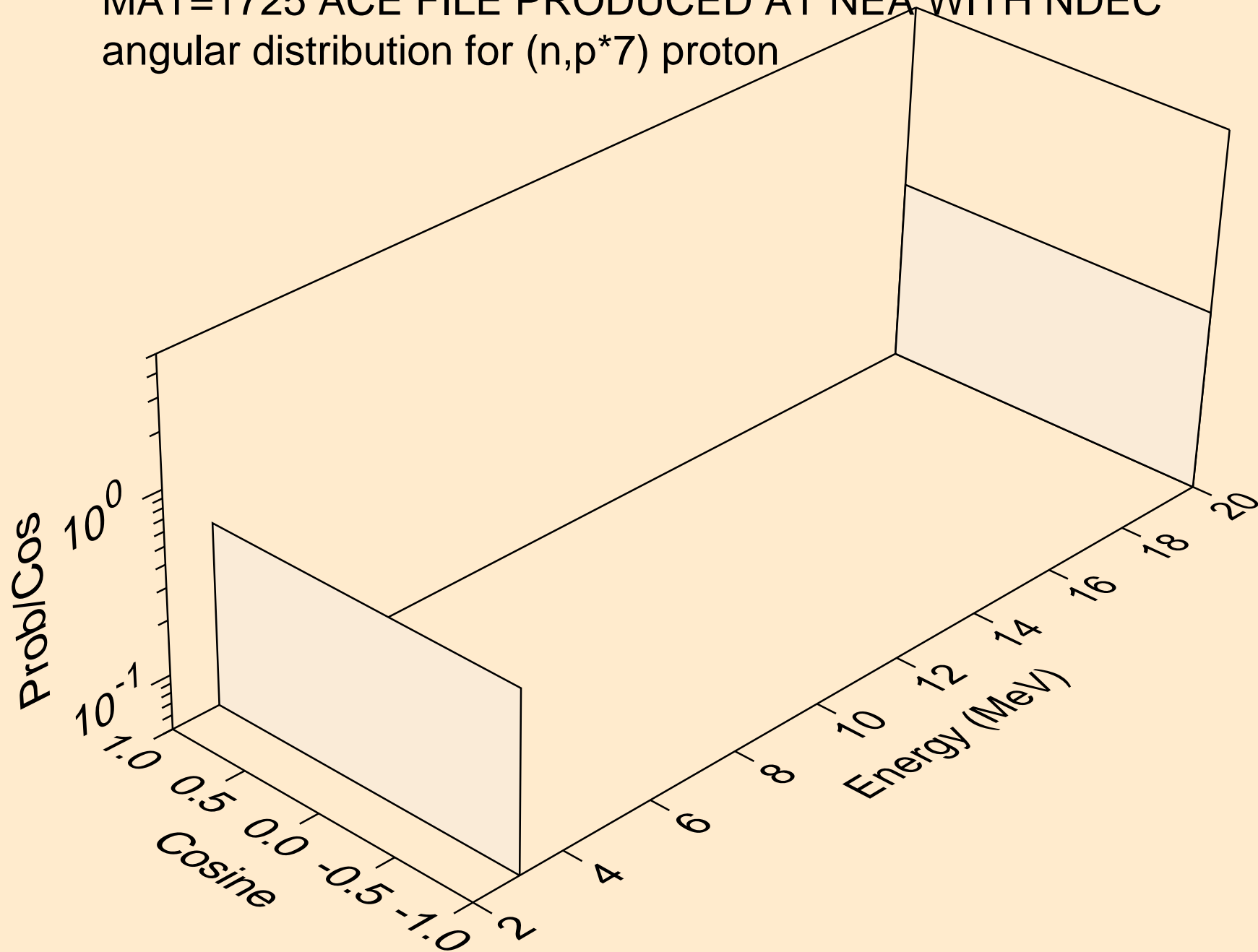

MAT=1725 ACE FILE PRODUCED AT NEA WITH NDEC
angular distribution for (n,p*8) proton

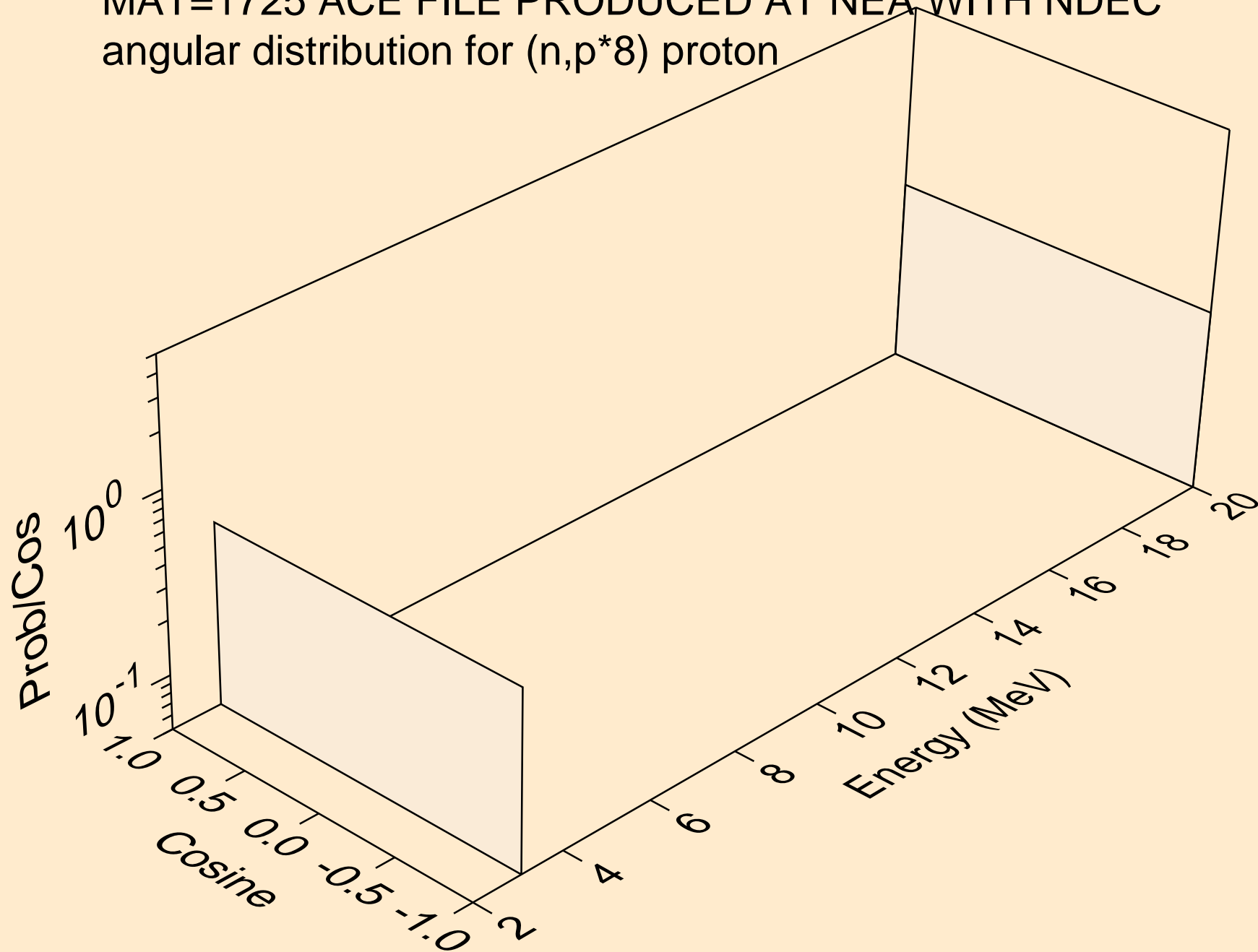

MAT=1725 ACE FILE PRODUCED AT NEA WITH NDEC
angular distribution for (n,p*9) proton

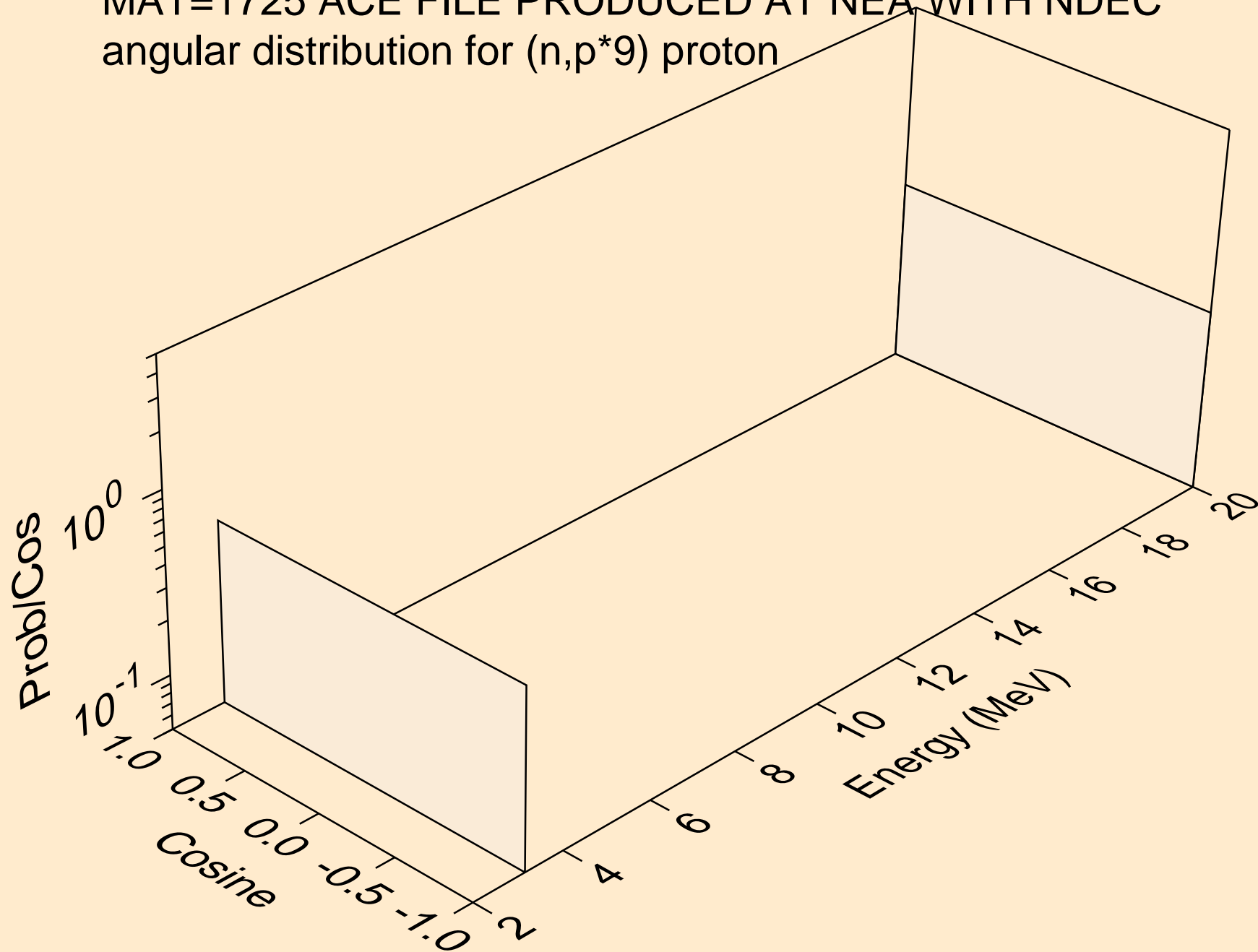

MAT=1725 ACE FILE PRODUCED AT NEA WITH NDEC
angular distribution for (n,p*10) proton

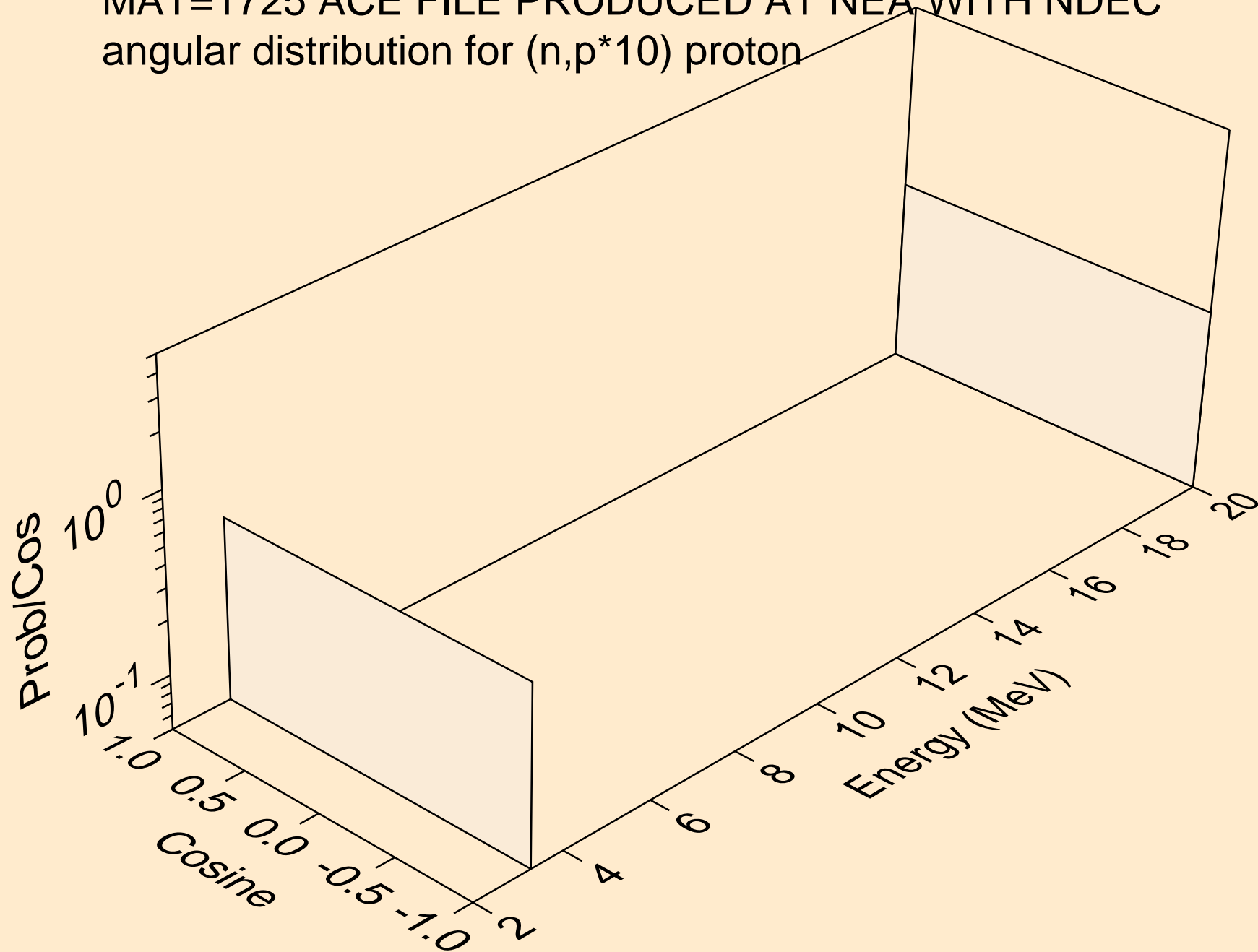

MAT=1725 ACE FILE PRODUCED AT NEA WITH NDEC
angular distribution for (n,p*11) proton

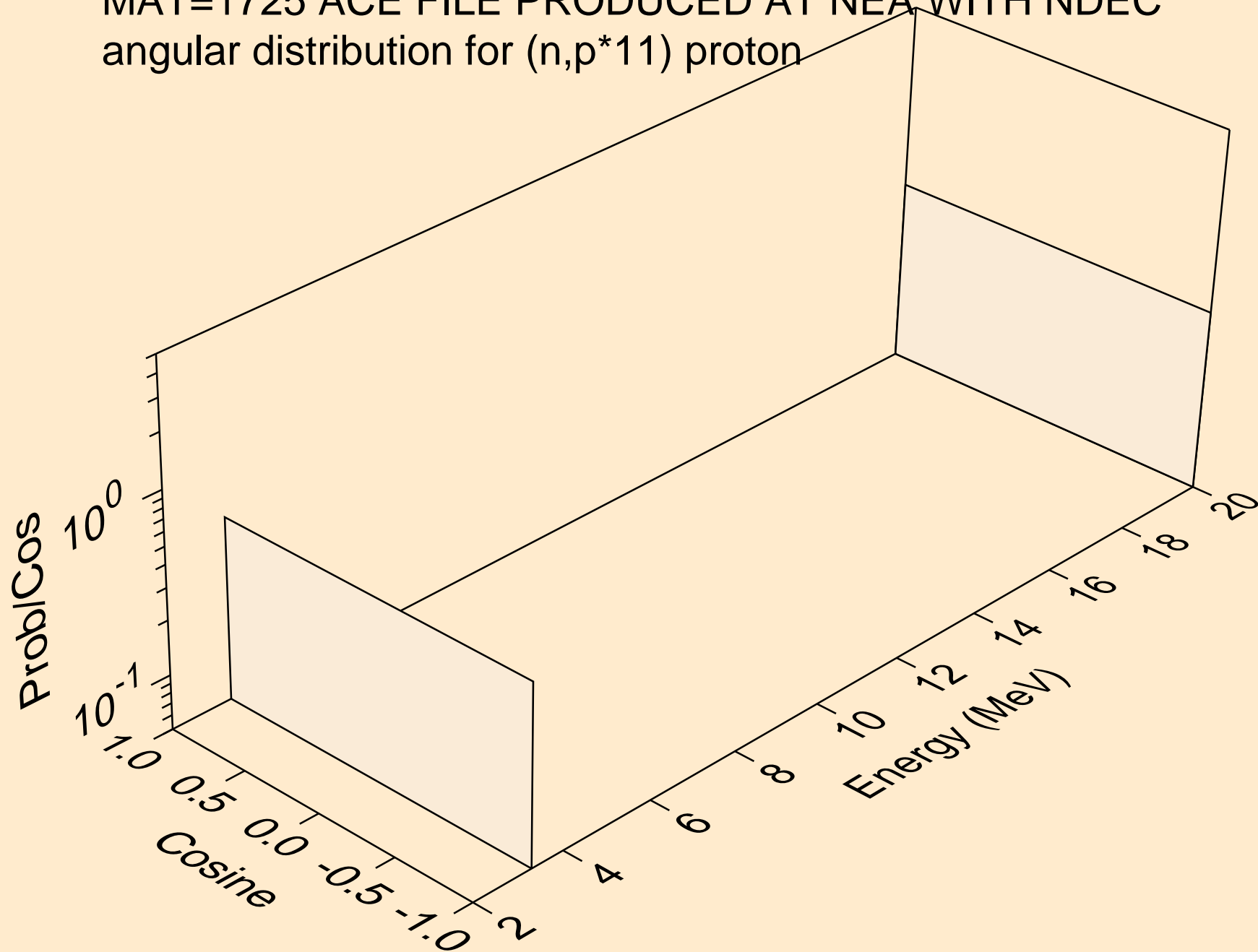

MAT=1725 ACE FILE PRODUCED AT NEA WITH NDEC
angular distribution for (n,p*12) proton

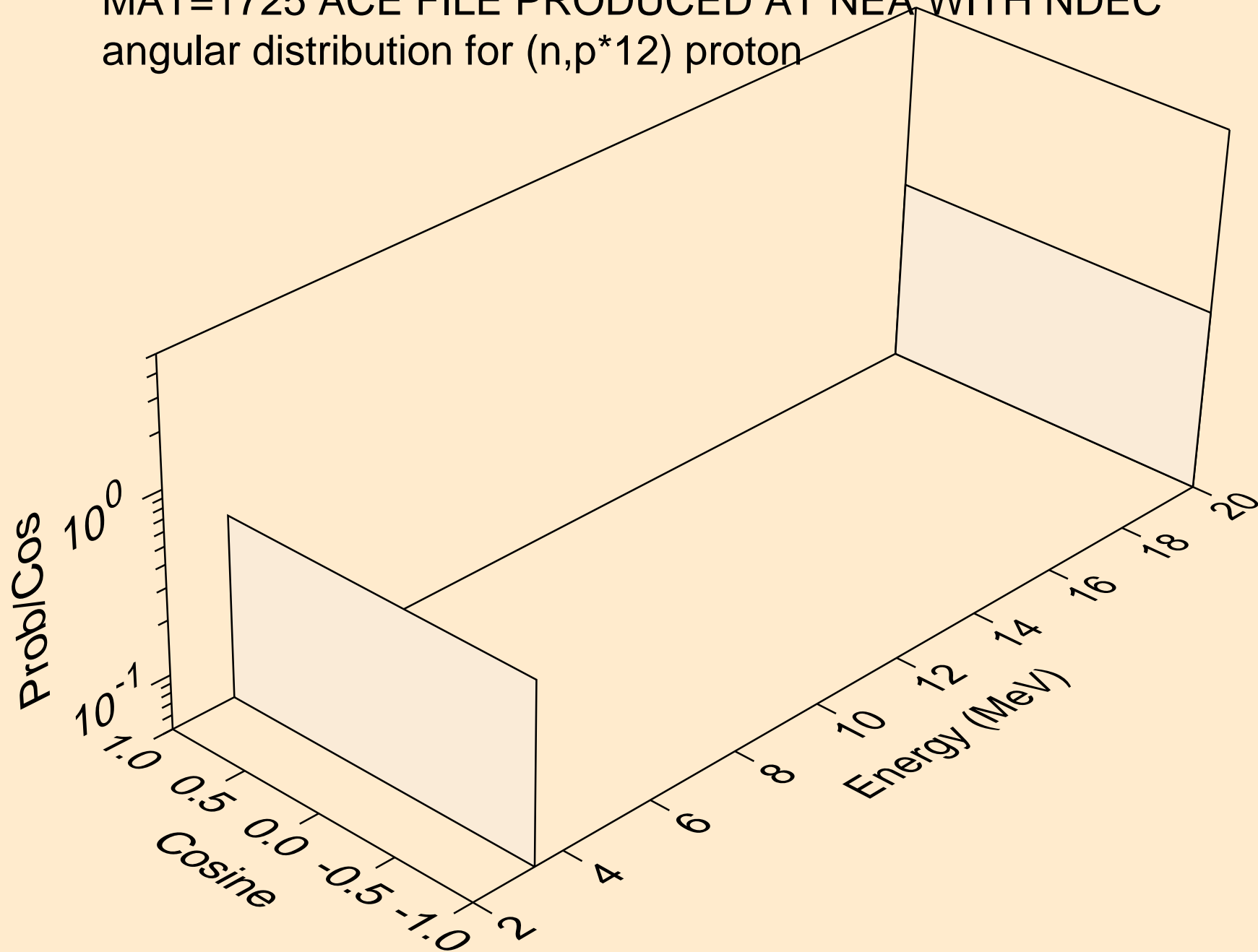

MAT=1725 ACE FILE PRODUCED AT NEA WITH NDEC
angular distribution for (n,p*13) proton

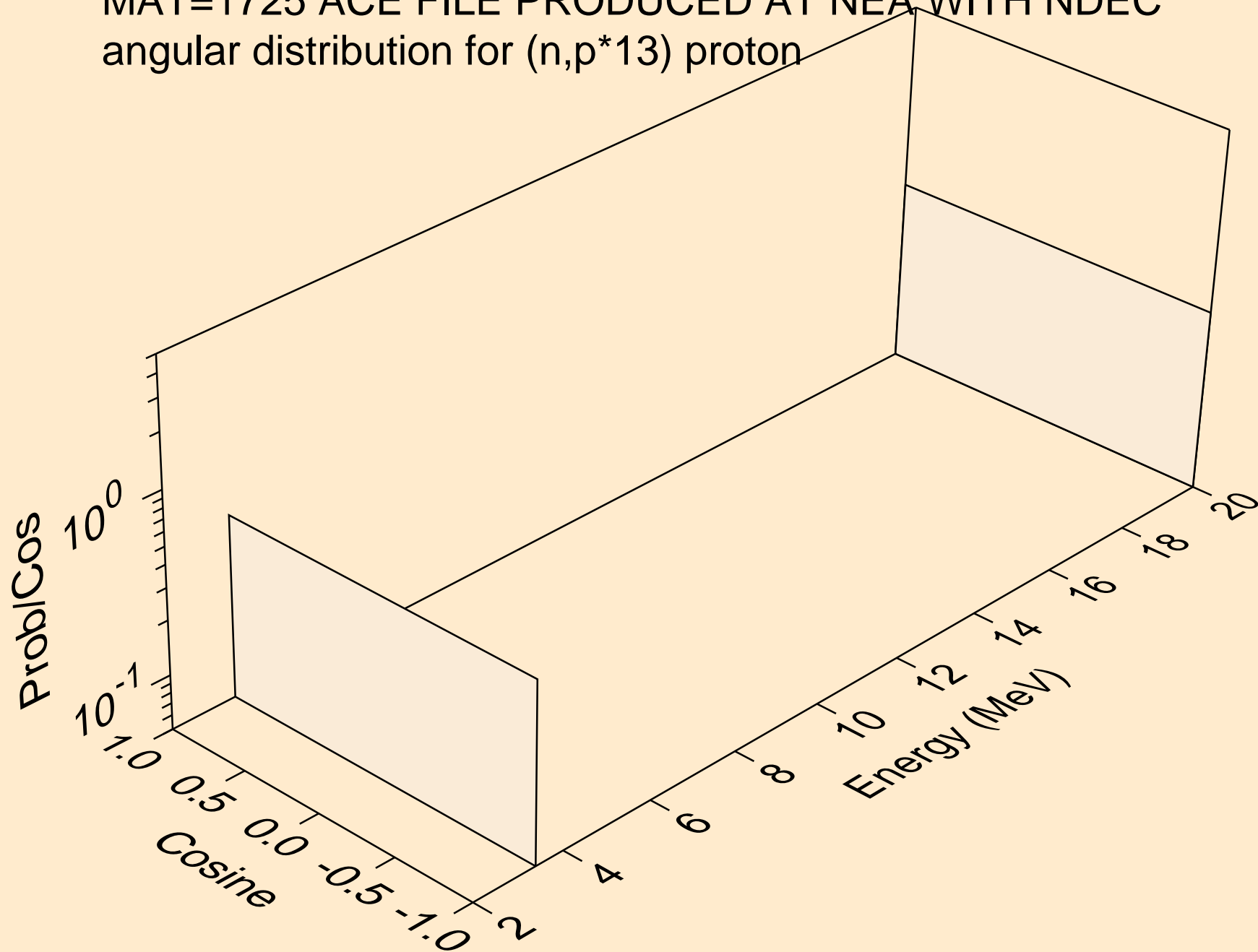

MAT=1725 ACE FILE PRODUCED AT NEA WITH NDEC
angular distribution for (n,p*14) proton

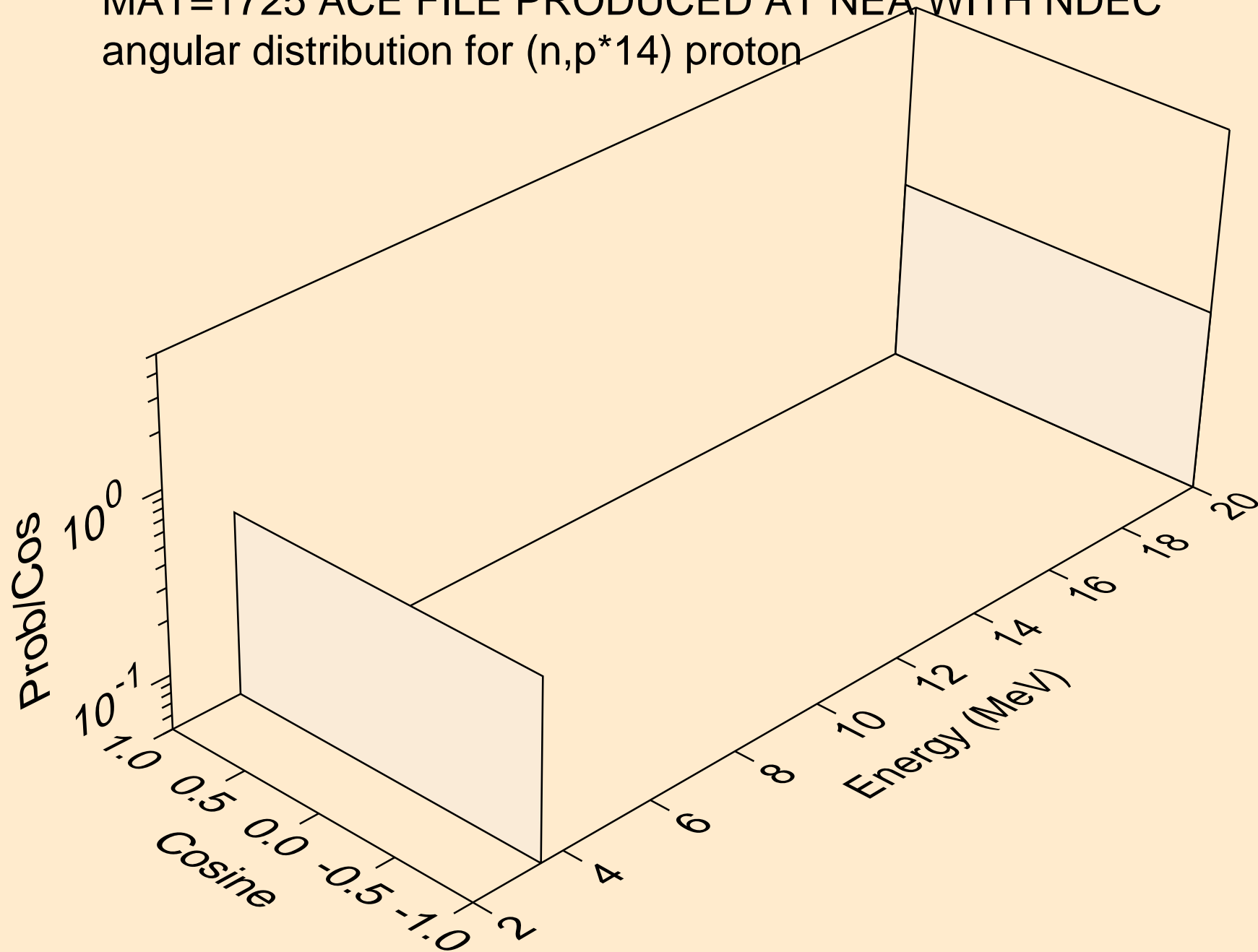

MAT=1725 ACE FILE PRODUCED AT NEA WITH NDEC
angular distribution for (n,p*15) proton

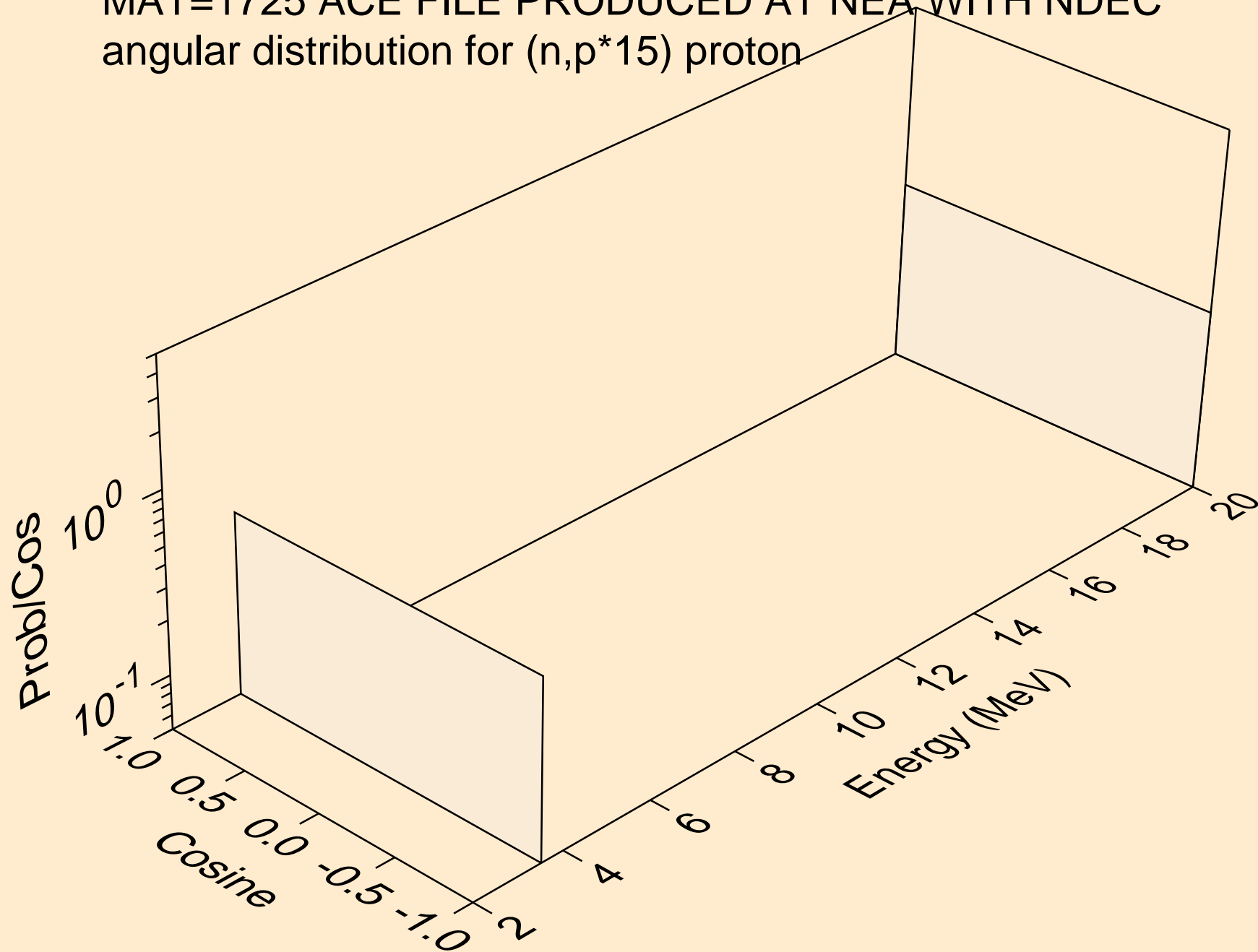

MAT=1725 ACE FILE PRODUCED AT NEA WITH NDEC
angular distribution for (n,p*16) proton

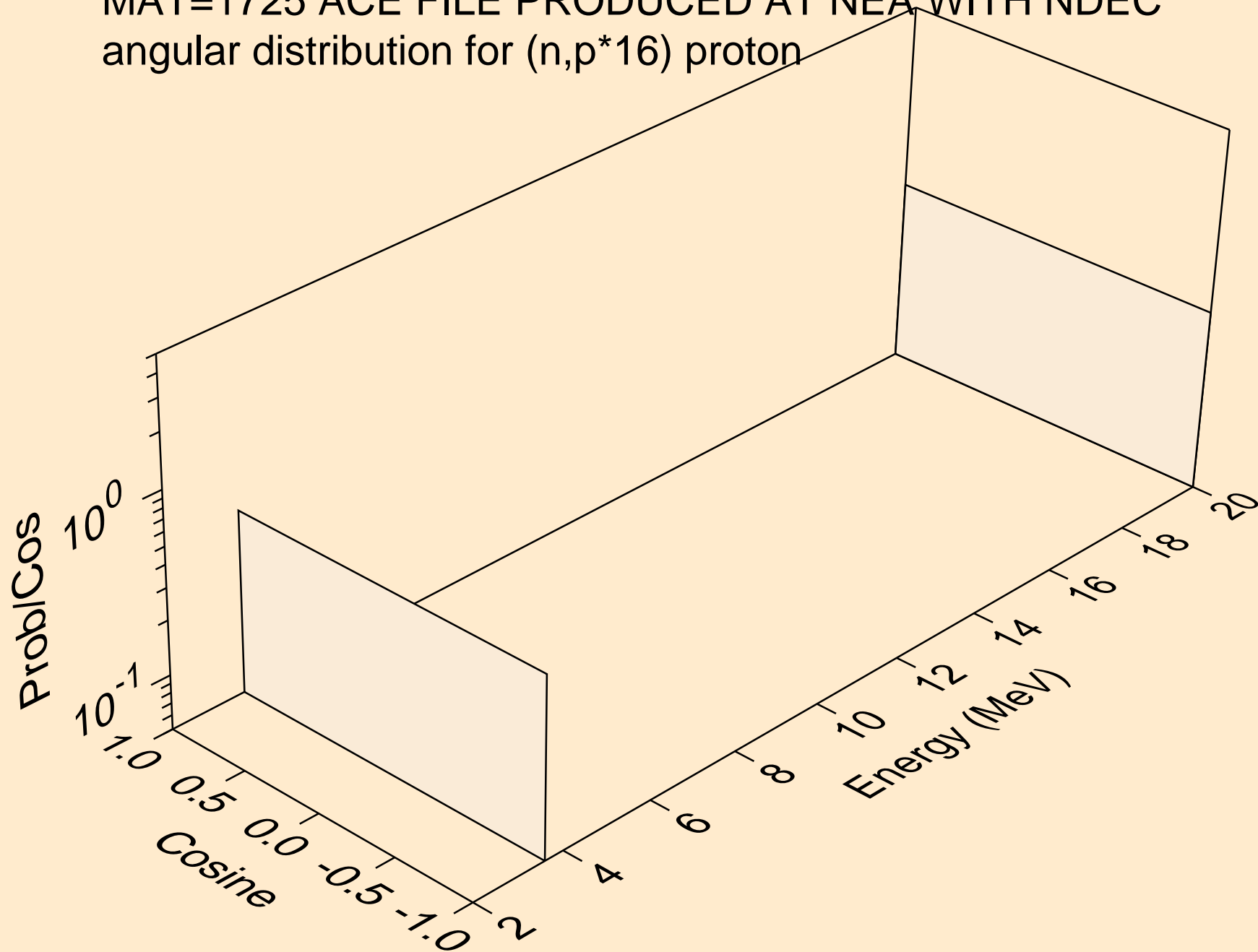

MAT=1725 ACE FILE PRODUCED AT NEA WITH NDEC
angular distribution for (n,p*17) proton

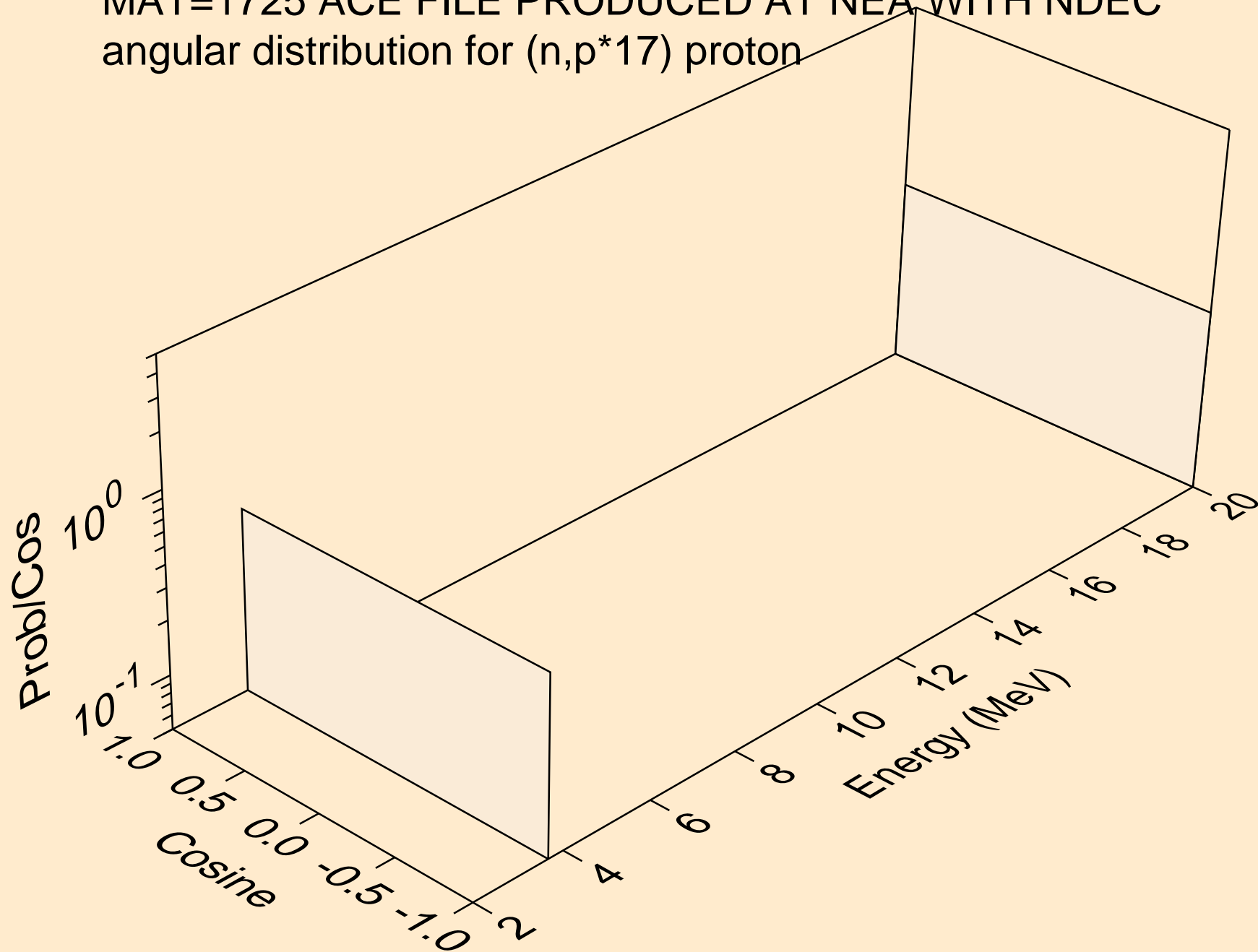

MAT=1725 ACE FILE PRODUCED AT NEA WITH NDEC
angular distribution for (n,p*18) proton

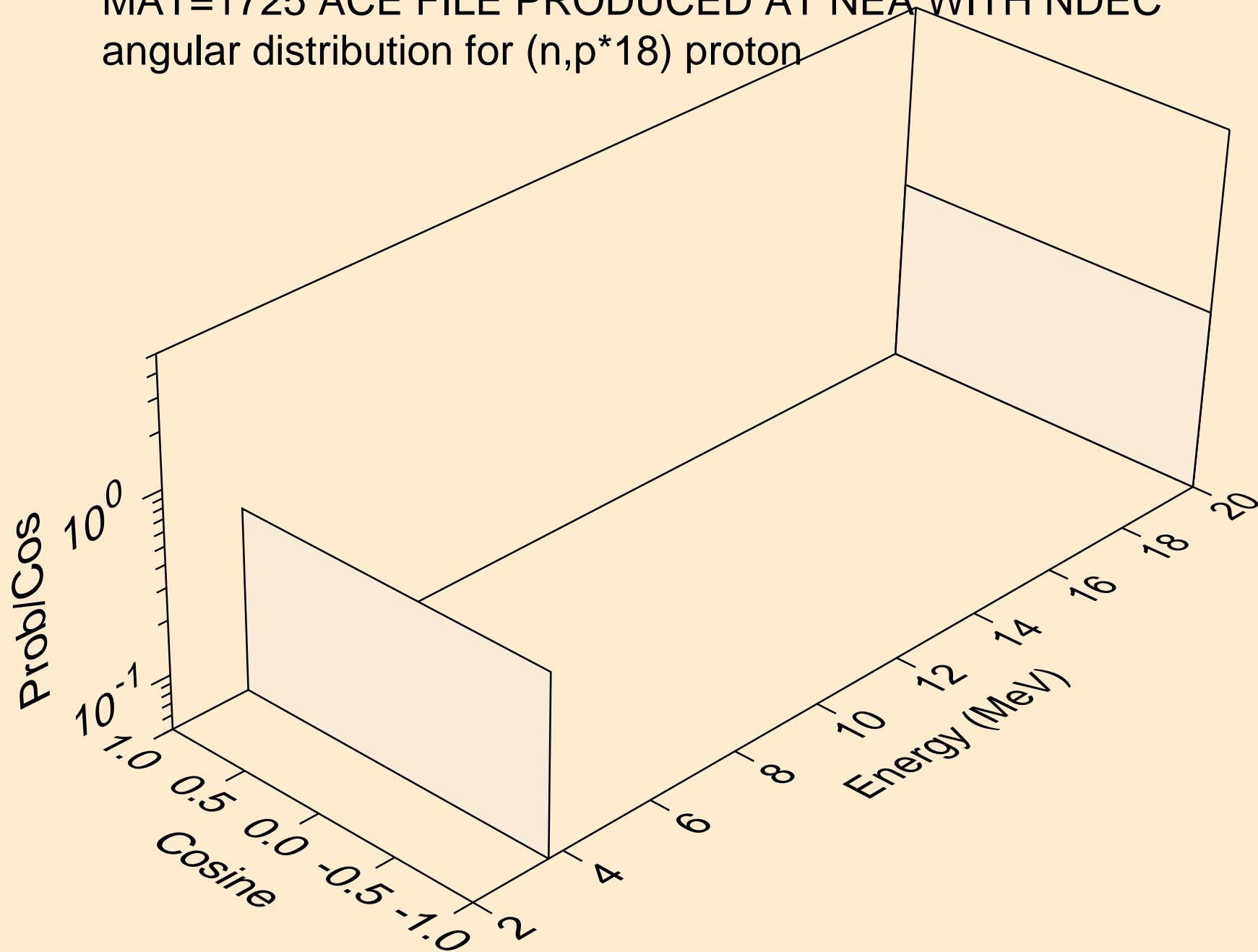

MAT=1725 ACE FILE PRODUCED AT NEA WITH NDEC
angular distribution for (n,p*19) proton

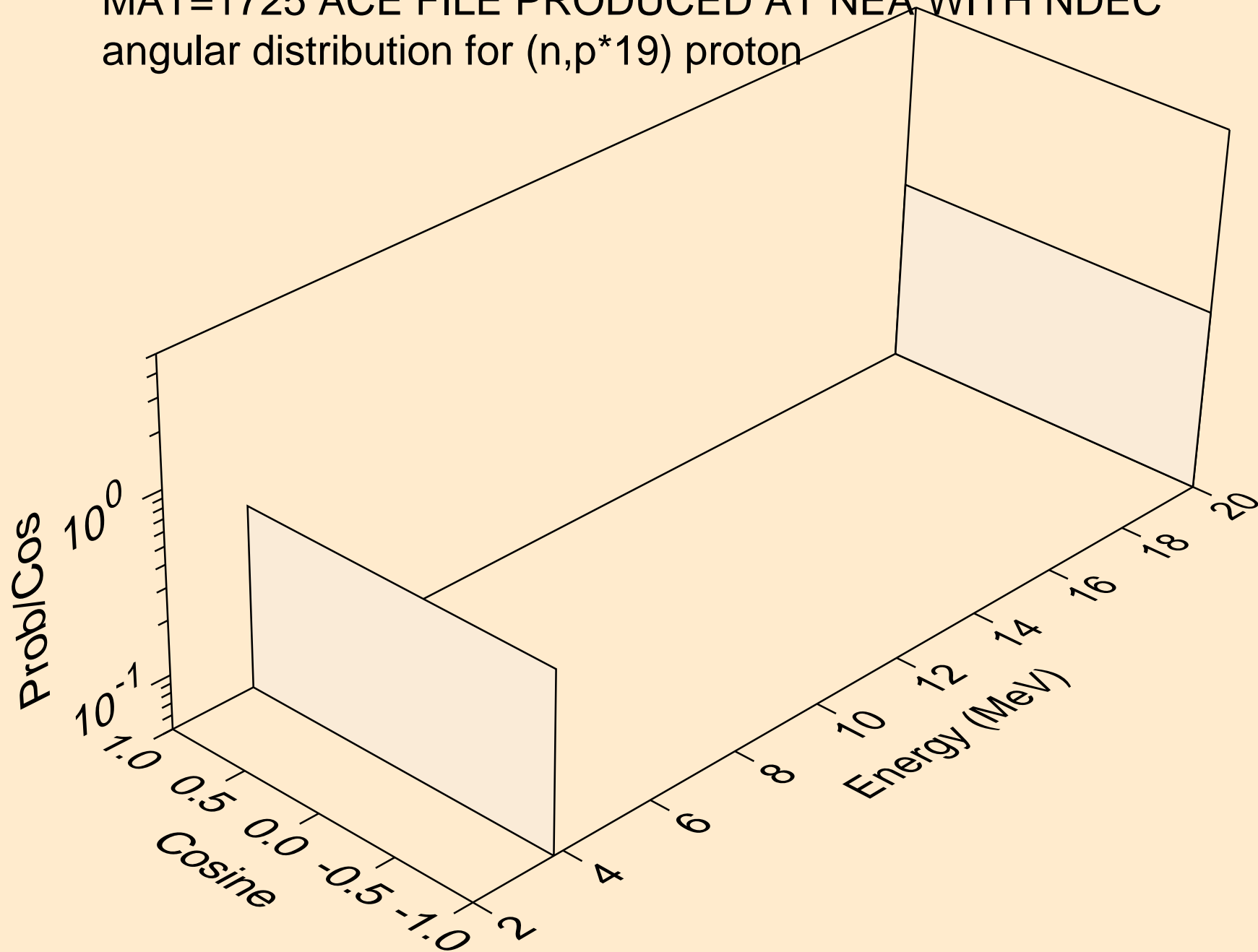

MAT=1725 ACE FILE PRODUCED AT NEA WITH NDEC
angular distribution for (n,p*20) proton

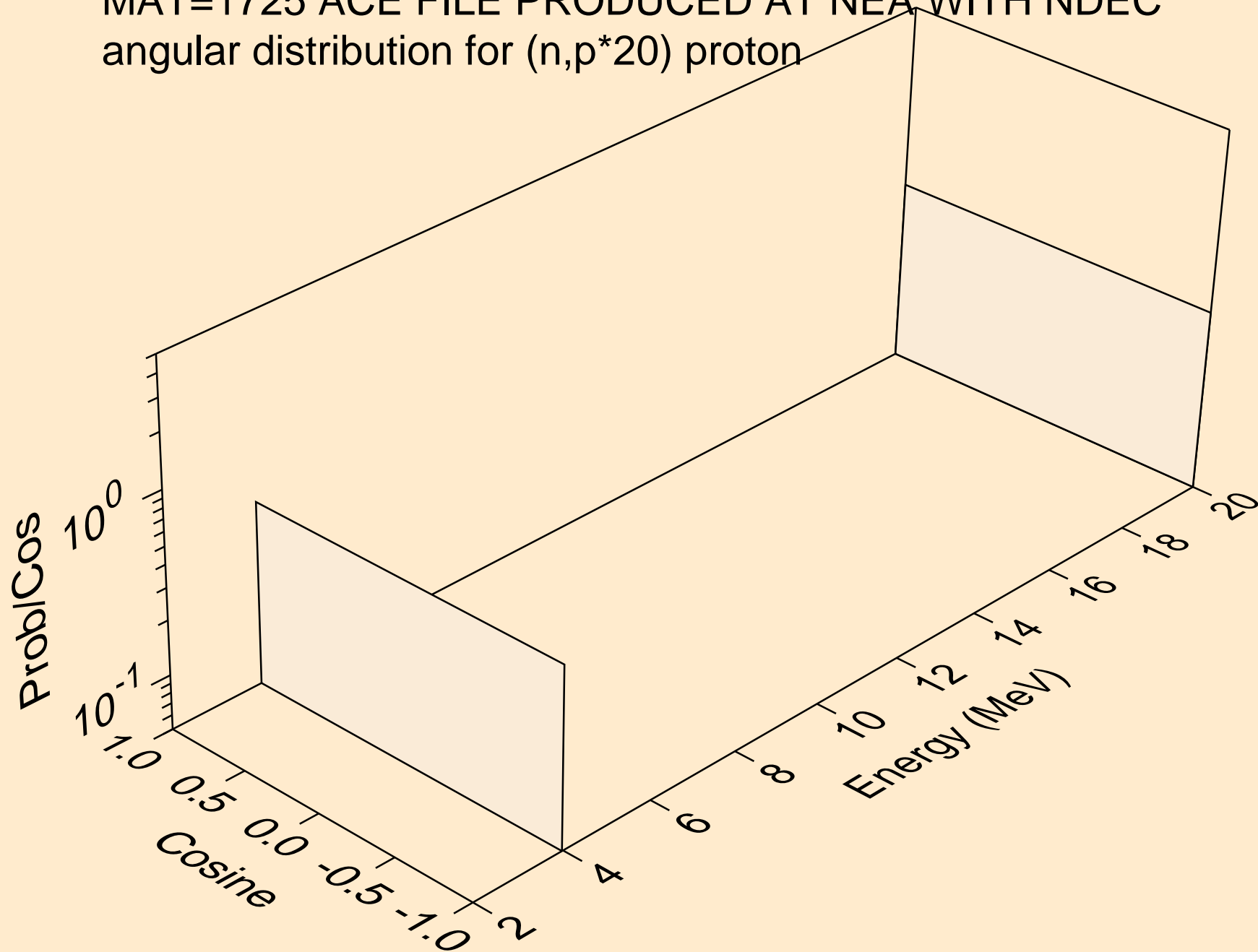

MAT=1725 ACE FILE PRODUCED AT NEA WITH NDEC
angular distribution for (n,p*21) proton

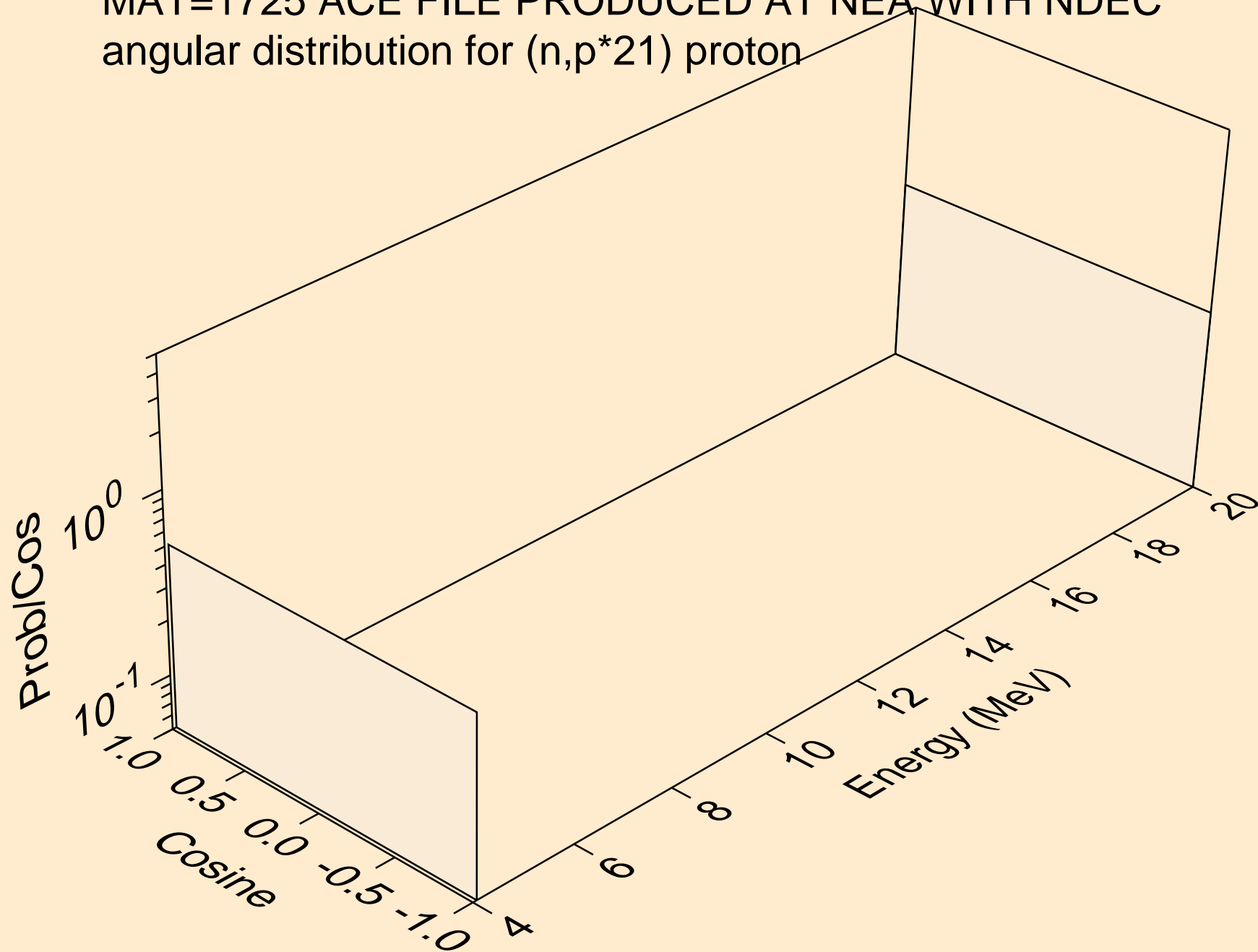

MAT=1725 ACE FILE PRODUCED AT NEA WITH NDEC
angular distribution for (n,p*22) proton

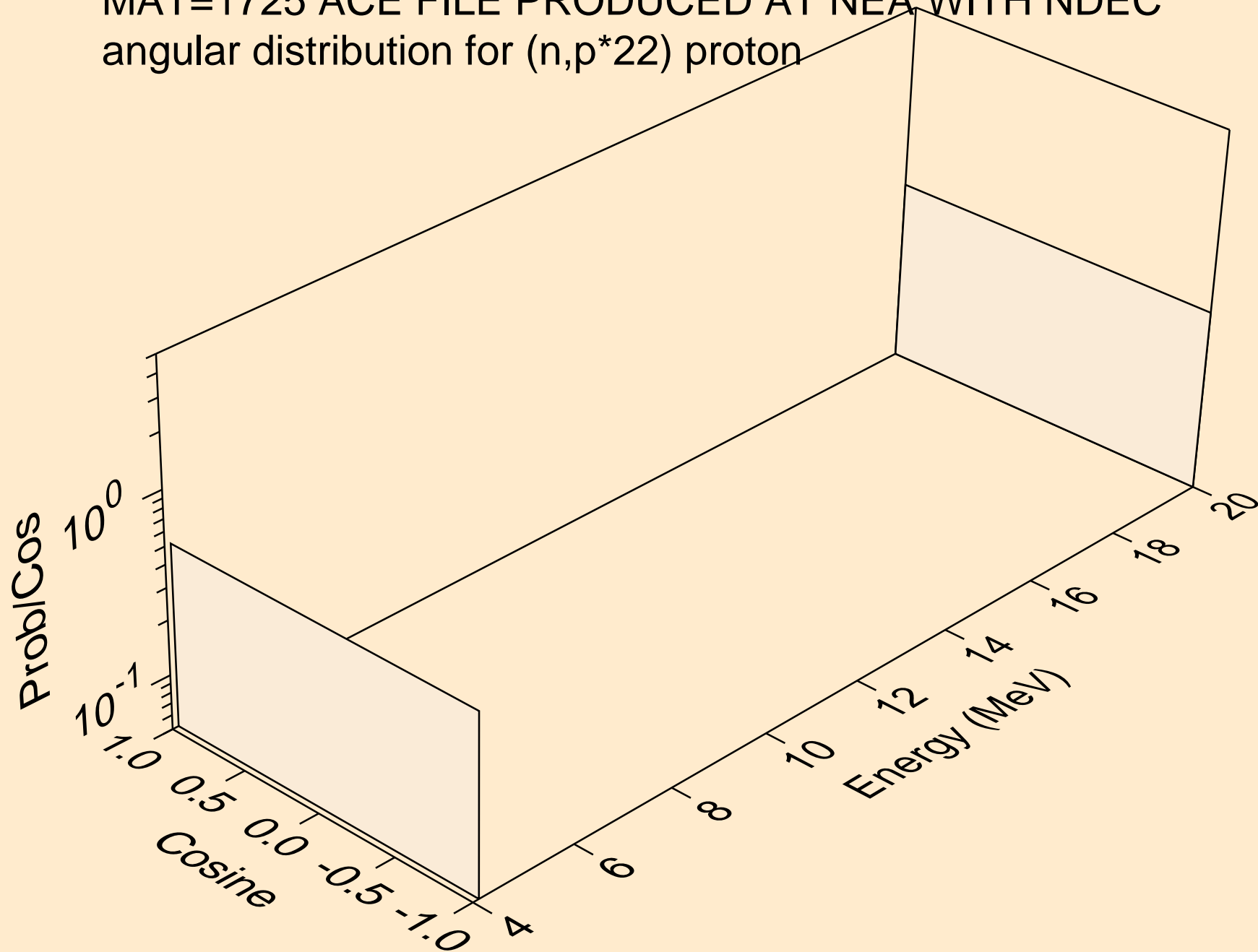

MAT=1725 ACE FILE PRODUCED AT NEA WITH NDEC
angular distribution for (n,p*23) proton

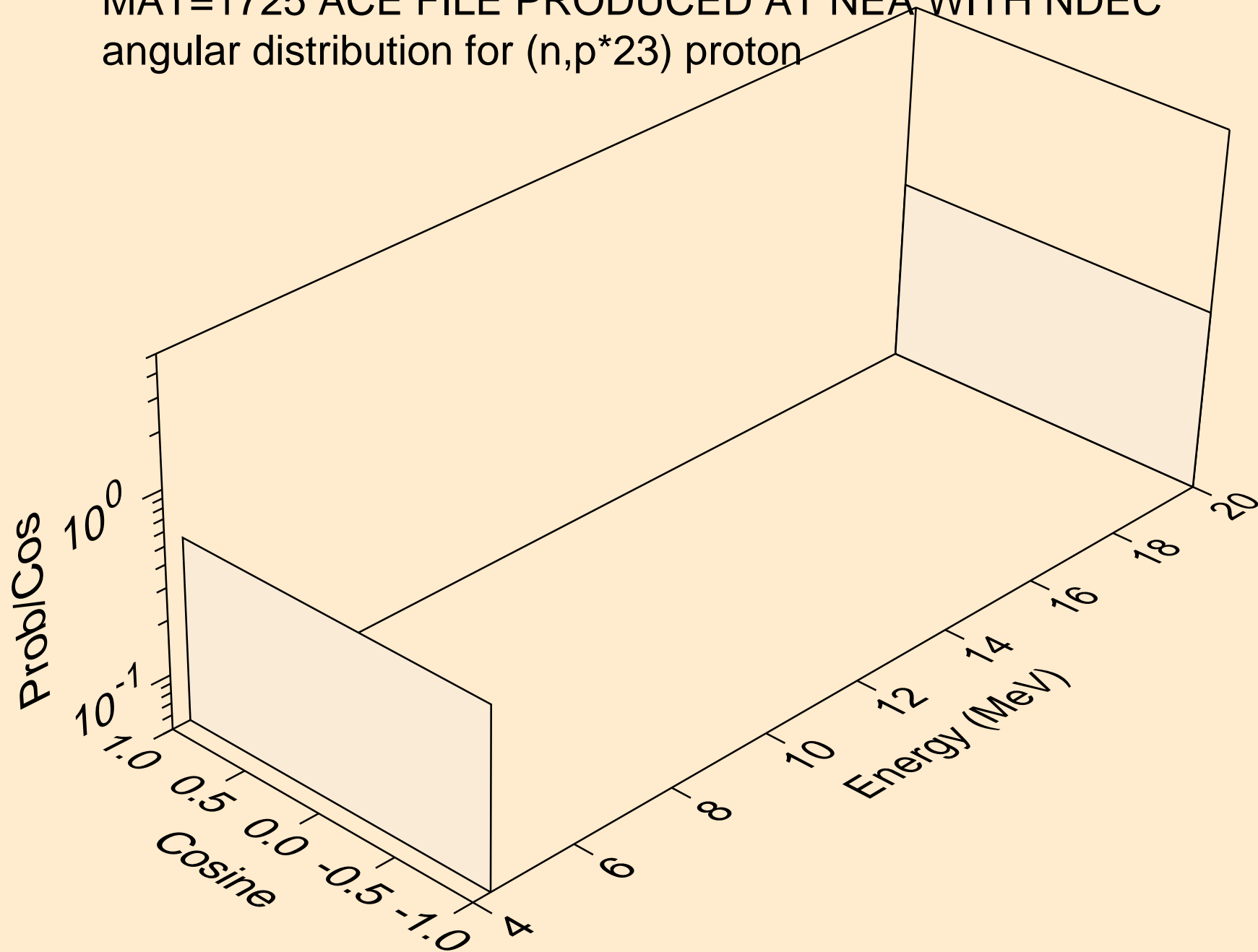

MAT=1725 ACE FILE PRODUCED AT NEA WITH NDEC
angular distribution for (n,p*24) proton

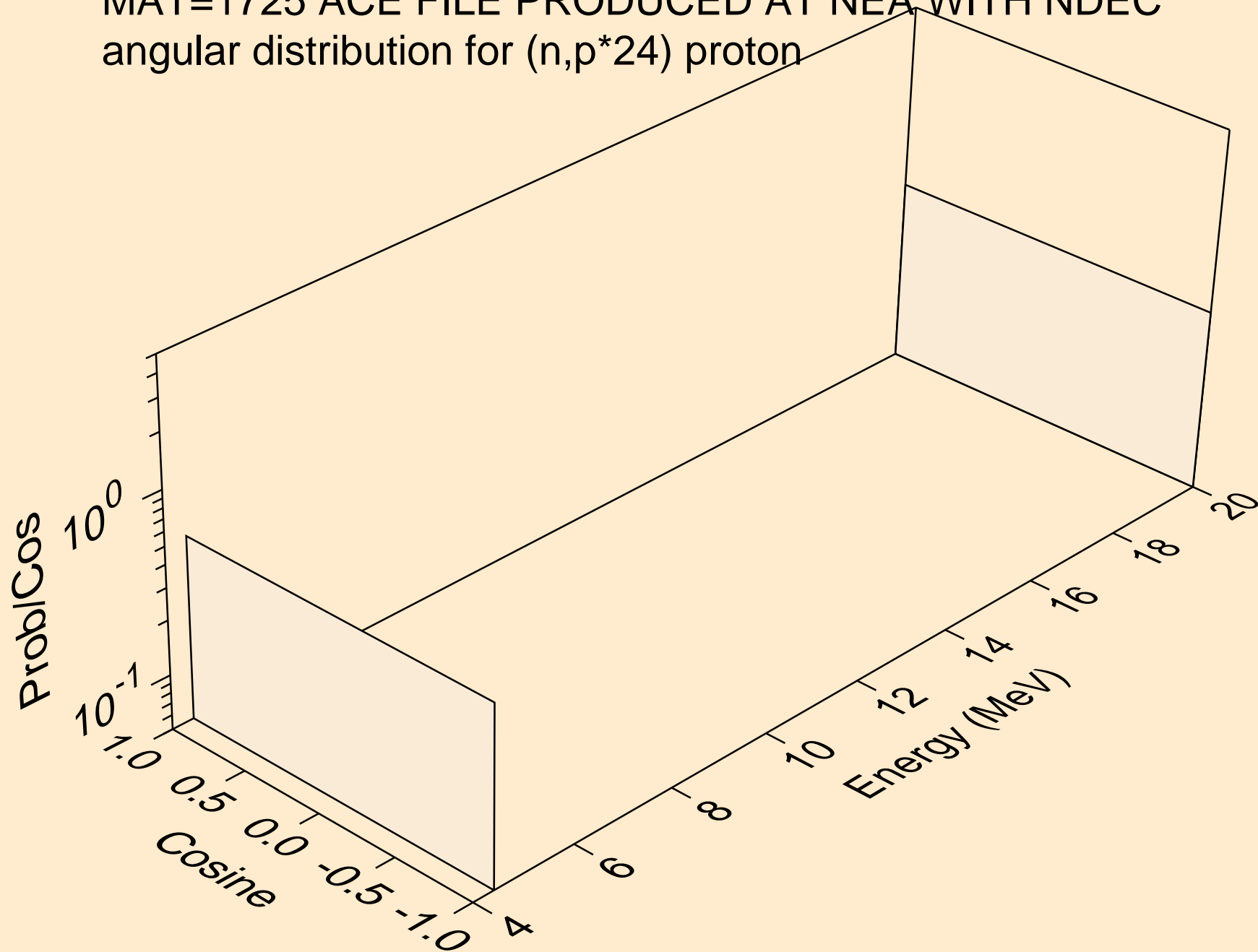

MAT=1725 ACE FILE PRODUCED AT NEA WITH NDEC
angular distribution for (n,p*25) proton

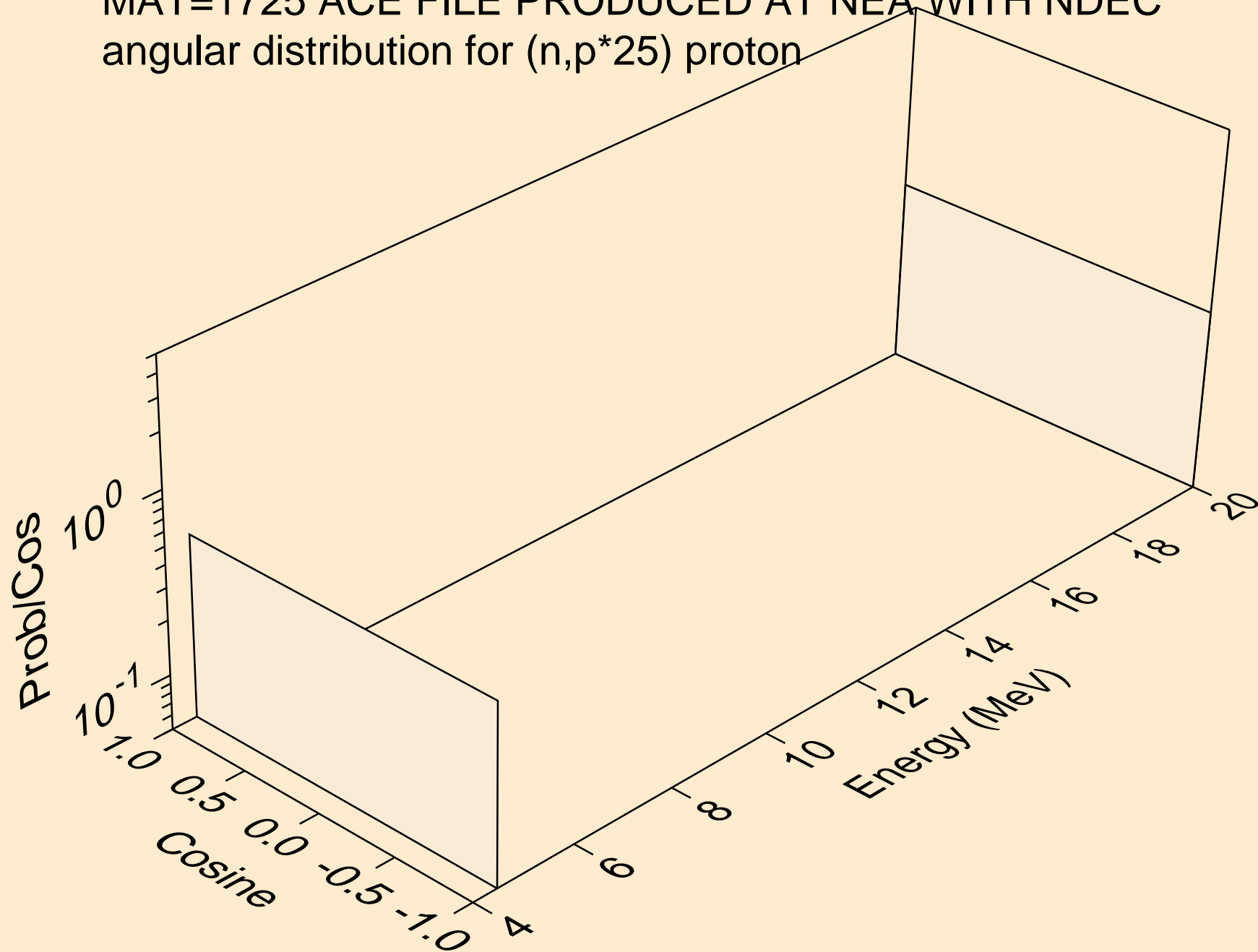

MAT=1725 ACE FILE PRODUCED AT NEA WITH NDEC
angular distribution for (n,p*26) proton

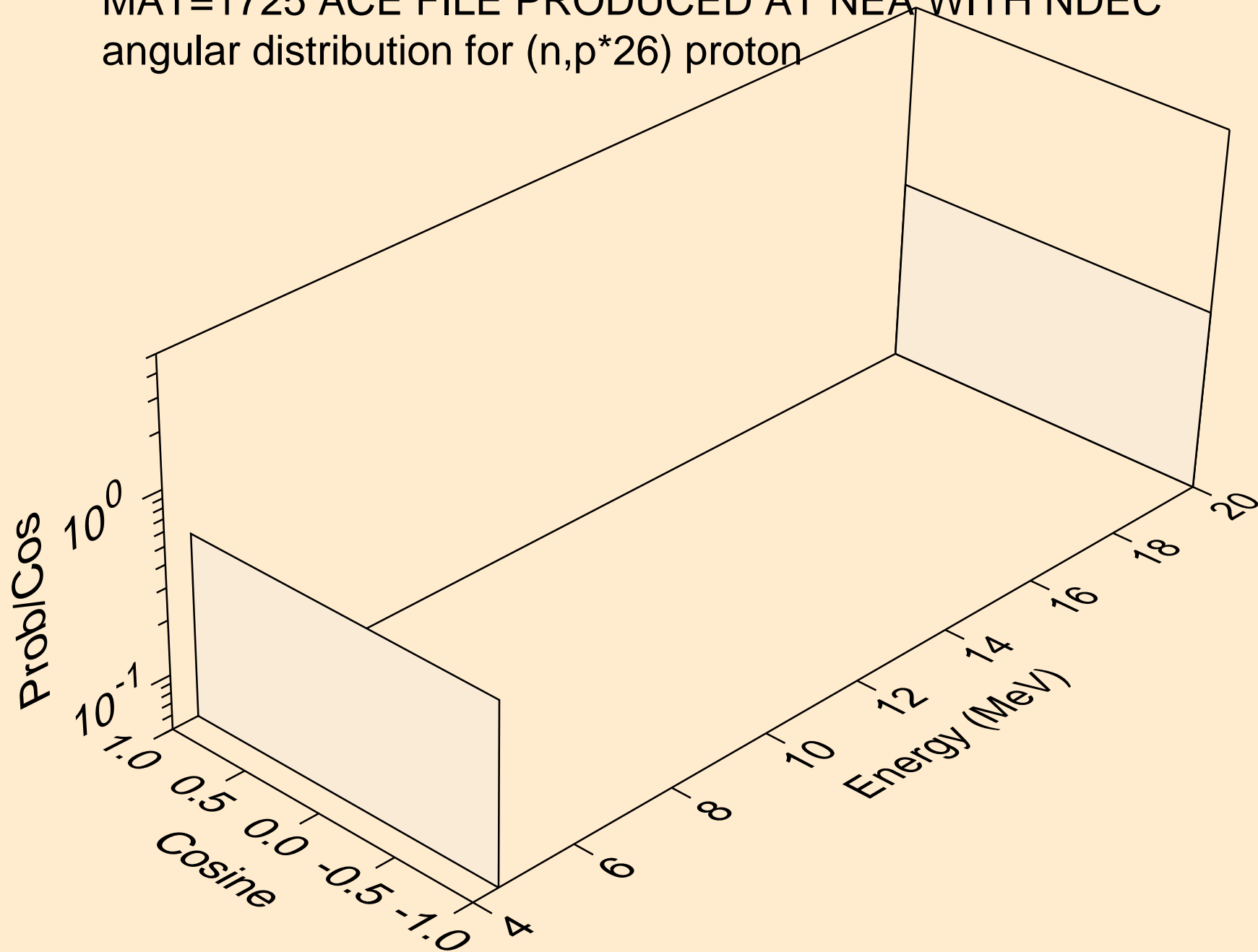

MAT=1725 ACE FILE PRODUCED AT NEA WITH NDEC
angular distribution for (n,p*27) proton

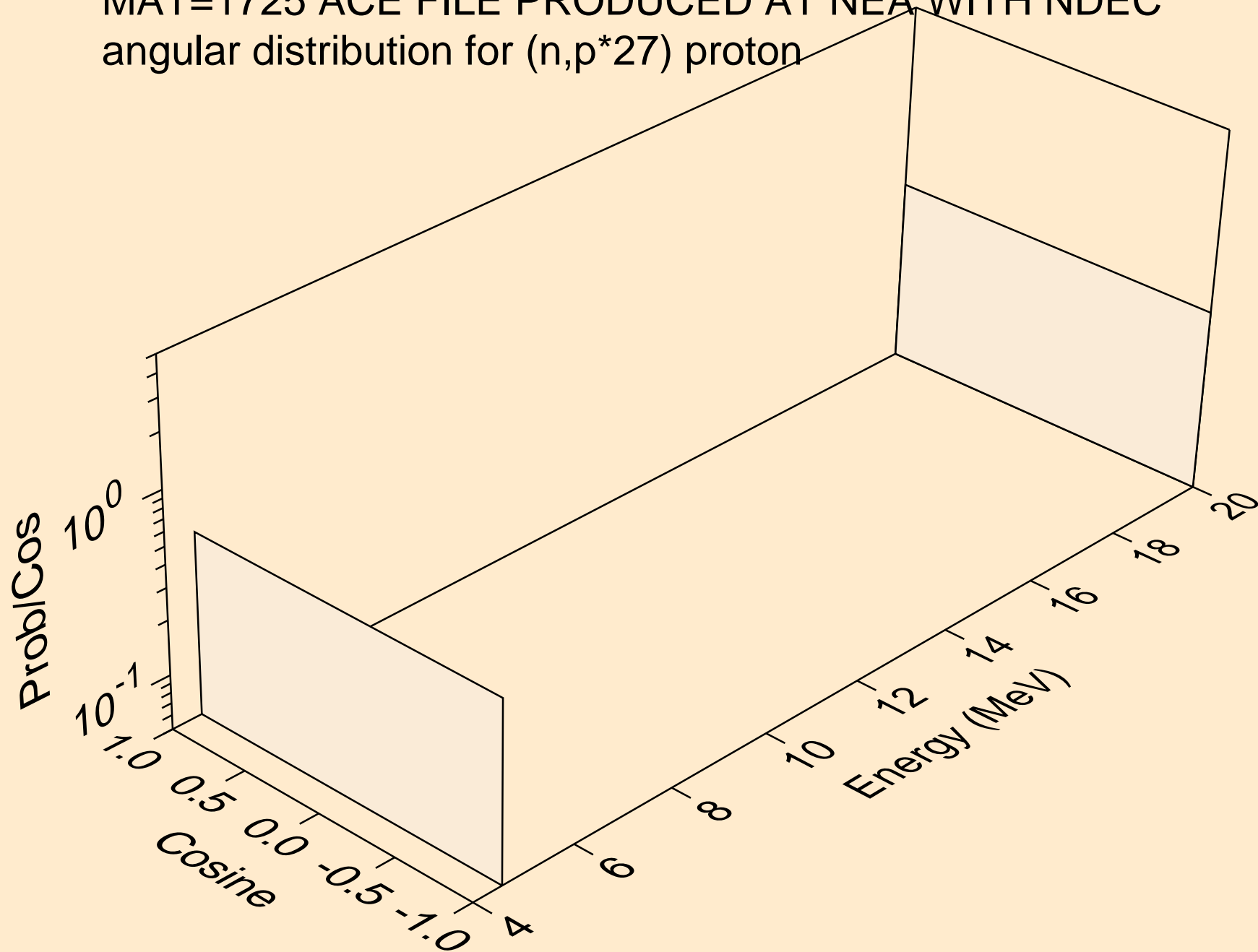

MAT=1725 ACE FILE PRODUCED AT NEA WITH NDEC
angular distribution for (n,p*28) proton

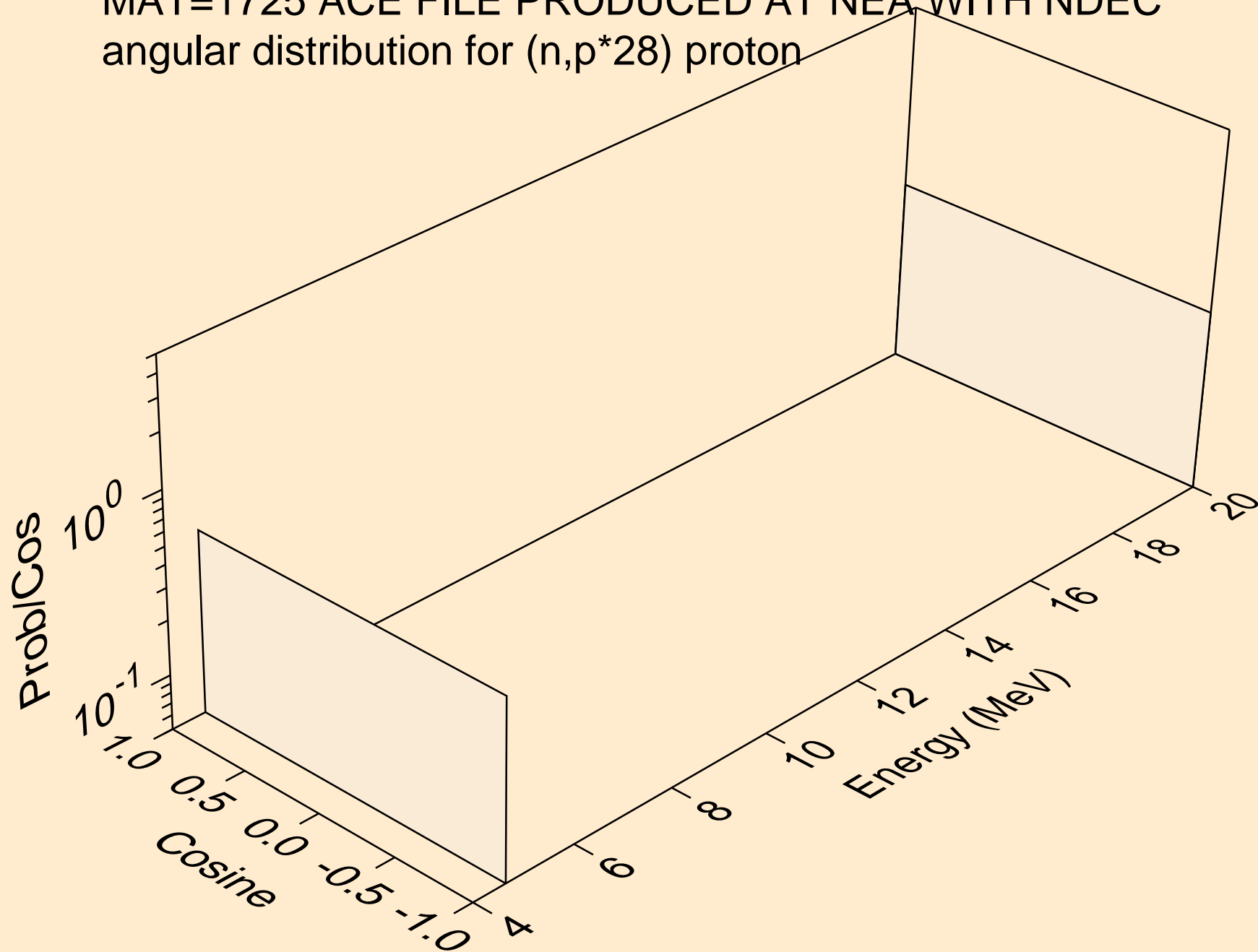

MAT=1725 ACE FILE PRODUCED AT NEA WITH NDEC
angular distribution for (n,p*29) proton

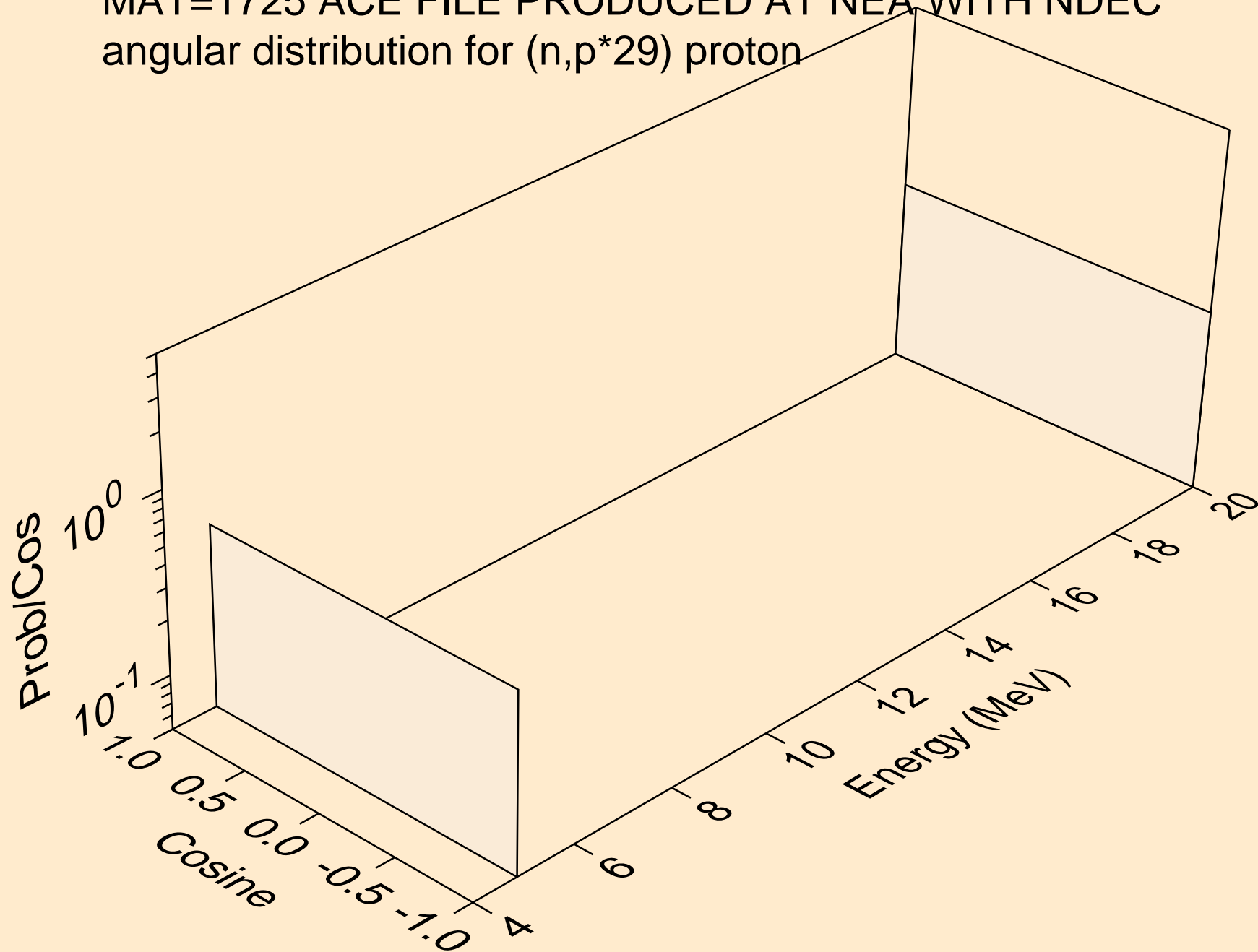

MAT=1725 ACE FILE PRODUCED AT NEA WITH NDEC
protons from (n,p*c)

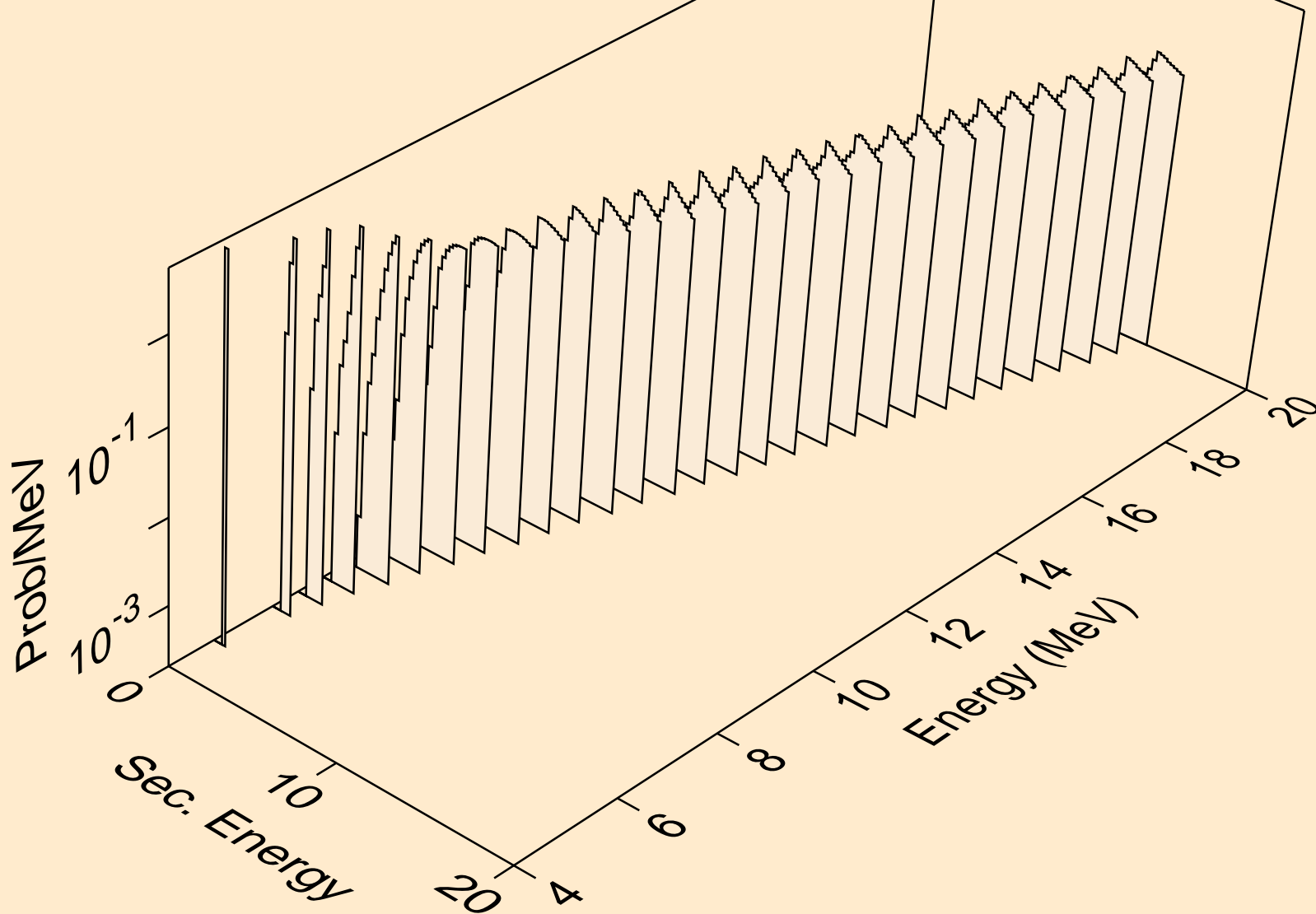

MAT=1725 ACE FILE PRODUCED AT NEA WITH NDEC
deuterons from (n,n*)d

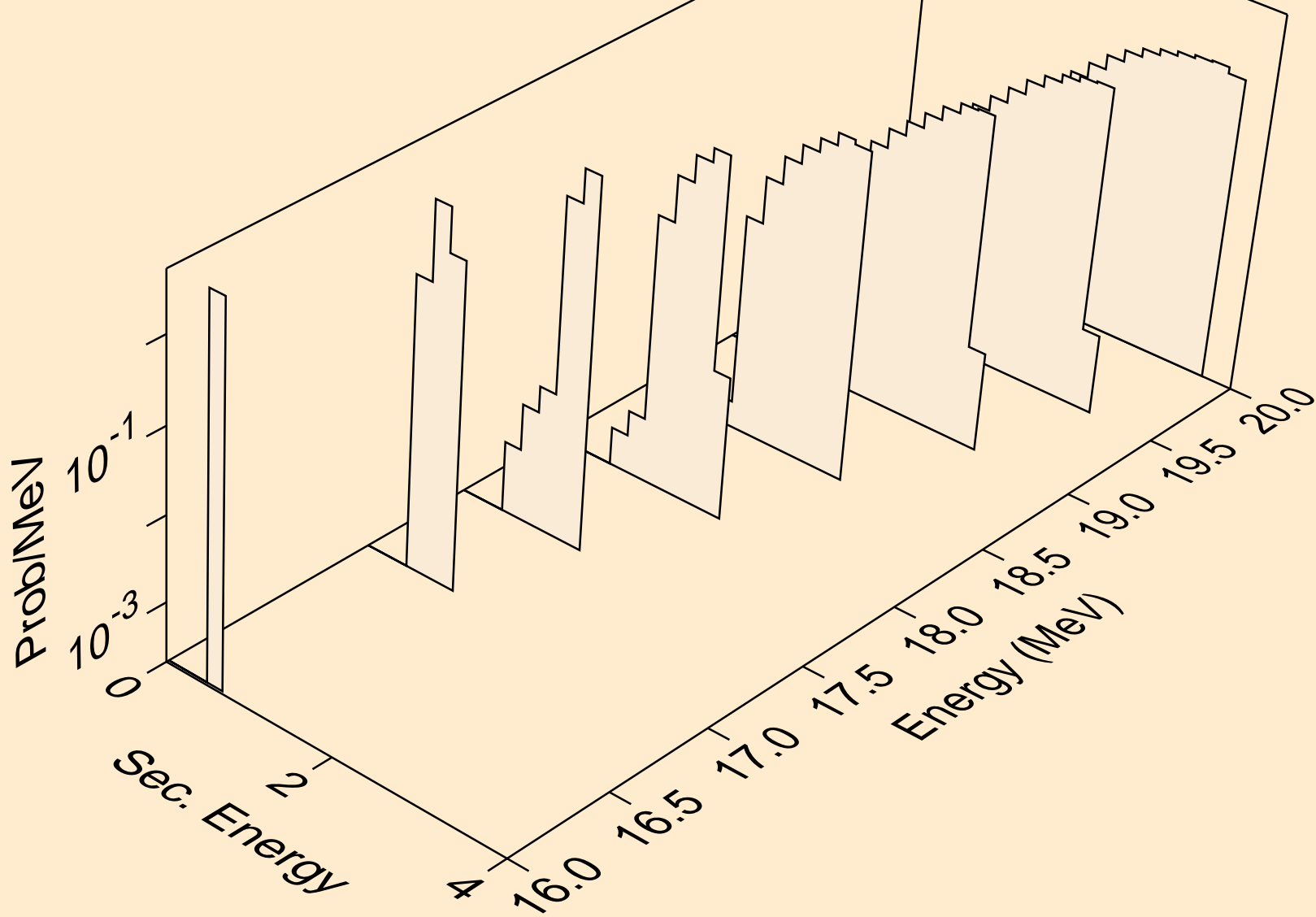

MAT=1725 ACE FILE PRODUCED AT NEA WITH NDEC
angular distribution for (n,d*0) deuteron

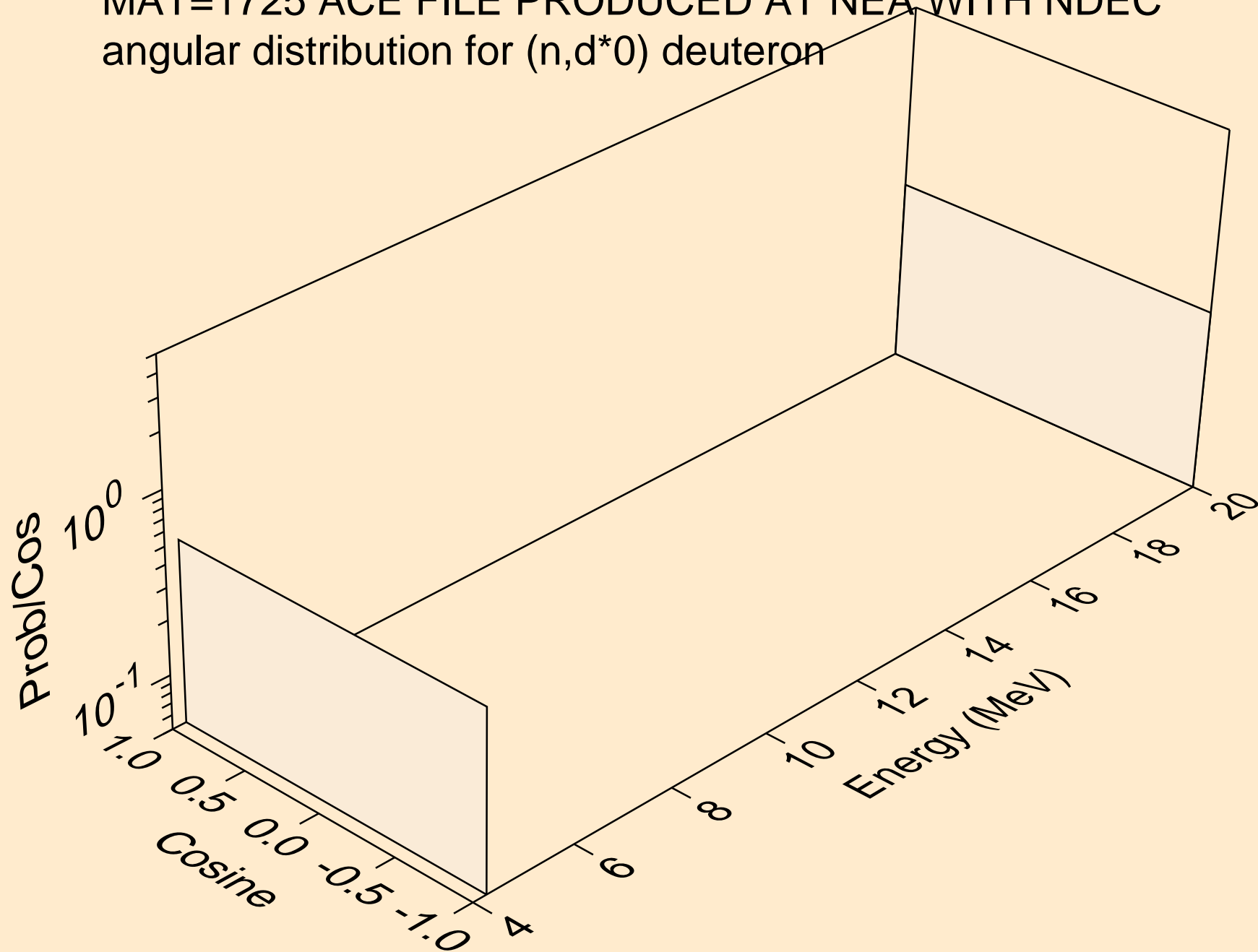

MAT=1725 ACE FILE PRODUCED AT NEA WITH NDEC
angular distribution for (n,d*1) deuteron

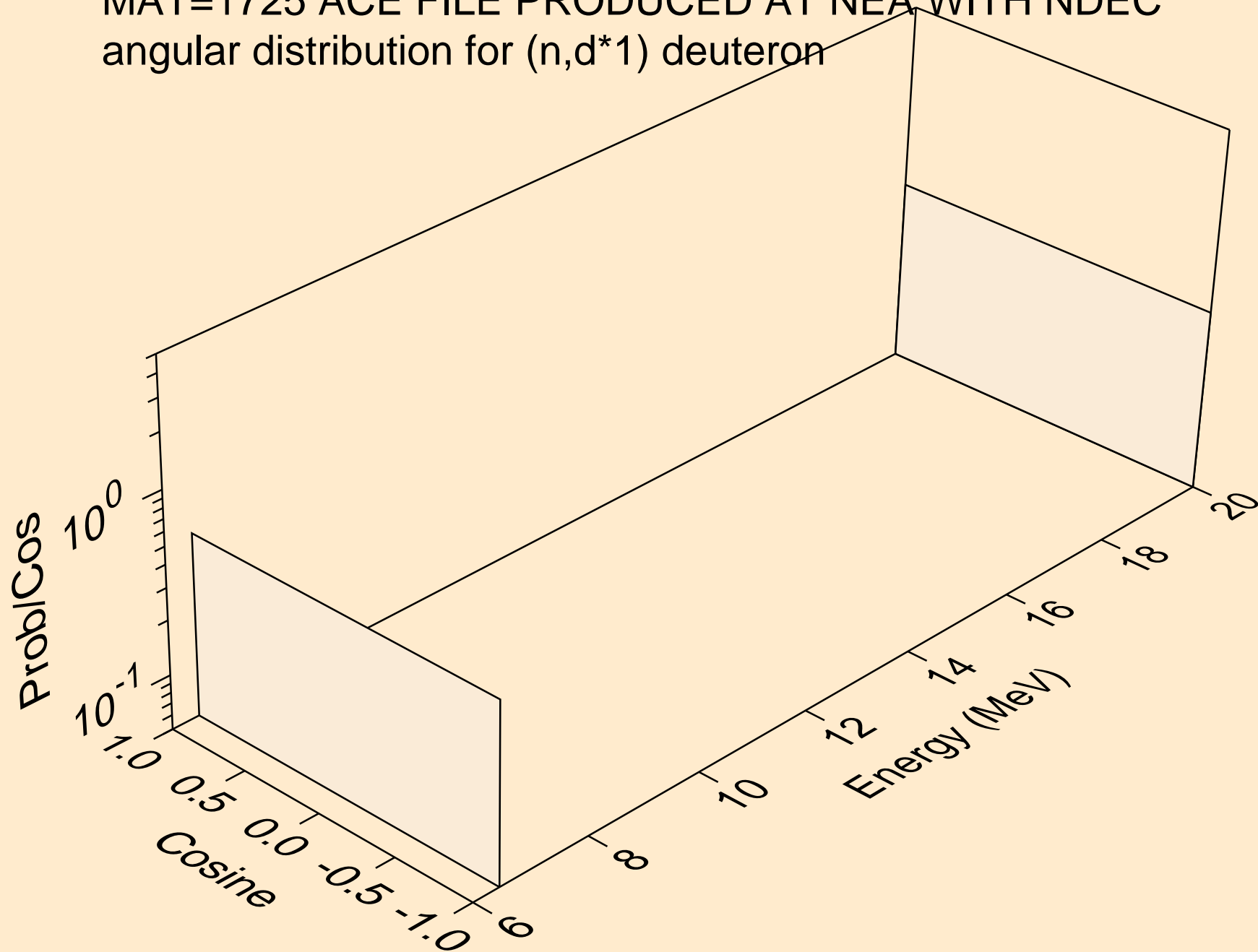

MAT=1725 ACE FILE PRODUCED AT NEA WITH NDEC
angular distribution for (n,d*2) deuteron

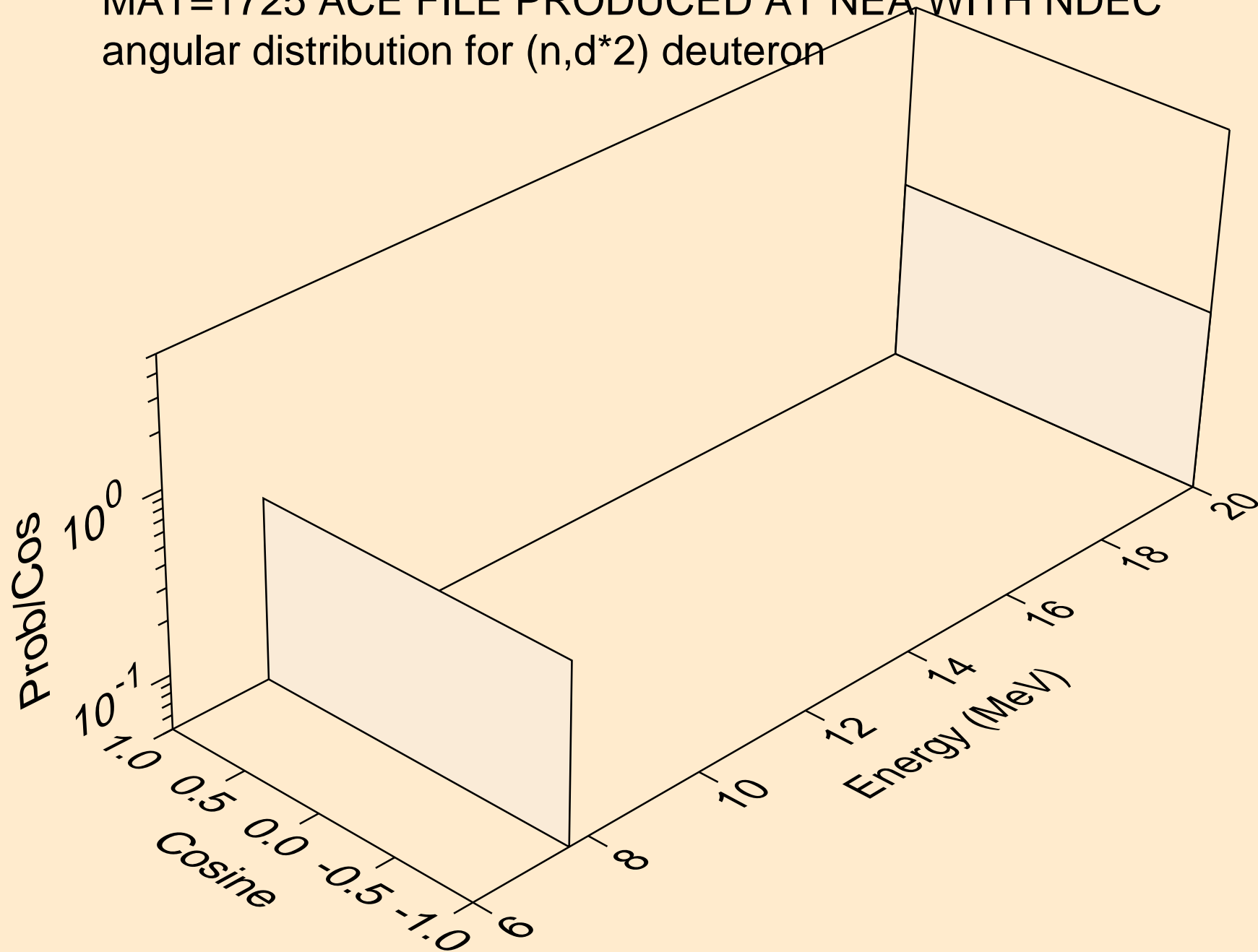

MAT=1725 ACE FILE PRODUCED AT NEA WITH NDEC
angular distribution for (n,d*3) deuteron

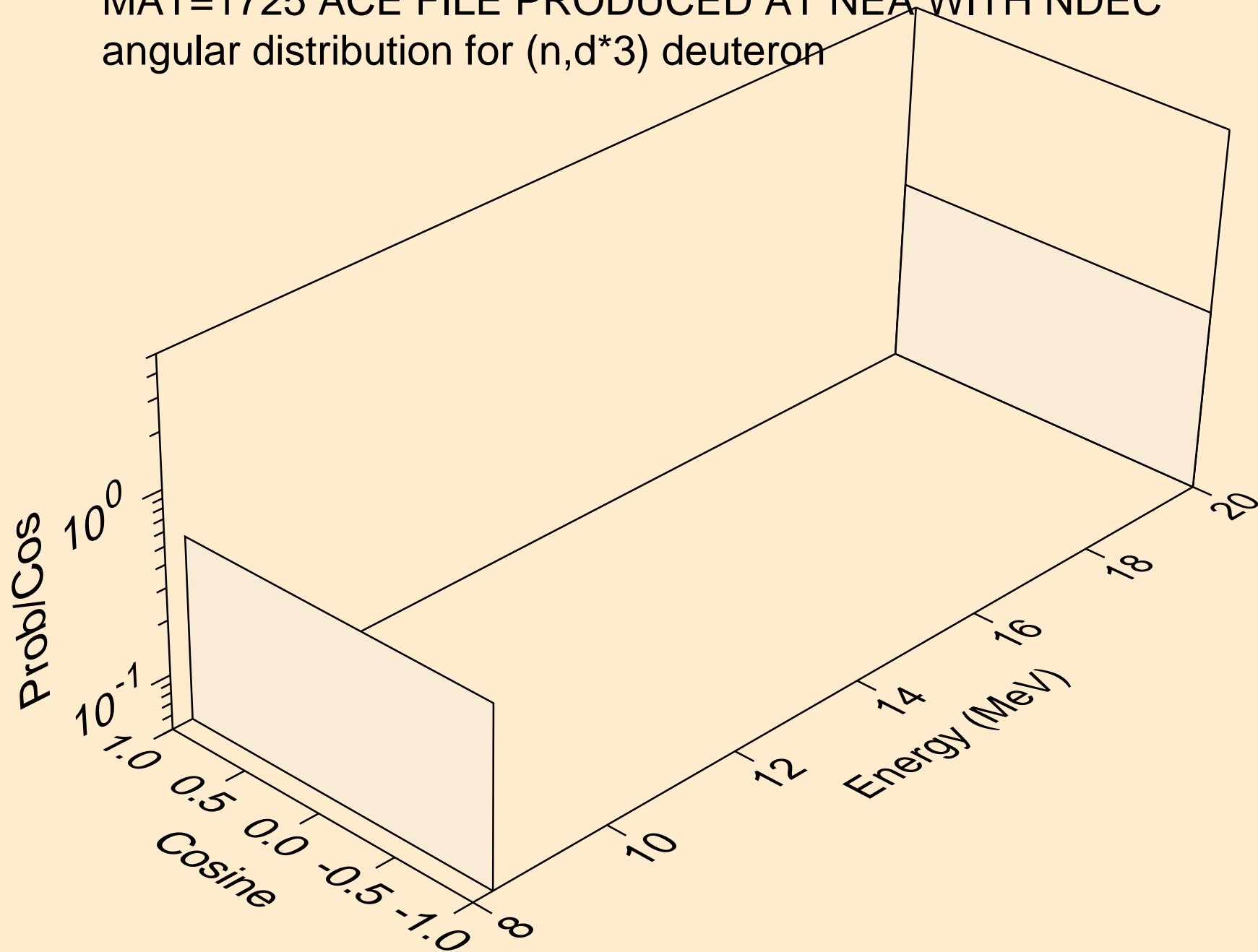

MAT=1725 ACE FILE PRODUCED AT NEA WITH NDEC
angular distribution for (n,d*4) deuteron

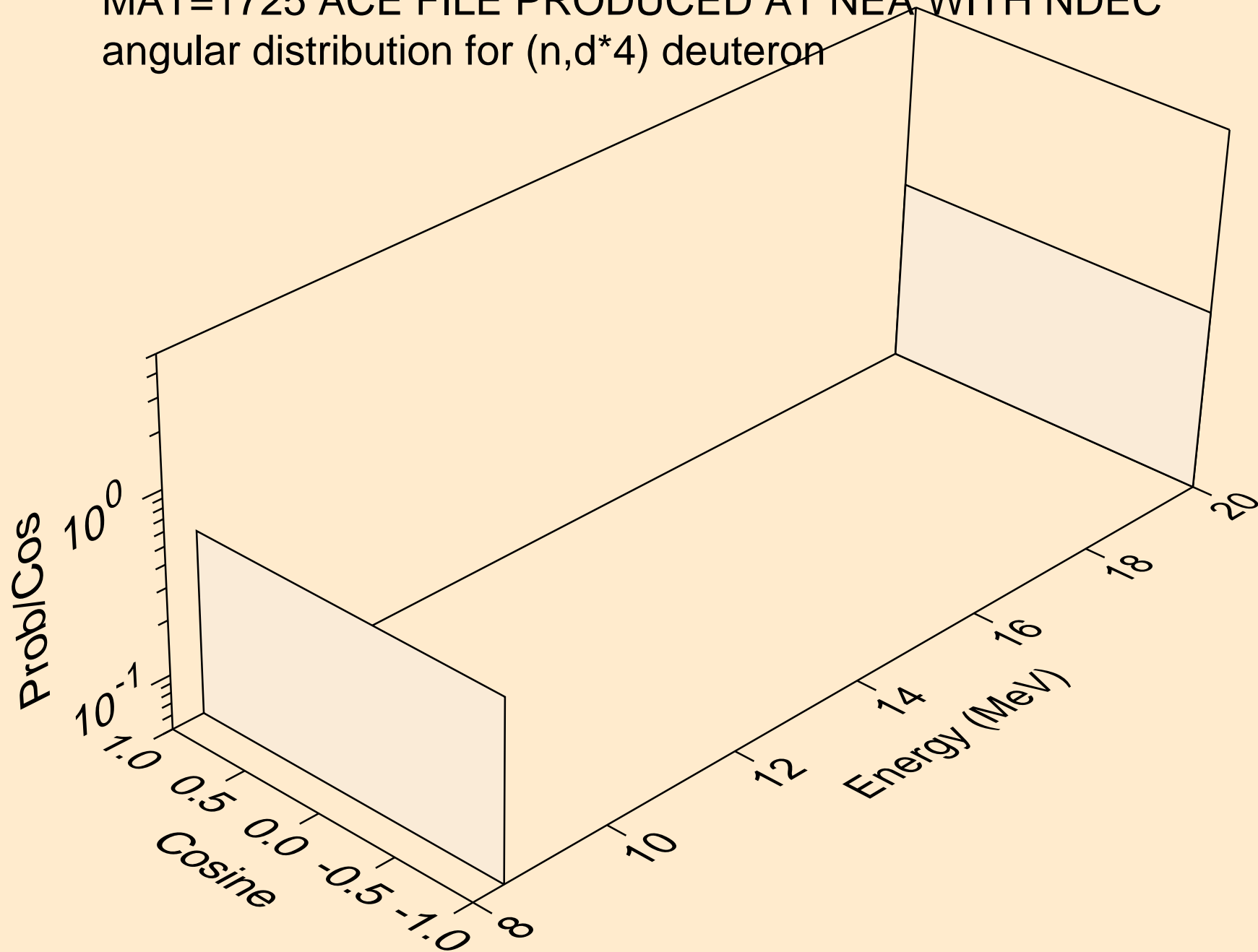

MAT=1725 ACE FILE PRODUCED AT NEA WITH NDEC
angular distribution for (n,d*5) deuteron

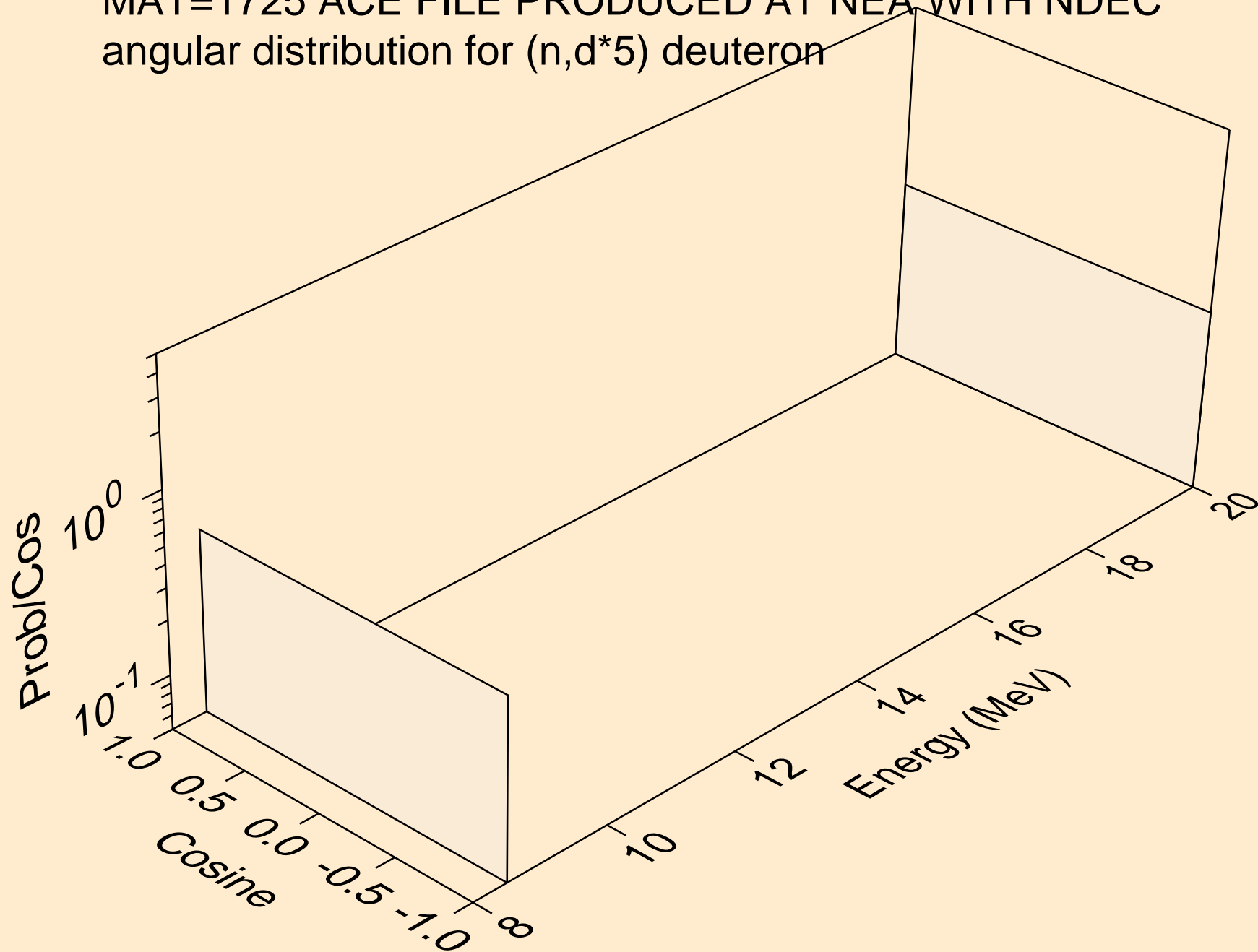

MAT=1725 ACE FILE PRODUCED AT NEA WITH NDEC
angular distribution for (n,d*6) deuteron

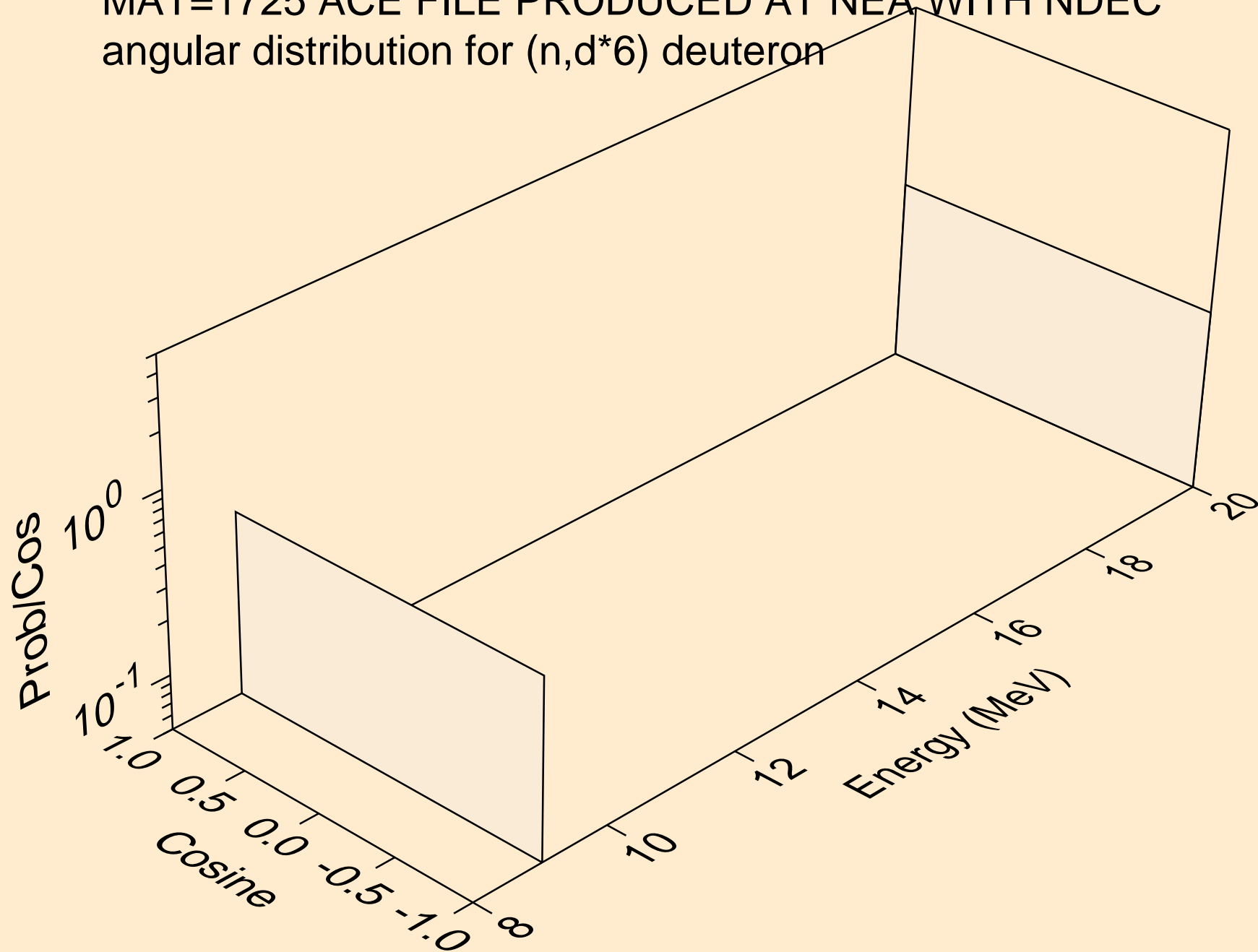

MAT=1725 ACE FILE PRODUCED AT NEA WITH NDEC
angular distribution for (n,d*7) deuteron

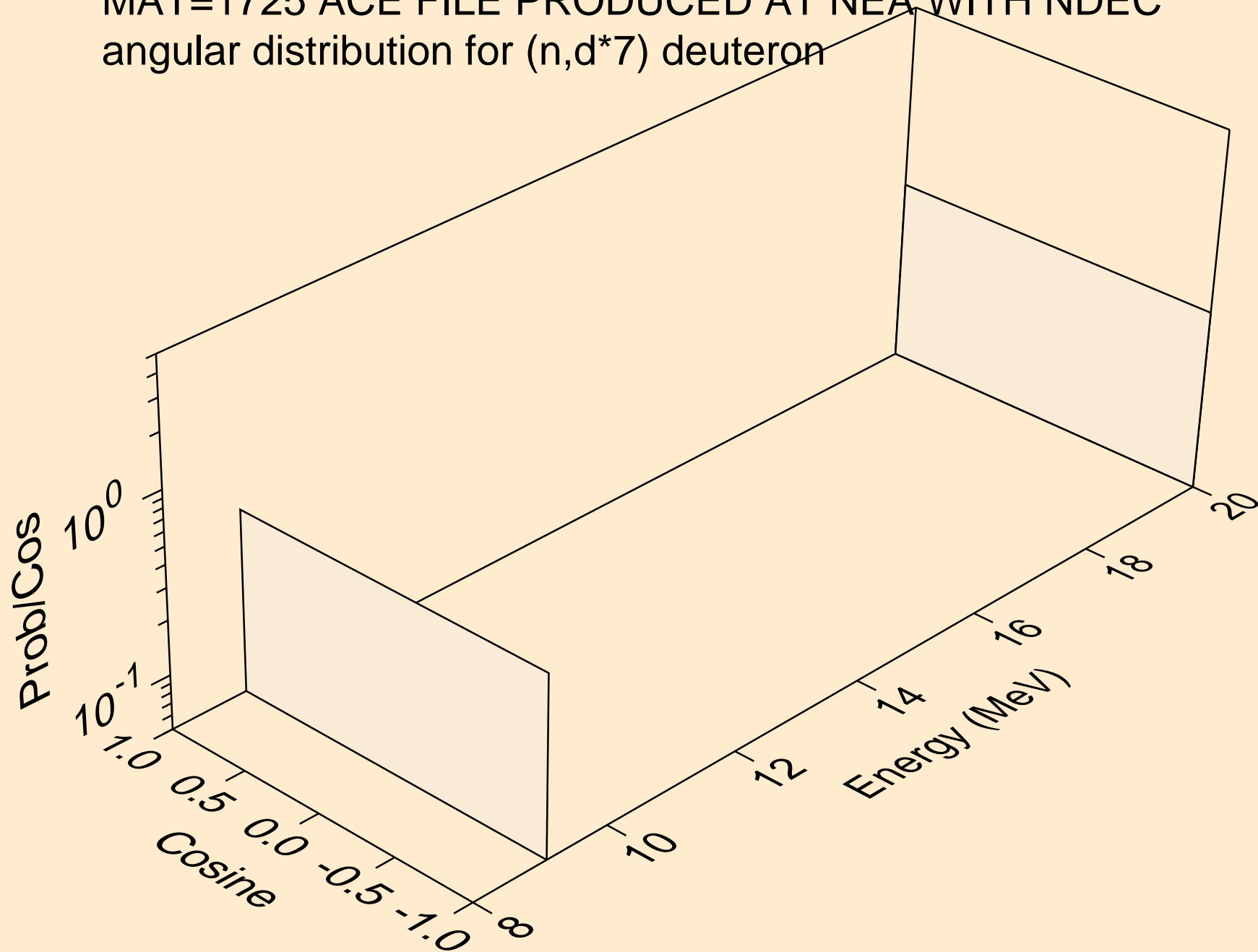

MAT=1725 ACE FILE PRODUCED AT NEA WITH NDEC
angular distribution for (n,d*8) deuteron

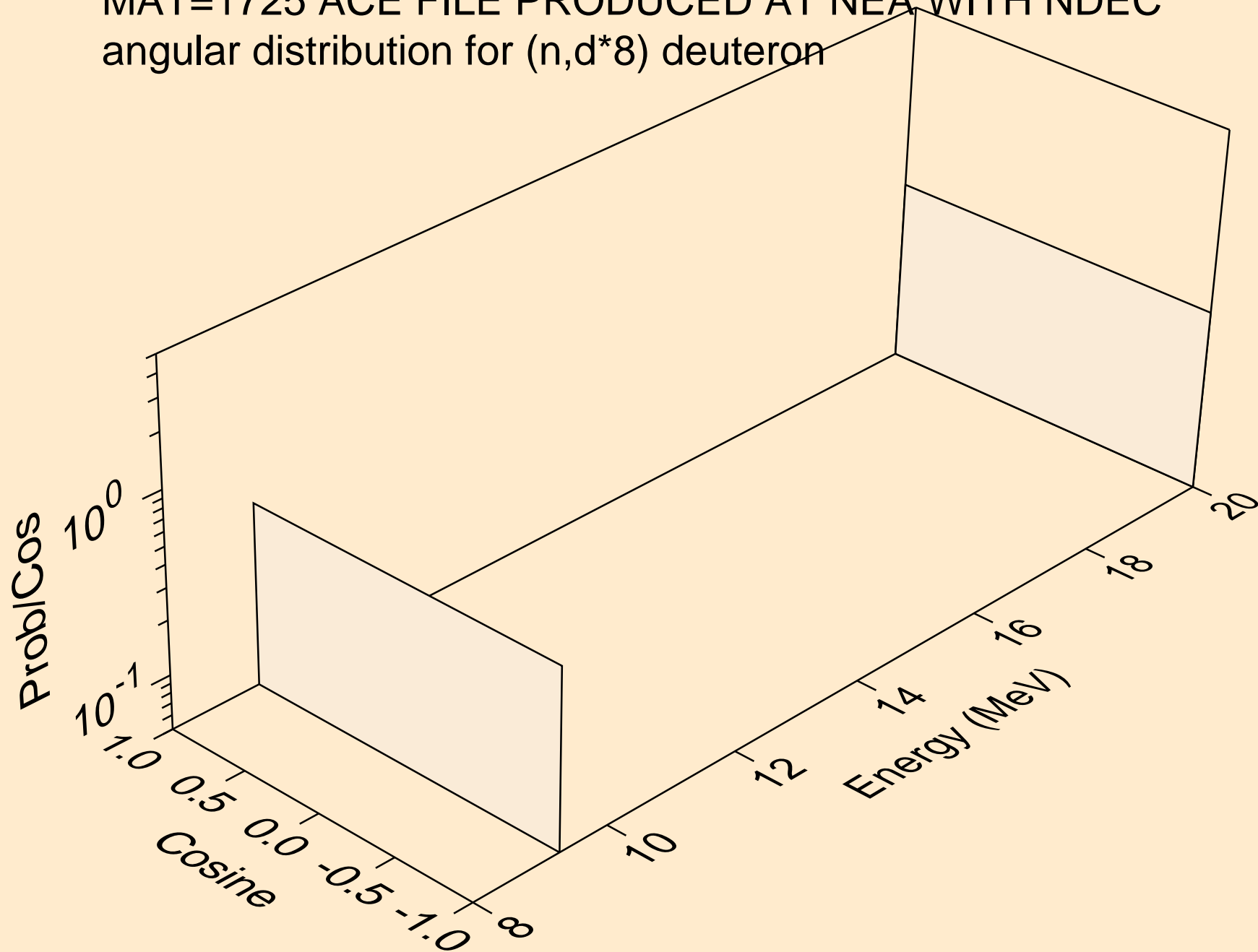

MAT=1725 ACE FILE PRODUCED AT NEA WITH NDEC
angular distribution for (n,d*9) deuteron

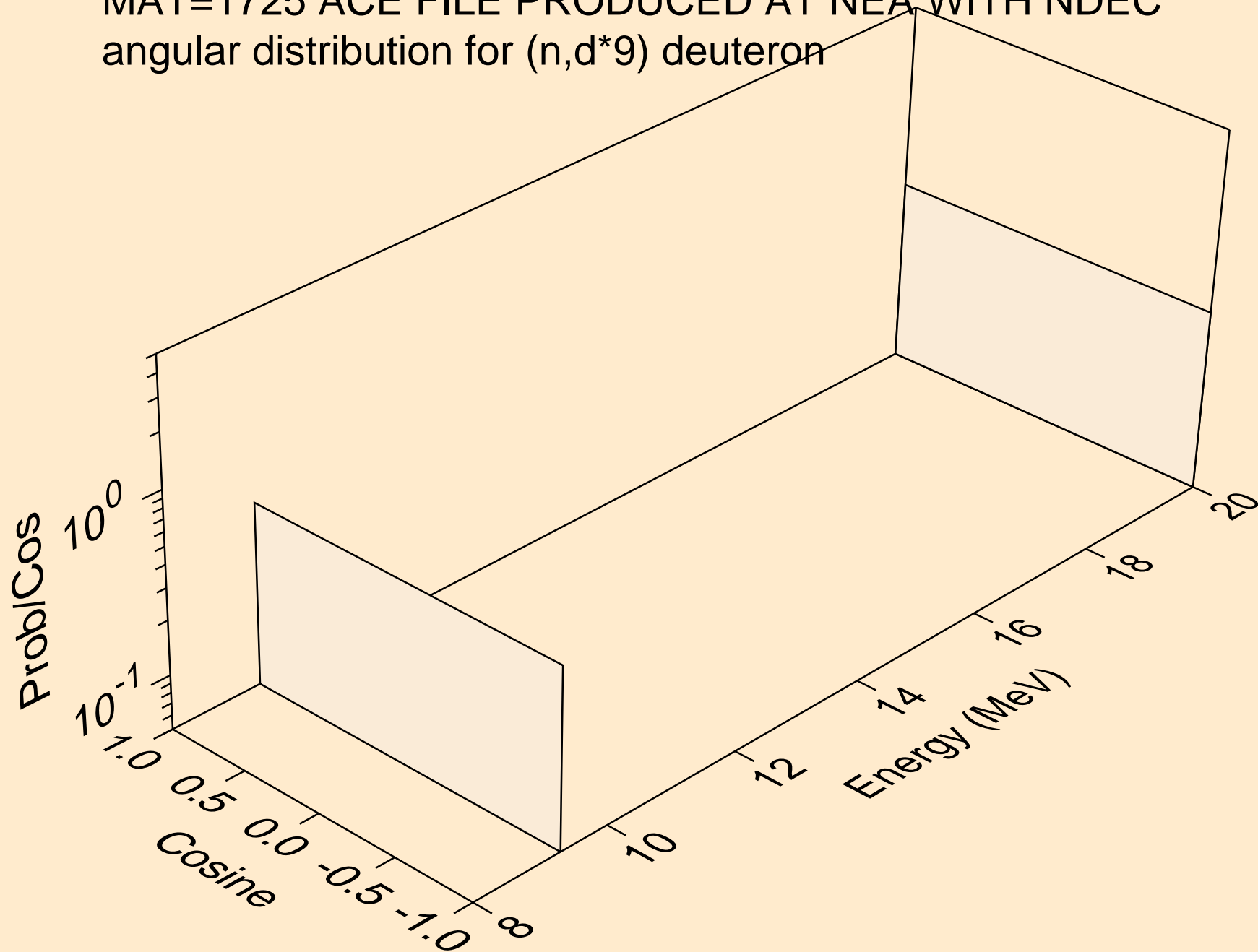

MAT=1725 ACE FILE PRODUCED AT NEA WITH NDEC
angular distribution for (n,d*10) deuteron

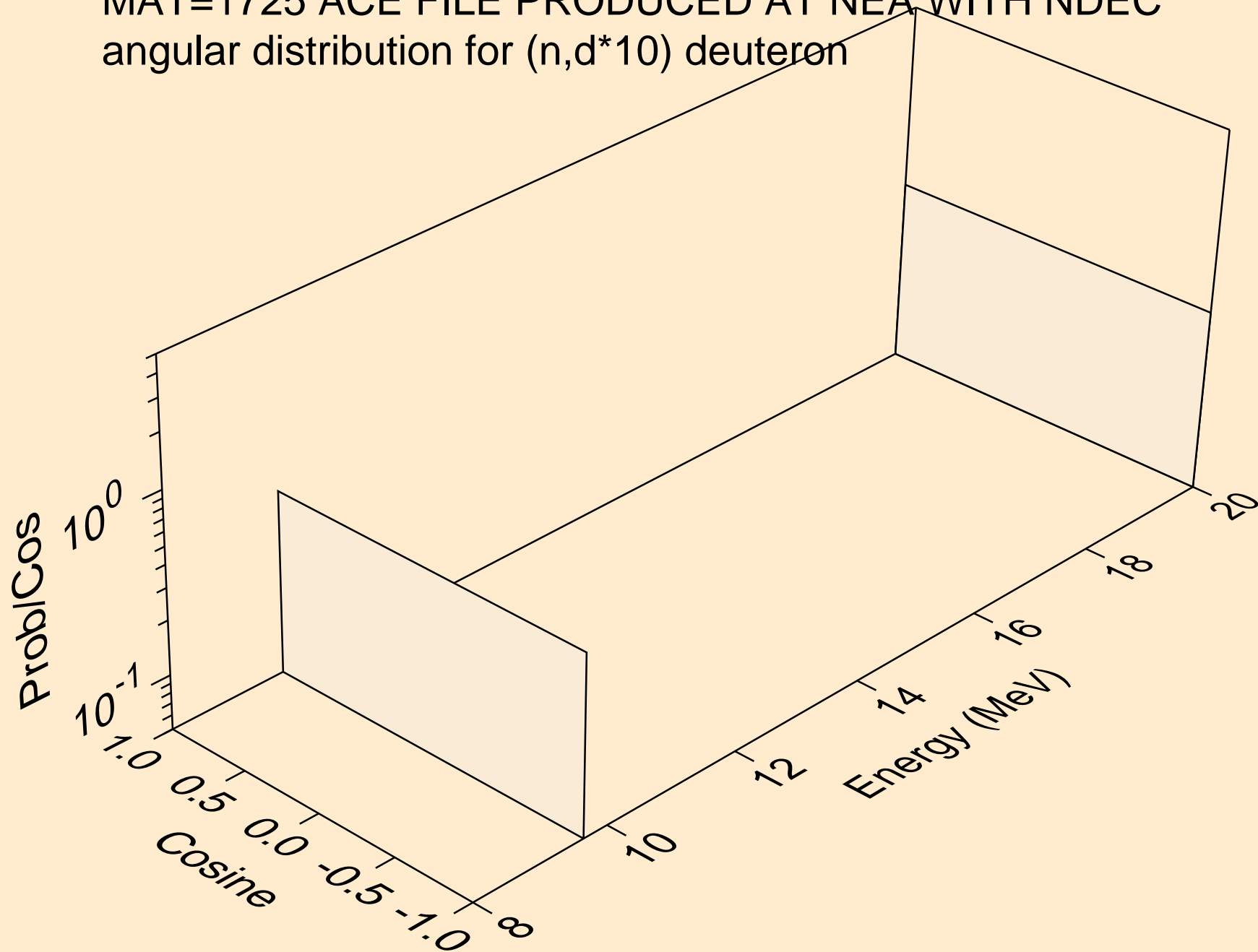

MAT=1725 ACE FILE PRODUCED AT NEA WITH NDEC
angular distribution for (n,d*11) deuteron

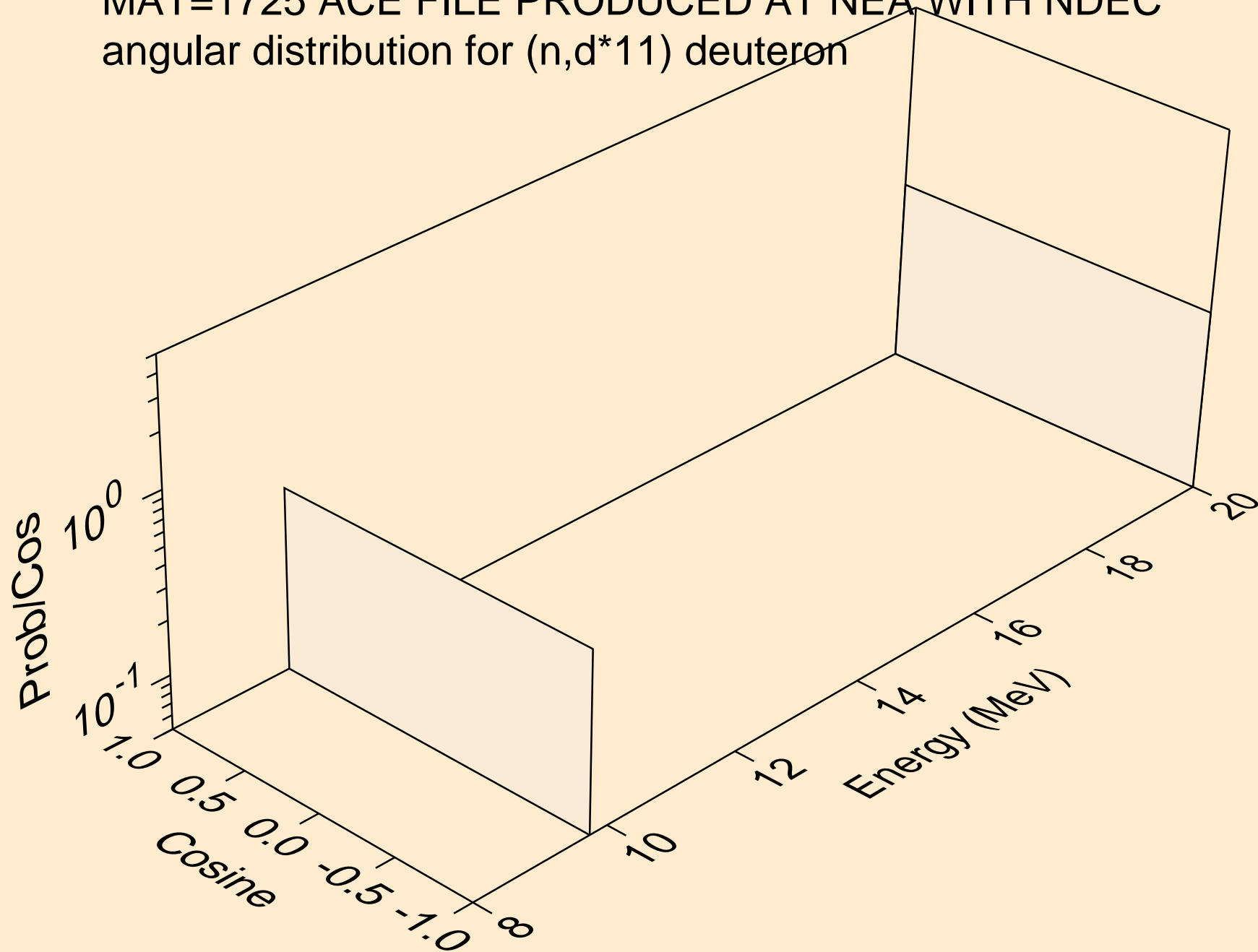

MAT=1725 ACE FILE PRODUCED AT NEA WITH NDEC
angular distribution for (n,d*12) deuteron

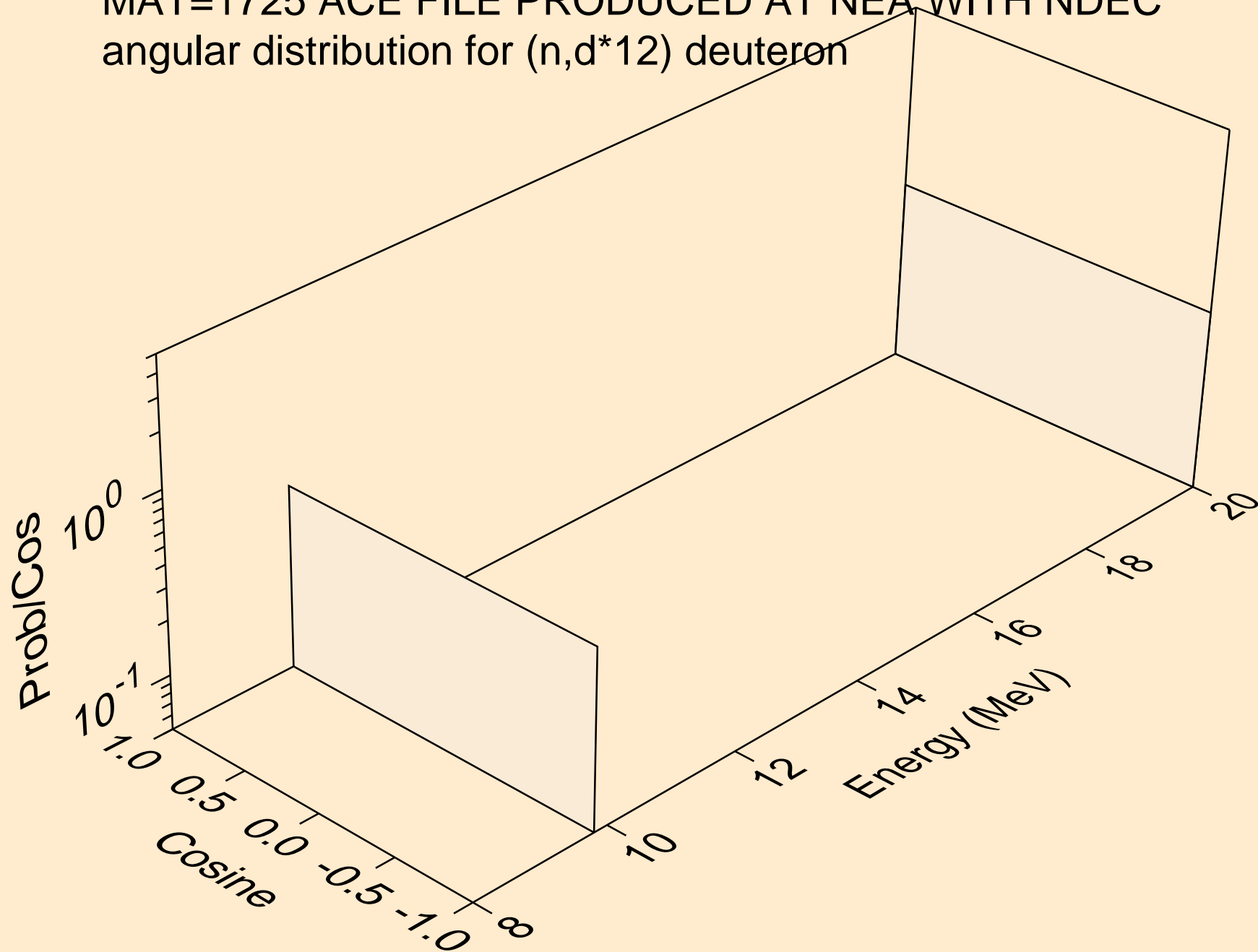

MAT=1725 ACE FILE PRODUCED AT NEA WITH NDEC
angular distribution for (n,d*13) deuteron

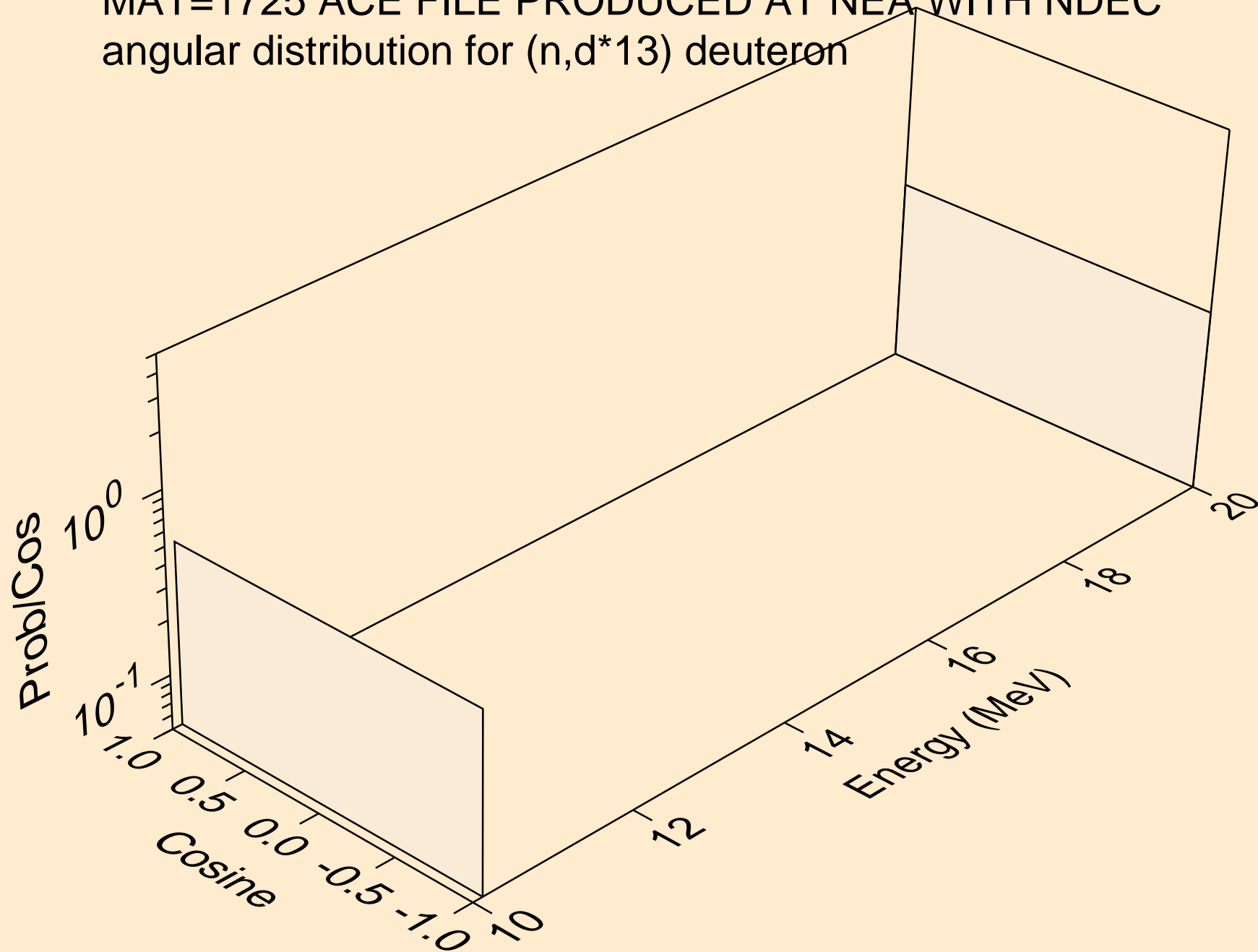

MAT=1725 ACE FILE PRODUCED AT NEA WITH NDEC
angular distribution for (n,d*14) deuteron

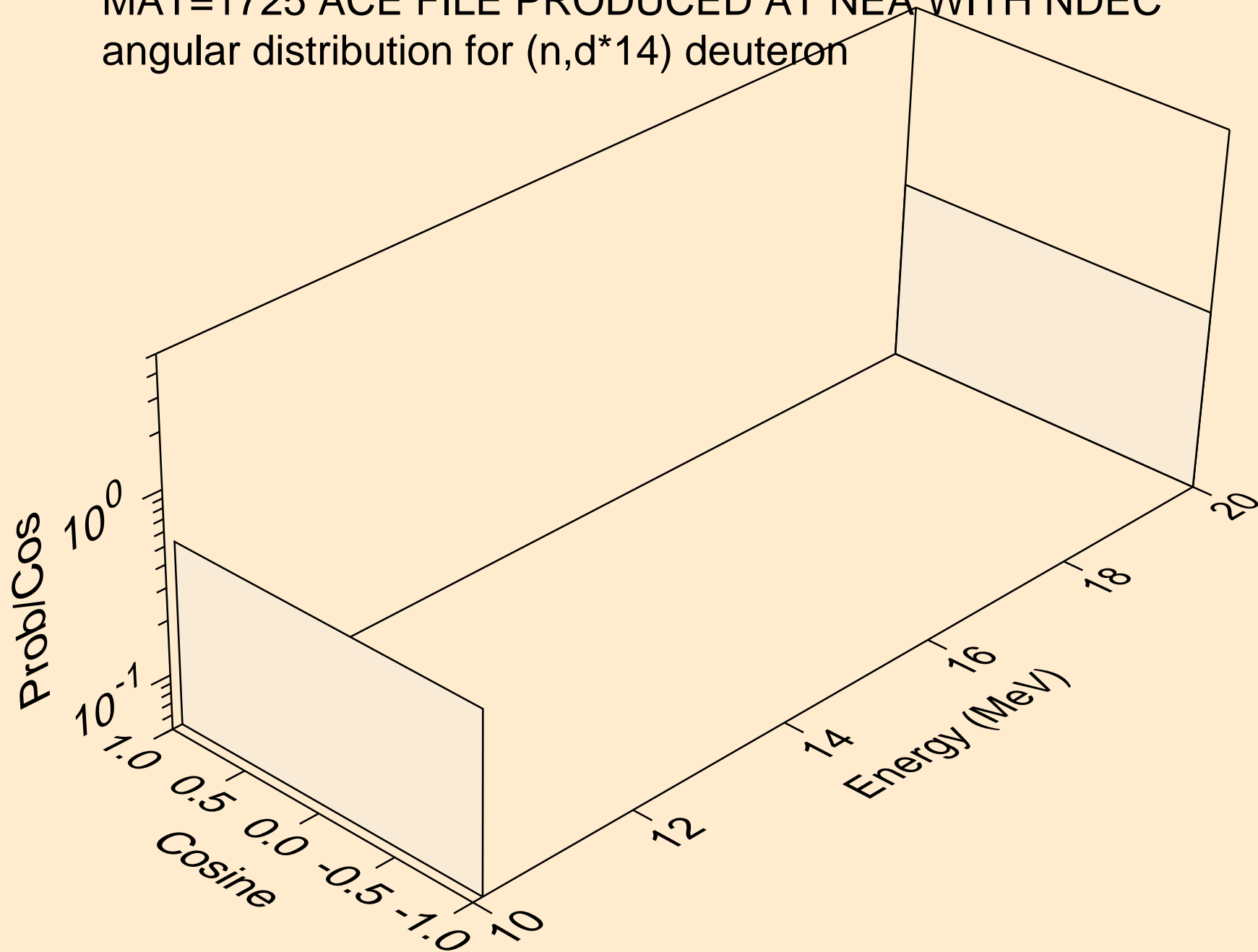

MAT=1725 ACE FILE PRODUCED AT NEA WITH NDEC
angular distribution for (n,d*15) deuteron

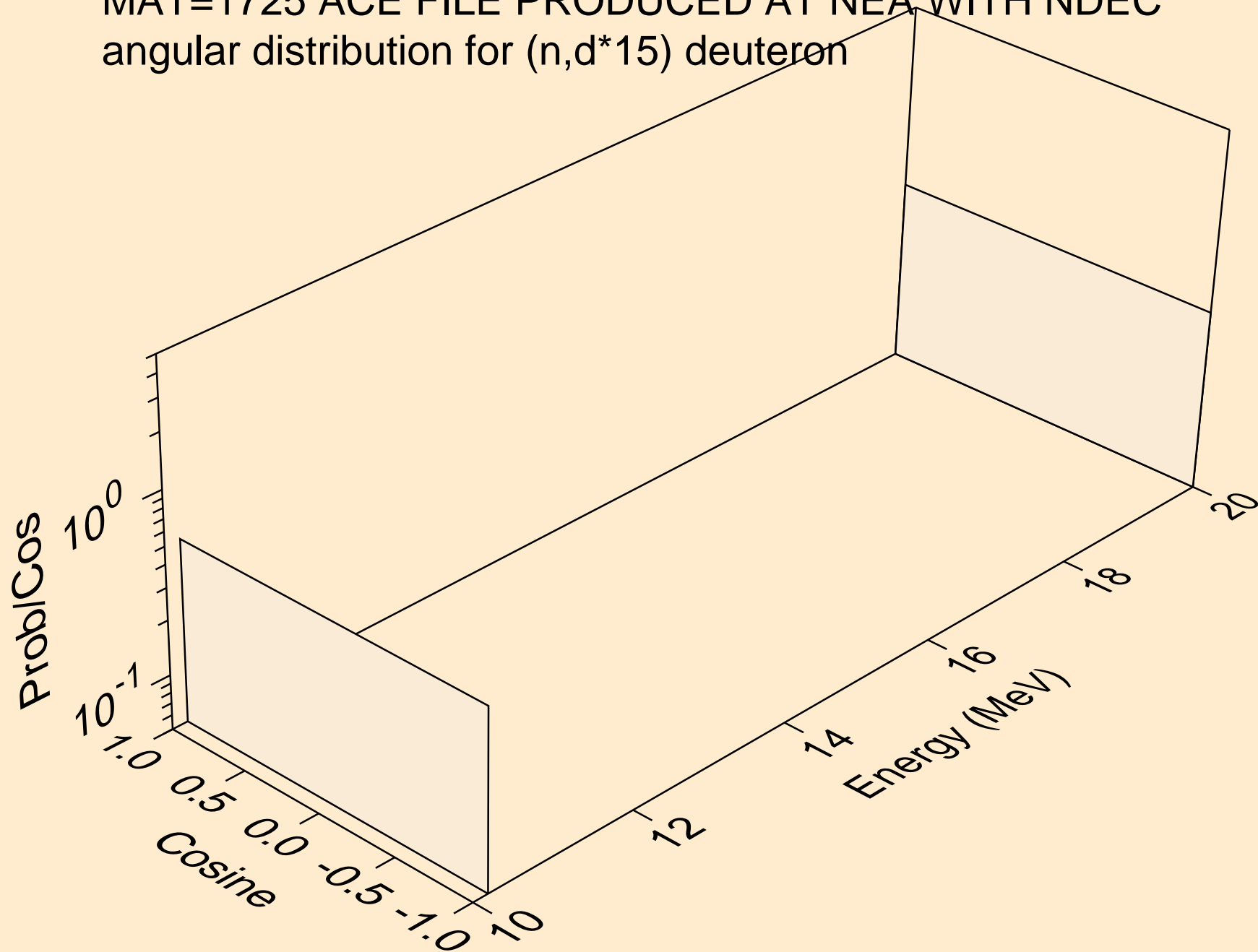

MAT=1725 ACE FILE PRODUCED AT NEA WITH NDEC
angular distribution for (n,d*16) deuteron

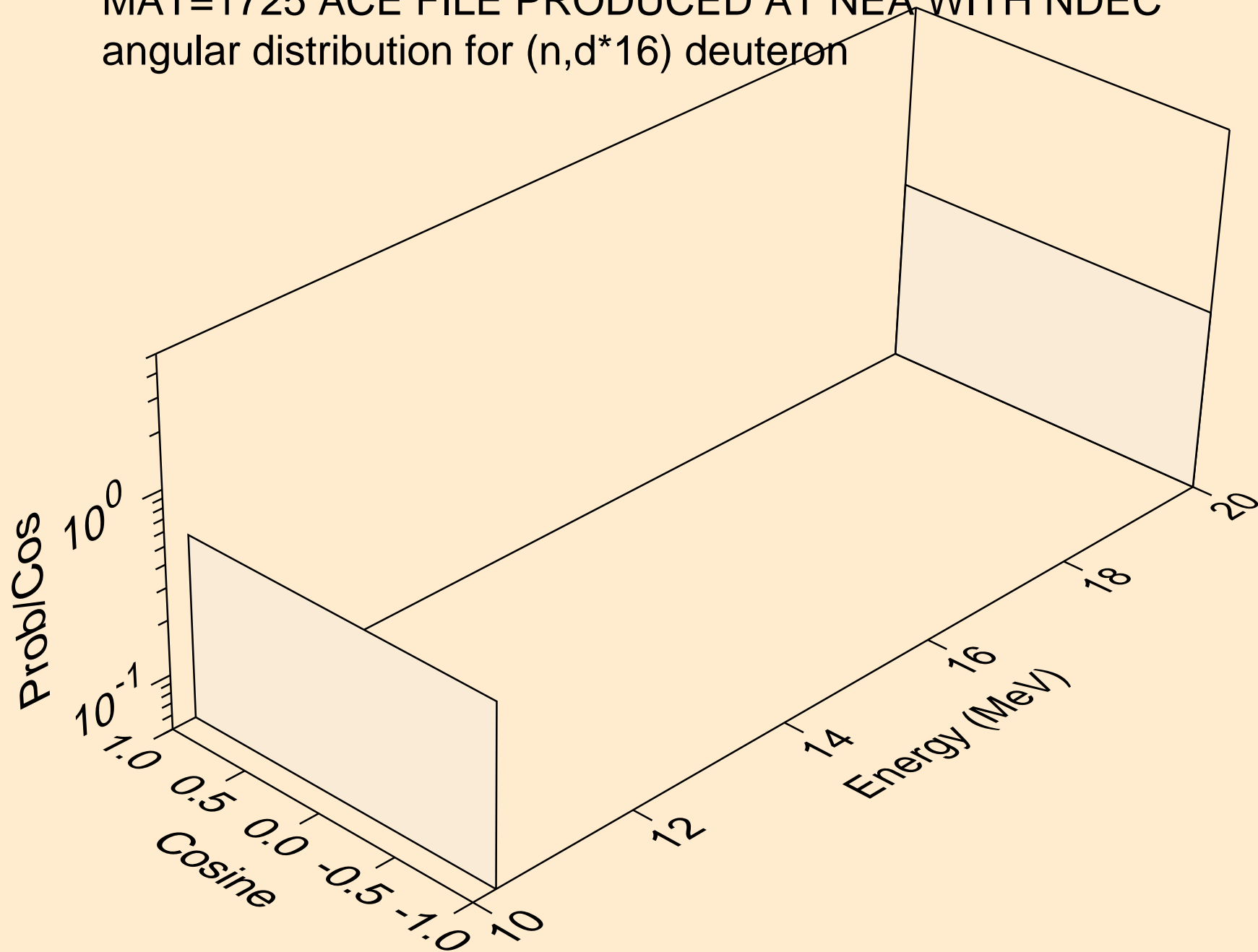

MAT=1725 ACE FILE PRODUCED AT NEA WITH NDEC
angular distribution for (n,d*17) deuteron

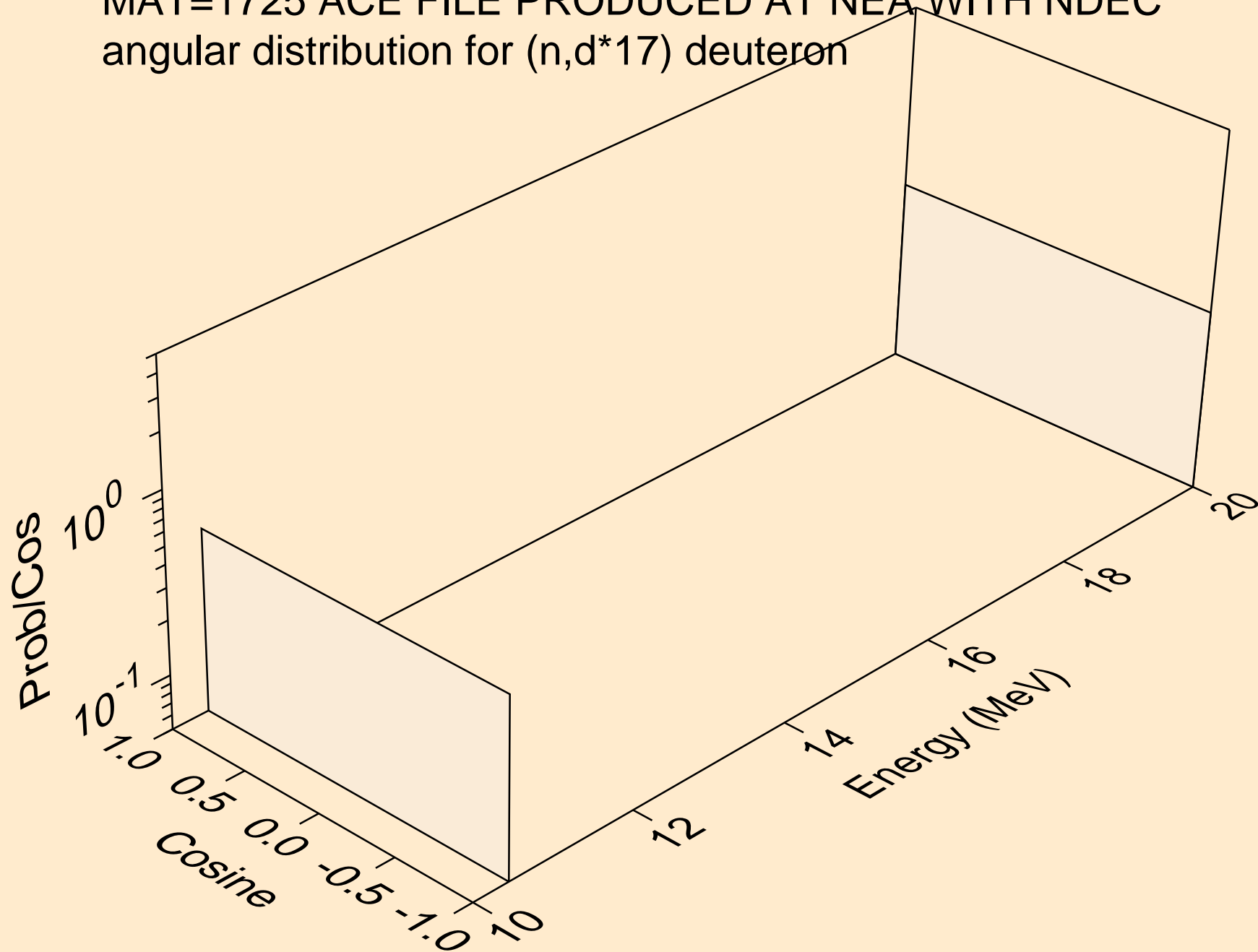

MAT=1725 ACE FILE PRODUCED AT NEA WITH NDEC
angular distribution for (n,d*18) deuteron

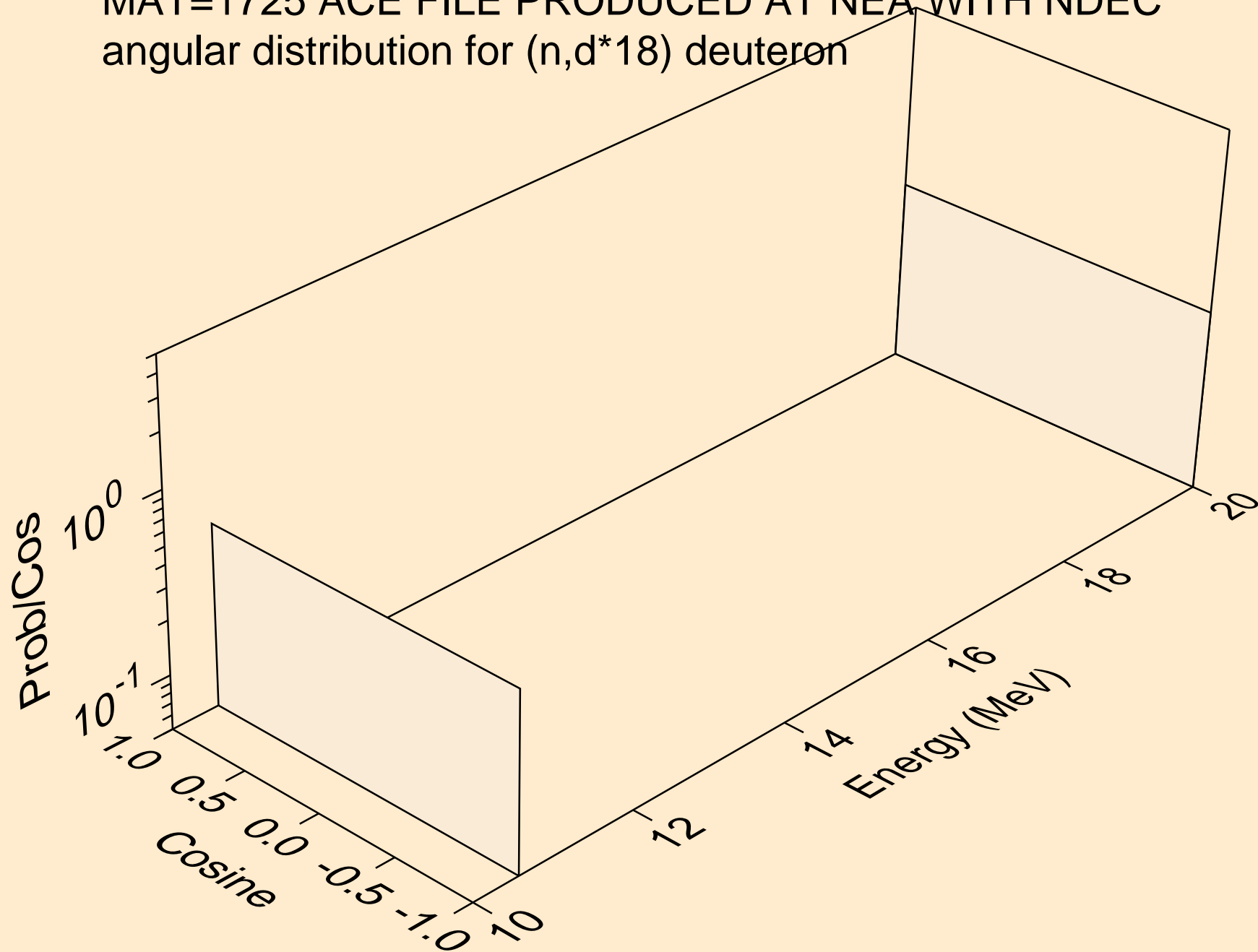

MAT=1725 ACE FILE PRODUCED AT NEA WITH NDEC
angular distribution for (n,d*19) deuteron

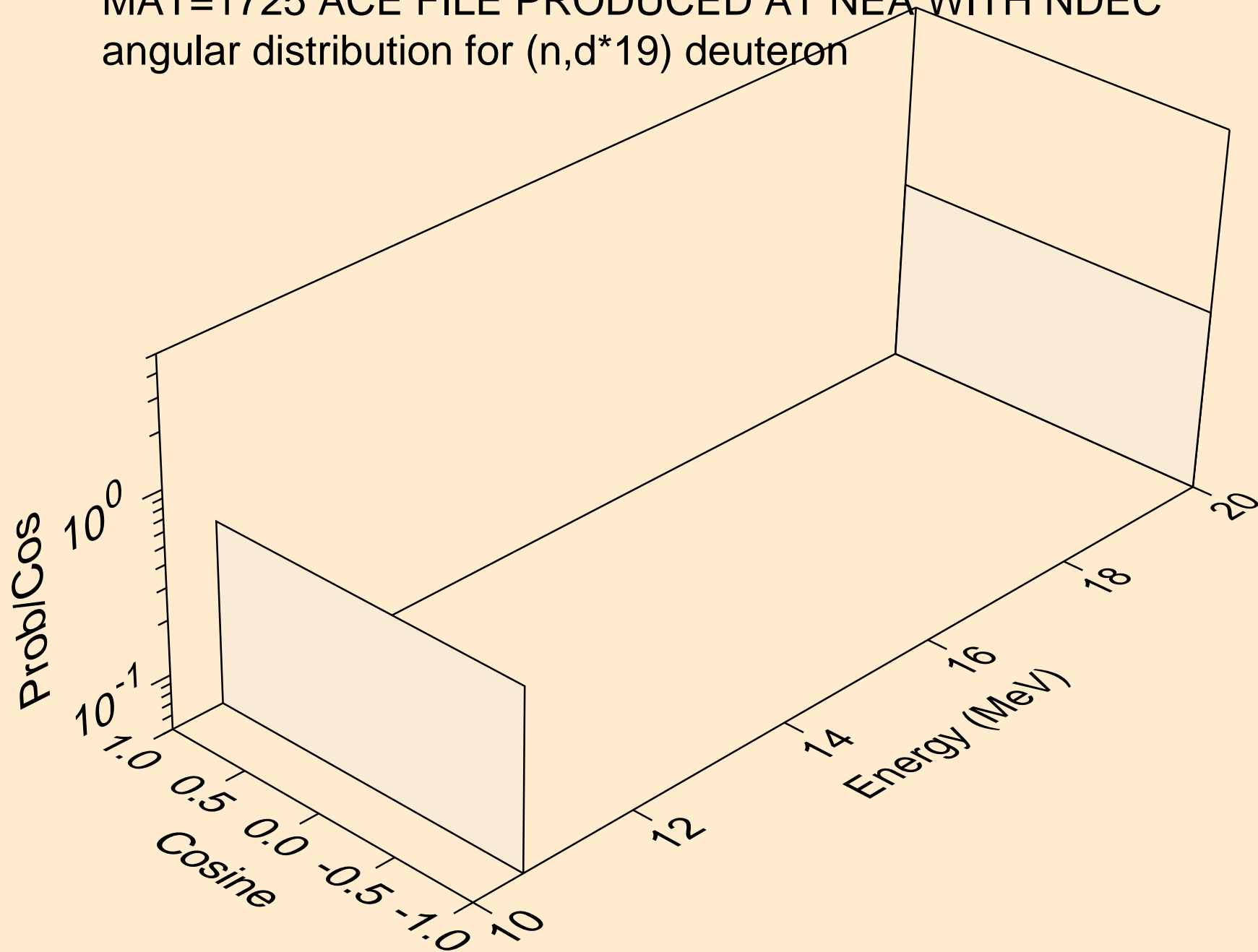

MAT=1725 ACE FILE PRODUCED AT NEA WITH NDEC
angular distribution for (n,d*20) deuteron

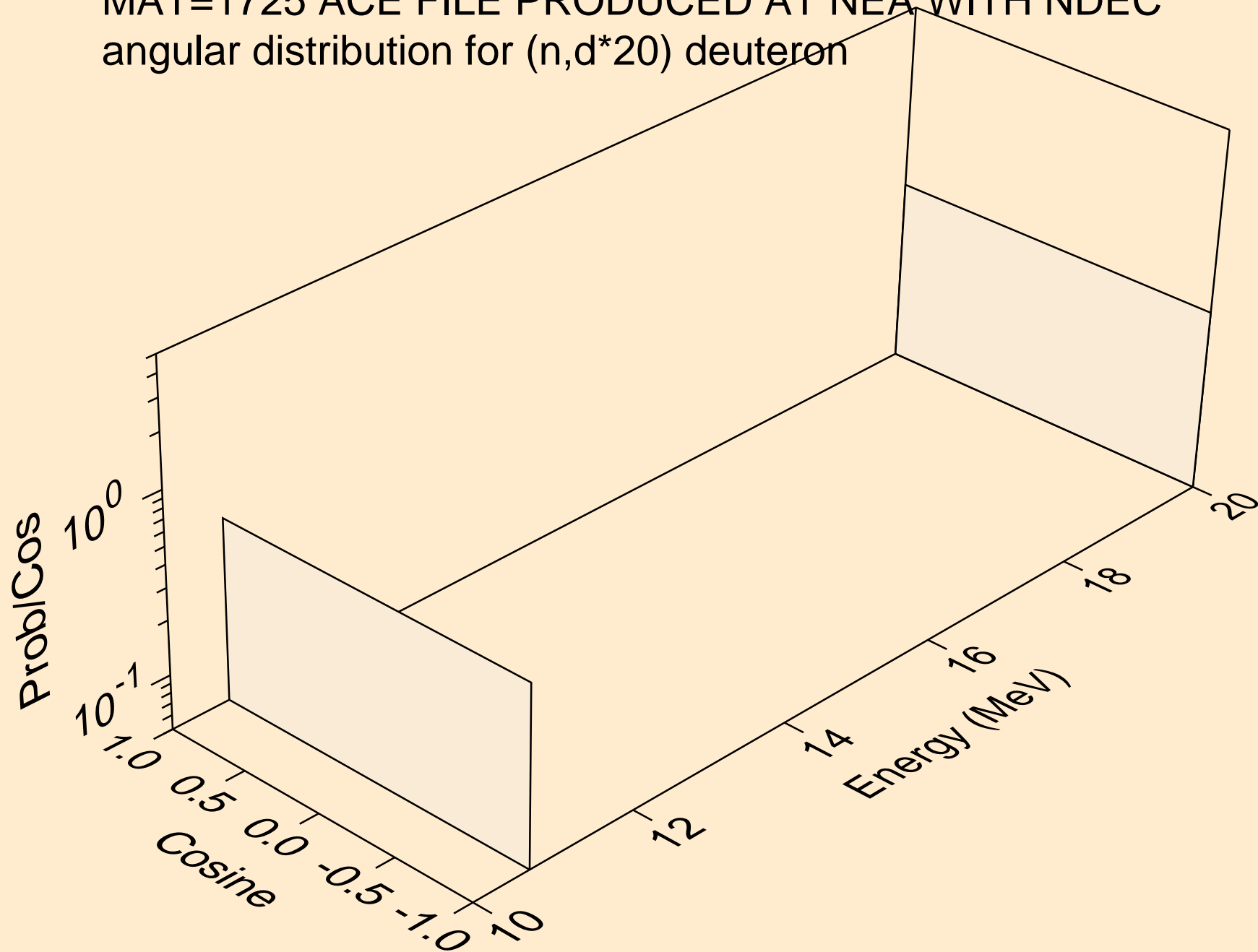

MAT=1725 ACE FILE PRODUCED AT NEA WITH NDEC
angular distribution for (n,d*21) deuteron

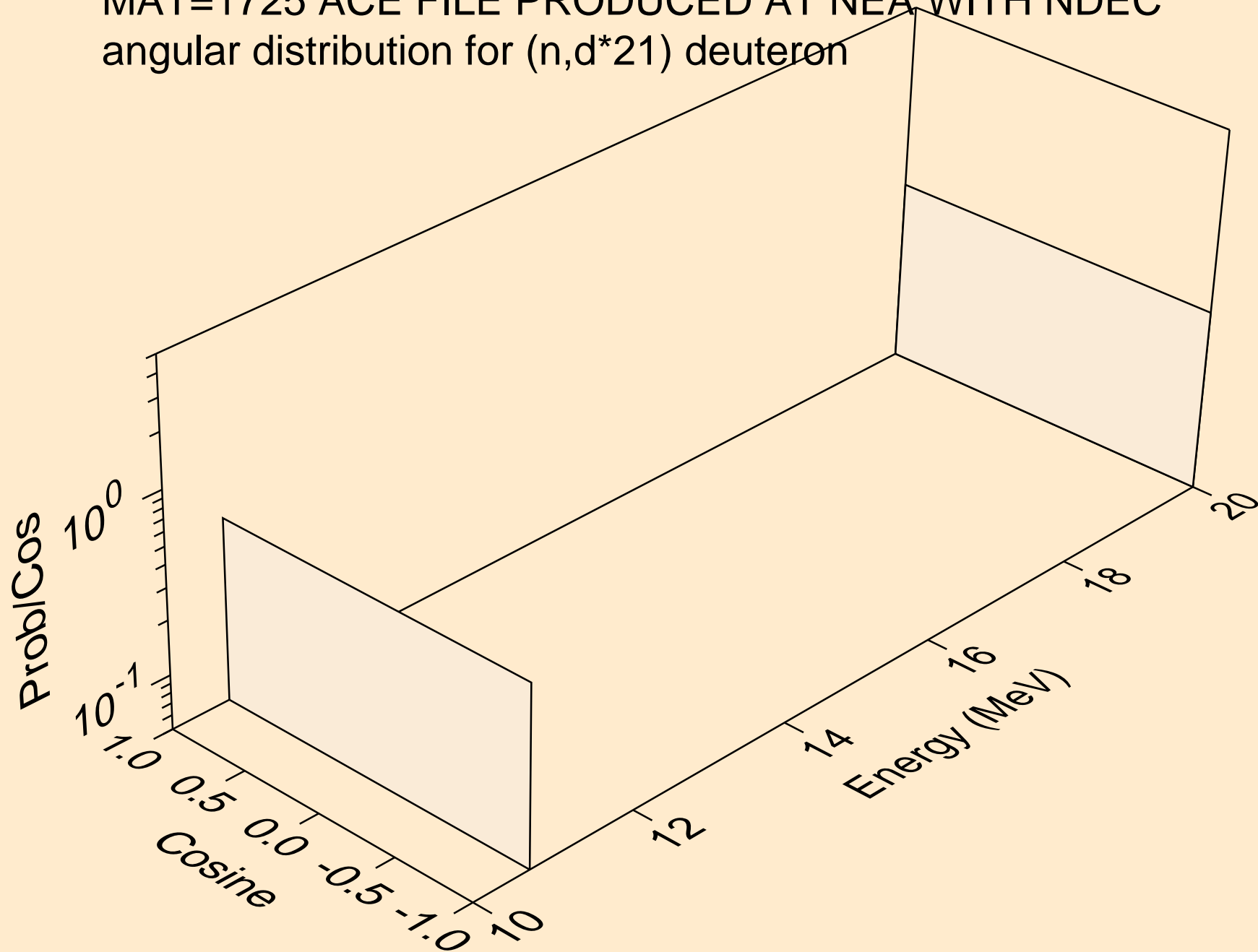

MAT=1725 ACE FILE PRODUCED AT NEA WITH NDEC
angular distribution for (n,d*22) deuteron

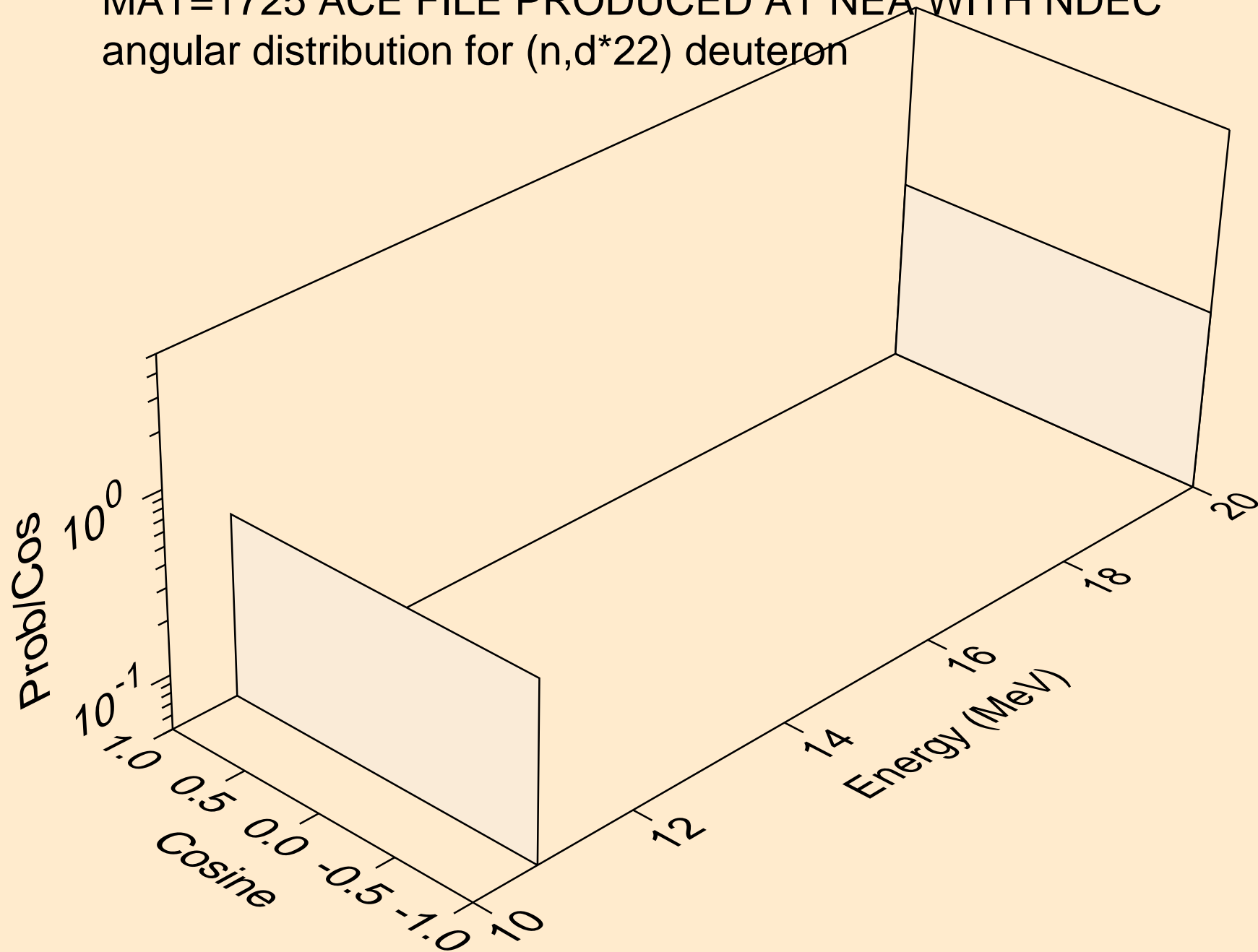

MAT=1725 ACE FILE PRODUCED AT NEA WITH NDEC
angular distribution for (n,d*23) deuteron

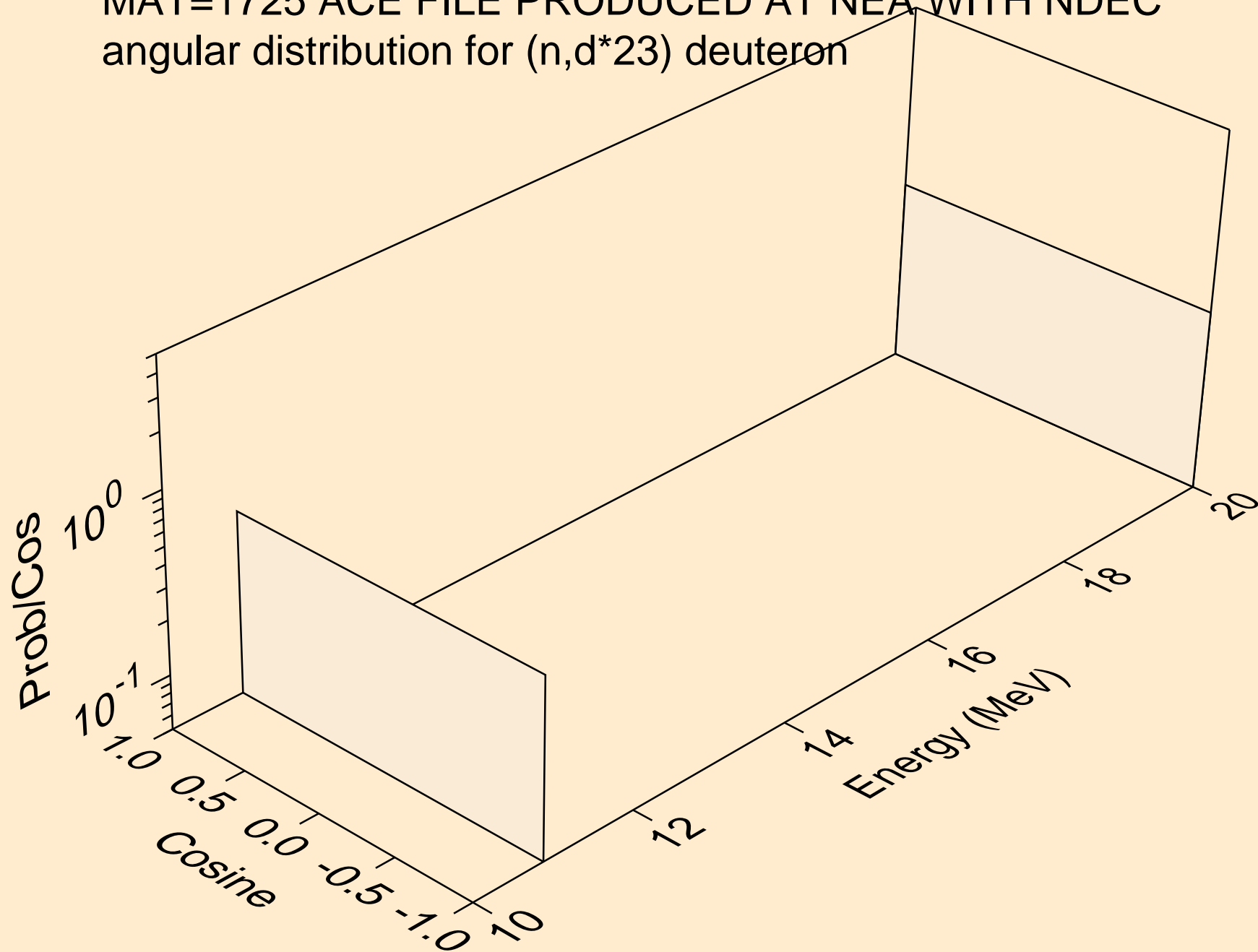

MAT=1725 ACE FILE PRODUCED AT NEA WITH NDEC
angular distribution for (n,d*24) deuteron

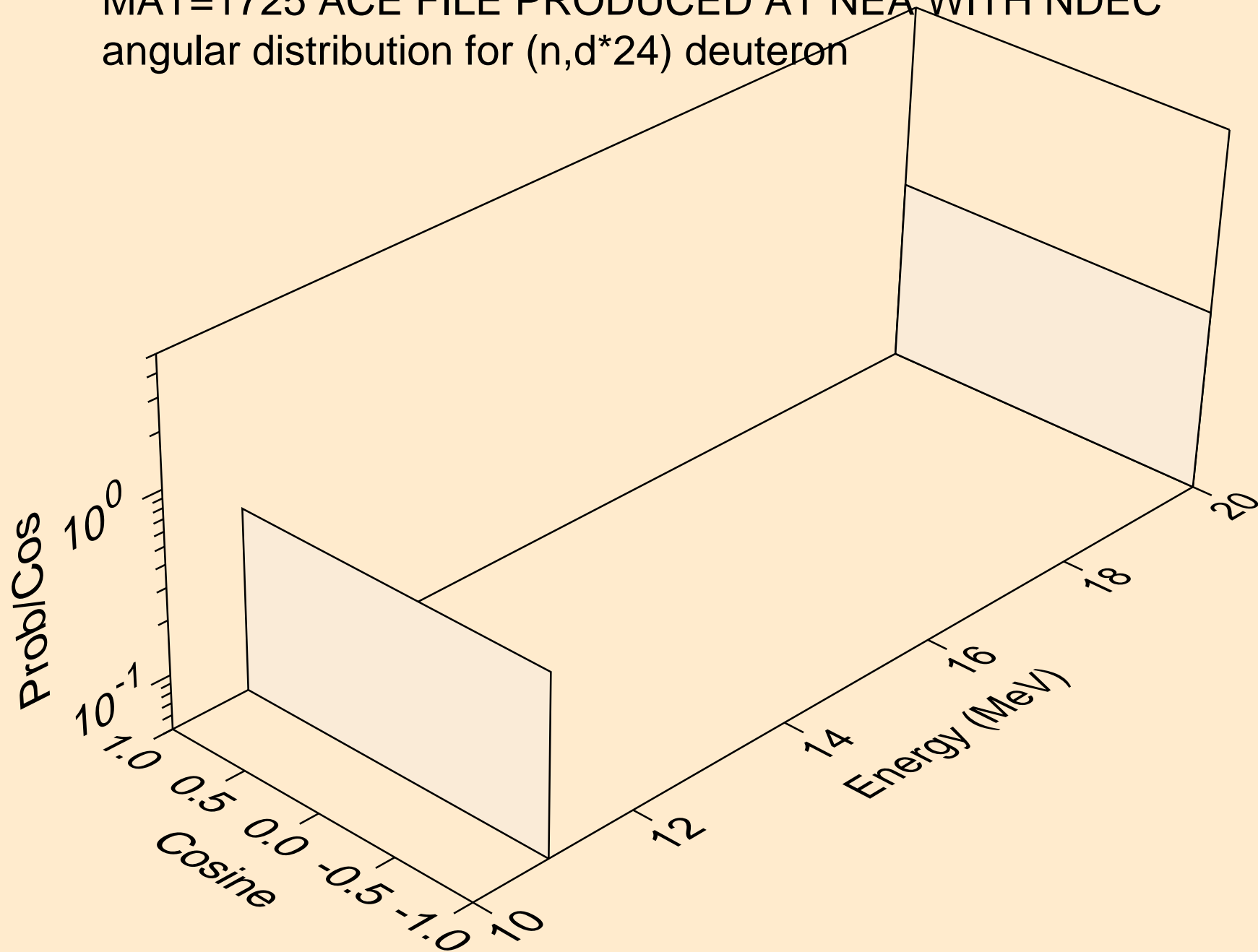

MAT=1725 ACE FILE PRODUCED AT NEA WITH NDEC
angular distribution for (n,d*25) deuteron

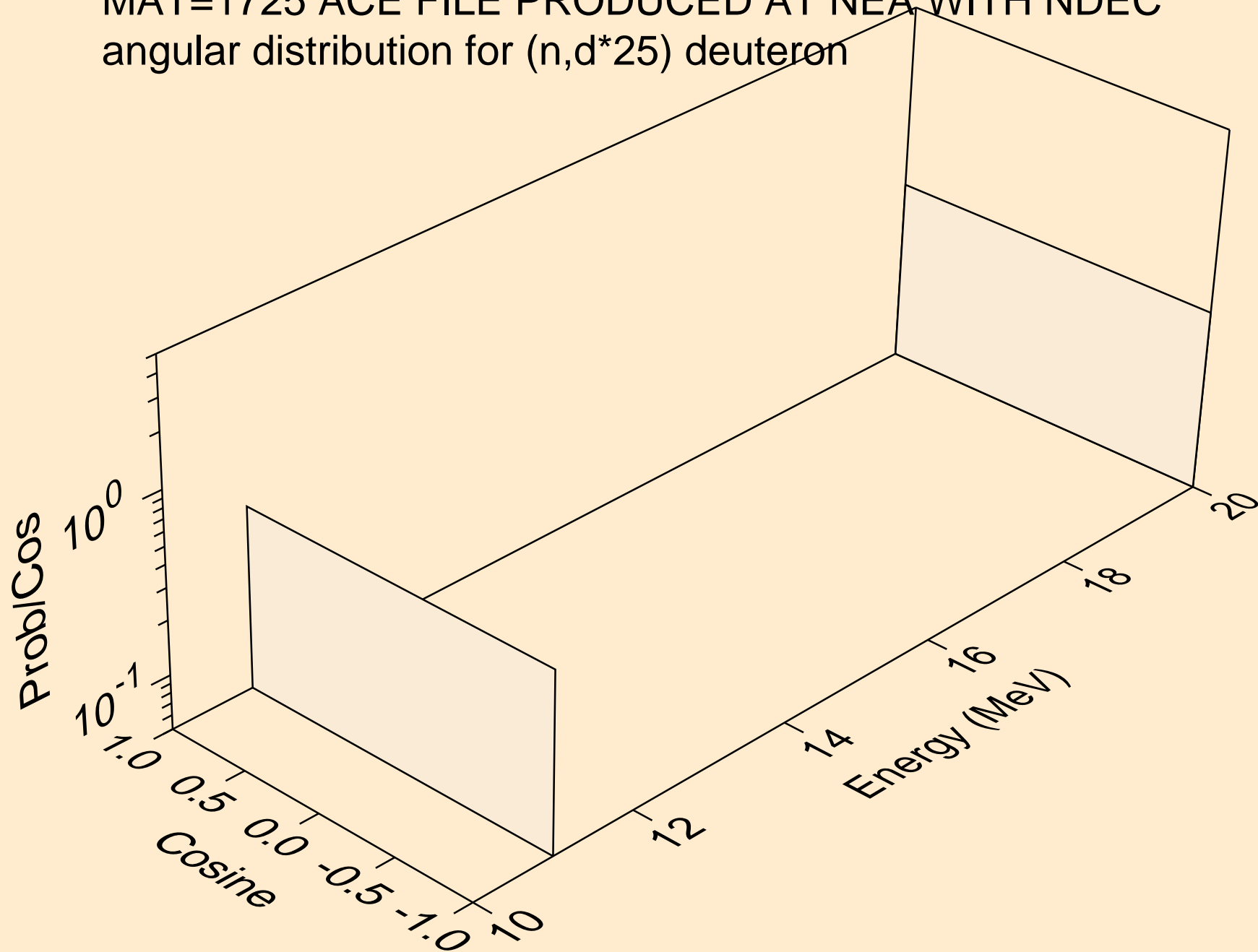

MAT=1725 ACE FILE PRODUCED AT NEA WITH NDEC
angular distribution for (n,d*26) deuteron

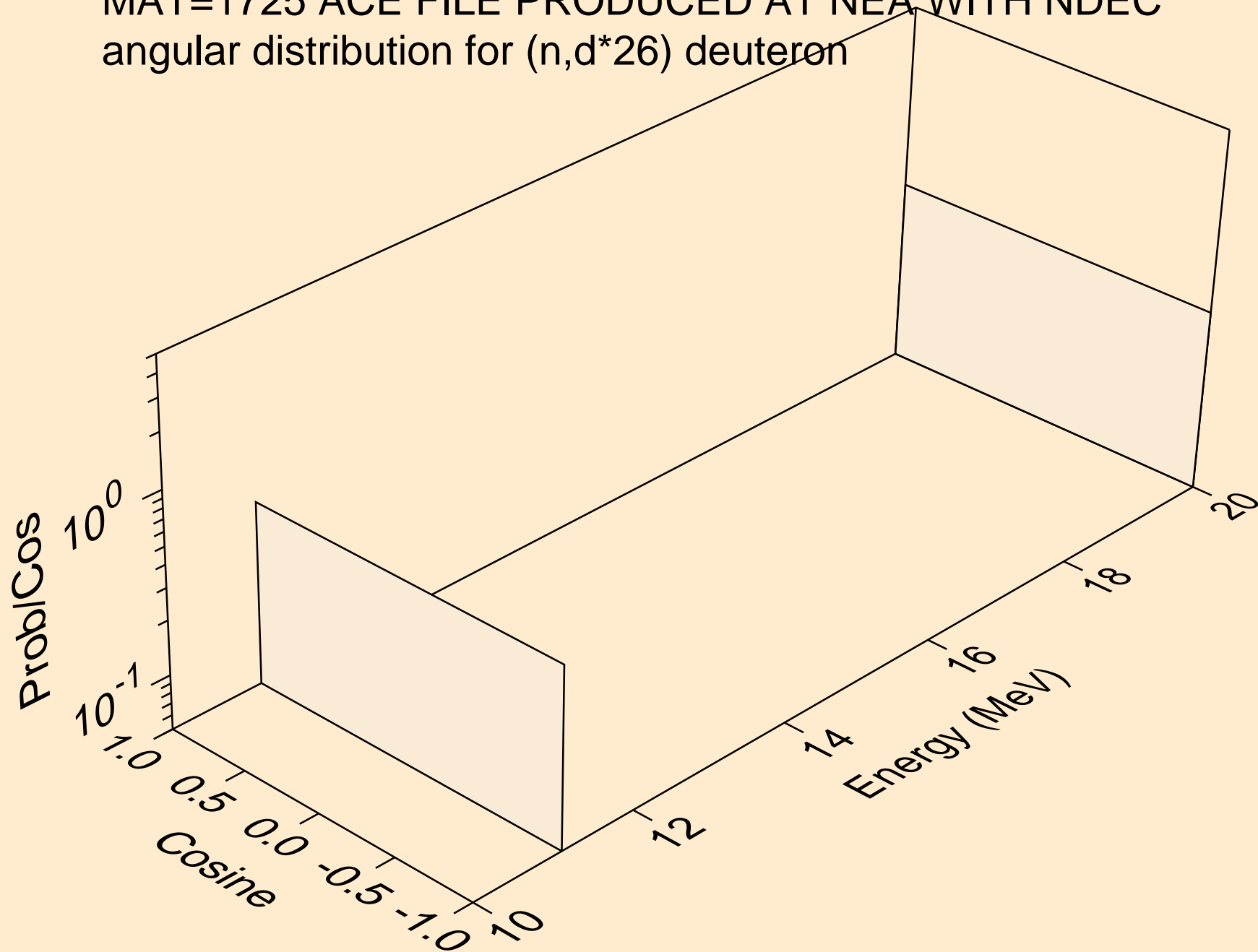

MAT=1725 ACE FILE PRODUCED AT NEA WITH NDEC
angular distribution for (n,d*27) deuteron

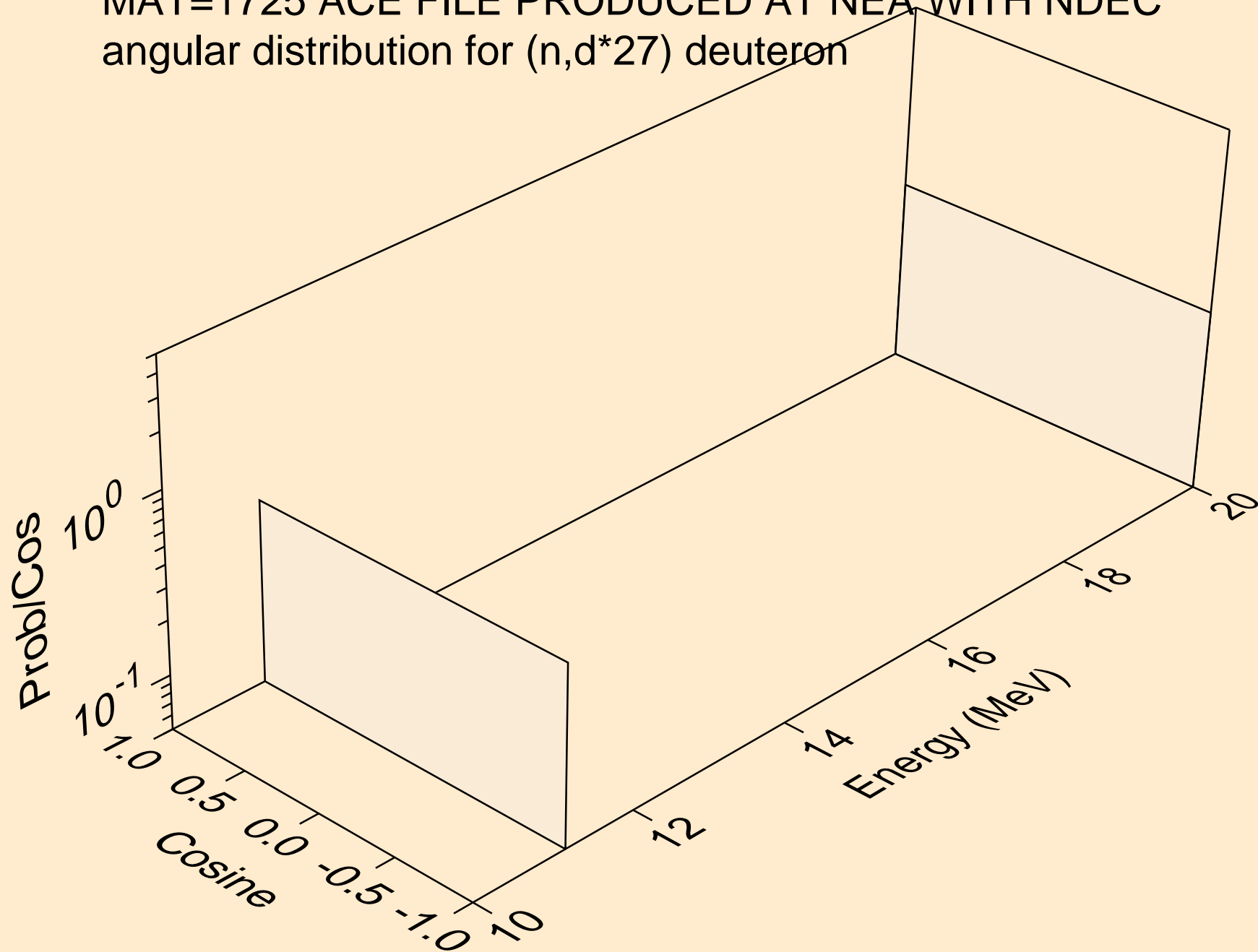

MAT=1725 ACE FILE PRODUCED AT NEA WITH NDEC
angular distribution for (n,d*28) deuteron

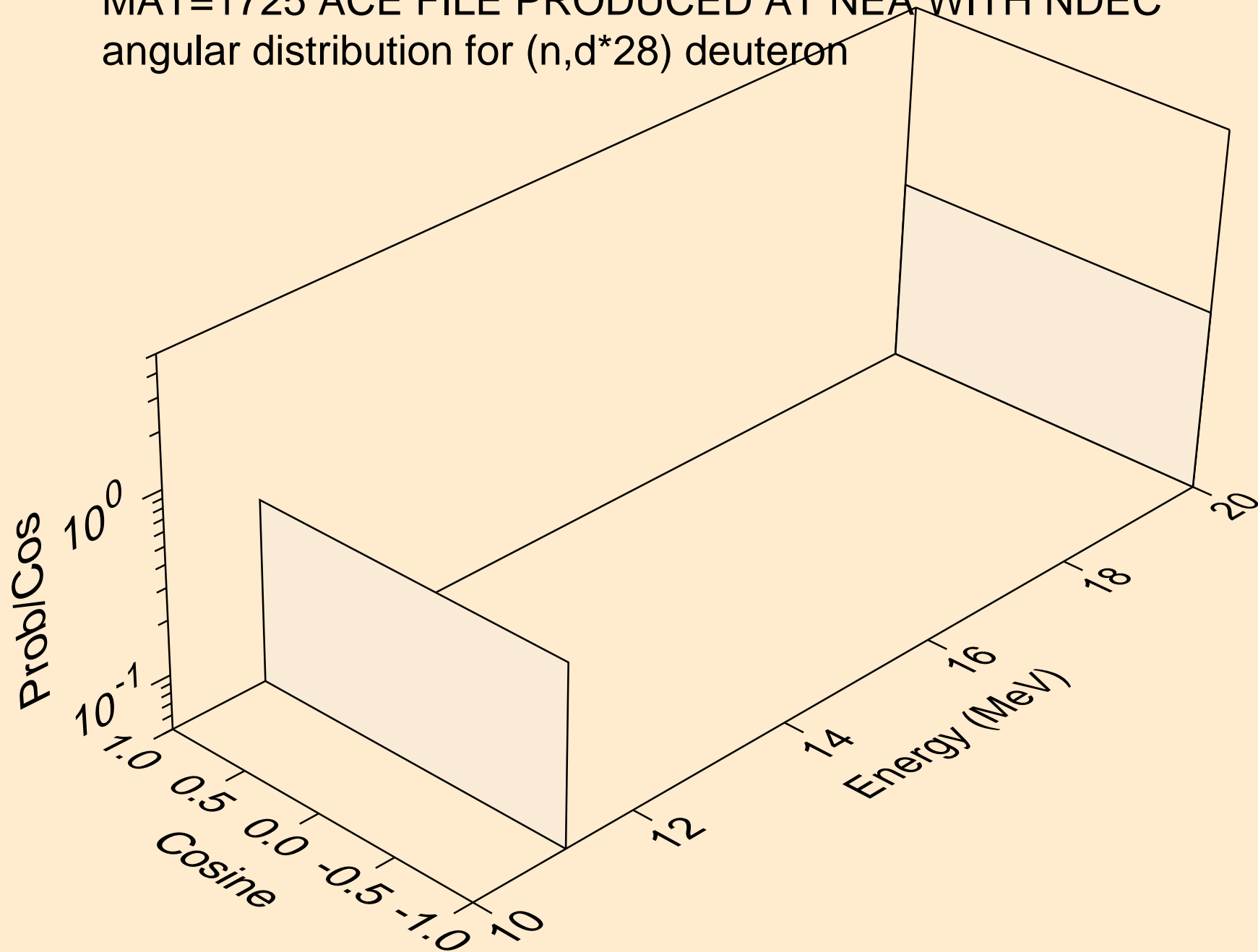

MAT=1725 ACE FILE PRODUCED AT NEA WITH NDEC
angular distribution for (n,d*29) deuteron

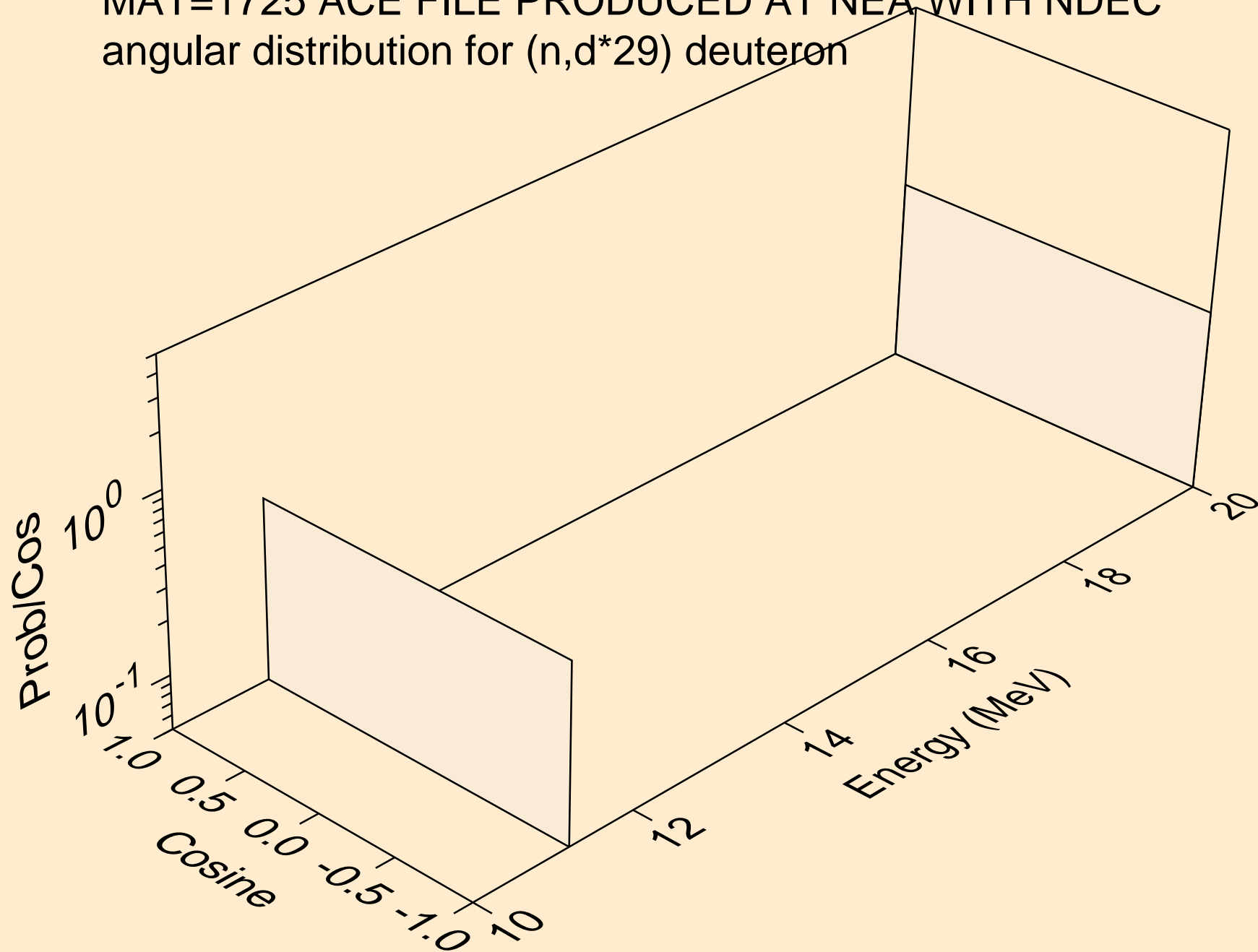

MAT=1725 ACE FILE PRODUCED AT NEA WITH NDEC
angular distribution for (n,d*30) deuteron

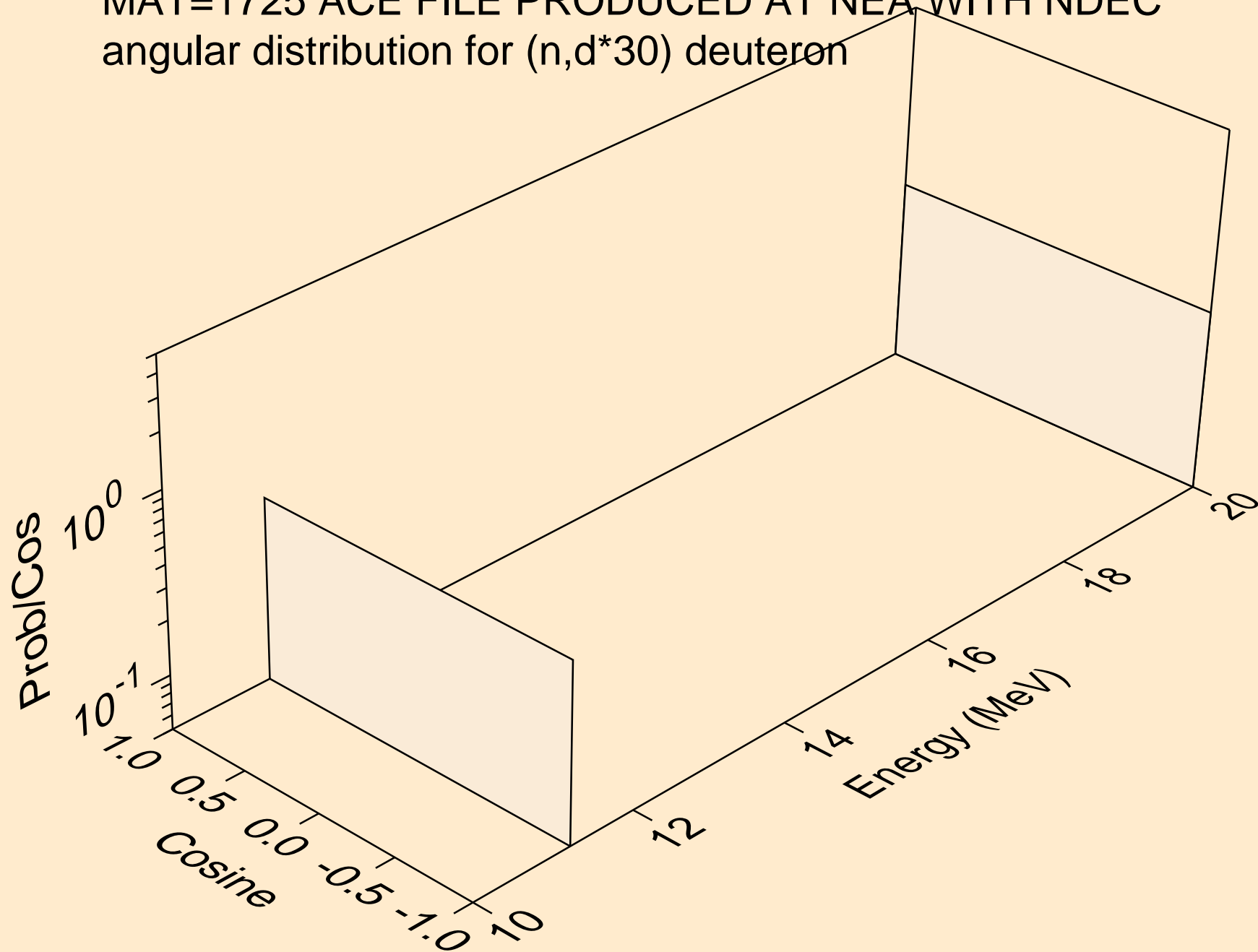

MAT=1725 ACE FILE PRODUCED AT NEA WITH NDEC
deuterons from (n,d*c)

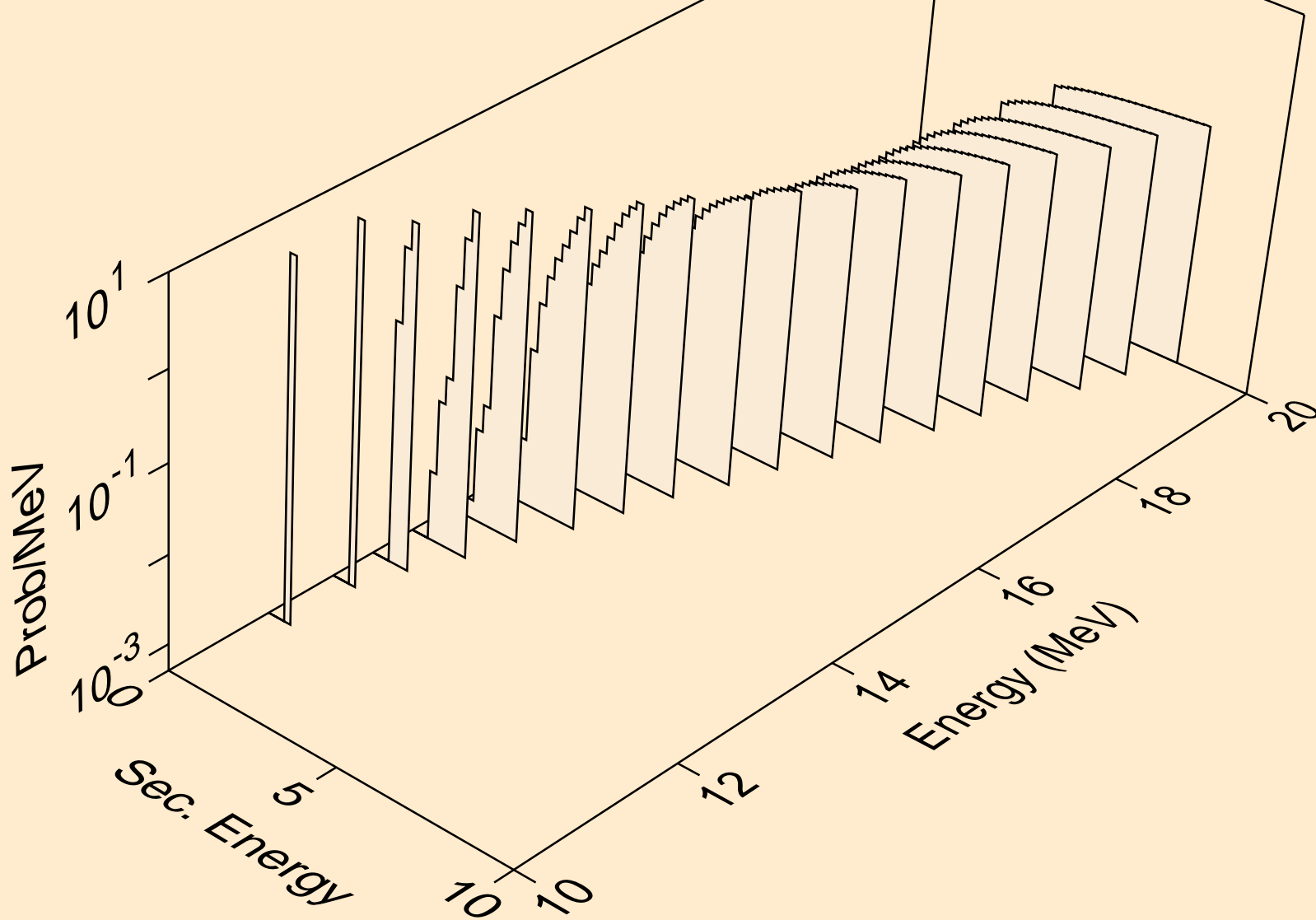

MAT=1725 ACE FILE PRODUCED AT NEA WITH NDEC
angular distribution for (n,t*0) triton

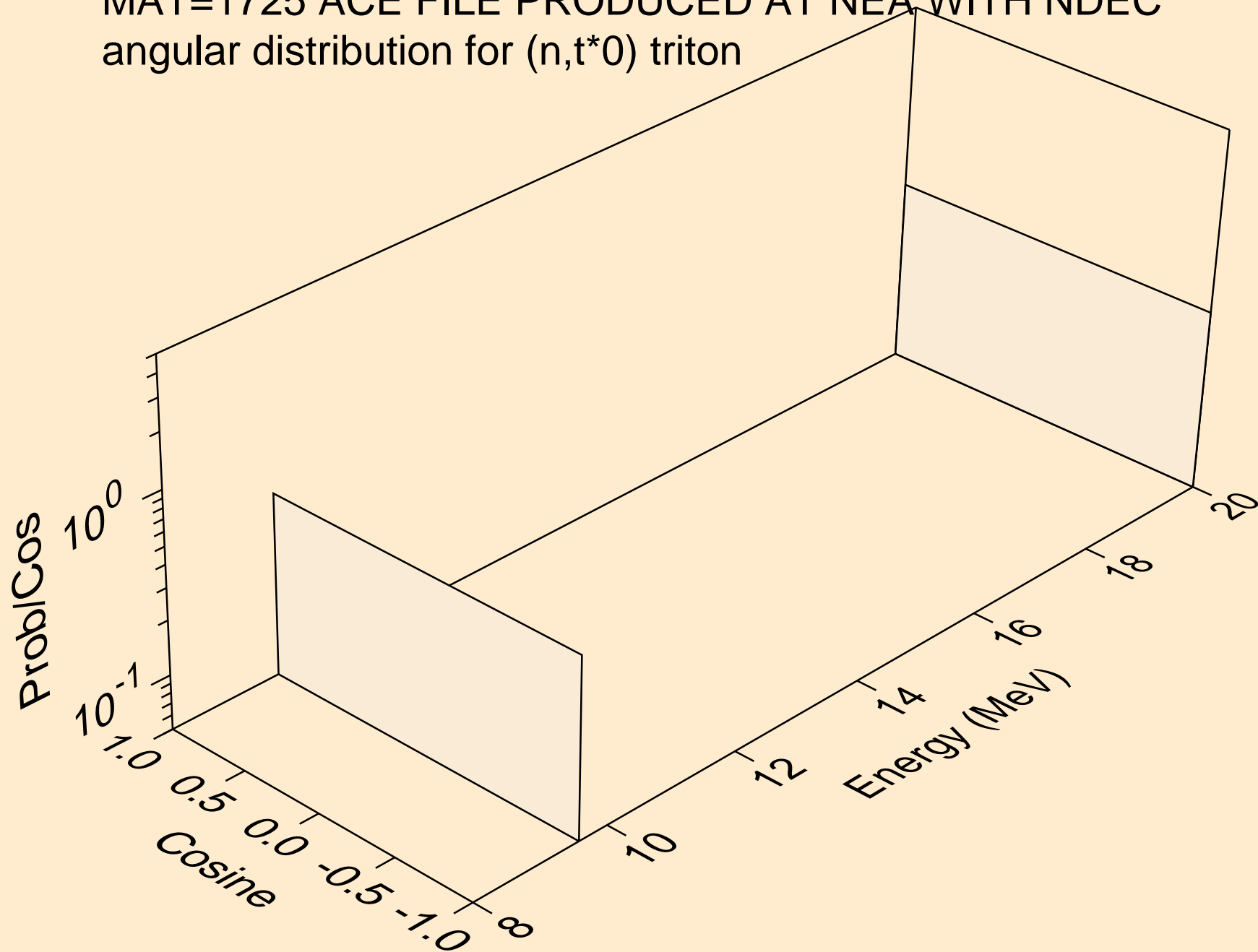

MAT=1725 ACE FILE PRODUCED AT NEA WITH NDEC
angular distribution for (n,t*1) triton

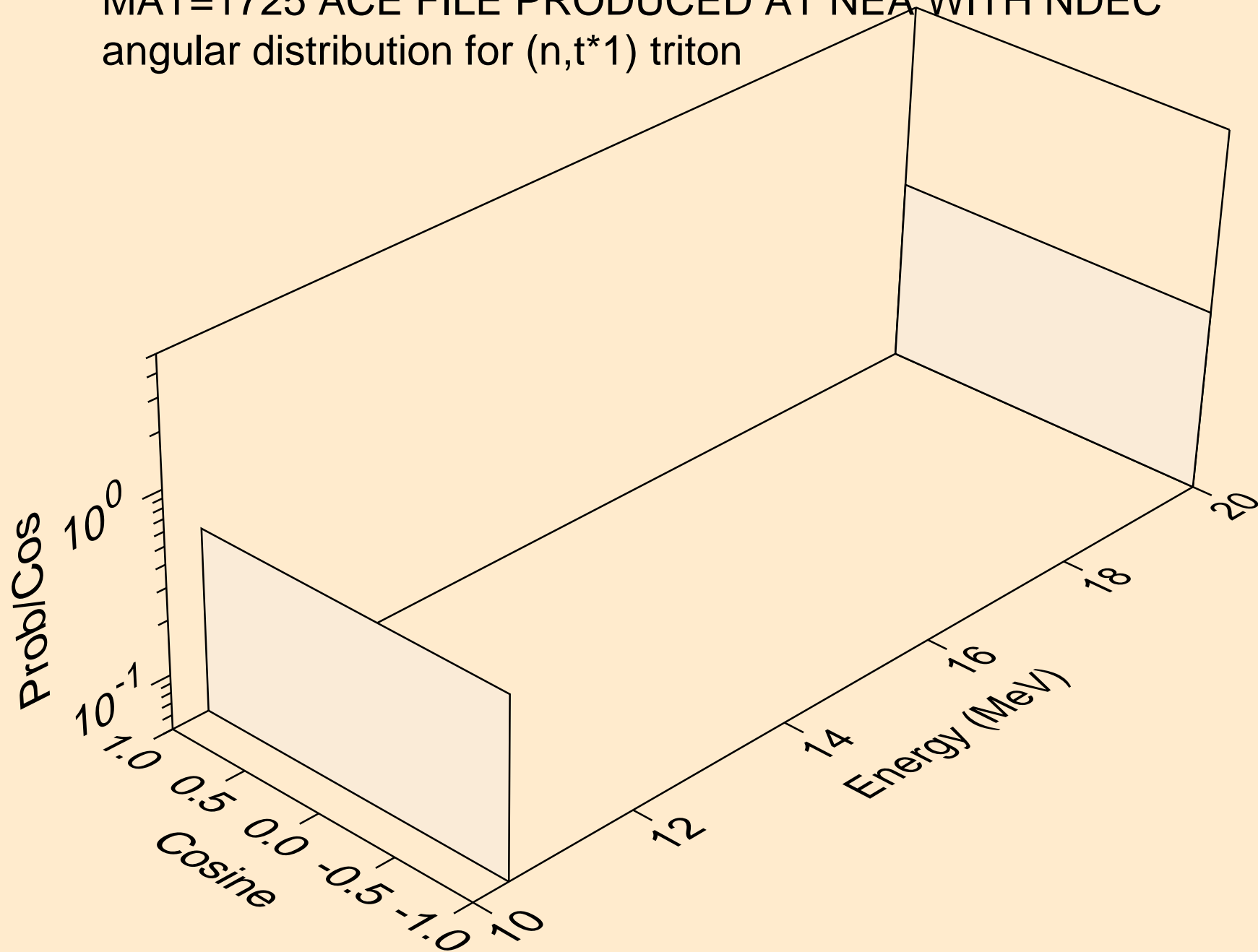

MAT=1725 ACE FILE PRODUCED AT NEA WITH NDEC
angular distribution for (n,t*2) triton

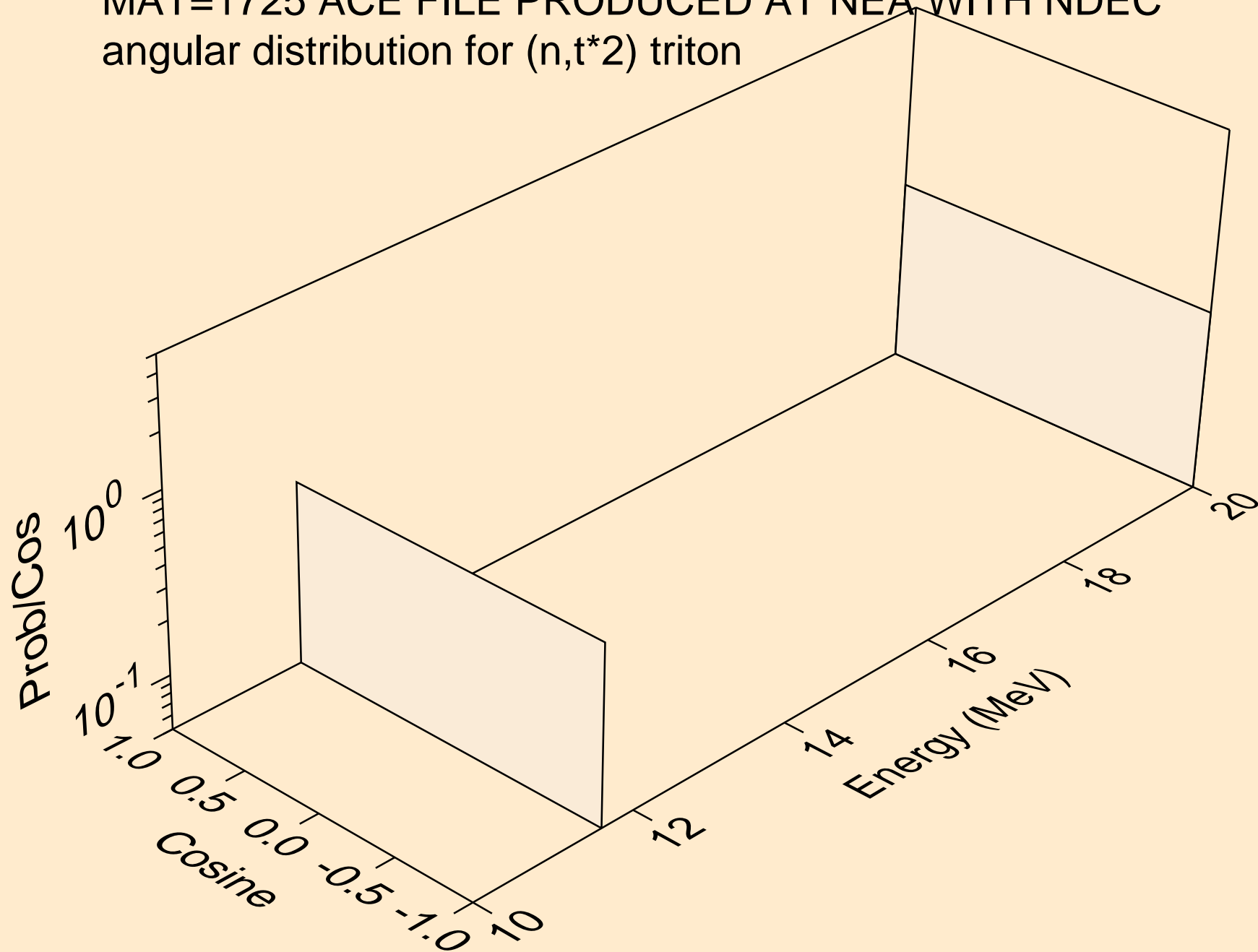

MAT=1725 ACE FILE PRODUCED AT NEA WITH NDEC
angular distribution for (n,t*3) triton

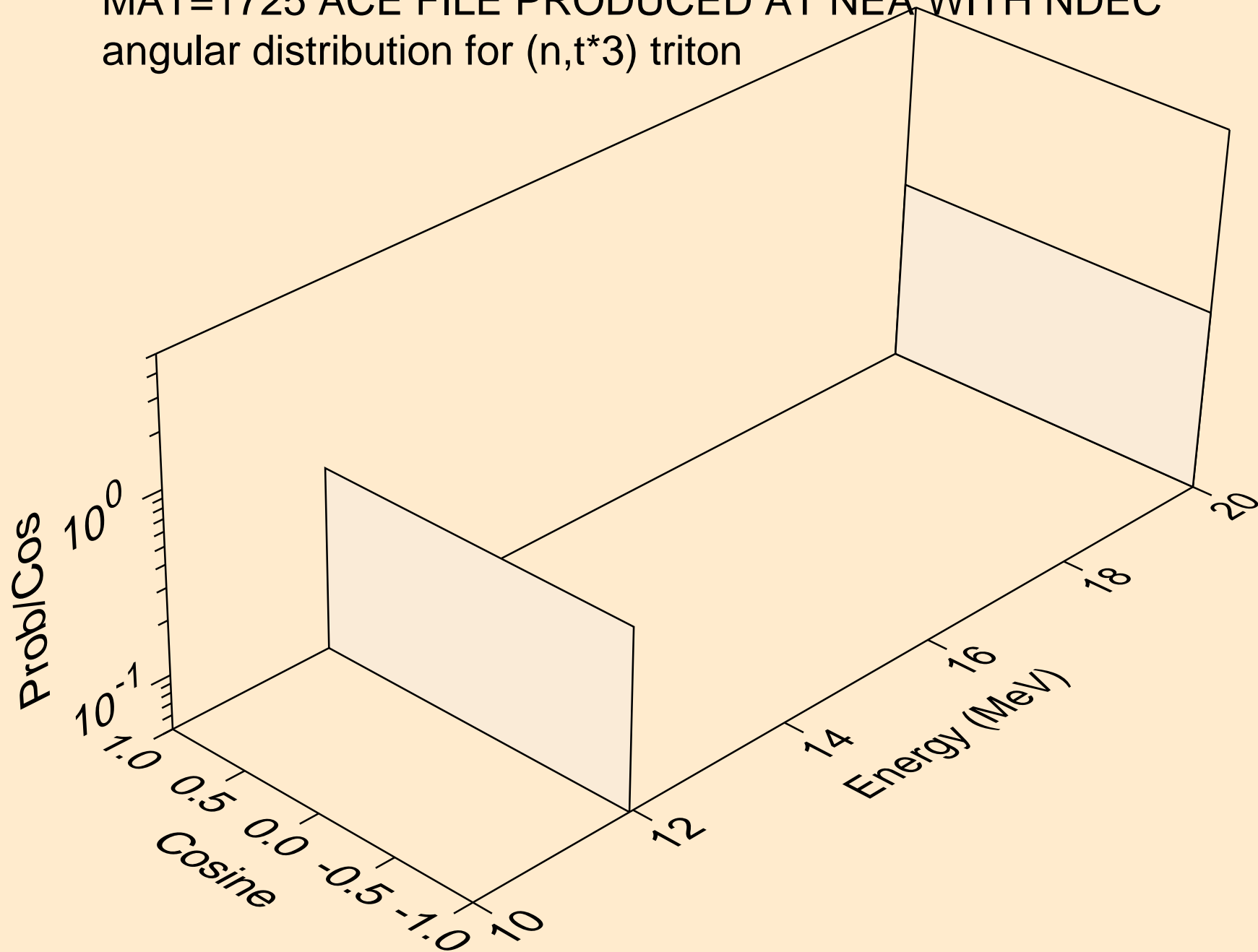

MAT=1725 ACE FILE PRODUCED AT NEA WITH NDEC
angular distribution for (n,t*4) triton

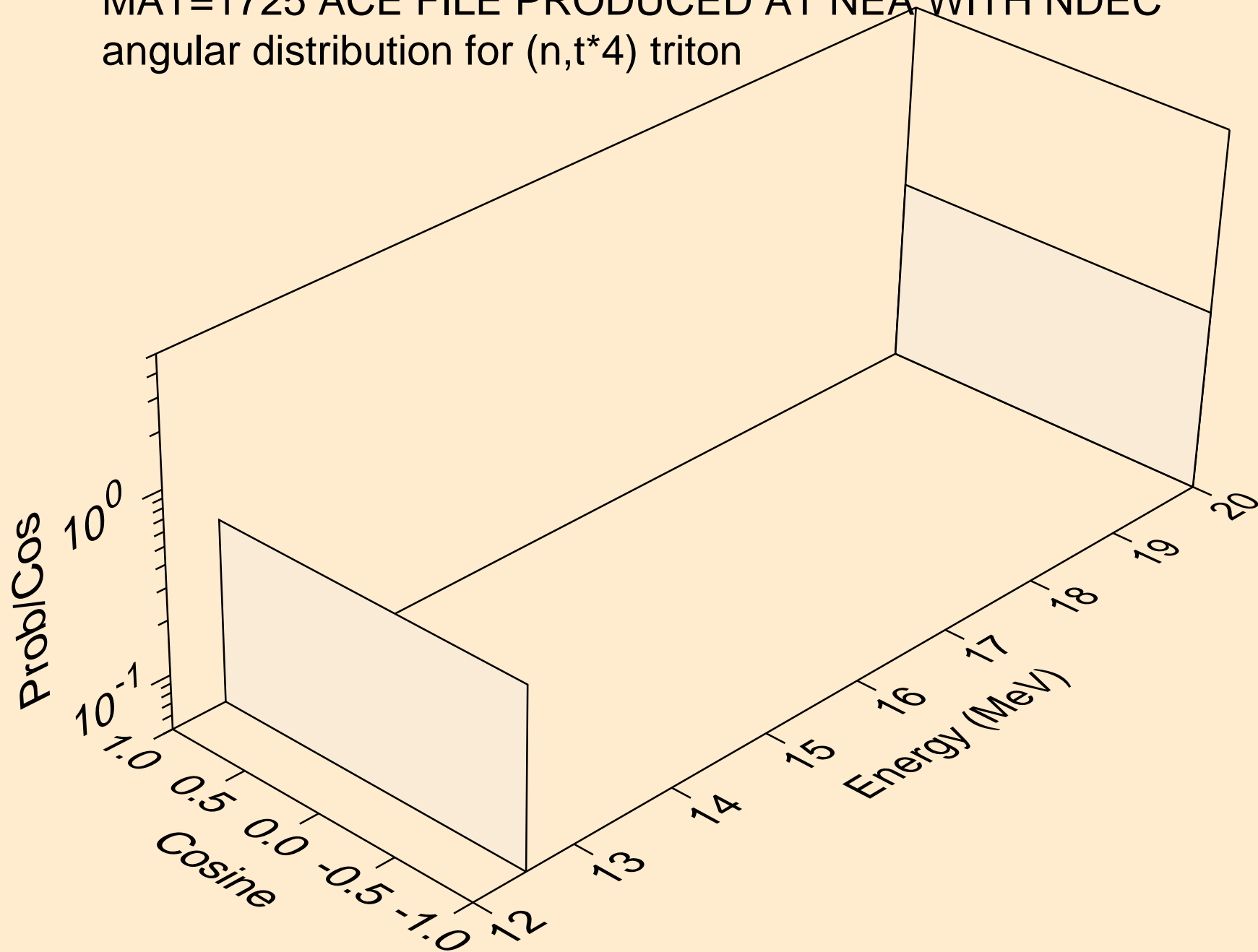

MAT=1725 ACE FILE PRODUCED AT NEA WITH NDEC
angular distribution for (n,t*5) triton

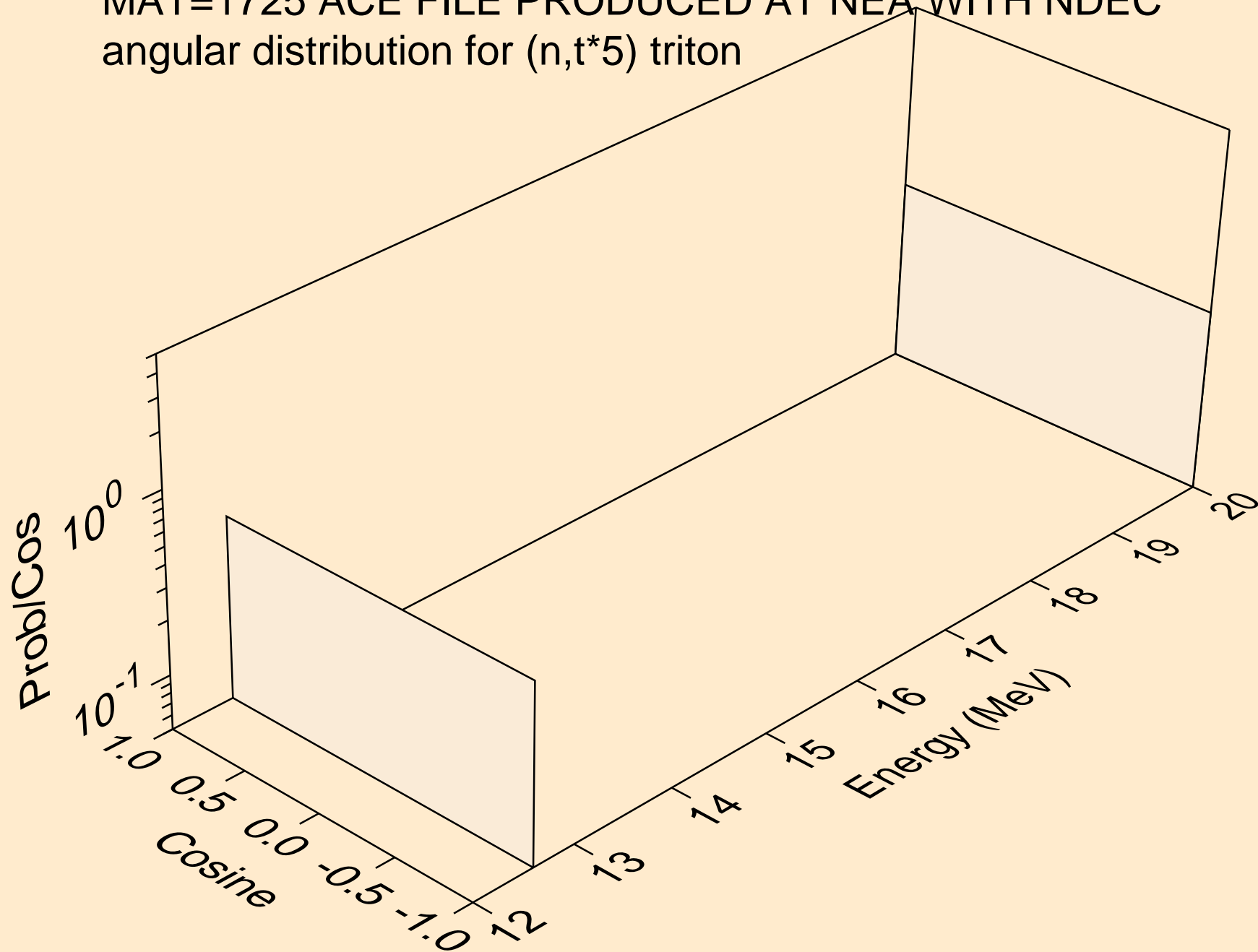

MAT=1725 ACE FILE PRODUCED AT NEA WITH NDEC
angular distribution for (n,t*6) triton

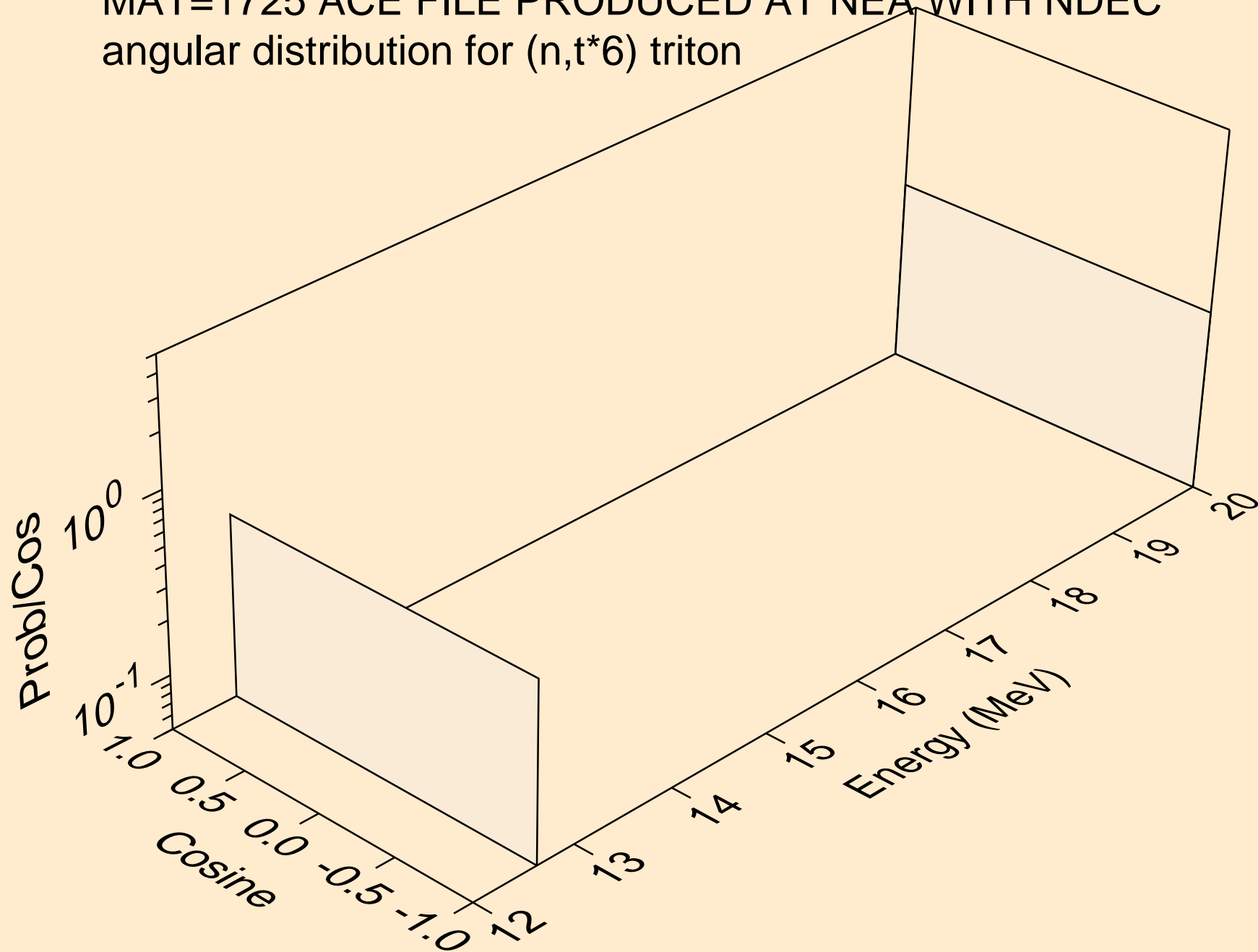

MAT=1725 ACE FILE PRODUCED AT NEA WITH NDEC
angular distribution for (n,t*7) triton

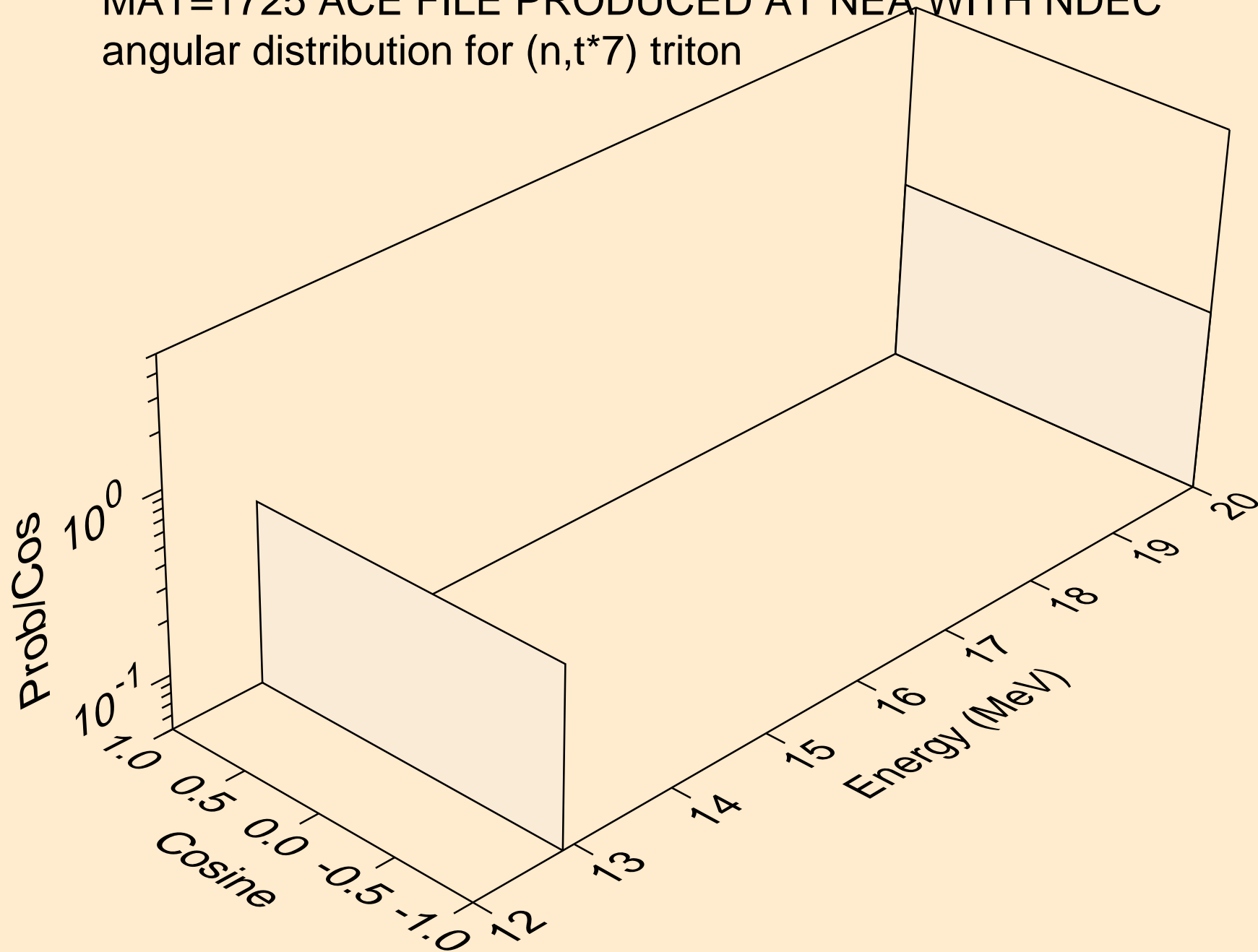

MAT=1725 ACE FILE PRODUCED AT NEA WITH NDEC
angular distribution for (n,t*8) triton

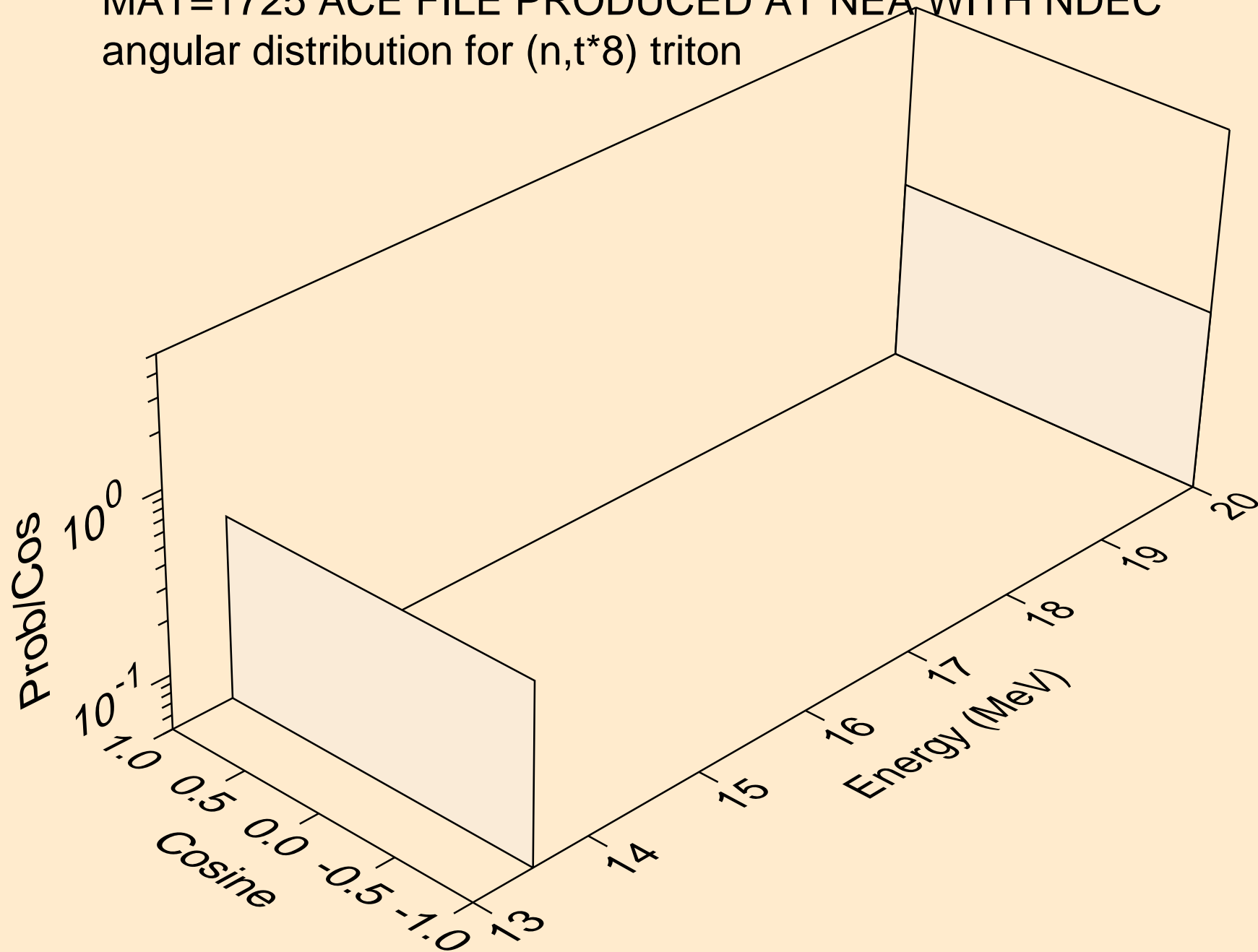

MAT=1725 ACE FILE PRODUCED AT NEA WITH NDEC
angular distribution for (n,t*9) triton

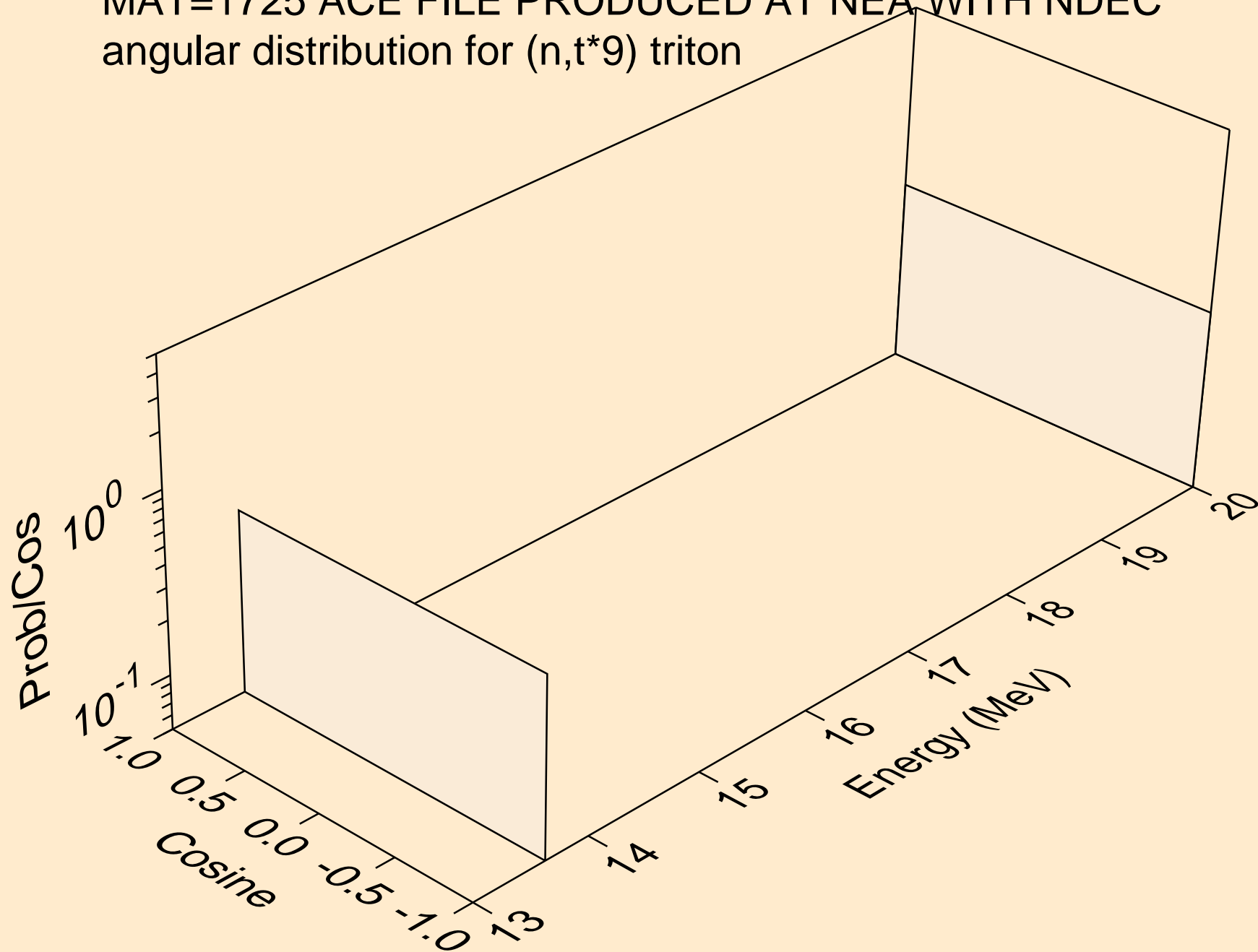

MAT=1725 ACE FILE PRODUCED AT NEA WITH NDEC
angular distribution for (n,t*10) triton

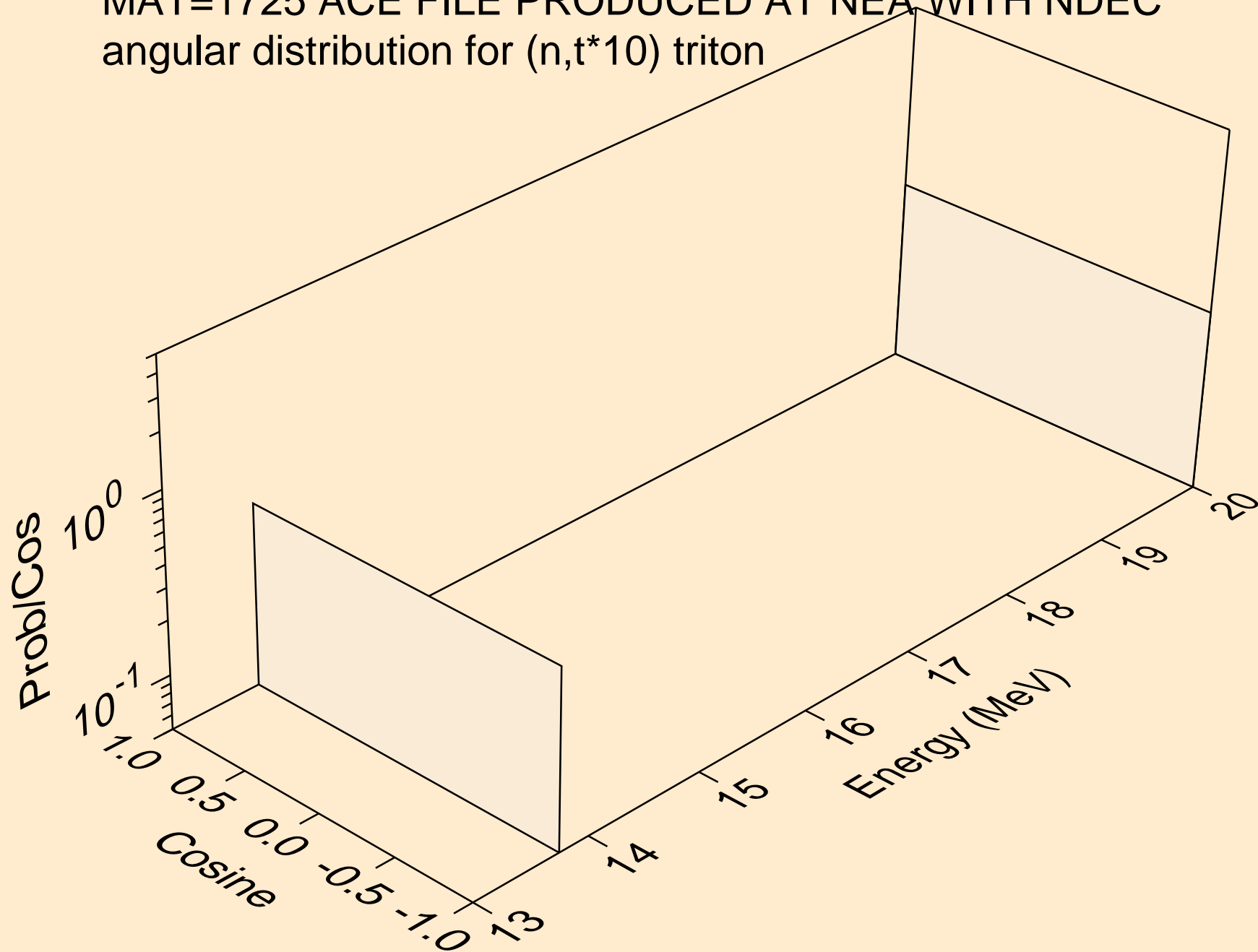

MAT=1725 ACE FILE PRODUCED AT NEA WITH NDEC
angular distribution for (n,t*11) triton

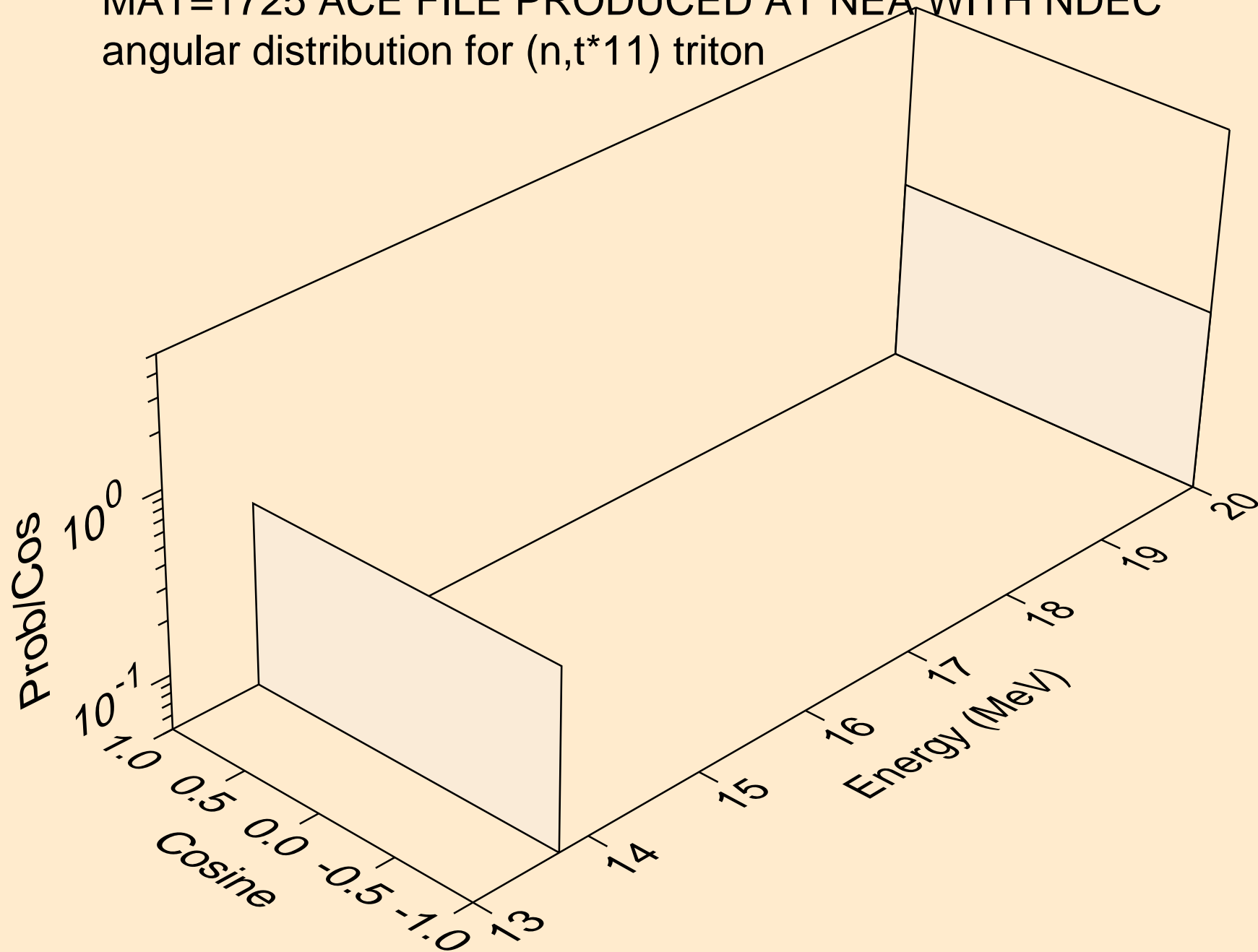

MAT=1725 ACE FILE PRODUCED AT NEA WITH NDEC
angular distribution for (n,t*12) triton

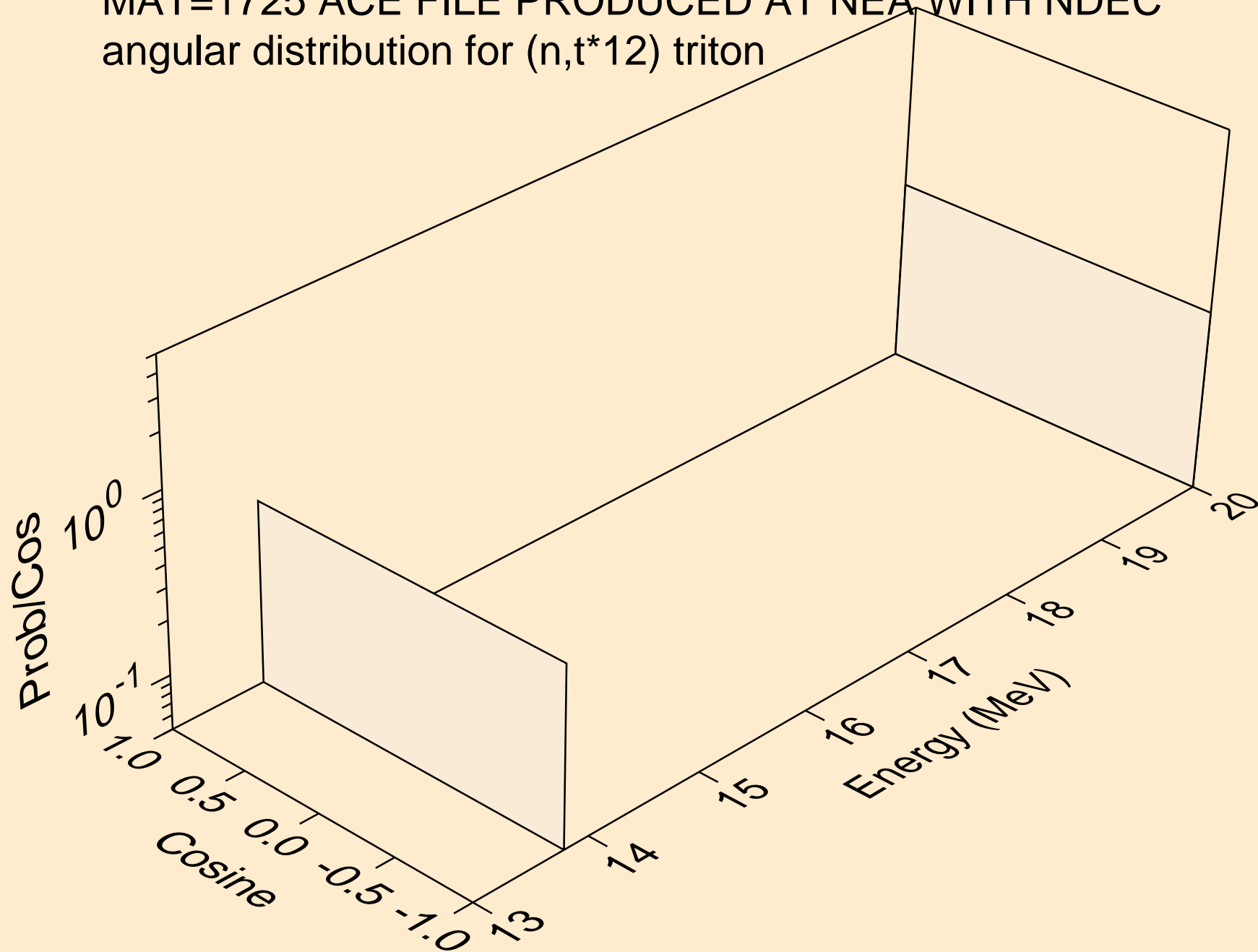

MAT=1725 ACE FILE PRODUCED AT NEA WITH NDEC
angular distribution for (n,t*13) triton

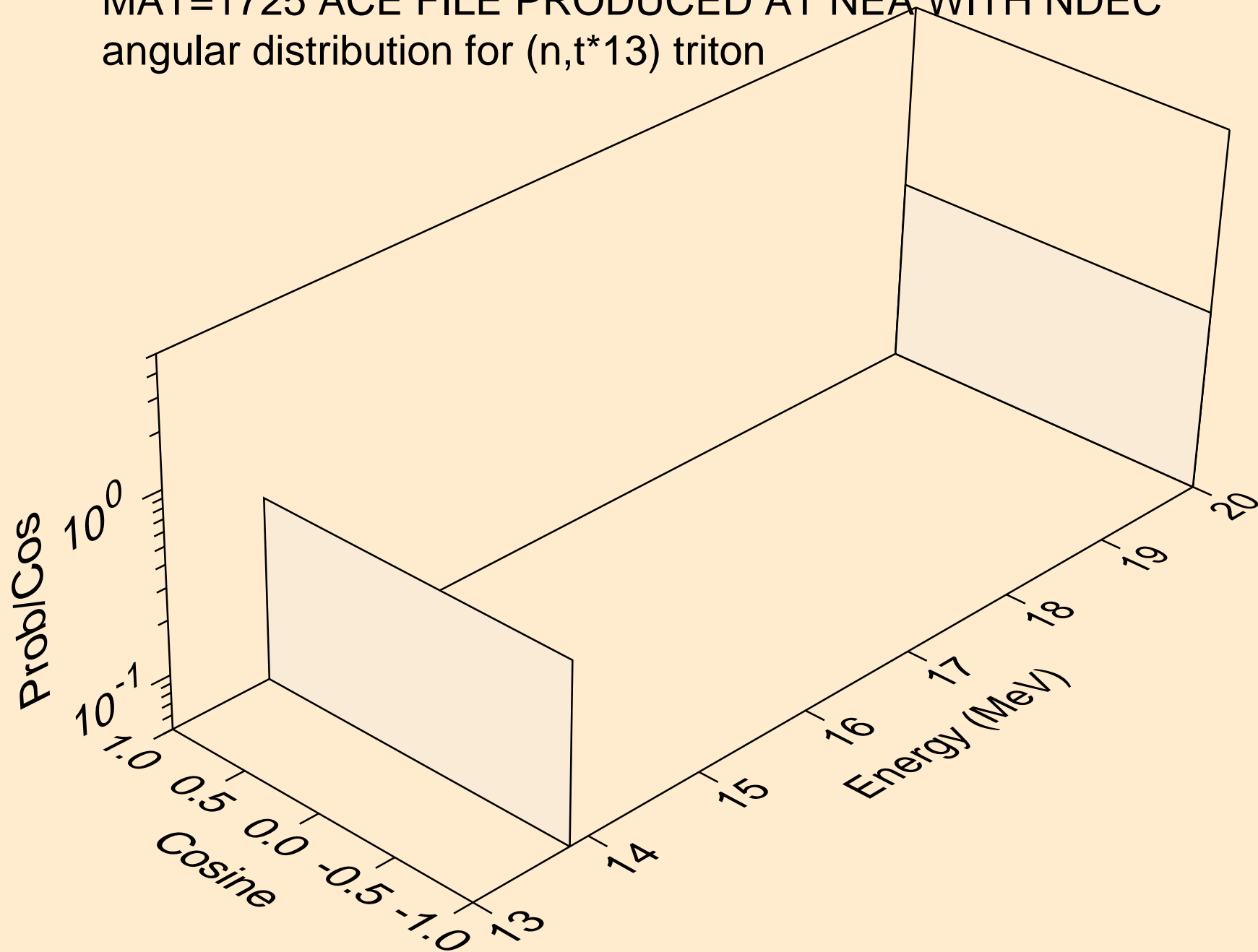

MAT=1725 ACE FILE PRODUCED AT NEA WITH NDEC
angular distribution for (n,t*14) triton

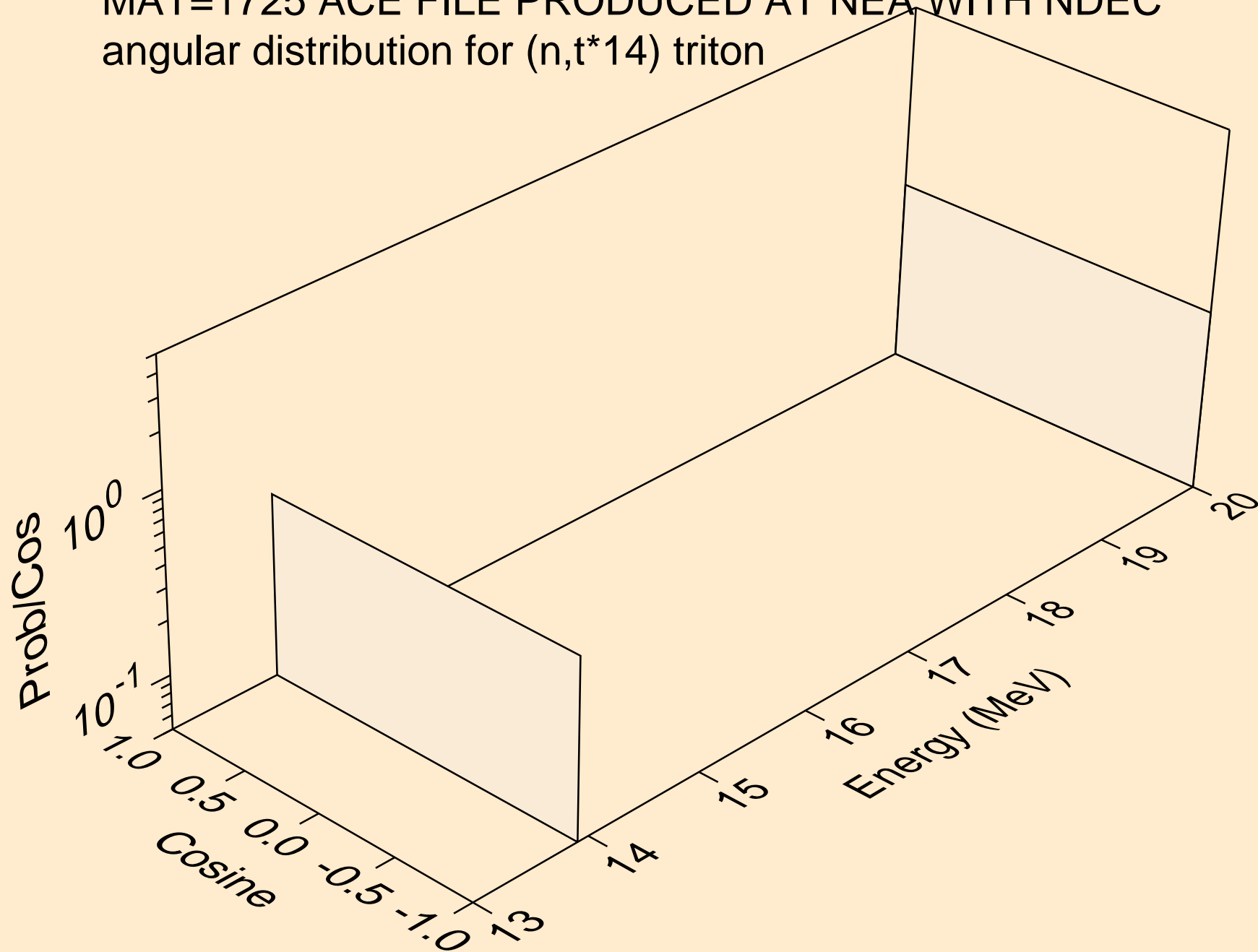

MAT=1725 ACE FILE PRODUCED AT NEA WITH NDEC
angular distribution for (n,t*15) triton

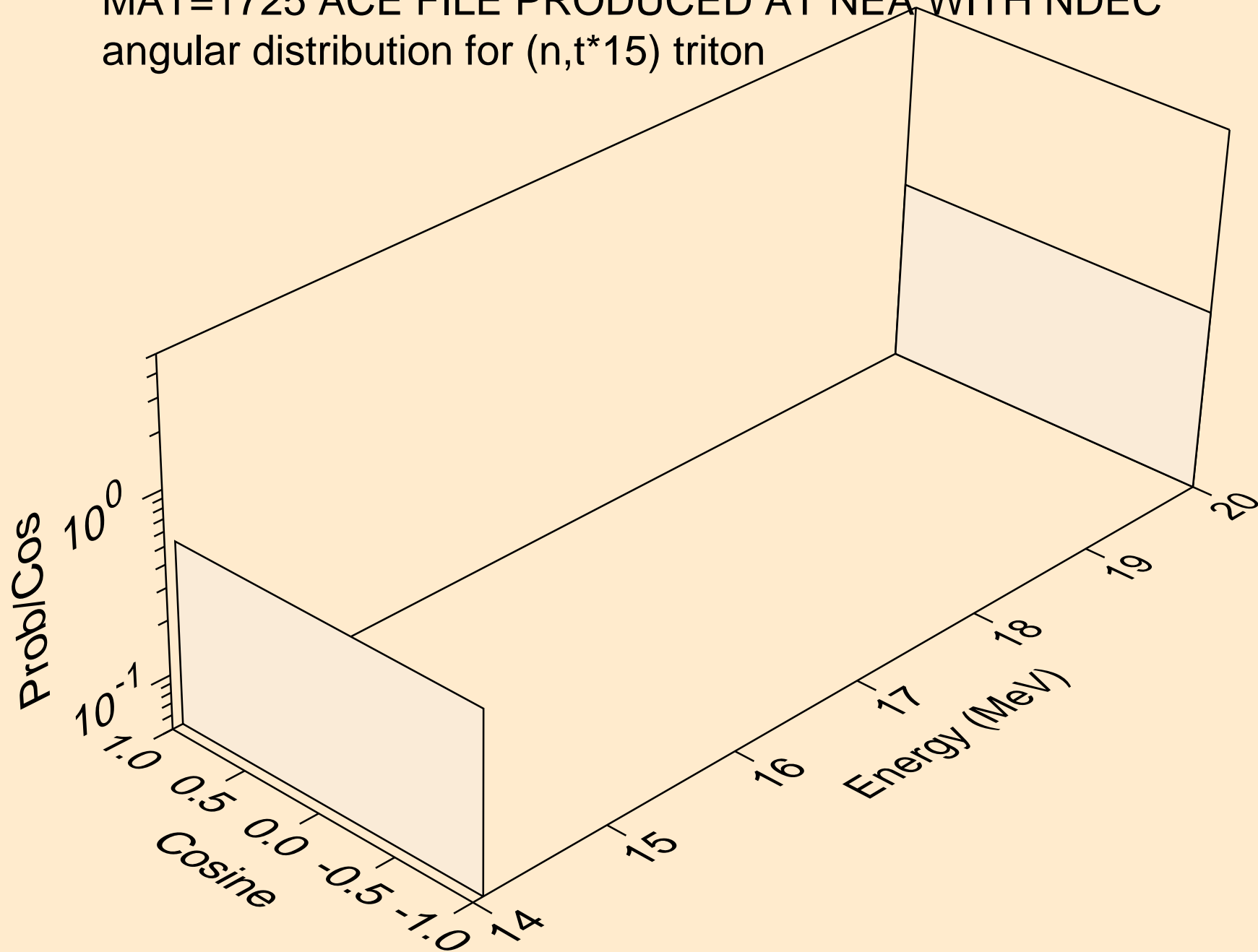

MAT=1725 ACE FILE PRODUCED AT NEA WITH NDEC
angular distribution for (n,t*16) triton

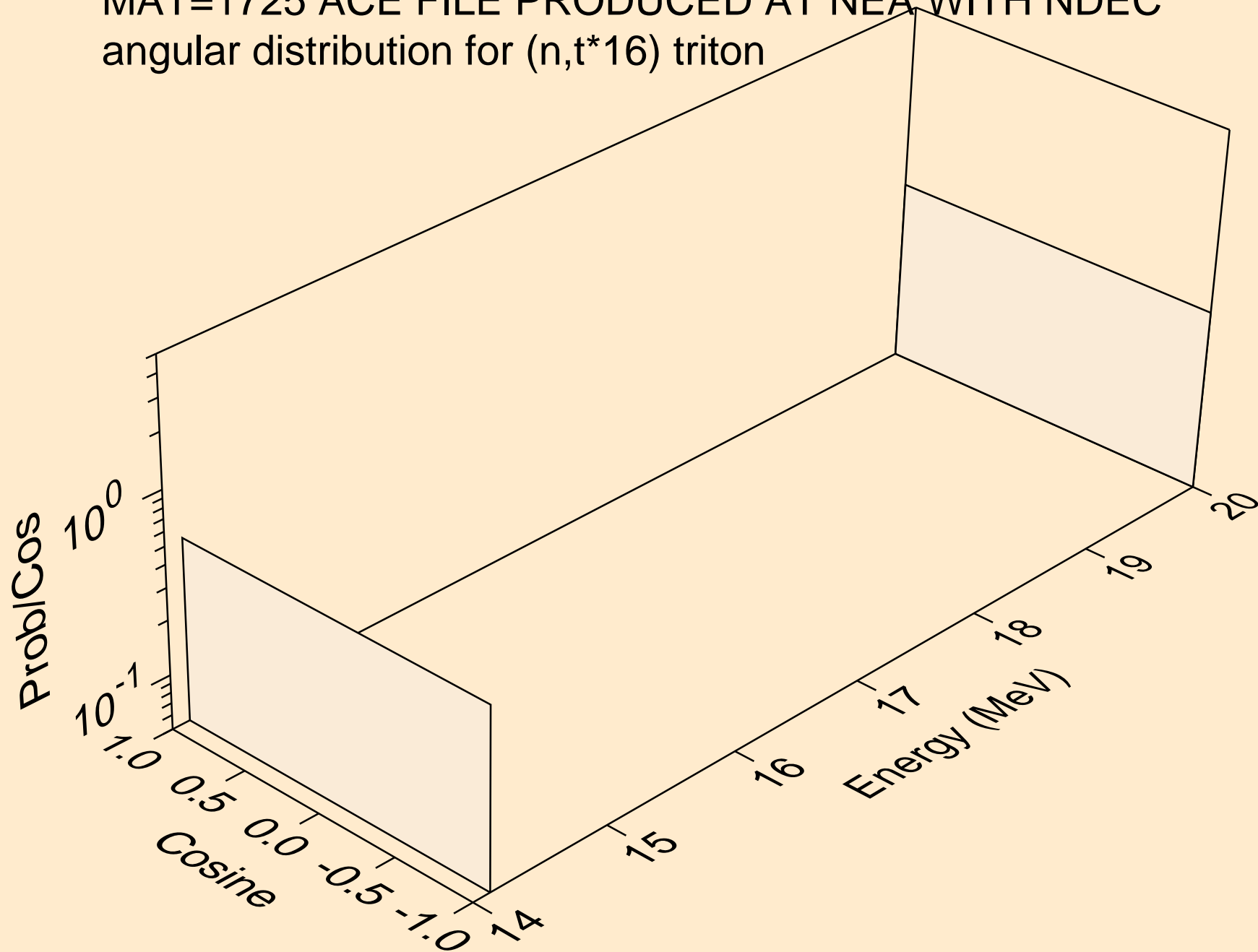

MAT=1725 ACE FILE PRODUCED AT NEA WITH NDEC
angular distribution for (n,t*17) triton

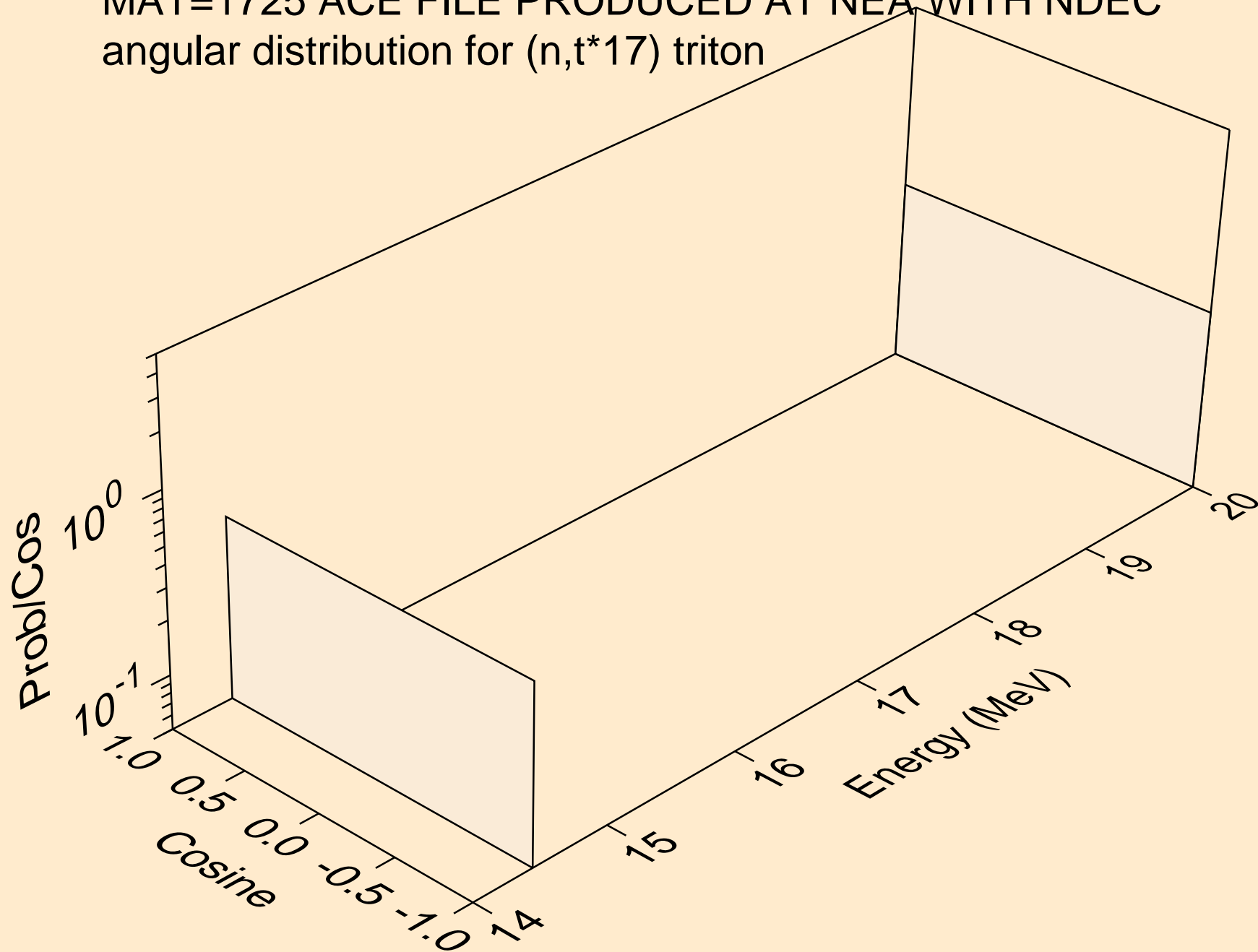

MAT=1725 ACE FILE PRODUCED AT NEA WITH NDEC
angular distribution for (n,t*18) triton

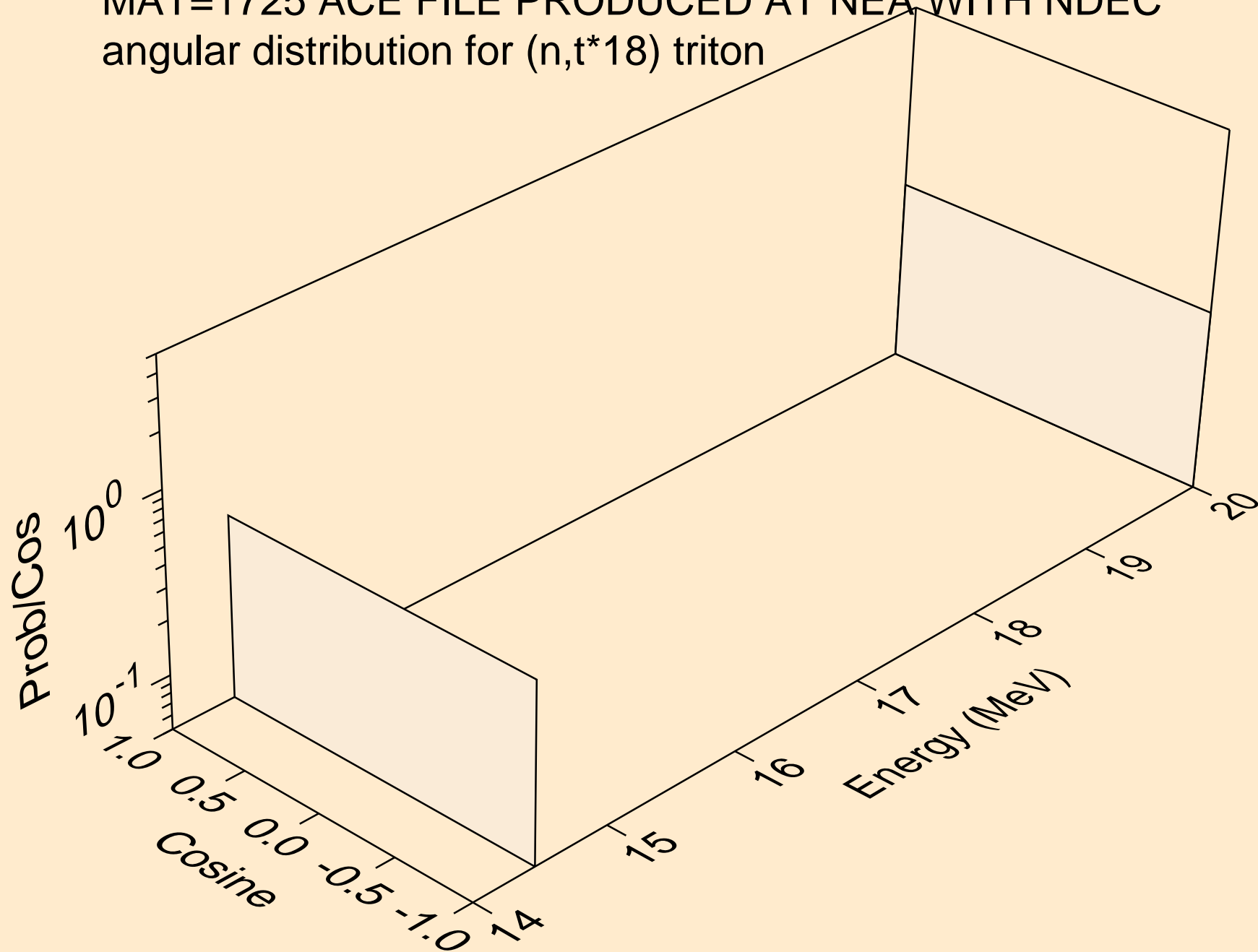

MAT=1725 ACE FILE PRODUCED AT NEA WITH NDEC
angular distribution for (n,t*19) triton

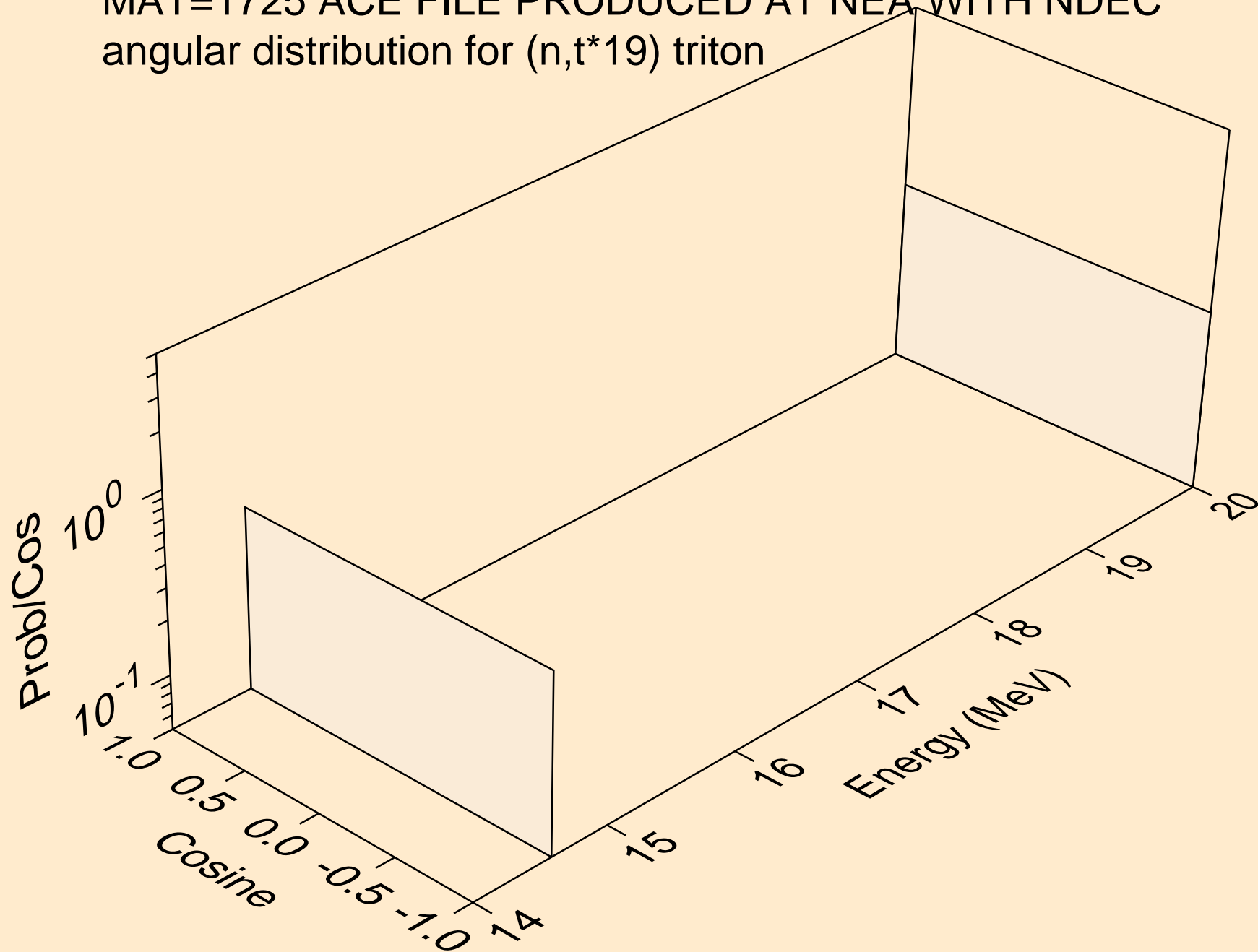

MAT=1725 ACE FILE PRODUCED AT NEA WITH NDEC
angular distribution for (n,t*20) triton

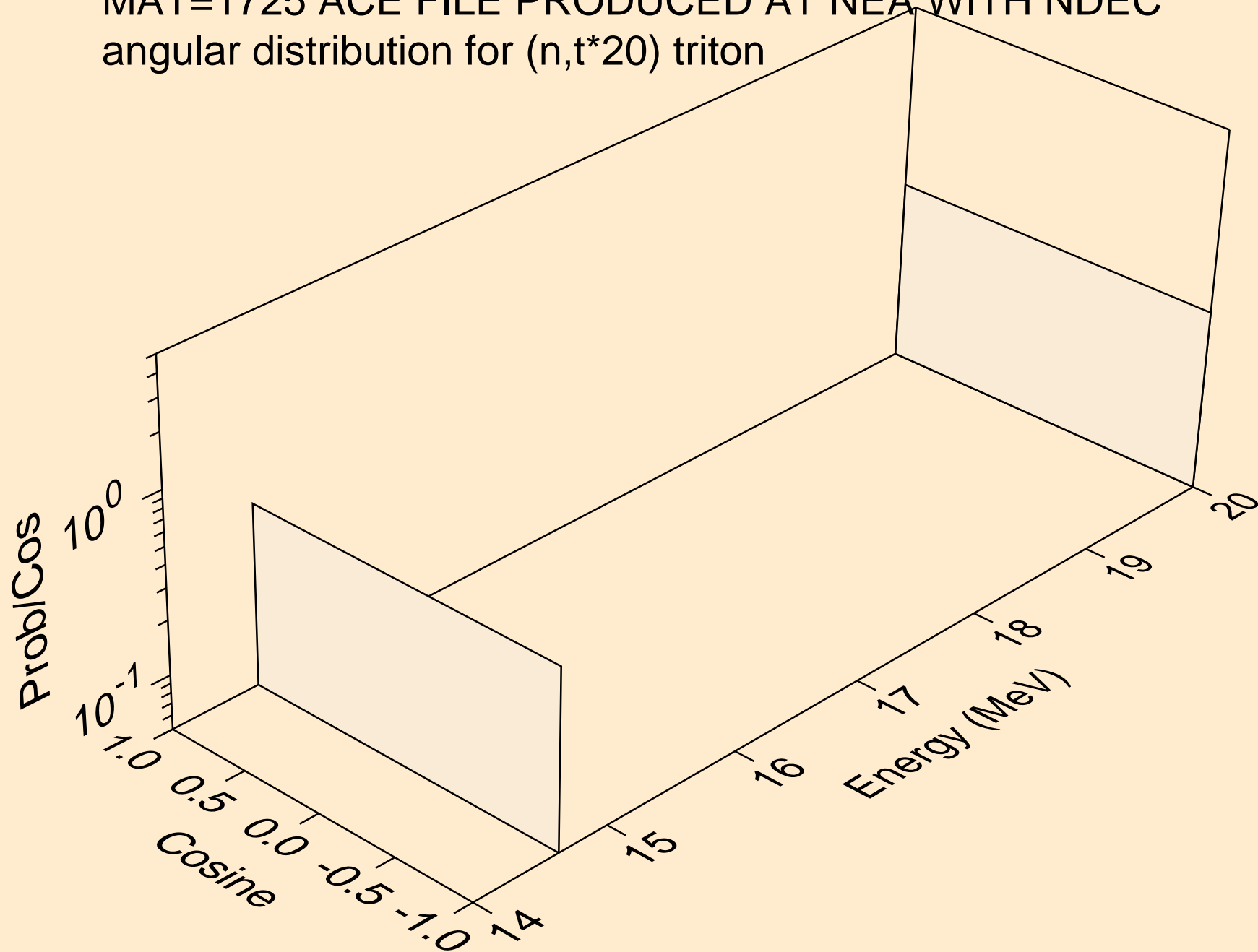

MAT=1725 ACE FILE PRODUCED AT NEA WITH NDEC
angular distribution for (n,t*21) triton

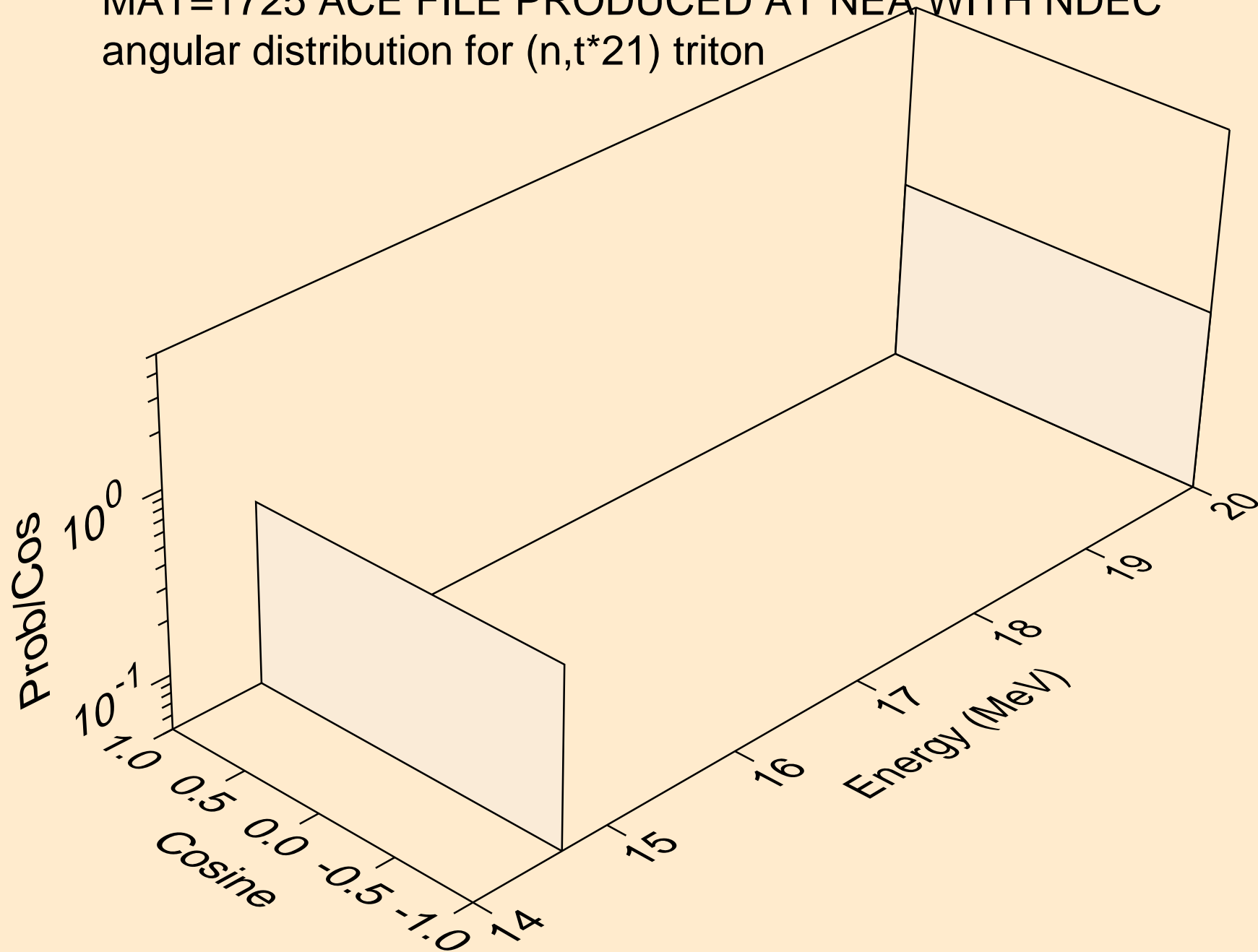

MAT=1725 ACE FILE PRODUCED AT NEA WITH NDEC
angular distribution for (n,t*22) triton

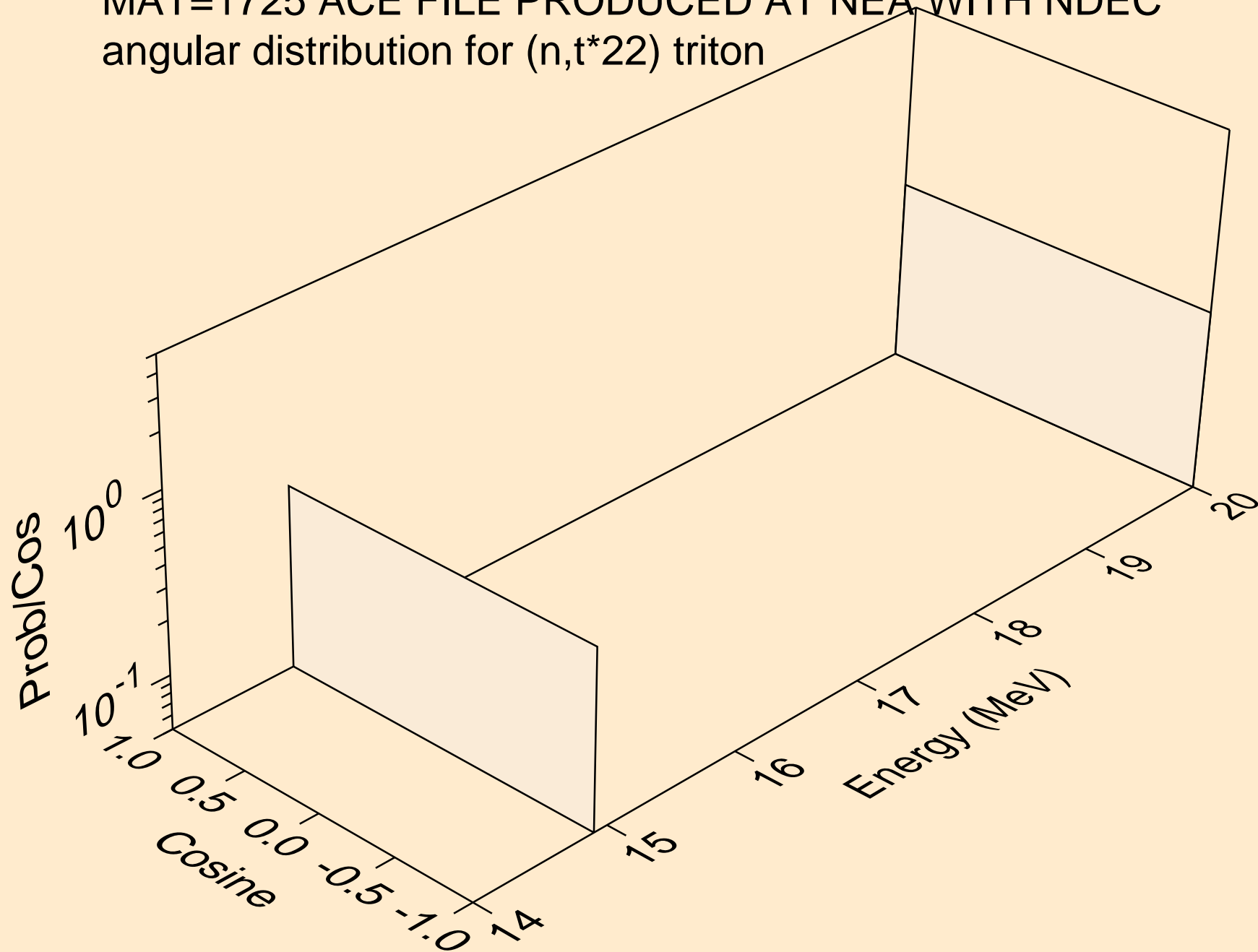

MAT=1725 ACE FILE PRODUCED AT NEA WITH NDEC
angular distribution for (n,t*23) triton

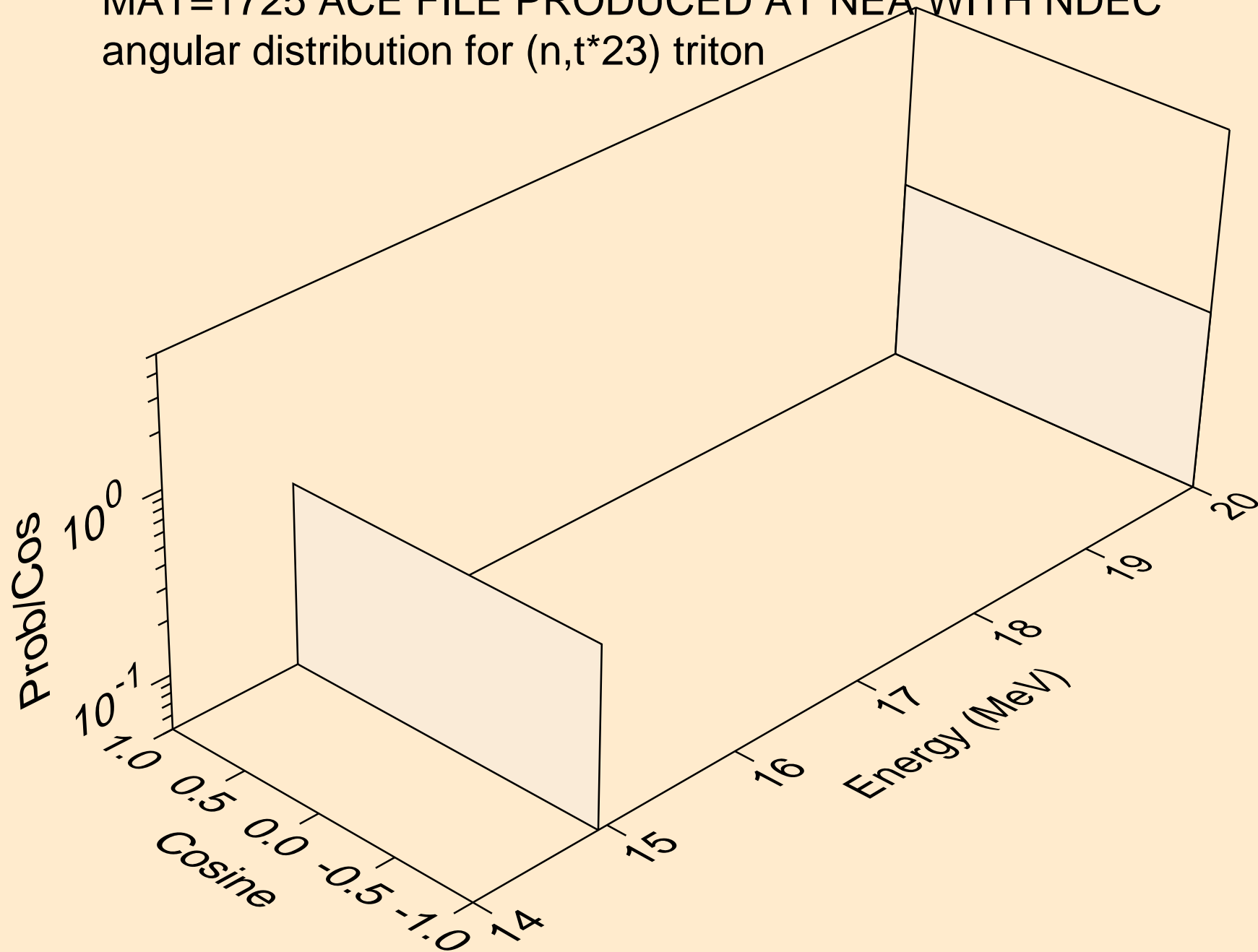

MAT=1725 ACE FILE PRODUCED AT NEA WITH NDEC
angular distribution for (n,t*24) triton

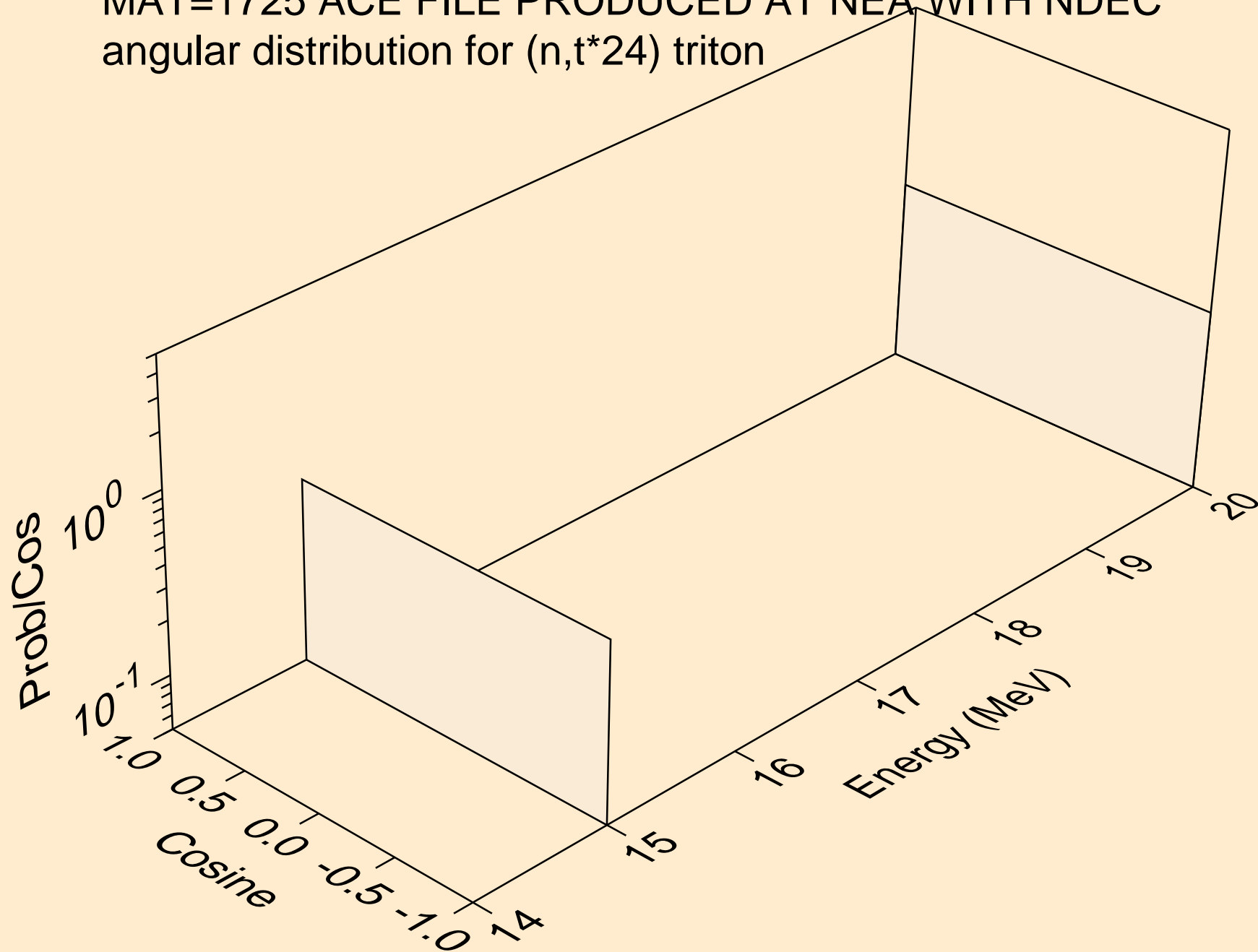

MAT=1725 ACE FILE PRODUCED AT NEA WITH NDEC
angular distribution for (n,t*25) triton

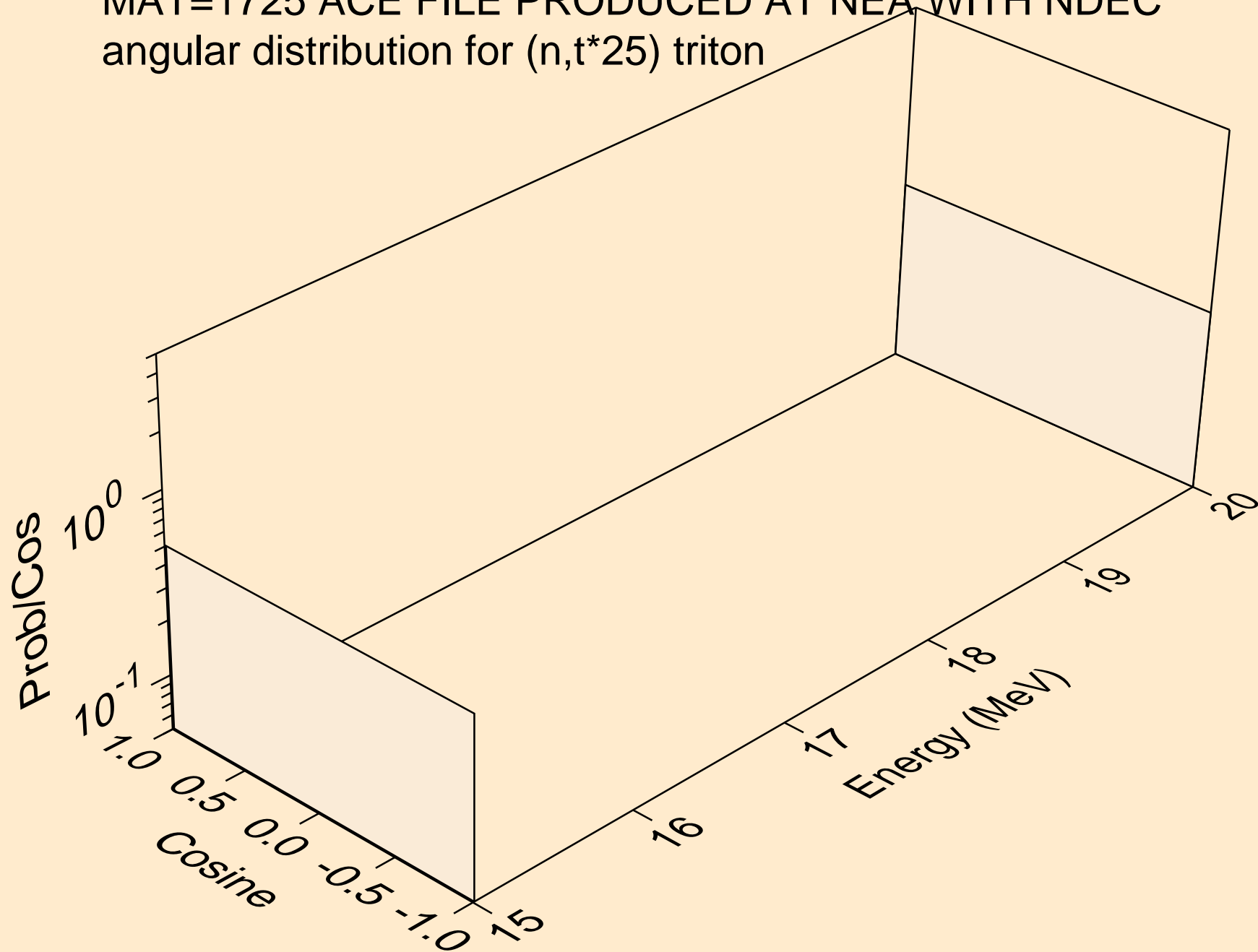

MAT=1725 ACE FILE PRODUCED AT NEA WITH NDEC
angular distribution for (n,t*26) triton

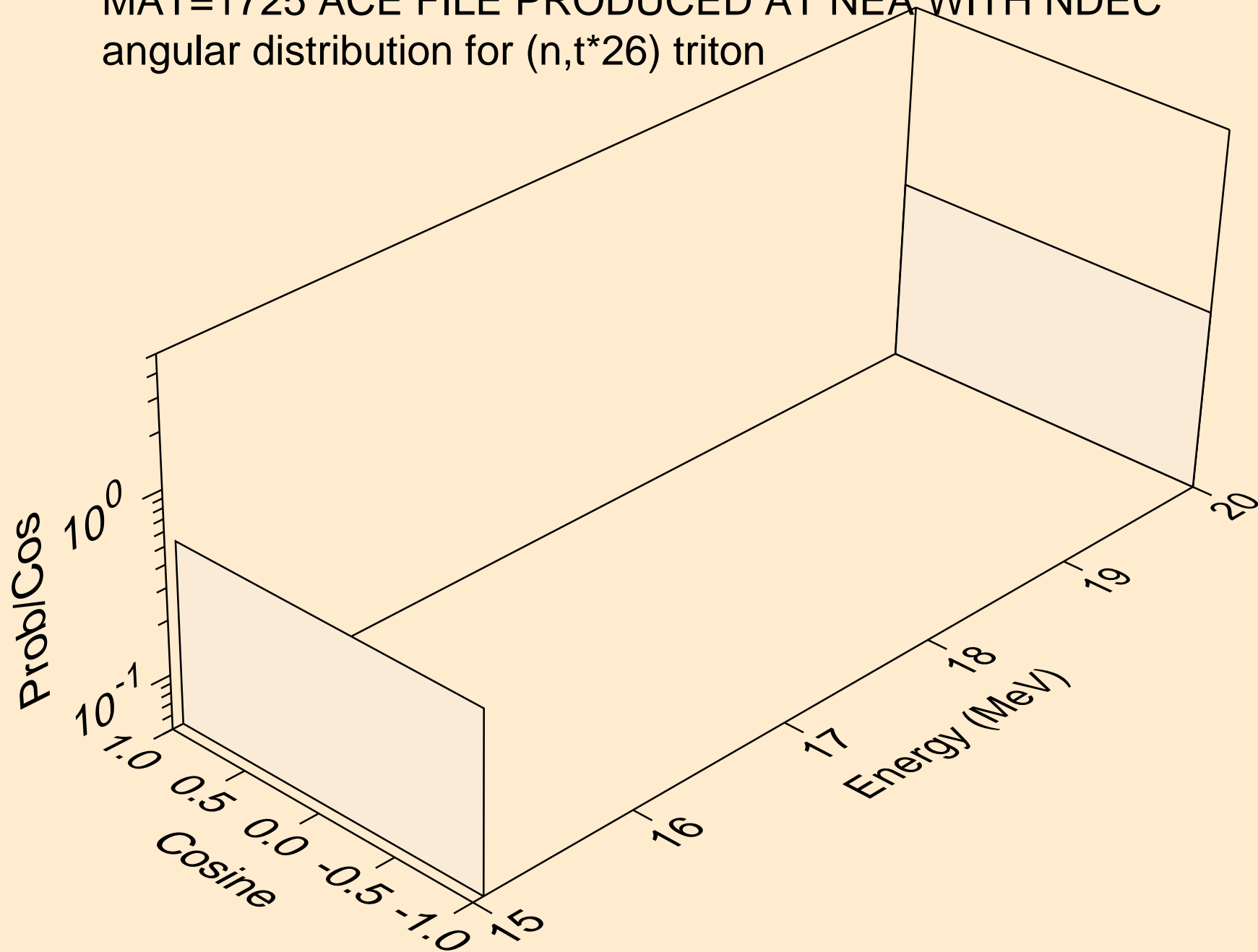

MAT=1725 ACE FILE PRODUCED AT NEA WITH NDEC
angular distribution for (n,t*27) triton

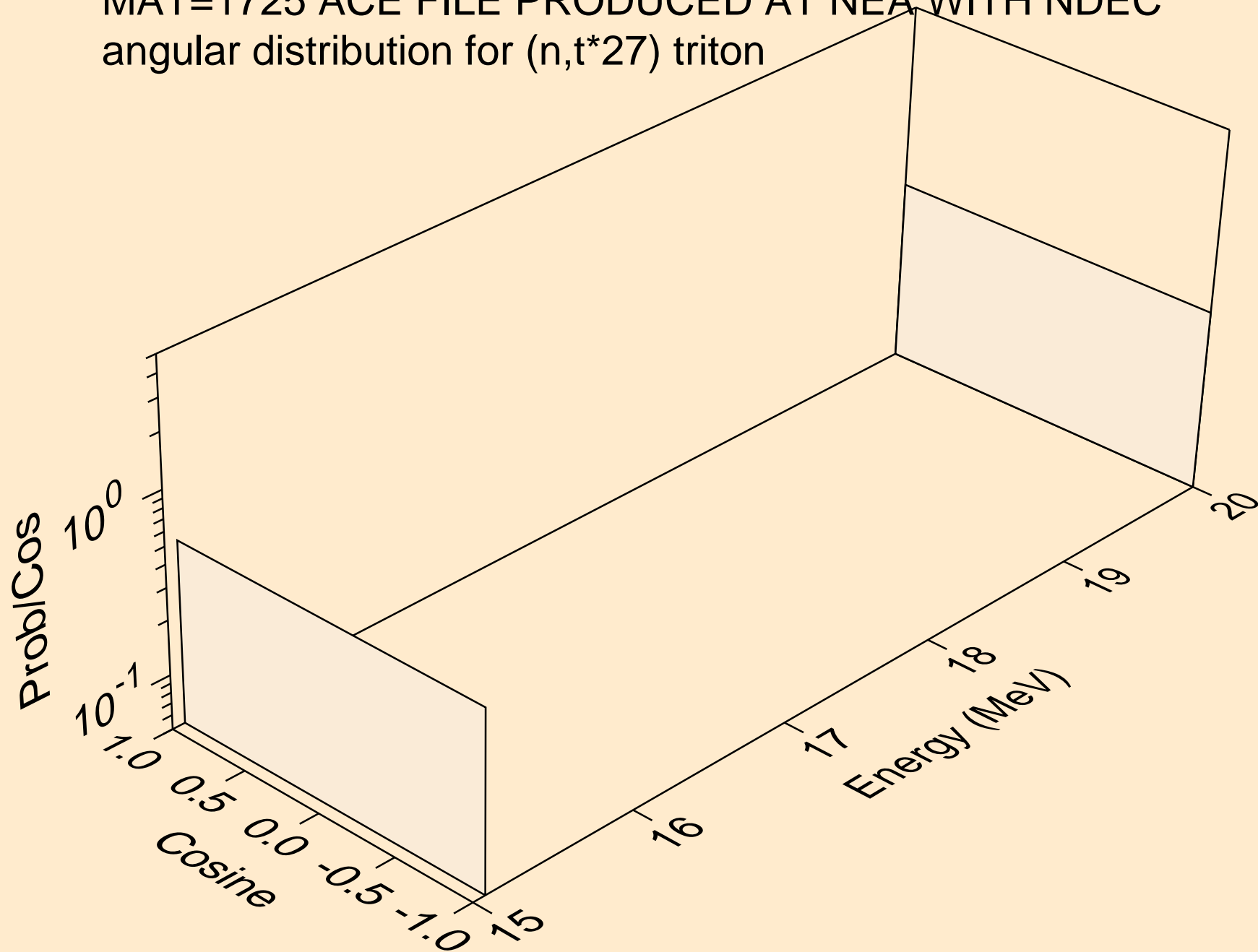

MAT=1725 ACE FILE PRODUCED AT NEA WITH NDEC
angular distribution for (n,t*28) triton

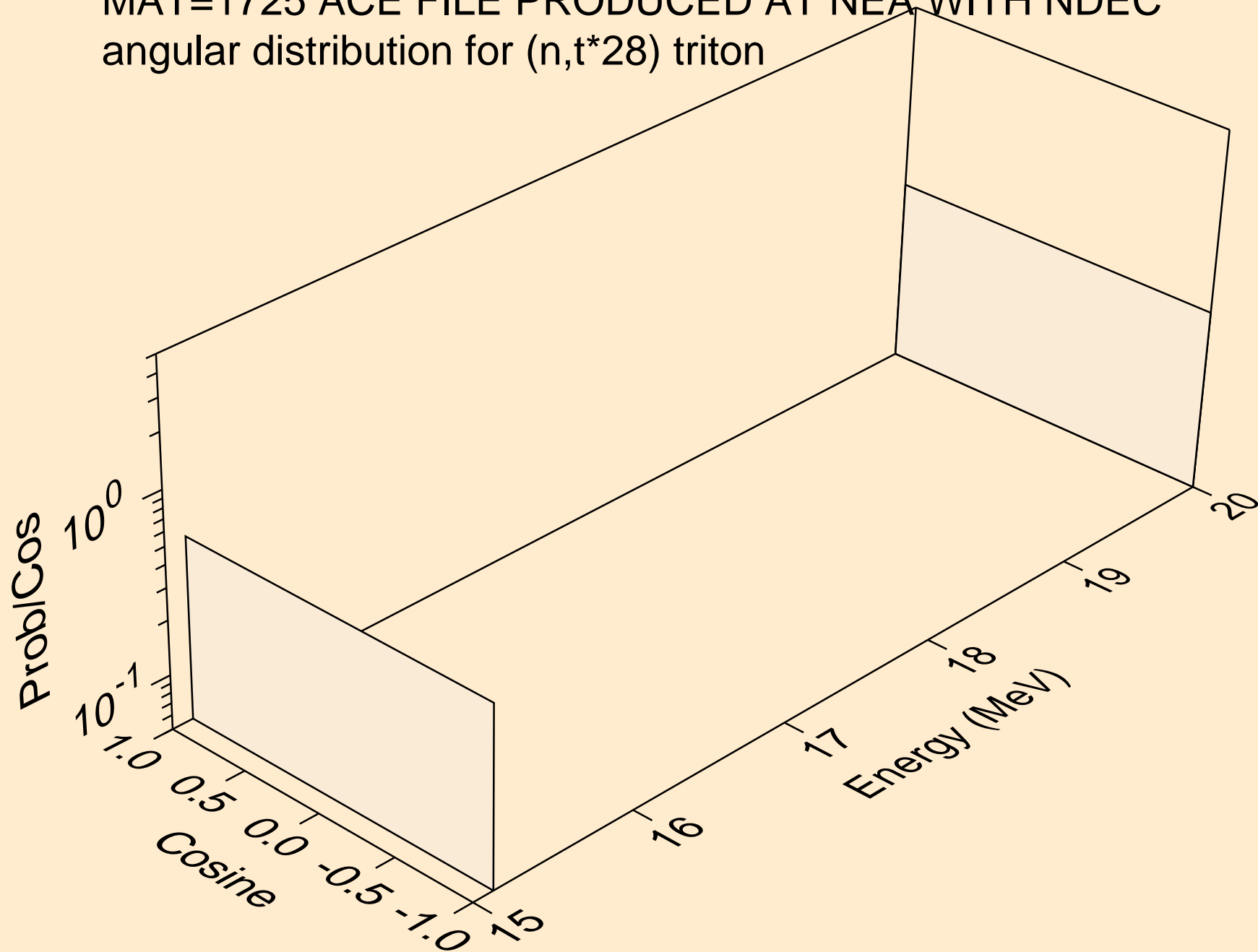

MAT=1725 ACE FILE PRODUCED AT NEA WITH NDEC
angular distribution for (n,t*29) triton

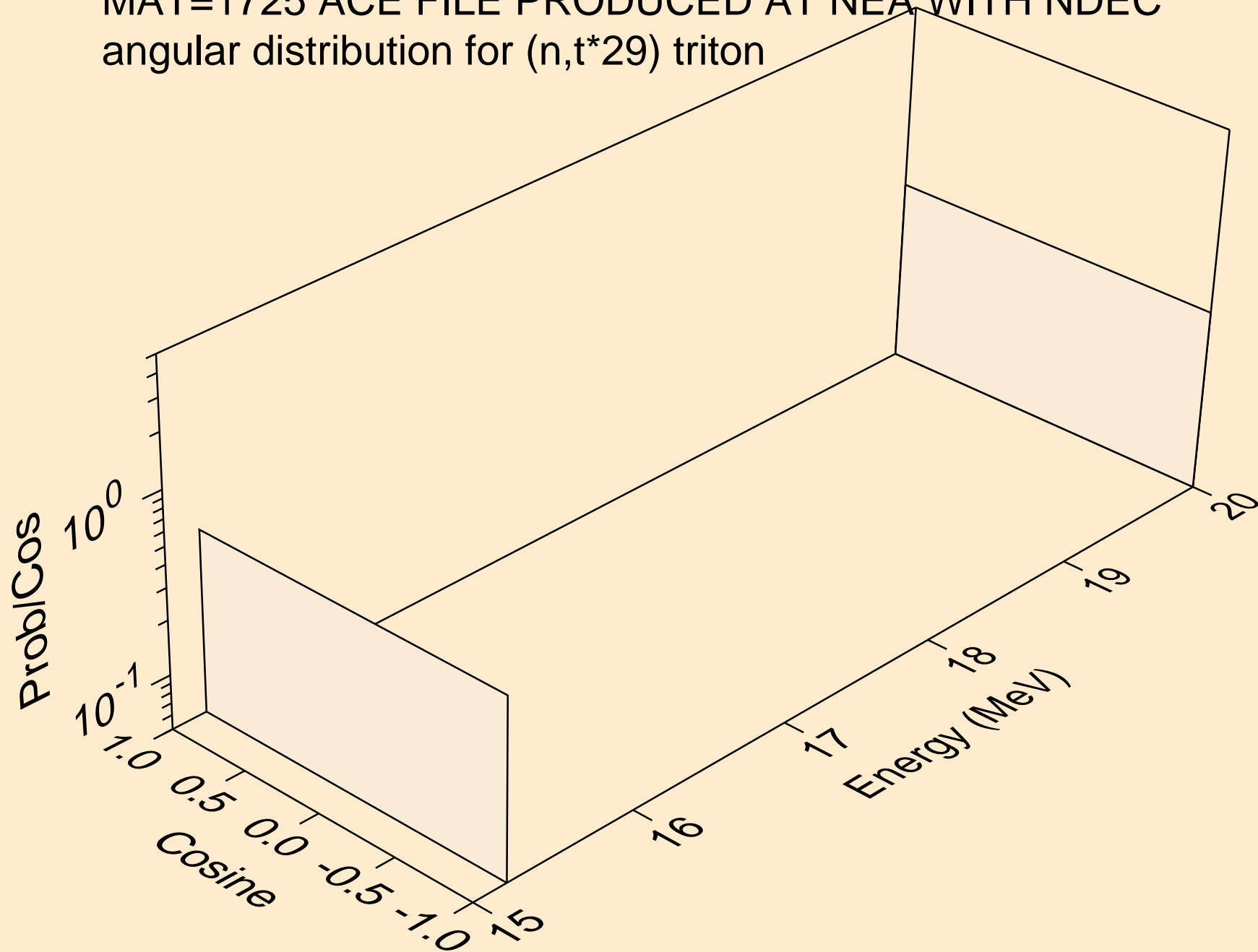

MAT=1725 ACE FILE PRODUCED AT NEA WITH NDEC
angular distribution for (n,t*30) triton

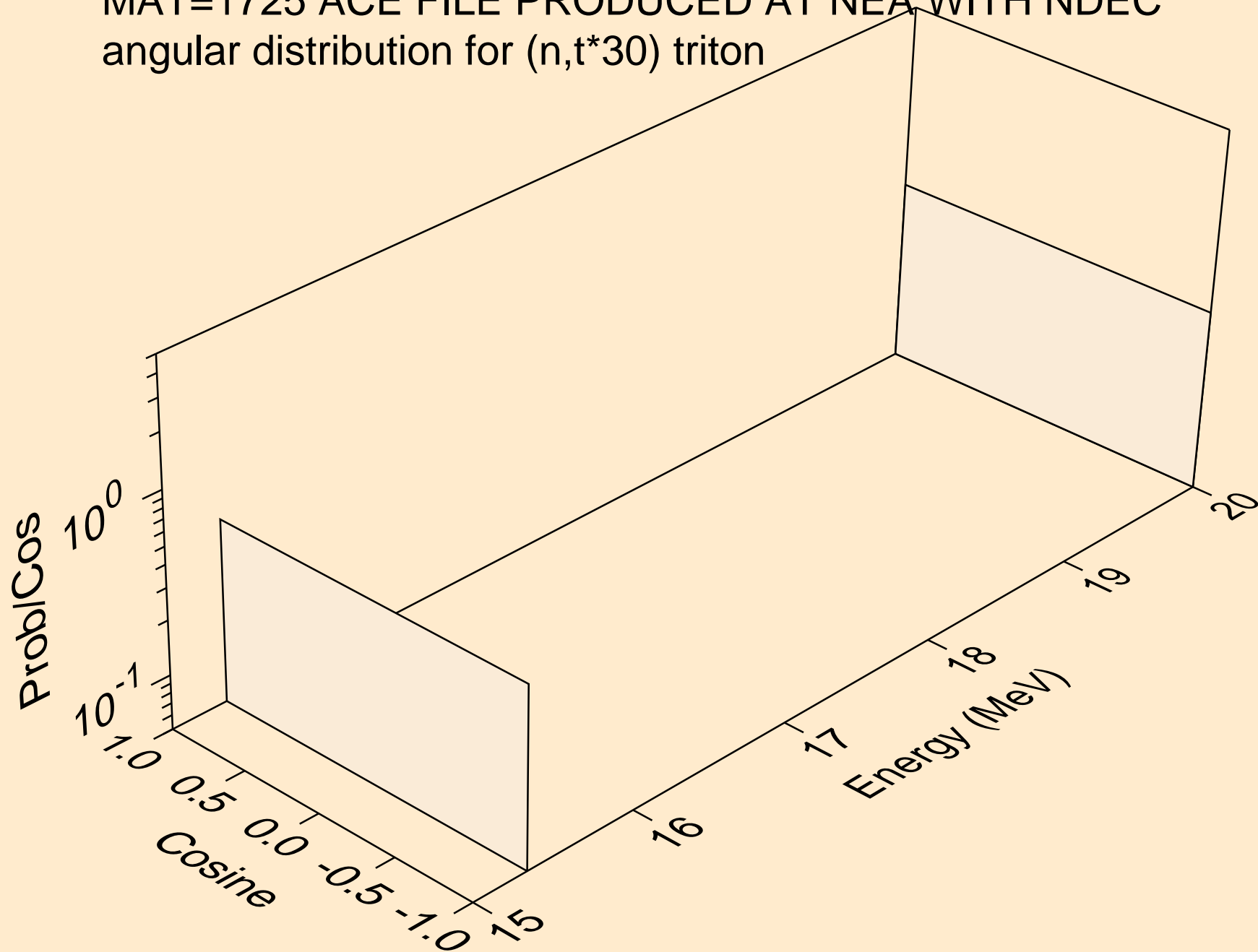

MAT=1725 ACE FILE PRODUCED AT NEA WITH NDEC
tritons from (n,t*c)

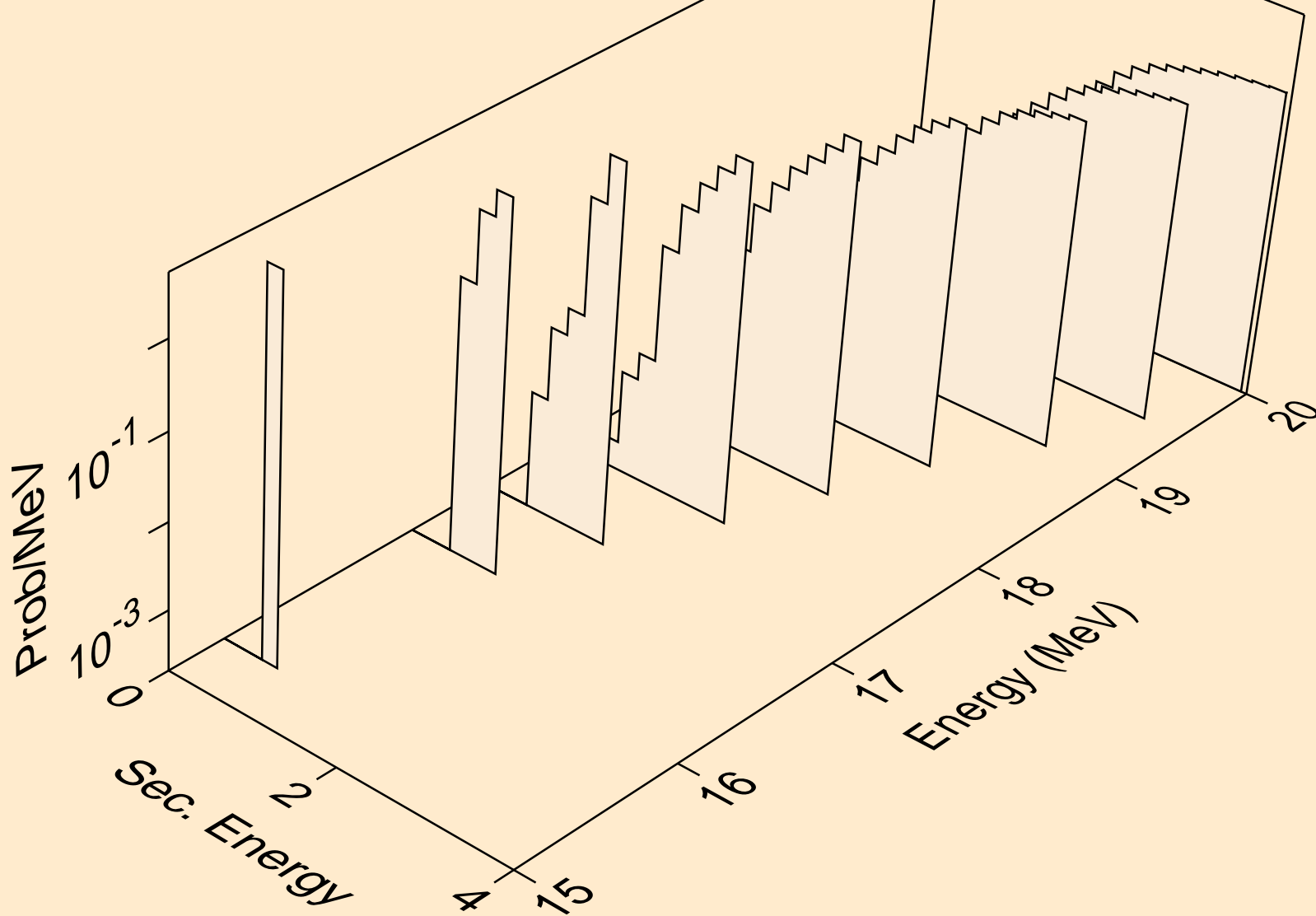

MAT=1725 ACE FILE PRODUCED AT NEA WITH NDEC
alphas from (n,n*)a

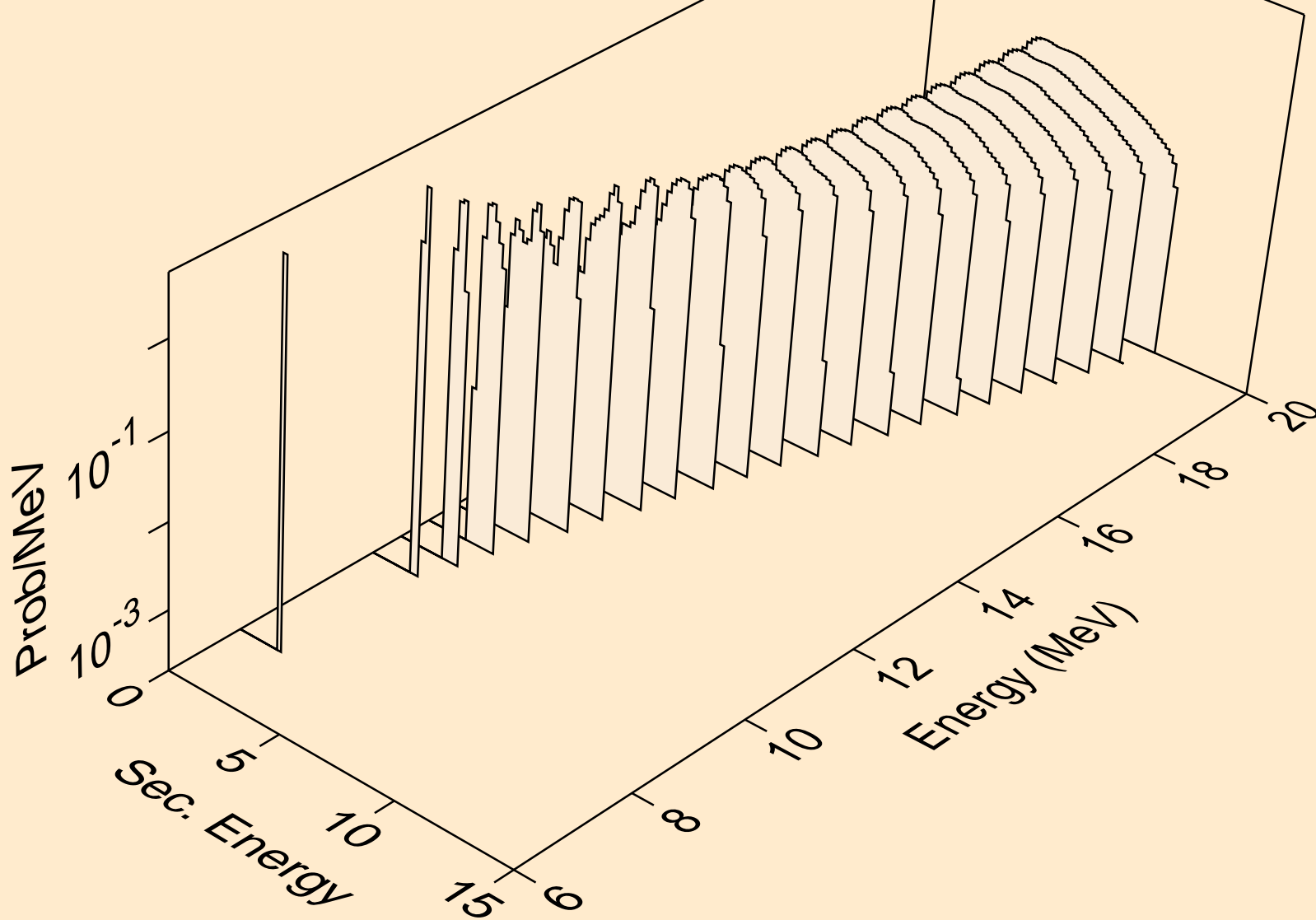

MAT=1725 ACE FILE PRODUCED AT NEA WITH NDEC
alphas from (n,pa)

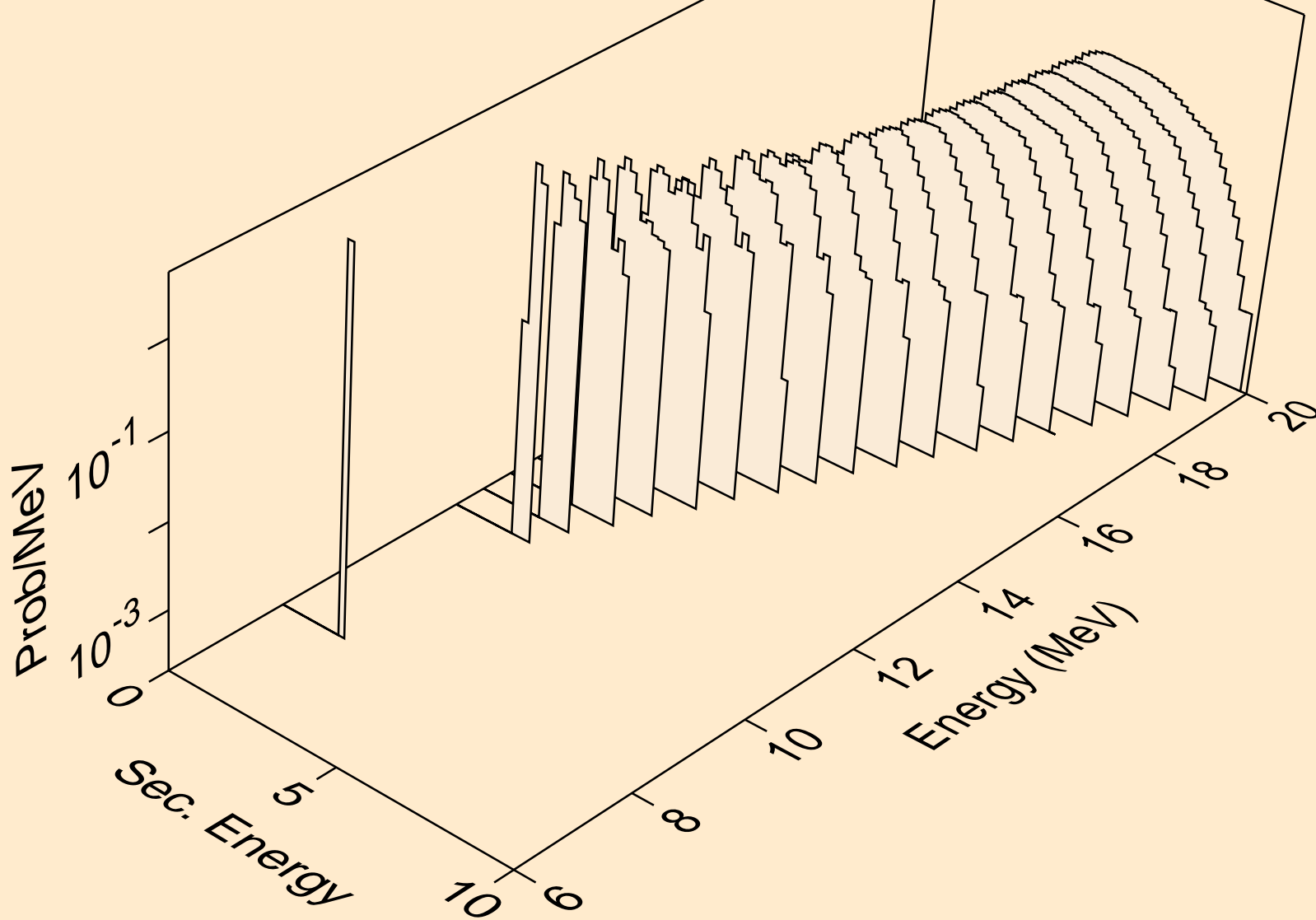

MAT=1725 ACE FILE PRODUCED AT NEA WITH NDEC
angular distribution for (n,a*0) alpha

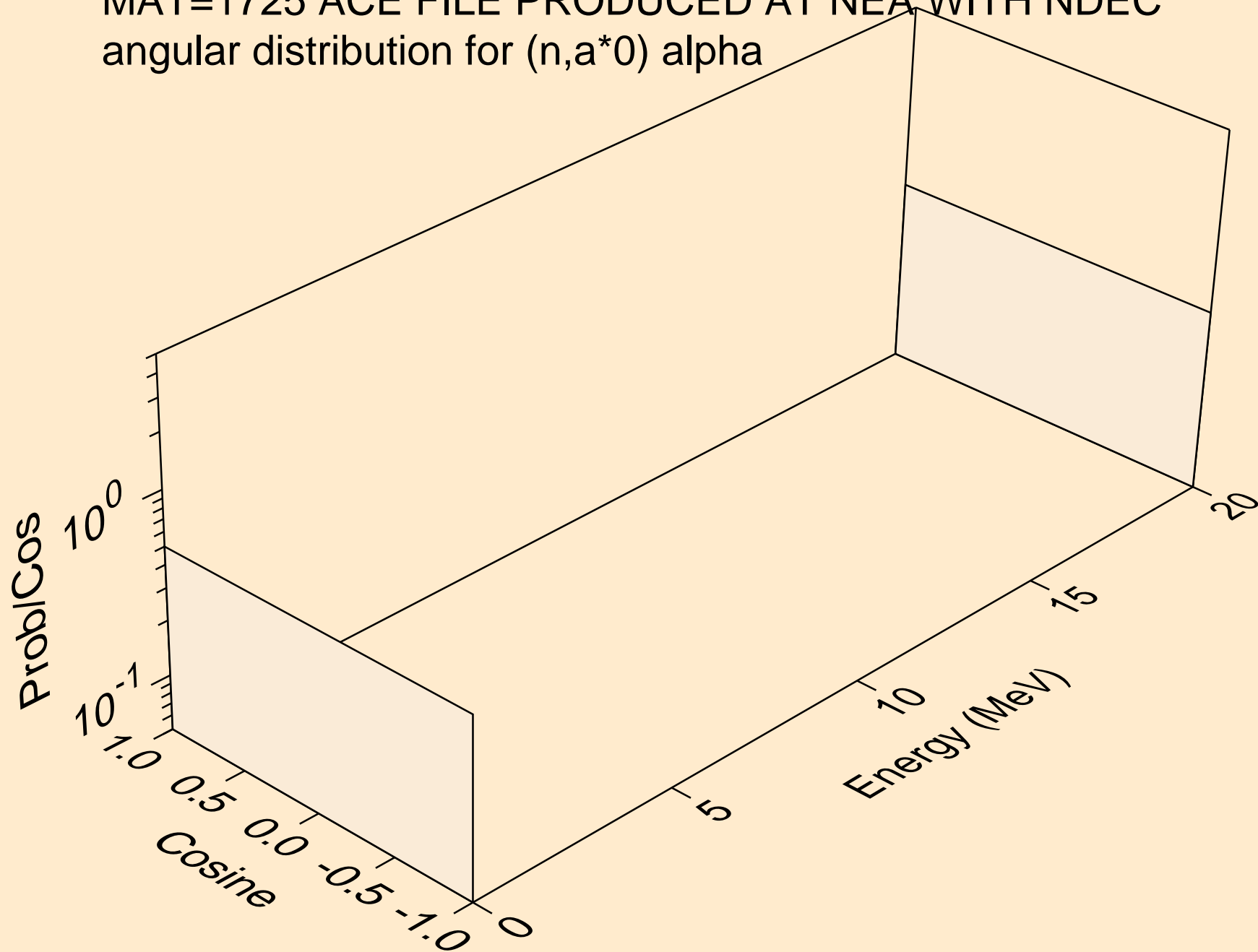

MAT=1725 ACE FILE PRODUCED AT NEA WITH NDEC
angular distribution for (n,a*1) alpha

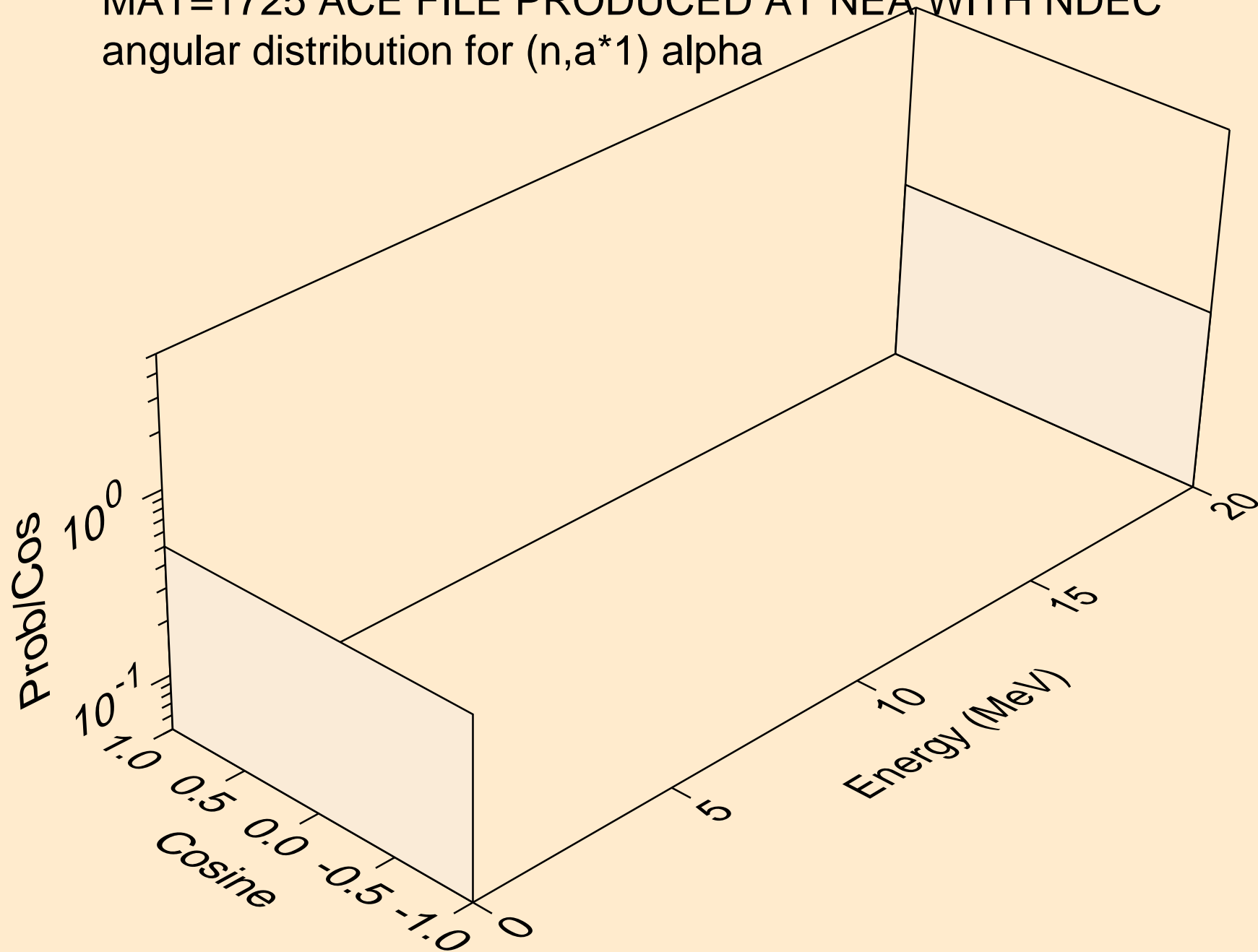

MAT=1725 ACE FILE PRODUCED AT NEA WITH NDEC
angular distribution for (n,a*2) alpha

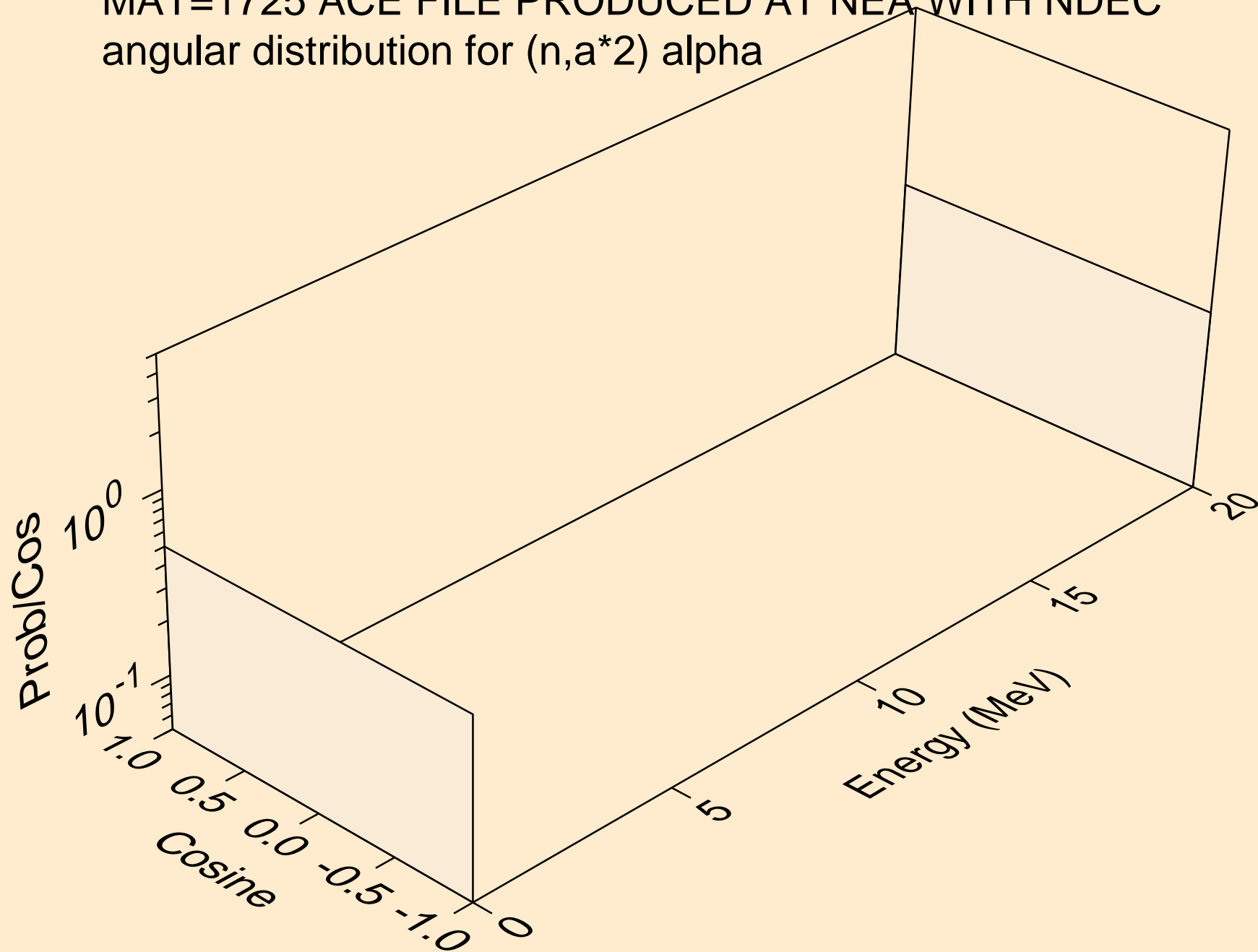

MAT=1725 ACE FILE PRODUCED AT NEA WITH NDEC
angular distribution for (n,a*3) alpha

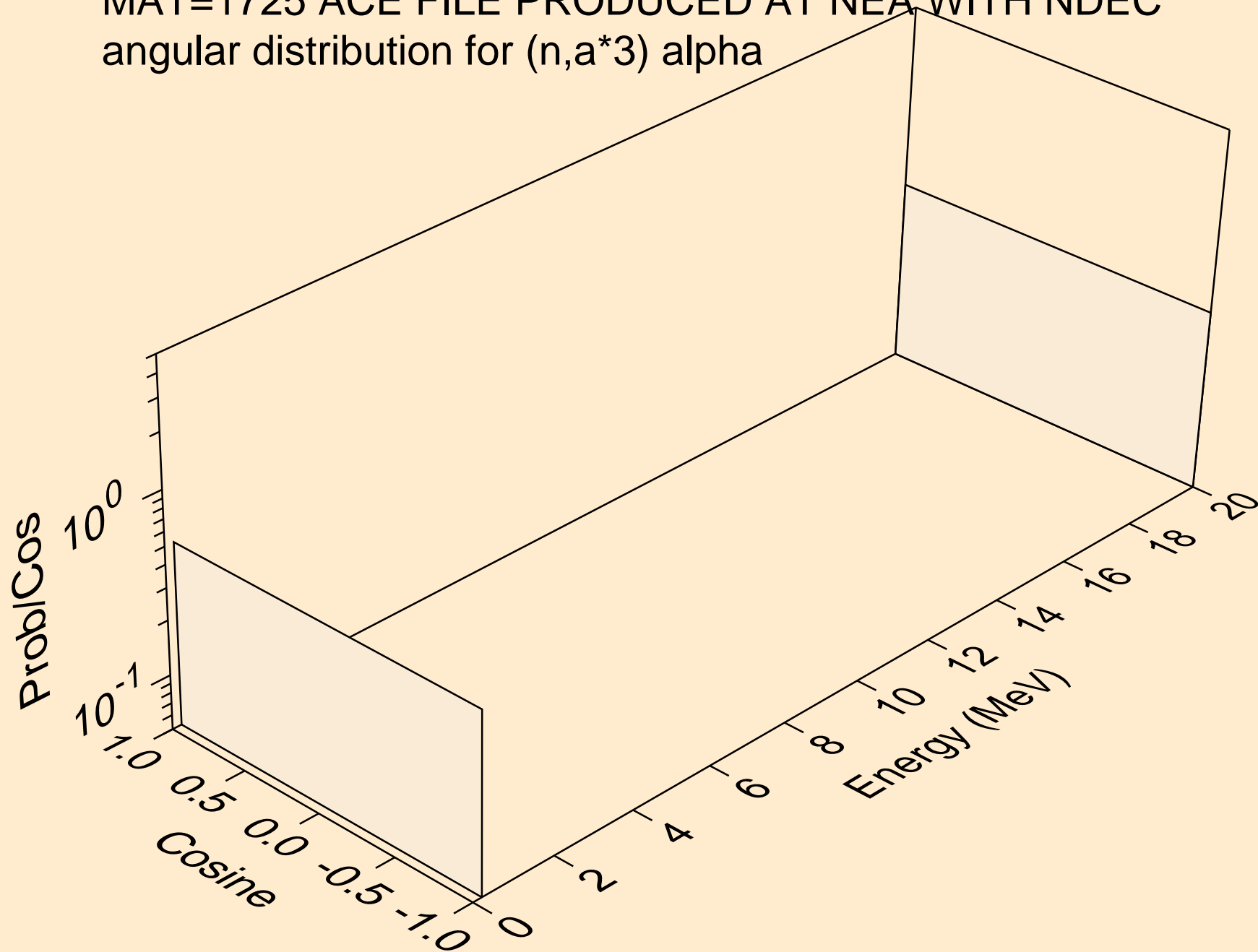

MAT=1725 ACE FILE PRODUCED AT NEA WITH NDEC
angular distribution for (n,a*4) alpha

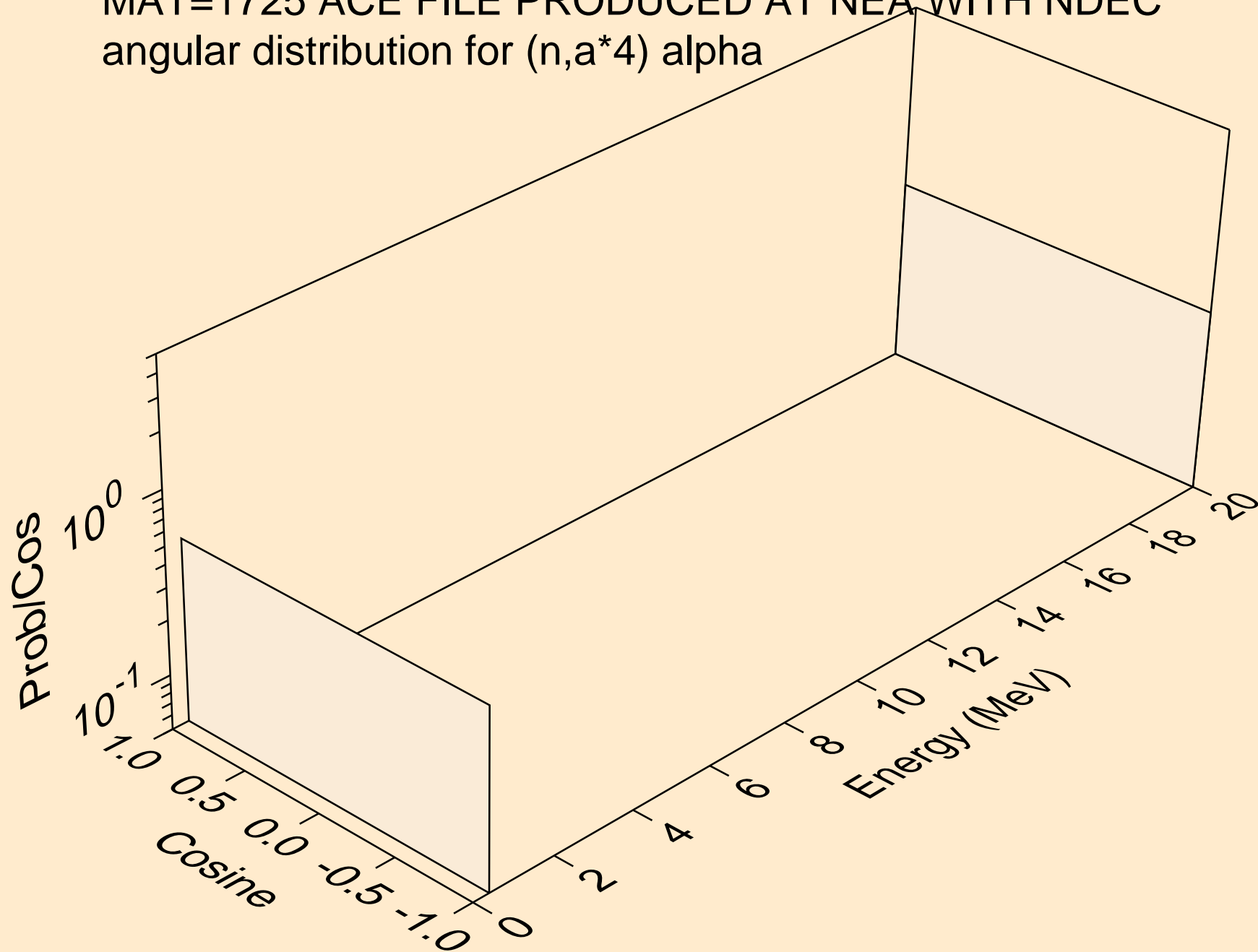

MAT=1725 ACE FILE PRODUCED AT NEA WITH NDEC
angular distribution for (n,a*5) alpha

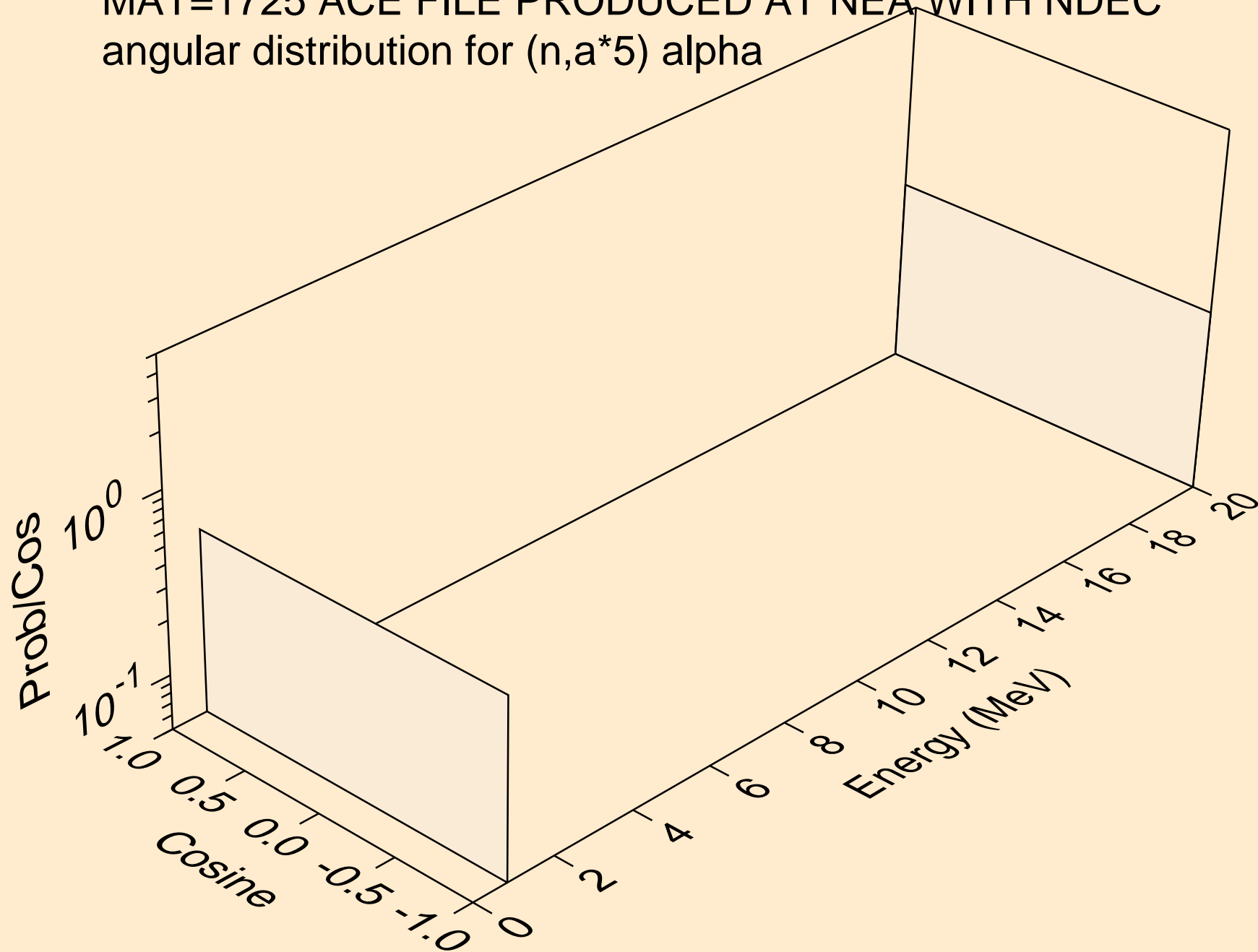

MAT=1725 ACE FILE PRODUCED AT NEA WITH NDEC
angular distribution for (n,a*6) alpha

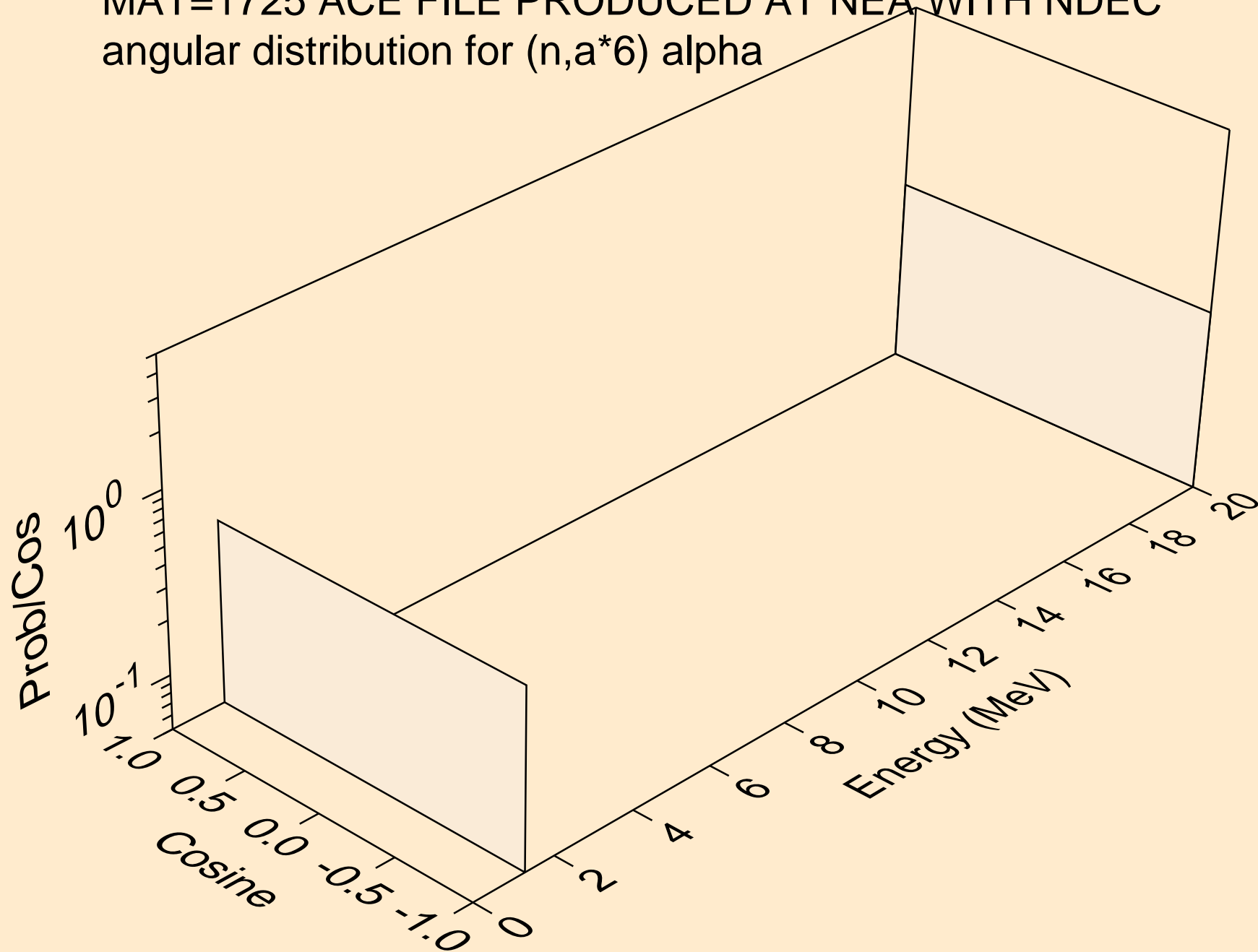

MAT=1725 ACE FILE PRODUCED AT NEA WITH NDEC
angular distribution for (n,a*7) alpha

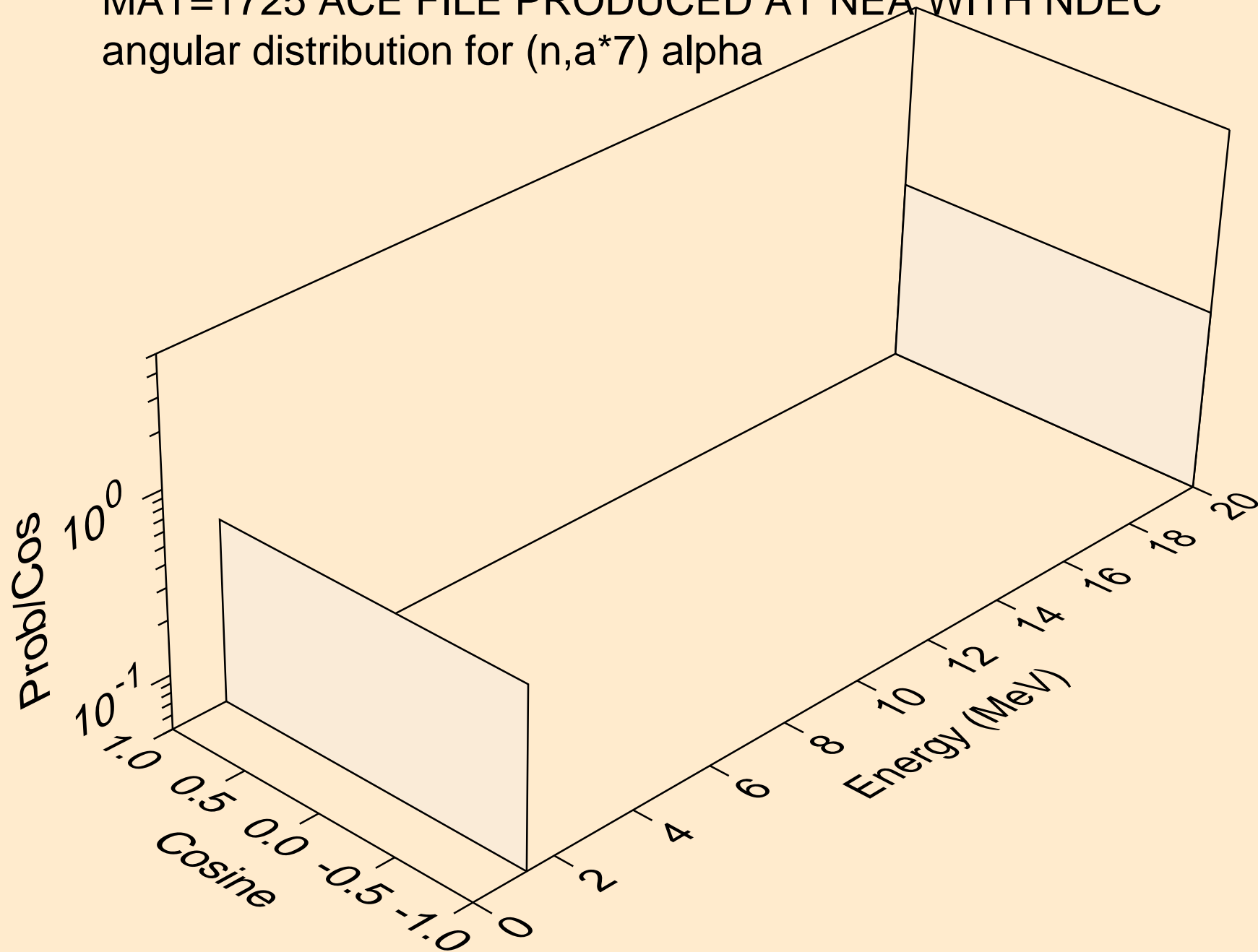

MAT=1725 ACE FILE PRODUCED AT NEA WITH NDEC
angular distribution for (n,a*8) alpha

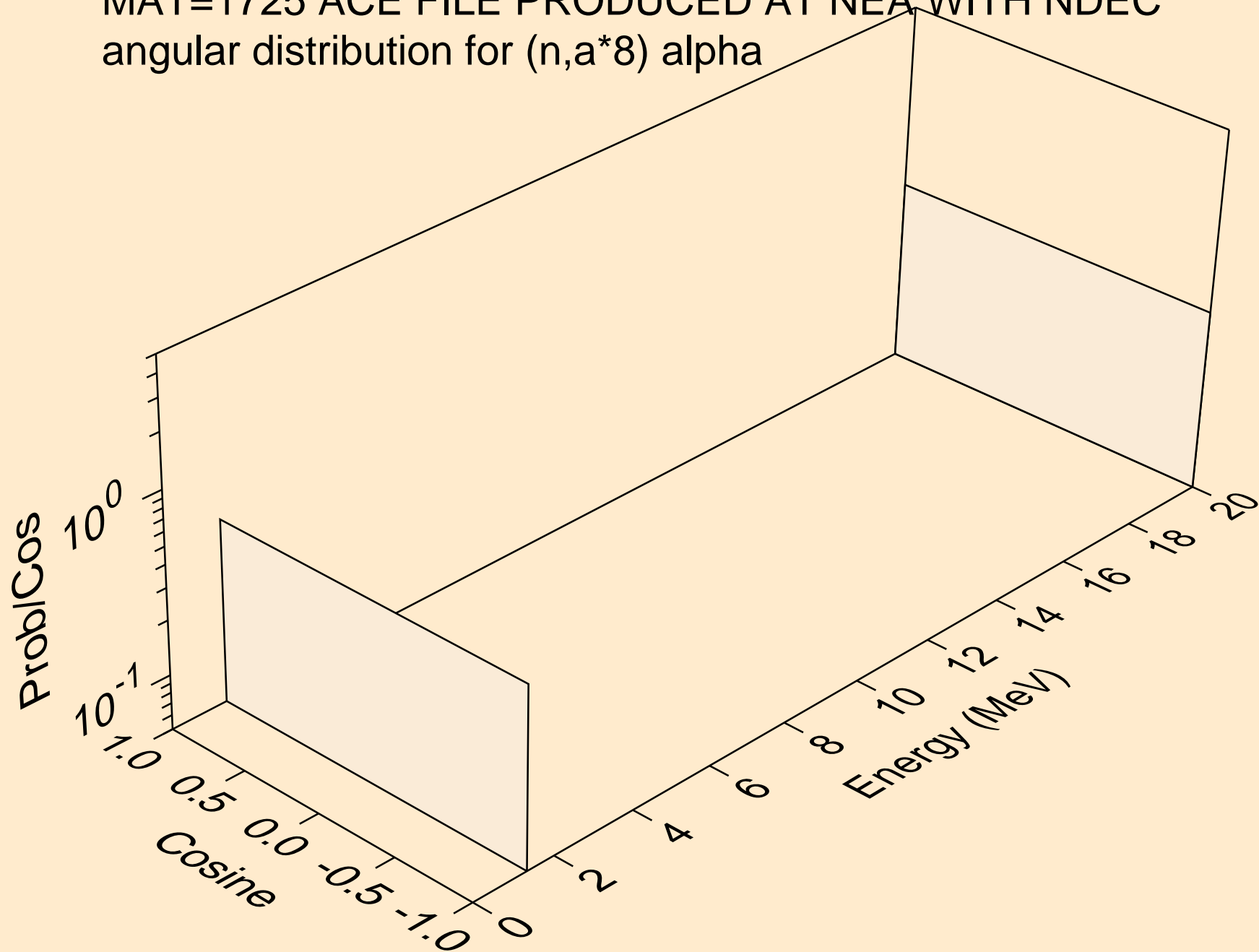

MAT=1725 ACE FILE PRODUCED AT NEA WITH NDEC
angular distribution for (n,a*9) alpha

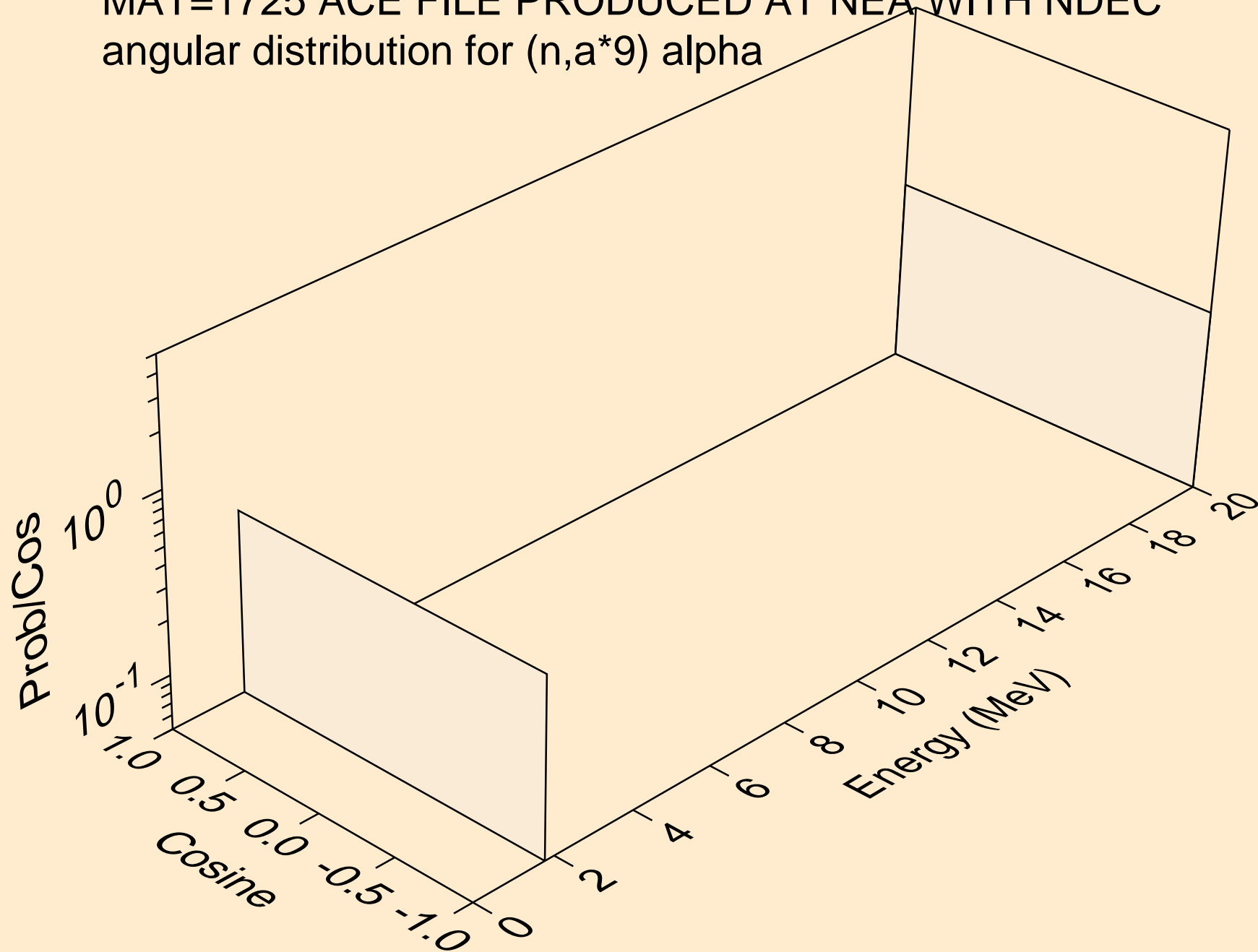

MAT=1725 ACE FILE PRODUCED AT NEA WITH NDEC
angular distribution for (n,a*10) alpha

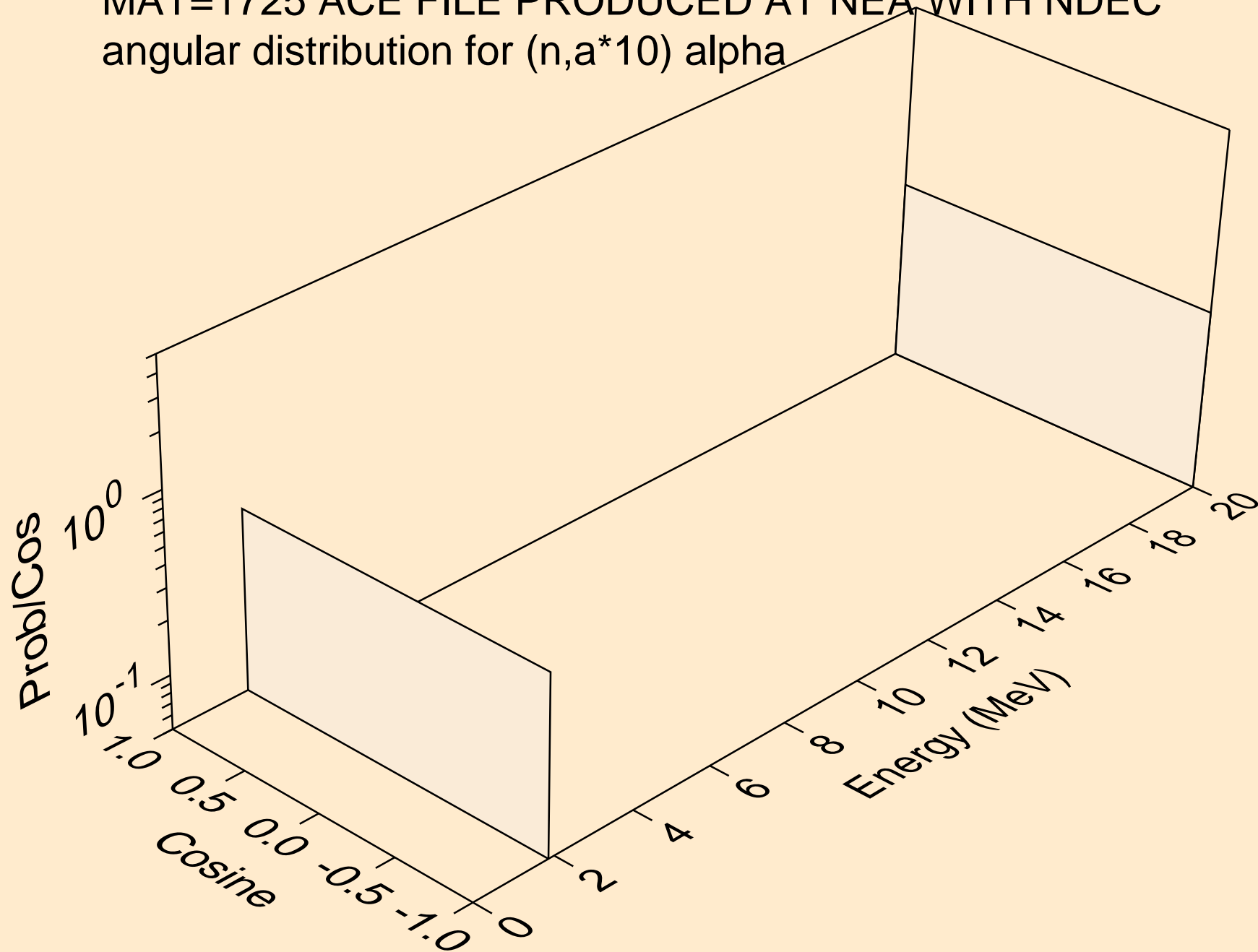

MAT=1725 ACE FILE PRODUCED AT NEA WITH NDEC
angular distribution for (n,a*11) alpha

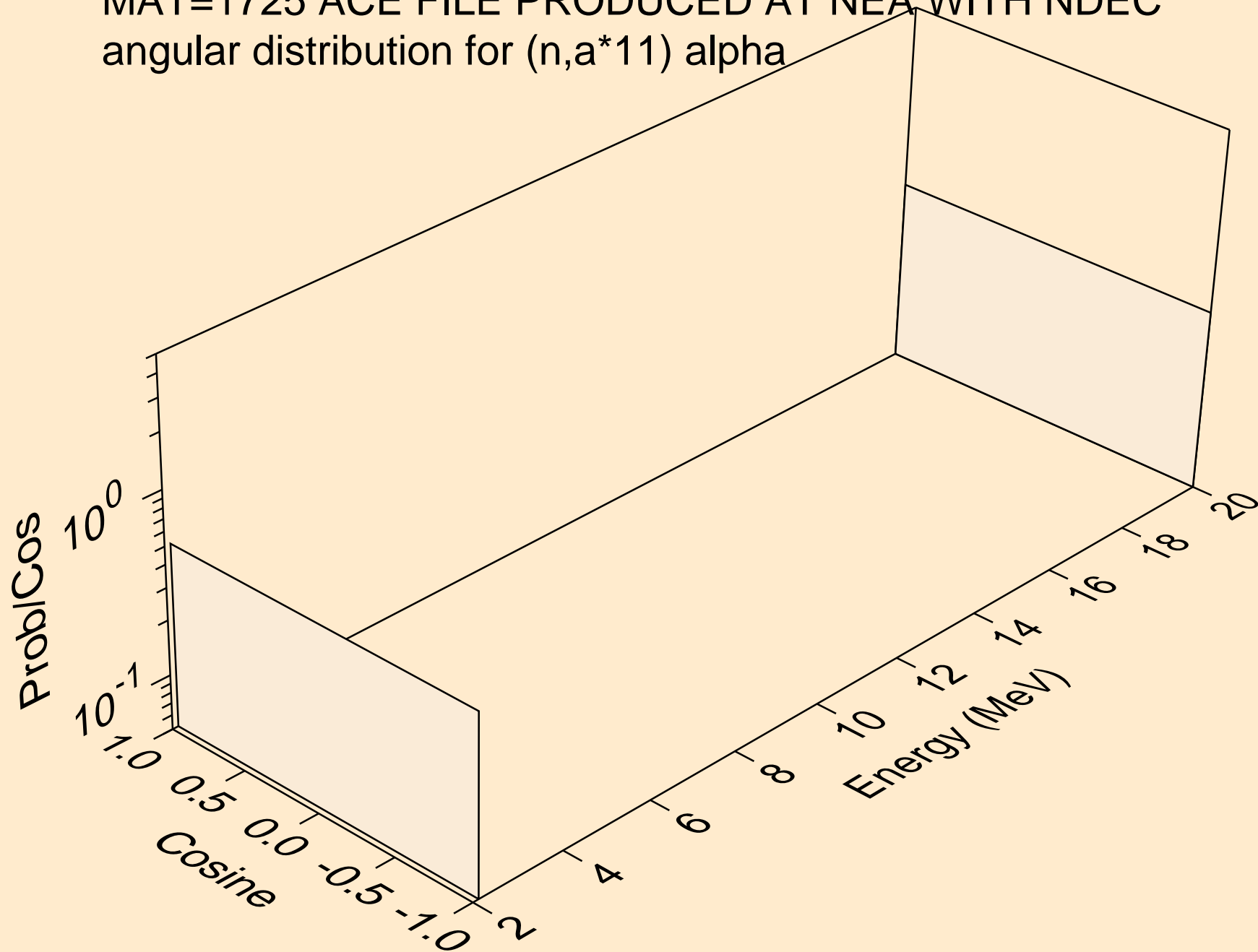

MAT=1725 ACE FILE PRODUCED AT NEA WITH NDEC
angular distribution for (n,a*12) alpha

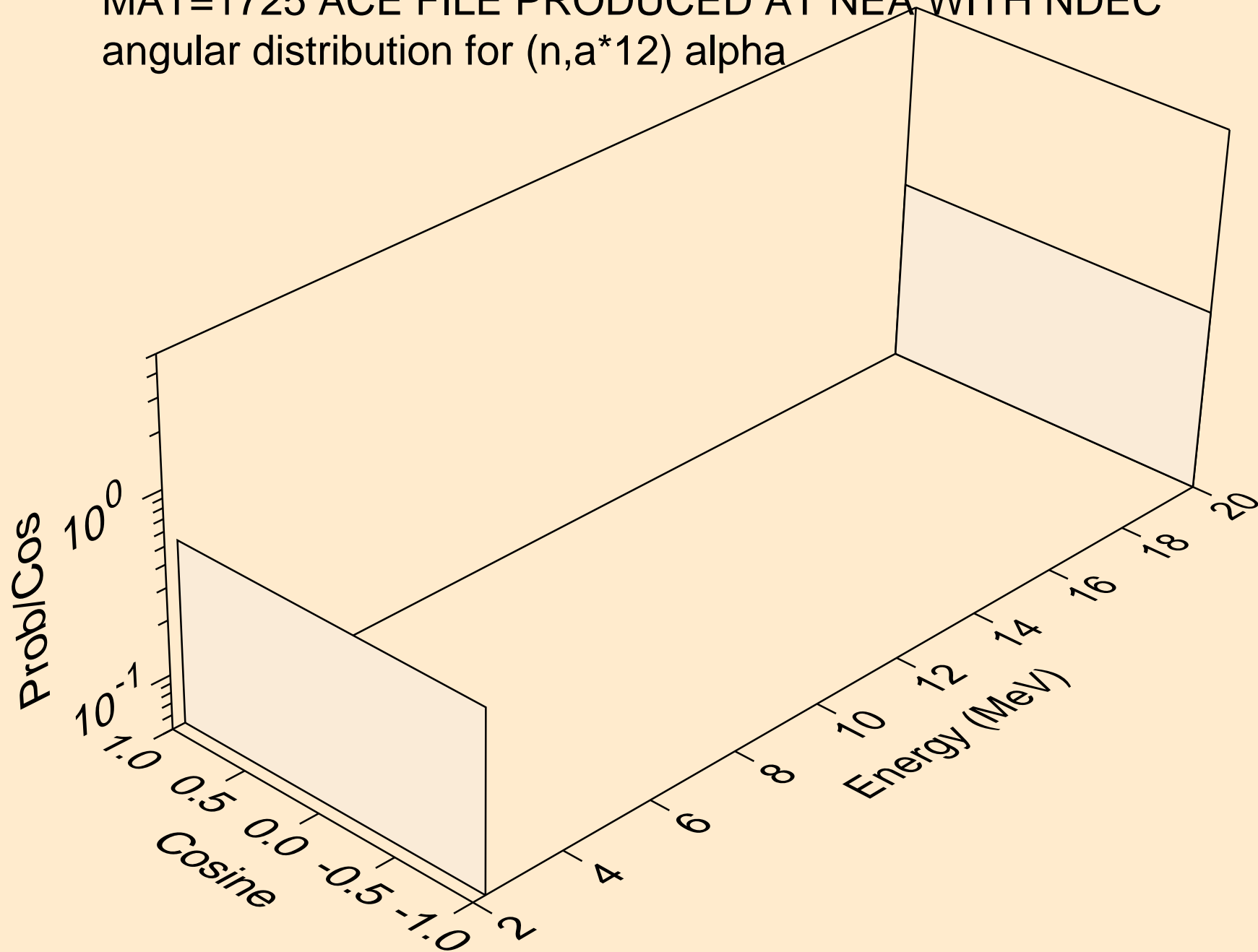

MAT=1725 ACE FILE PRODUCED AT NEA WITH NDEC
angular distribution for (n,a*13) alpha

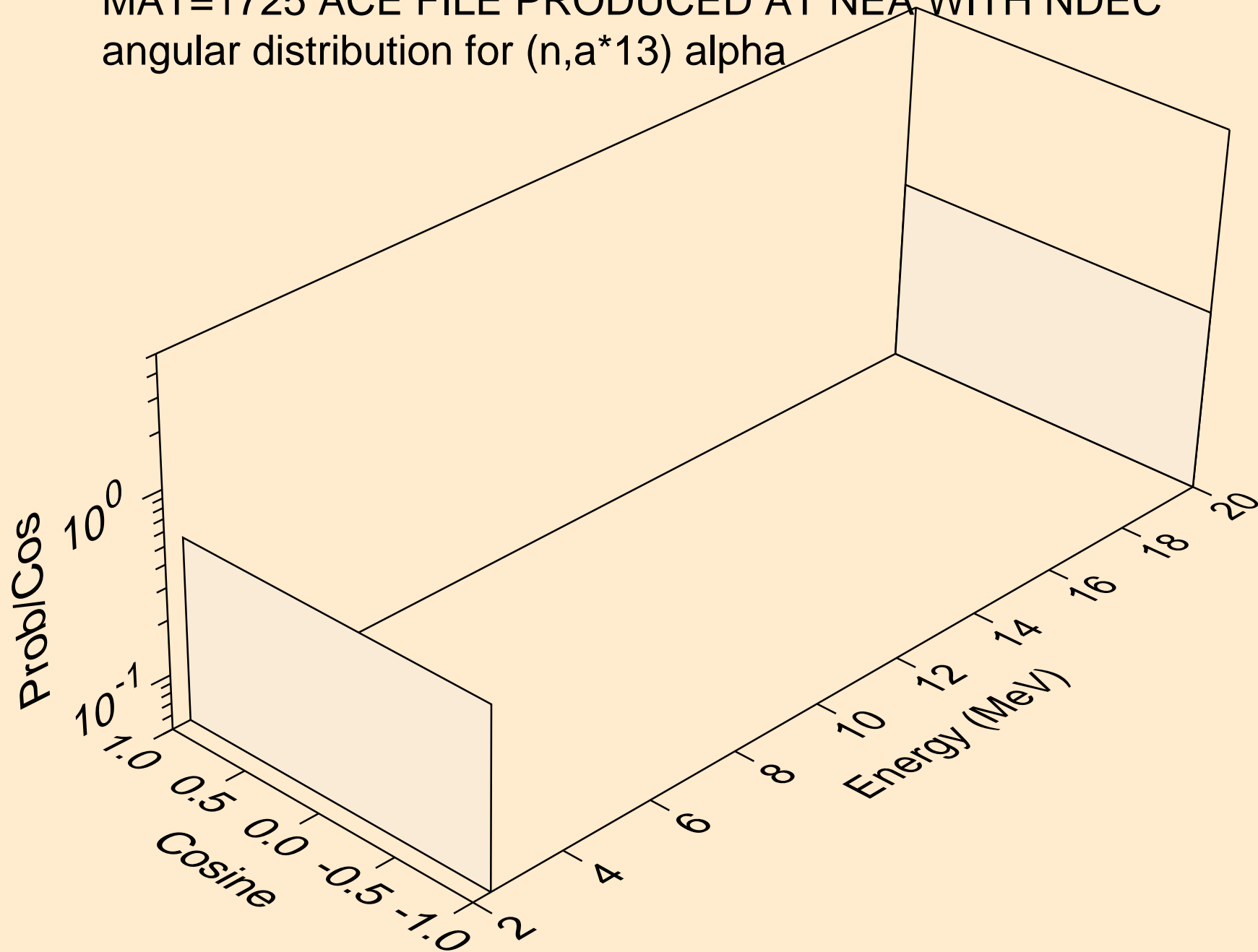

MAT=1725 ACE FILE PRODUCED AT NEA WITH NDEC
angular distribution for (n,a*14) alpha

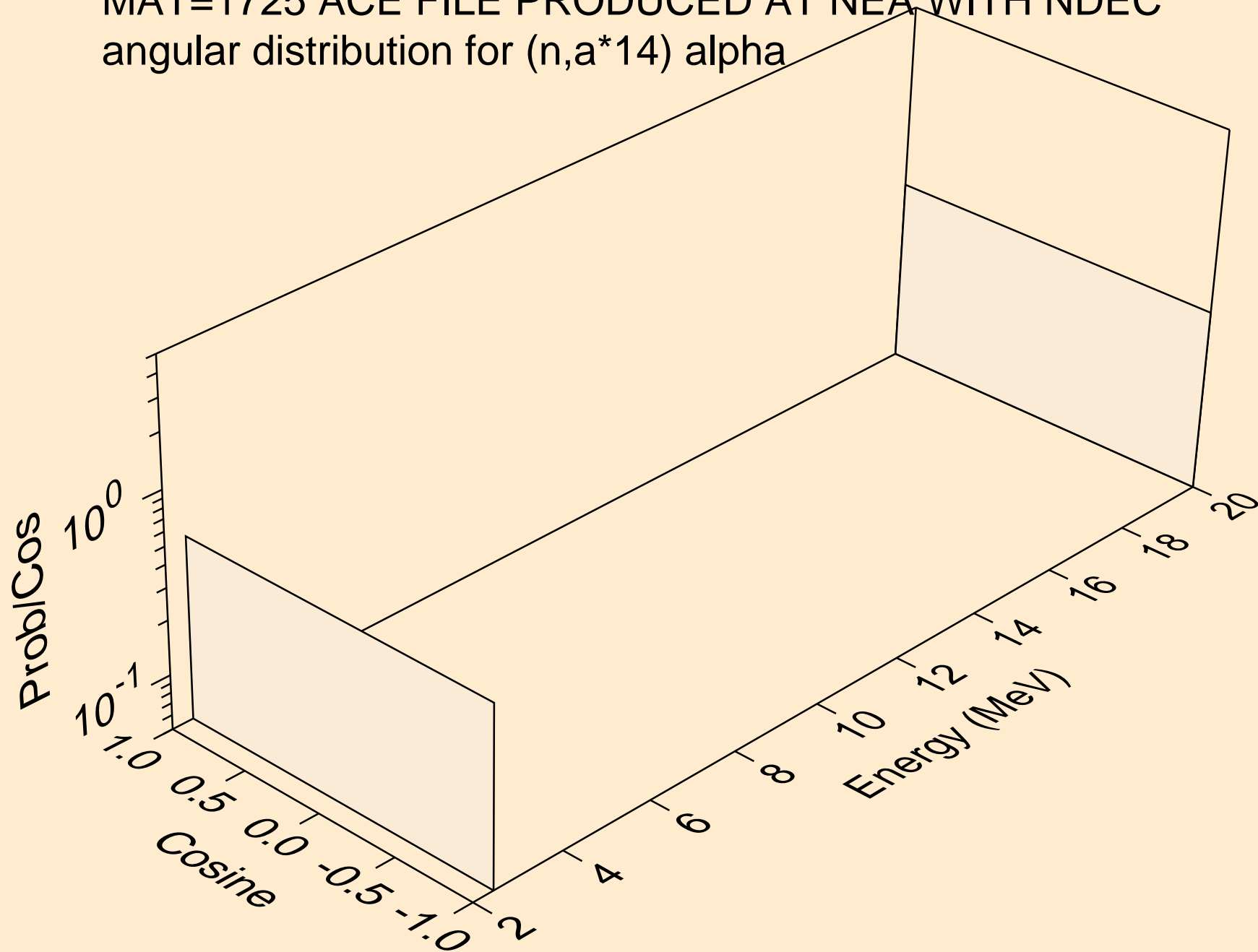

MAT=1725 ACE FILE PRODUCED AT NEA WITH NDEC
angular distribution for (n,a*15) alpha

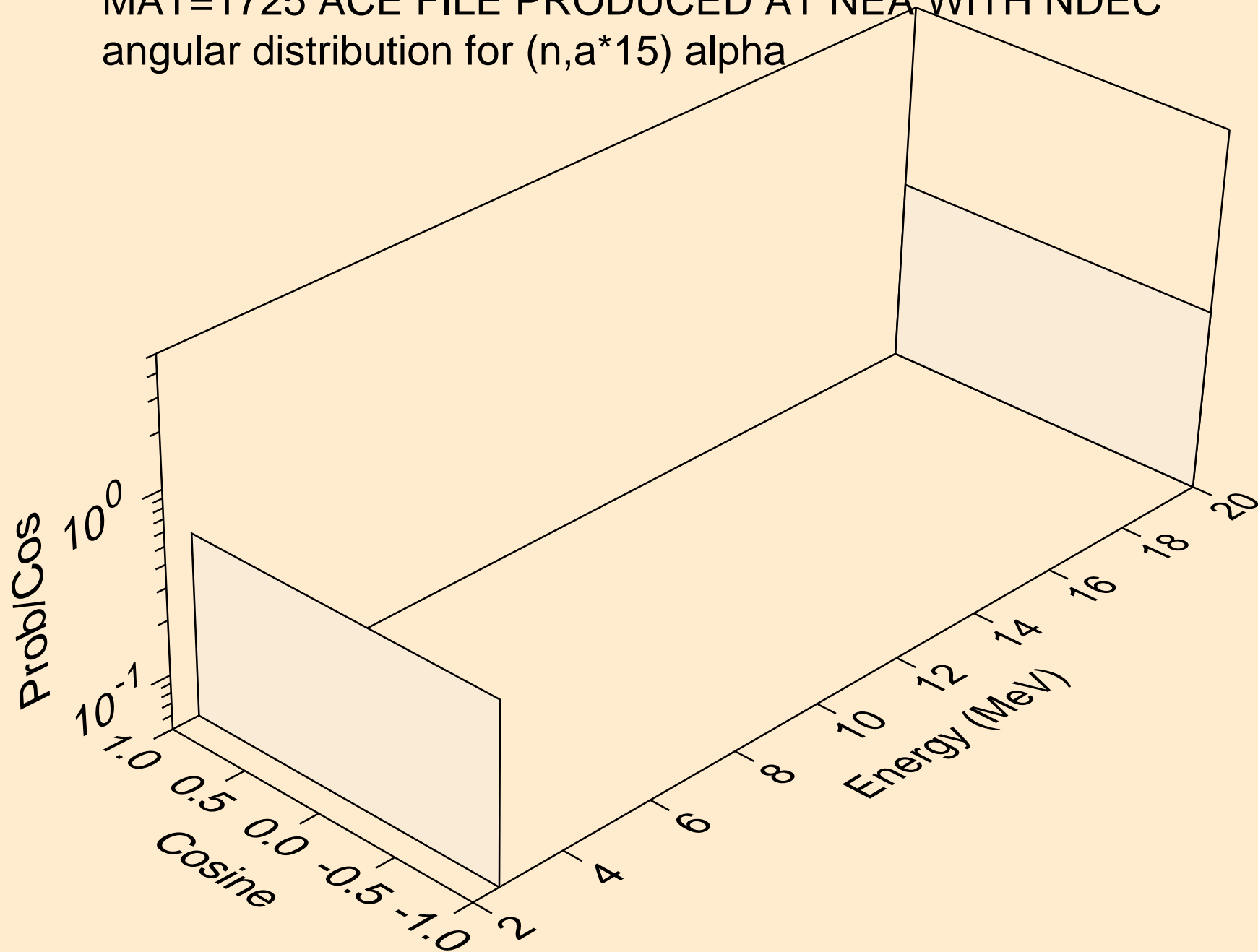

MAT=1725 ACE FILE PRODUCED AT NEA WITH NDEC
angular distribution for (n,a*16) alpha

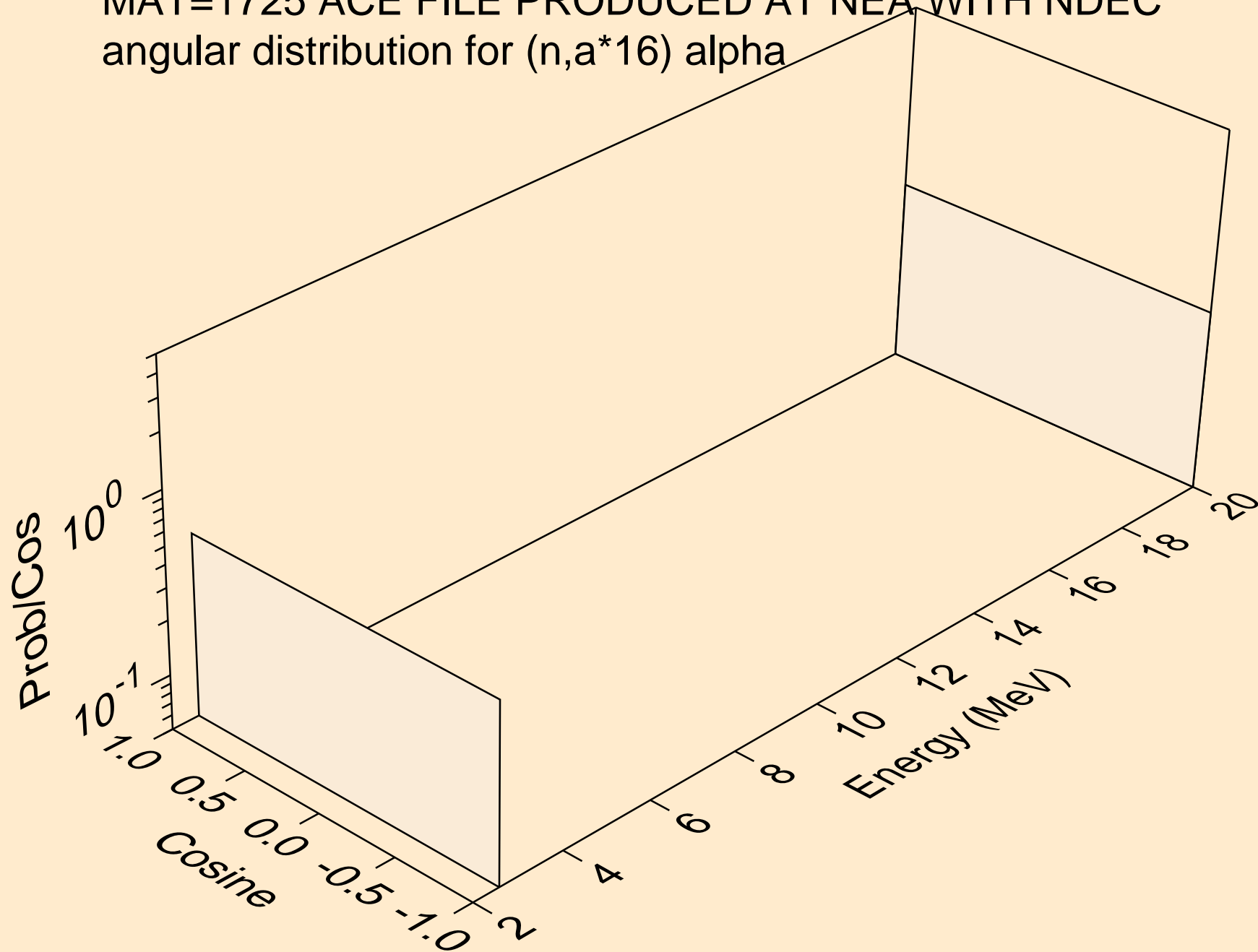

MAT=1725 ACE FILE PRODUCED AT NEA WITH NDEC
angular distribution for (n,a*17) alpha

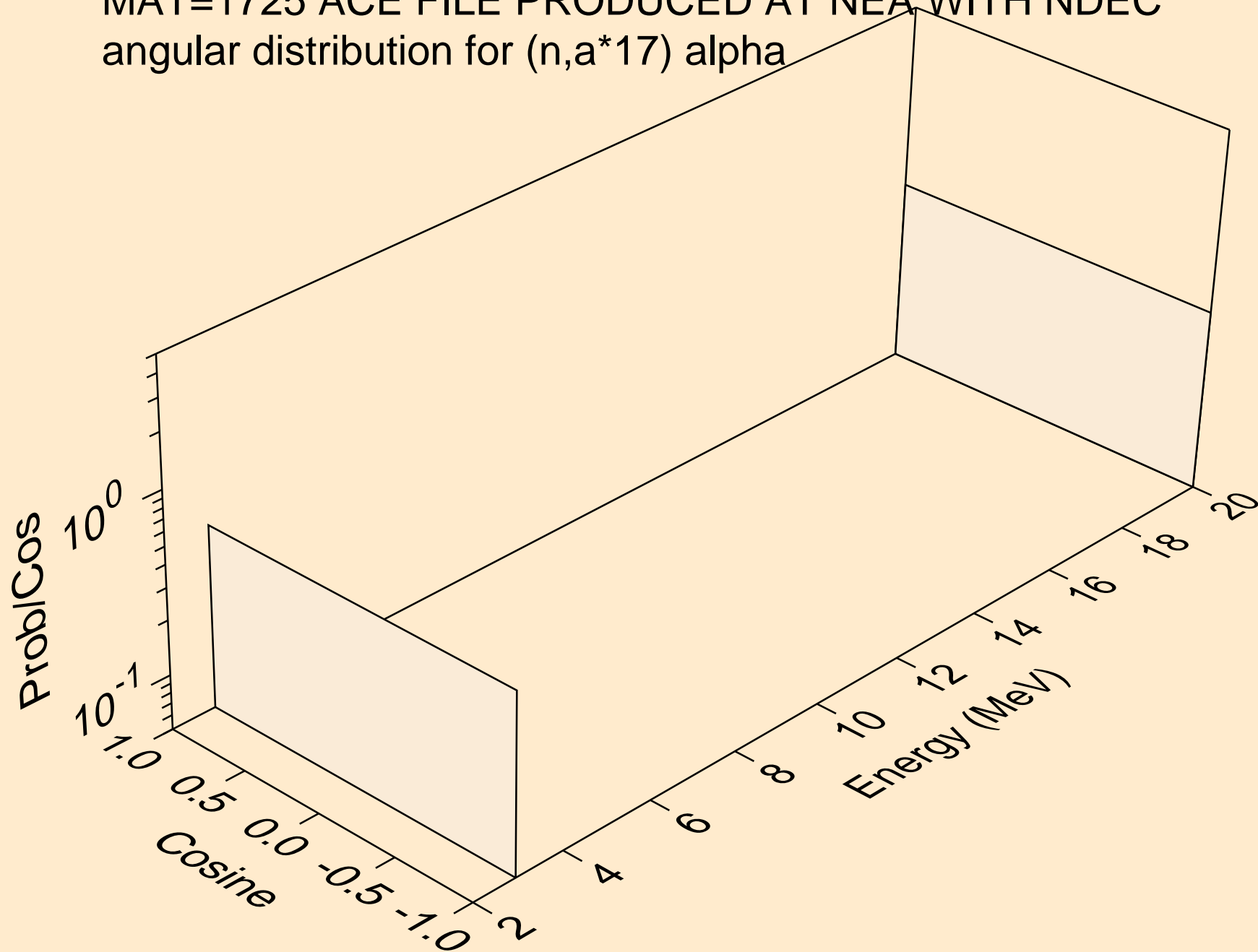

MAT=1725 ACE FILE PRODUCED AT NEA WITH NDEC
angular distribution for (n,a*18) alpha

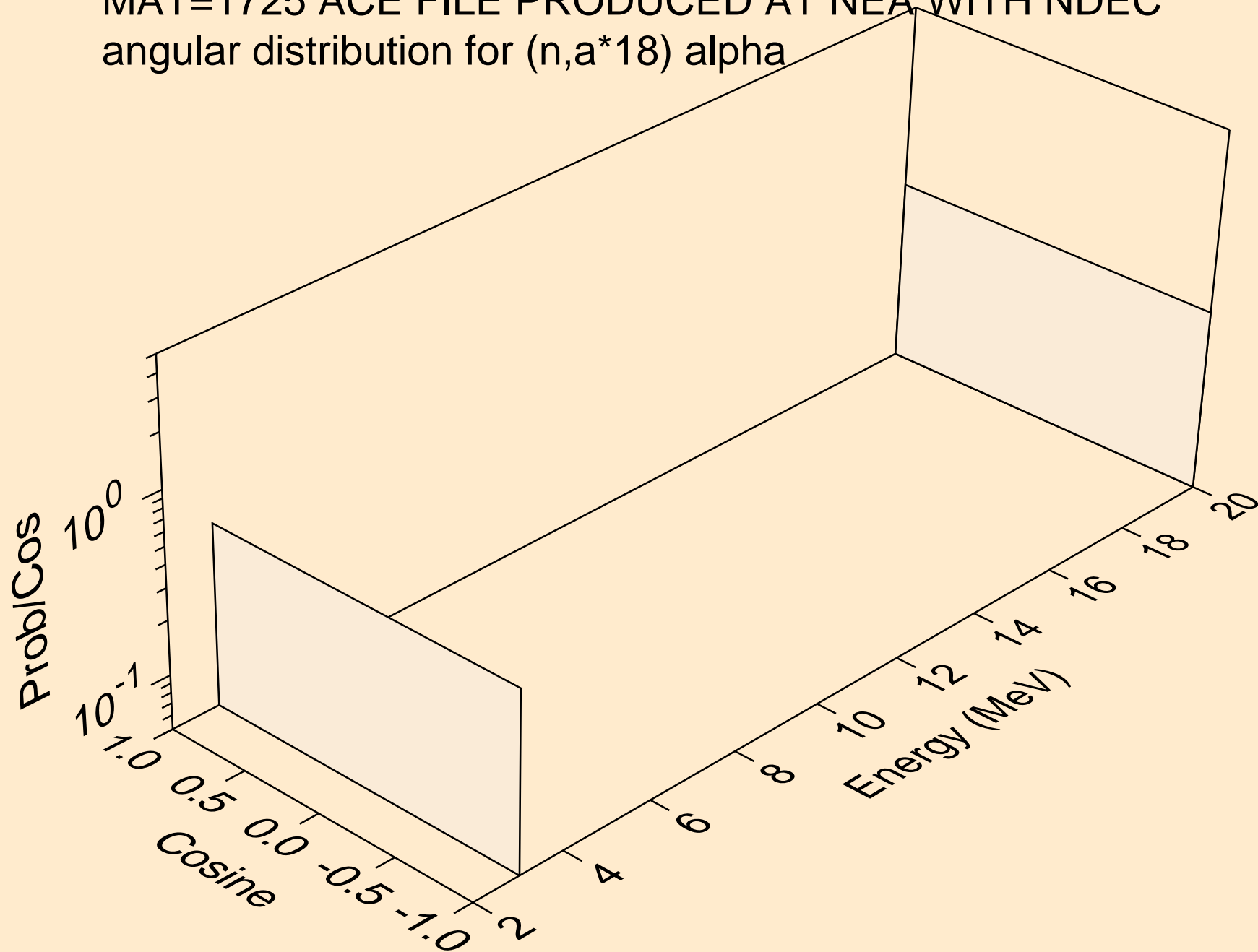

MAT=1725 ACE FILE PRODUCED AT NEA WITH NDEC
angular distribution for (n,a*19) alpha

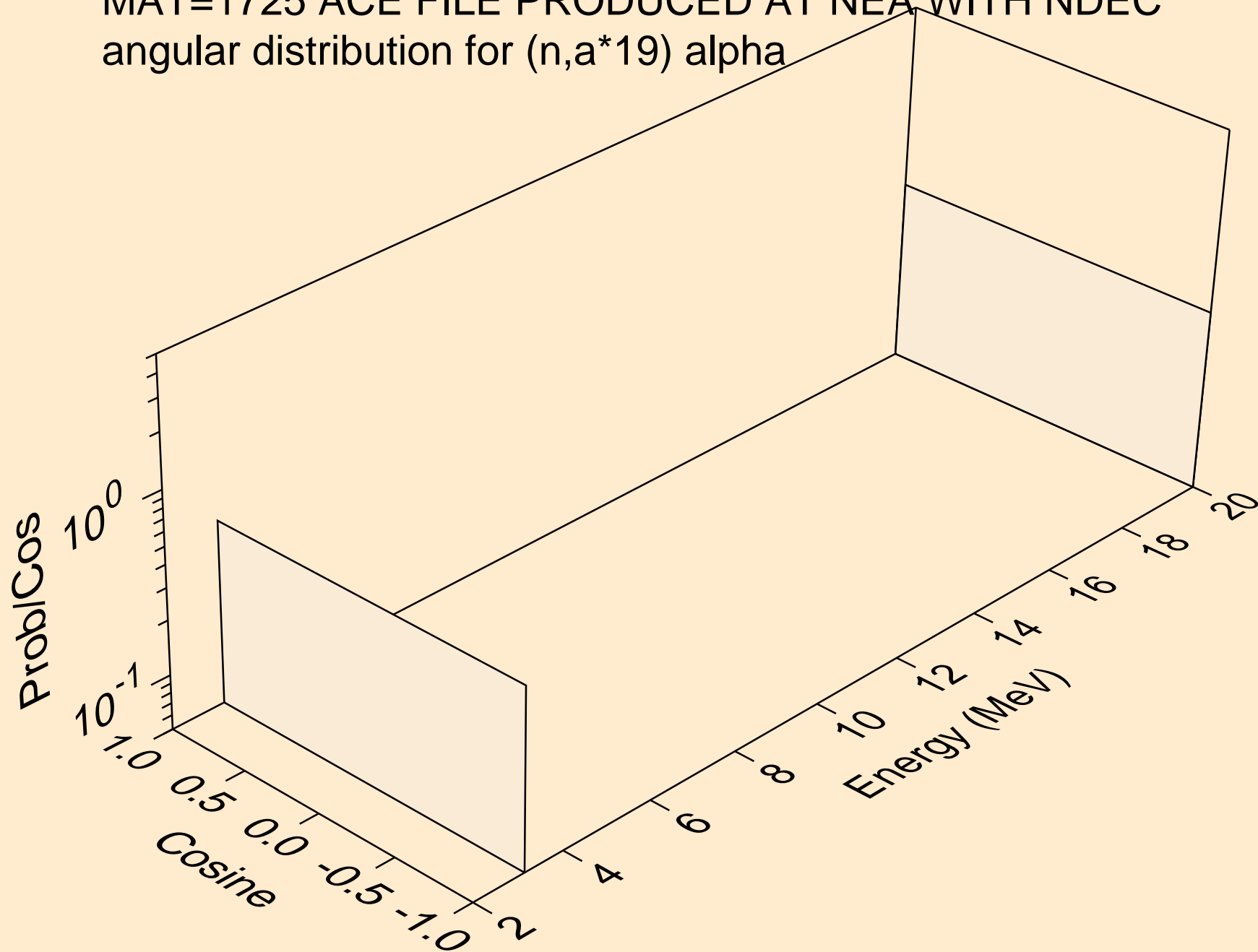

MAT=1725 ACE FILE PRODUCED AT NEA WITH NDEC
angular distribution for (n,a*20) alpha

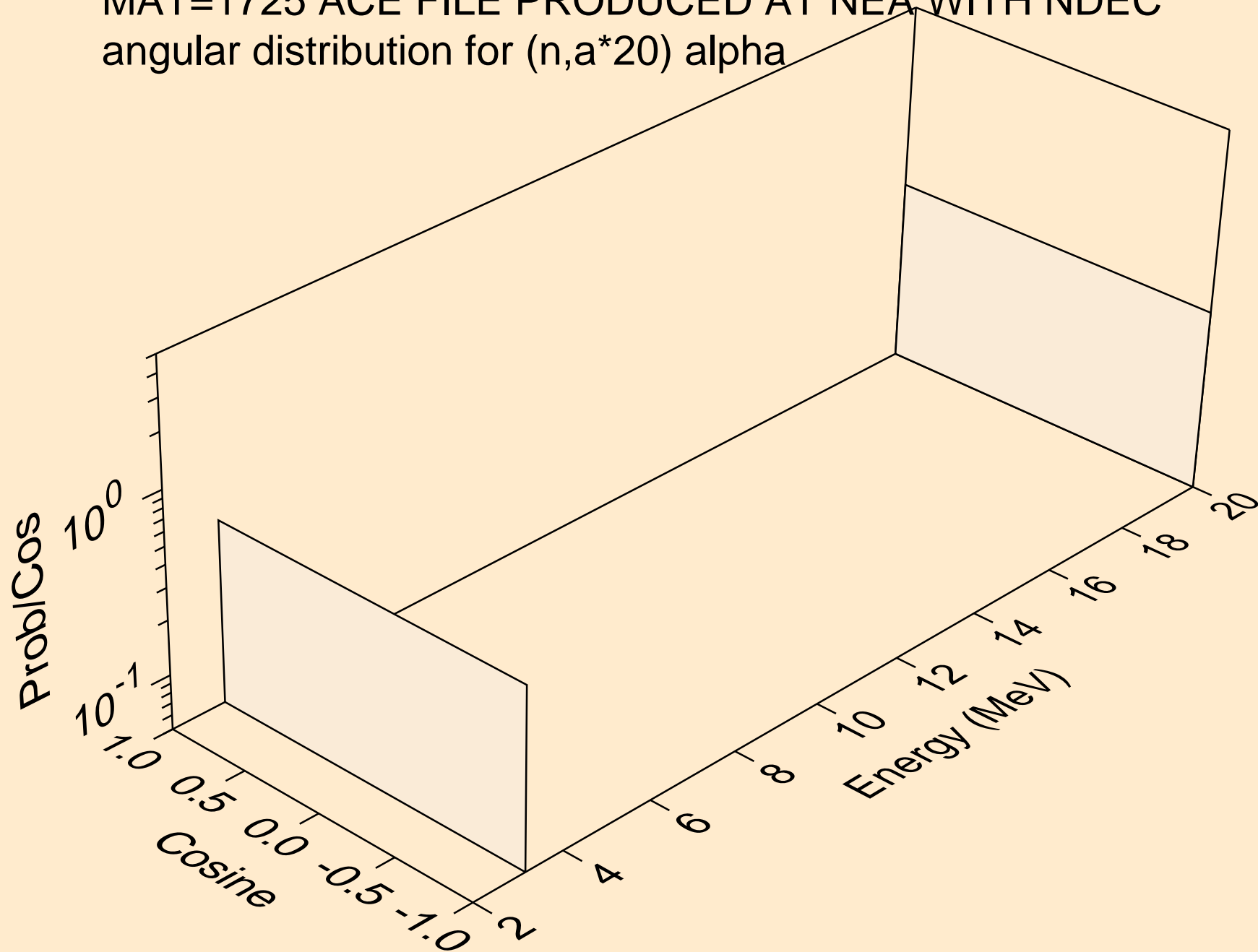

MAT=1725 ACE FILE PRODUCED AT NEA WITH NDEC
alphas from (n,a*c)

