

MAT=525 ACE FILE PRODUCED AT NEA WITH NDEC
Principal cross sections

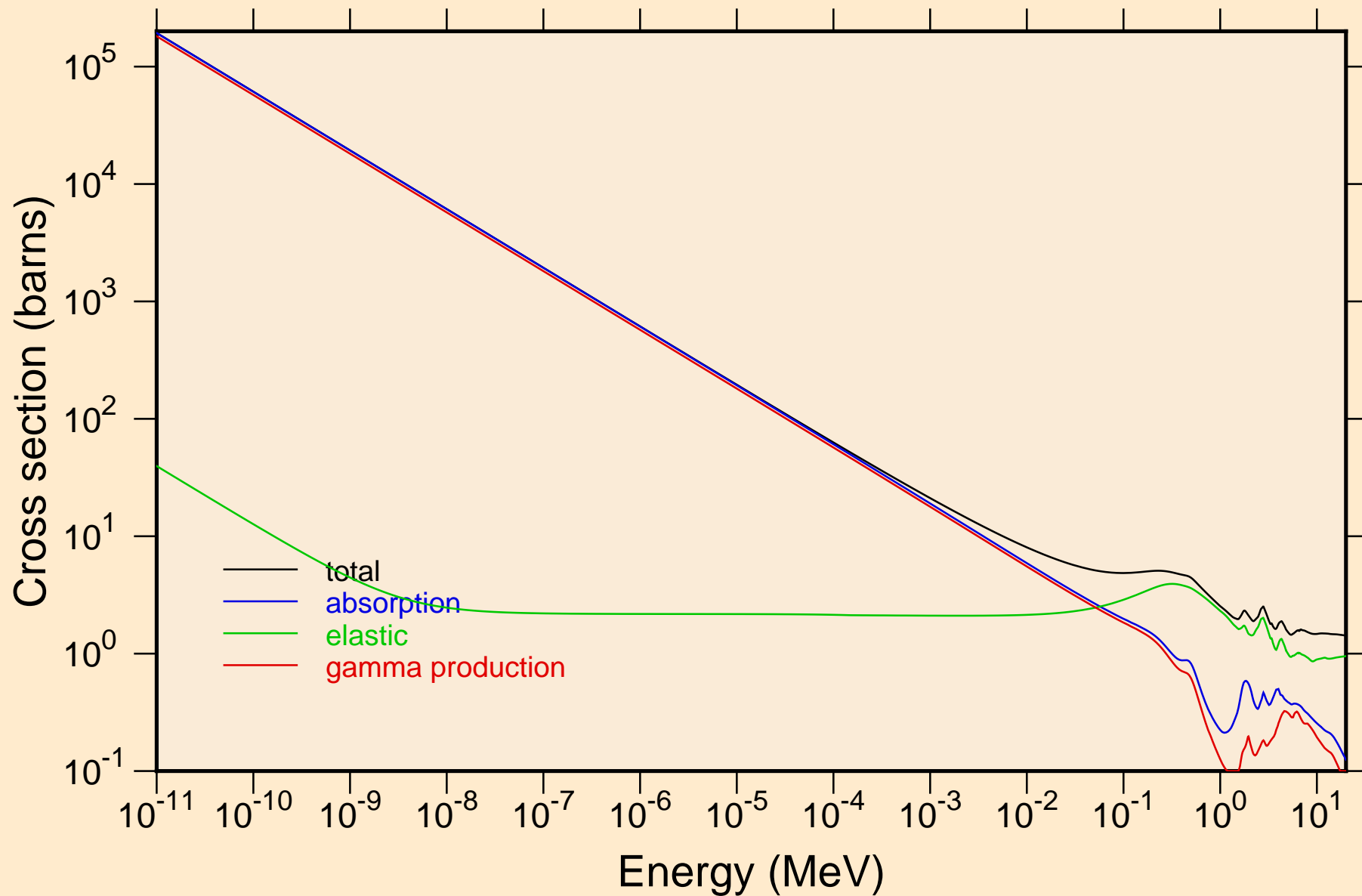

MAT=525 ACE FILE PRODUCED AT NEA WITH NDEC
Heating

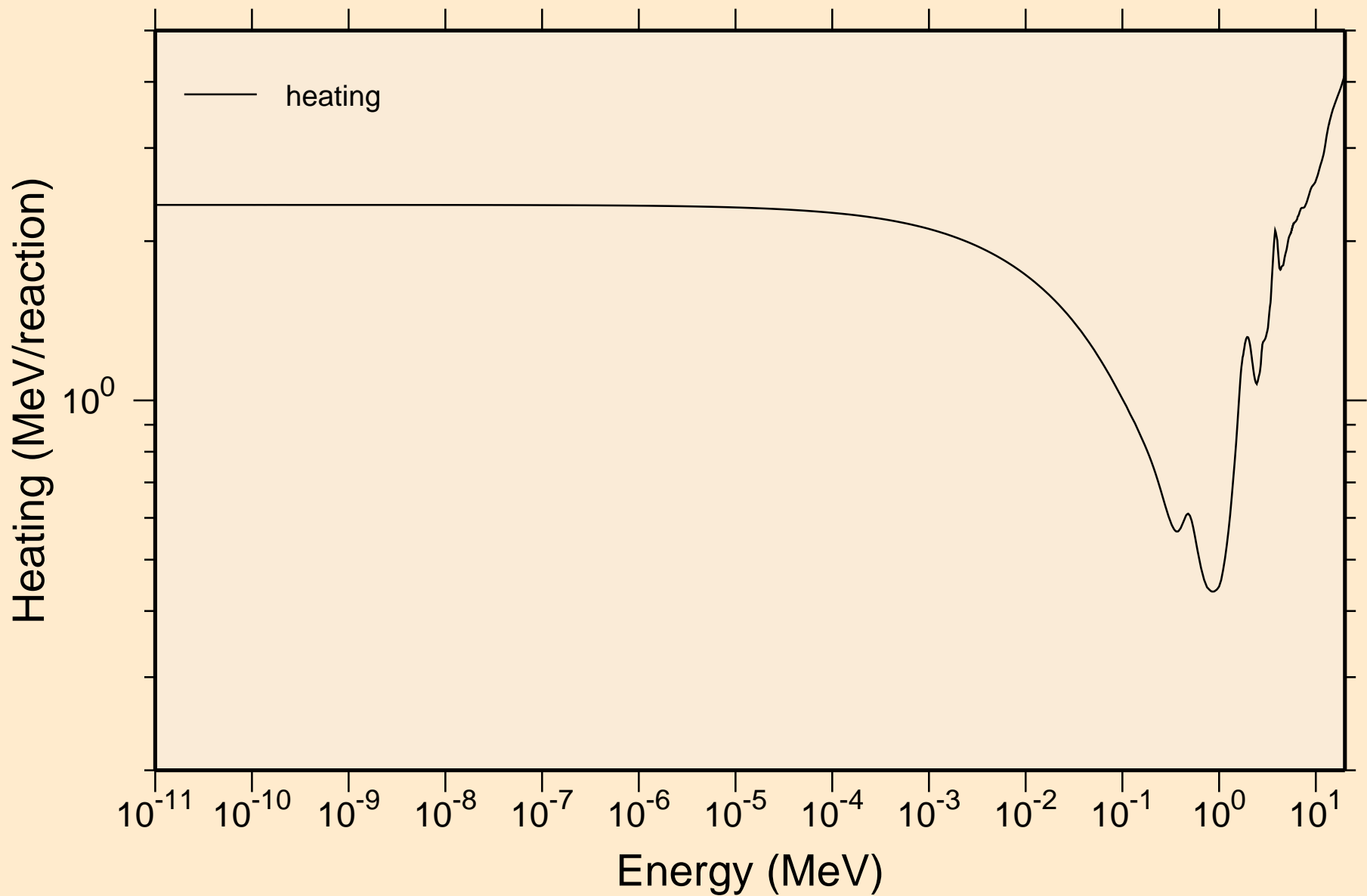

MAT=525 ACE FILE PRODUCED AT NEA WITH NDEC
Damage

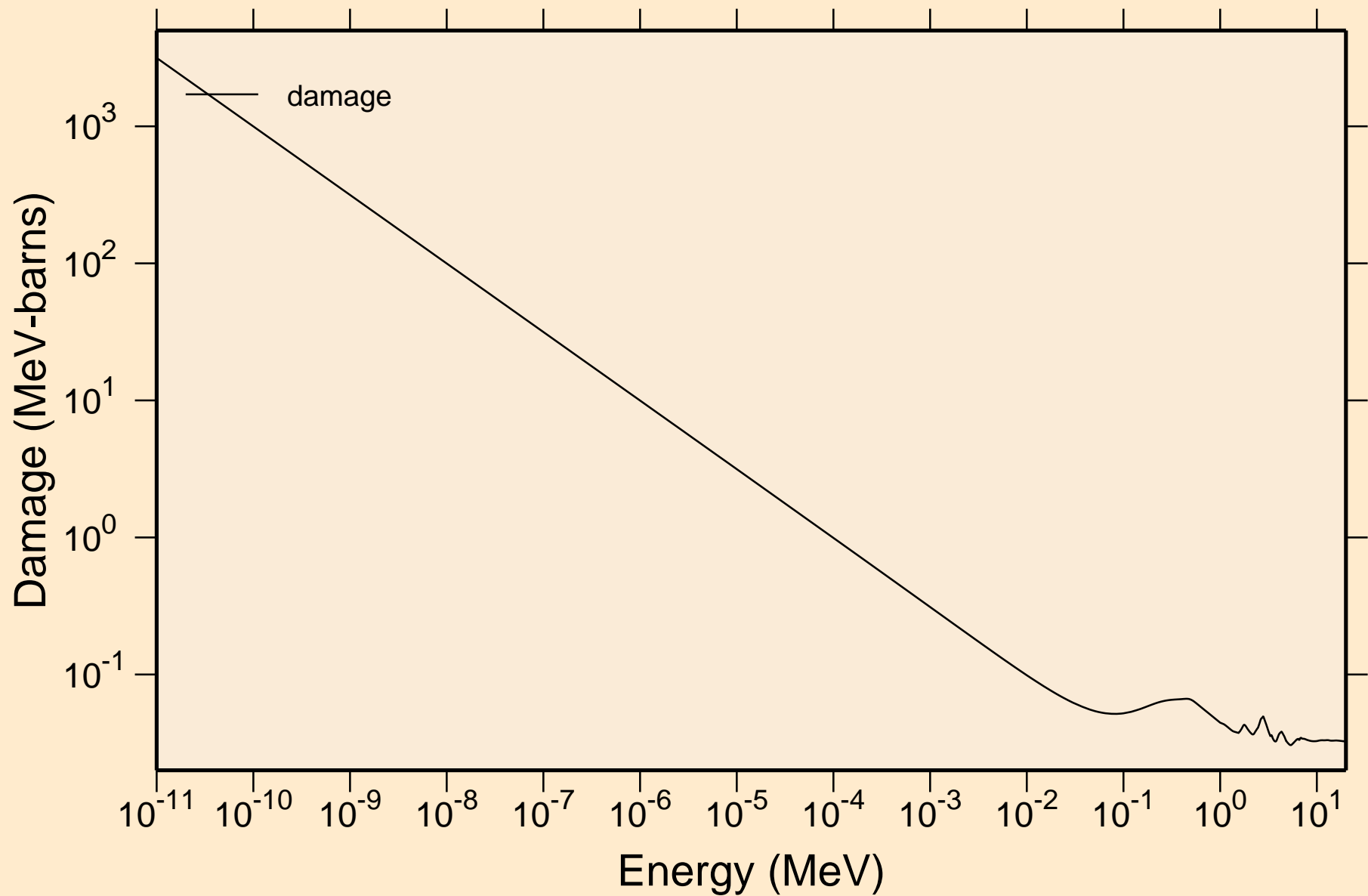

MAT=525 ACE FILE PRODUCED AT NEA WITH NDEC
Non-threshold reactions

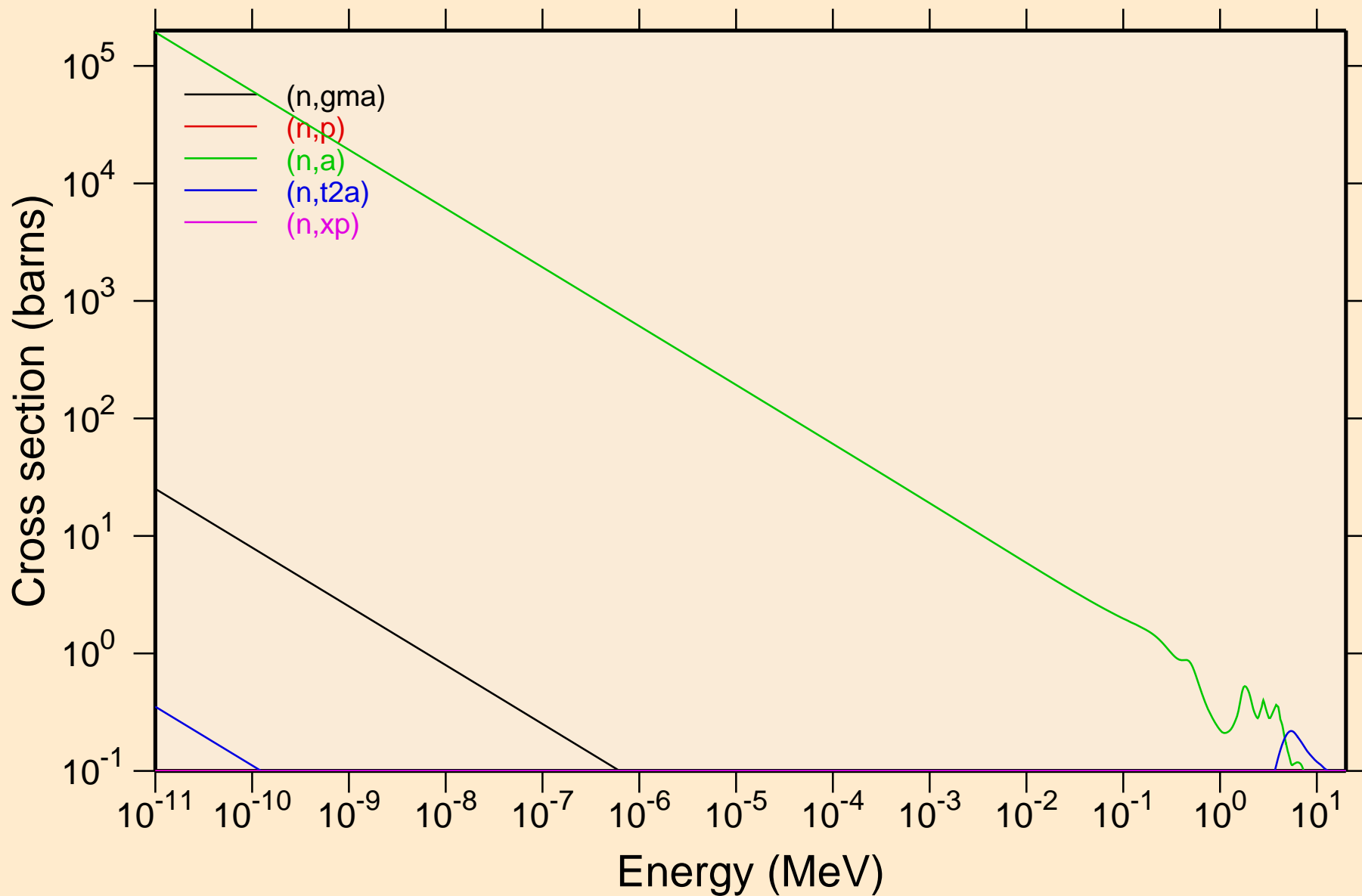

MAT=525 ACE FILE PRODUCED AT NEA WITH NDEC
Non-threshold reactions

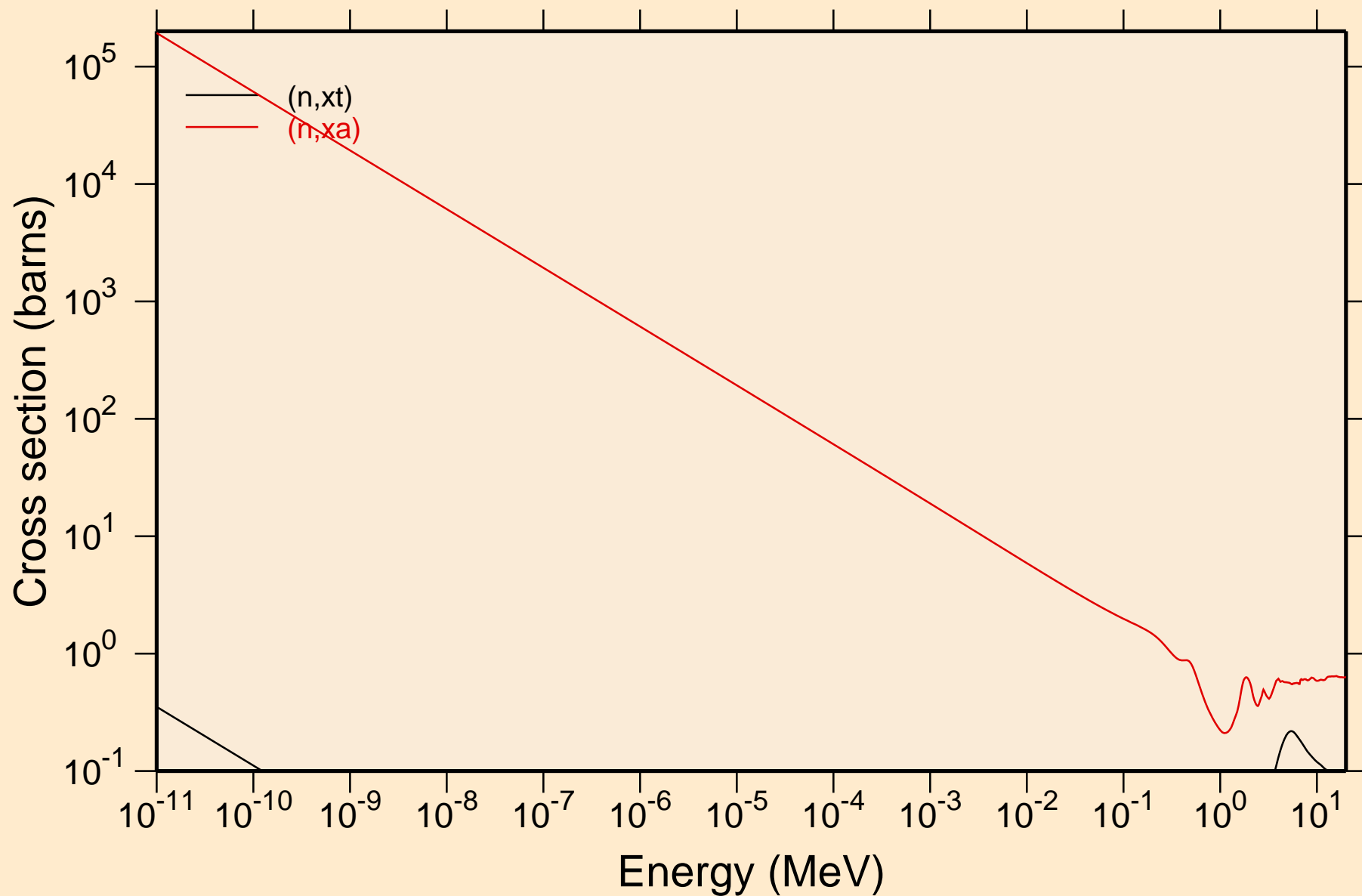

MAT=525 ACE FILE PRODUCED AT NEA WITH NDEC

Principal cross sections

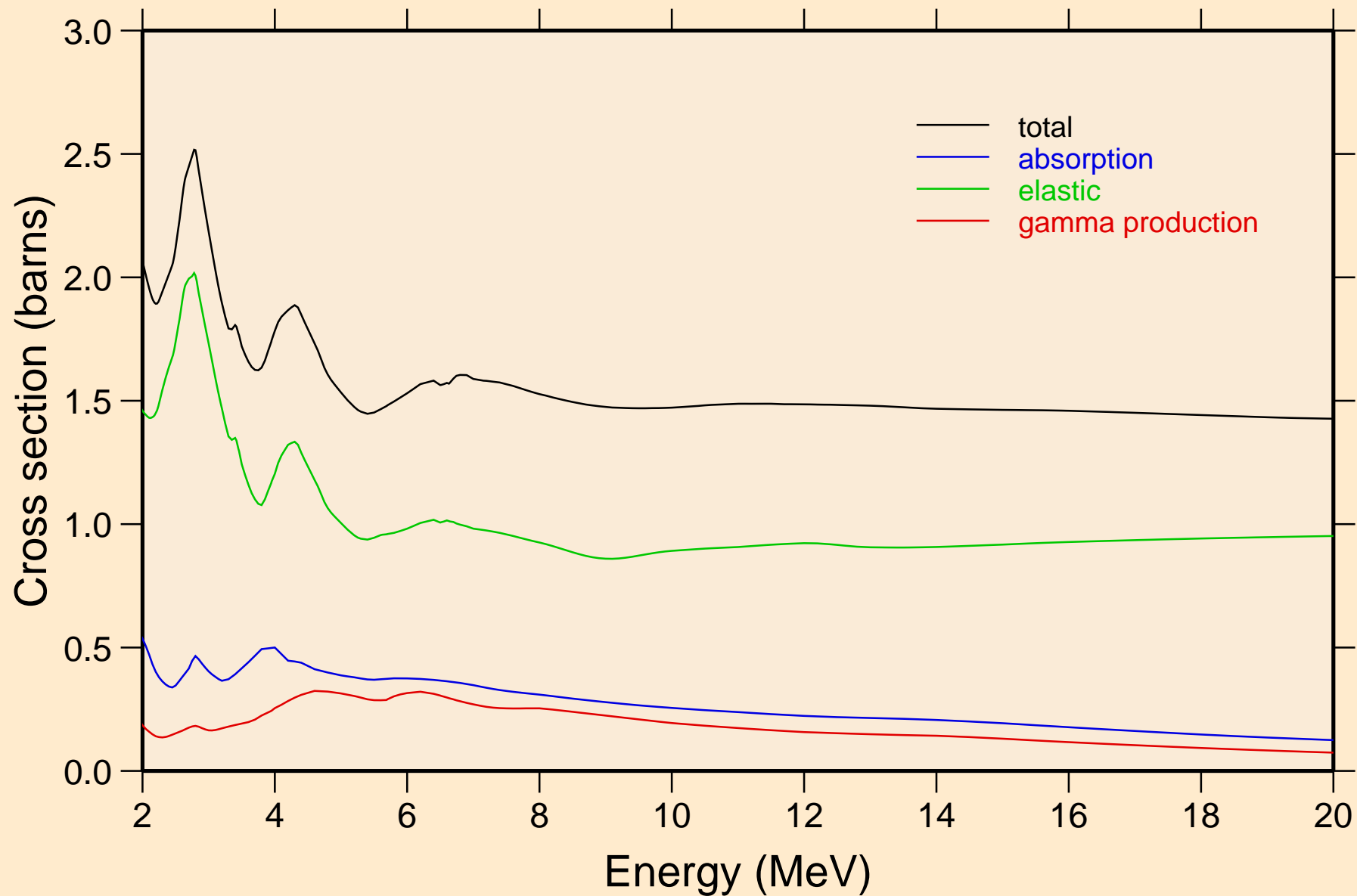

MAT=525 ACE FILE PRODUCED AT NEA WITH NDEC
Heating

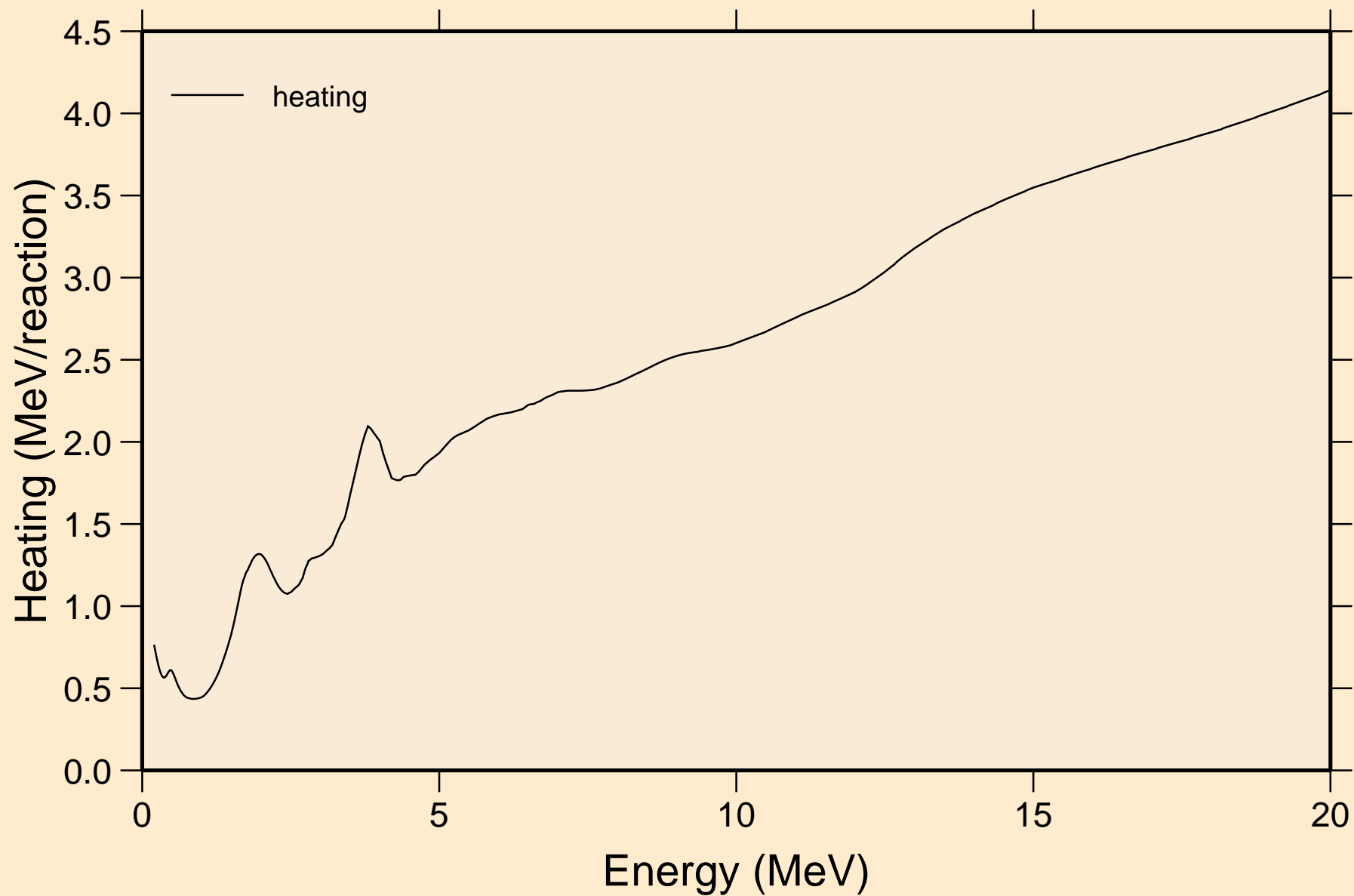

MAT=525 ACE FILE PRODUCED AT NEA WITH NDEC
Damage

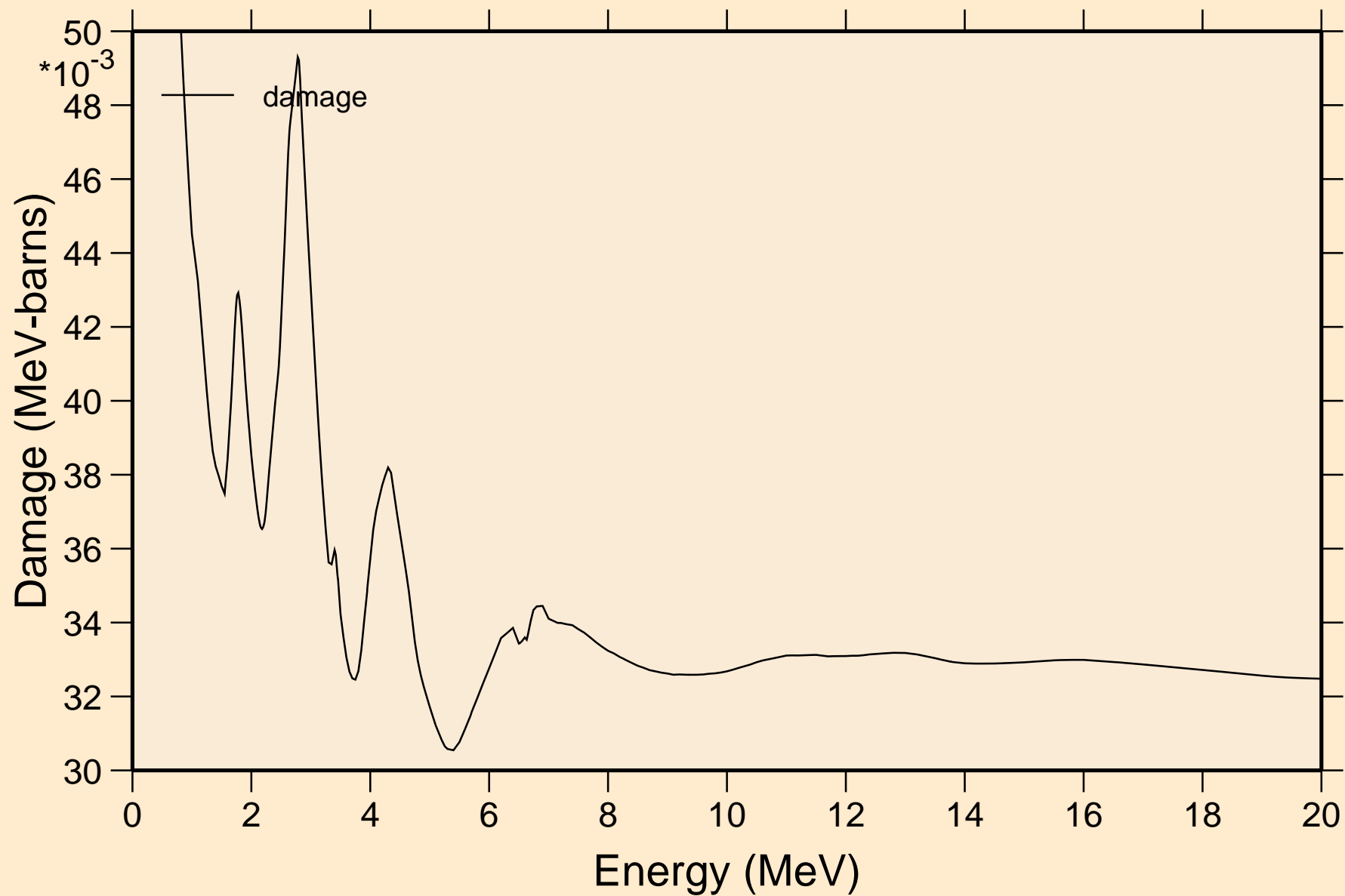

MAT=525 ACE FILE PRODUCED AT NEA WITH NDEC
Non-threshold reactions

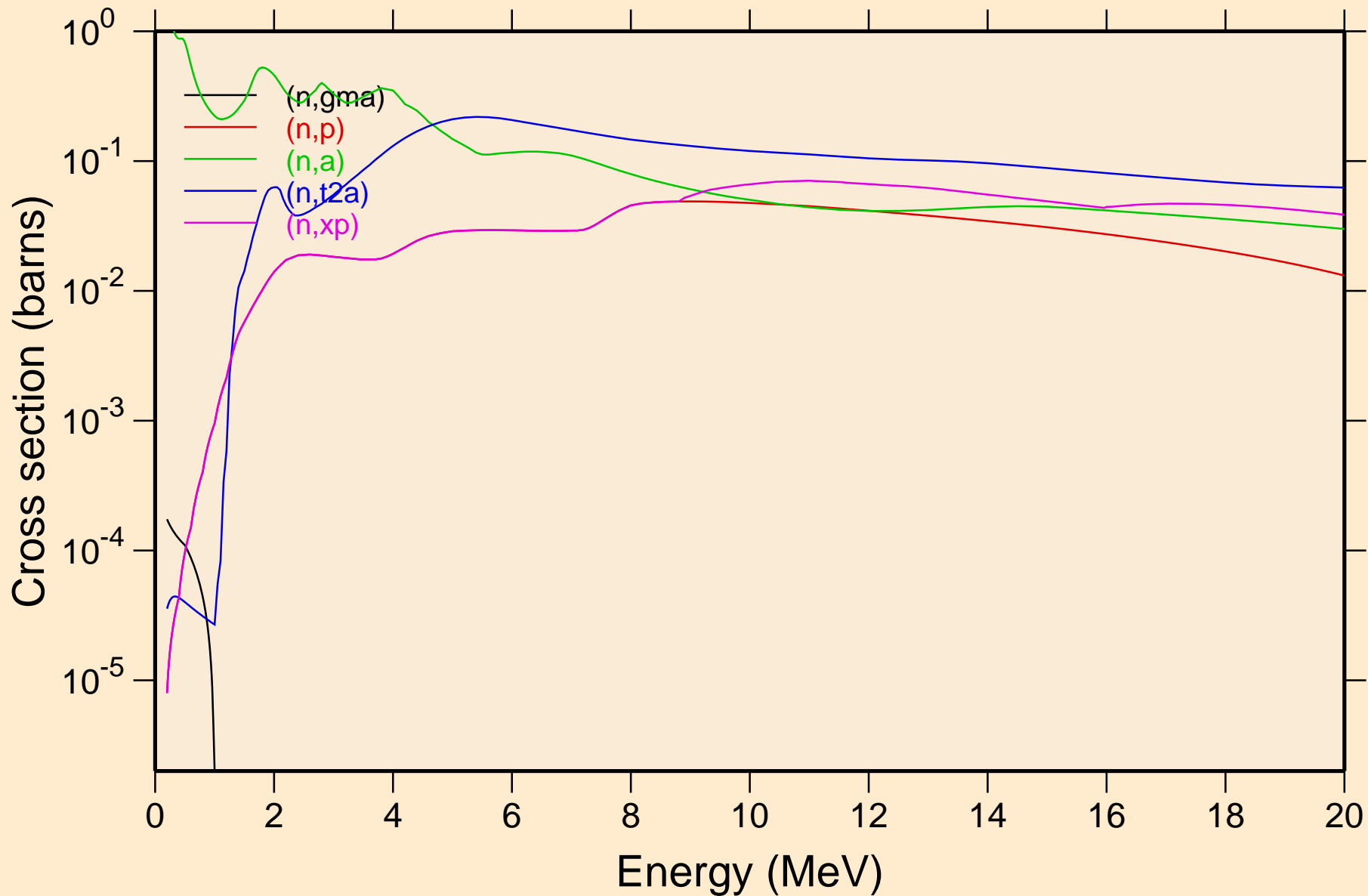

MAT=525 ACE FILE PRODUCED AT NEA WITH NDEC
Non-threshold reactions

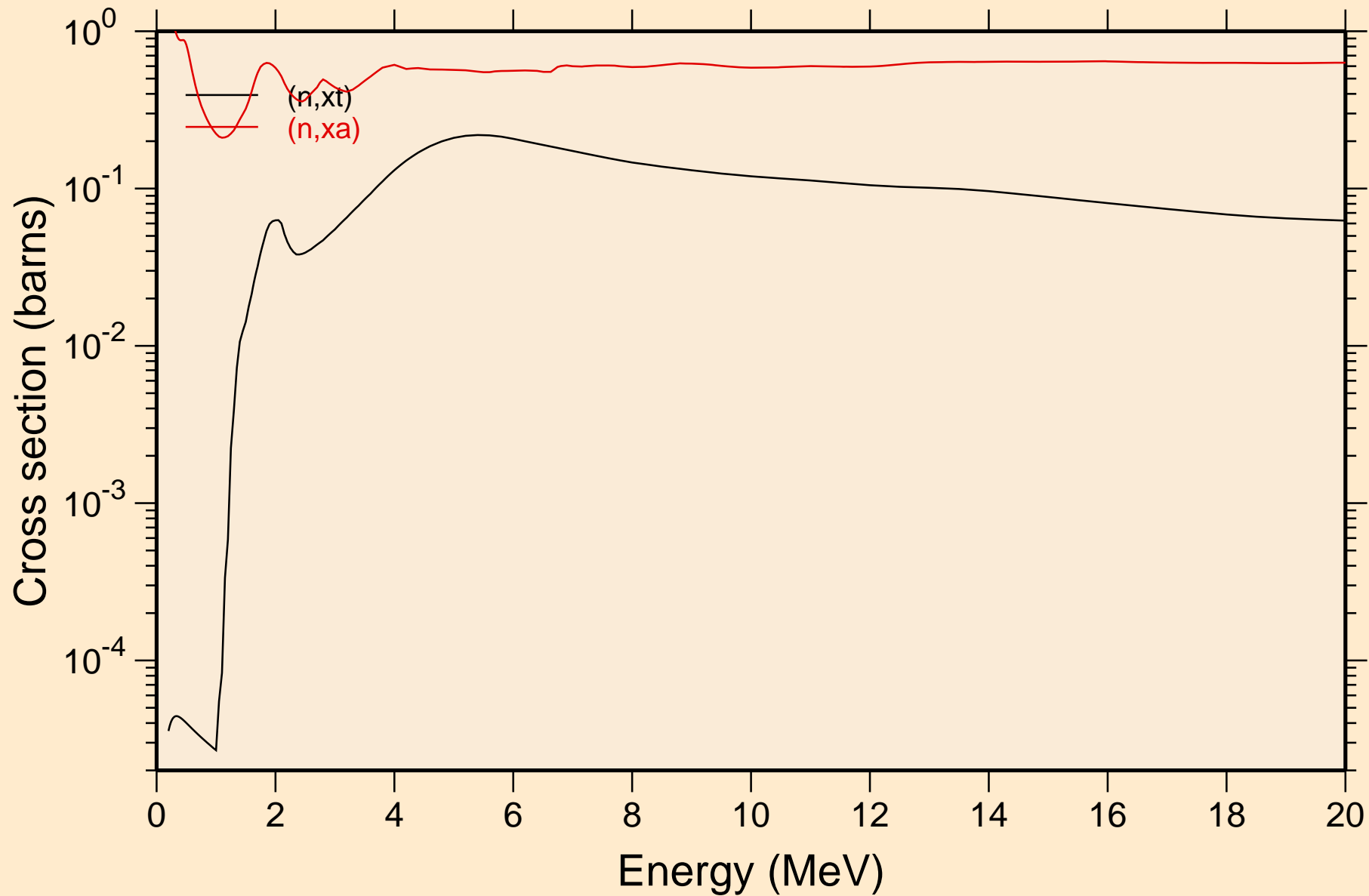

MAT=525 ACE FILE PRODUCED AT NEA WITH NDEC
Inelastic levels

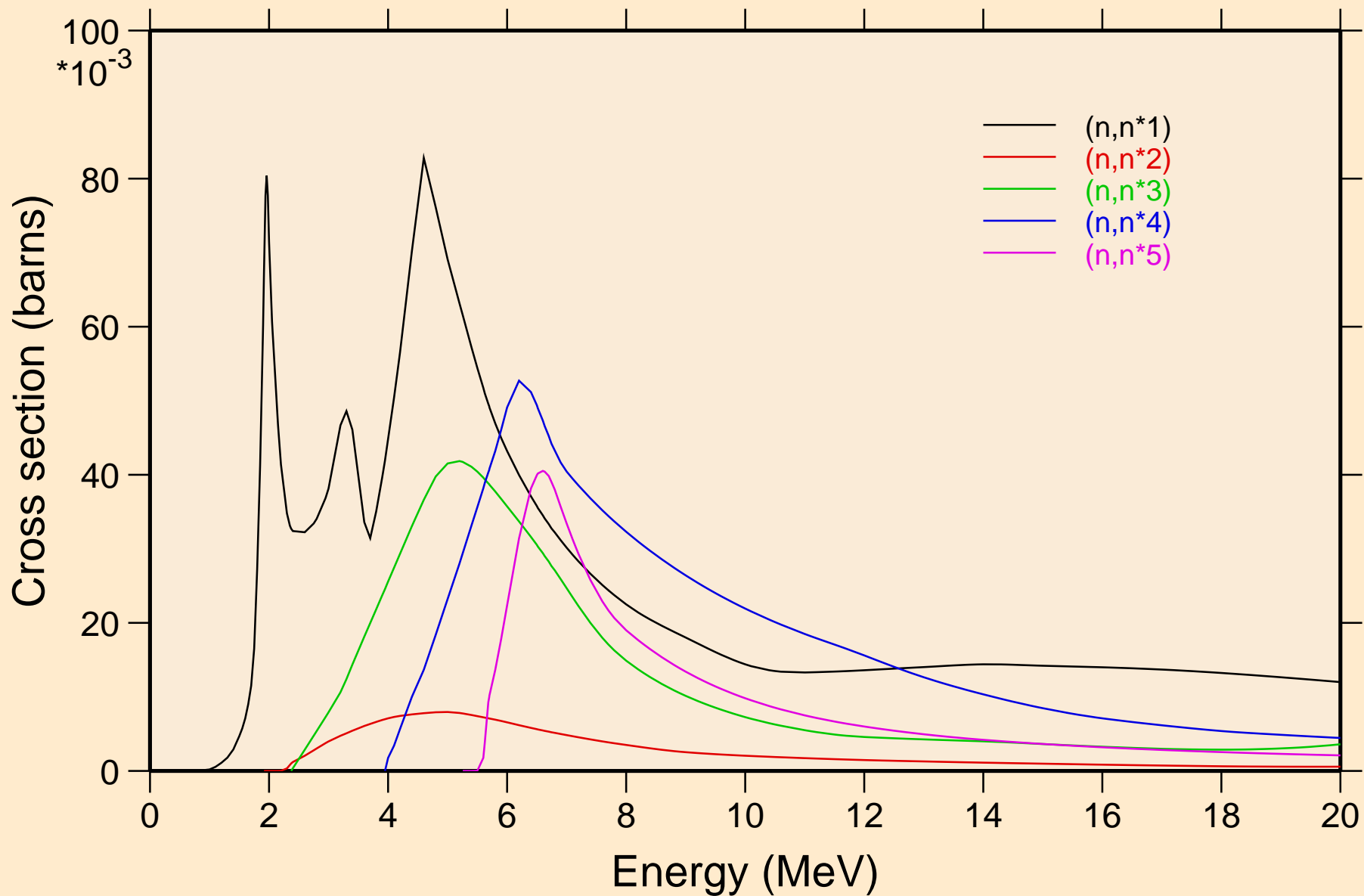

MAT=525 ACE FILE PRODUCED AT NEA WITH NDEC
Inelastic levels

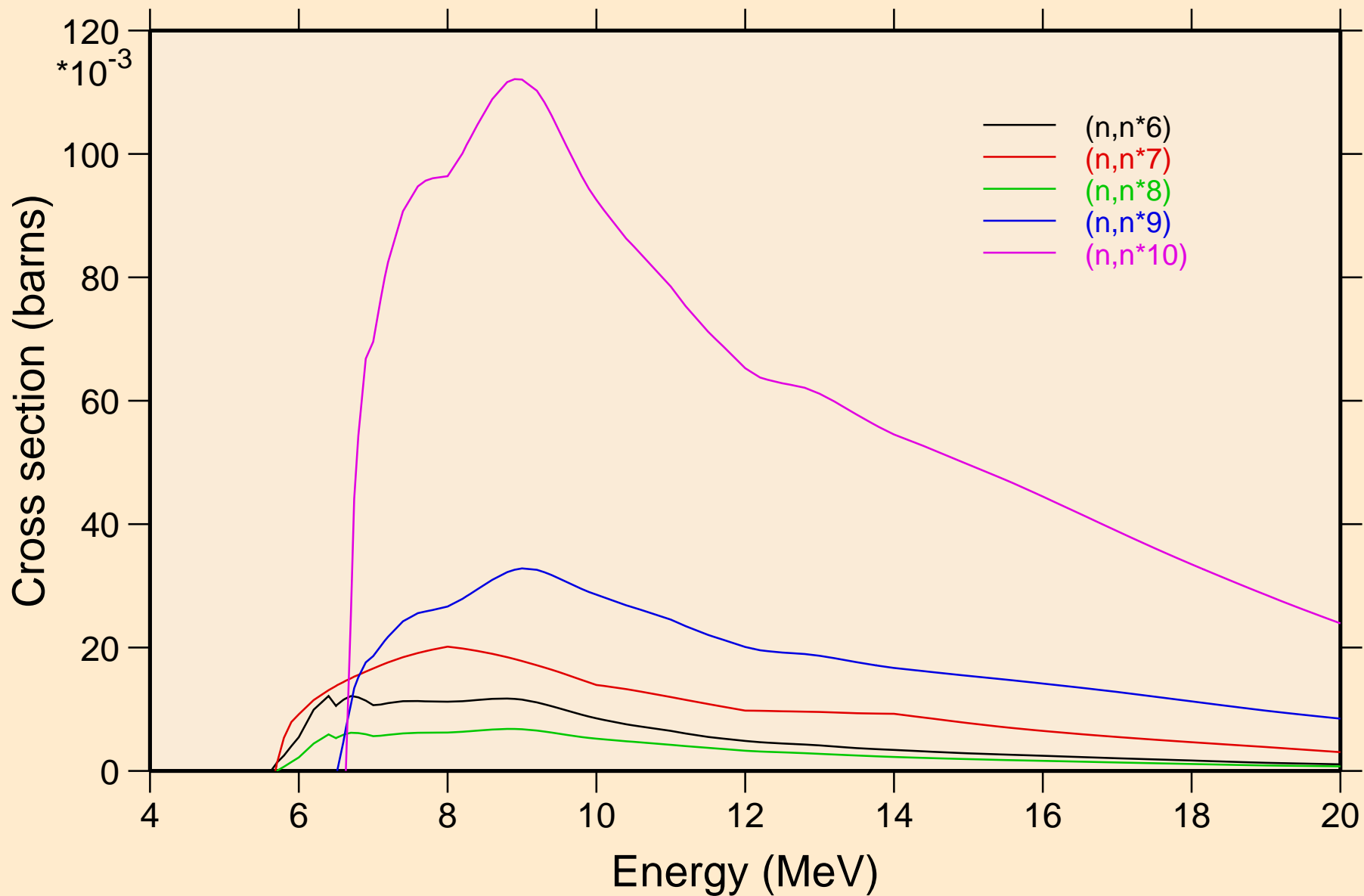

MAT=525 ACE FILE PRODUCED AT NEA WITH NDEC
Inelastic levels

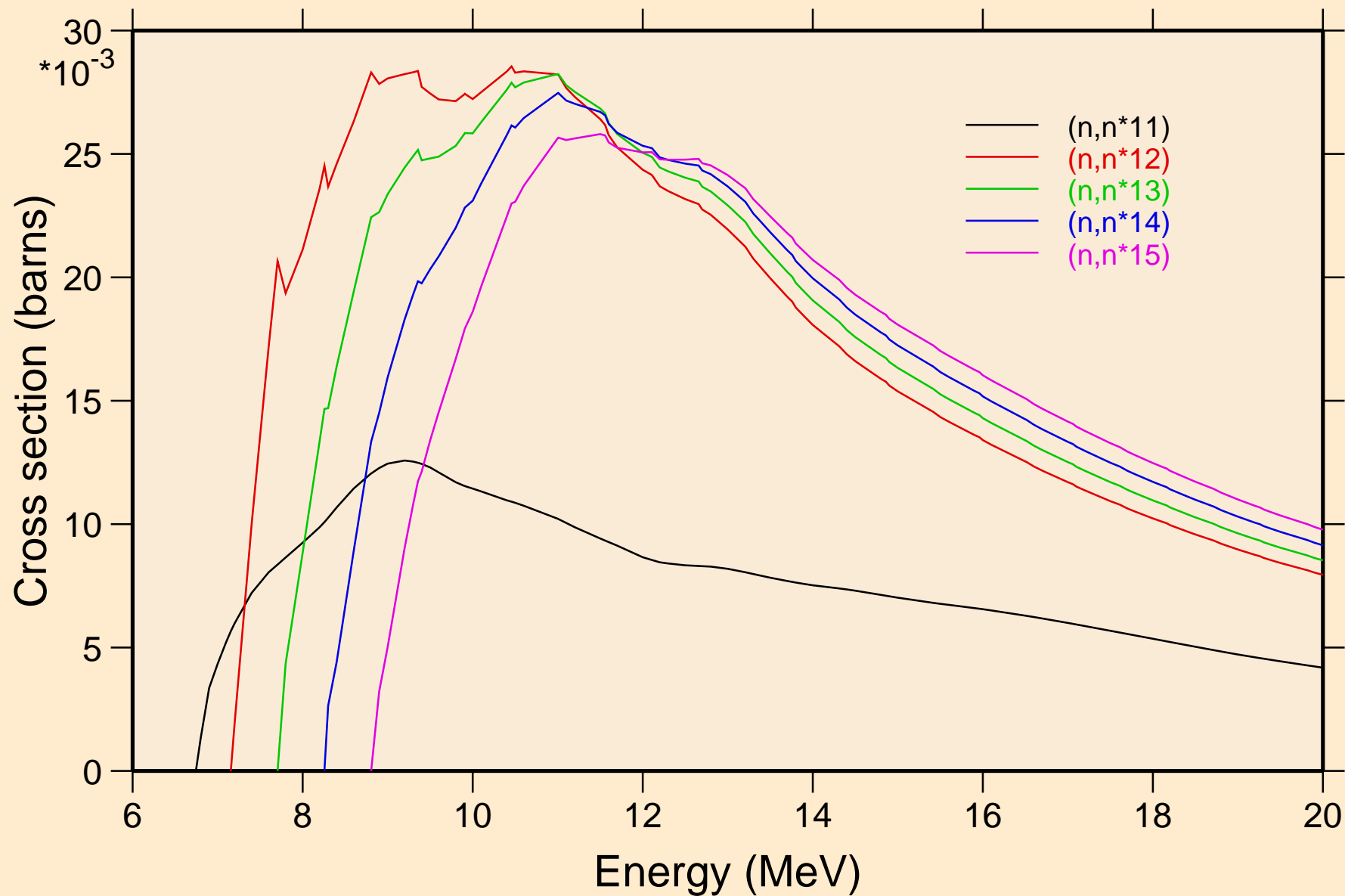

MAT=525 ACE FILE PRODUCED AT NEA WITH NDEC
Inelastic levels

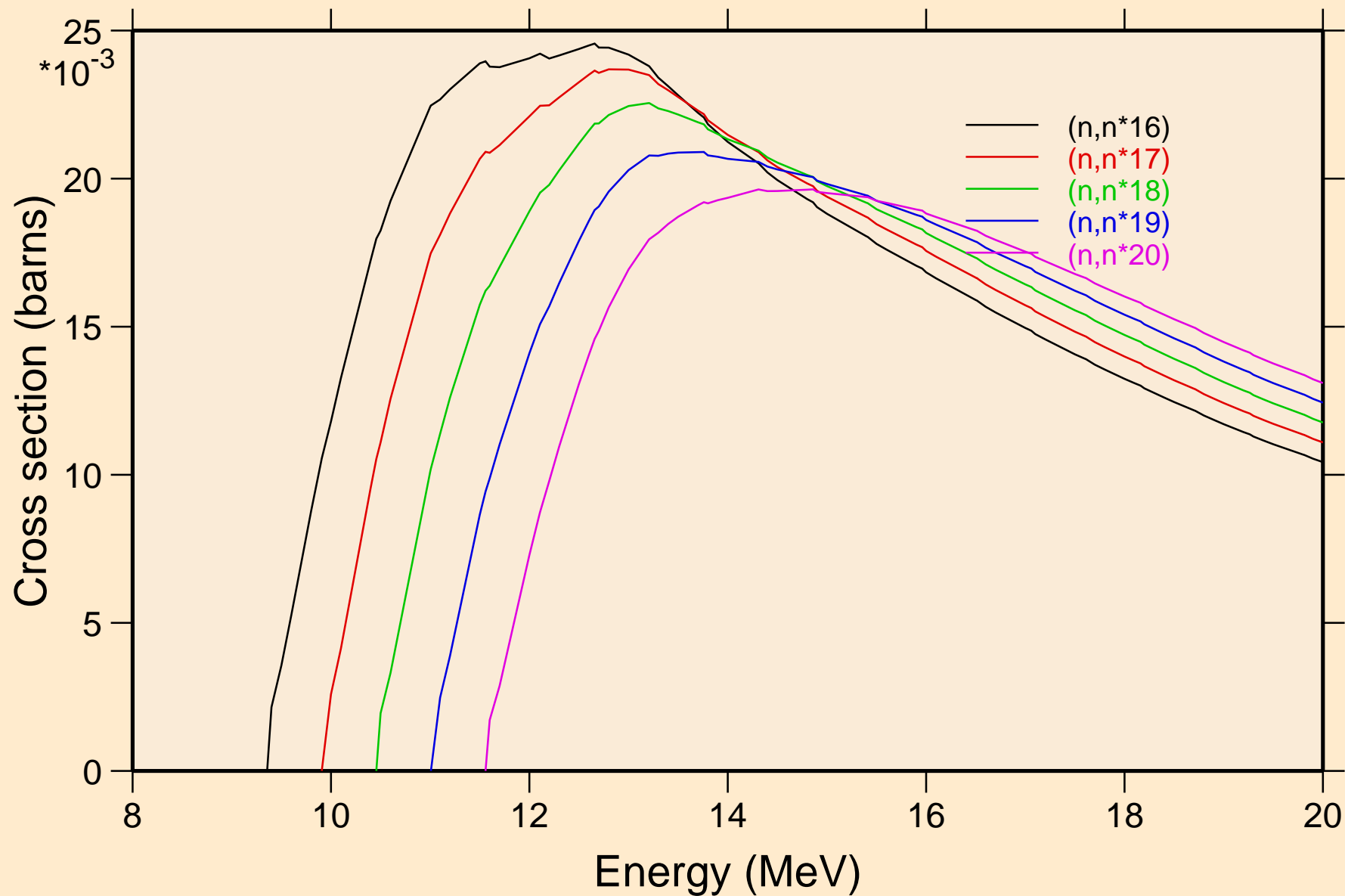

MAT=525 ACE FILE PRODUCED AT NEA WITH NDEC
Inelastic levels

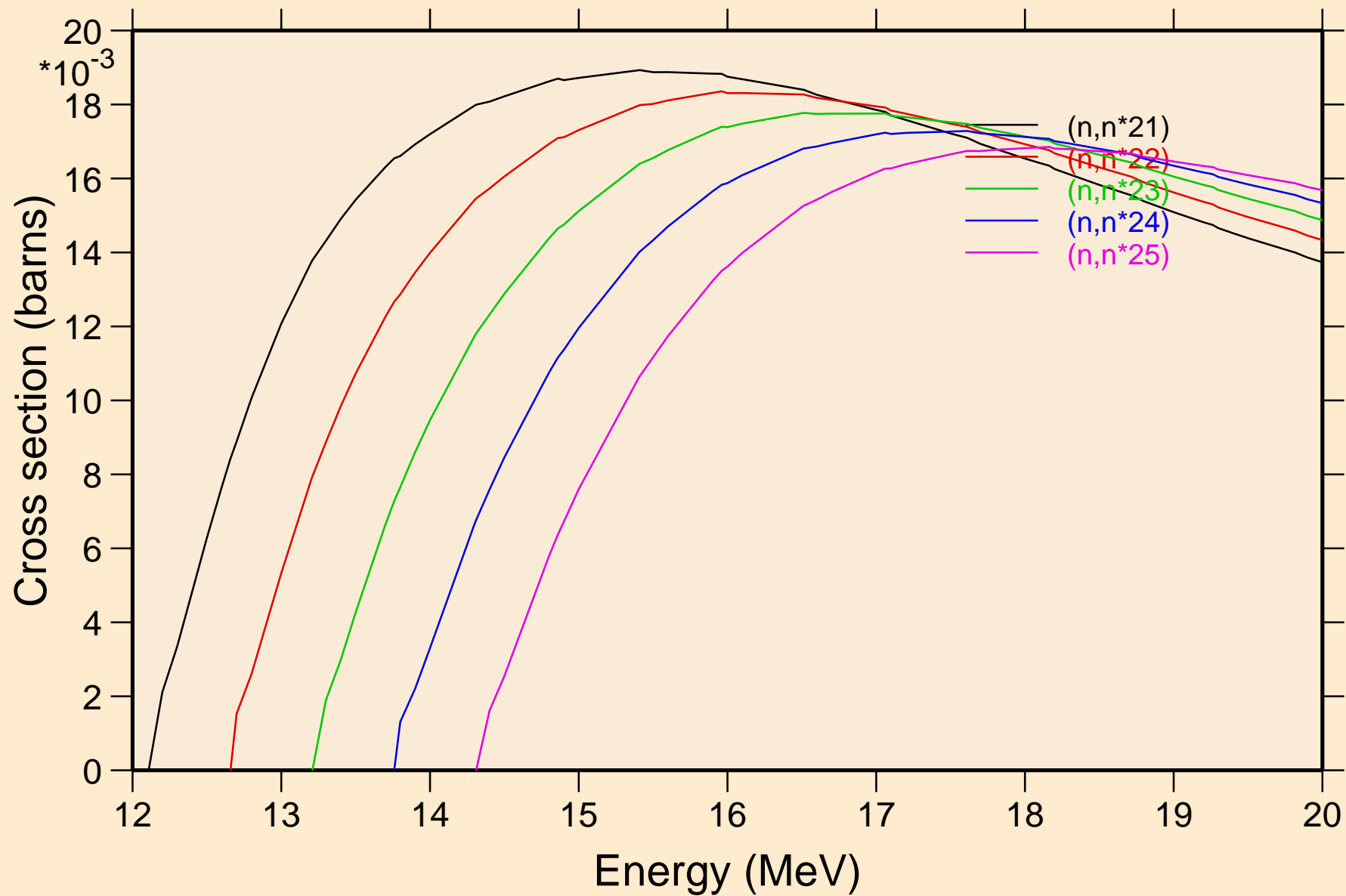

MAT=525 ACE FILE PRODUCED AT NEA WITH NDEC
Inelastic levels

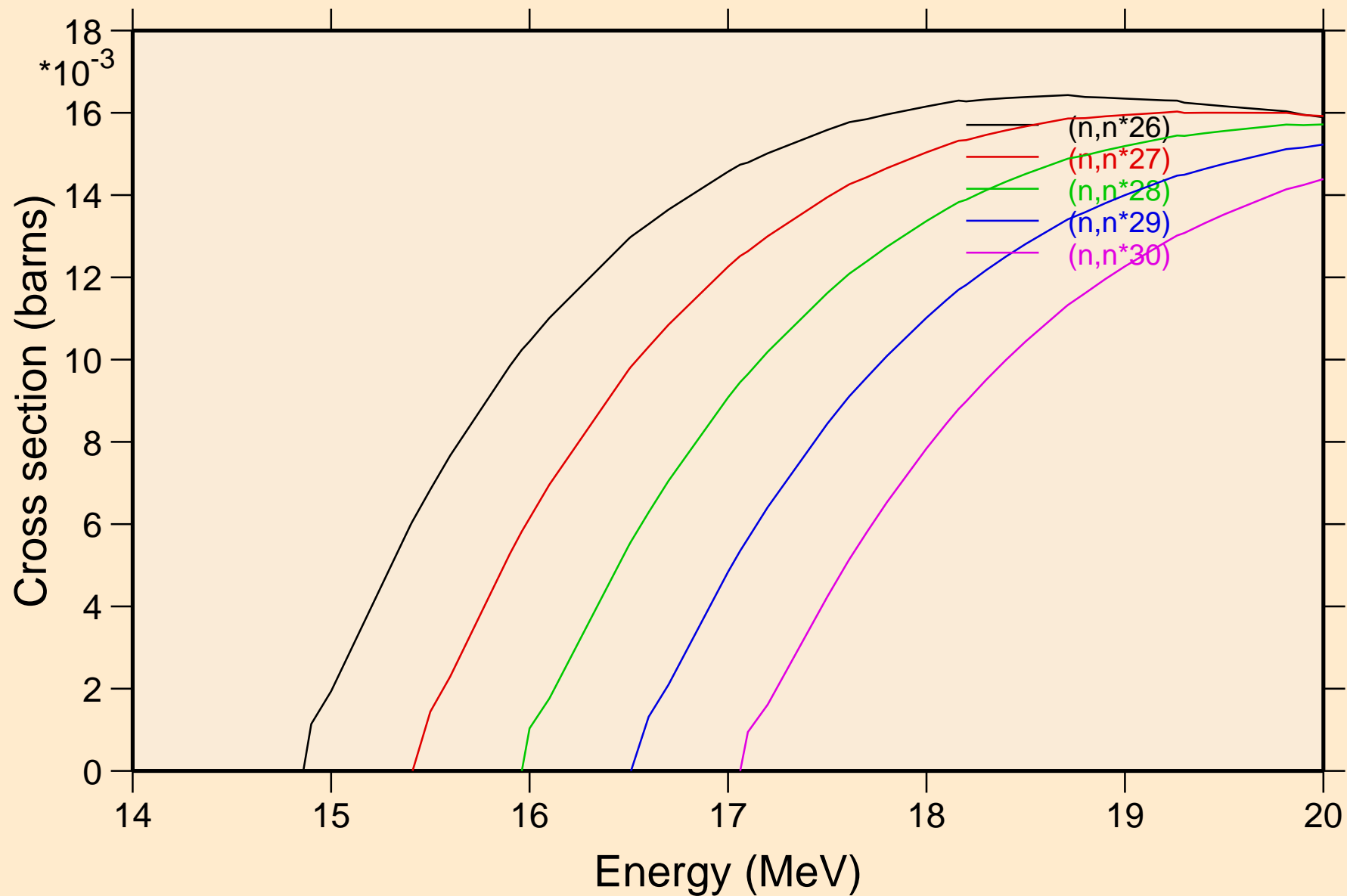

MAT=525 ACE FILE PRODUCED AT NEA WITH NDEC
Inelastic levels

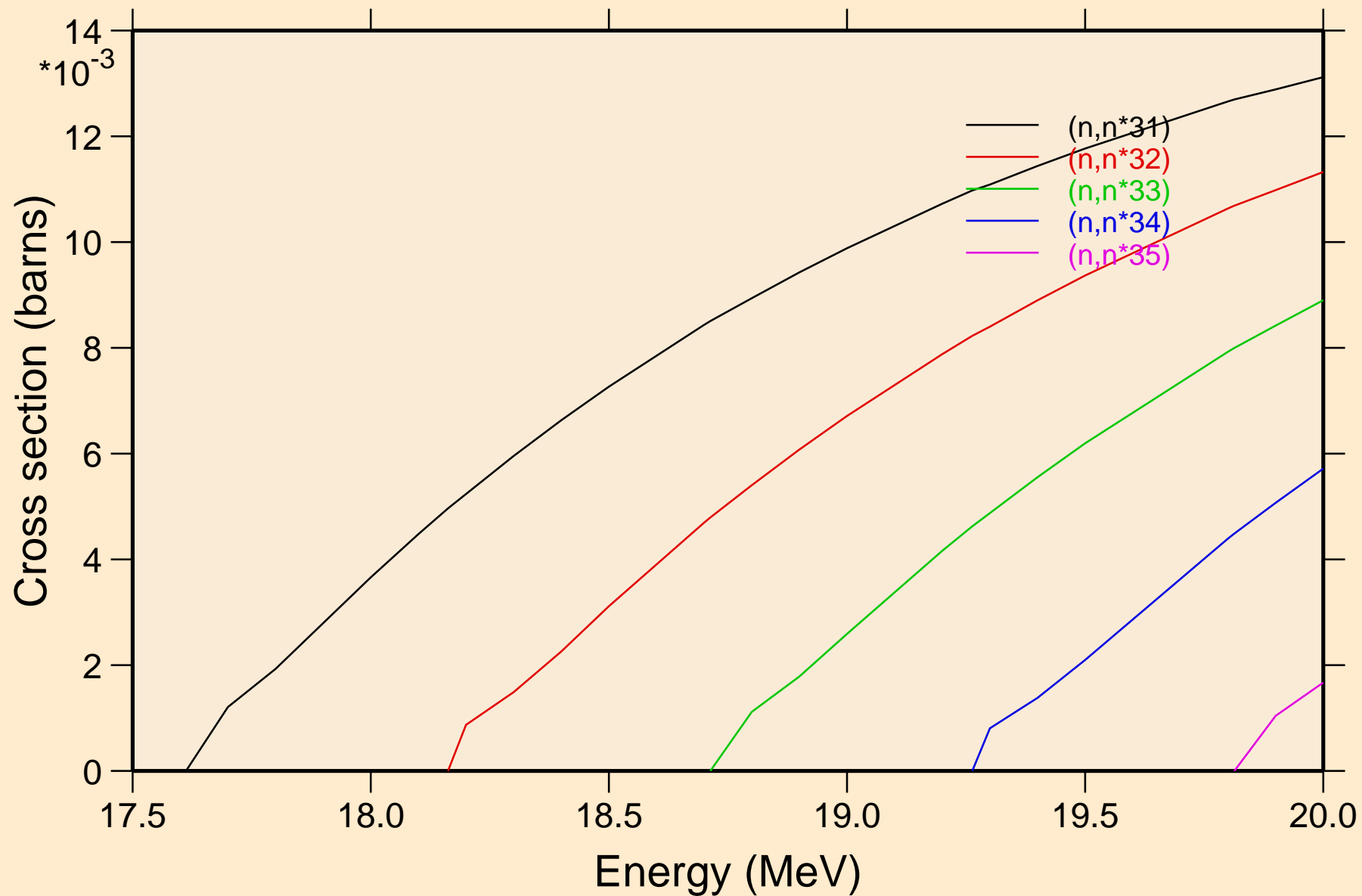

MAT=525 ACE FILE PRODUCED AT NEA WITH NDEC
Threshold reactions

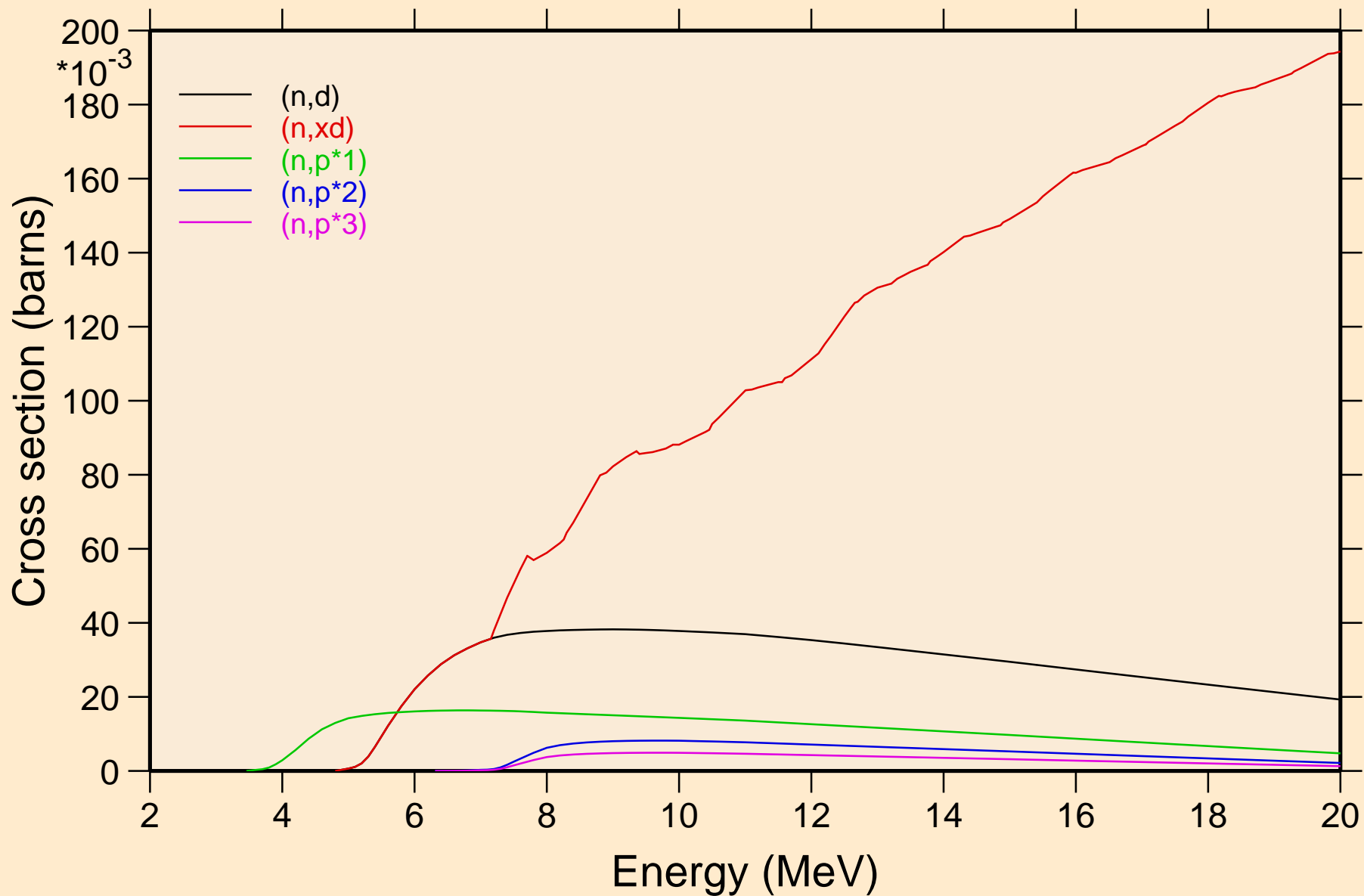

MAT=525 ACE FILE PRODUCED AT NEA WITH NDEC
Threshold reactions

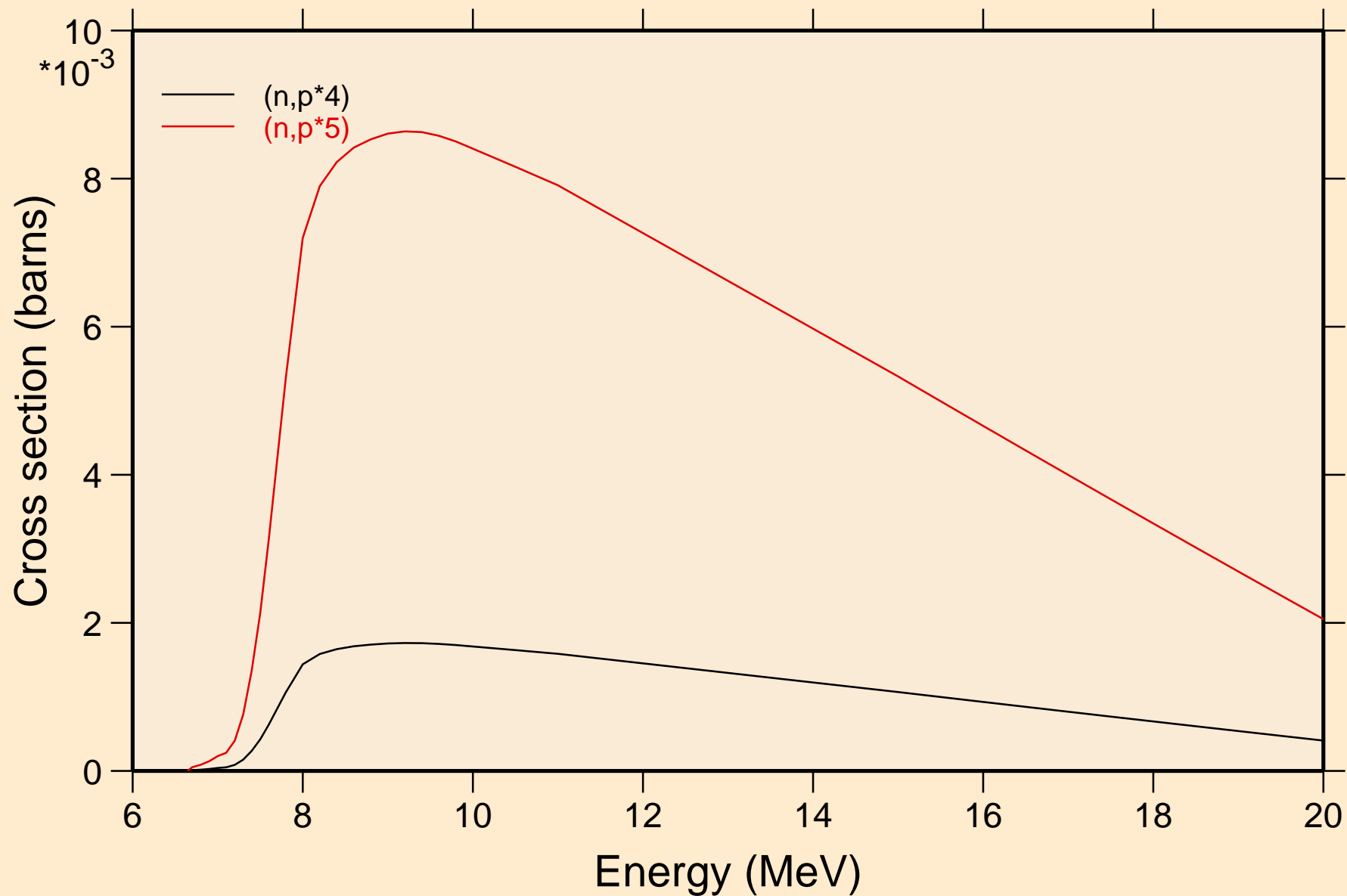

MAT=525 ACE FILE PRODUCED AT NEA WITH NDEC
angular distribution for elastic

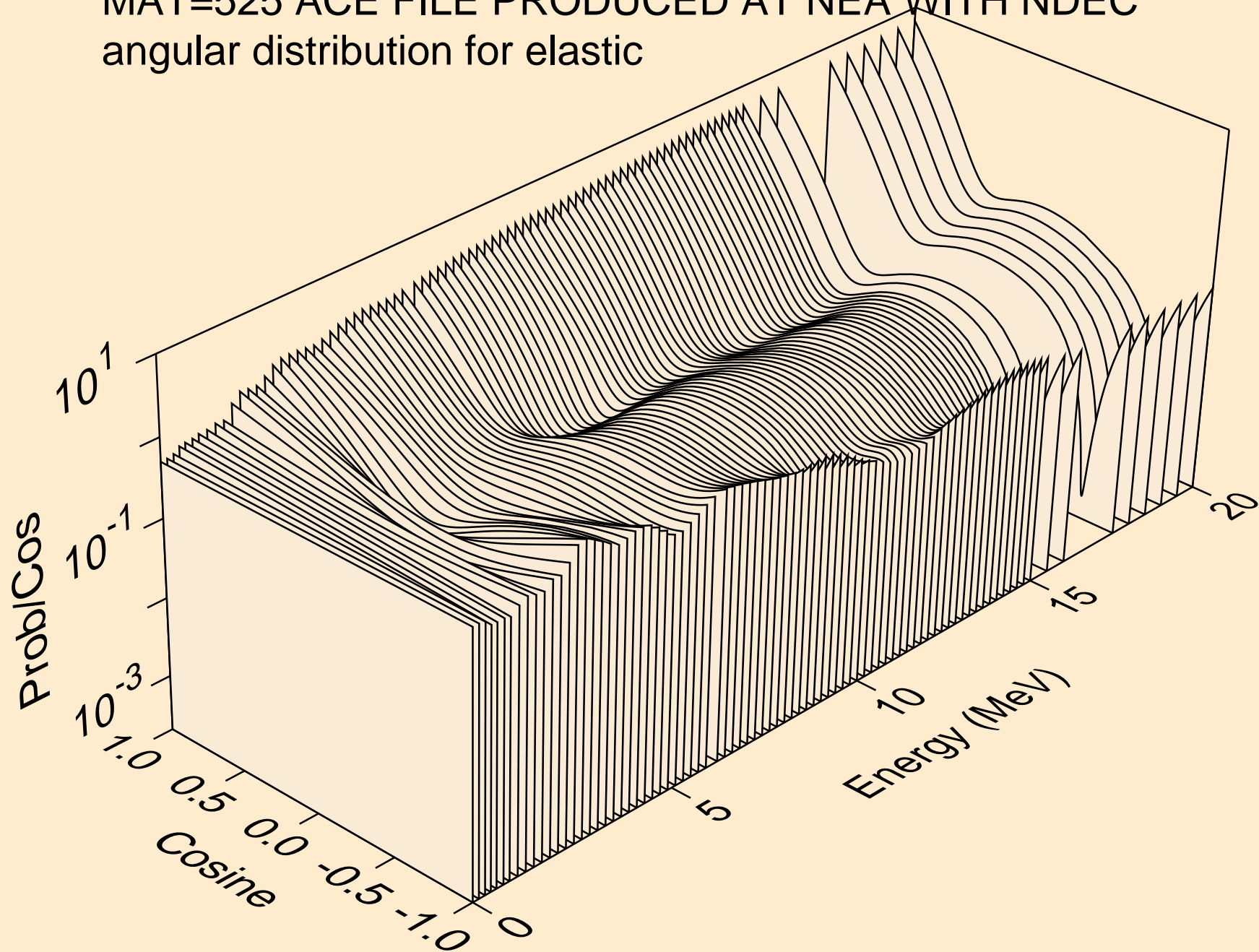

MAT=525 ACE FILE PRODUCED AT NEA WITH NDEC
angular distribution for (n,n*1)

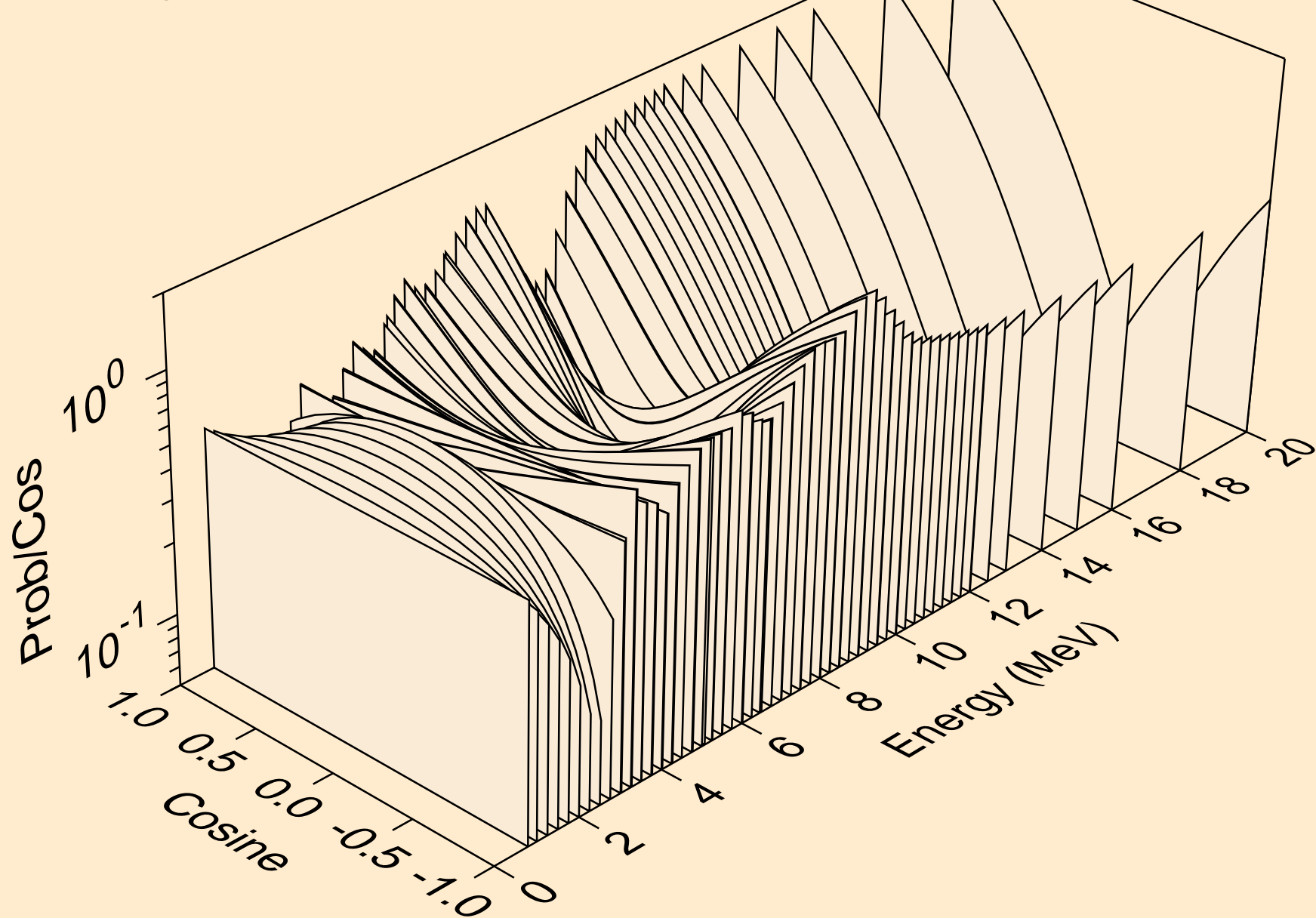

MAT=525 ACE FILE PRODUCED AT NEA WITH NDEC
angular distribution for (n,n*2)

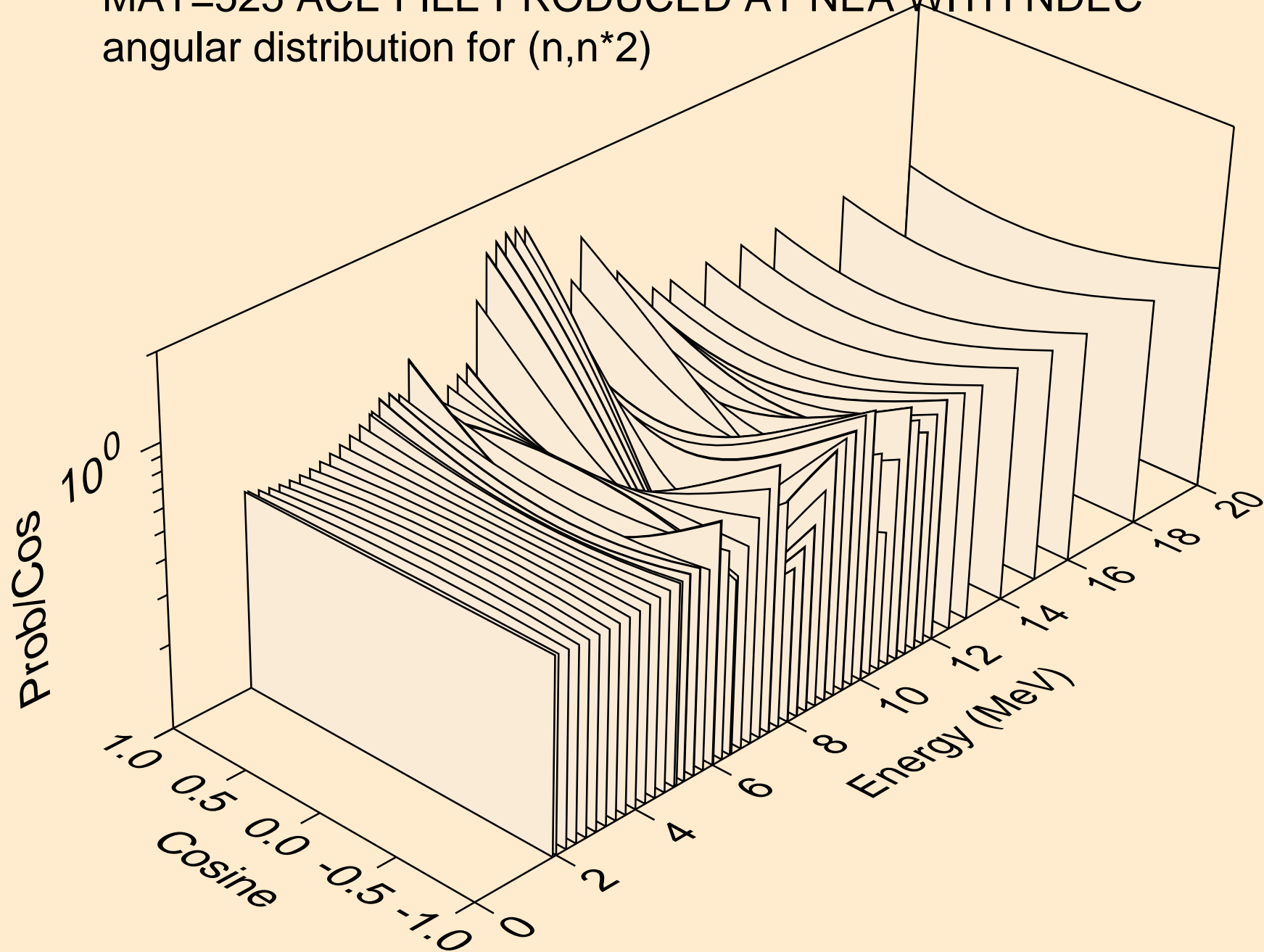

MAT=525 ACE FILE PRODUCED AT NEA WITH NDEC
angular distribution for (n,n*3)

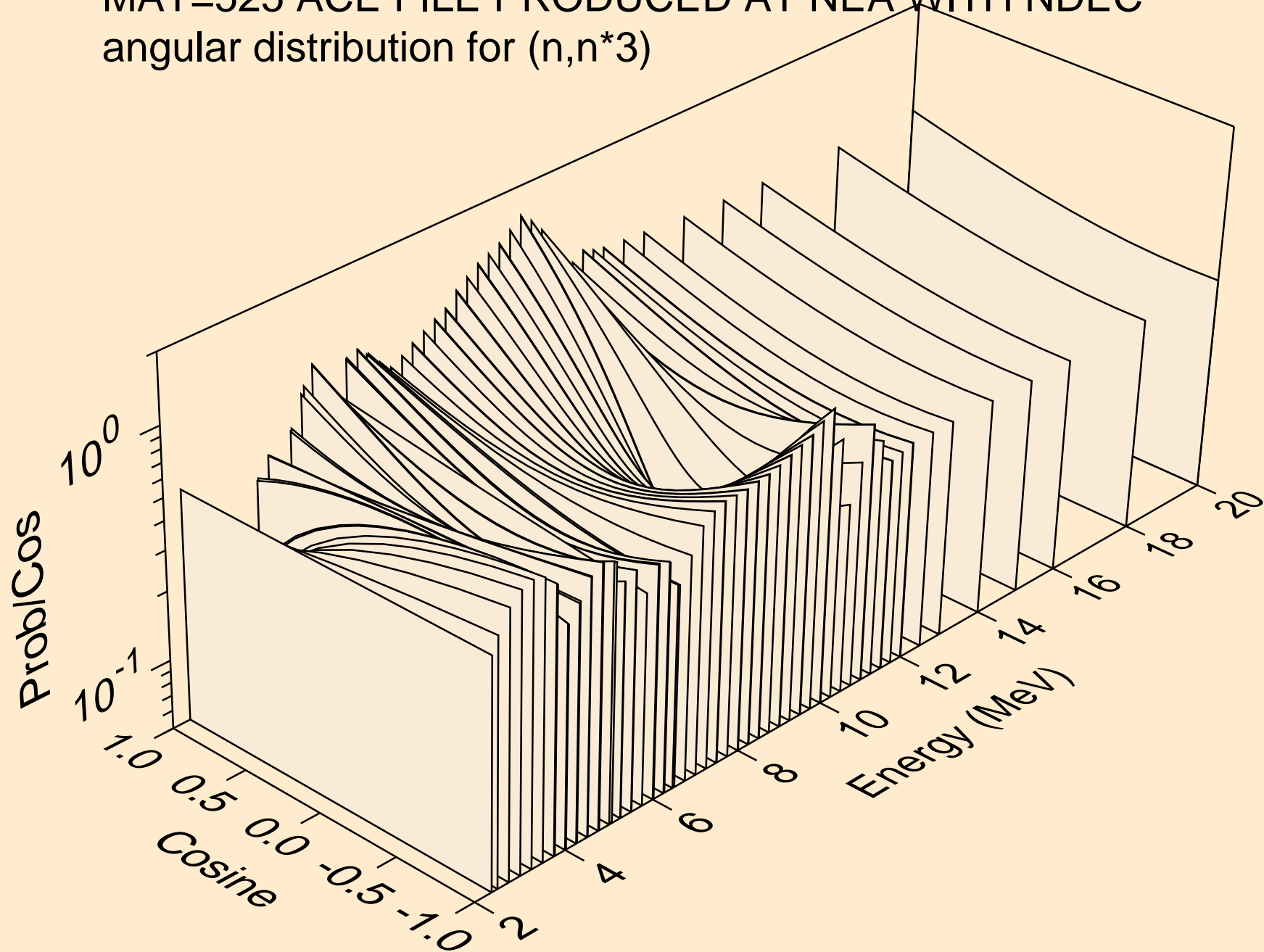

MAT=525 ACE FILE PRODUCED AT NEA WITH NDEC
angular distribution for (n,n*4)

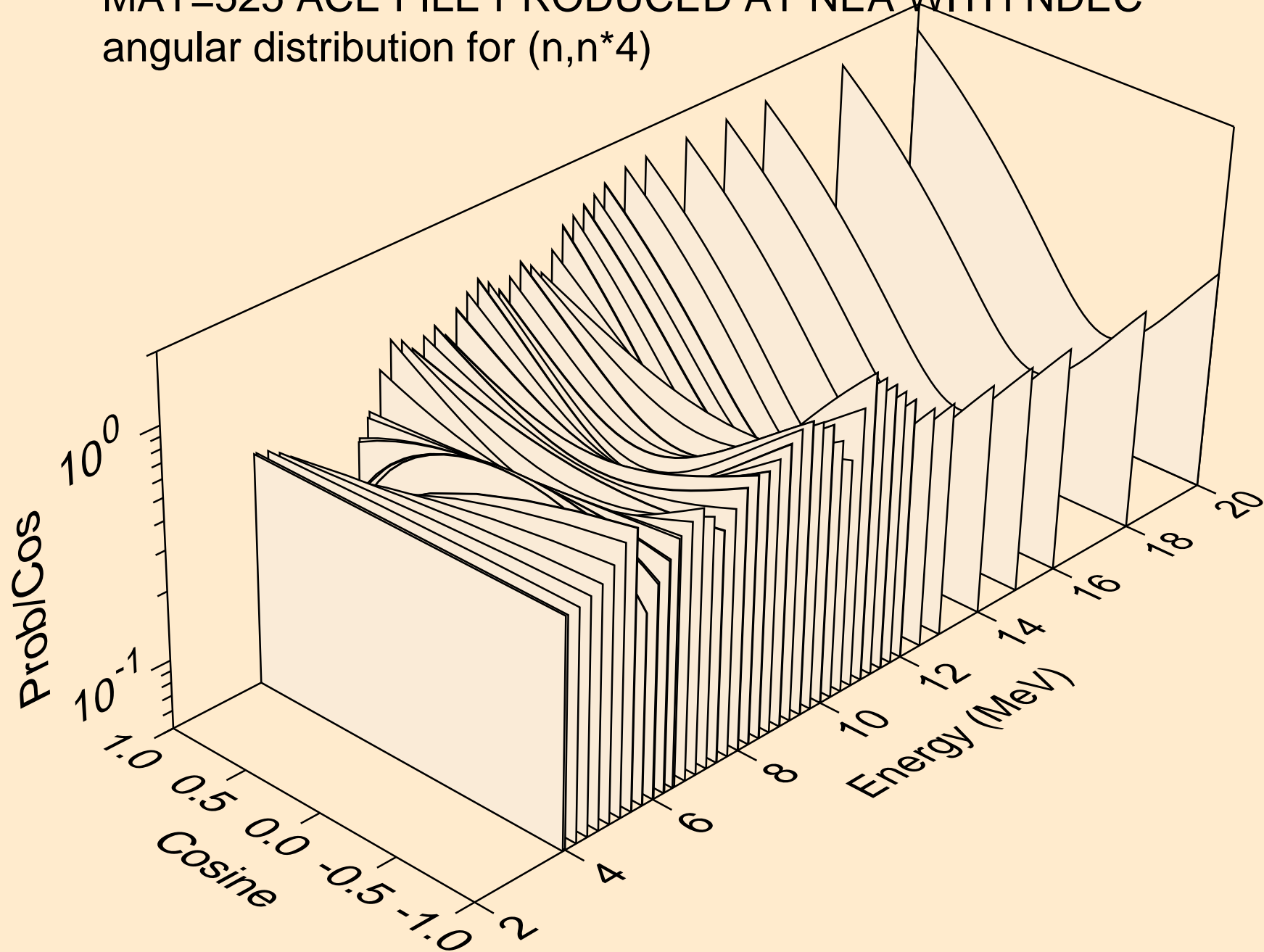

MAT=525 ACE FILE PRODUCED AT NEA WITH NDEC
angular distribution for (n,n*5)

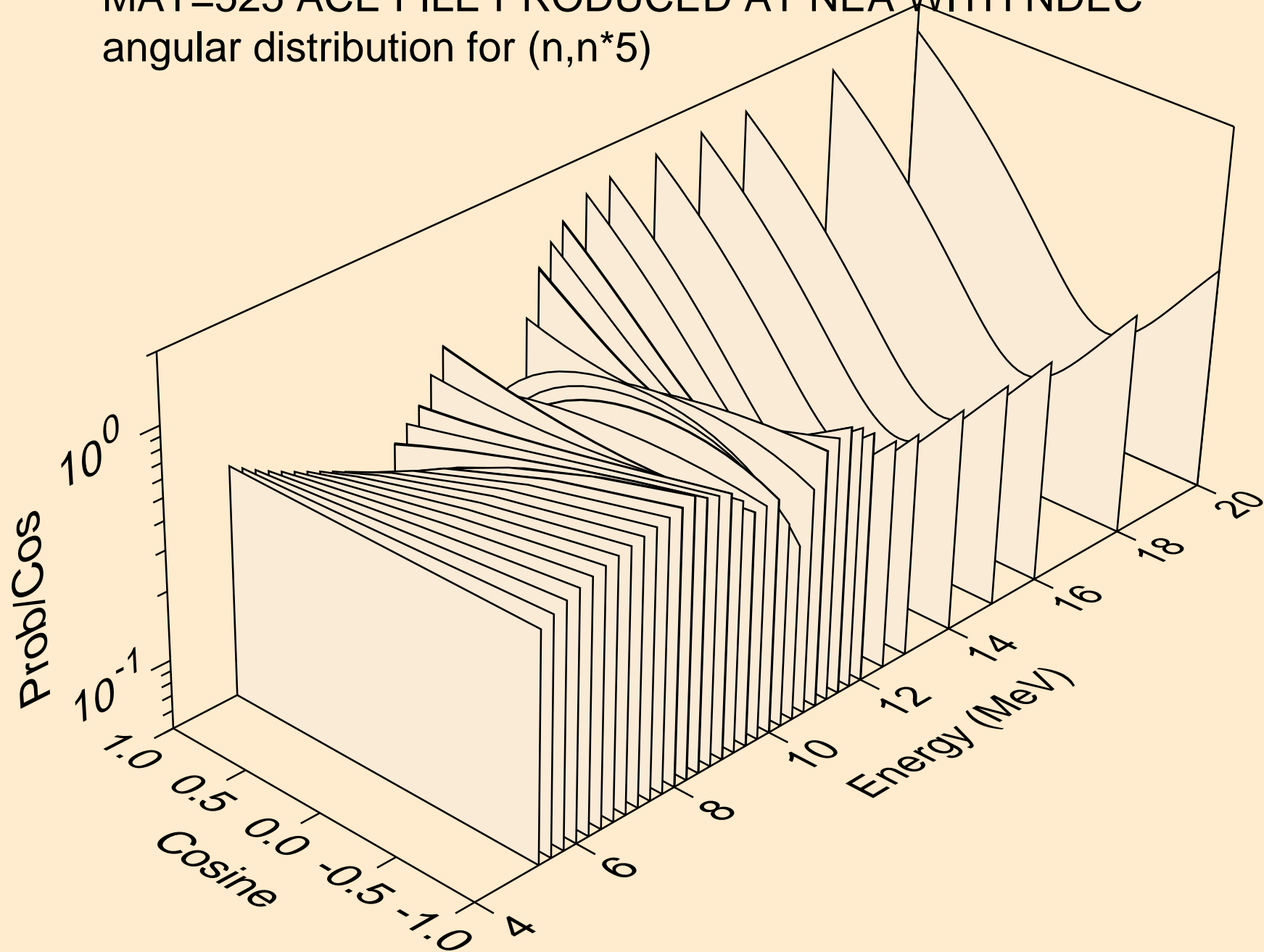

MAT=525 ACE FILE PRODUCED AT NEA WITH NDEC
Photon emission for (n,a*1)

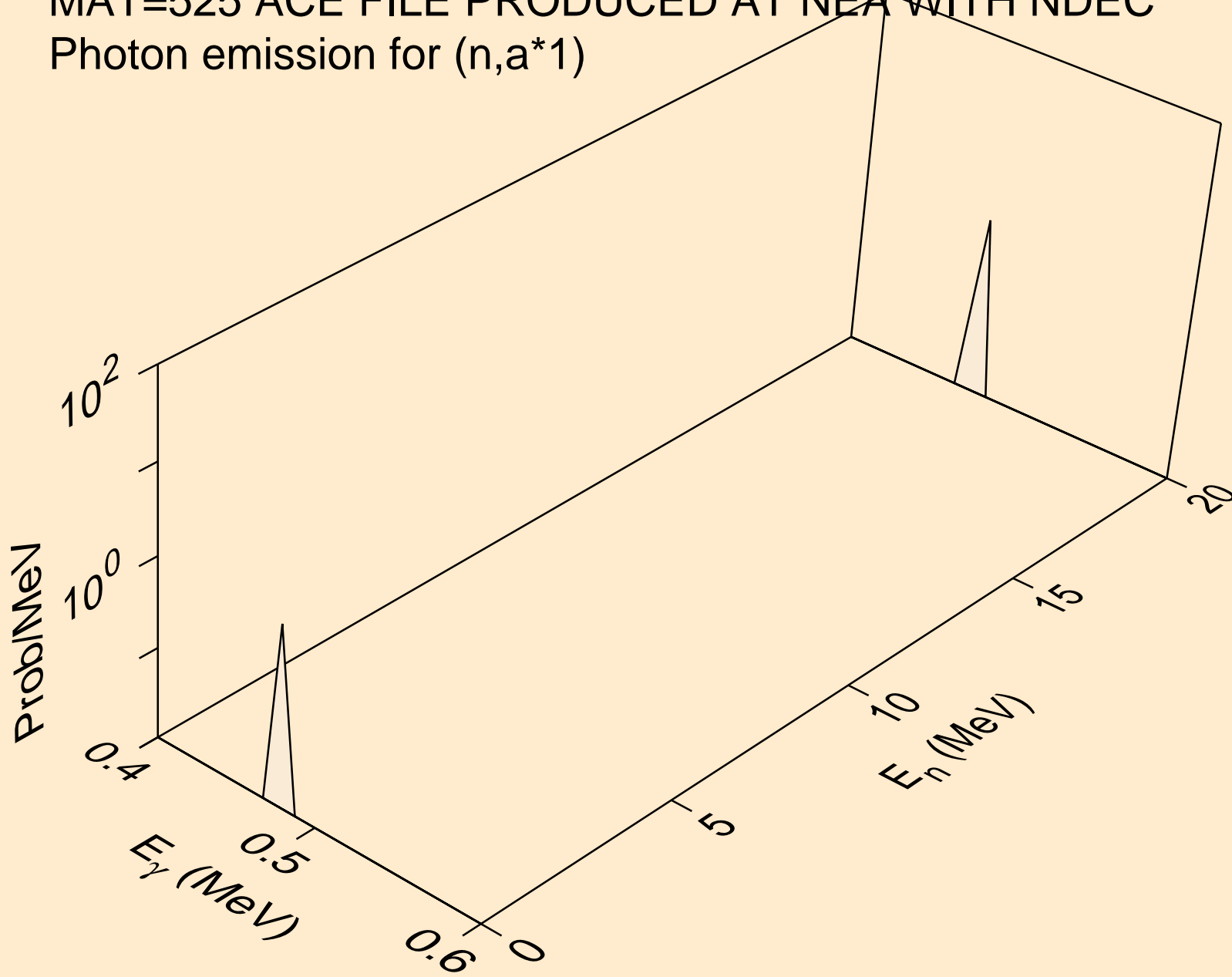

MAT=525 ACE FILE PRODUCED AT NEA WITH NDEC
14 MeV photon spectrum

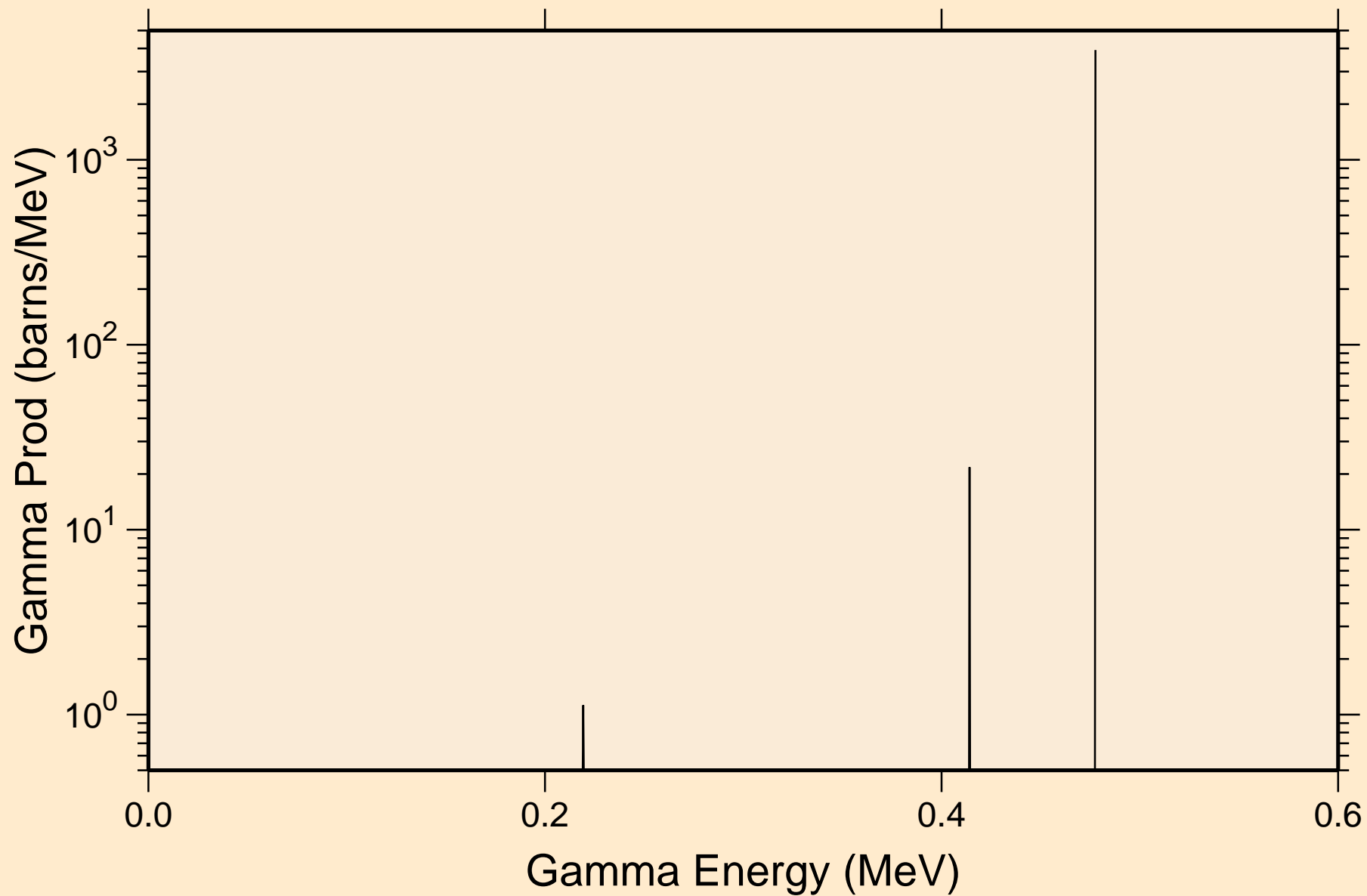

MAT=525 ACE FILE PRODUCED AT NEA WITH NDEC
Particle heating contributions

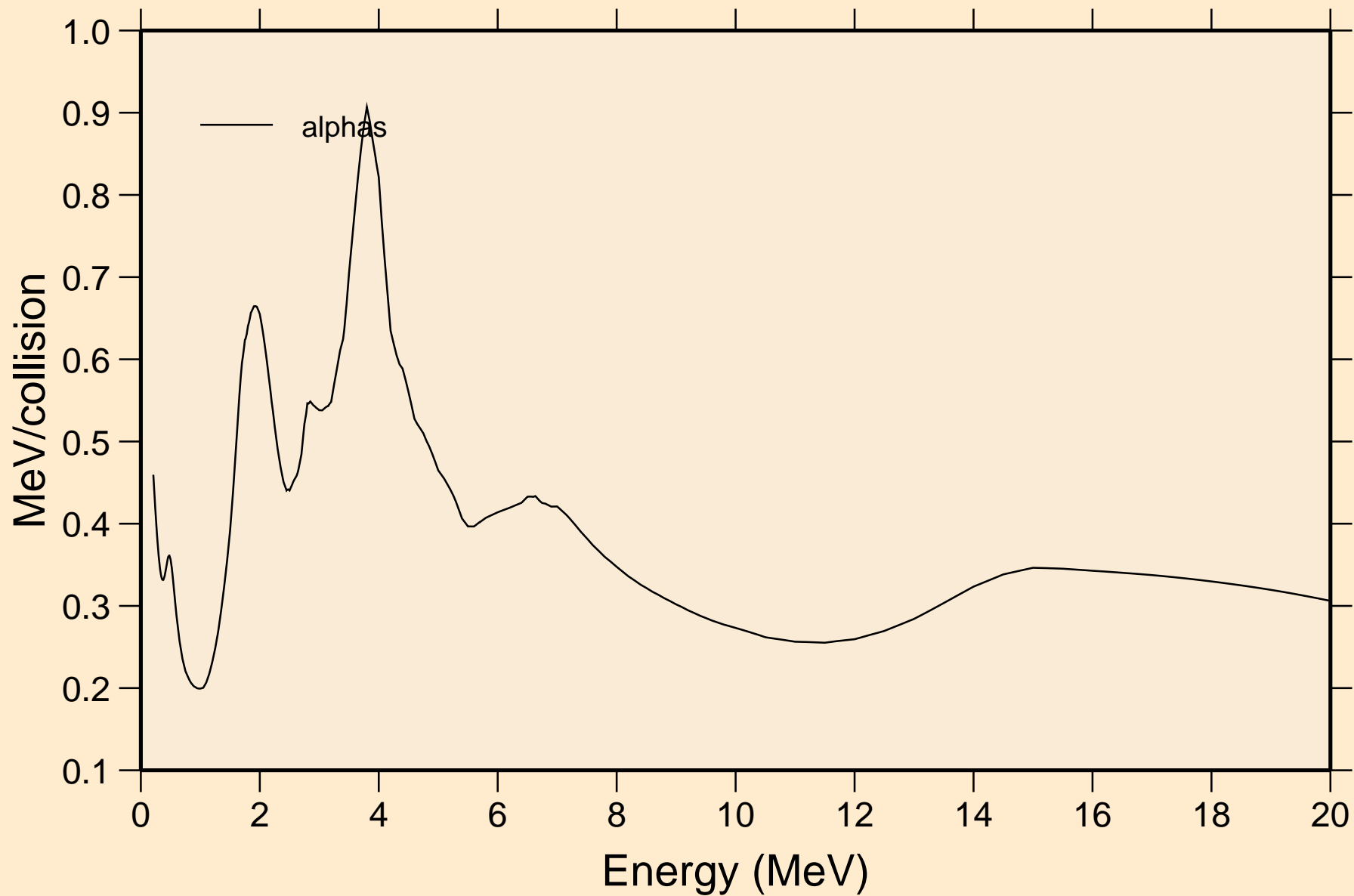

MAT=525 ACE FILE PRODUCED AT NEA WITH NDEC
Recoil Heating

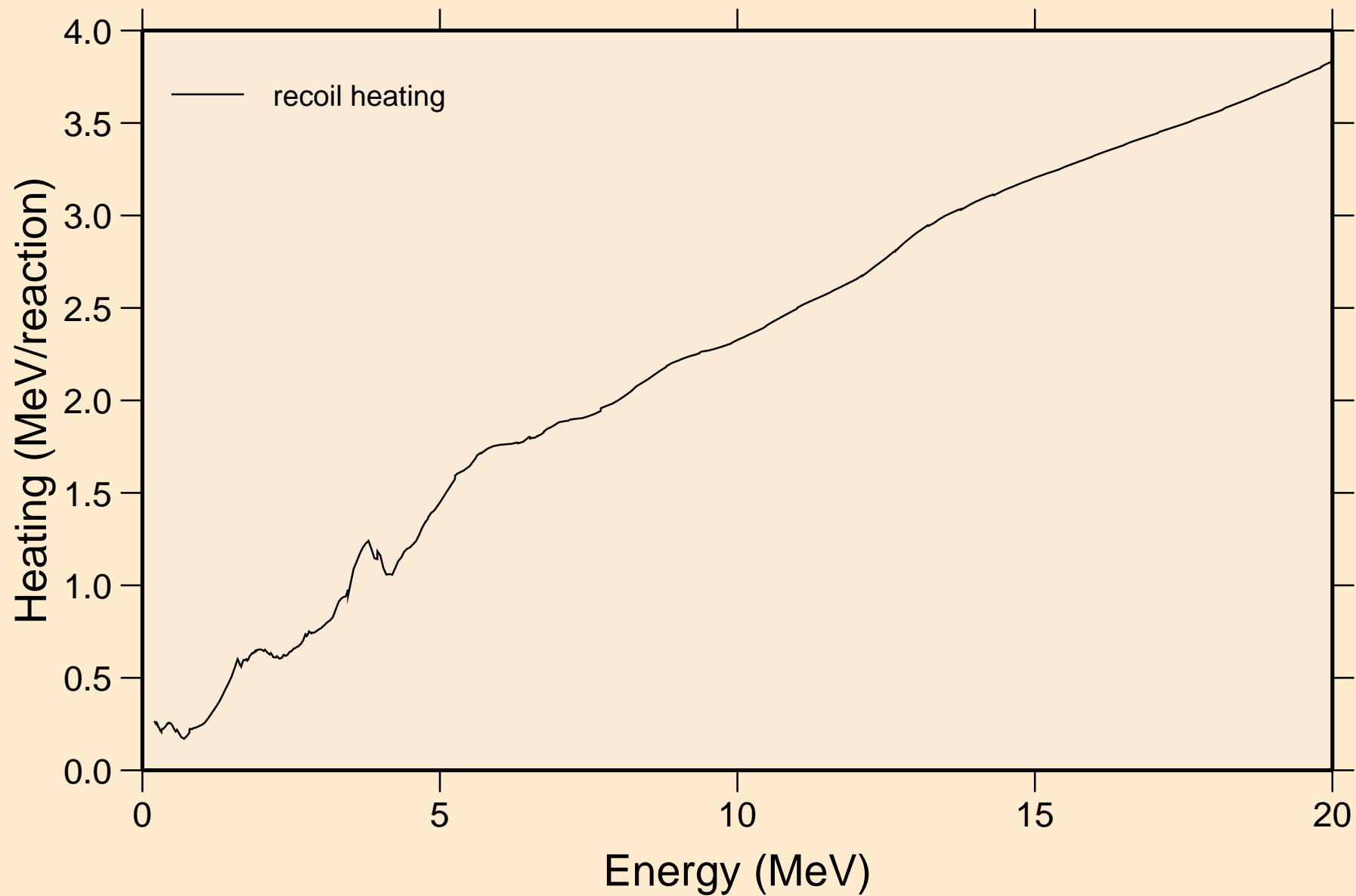

MAT=525 ACE FILE PRODUCED AT NEA WITH NDEC
Particle production cross sections

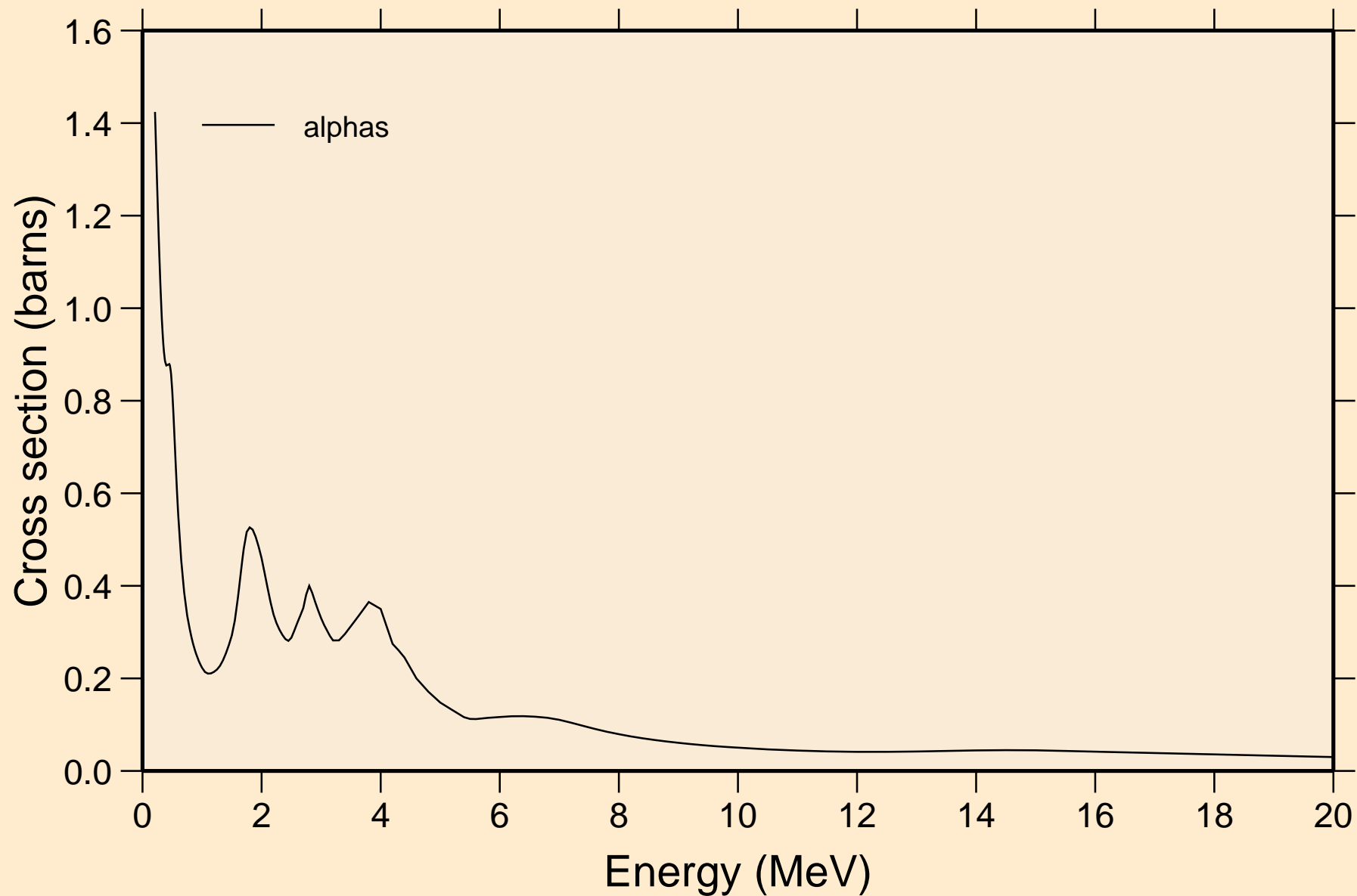

MAT=525 ACE FILE PRODUCED AT NEA WITH NDEC
angular distribution for (n,a*0) alpha

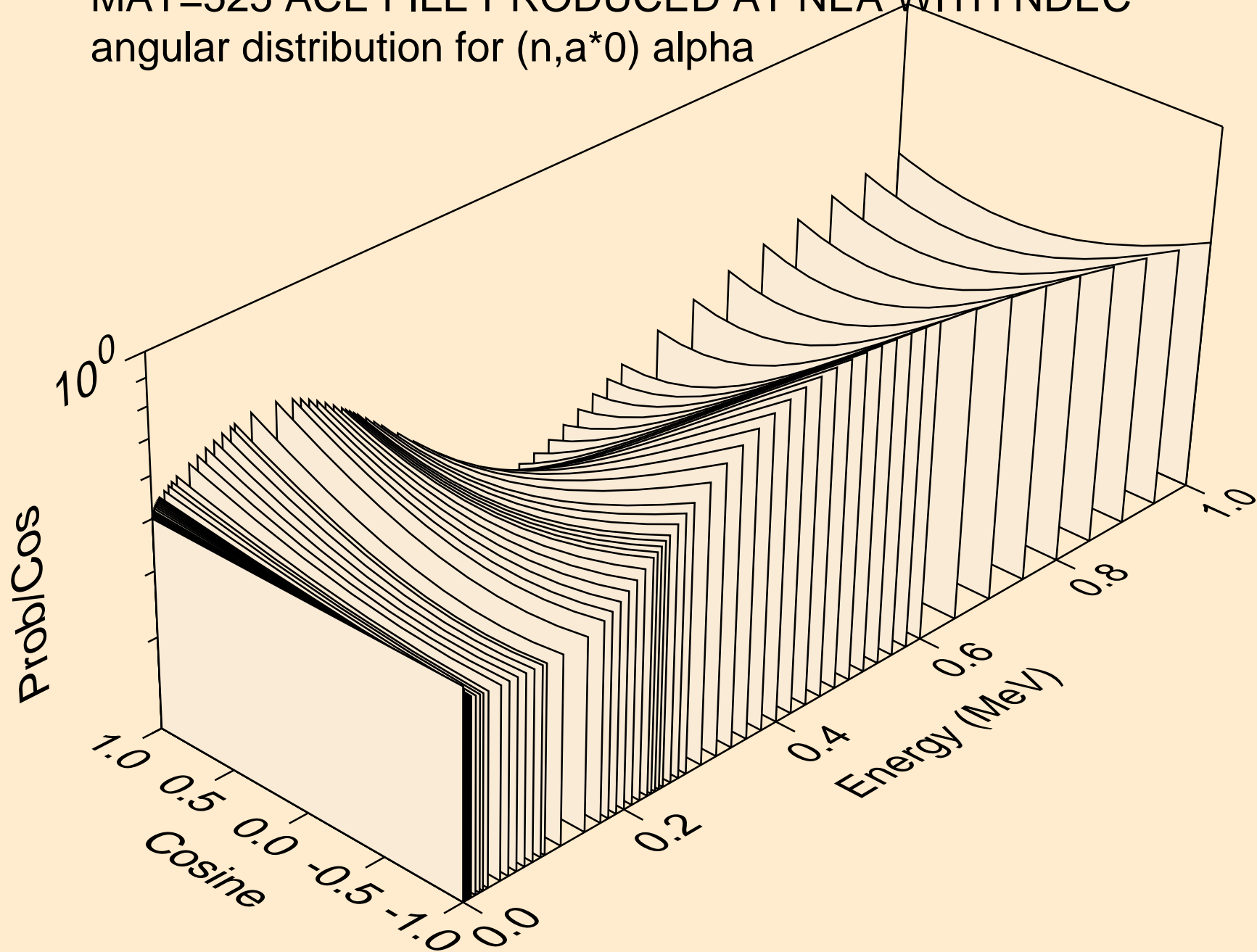

MAT=525 ACE FILE PRODUCED AT NEA WITH NDEC
angular distribution for (n,a*1) alpha

