



# Current progress in R&D on MSR fuel cycle technology in the Czech Republic

**Jan Uhlíř**

**Nuclear Research Institute Řež plc  
Czech Republic**

*OECD-NEA 10th IEM on Actinides and Fission Products P&T,  
Mito, Japan, October 6 – 10, 2008*

**Czech P&T program is grounded on the Molten Salt Reactor system concept with fluoride salts based liquid fuel, the fuel cycle of which is based on pyrochemical fluoride partitioning of spent fuel.**

Molten Salt Reactor (MSR) represents one of promising advanced reactor type, which can be operated as actinide burner (transmuter) incinerating transuranium fuel.

MSR – An burner has to be operated in closed cycle mode, based on the on-line reprocessing technology. The on-line reprocessing should be linked with the fresh transuranium fuel processing to continuously refill the new fuel into the reactor system.

**Czech R&D program “SPHINX” covers mainly the areas of reactor physics, material research, development of apparatuses for molten salt media as well as the MSR fuel cycle technology development.**

Fuel cycle technologies proposed for MSR An-burner (often called MSTR) are generally pyrochemical and fluoride caused by the fact that MSTR fuel is constituted by a mixture of molten fluoride.

Main pyrochemical separation techniques proposed for processing and subsequent reprocessing of MSTR fuel are

- Fluoride volatilization processes
- Molten salt / Liquid metal extraction processes
- Electrochemical separation processes

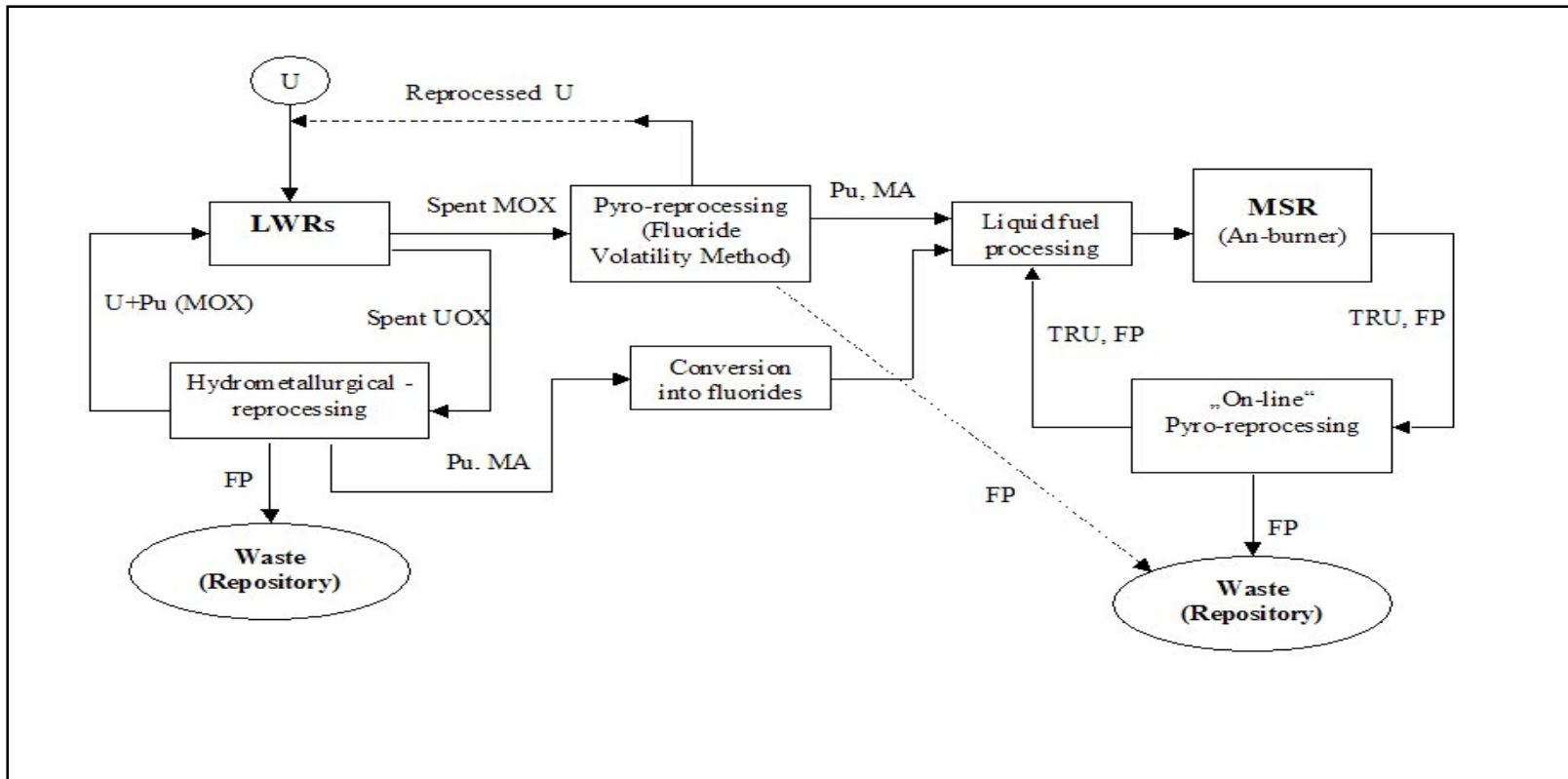

Czech P&T concept - Double strata strategy with MSTR in second stratum.

Two partitioning technologies of MSTR fuel cycle are under development:

- Fluoride volatility method
- Electrochemical separation process from fluoride molten salt media

## Progress in Fluoride Volatility Method development

FVM is a pyrochemical method proposed for reprocessing of oxide spent fuel from LWR or fast reactors. The method should be suitable for reprocessing of advanced oxide fuel types with inert matrixes, high burn-up, high content of Pu and very short cooling time.

The technology is based on direct fluorination of spent fuel by fluorine gas.

The separation process comes out from the specific property of uranium, neptunium and partially of plutonium to form volatile hexafluorides, whereas most of fission products and transplutonium elements present in spent fuel form non-volatile trifluorides.

## Main Steps of Fluoride Volatility Method

1. **Removal of the cladding material (fuse apart in furnace)**
2. **Conversion of the spent fuel into powdered form (grinding or voloxidation)**
3. **Fluorination of spent fuel**
4. **Separation and purification of formed products**

Mission and objectives of FVM within the MSTR fuel cycle:

- **Primary processing of TRU-fuel for MSTR**
  - **Separation of a maximum fraction of uranium component from Pu, MA and FP.**

## Fluorination reactions

uranium:

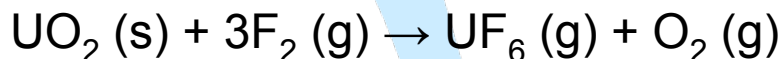

plutonium:

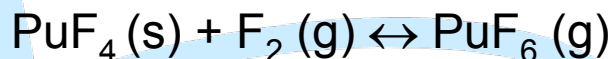
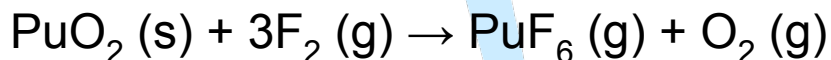
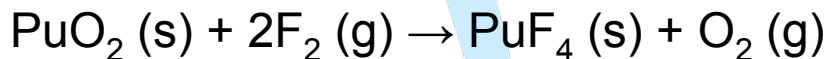

lanthanides:



minor actinides:

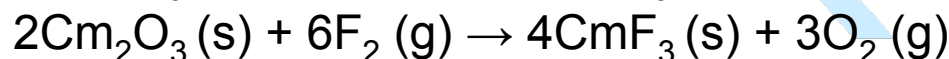
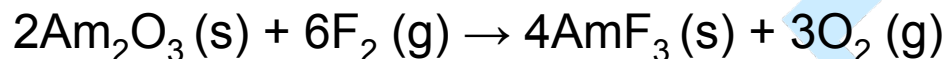
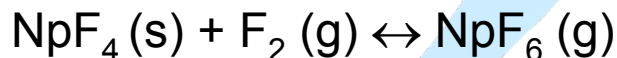
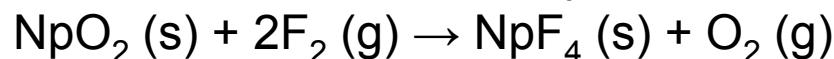
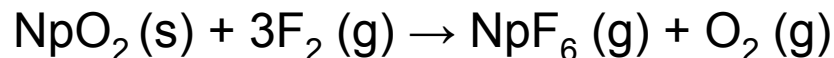

## Presumed Selected Products of Spent Fuel Fluorination

Volatile fluorides	Non-volatile fluorides	
<b>UF<sub>6</sub></b>	<b>AmF<sub>3</sub></b>	LaF <sub>3</sub>
<b>NpF<sub>6</sub></b>	<b>CmF<sub>3</sub></b>	YF <sub>3</sub>
<b>PuF<sub>6</sub></b>	<b>PuF<sub>4</sub></b>	InF <sub>3</sub>
MoF <sub>6</sub>	CsF	PmF <sub>3</sub>
TcF <sub>6</sub>	SrF <sub>2</sub>	SnF <sub>4</sub>
SeF <sub>6</sub>	ZrF <sub>4</sub>	RbF
TeF <sub>6</sub>	PrF <sub>3</sub>	AgF
RuF <sub>5</sub>	SmF <sub>3</sub>	BaF <sub>2</sub>
NbF <sub>5</sub>	EuF <sub>3</sub>	ZnF <sub>2</sub>
IF <sub>5</sub>	GdF <sub>3</sub>	SnF <sub>4</sub>

# Process flow-sheet of Fluoride Volatility Method

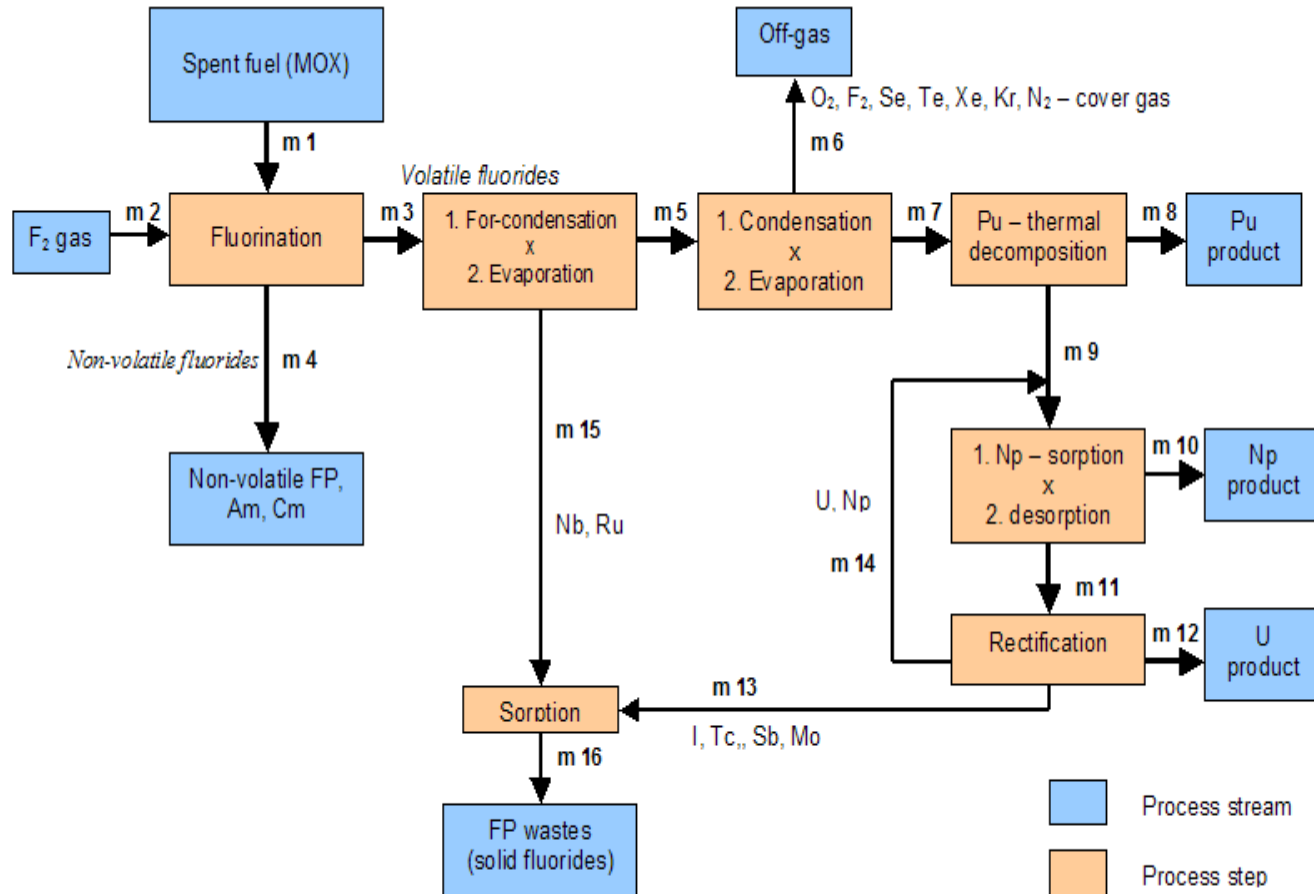

## Experimental Technological Line FERDA in the NRI Řež plc

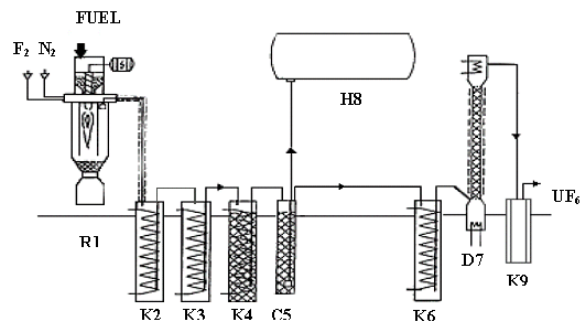
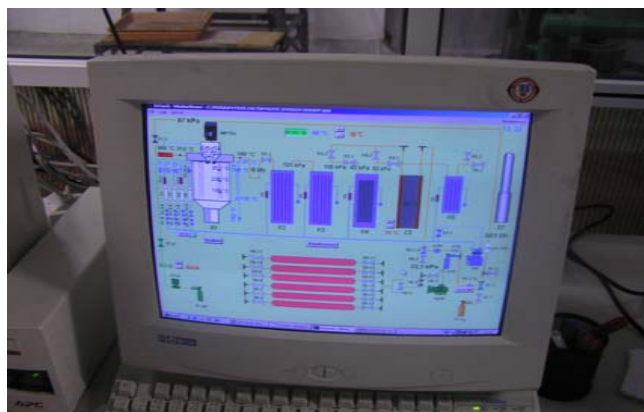

## Main present experimental effort – mastering the fluorination process

After tests done with uranium fuel, the program is focused to the verification of main unit operations with simulated spent oxide fuel constituted from a mixture of uranium oxides and non-radioactive oxides of selected fission products (lanthanides, Cs, Sr etc.)

The next series of experiments should verify the suitability of the technology for reprocessing of oxide fuels with inert matrixes.

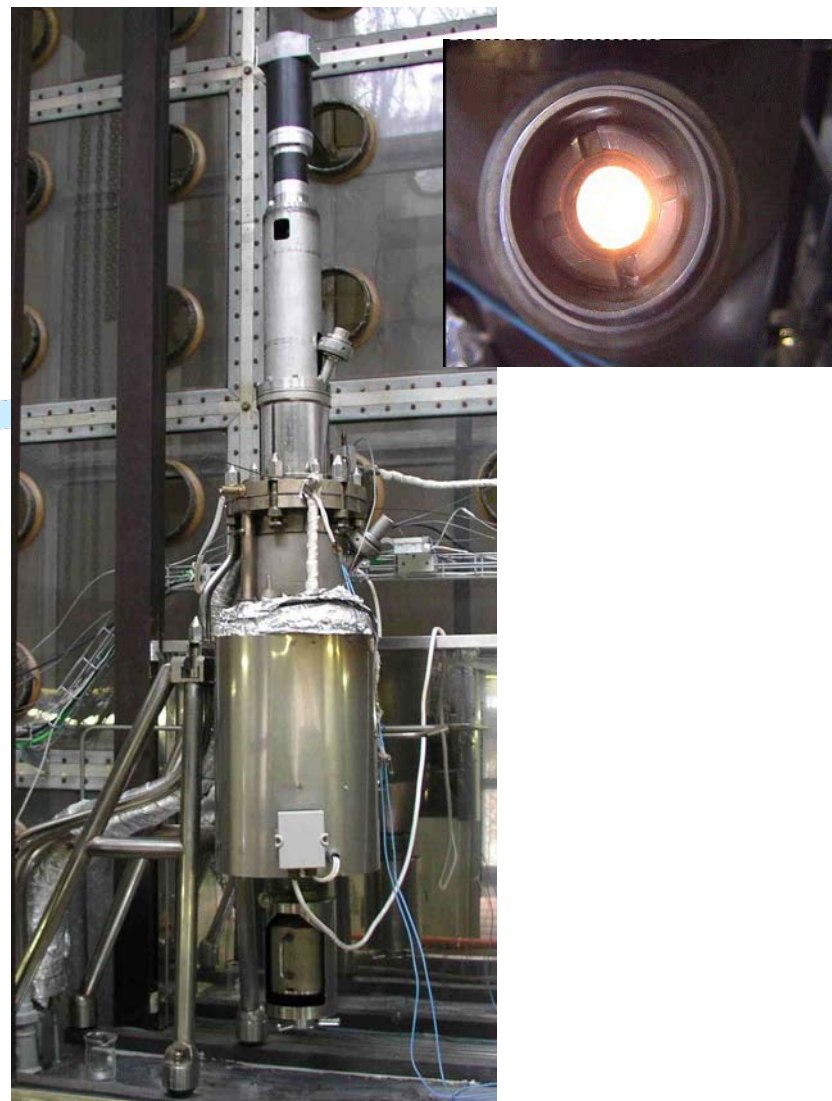

## Fuel cycle of MSTR - SPHINX

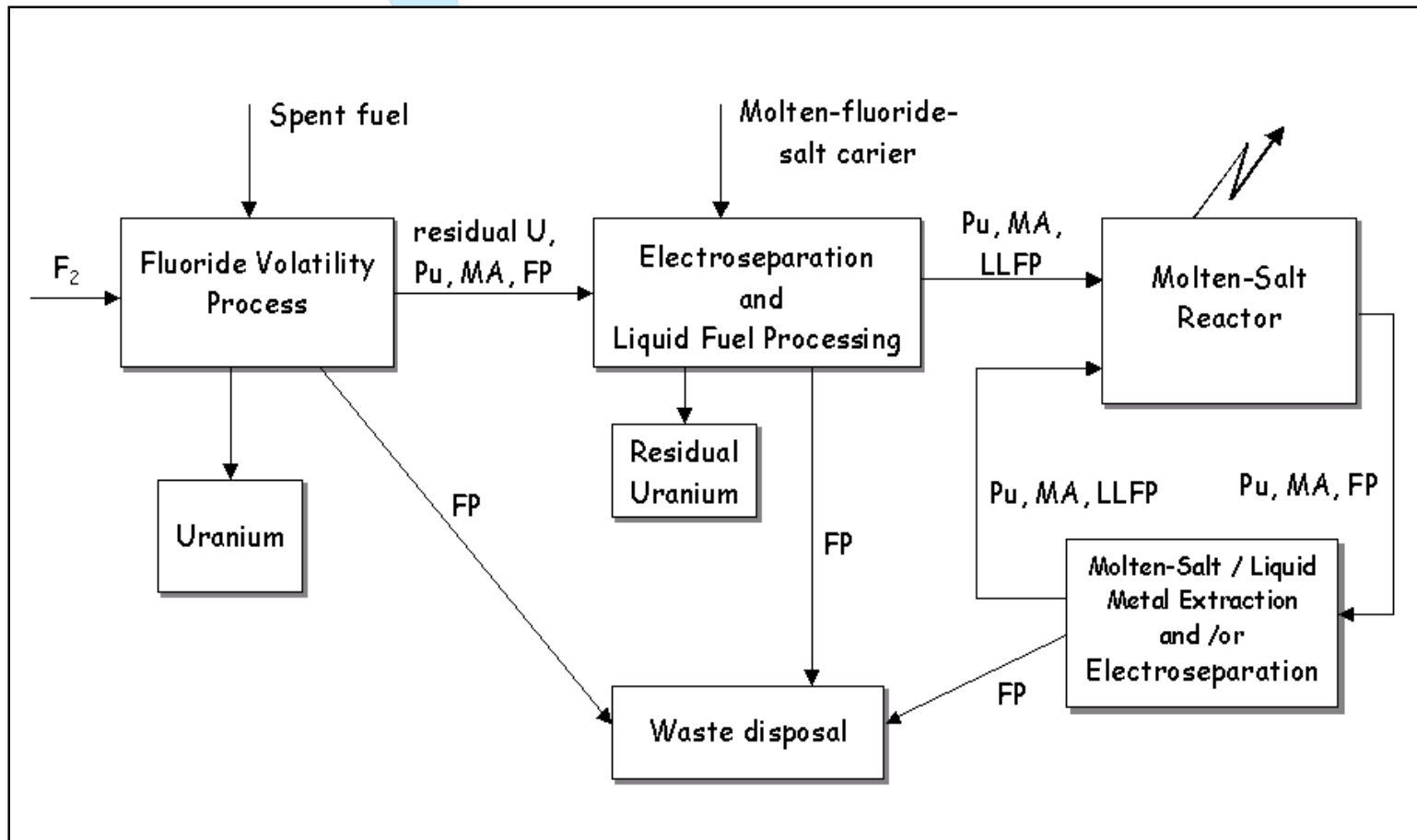

## **Progress in Electrochemical separations from fluoride molten salt media**

Electrochemical separation processes are proposed, in combination with Molten salt / Liquid metal extraction, for final processing of transuranium fuel for MSTR and for “on-line” reprocessing of circulating MSR/MSTR fuel.

Current R&D is focused to determine the basic technological conditions for electrochemical separation of individual components (actinides and fission products) from carrier molten salts.

The results should contribute to the design of conceptual flow-sheet of the MSR/MSTR on-line reprocessing technology.

## Molten salt media under the electrochemical separation study:

Carrier salt of MSR primary (fuel) circuit:

${}^7\text{LiF}-\text{BeF}_2$  (called FLIBE) or  ${}^7\text{LiF}-\text{BeF}_2-\text{NaF}$

*However, FLIBE is insufficiently electrochemically stable.*

Carrier salts proposed for electrochemical separation processes:

${}^7\text{LiF}-\text{BeF}_2$  or  ${}^7\text{LiF}-\text{BeF}_2-\text{NaF}$  (*limited use*)

$\text{LiF}-\text{NaF}-\text{KF}$  (called FLINAK)

$\text{LiF}-\text{CaF}_2$

Electrochemical separation processes under development:

Cathodic deposition method

Anodic dissolution method

# Electroseparation studies:

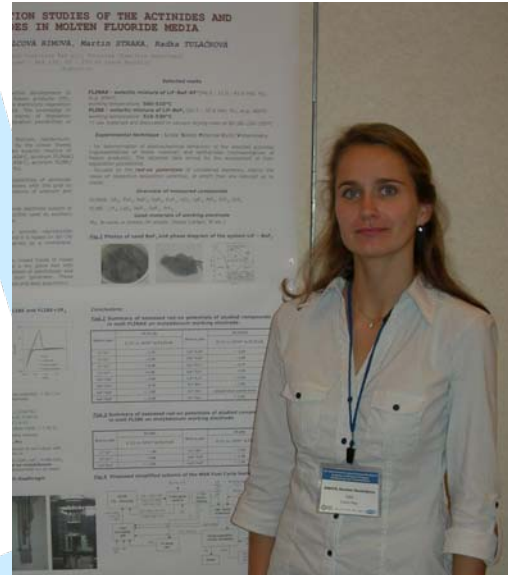

The detailed results of the electrochemical separation studies of the actinides and lanthanides in molten fluoride media are discussed in poster No. III-22 presented by Karolína Chuchvalcová Bímová.

Melt	FLIBE(-Na)	E [V] vs. Ni/Ni <sup>2+</sup> in FLIBE	
Studied reaction	mechanism	Potential without / with separator	
Melt decomposition	one-step	-1.50	-
Uranium reduction	two-step	-0,90	-1,40
Thorium reduction		No reduction	
Lanthanides reduction (La, Nd, Pr, Gd)		No reduction	

Melt	FLINAK	E [V] vs. Ni/Ni <sup>2+</sup> in FLINAK		LiF-CaF <sub>2</sub>	E [V] vs. Ni/Ni <sup>2+</sup> in LiF-CaF <sub>2</sub>	
Studied reaction	mechanism	Potential without / with separator		mechanism	Potential without separator	
Melt decomposition	one-step	-2.05/ -1,80	-	one-step	-2.30	-
Uranium reduction	two-step	-1.20/ -0,25	-1.75/ -1,54	two-step	-1.40	-1.85
Thorium reduction	two-step	-0.70	-2.00	N/A	N/A	N/A
Neodymium reduction	two-step	-1.00/ -0,70	< -2.05/ < -1,80	one-step	-2.00	-
Gadolinium reduction	two-step	-1.01 / -0,95	< -2.05/ < -1,80	one-step	-2.10	-
Europium reduction	two-step	-0.75	-1.95	one-step	< -2.30	-
Strontium reduction	not observed	< -2.05	-	N/A	N/A	N/A
Zirconium reduction	complicated	from -1.40*	-1.80*	N/A	N/A	N/A

## Flow-sheeting of MSR on-line reprocessing technology

- The flow-sheet concept comes out from the former results achieved by ORNL team during MSRE and MSBR projects and from the current progress in electrochemical separation studies
- The reprocessing technology is based on primary total (non-selective) “Molten-salt / Liquid metal” reductive extraction from MSR carrier salt and on subsequent electrochemical separation processes:
  - Anodic dissolution method (selective electrochemical oxidation of reduced elements according to the differences in their red-ox potentials)
  - Cathodic deposition method (selective electrochemical reduction of dissolved ions in molten carrier salt)

# Conceptual flow-sheet of MSTR-SPHINX on-line reprocessing technology (MSR – actinide burner)

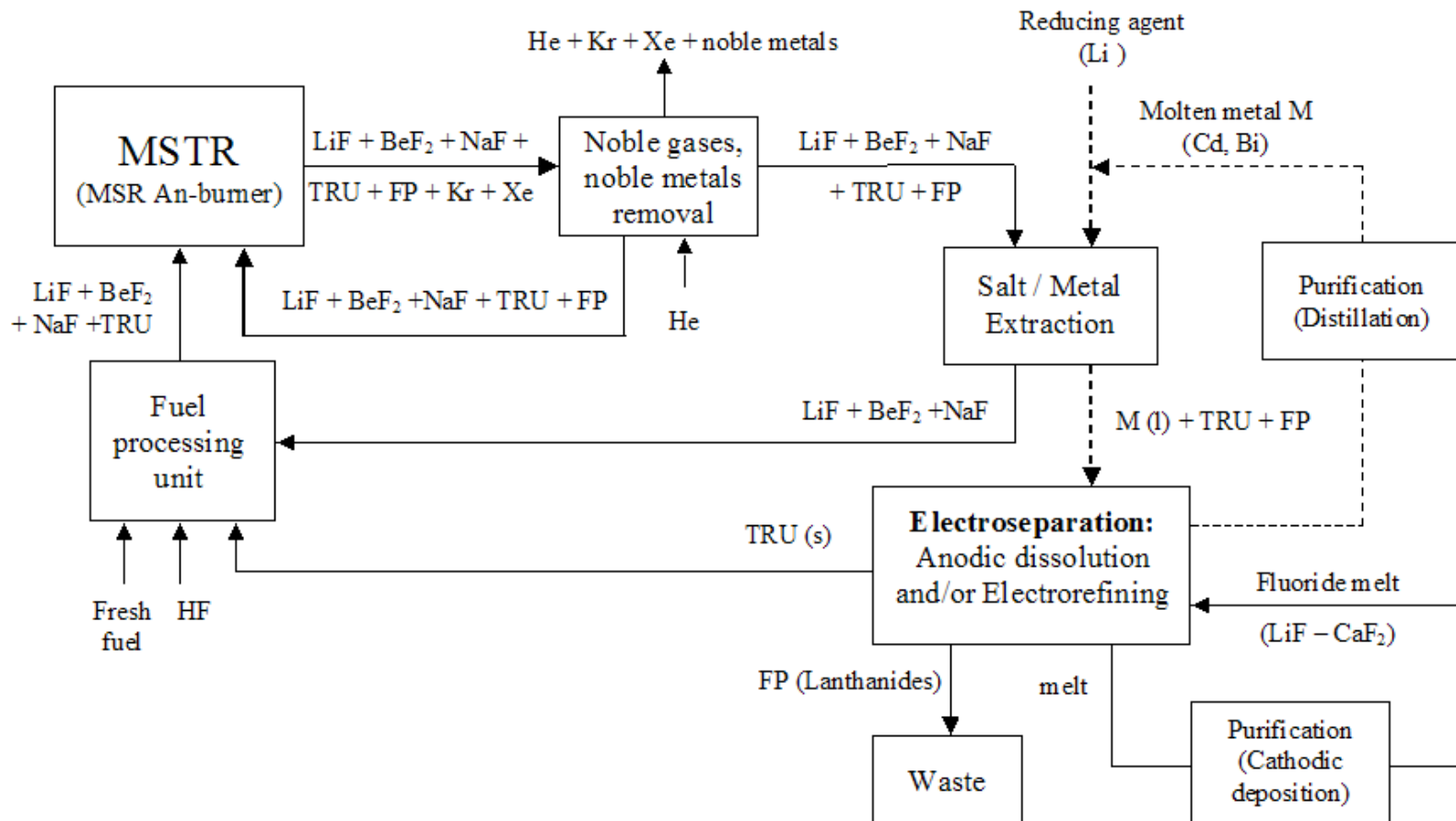

## Conclusions

- **Successful solution of MSR/MSTR fuel cycle technologies represents an essential precondition for future deployment of MSR systems.**
- **Fluoride pyrochemical separation methods seem to be promising technologies for their use within these fuel cycles.**
- **Current R&D effort and achieved results offer a prospect, that the MSR/MSTR fuel processing and reprocessing will be solved successfully.**

## Acknowledgements

*The work has been realized thanks to the financial support of the Czech Power Company ČEZ and the Ministry of Industry and Trade.*