

MAT=6431 ACE FILE PRODUCED AT NEA WITH NDEC
Principal cross sections

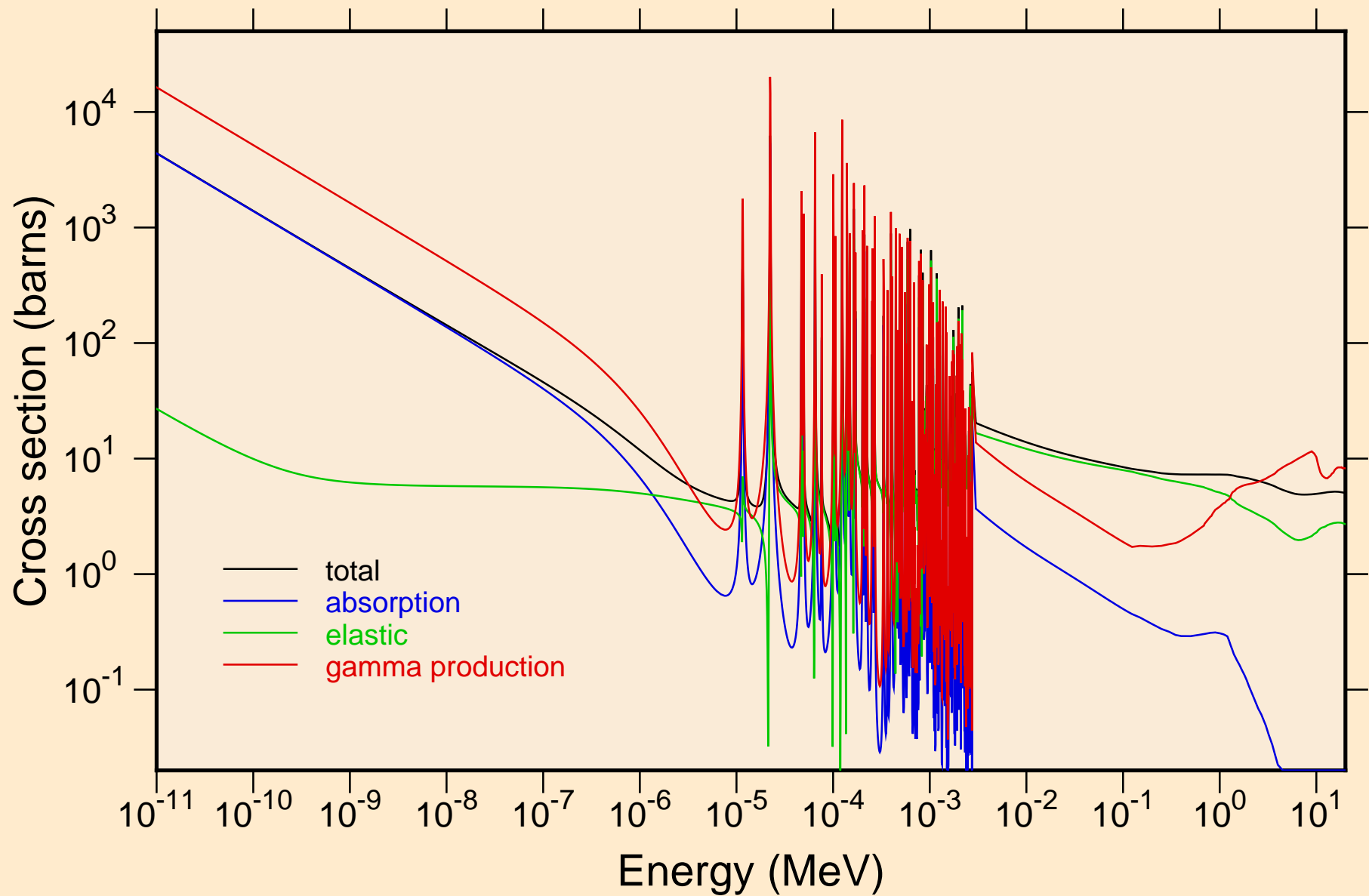

MAT=6431 ACE FILE PRODUCED AT NEA WITH NDEC
resonance total cross section

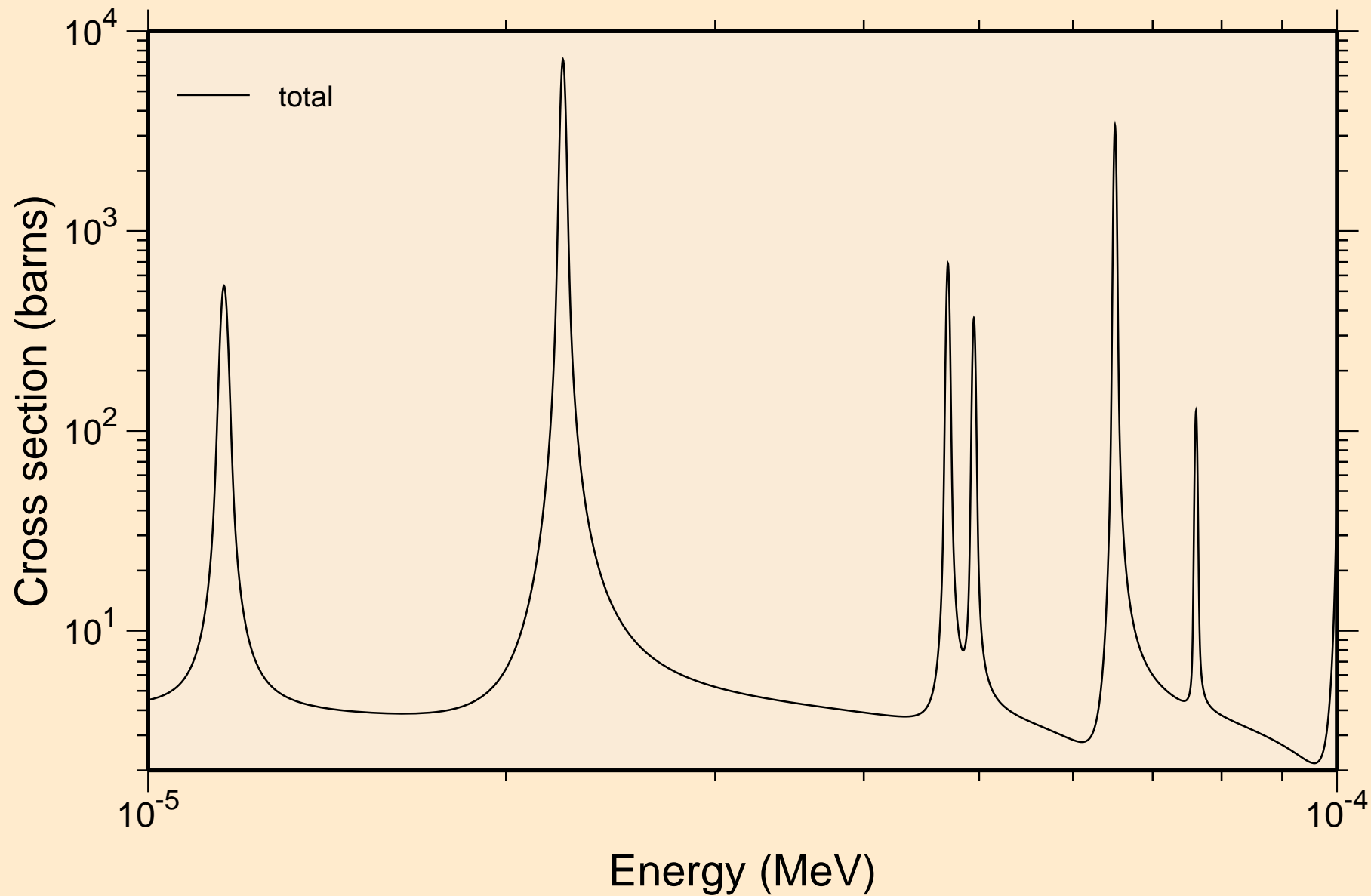

MAT=6431 ACE FILE PRODUCED AT NEA WITH NDEC
resonance total cross section

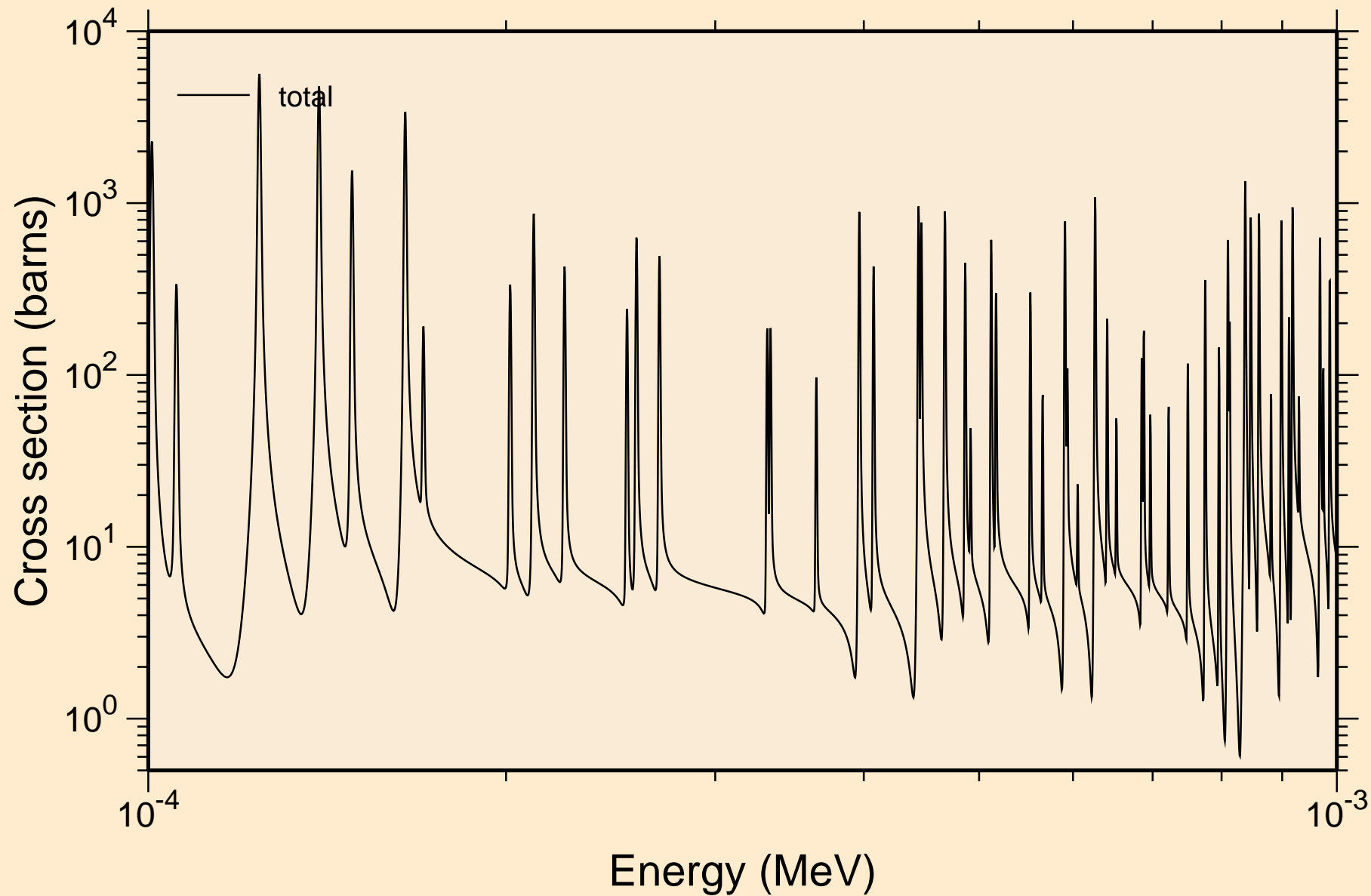

MAT=6431 ACE FILE PRODUCED AT NEA WITH NDEC
resonance total cross section

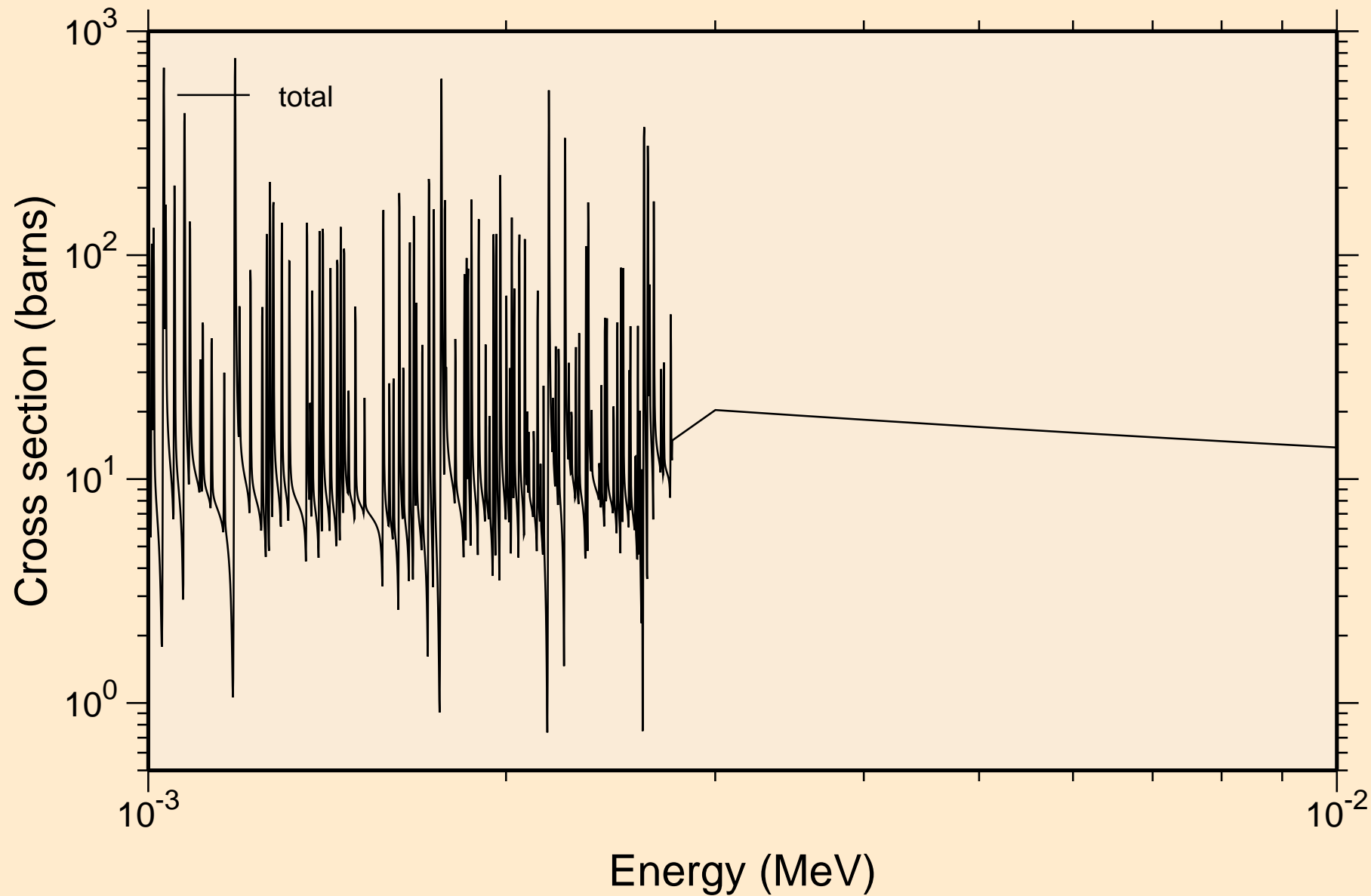

MAT=6431 ACE FILE PRODUCED AT NEA WITH NDEC
resonance total cross section

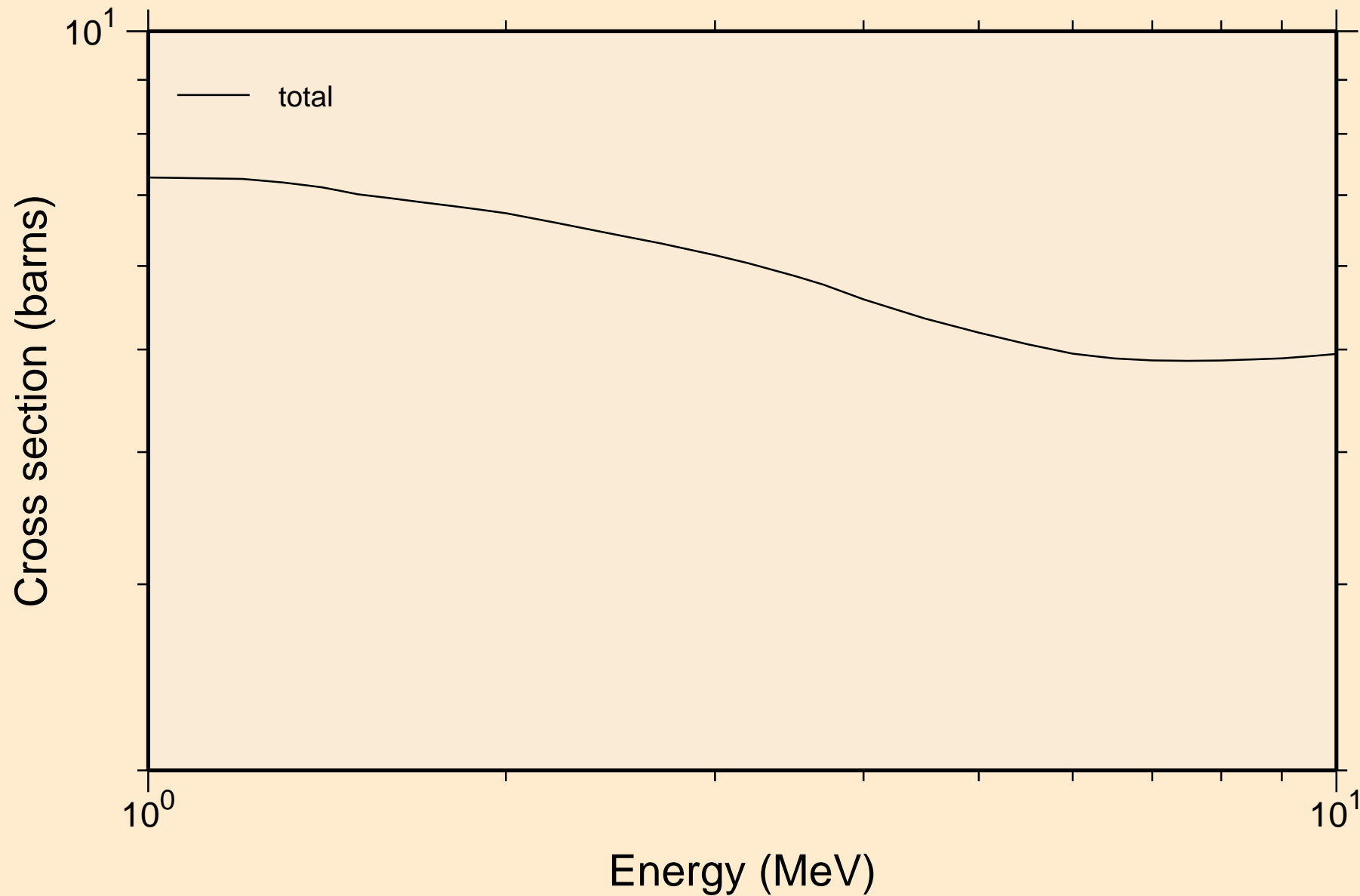

MAT=6431 ACE FILE PRODUCED AT NEA WITH NDEC
resonance absorption cross sections

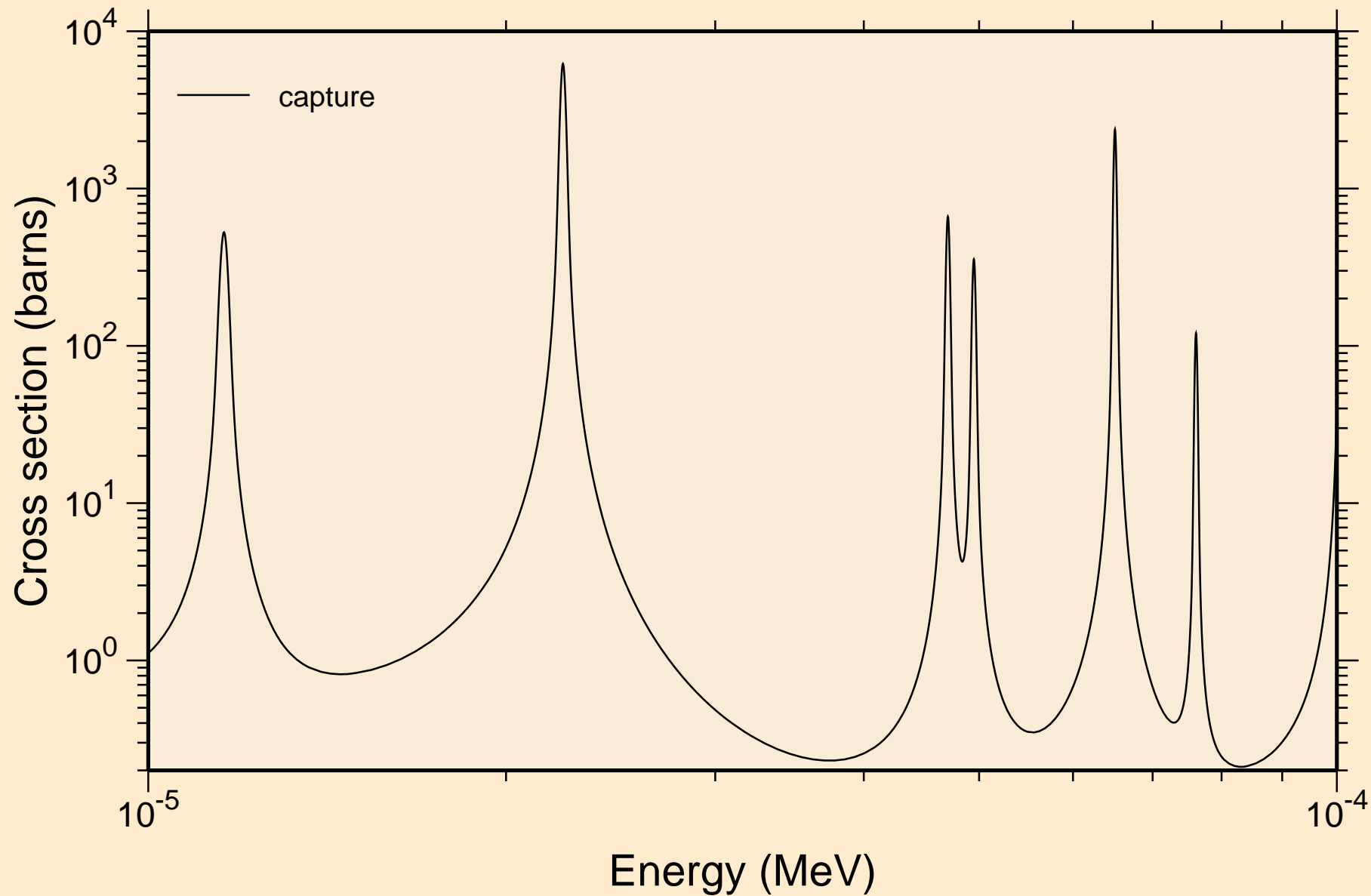

MAT=6431 ACE FILE PRODUCED AT NEA WITH NDEC
resonance absorption cross sections

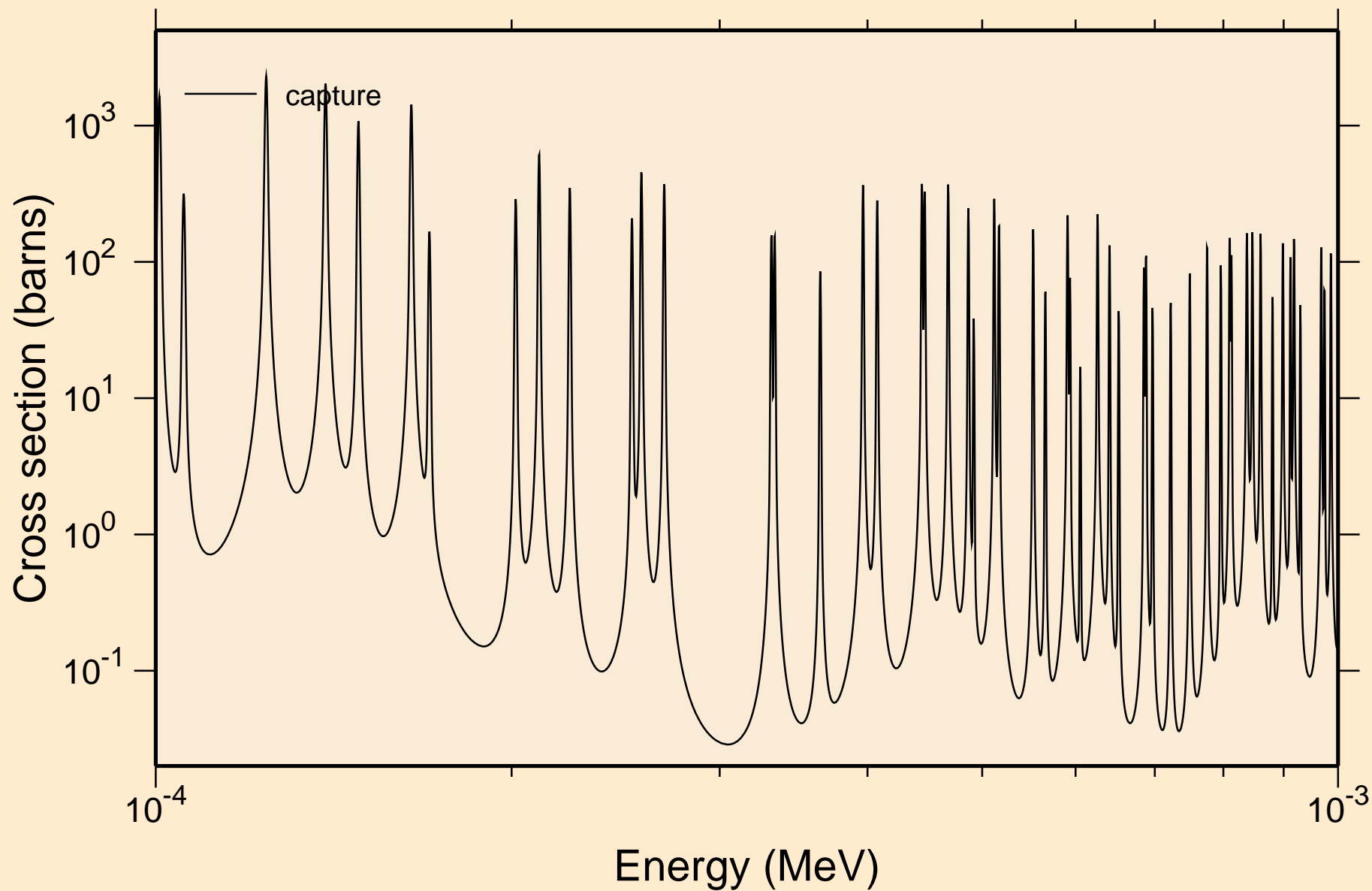

MAT=6431 ACE FILE PRODUCED AT NEA WITH NDEC
resonance absorption cross sections

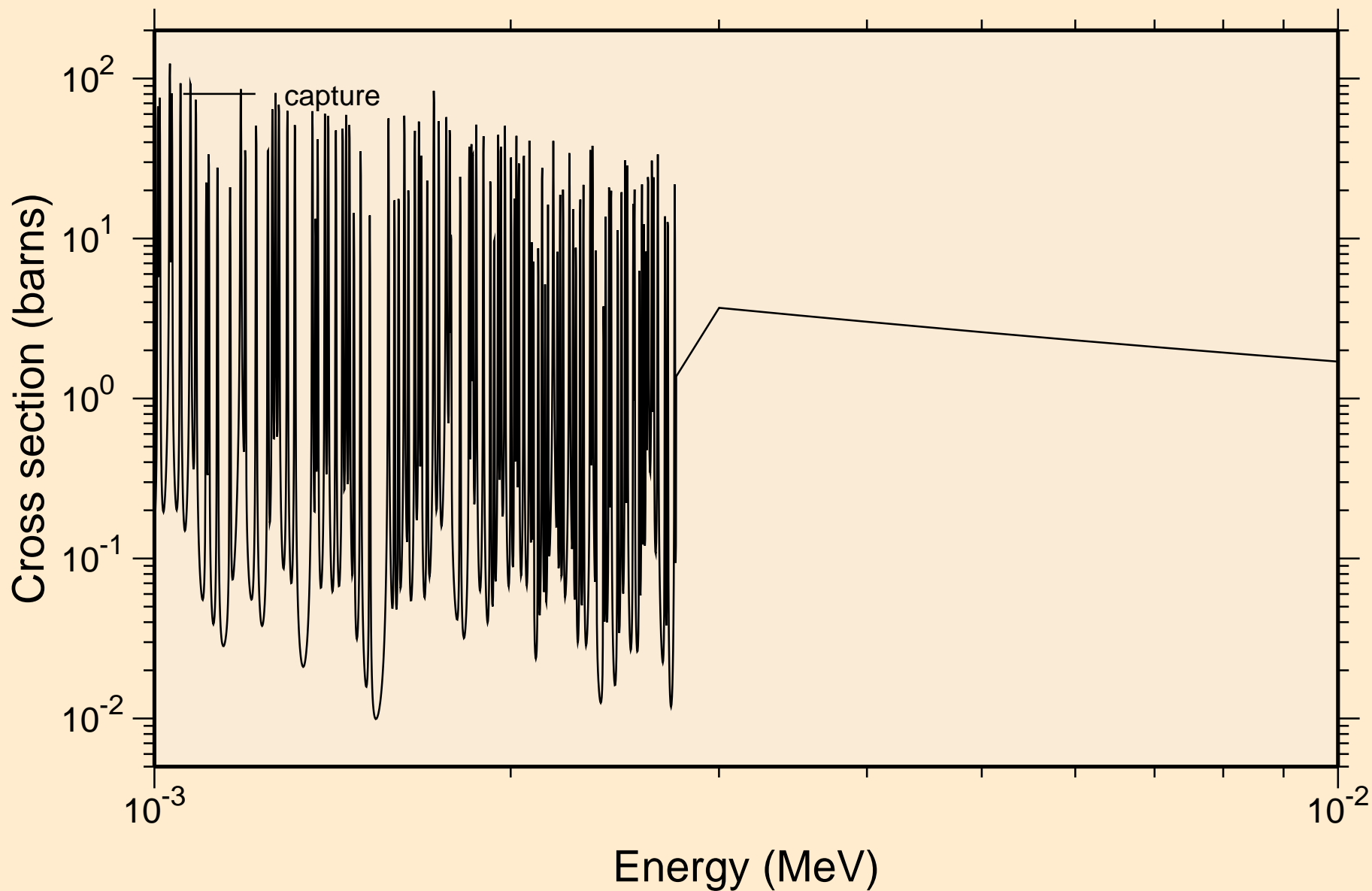

MAT=6431 ACE FILE PRODUCED AT NEA WITH NDEC
resonance absorption cross sections

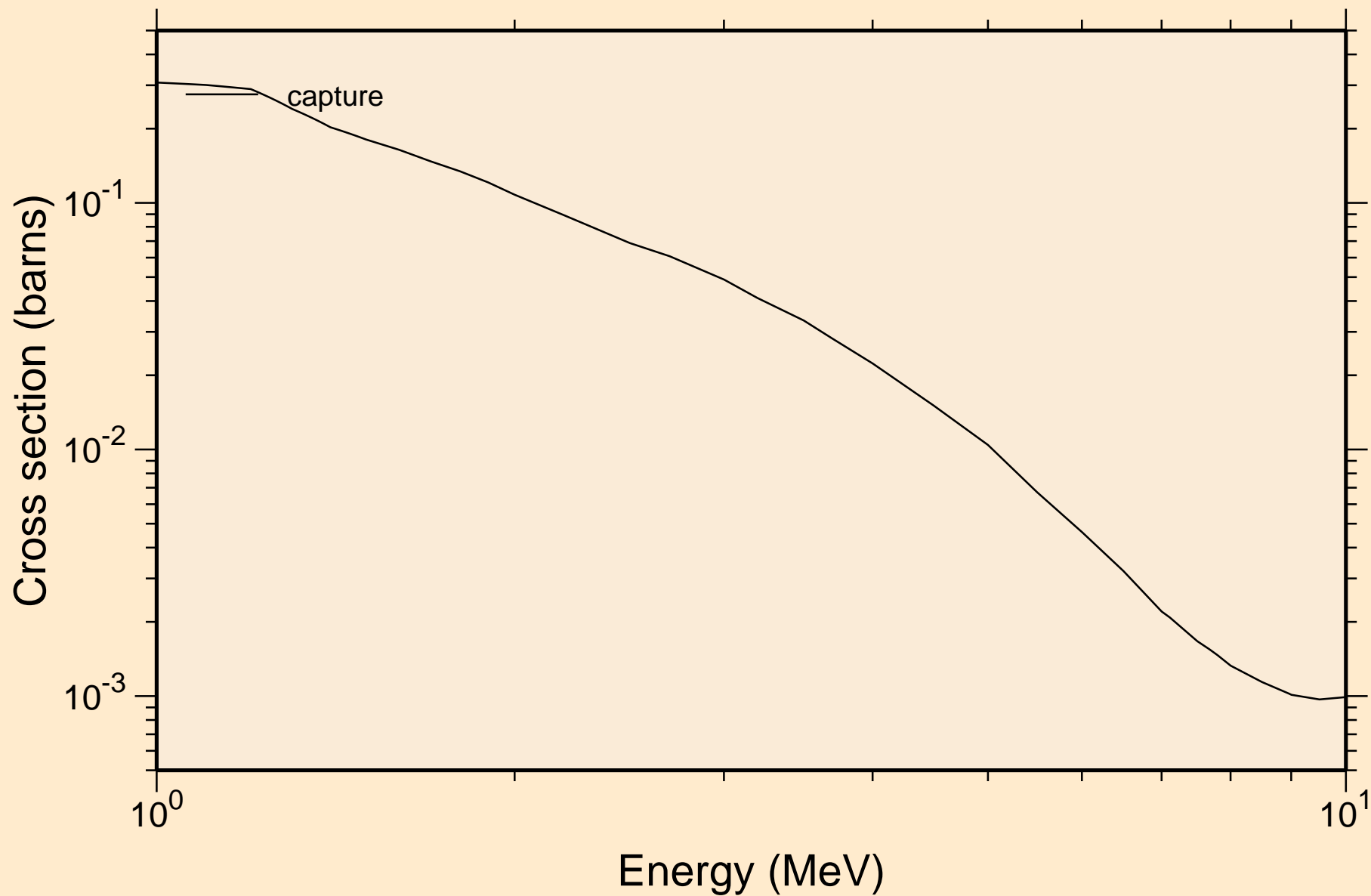

MAT=6431 ACE FILE PRODUCED AT NEA WITH NDEC
UR total cross section

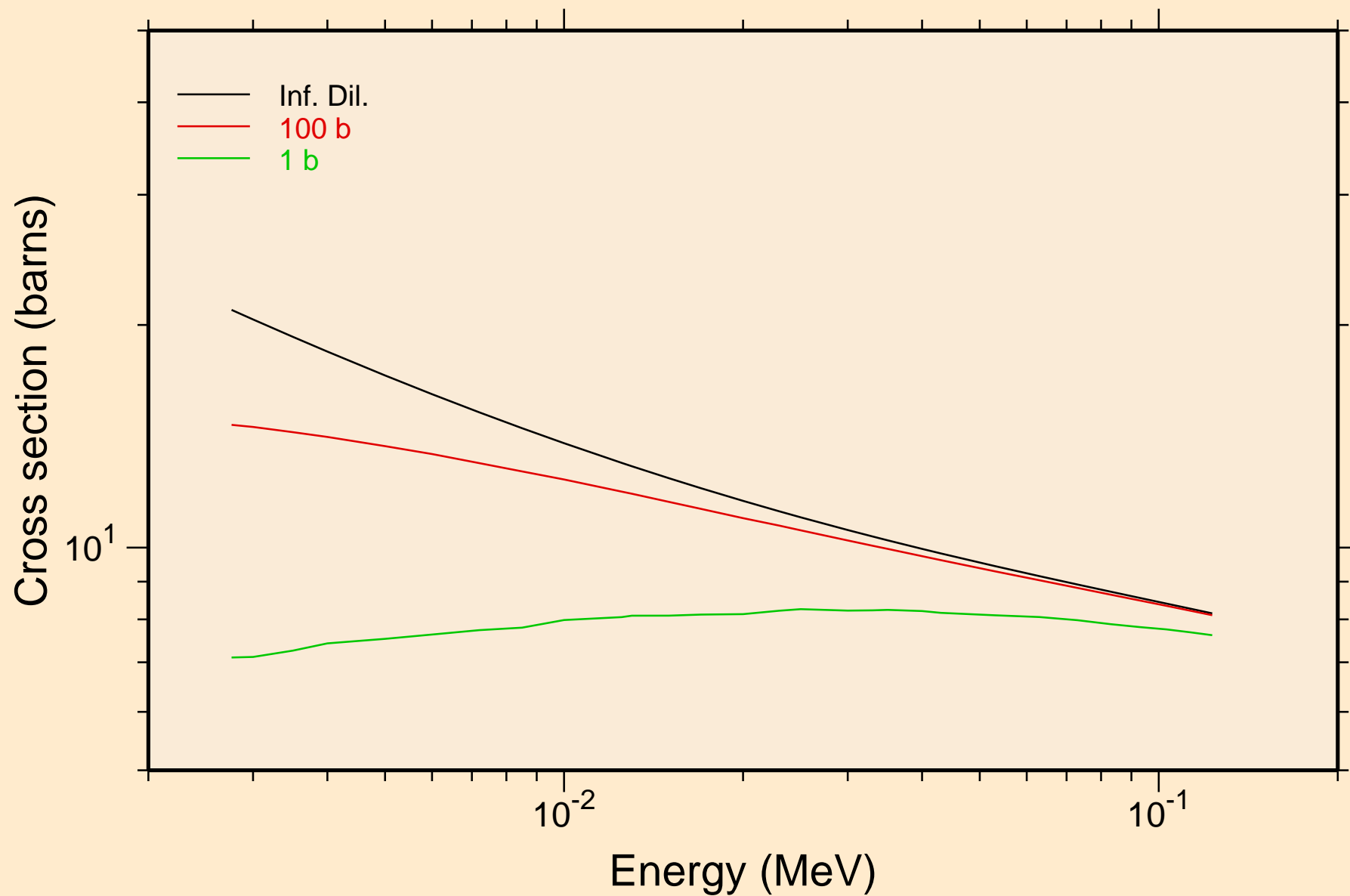

MAT=6431 ACE FILE PRODUCED AT NEA WITH NDEC
UR elastic cross section

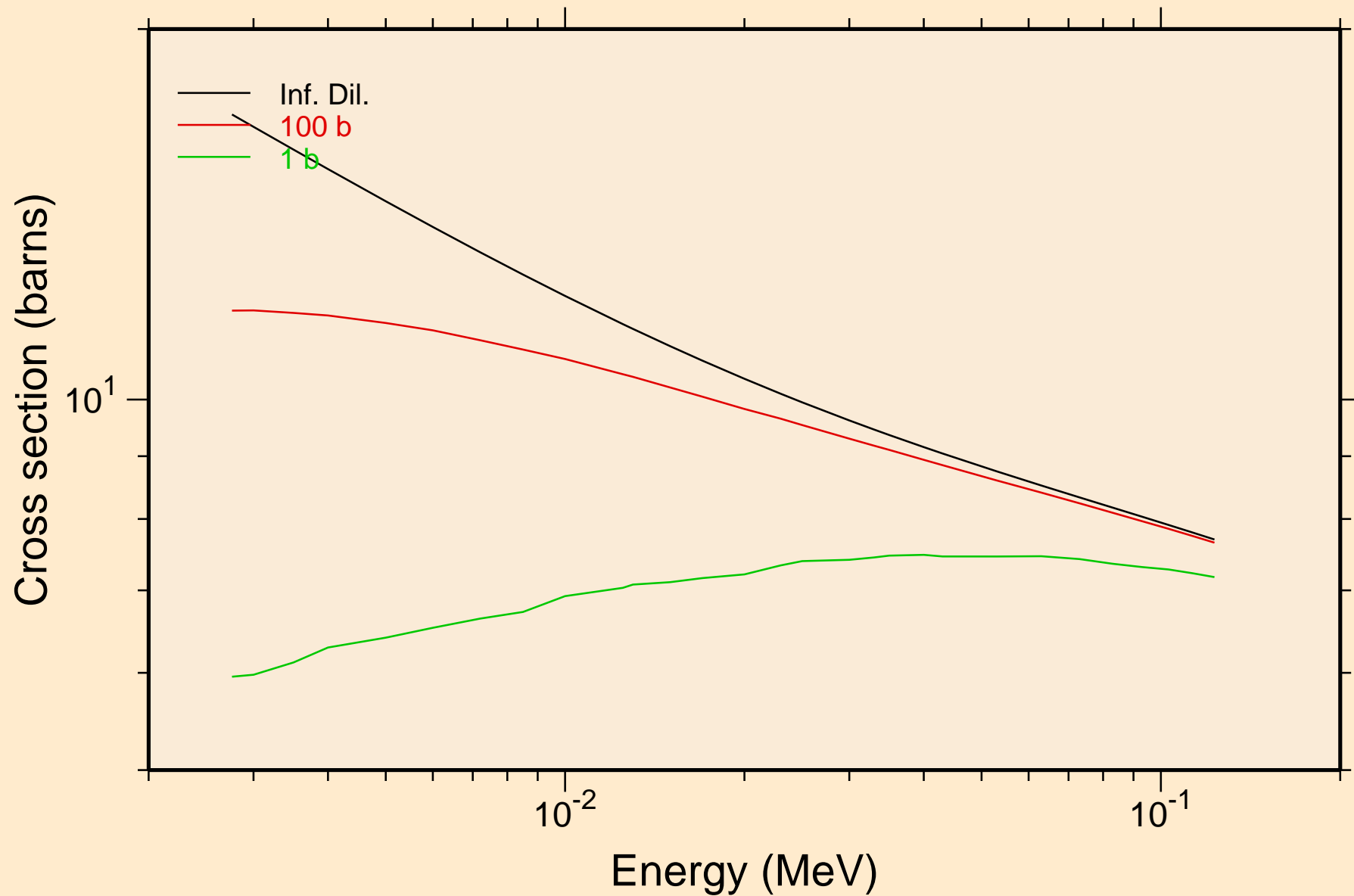

MAT=6431 ACE FILE PRODUCED AT NEA WITH NDEC
UR capture cross section

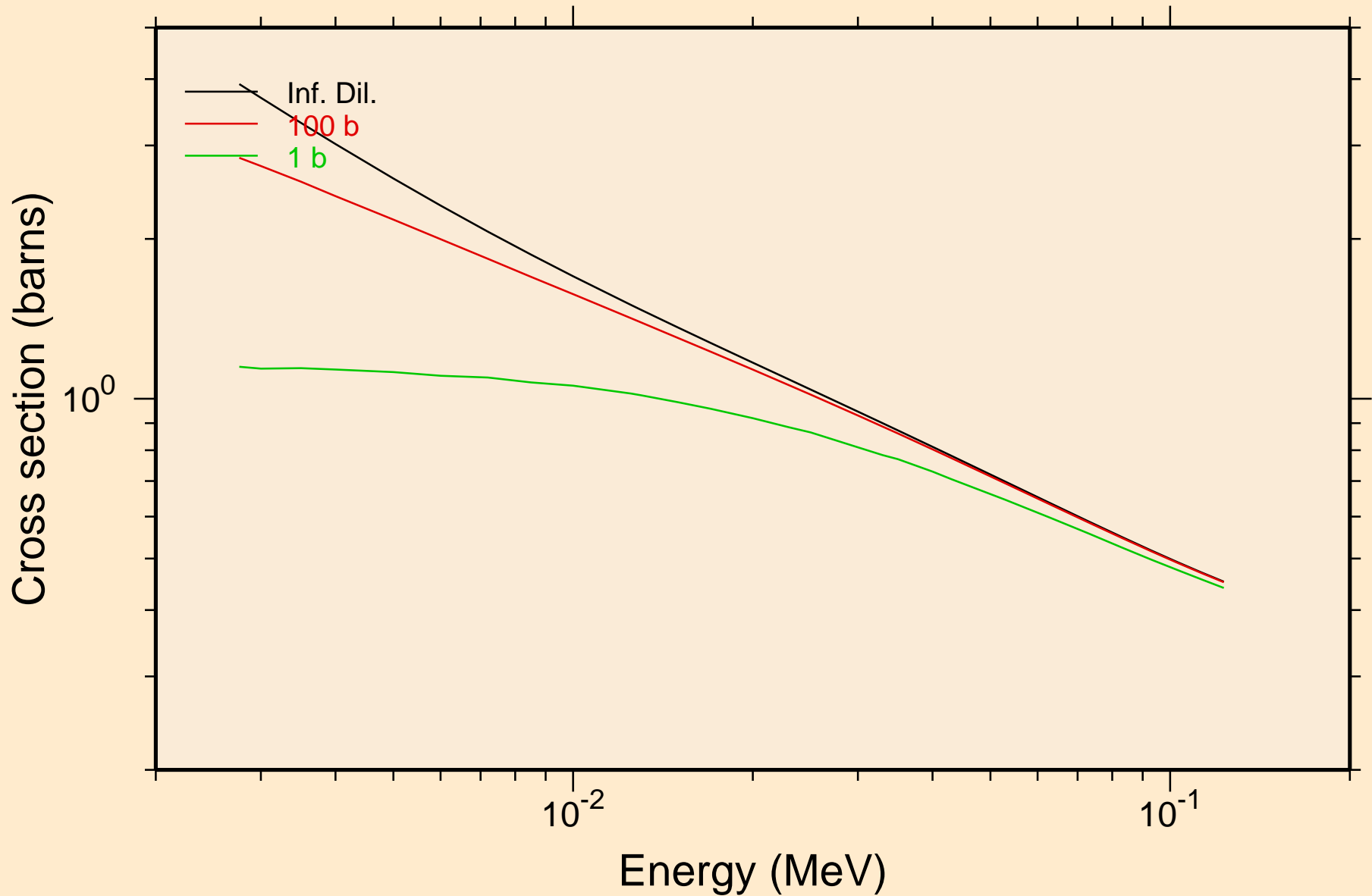

MAT=6431 ACE FILE PRODUCED AT NEA WITH NDEC
Heating

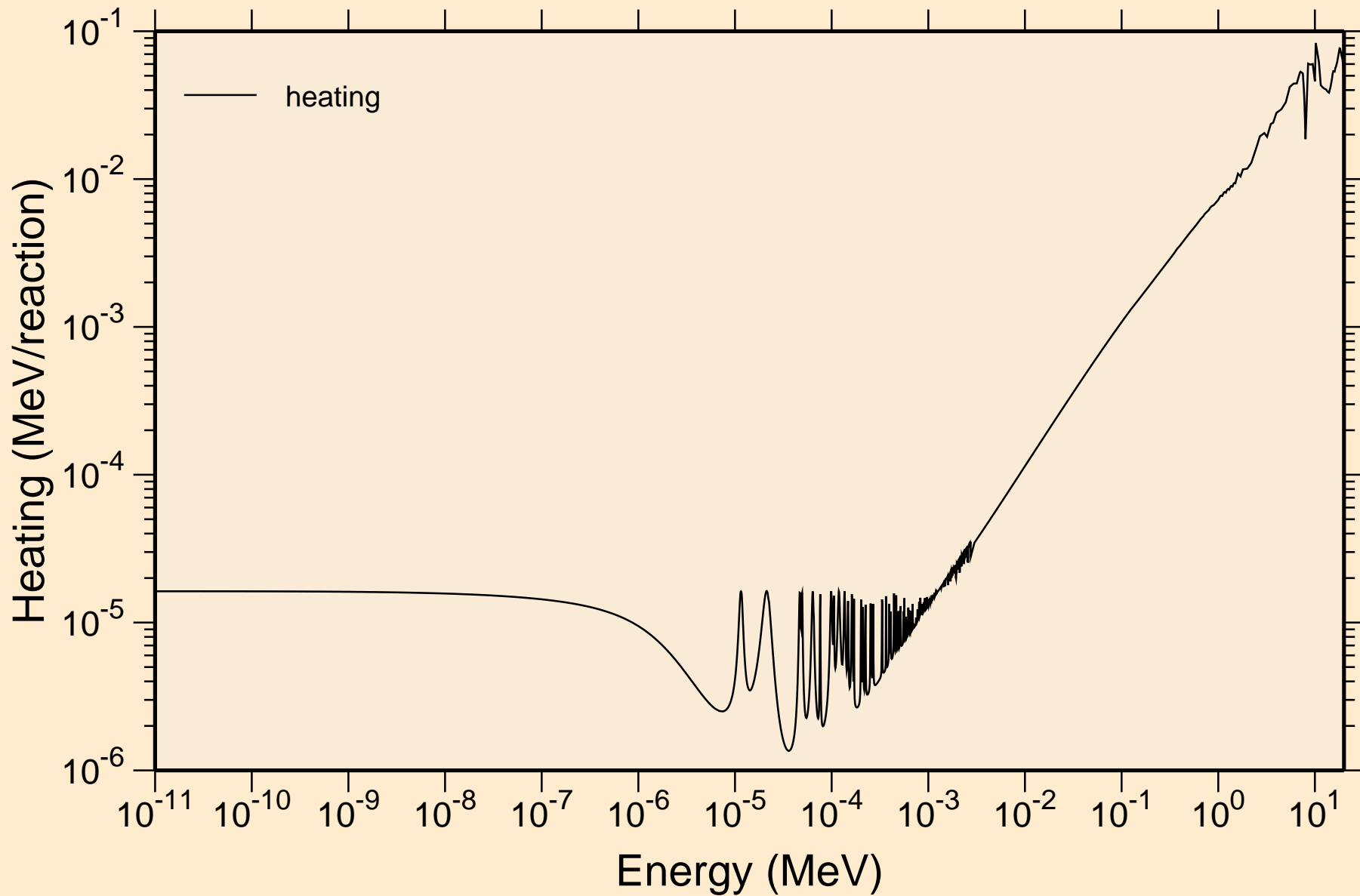

MAT=6431 ACE FILE PRODUCED AT NEA WITH NDEC
Damage

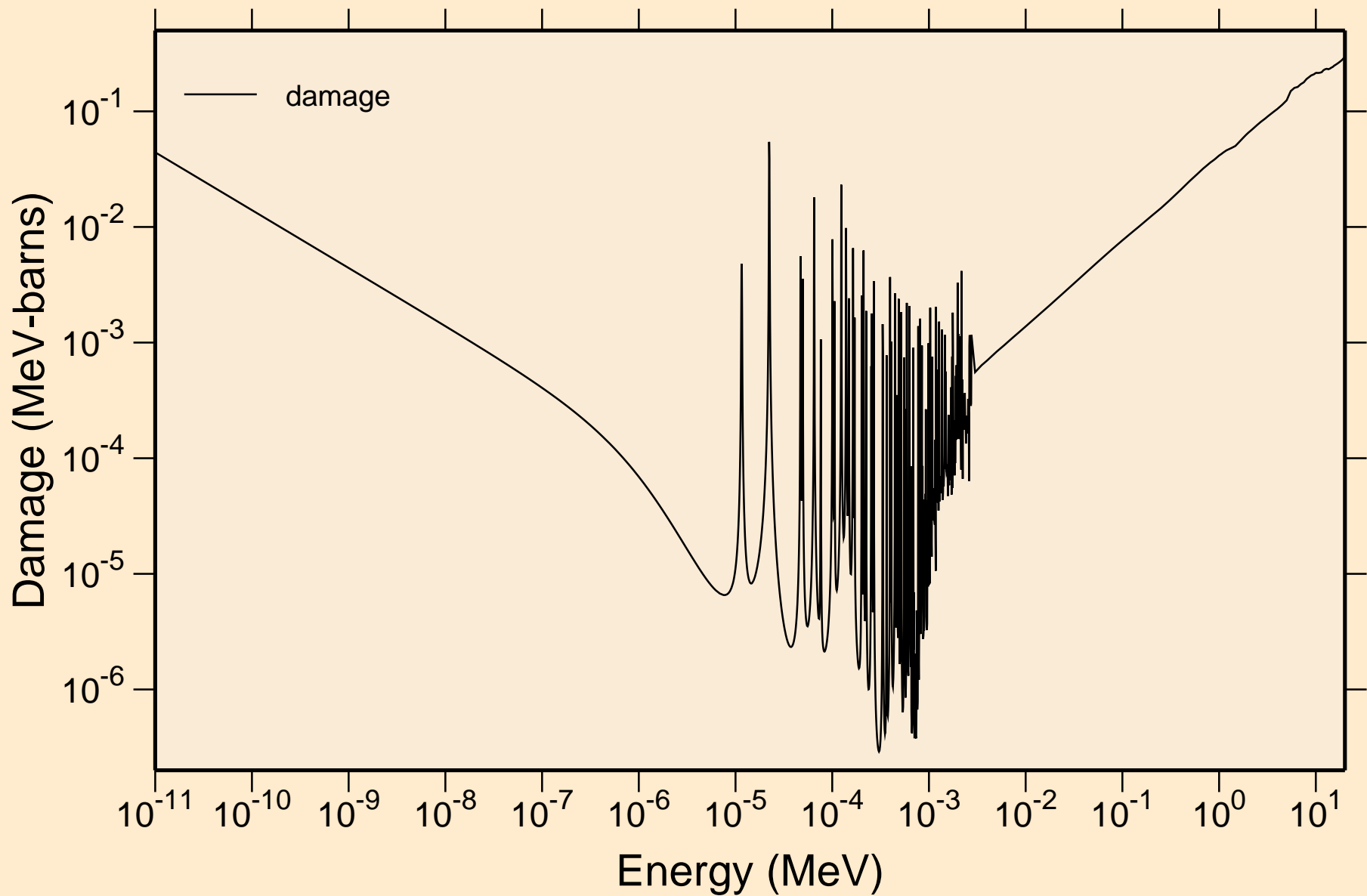

MAT=6431 ACE FILE PRODUCED AT NEA WITH NDEC
Non-threshold reactions

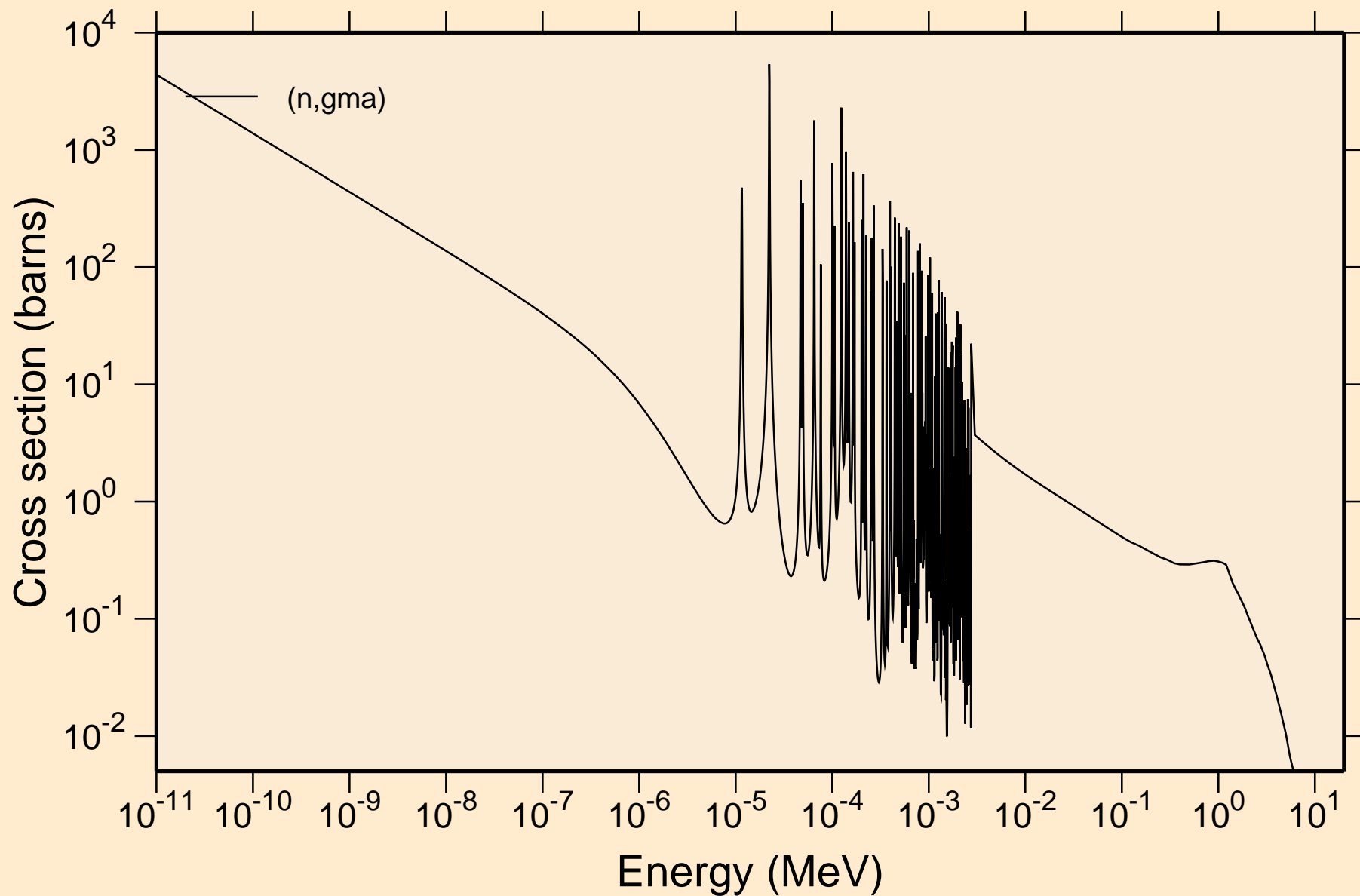

MAT=6431 ACE FILE PRODUCED AT NEA WITH NDEC

Principal cross sections

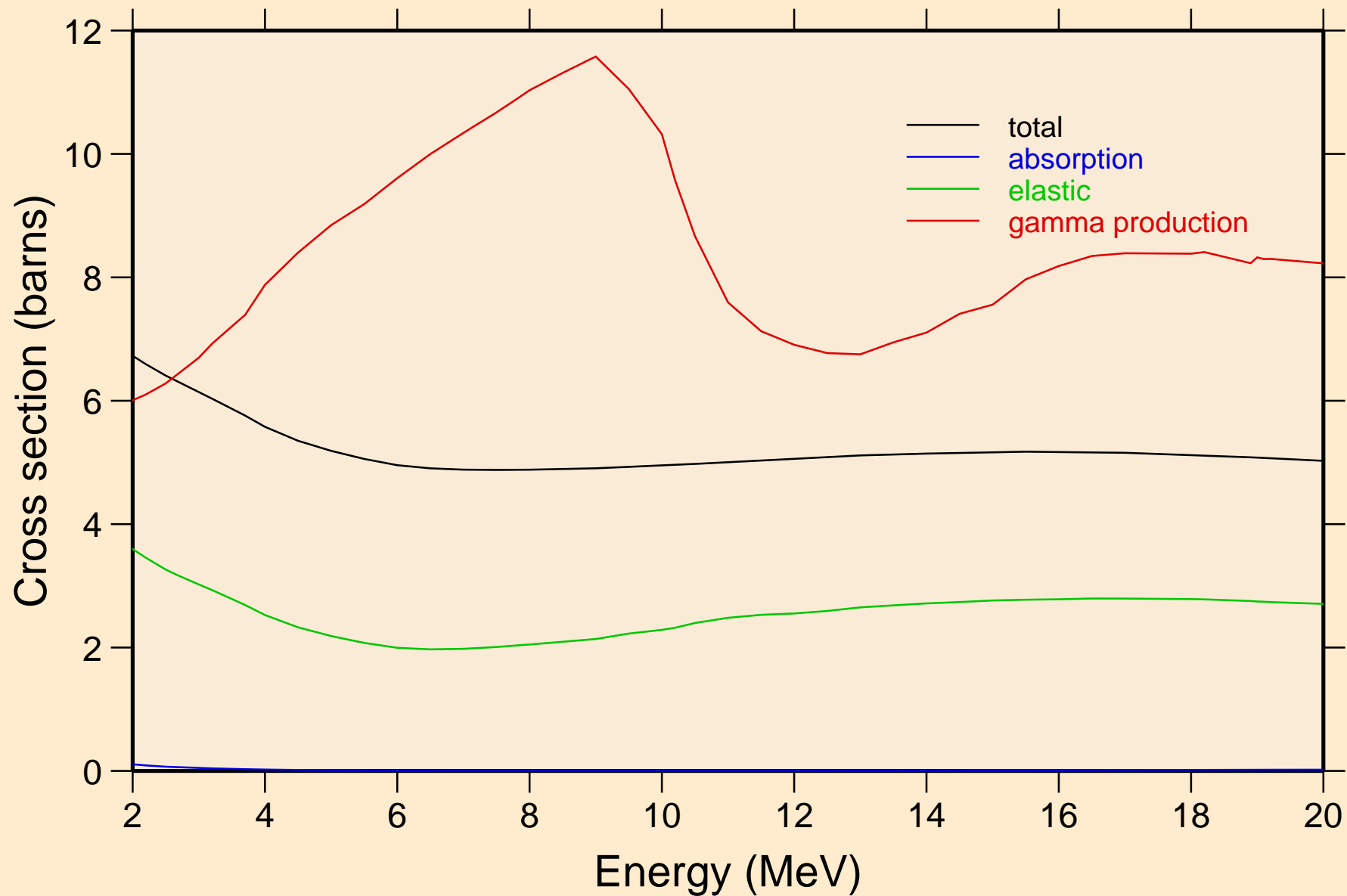

MAT=6431 ACE FILE PRODUCED AT NEA WITH NDEC
Heating

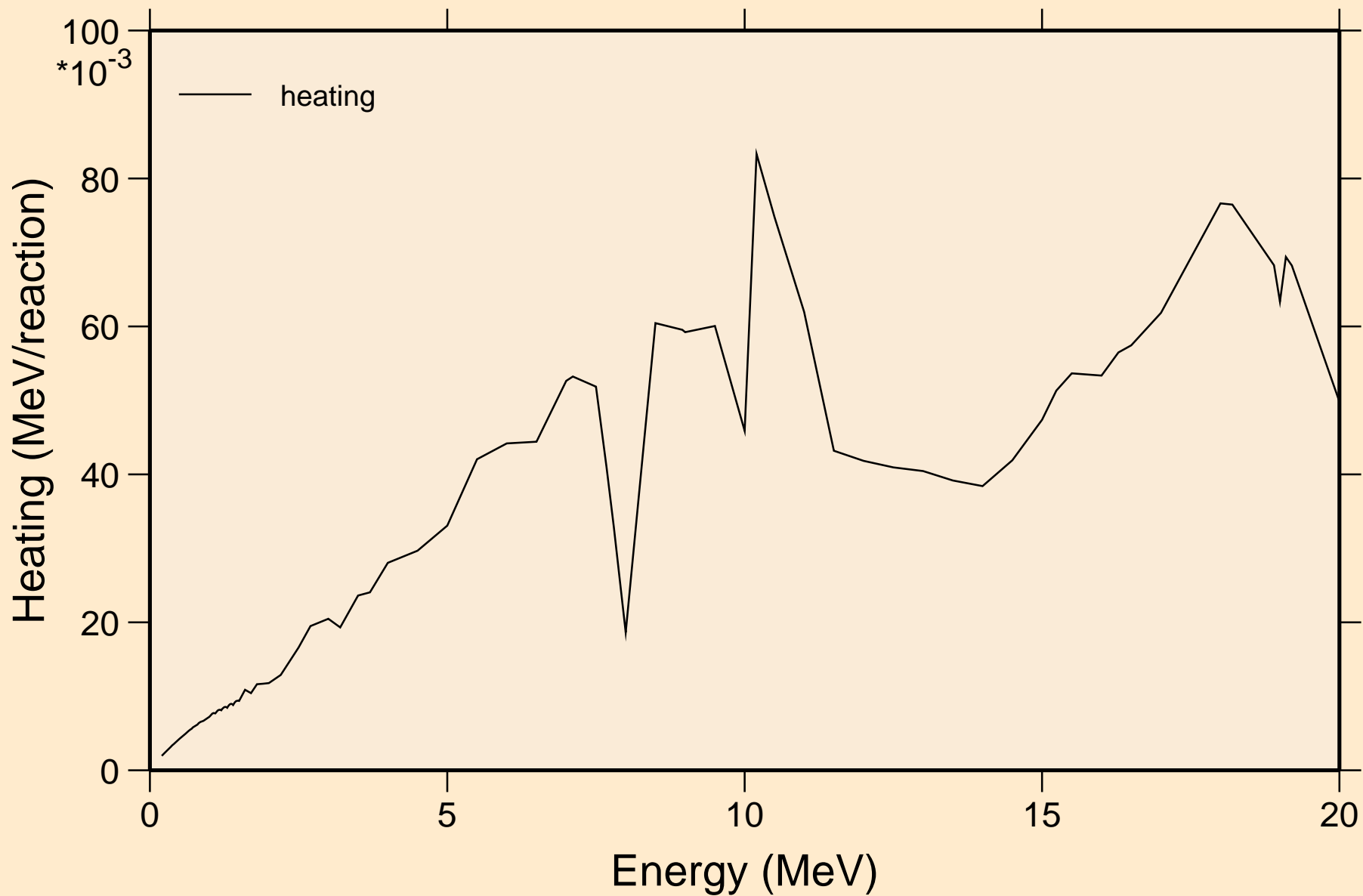

MAT=6431 ACE FILE PRODUCED AT NEA WITH NDEC
Damage

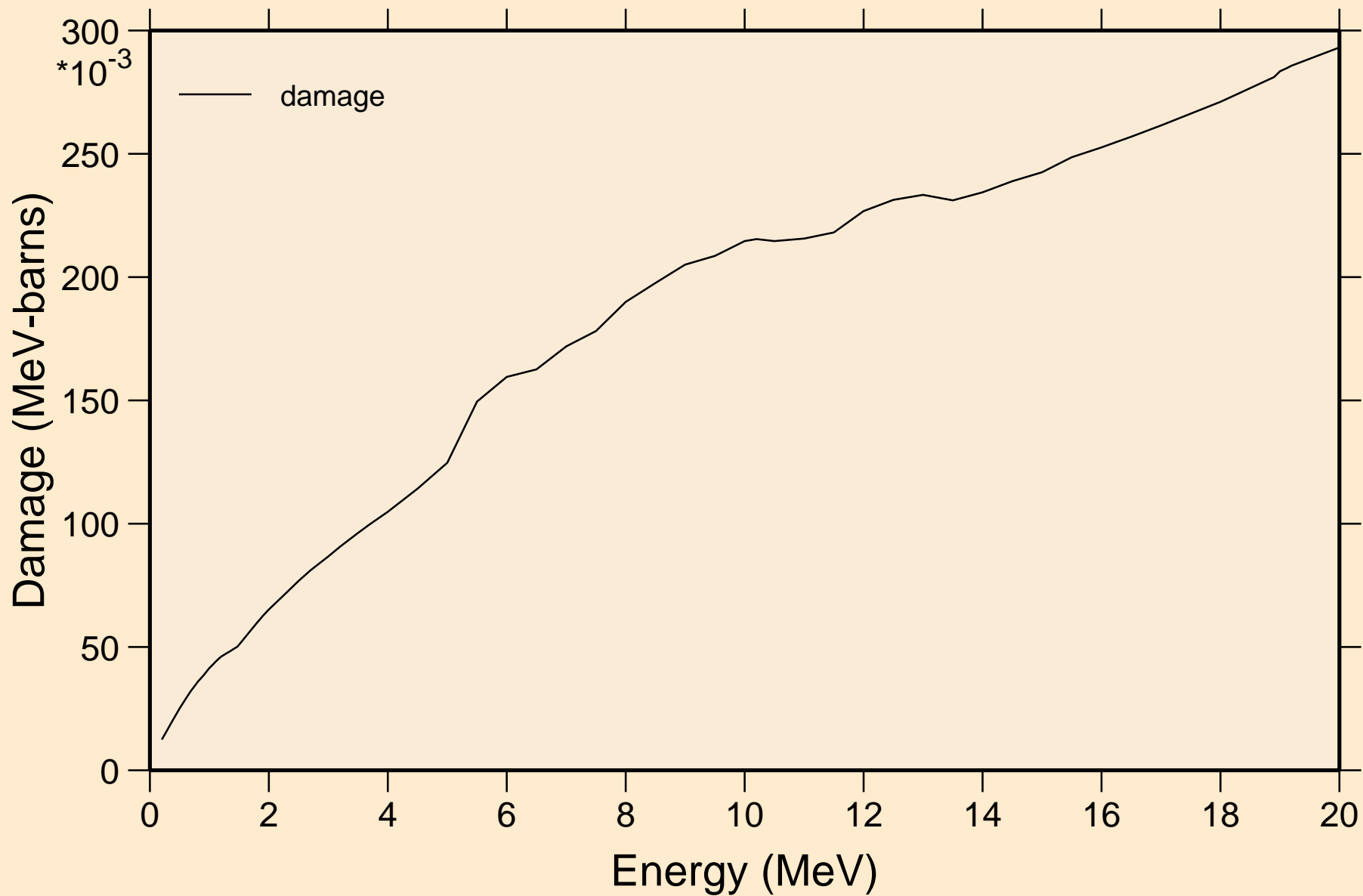

MAT=6431 ACE FILE PRODUCED AT NEA WITH NDEC
Non-threshold reactions

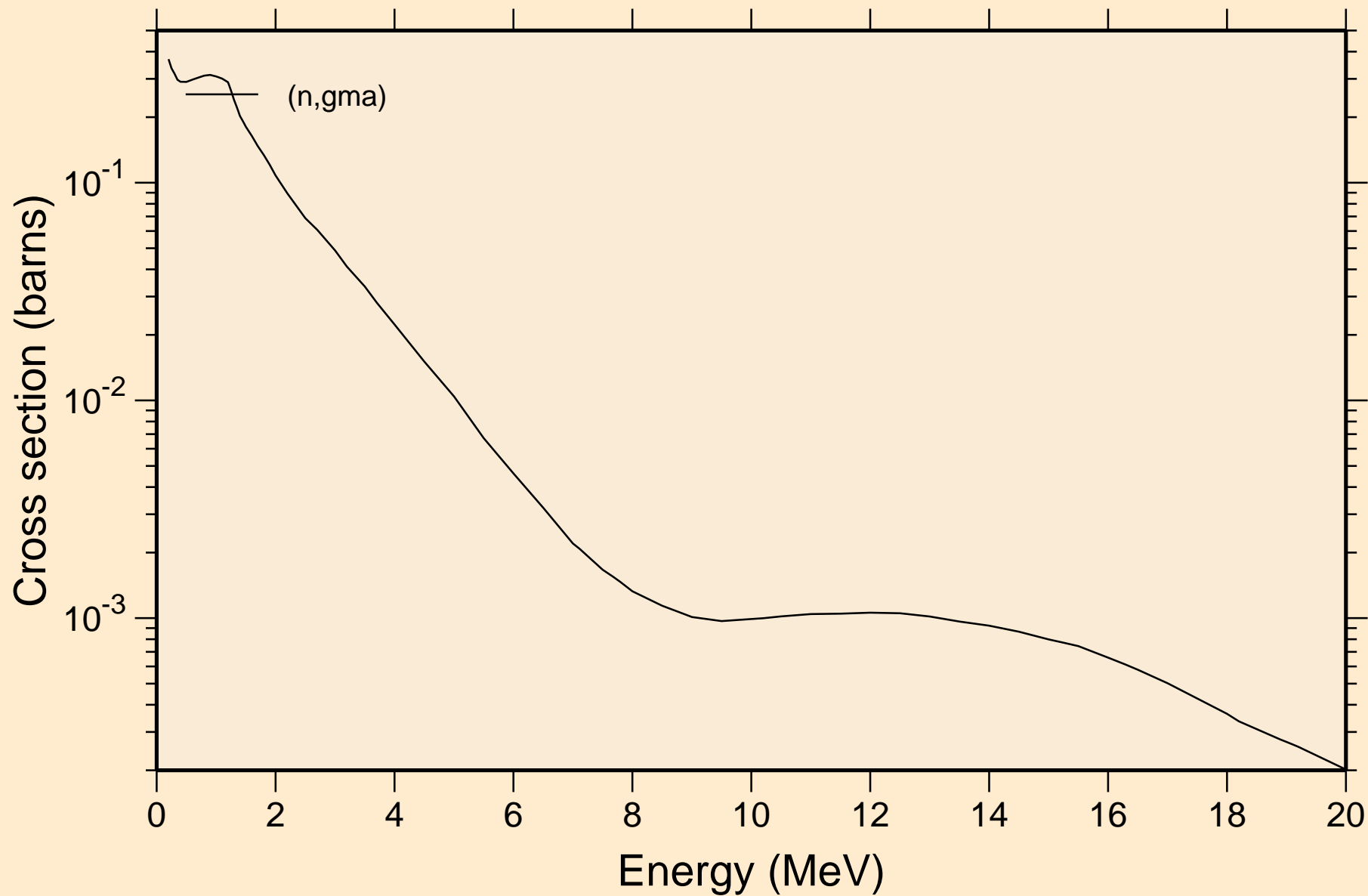

MAT=6431 ACE FILE PRODUCED AT NEA WITH NDEC
Inelastic levels

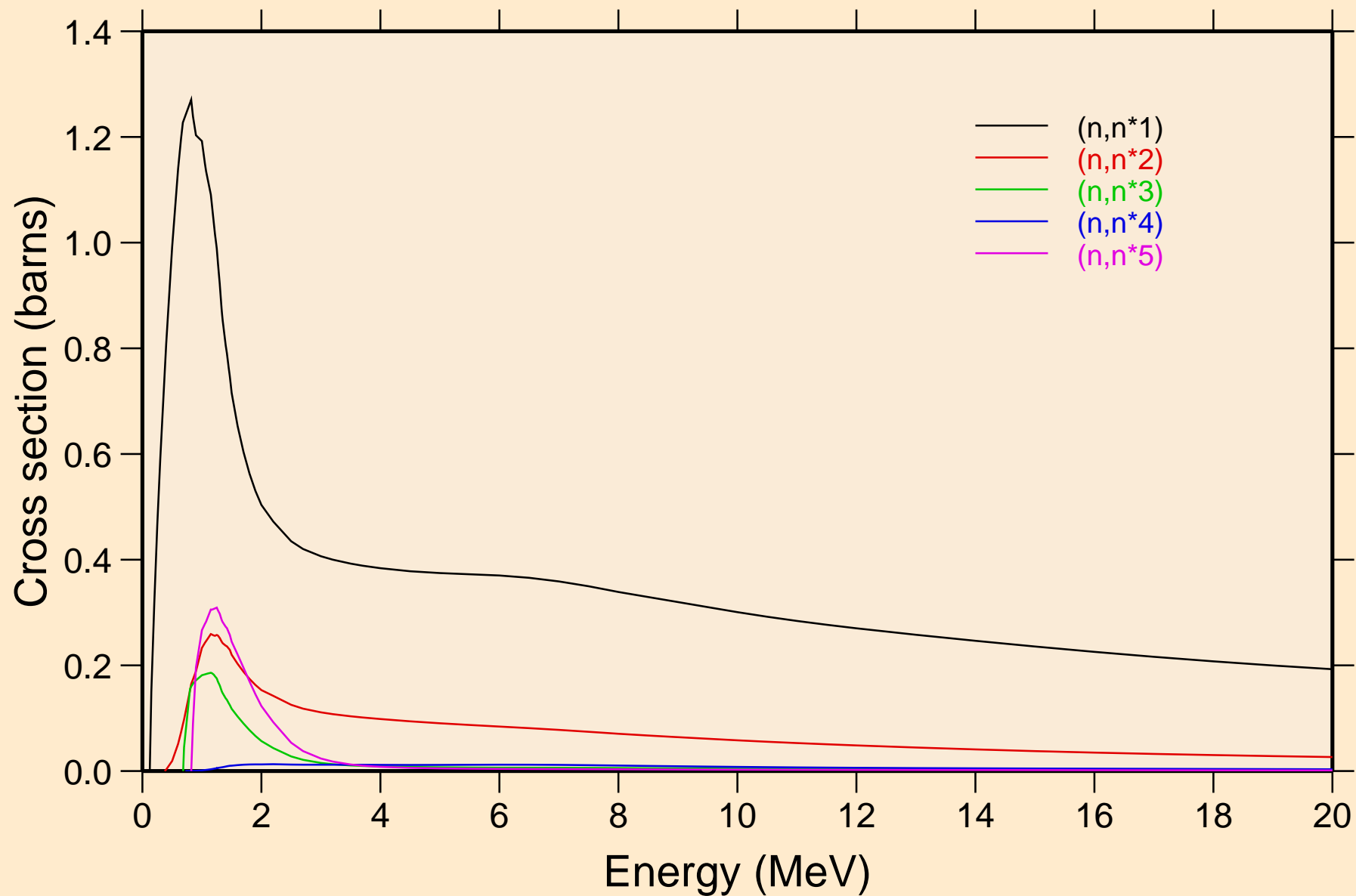

MAT=6431 ACE FILE PRODUCED AT NEA WITH NDEC
Inelastic levels

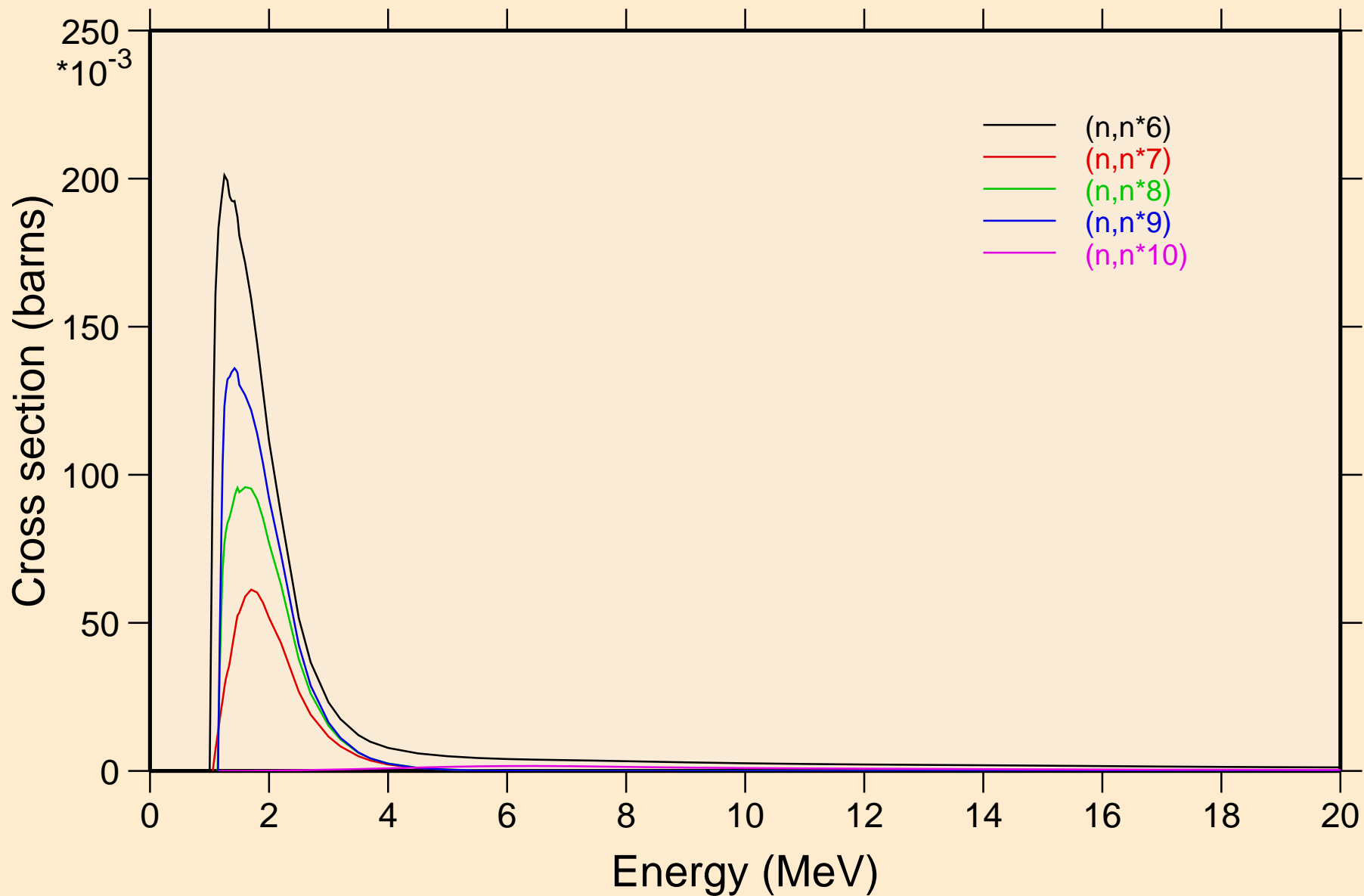

MAT=6431 ACE FILE PRODUCED AT NEA WITH NDEC
Inelastic levels

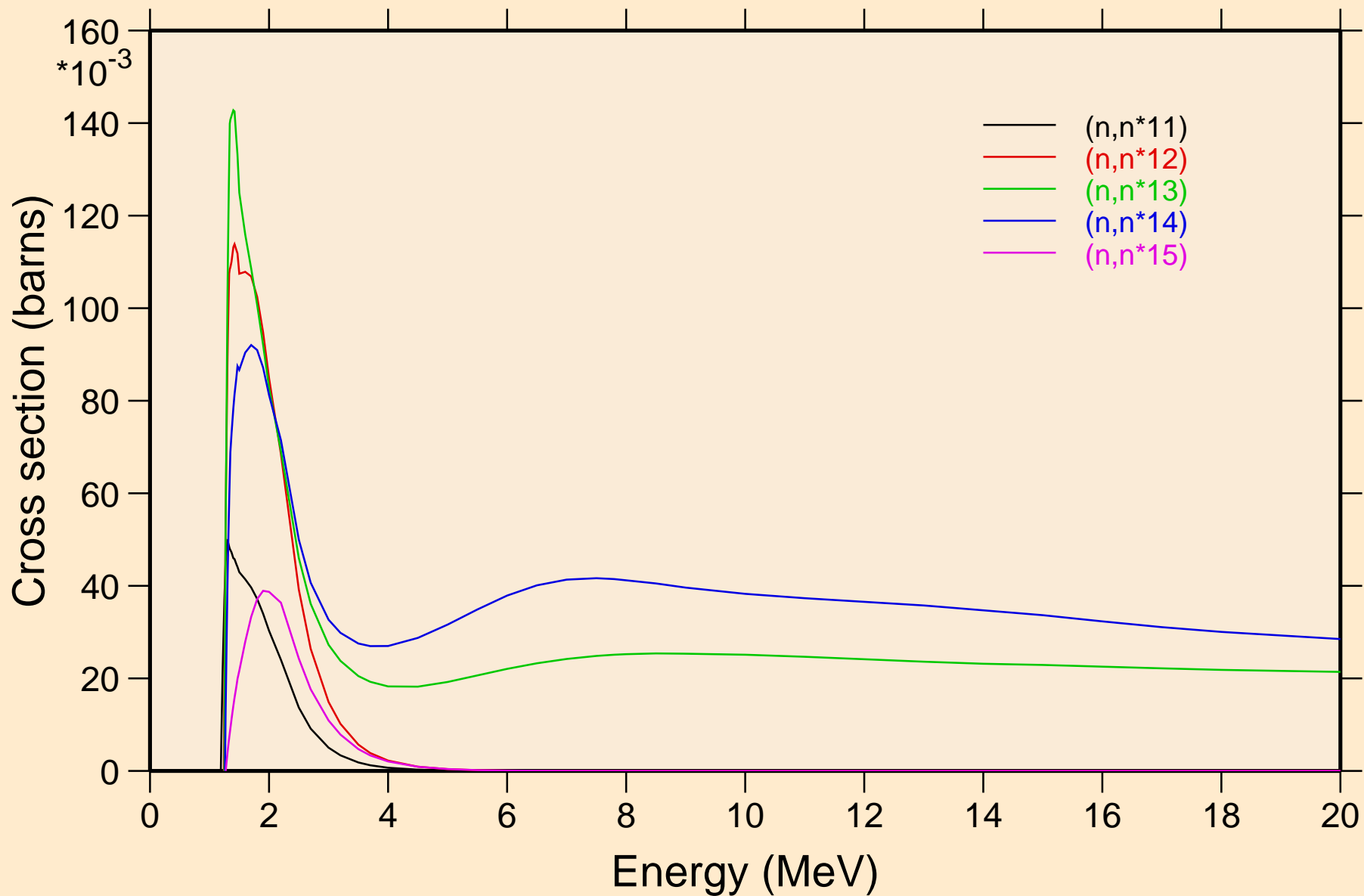

MAT=6431 ACE FILE PRODUCED AT NEA WITH NDEC
Inelastic levels

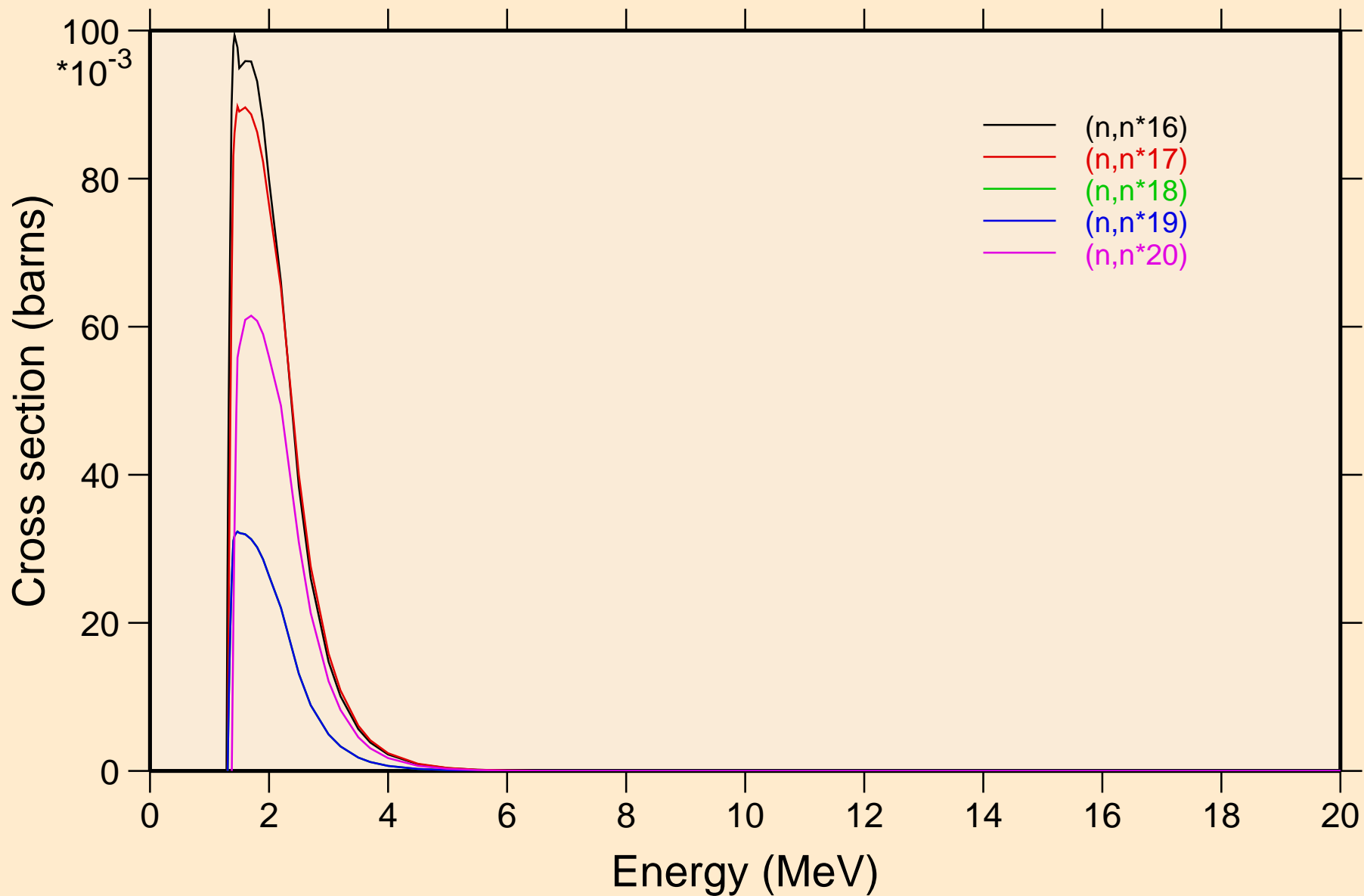

MAT=6431 ACE FILE PRODUCED AT NEA WITH NDEC
Inelastic levels

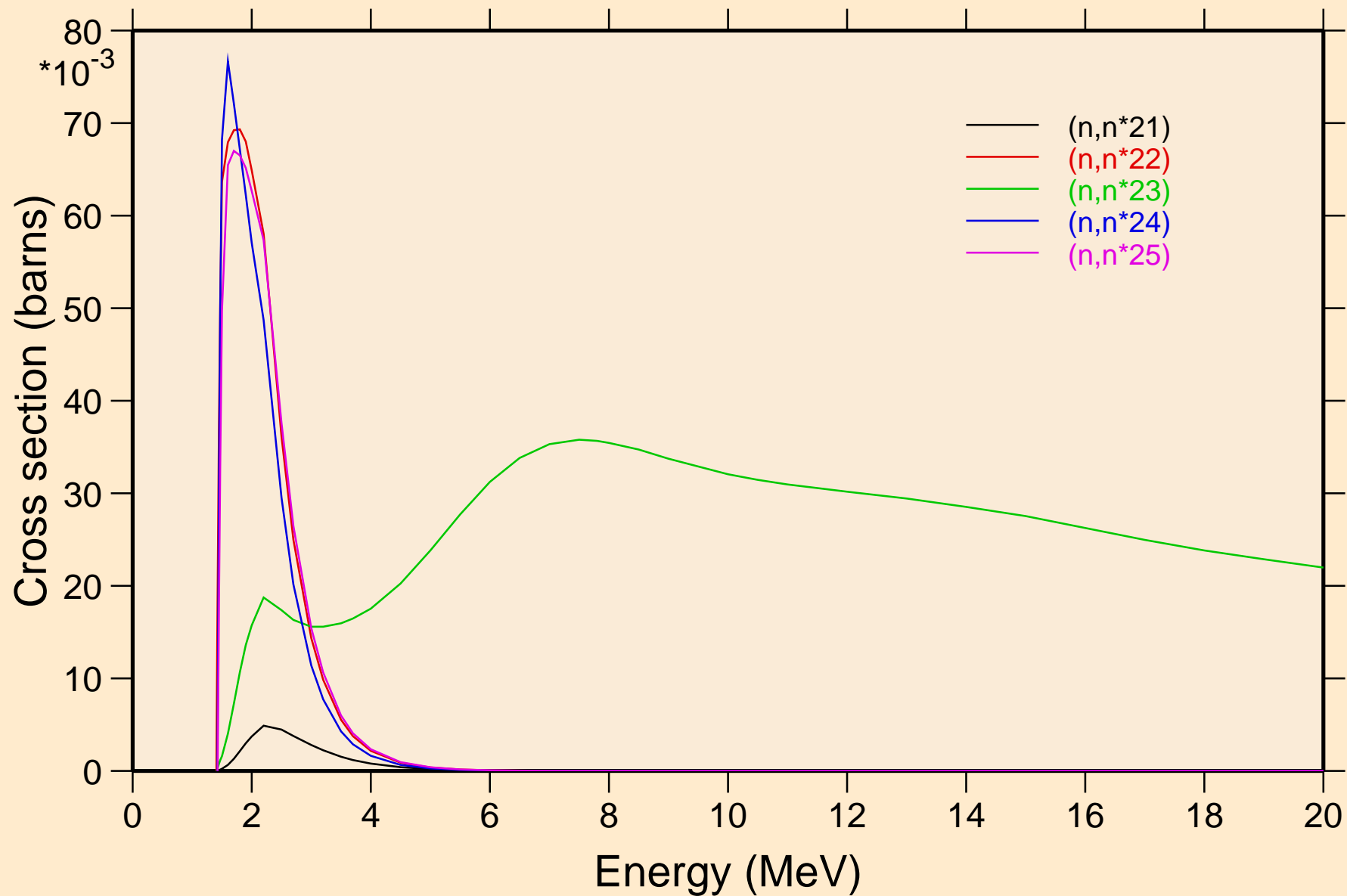

MAT=6431 ACE FILE PRODUCED AT NEA WITH NDEC
Inelastic levels

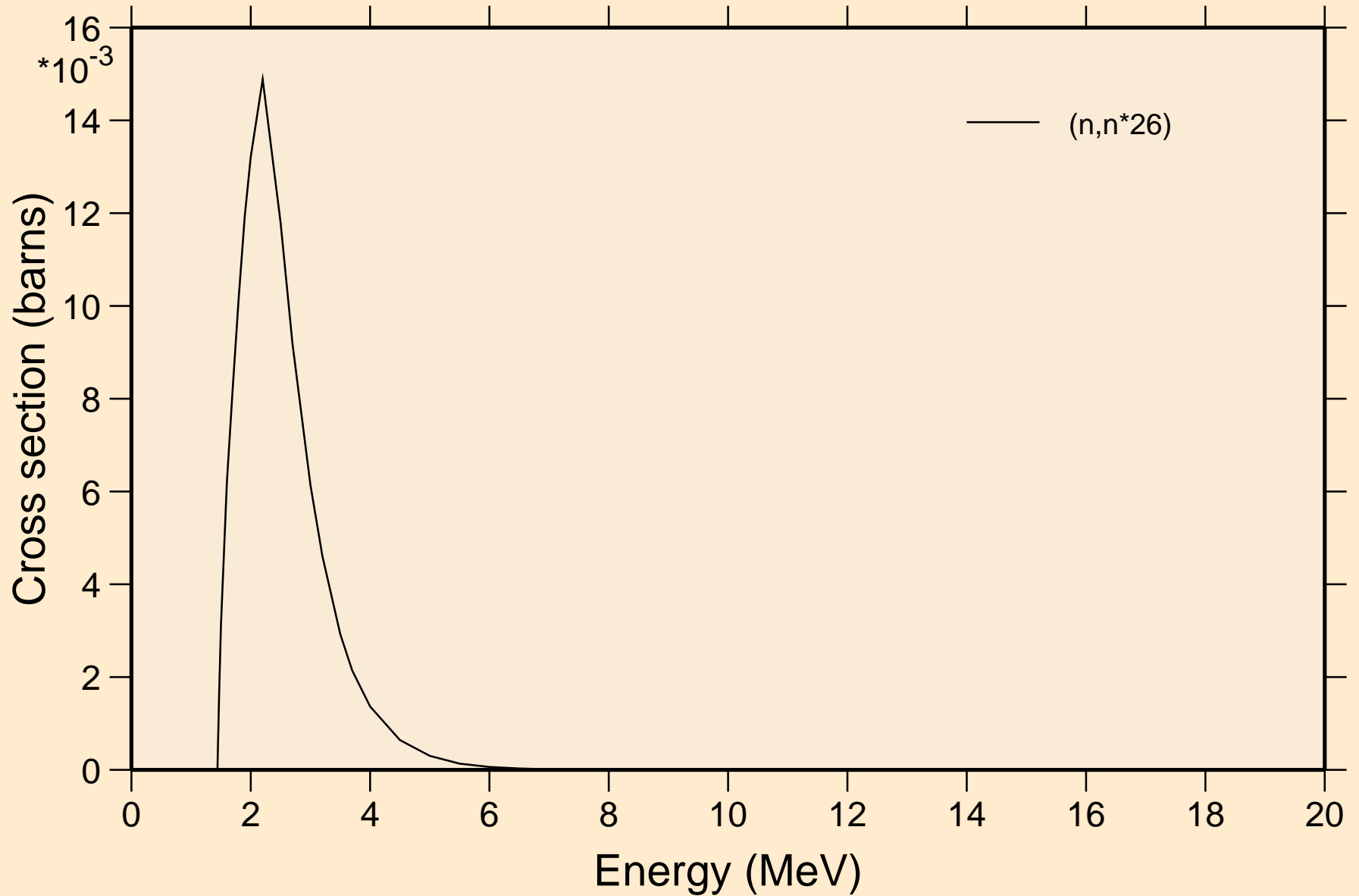

MAT=6431 ACE FILE PRODUCED AT NEA WITH NDEC
Threshold reactions

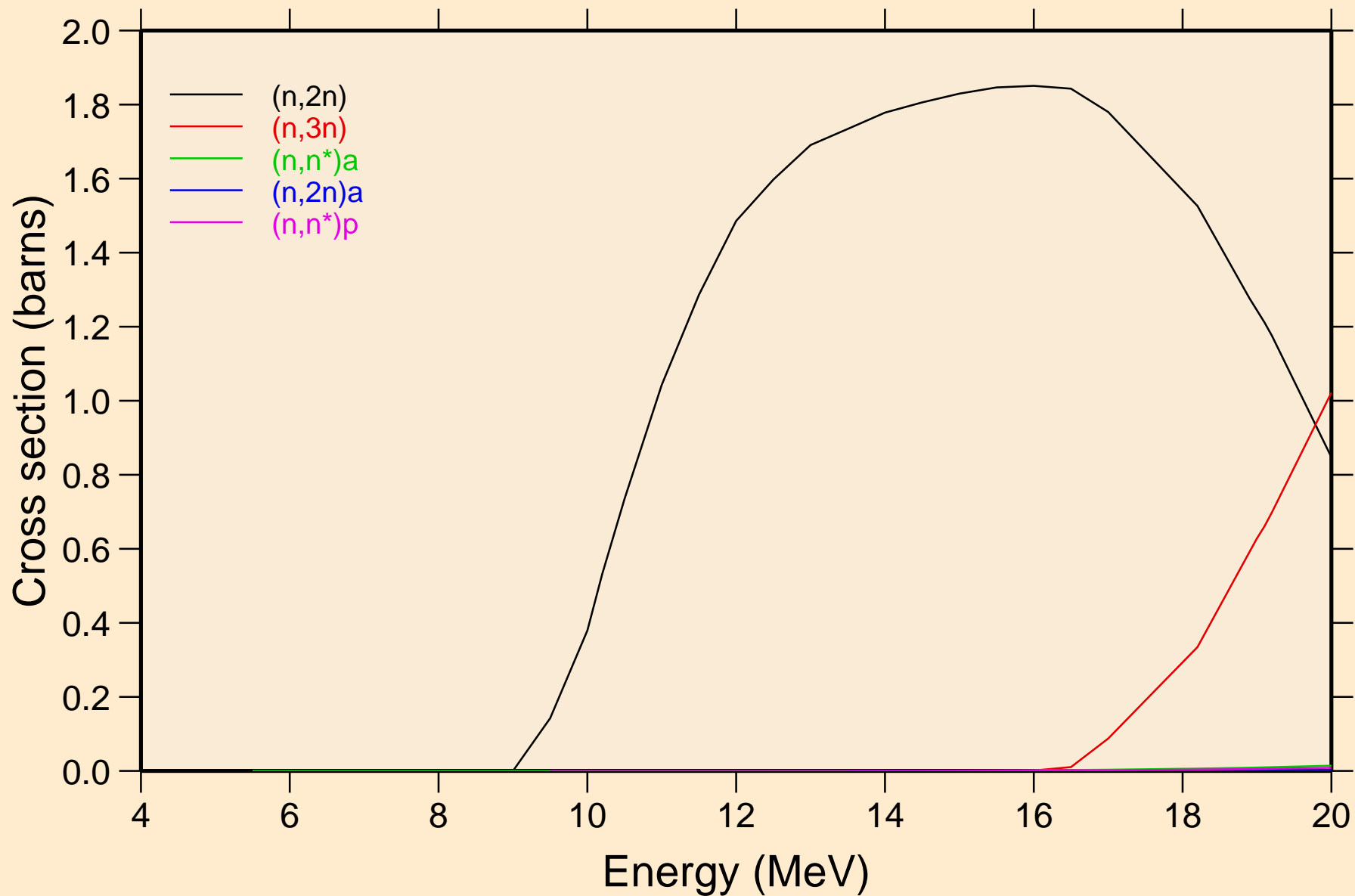

MAT=6431 ACE FILE PRODUCED AT NEA WITH NDEC
Threshold reactions

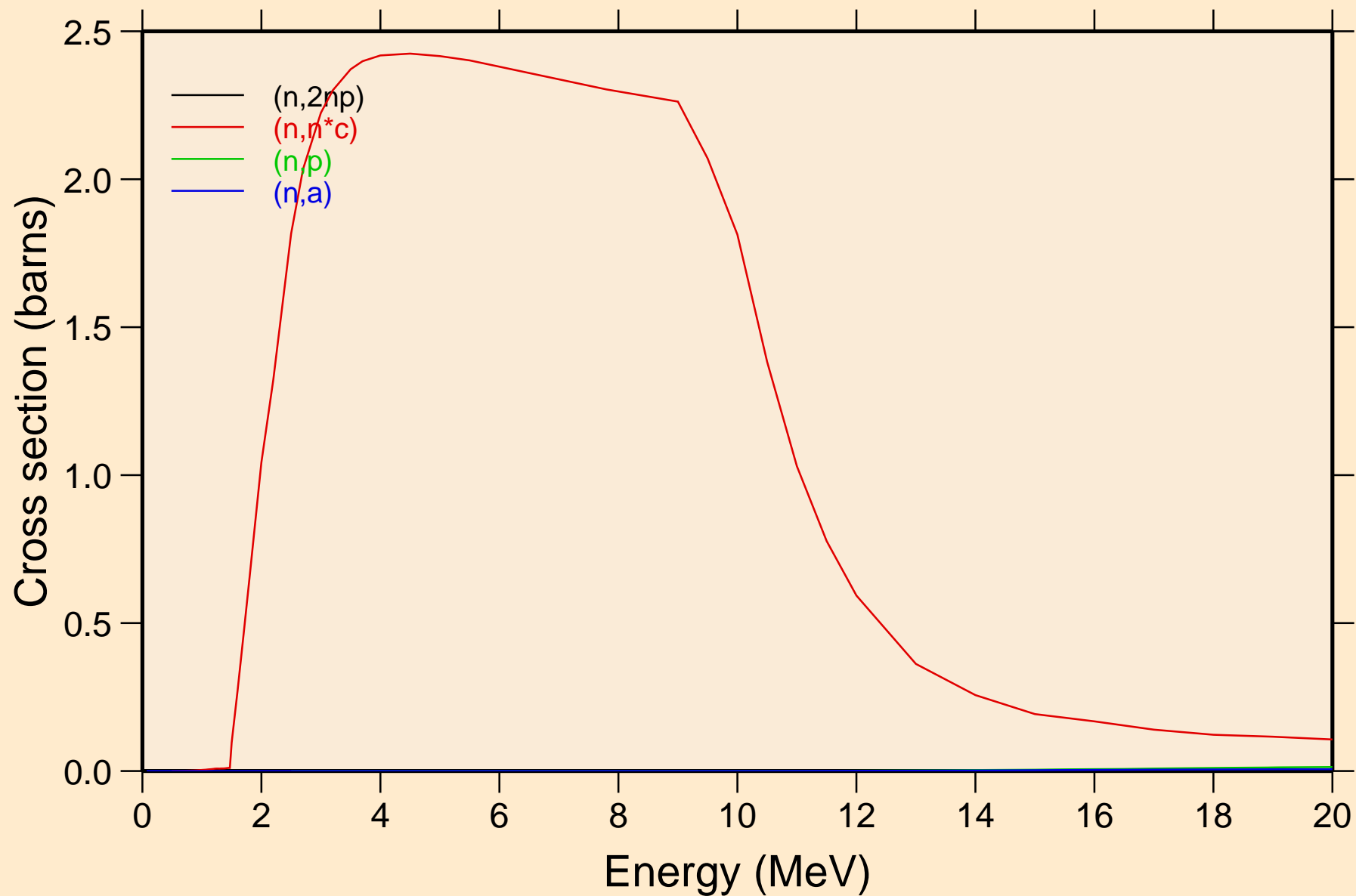

MAT=6431 ACE FILE PRODUCED AT NEA WITH NDEC
Threshold reactions

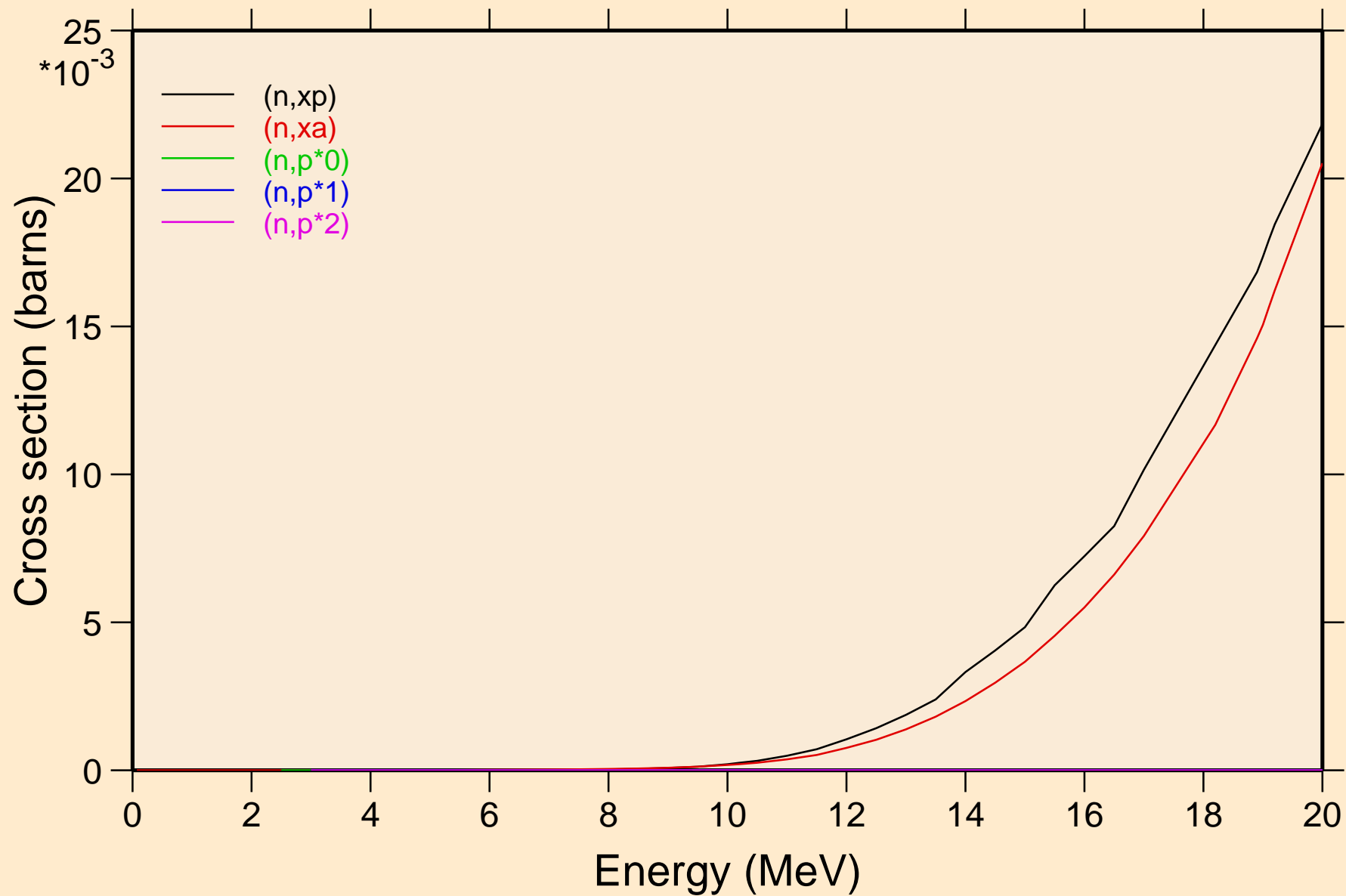

MAT=6431 ACE FILE PRODUCED AT NEA WITH NDEC
Threshold reactions

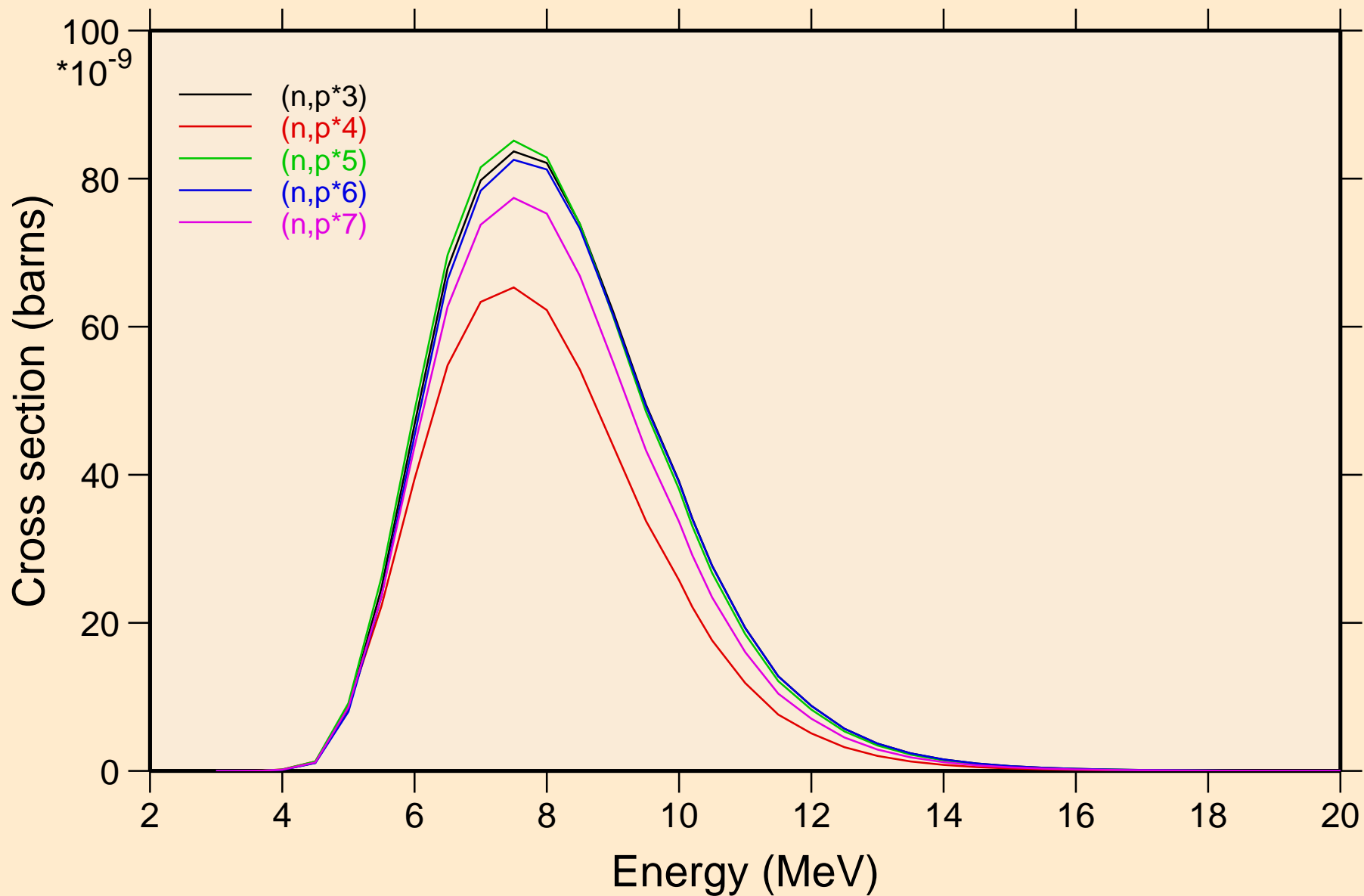

MAT=6431 ACE FILE PRODUCED AT NEA WITH NDEC
Threshold reactions

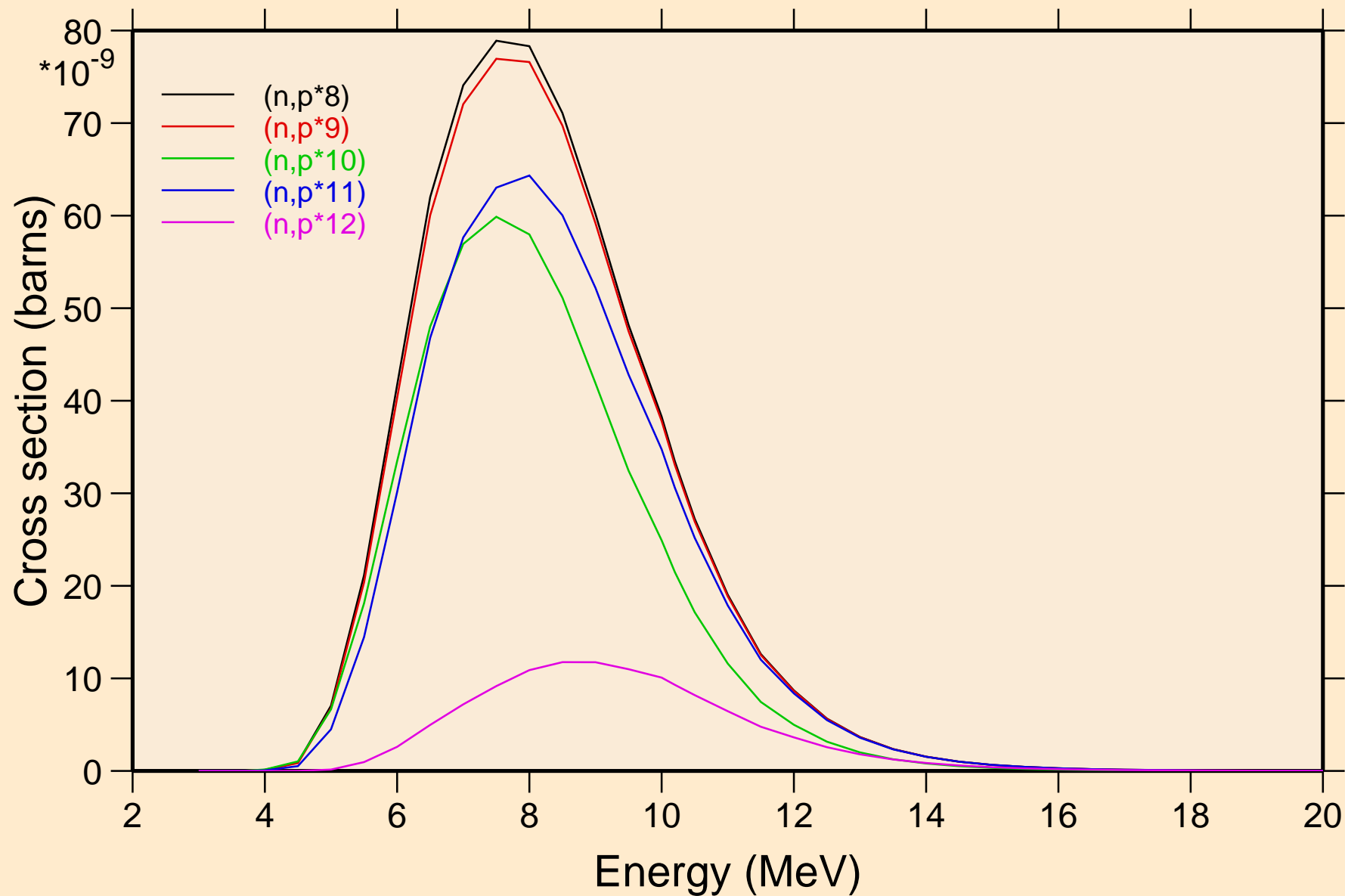

MAT=6431 ACE FILE PRODUCED AT NEA WITH NDEC
Threshold reactions

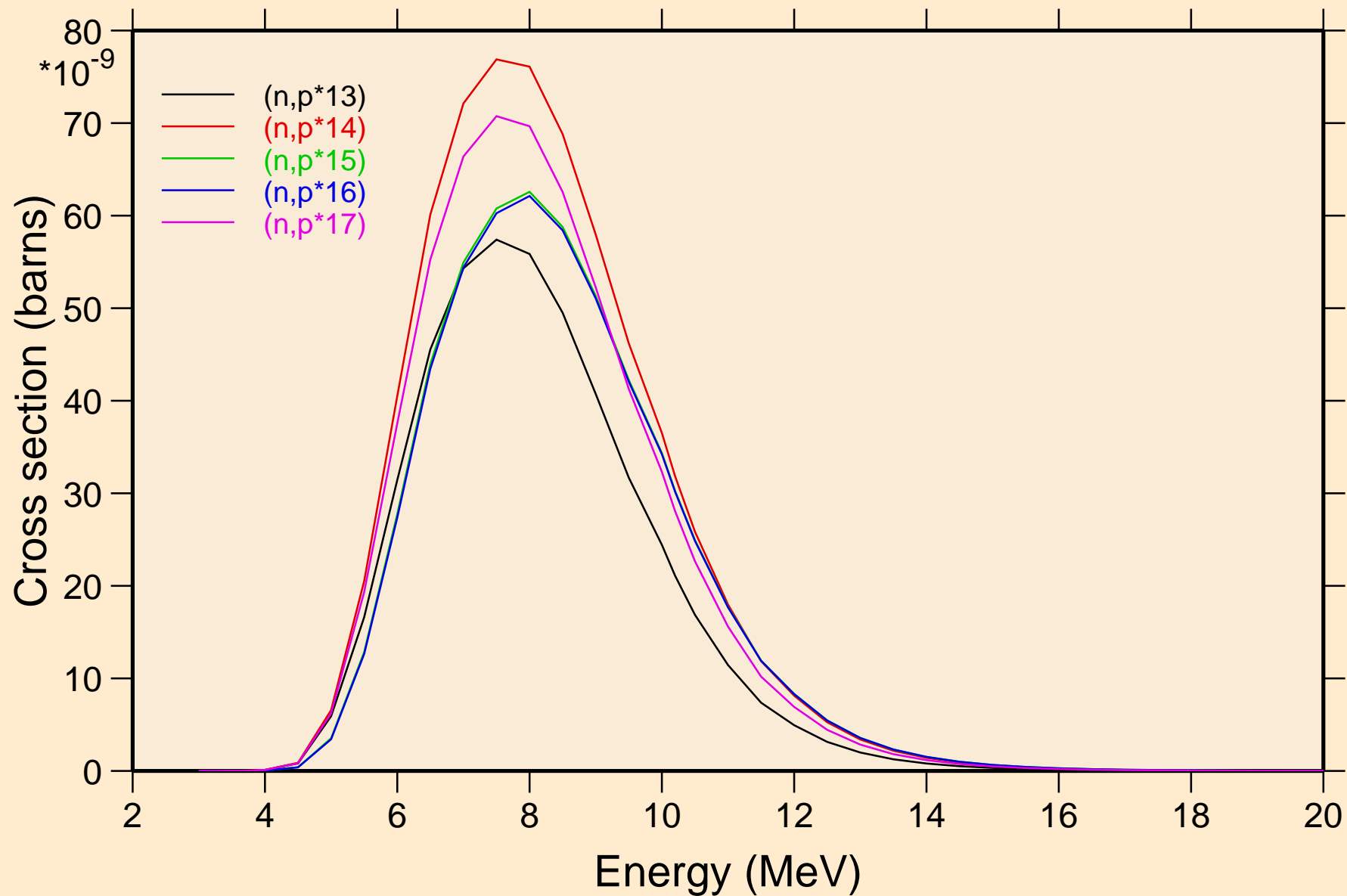

MAT=6431 ACE FILE PRODUCED AT NEA WITH NDEC
Threshold reactions

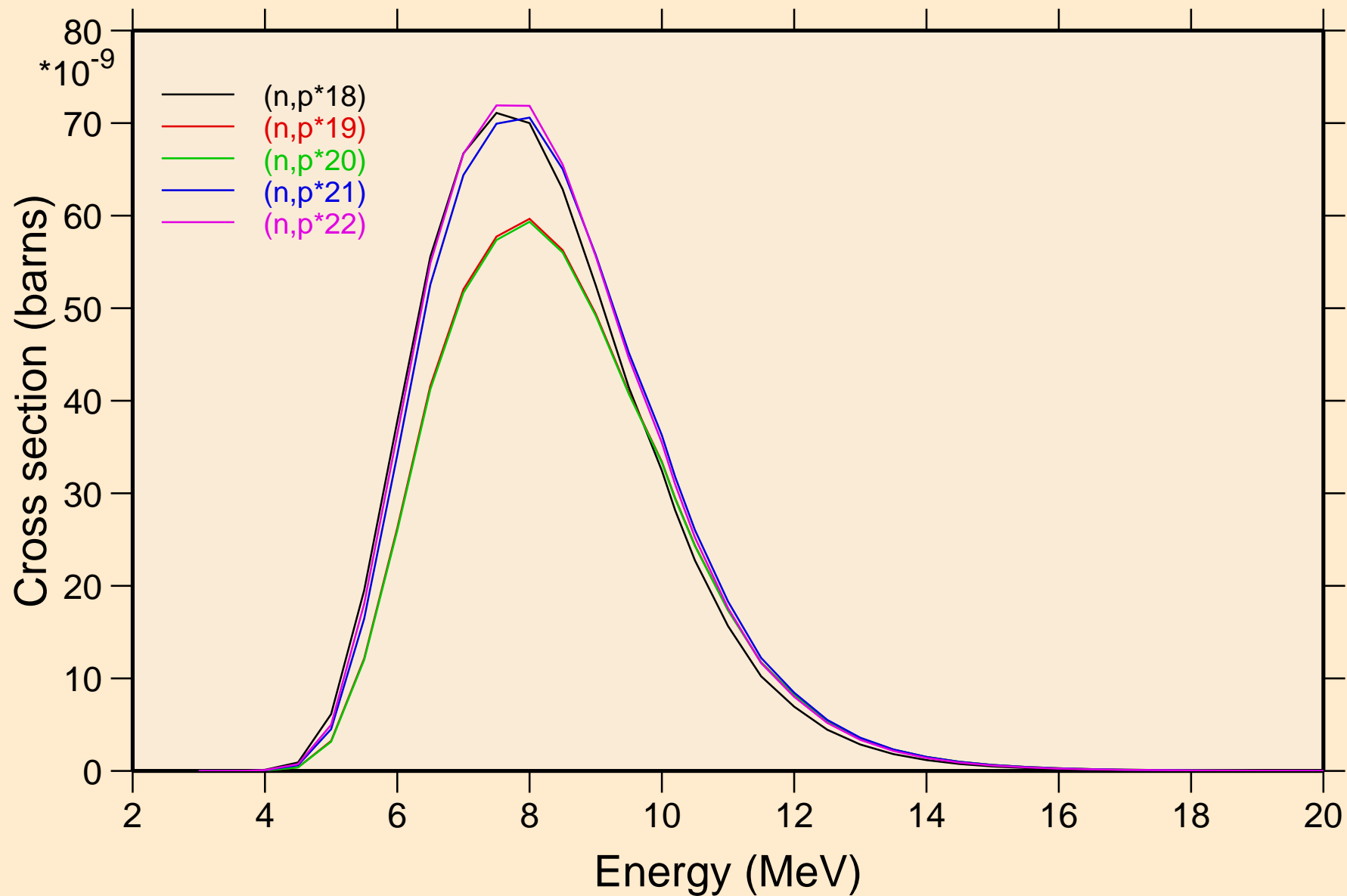

MAT=6431 ACE FILE PRODUCED AT NEA WITH NDEC
Threshold reactions

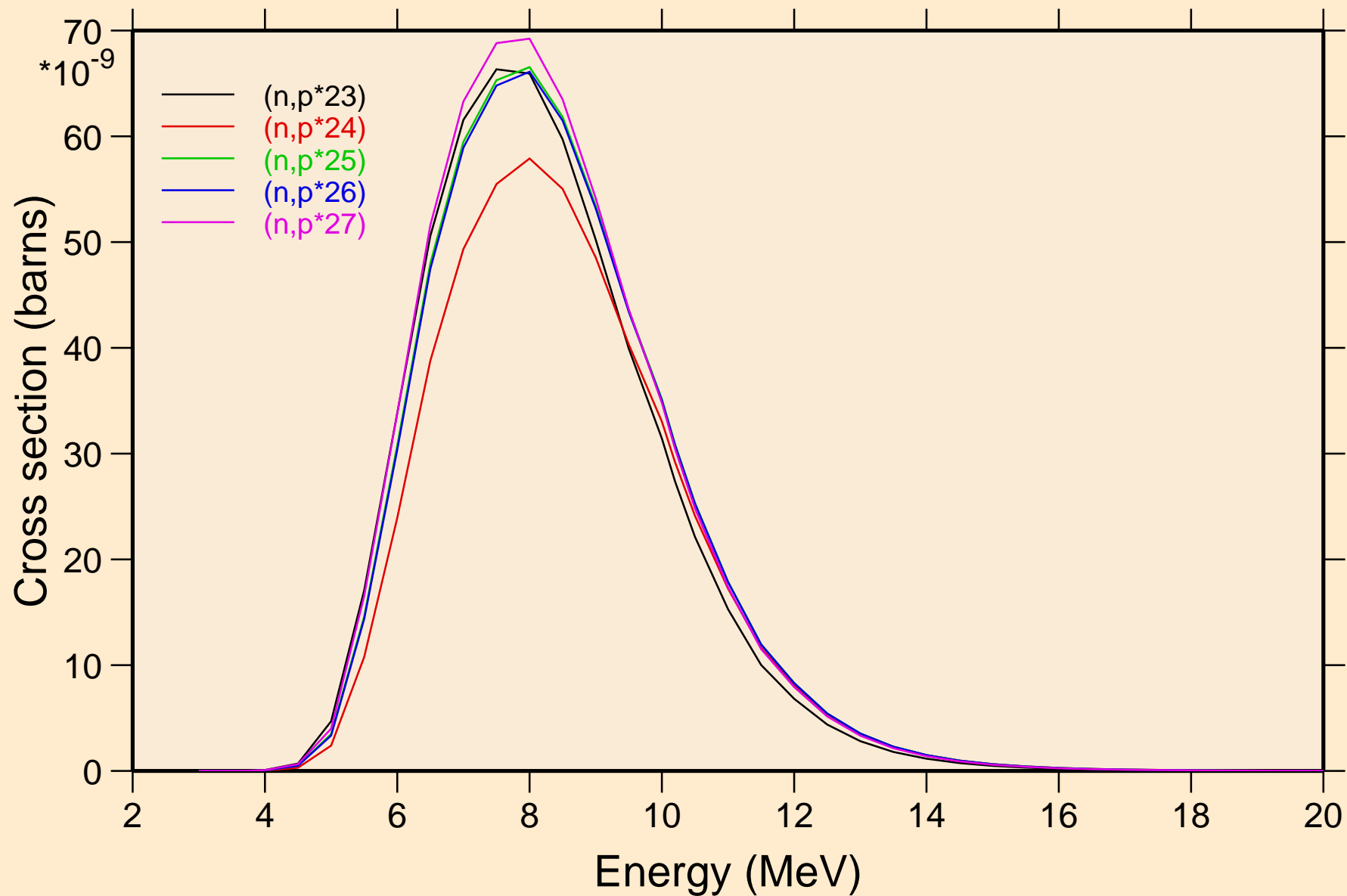

MAT=6431 ACE FILE PRODUCED AT NEA WITH NDEC
Threshold reactions

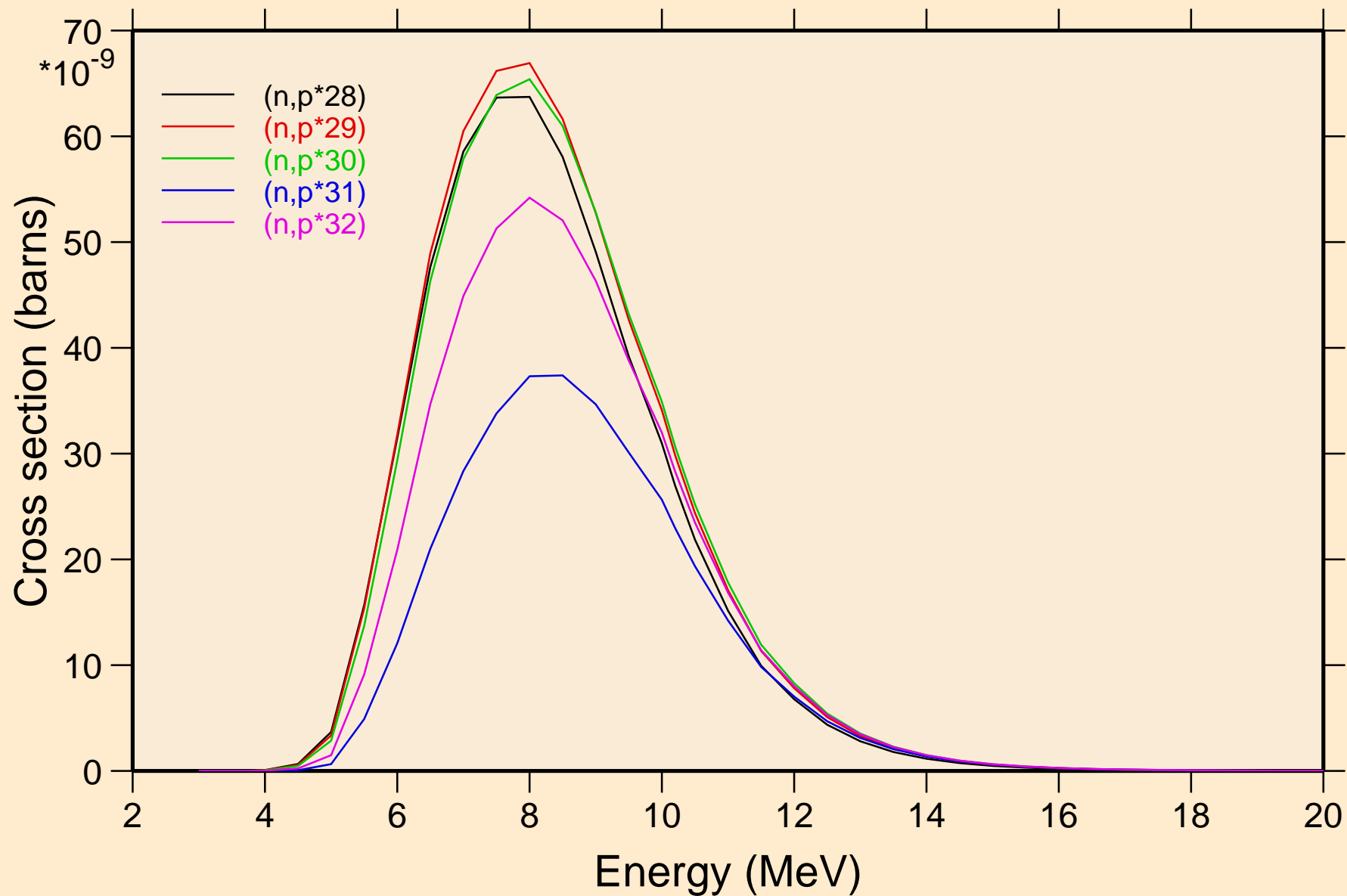

MAT=6431 ACE FILE PRODUCED AT NEA WITH NDEC
Threshold reactions

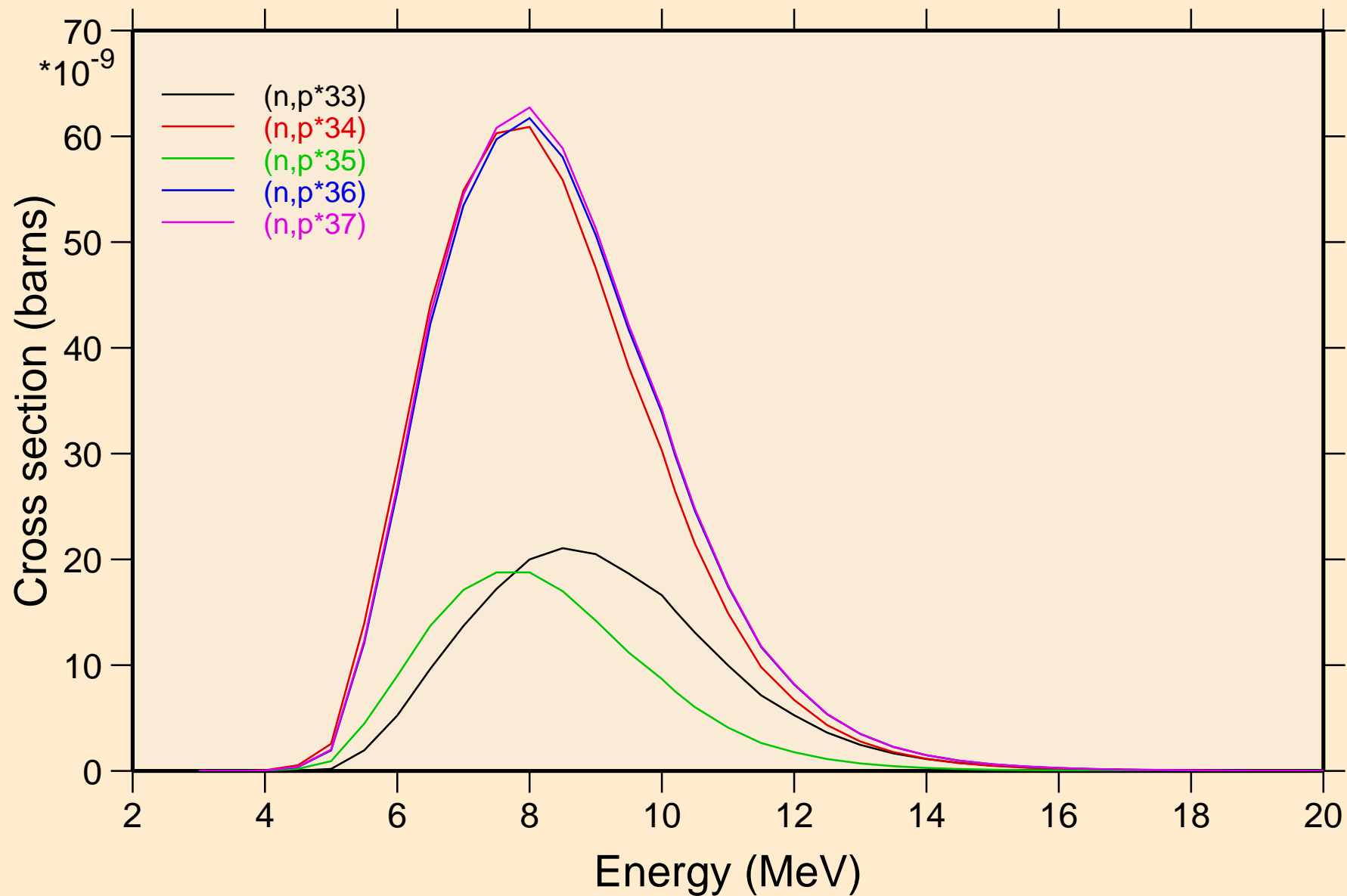

MAT=6431 ACE FILE PRODUCED AT NEA WITH NDEC
Threshold reactions

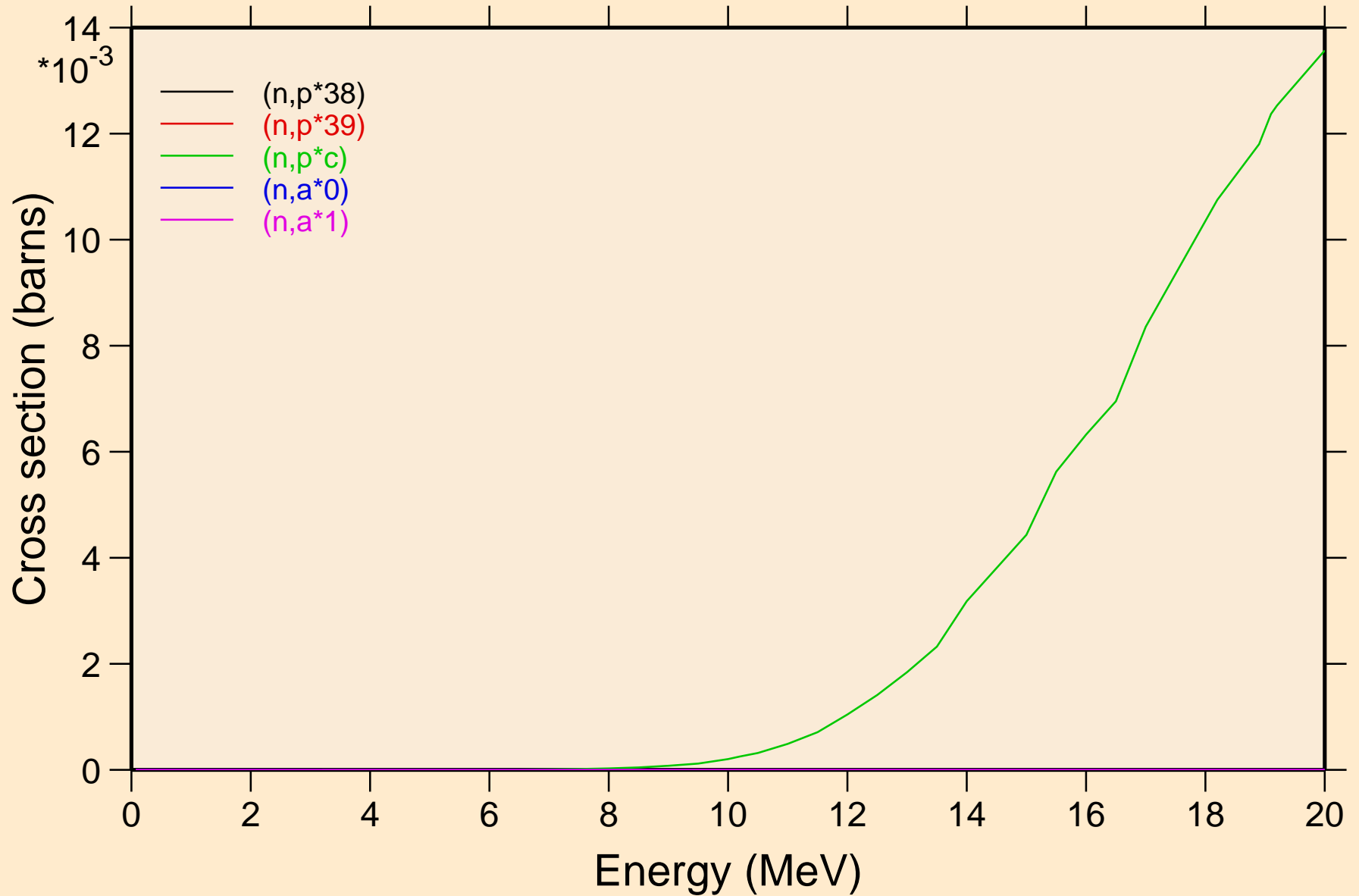

MAT=6431 ACE FILE PRODUCED AT NEA WITH NDEC
Threshold reactions

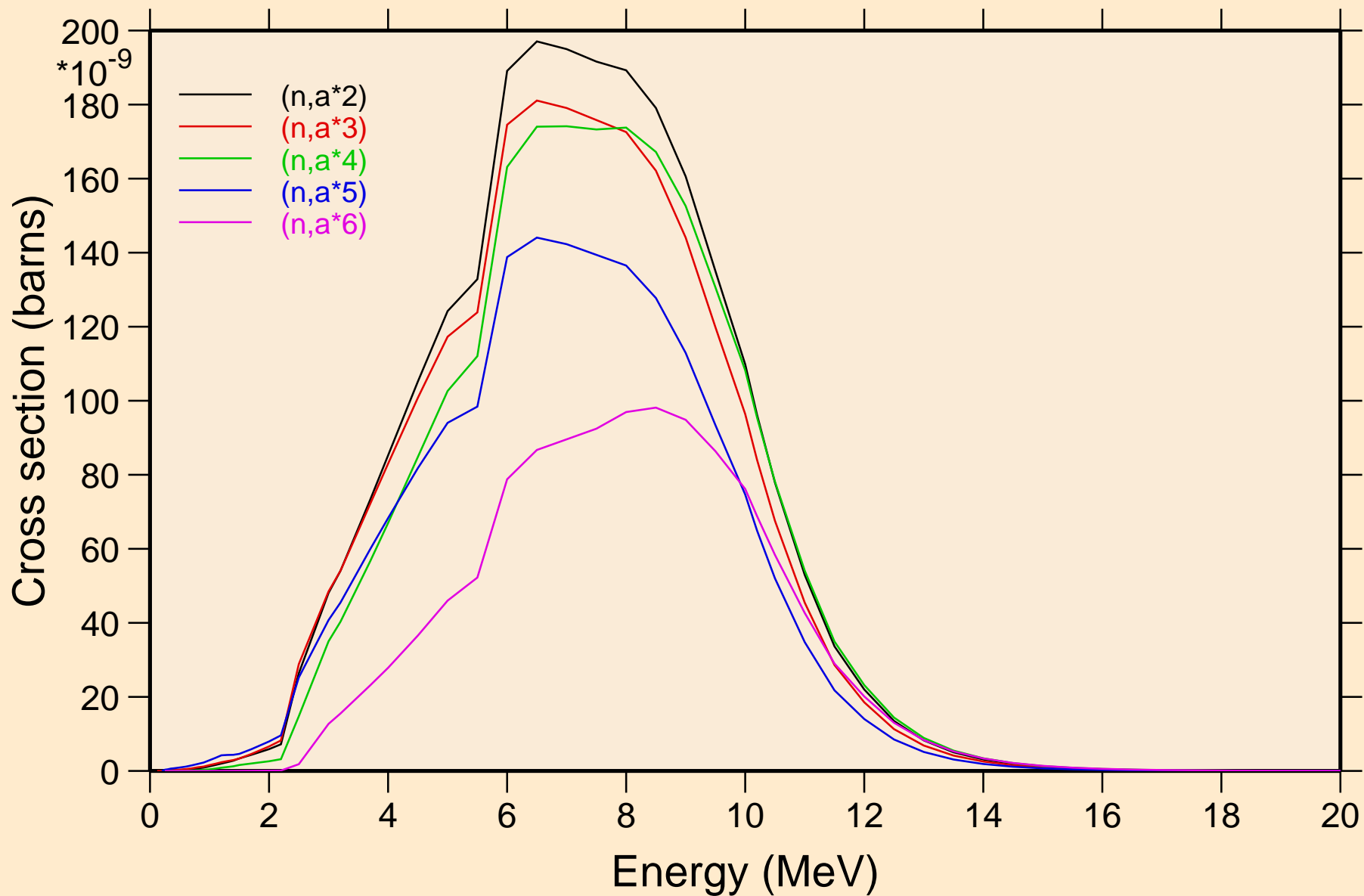

MAT=6431 ACE FILE PRODUCED AT NEA WITH NDEC
Threshold reactions

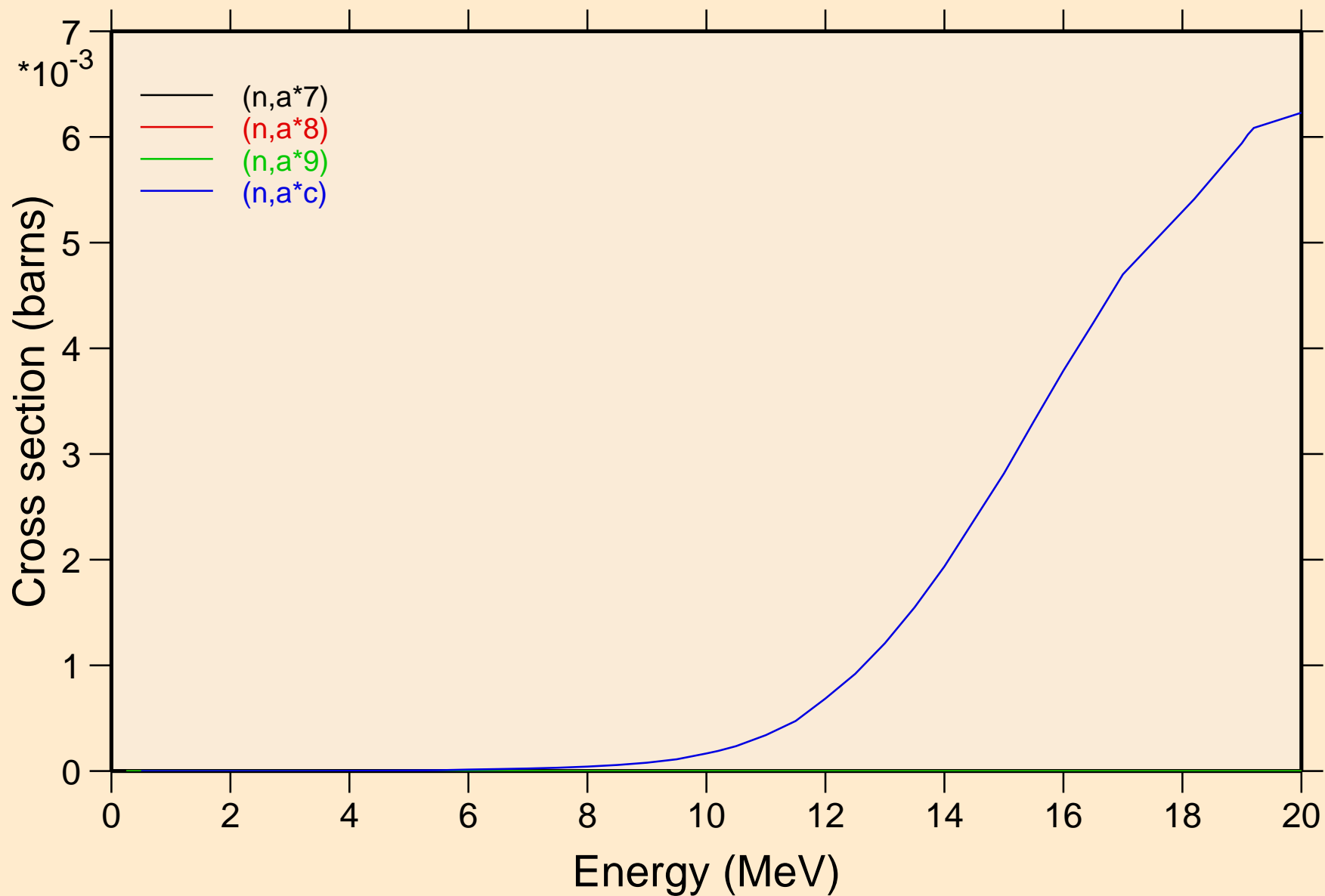

MAT=6431 ACE FILE PRODUCED AT NEA WITH NDEC
angular distribution for elastic

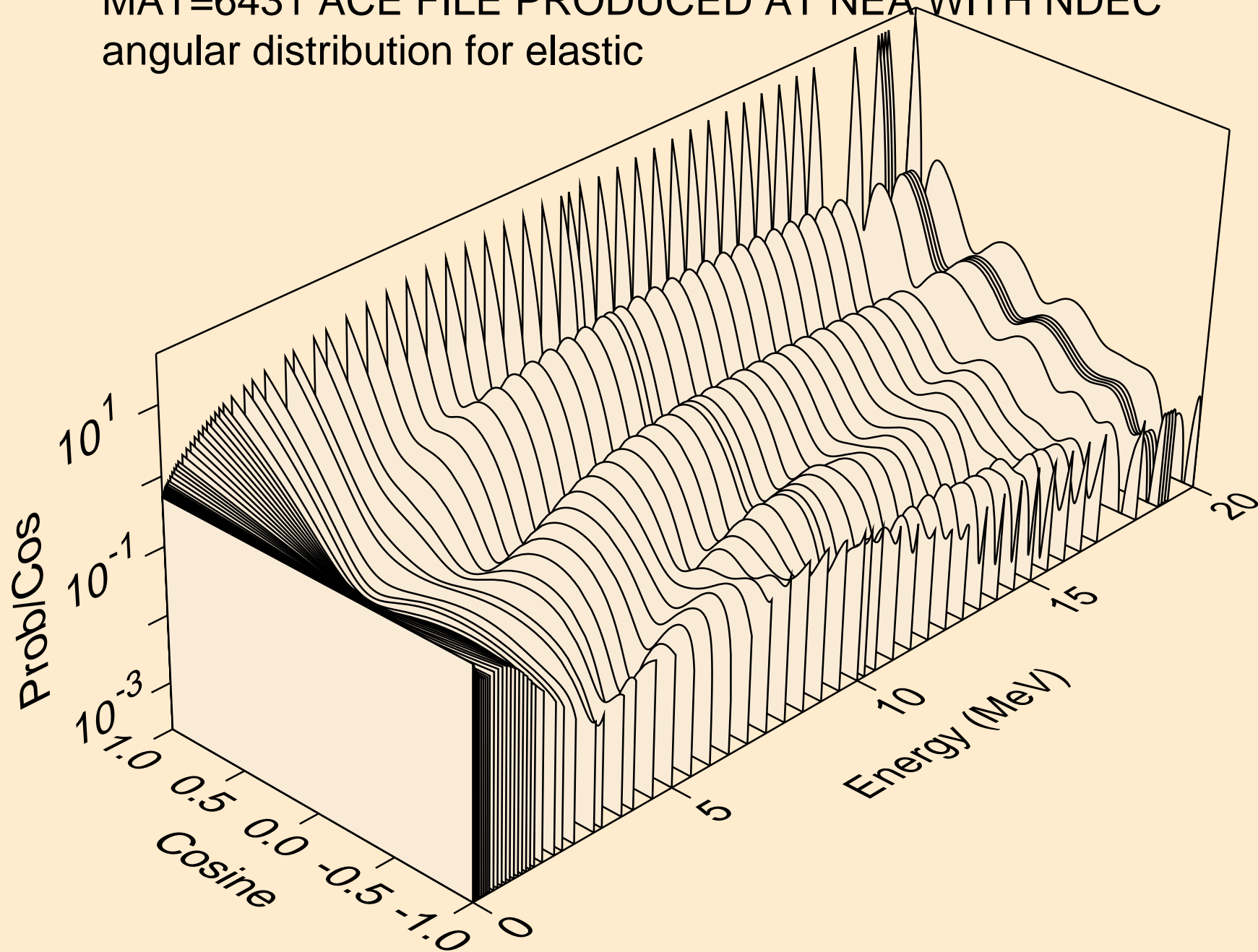

MAT=6431 ACE FILE PRODUCED AT NEA WITH NDEC
angular distribution for (n,n*1)

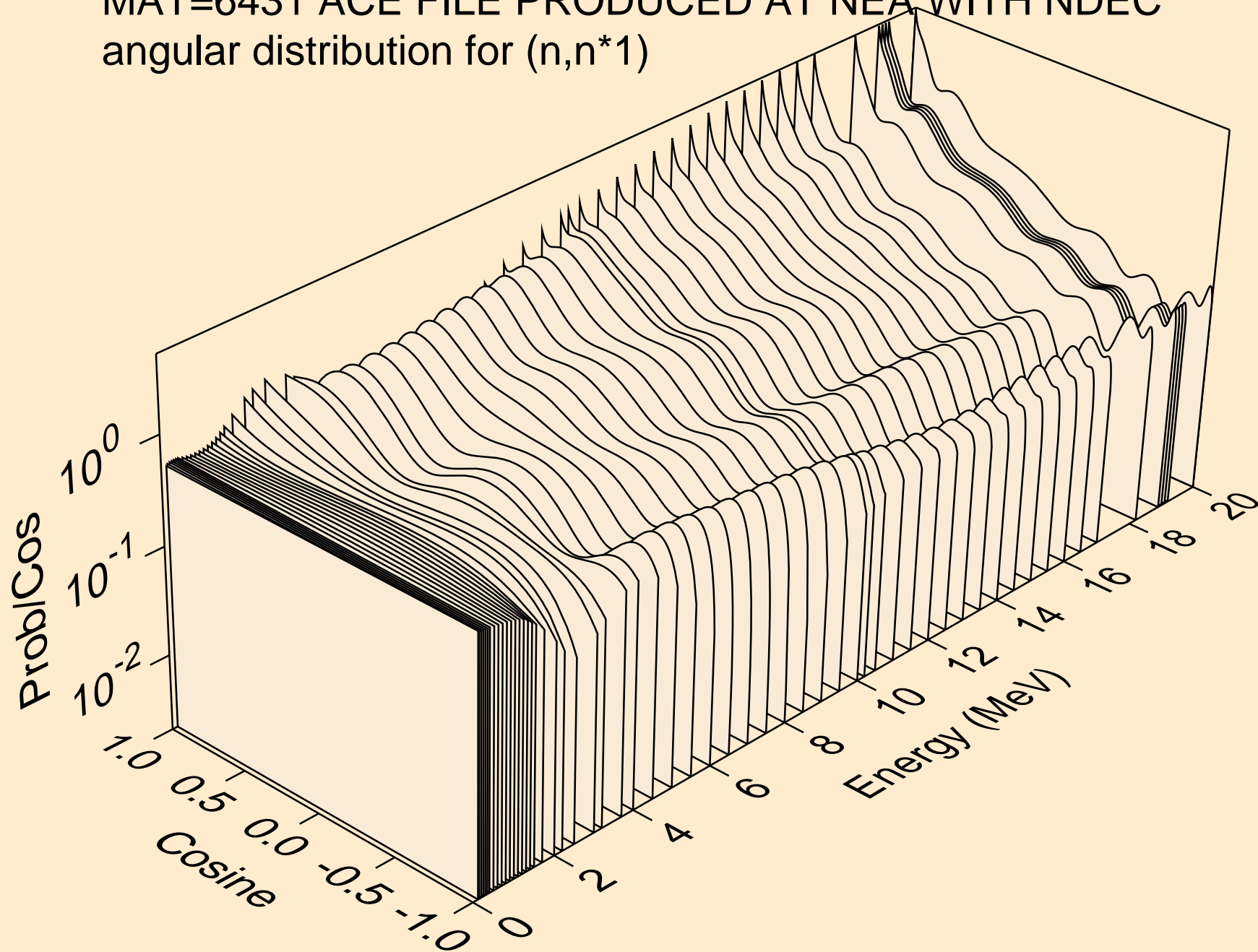

MAT=6431 ACE FILE PRODUCED AT NEA WITH NDEC
angular distribution for (n,n*2)

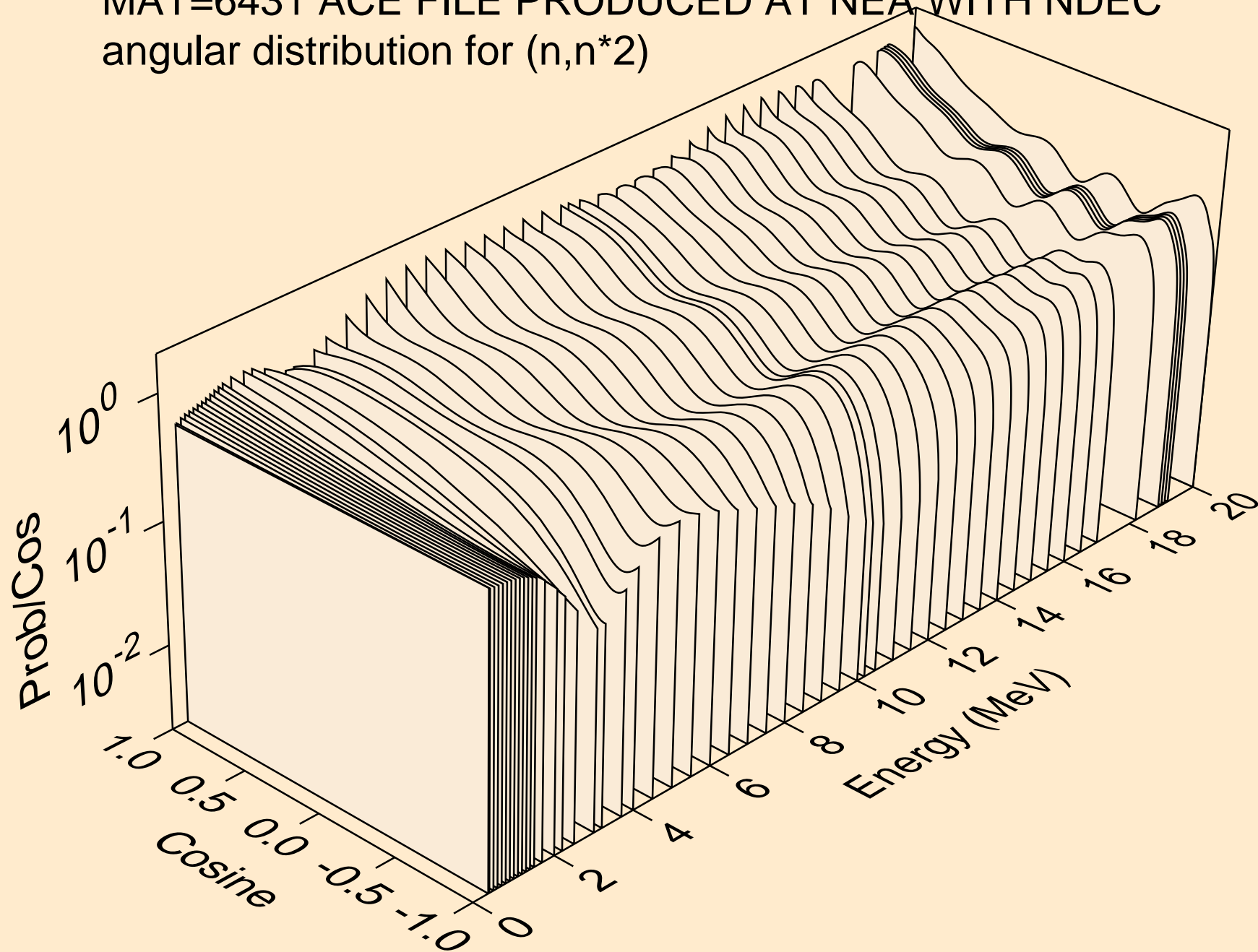

MAT=6431 ACE FILE PRODUCED AT NEA WITH NDEC
angular distribution for (n,n*3)

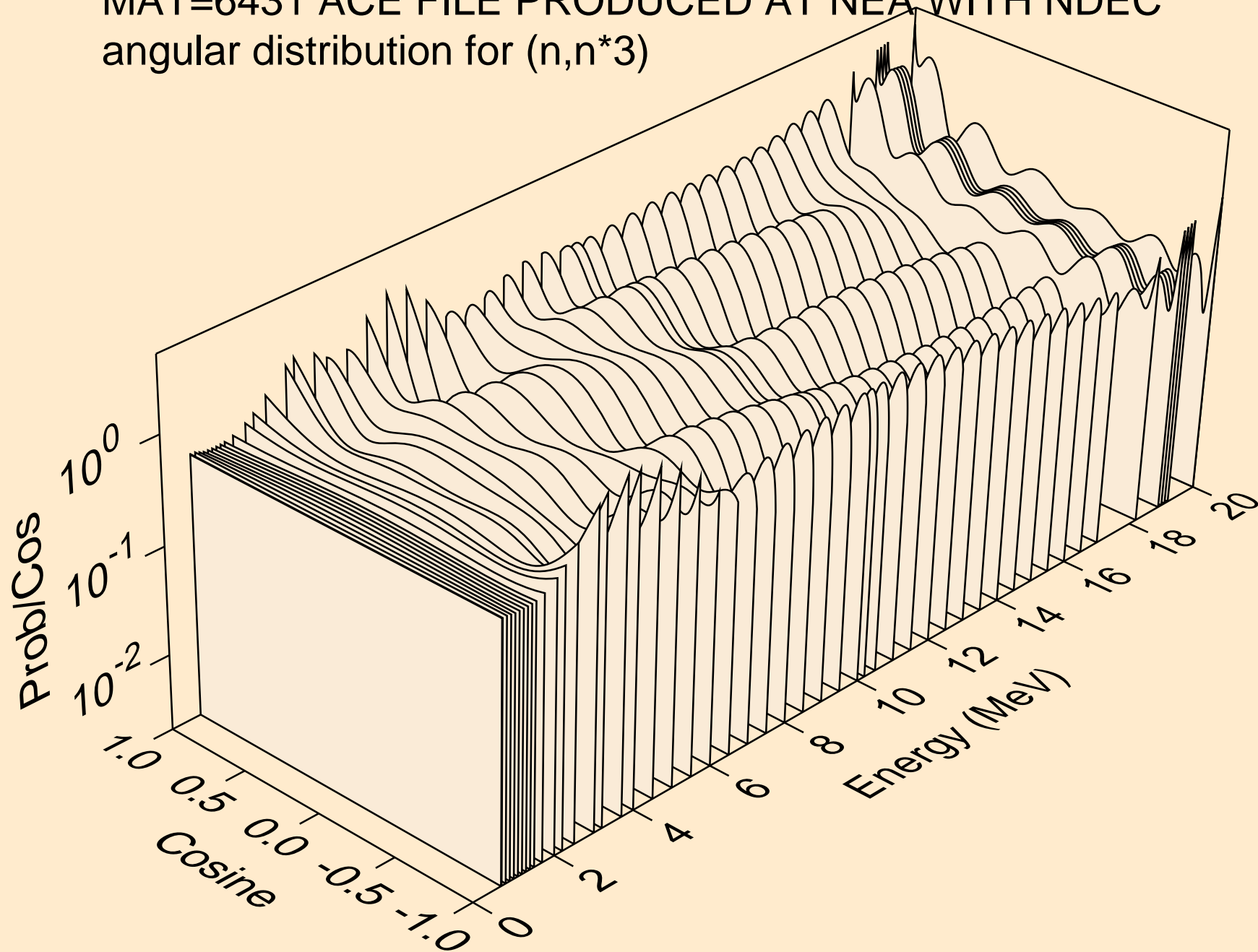

MAT=6431 ACE FILE PRODUCED AT NEA WITH NDEC
angular distribution for (n,n*4)

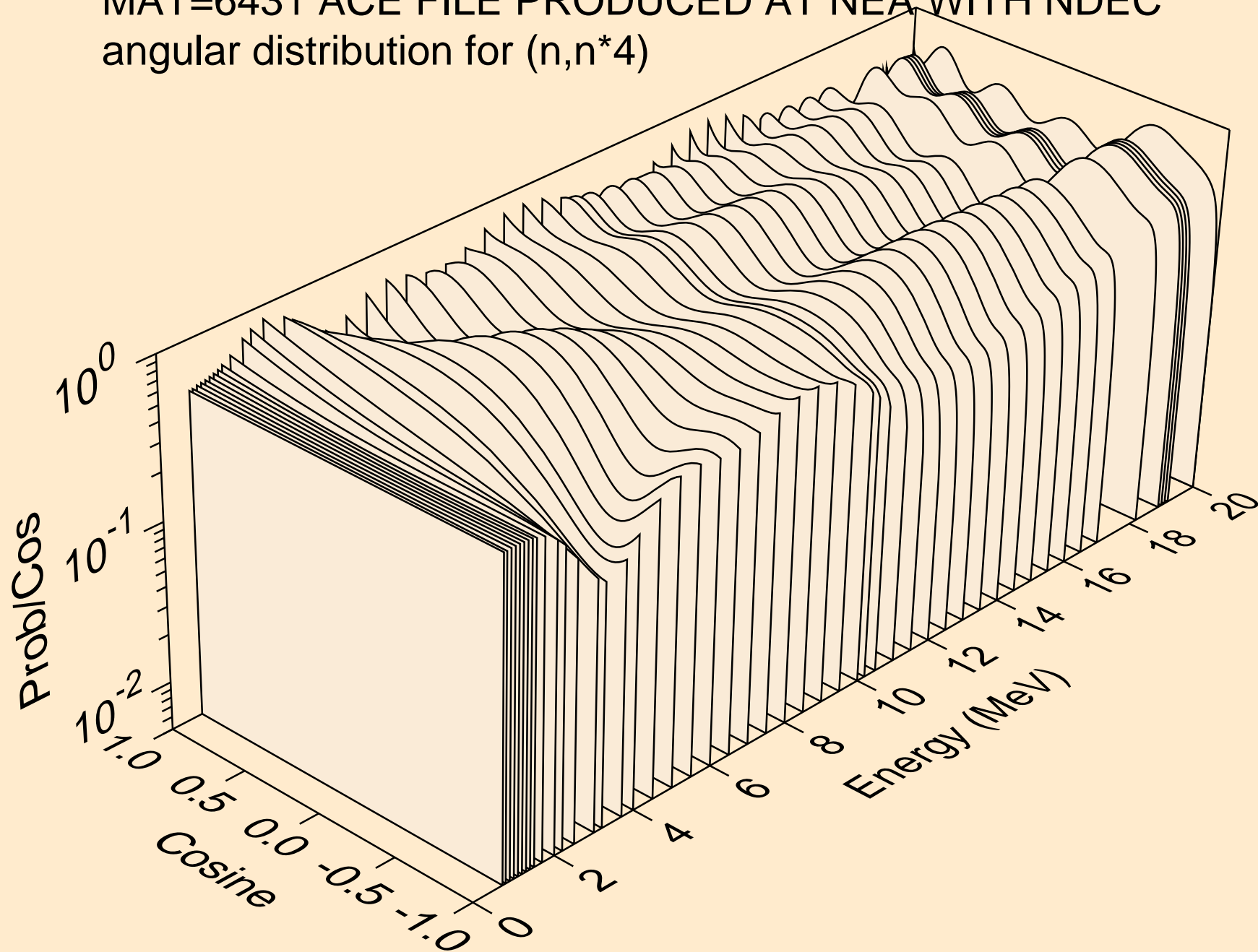

MAT=6431 ACE FILE PRODUCED AT NEA WITH NDEC
angular distribution for (n,n*5)

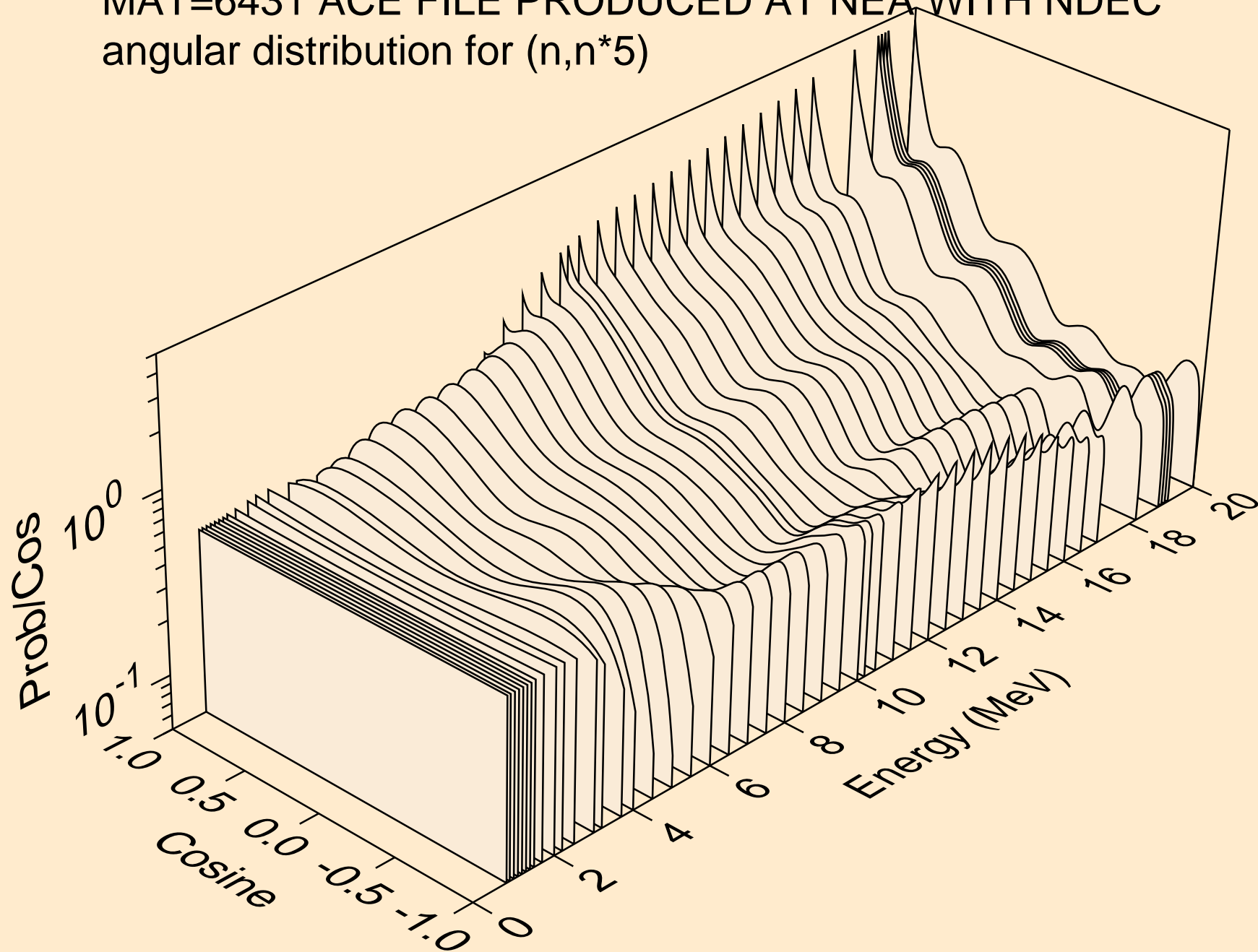

MAT=6431 ACE FILE PRODUCED AT NEA WITH NDEC
angular distribution for (n,n*6)

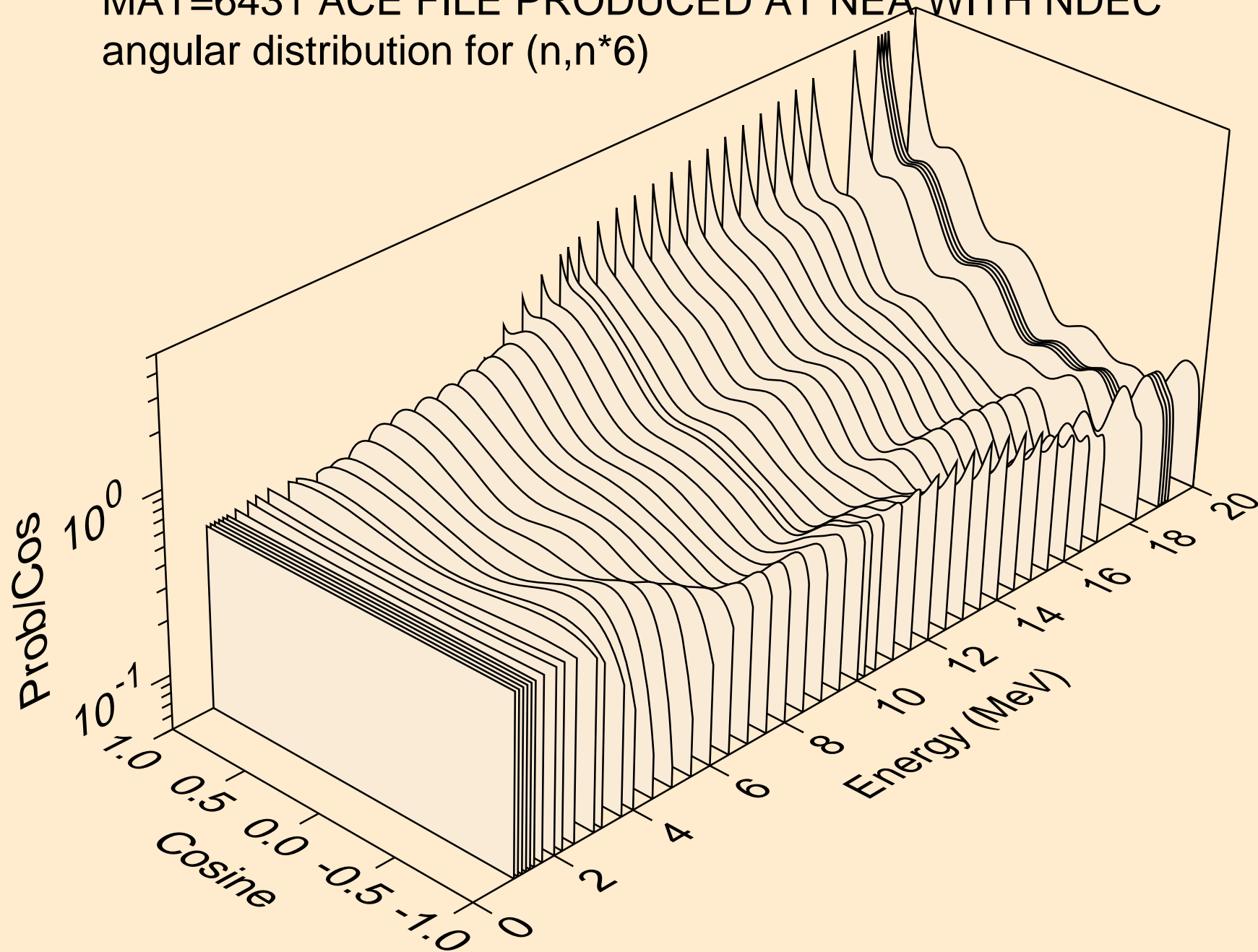

MAT=6431 ACE FILE PRODUCED AT NEA WITH NDEC
angular distribution for (n,n*7)

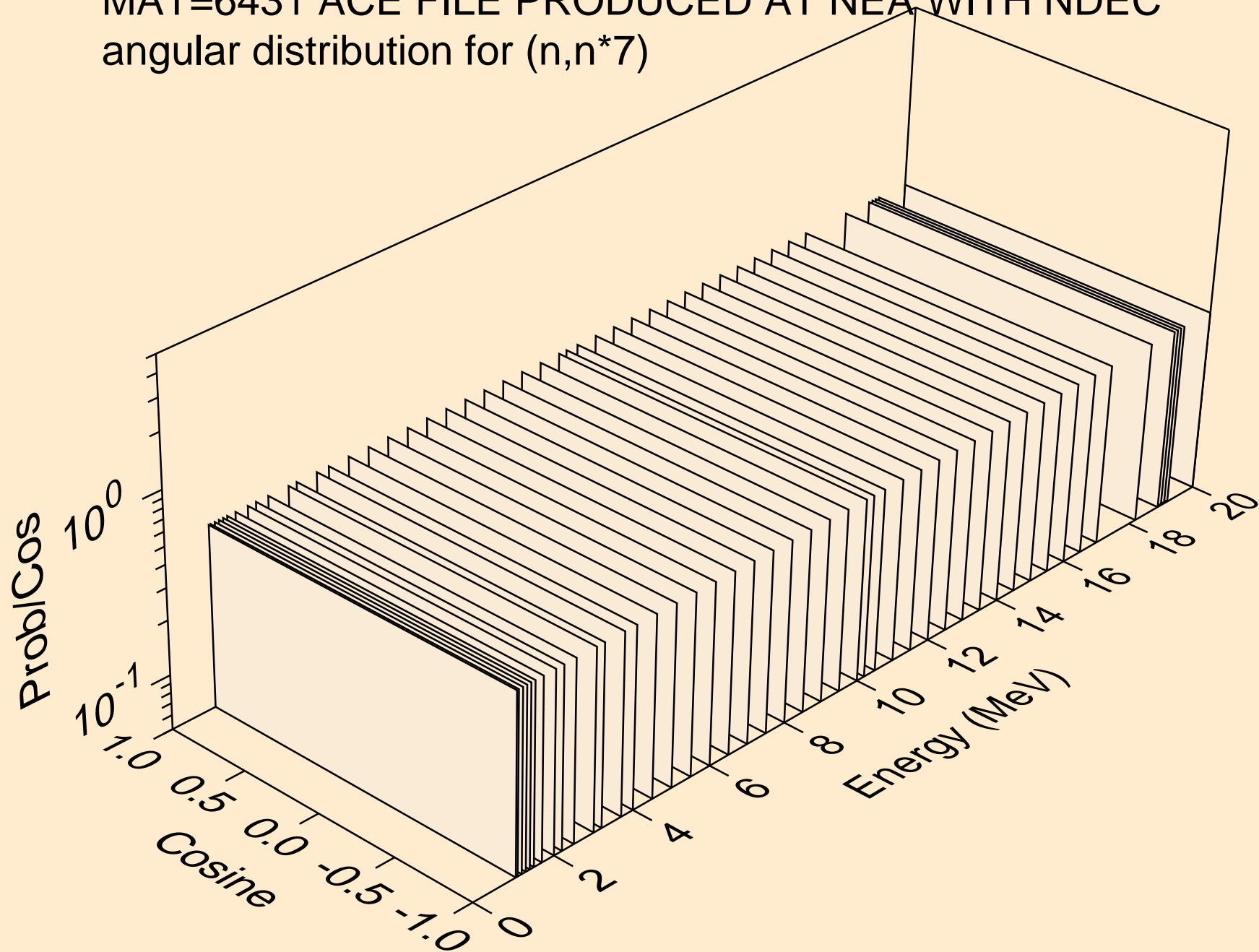

MAT=6431 ACE FILE PRODUCED AT NEA WITH NDEC
angular distribution for (n,n*8)

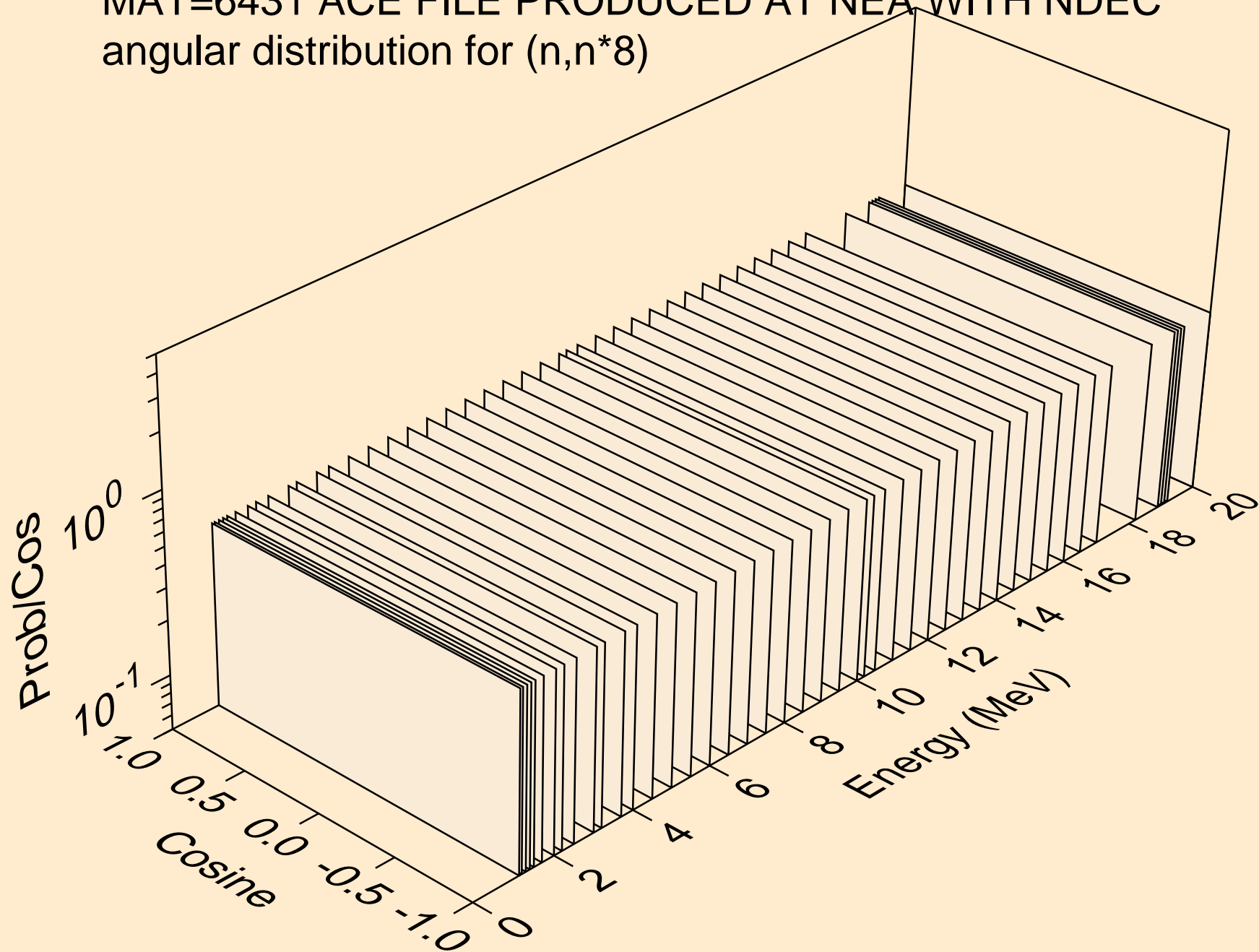

MAT=6431 ACE FILE PRODUCED AT NEA WITH NDEC
angular distribution for (n,n*9)

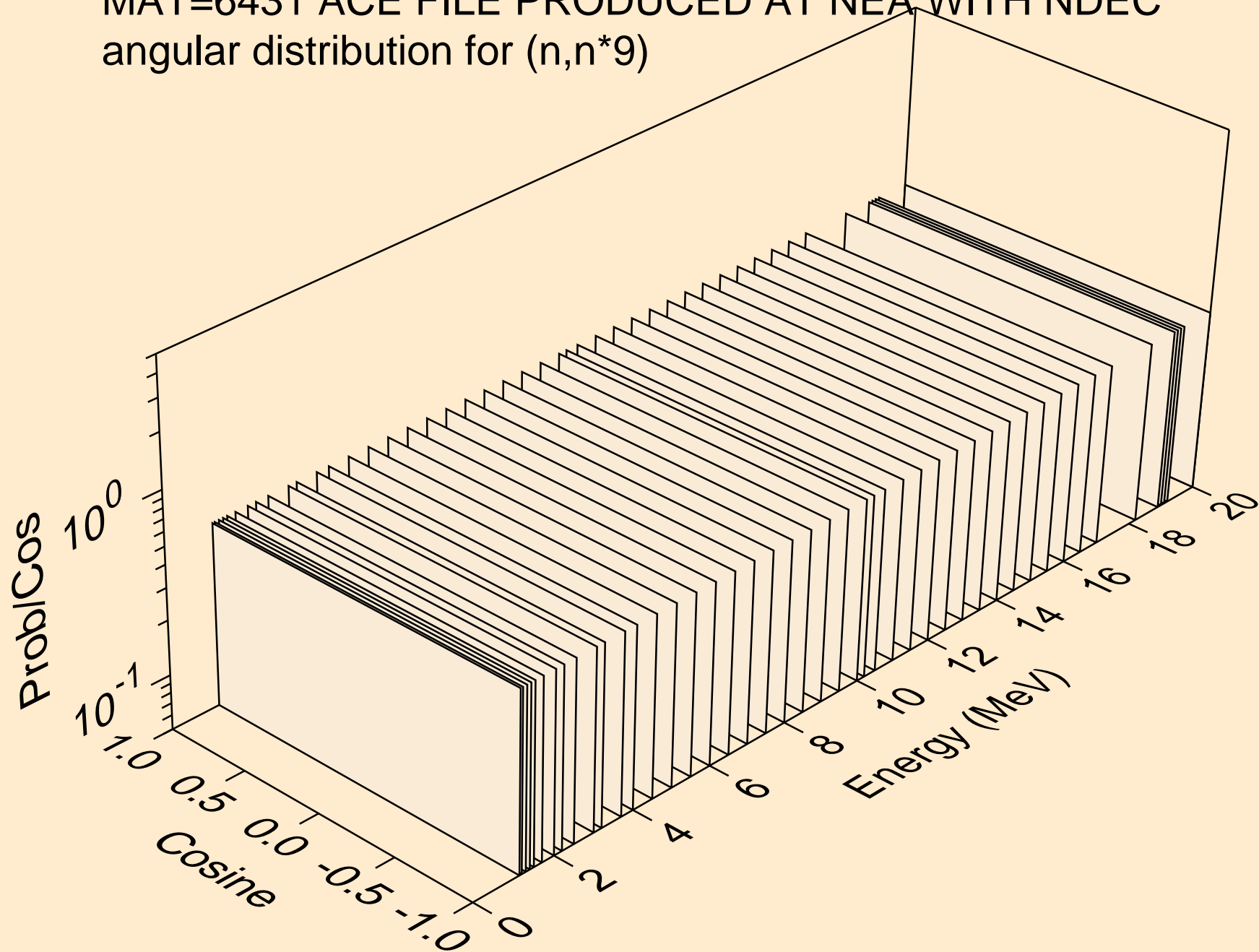

MAT=6431 ACE FILE PRODUCED AT NEA WITH NDEC
angular distribution for (n,n*10)

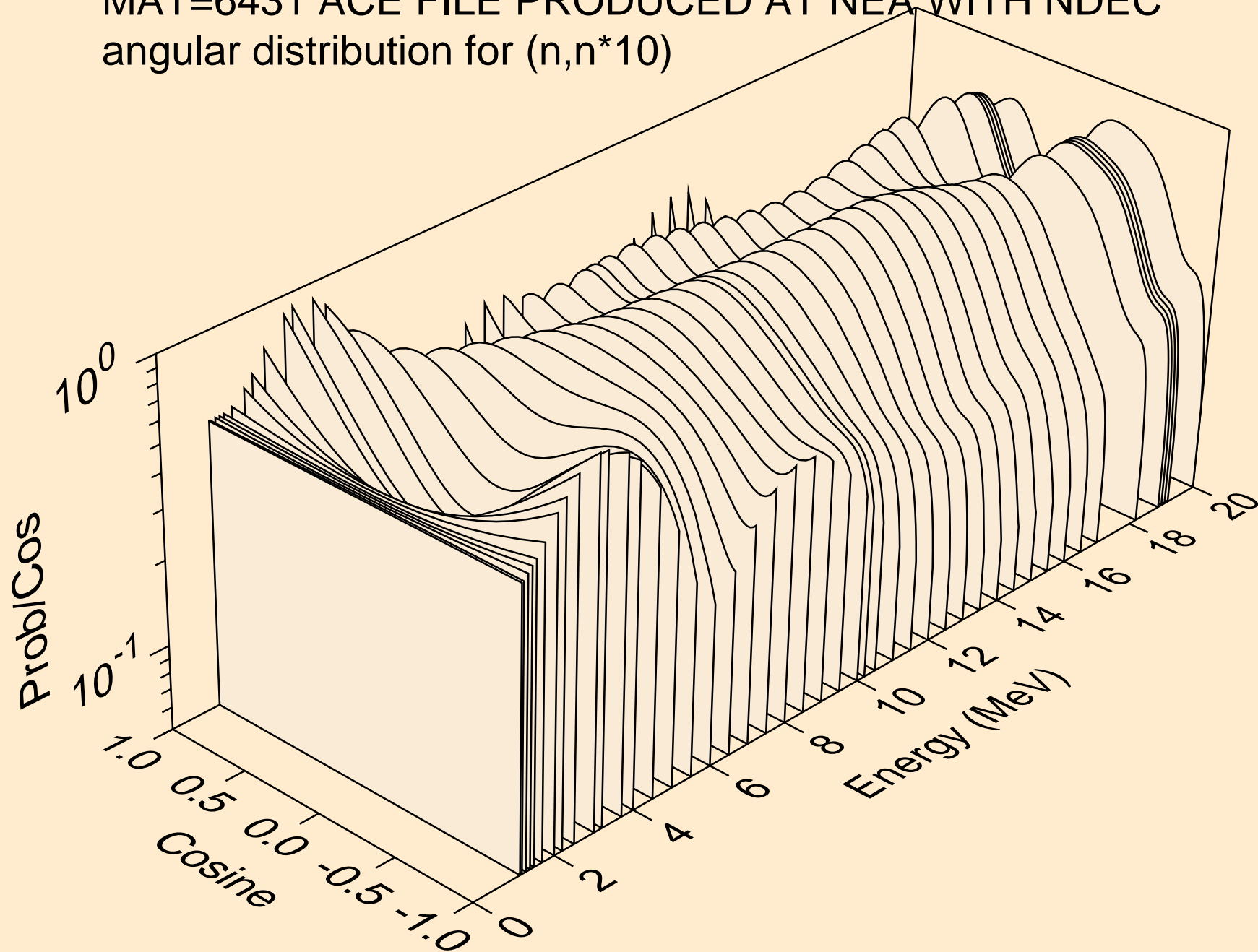

MAT=6431 ACE FILE PRODUCED AT NEA WITH NDEC
angular distribution for (n,n*11)

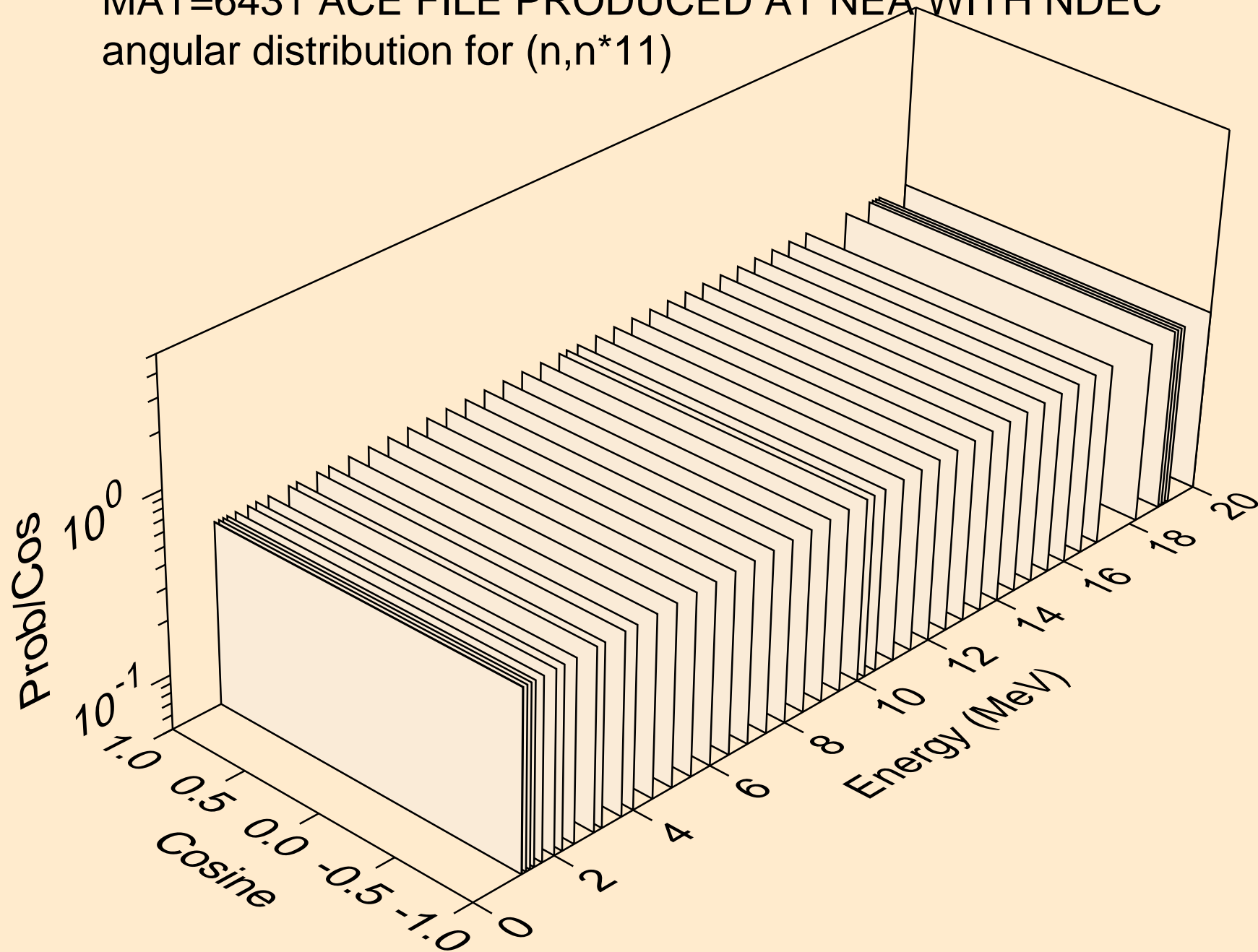

MAT=6431 ACE FILE PRODUCED AT NEA WITH NDEC
angular distribution for (n,n*12)

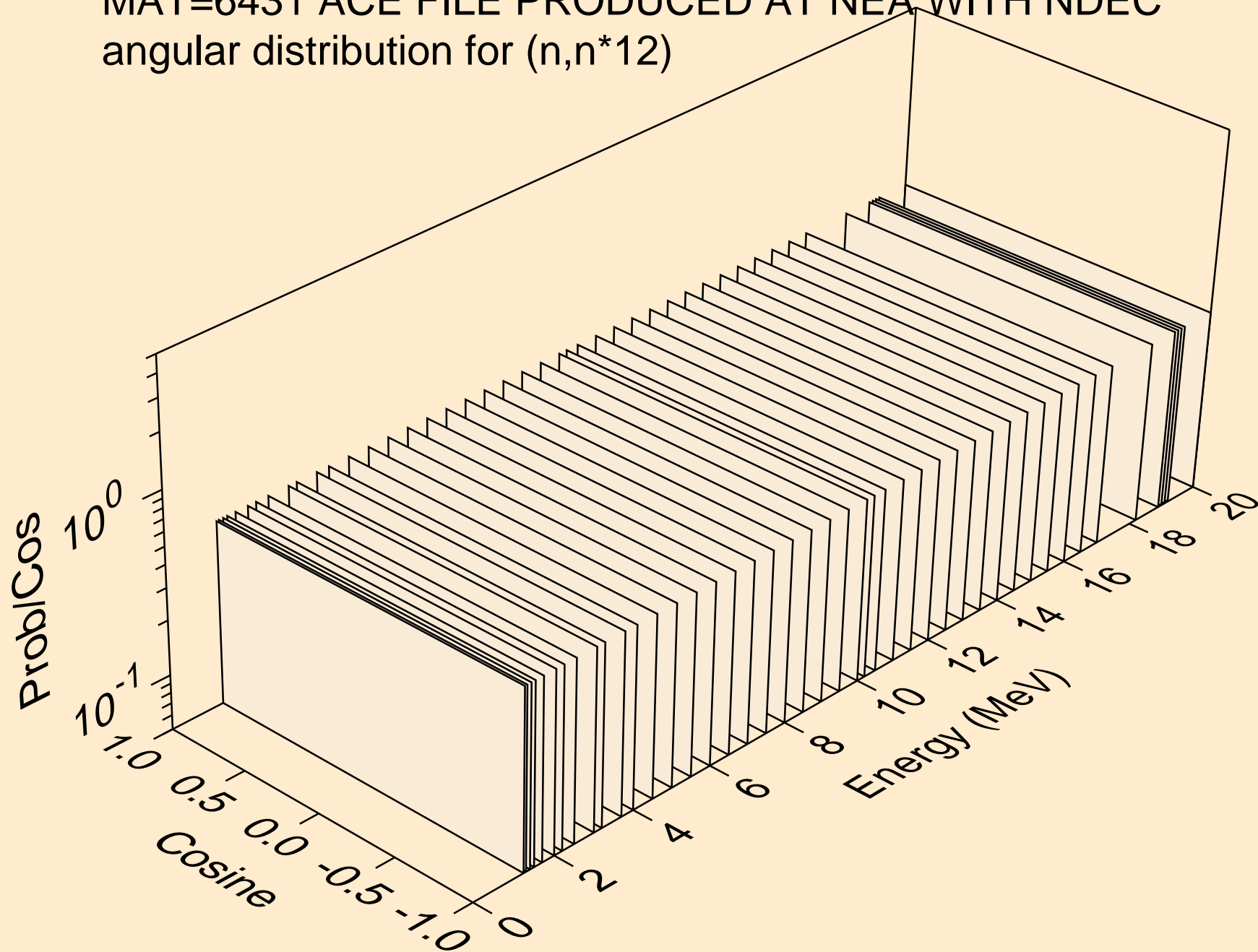

MAT=6431 ACE FILE PRODUCED AT NEA WITH NDEC
angular distribution for (n,n*13)

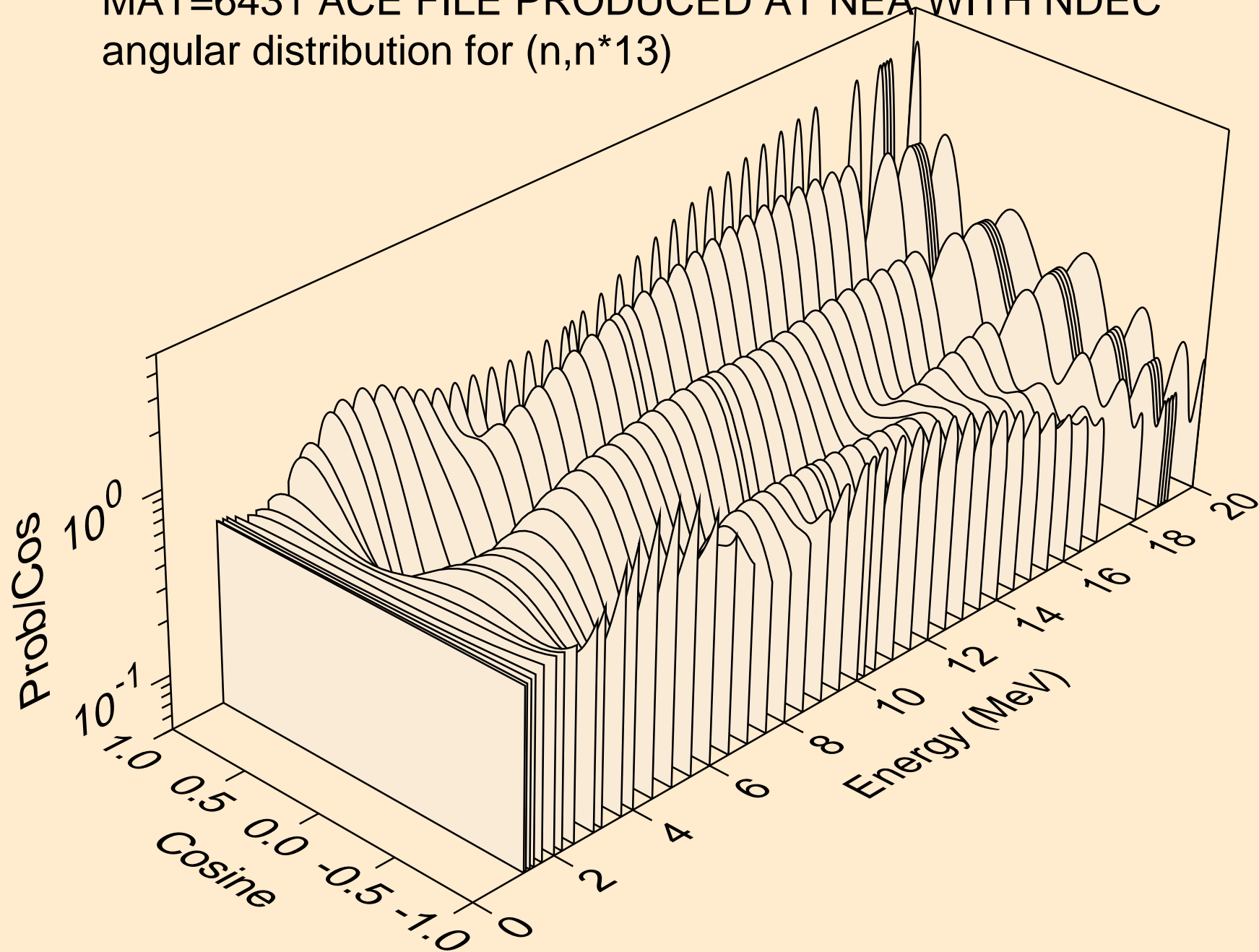

MAT=6431 ACE FILE PRODUCED AT NEA WITH NDEC
angular distribution for (n,n*14)

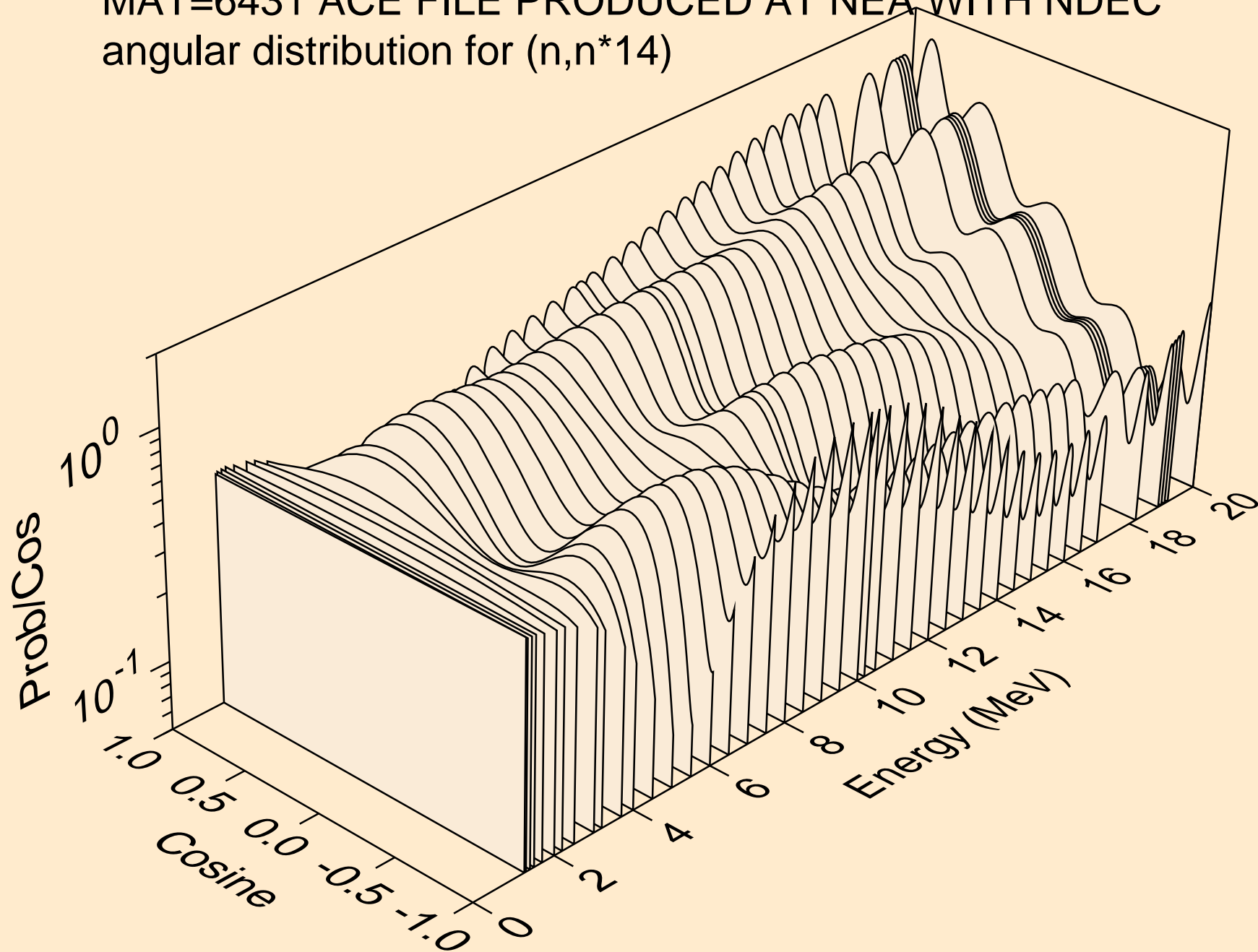

MAT=6431 ACE FILE PRODUCED AT NEA WITH NDEC
angular distribution for (n,n*15)

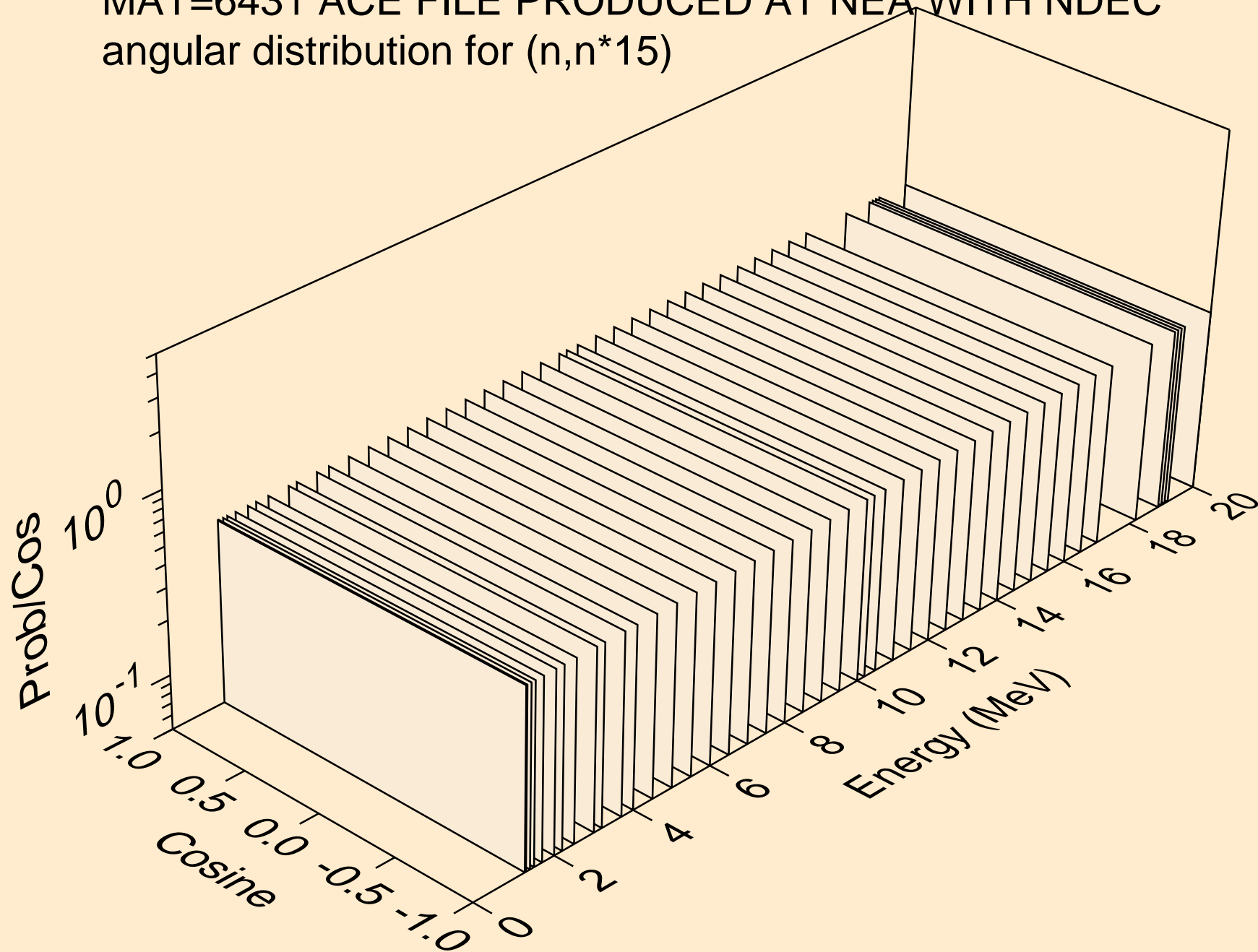

MAT=6431 ACE FILE PRODUCED AT NEA WITH NDEC
angular distribution for (n,n*16)

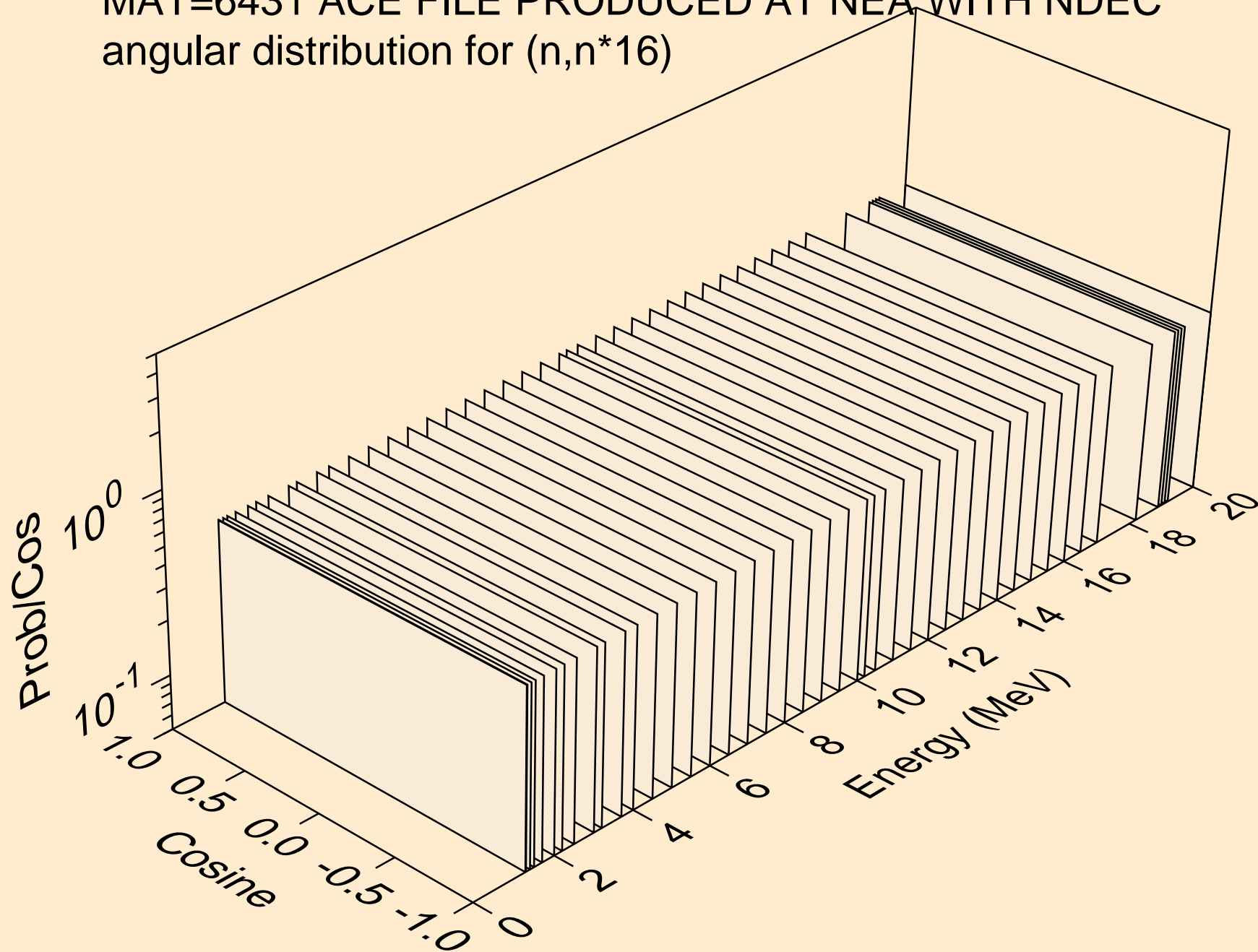

MAT=6431 ACE FILE PRODUCED AT NEA WITH NDEC
angular distribution for (n,n*17)

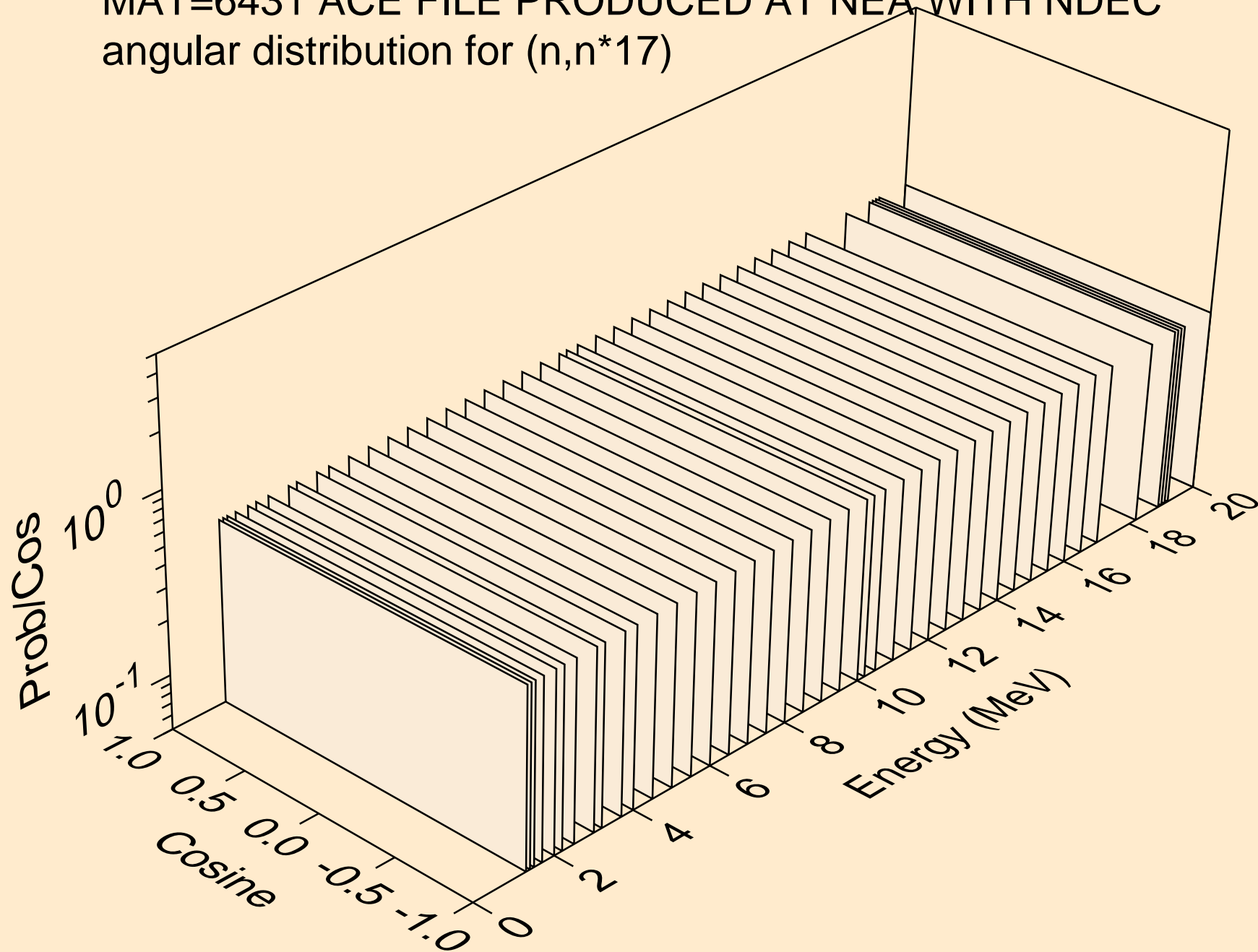

MAT=6431 ACE FILE PRODUCED AT NEA WITH NDEC
angular distribution for (n,n*18)

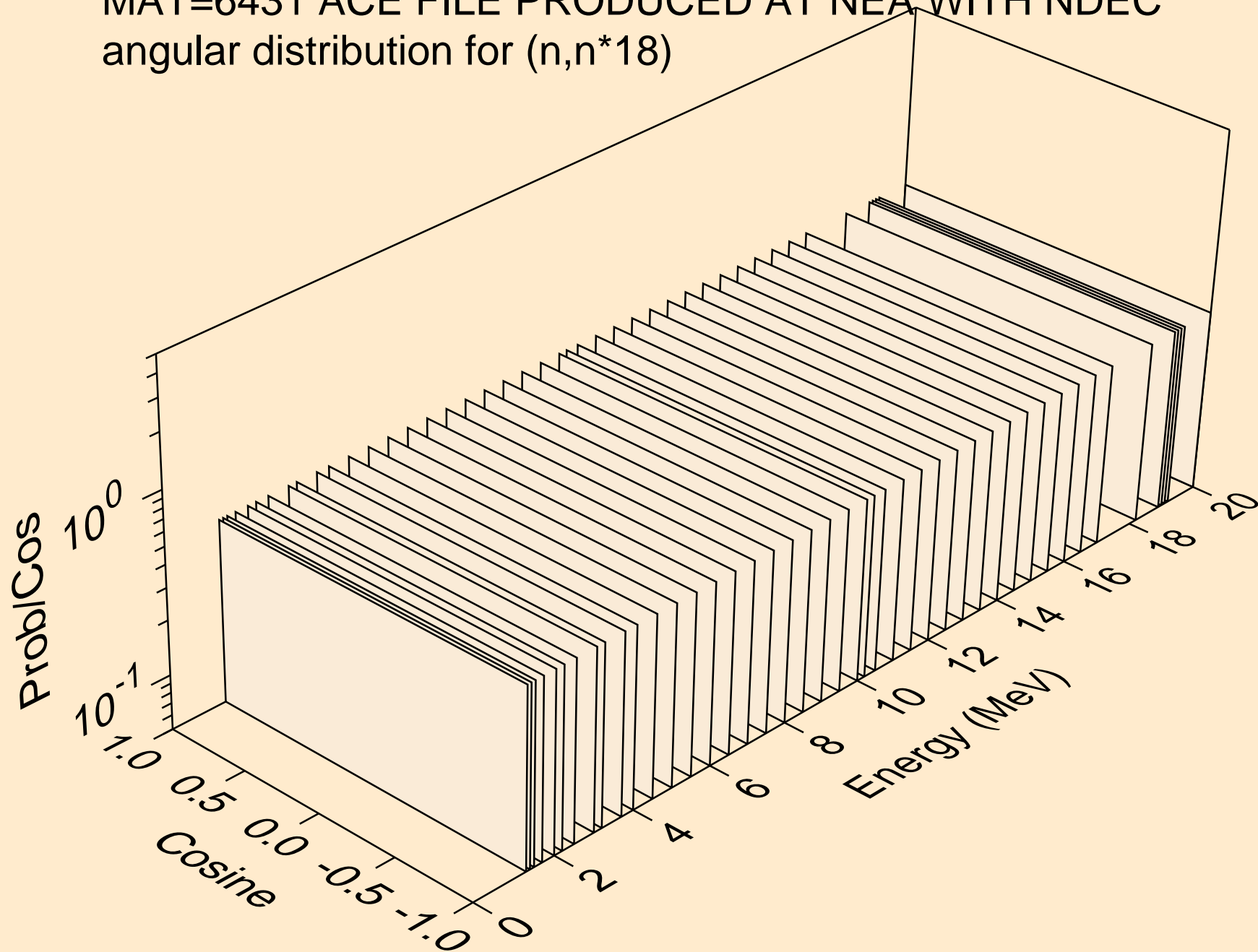

MAT=6431 ACE FILE PRODUCED AT NEA WITH NDEC
angular distribution for (n,n*19)

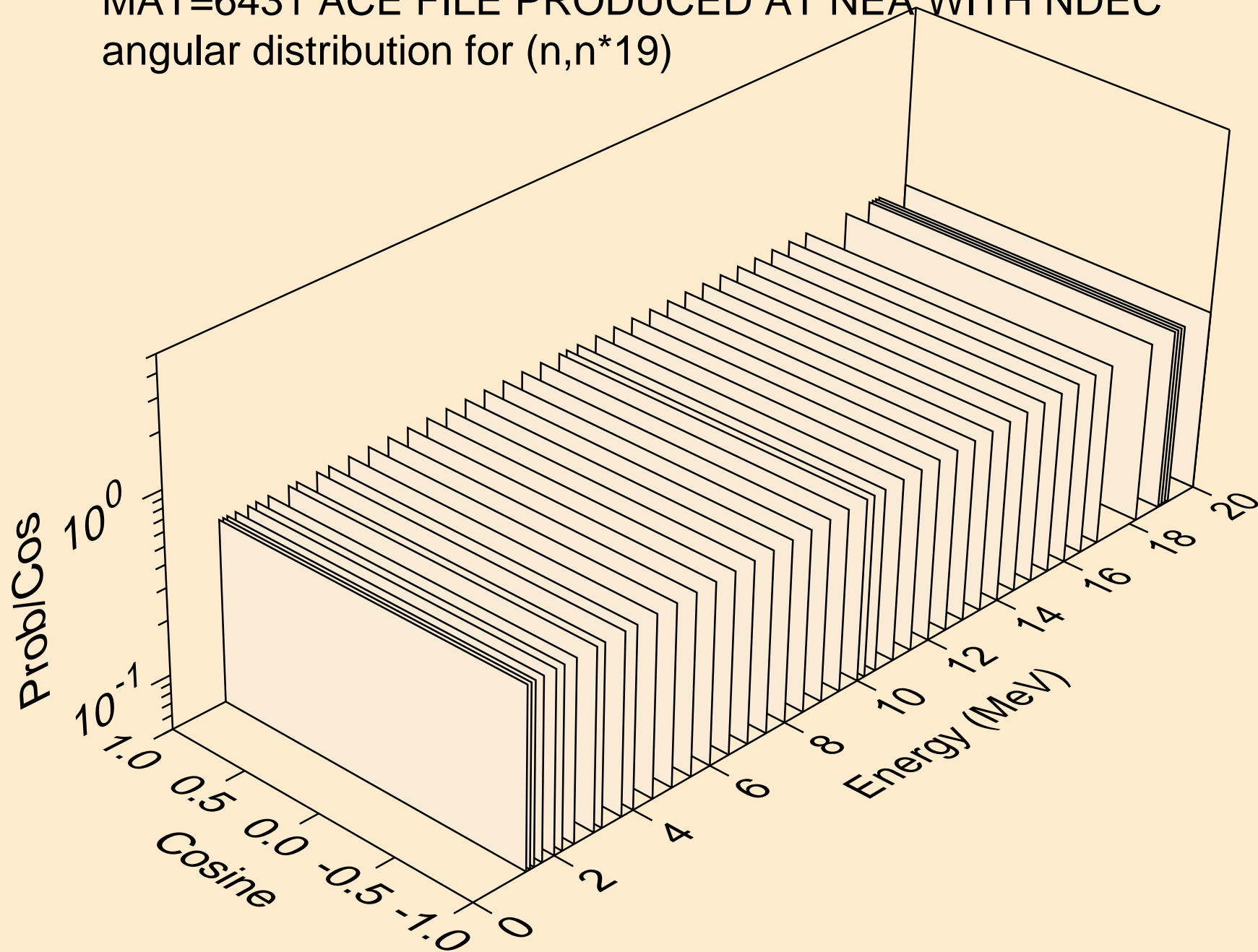

MAT=6431 ACE FILE PRODUCED AT NEA WITH NDEC
angular distribution for (n,n*20)

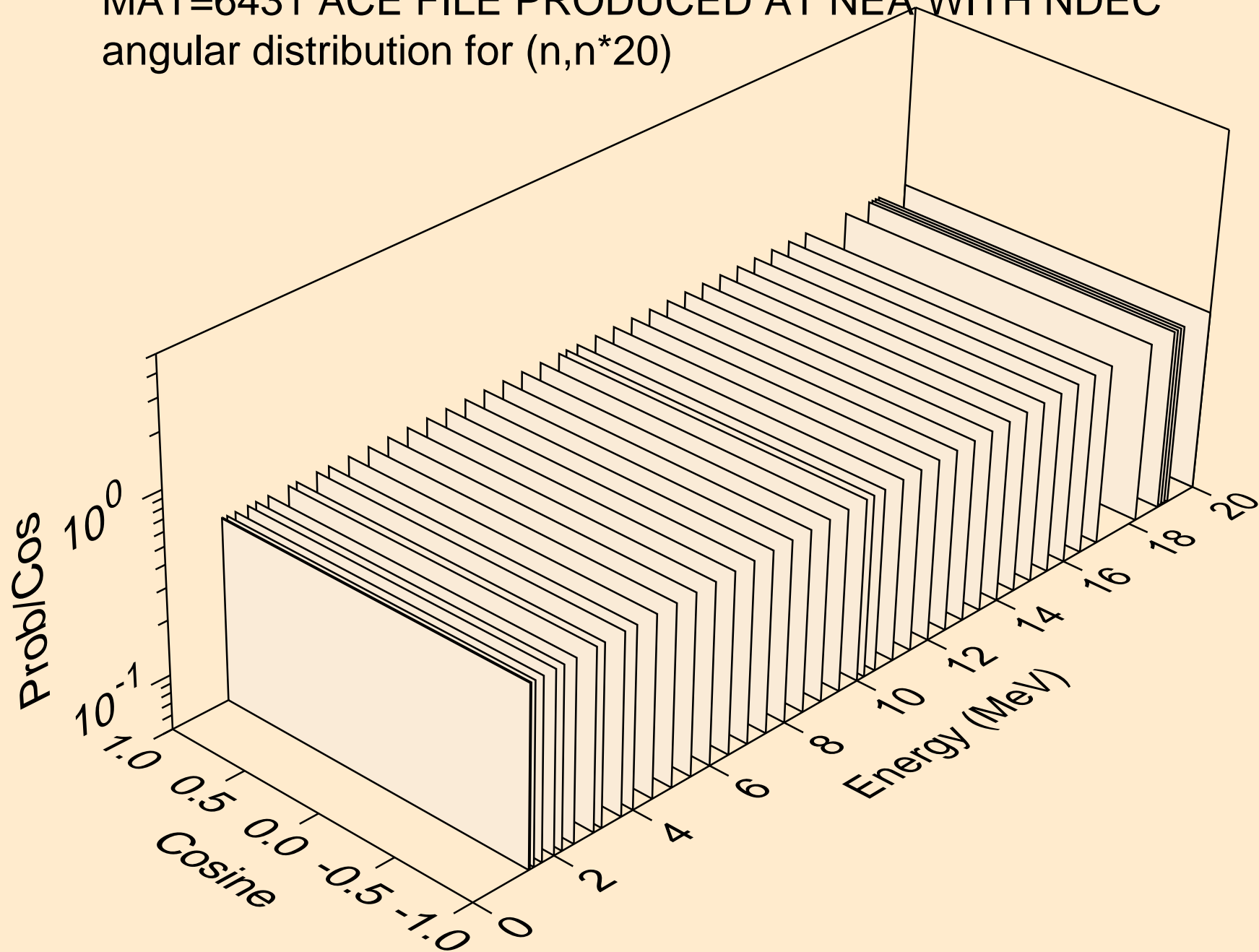

MAT=6431 ACE FILE PRODUCED AT NEA WITH NDEC
angular distribution for (n,n*21)

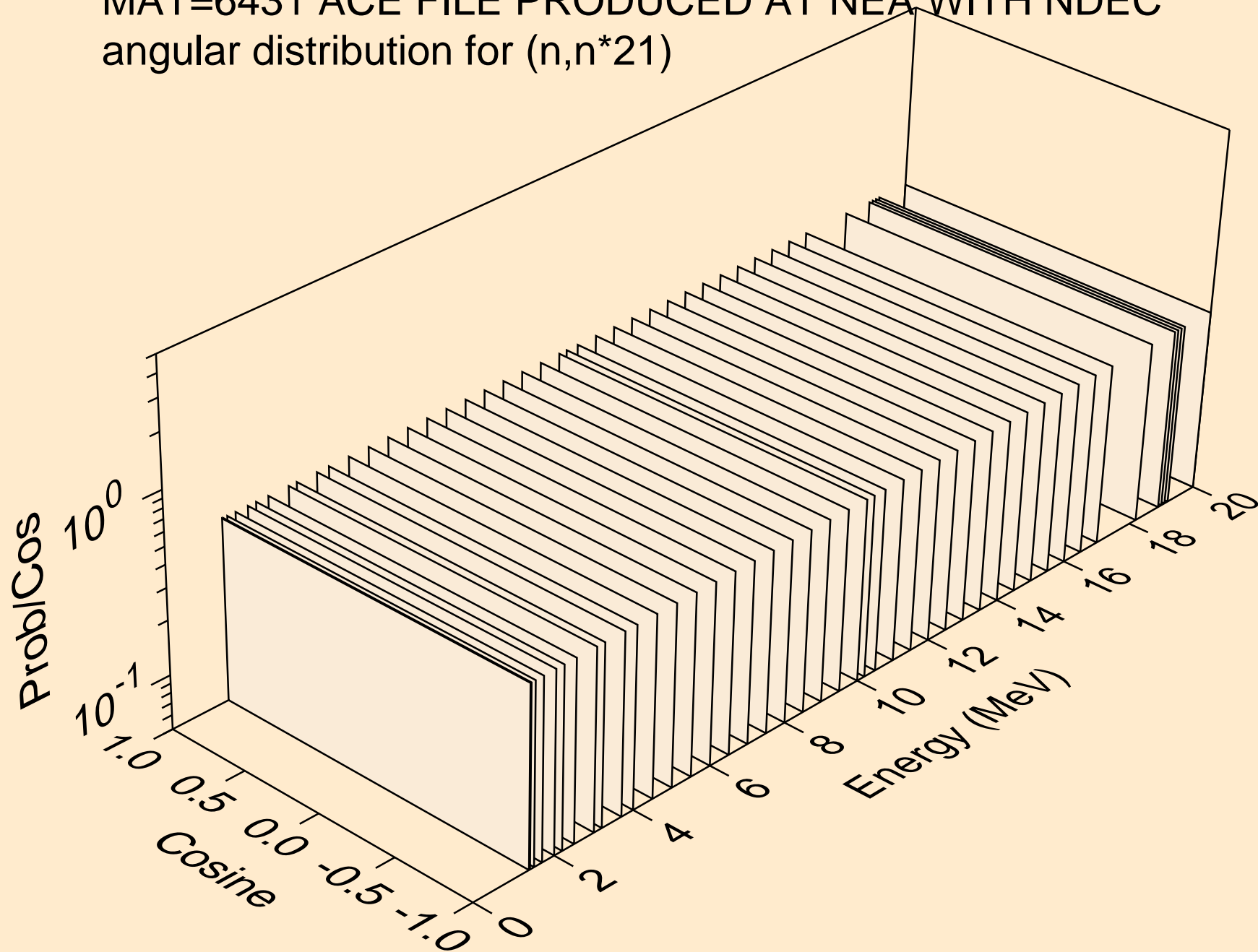

MAT=6431 ACE FILE PRODUCED AT NEA WITH NDEC
angular distribution for (n,n*22)

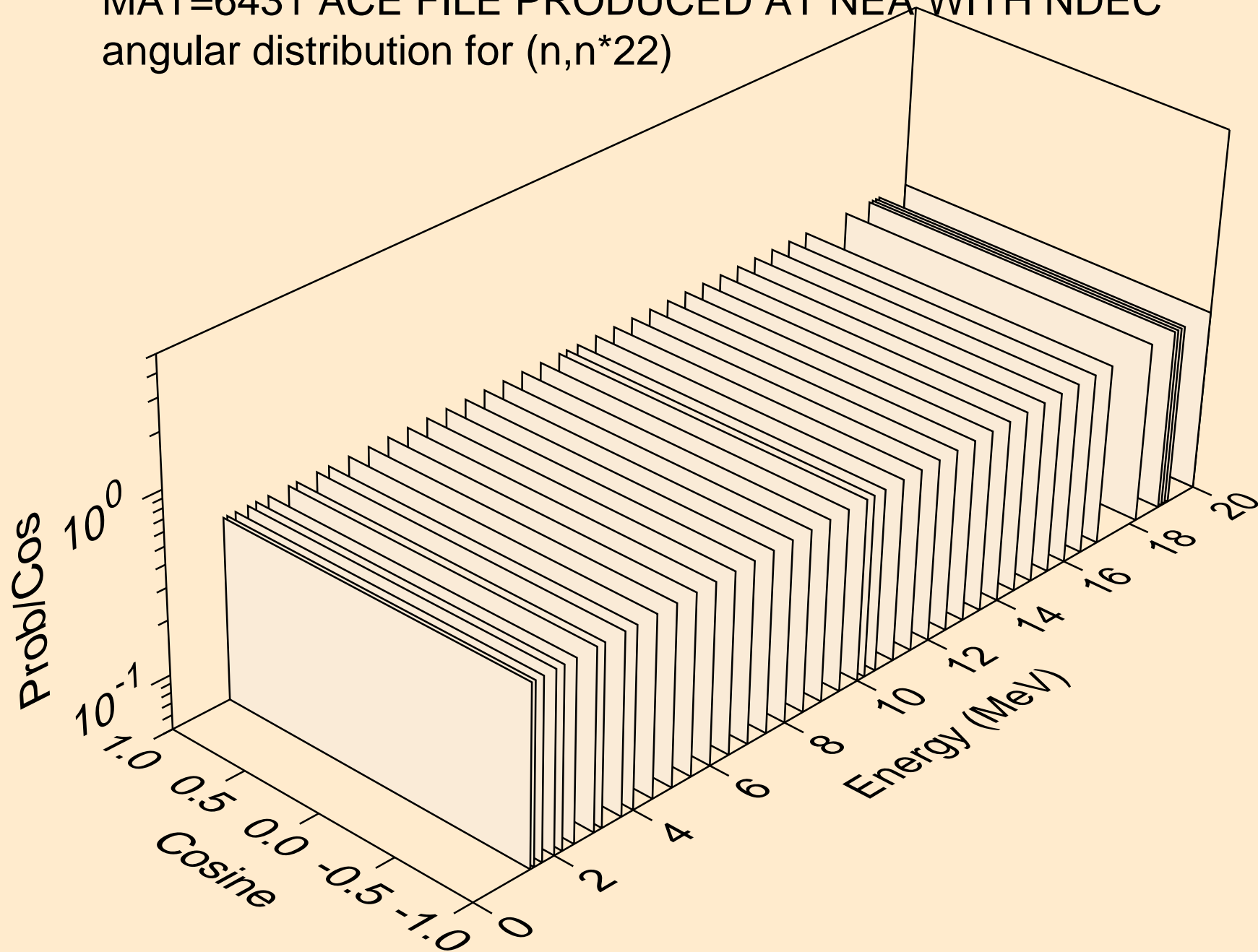

MAT=6431 ACE FILE PRODUCED AT NEA WITH NDEC
angular distribution for (n,n*23)

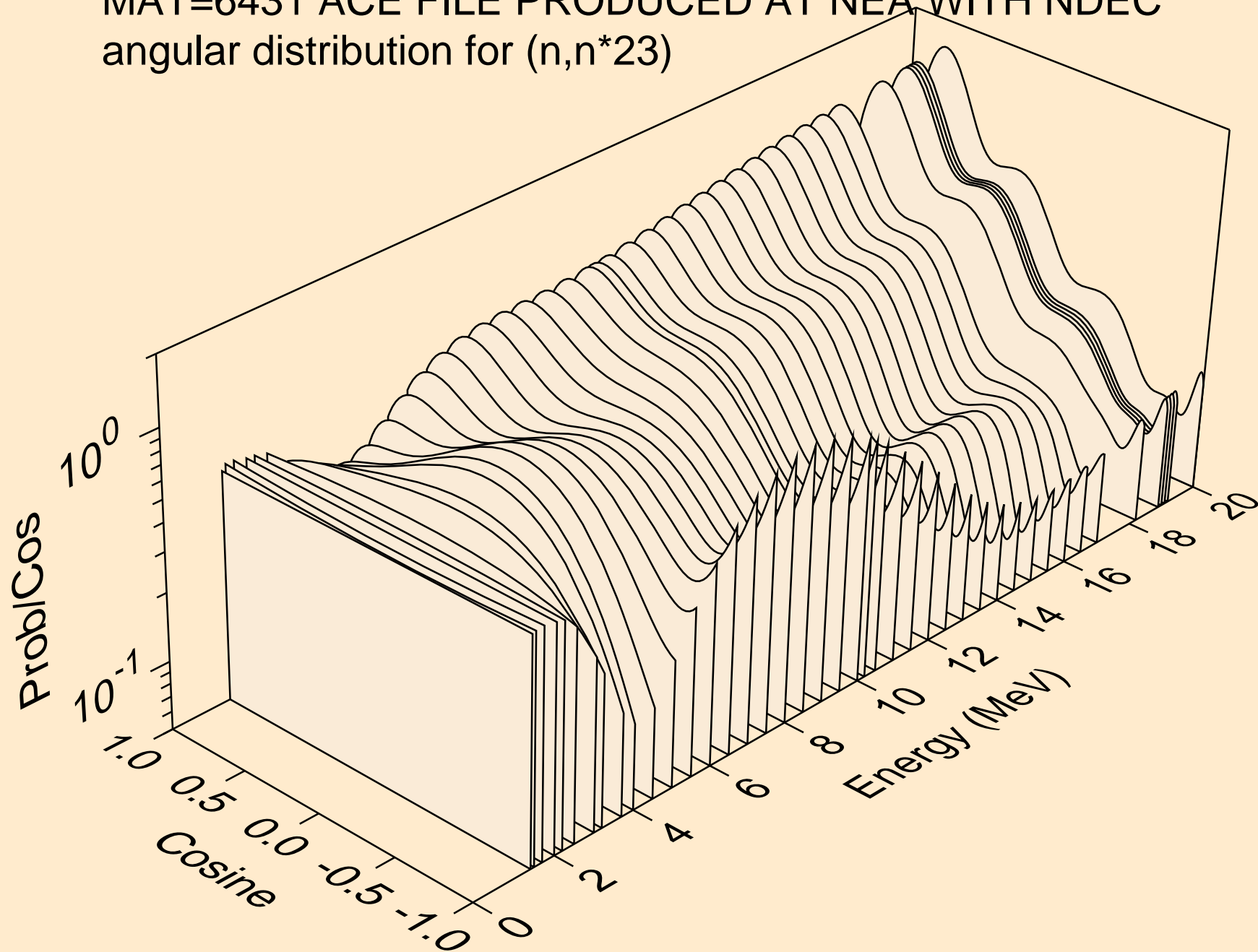

MAT=6431 ACE FILE PRODUCED AT NEA WITH NDEC
angular distribution for (n,n*24)

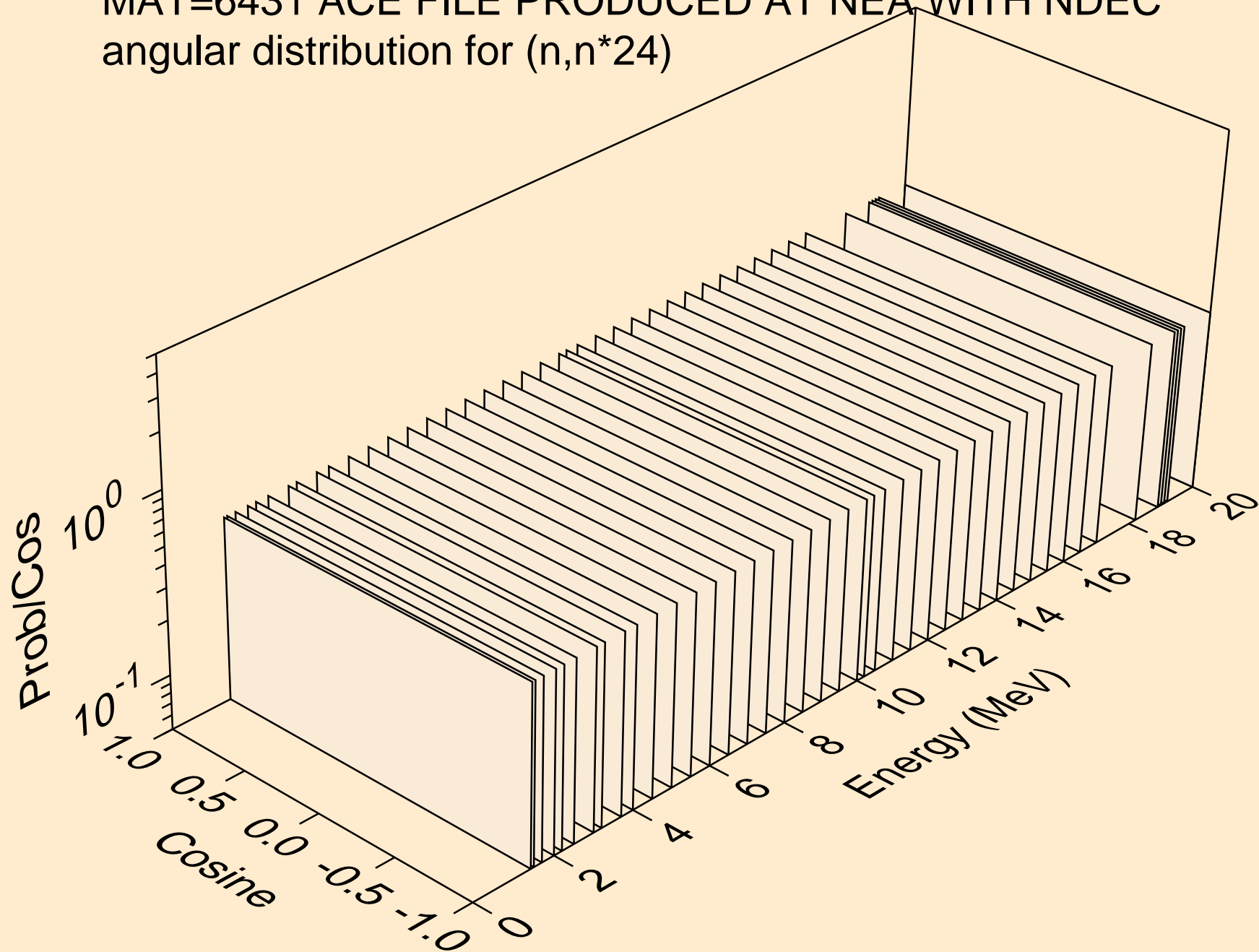

MAT=6431 ACE FILE PRODUCED AT NEA WITH NDEC
angular distribution for (n,n*25)

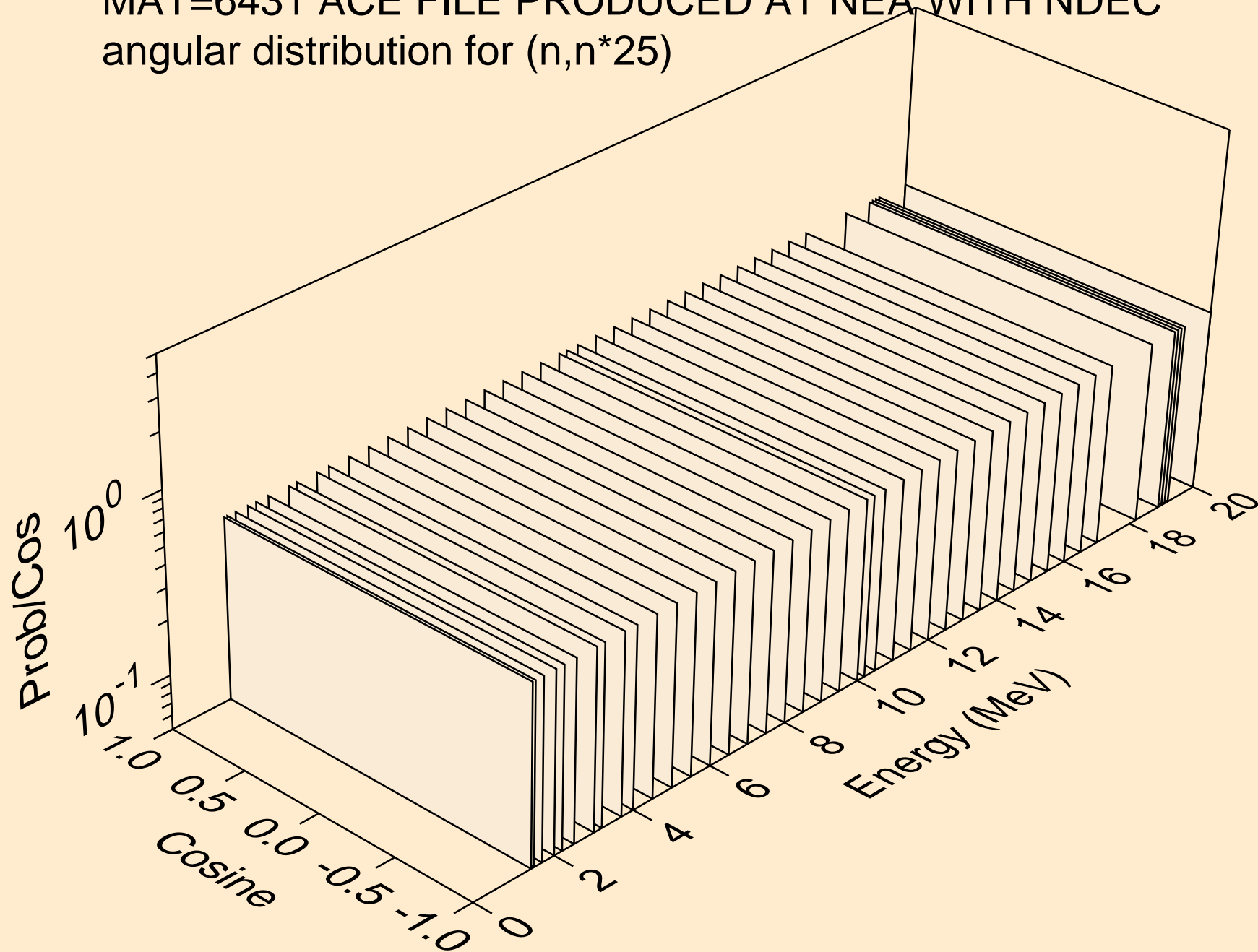

MAT=6431 ACE FILE PRODUCED AT NEA WITH NDEC
angular distribution for (n,n*26)

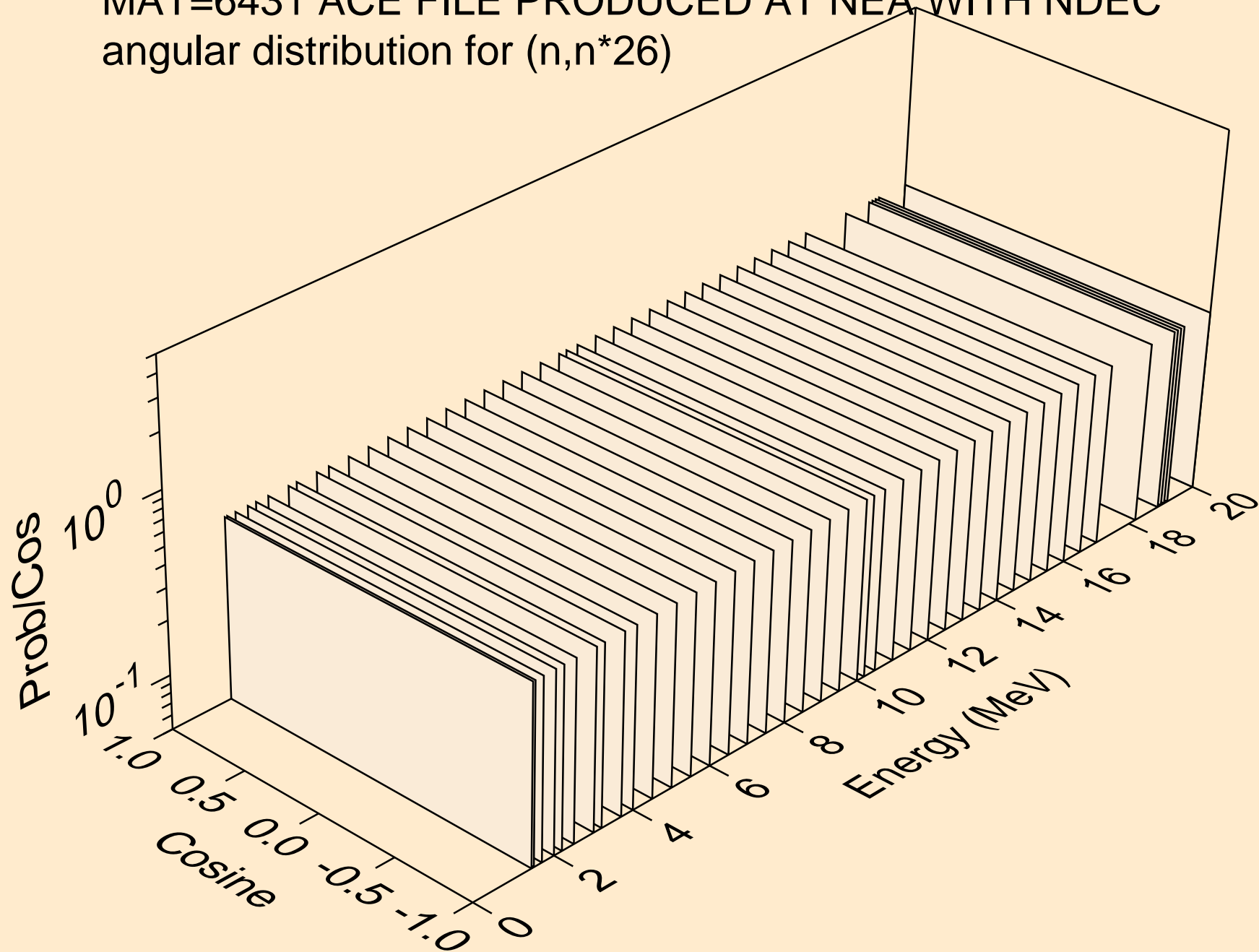

MAT=6431 ACE FILE PRODUCED AT NEA WITH NDEC
Neutron emission for (n,2n)

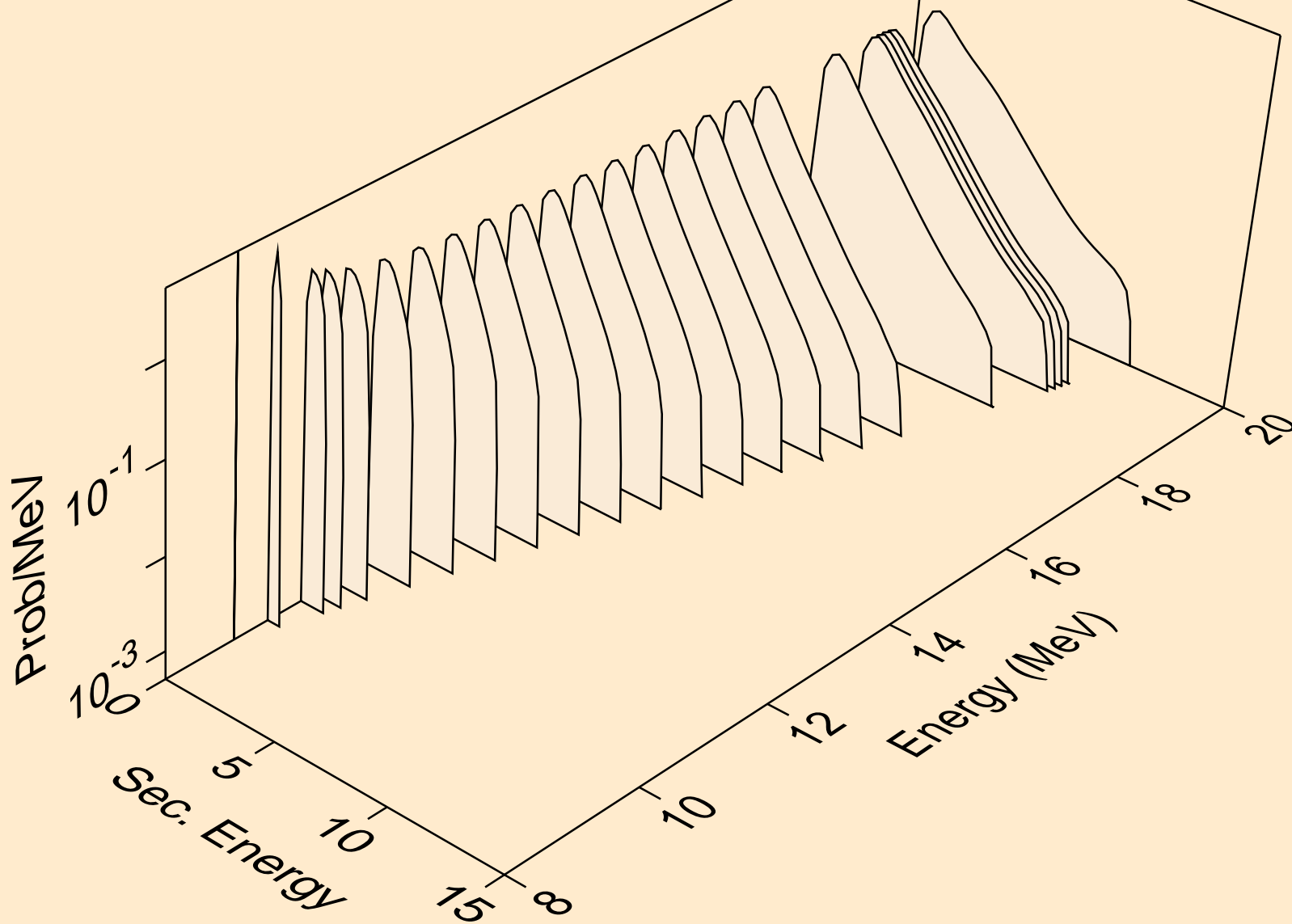

MAT=6431 ACE FILE PRODUCED AT NEA WITH NDEC
Neutron emission for (n,3n)

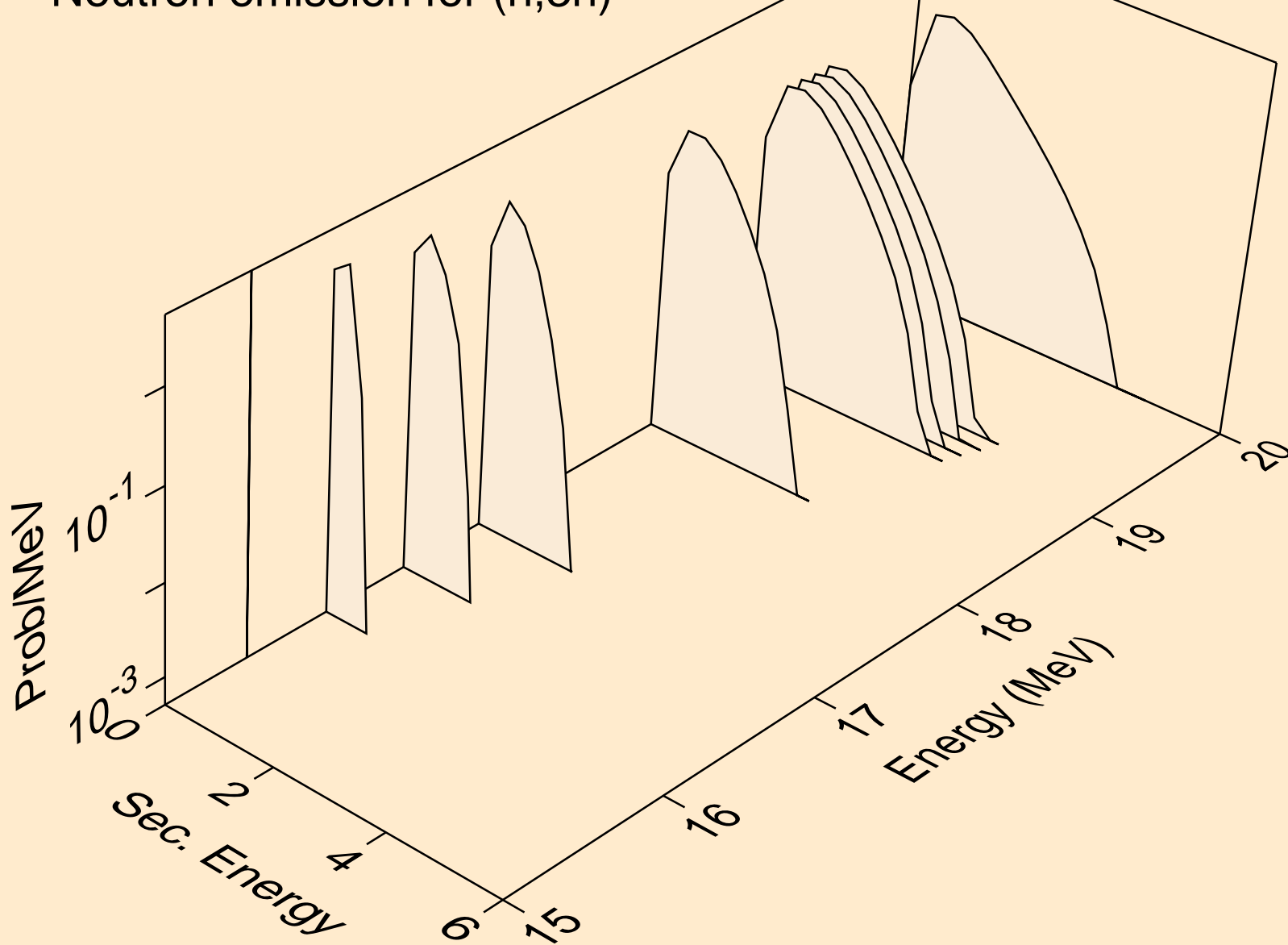

MAT=6431 ACE FILE PRODUCED AT NEA WITH NDEC
Neutron emission for (n,n*)a

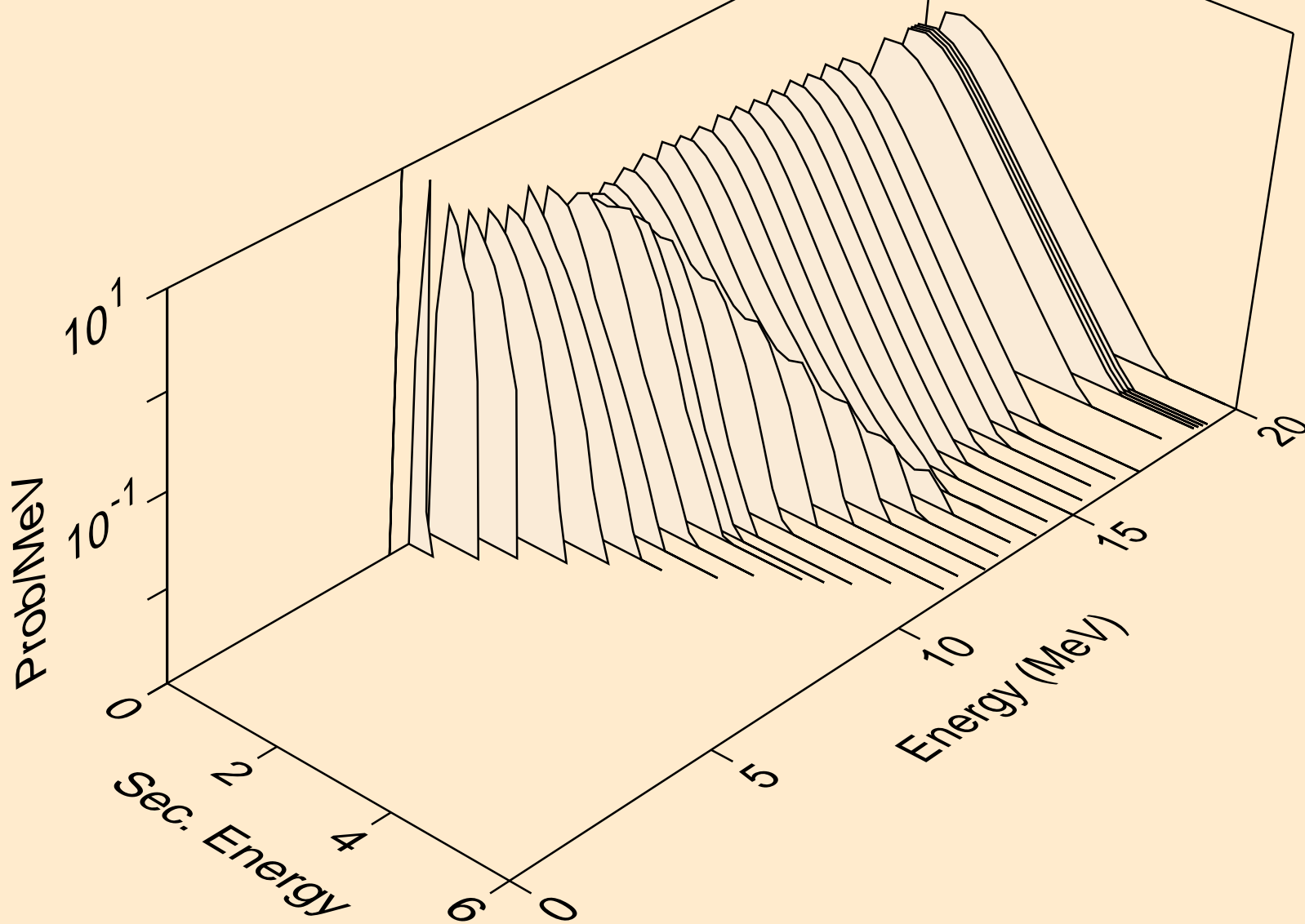

MAT=6431 ACE FILE PRODUCED AT NEA WITH NDEC
Neutron emission for (n,2n)a

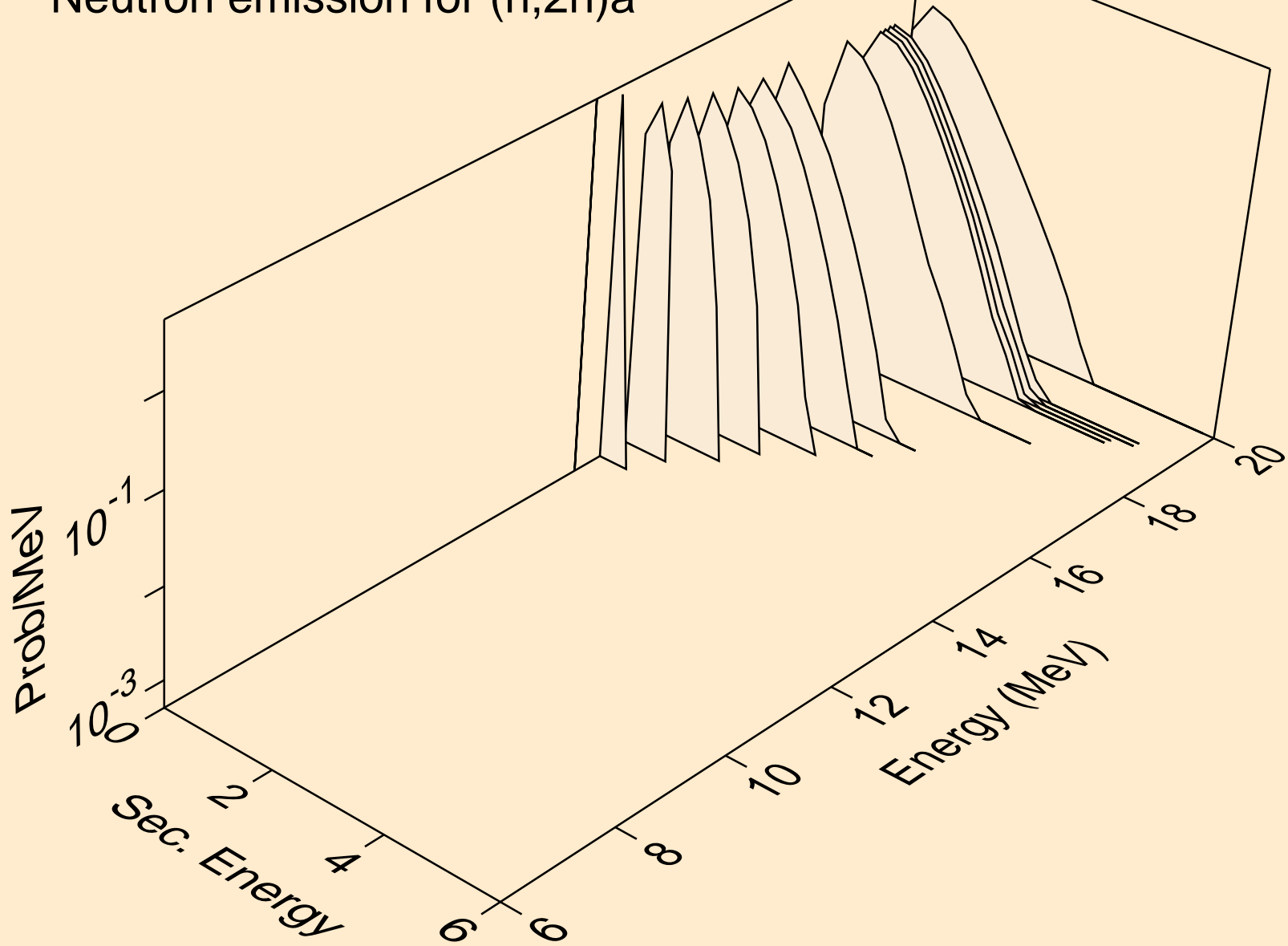

MAT=6431 ACE FILE PRODUCED AT NEA WITH NDEC
Neutron emission for (n,n*)p

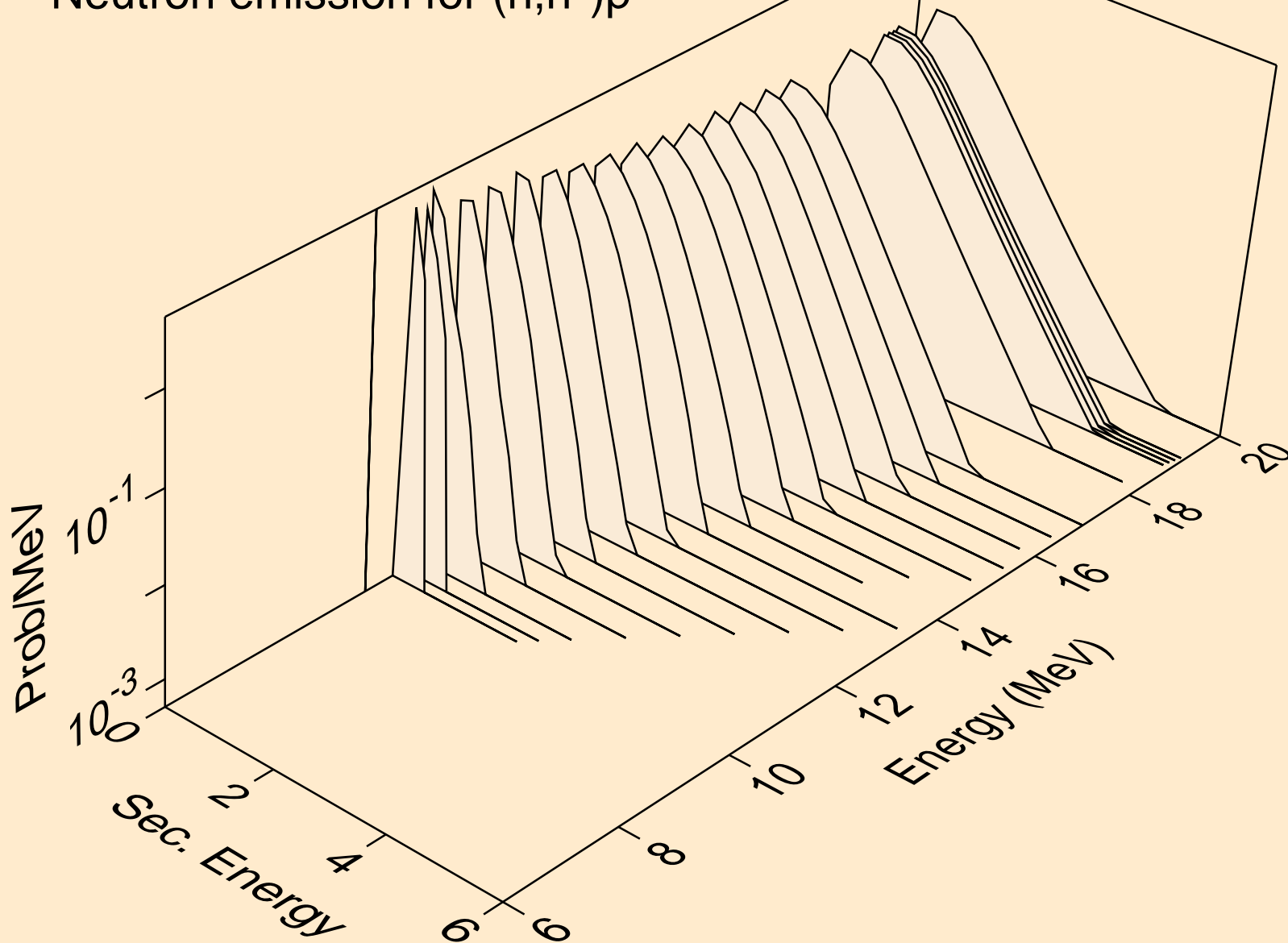

MAT=6431 ACE FILE PRODUCED AT NEA WITH NDEC
Neutron emission for (n,2np)

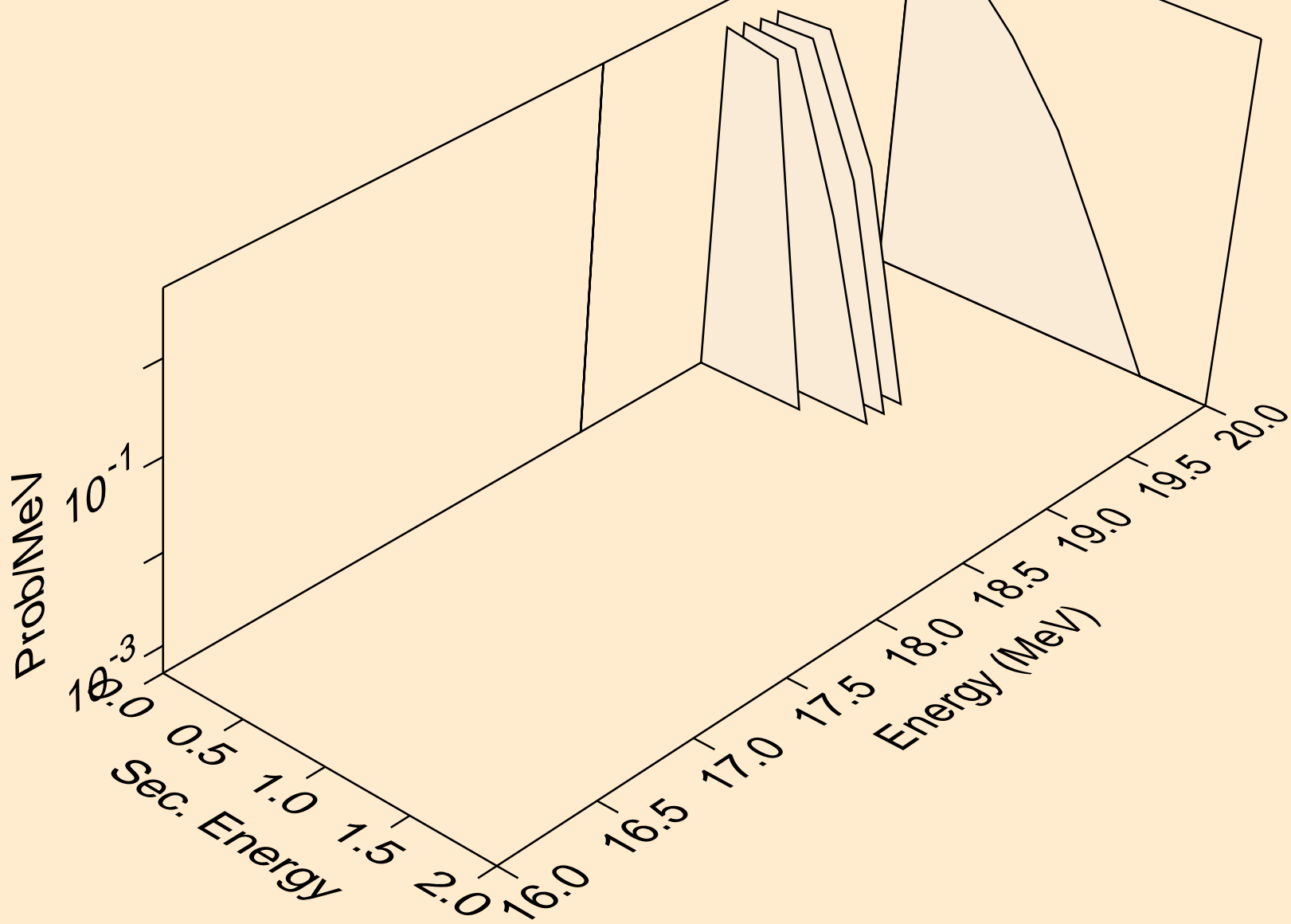

MAT=6431 ACE FILE PRODUCED AT NEA WITH NDEC
Neutron emission for (n,n*c)

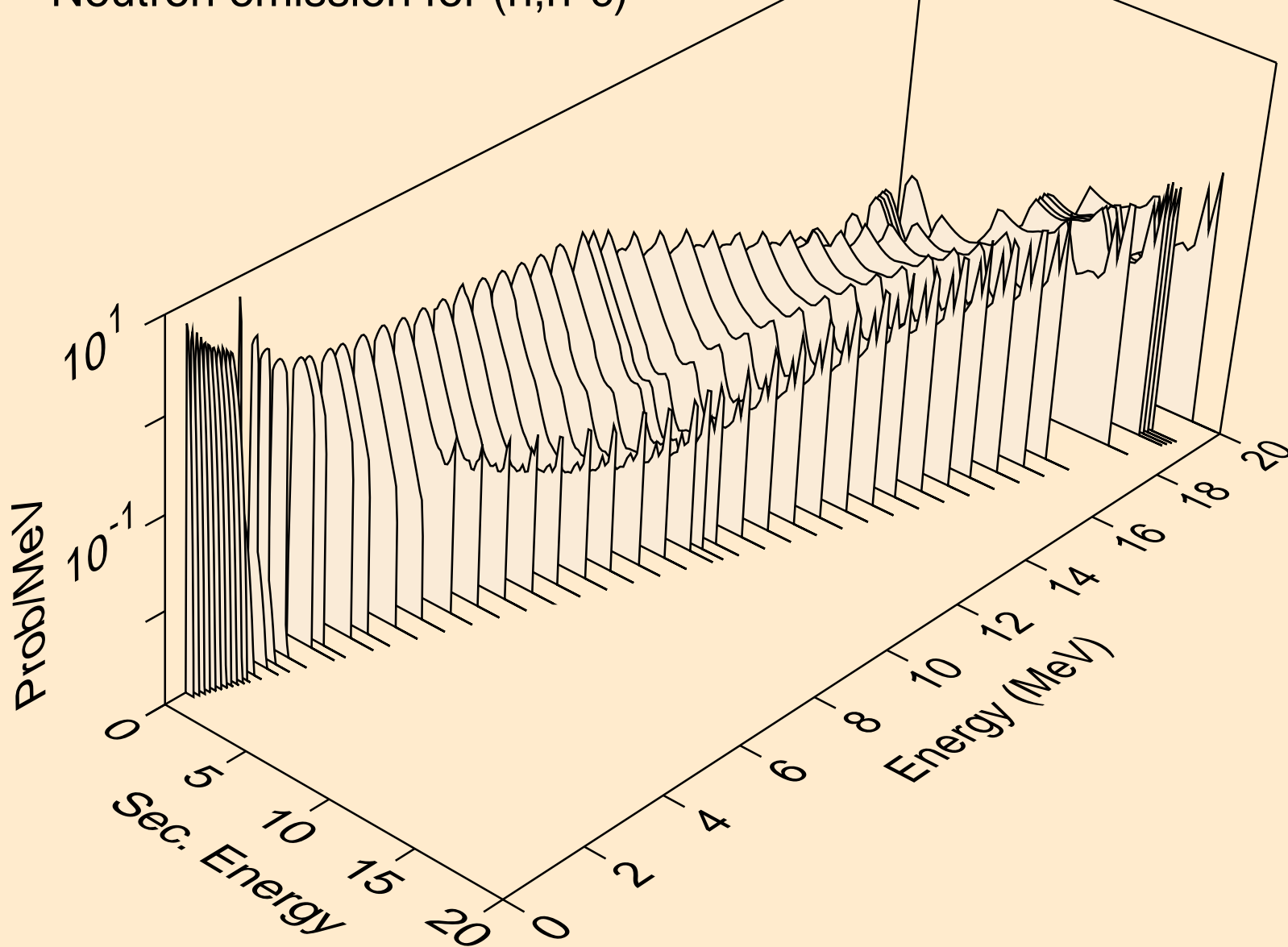

MAT=6431 ACE FILE PRODUCED AT NEA WITH NDEC
Photon emission for (n,2n)

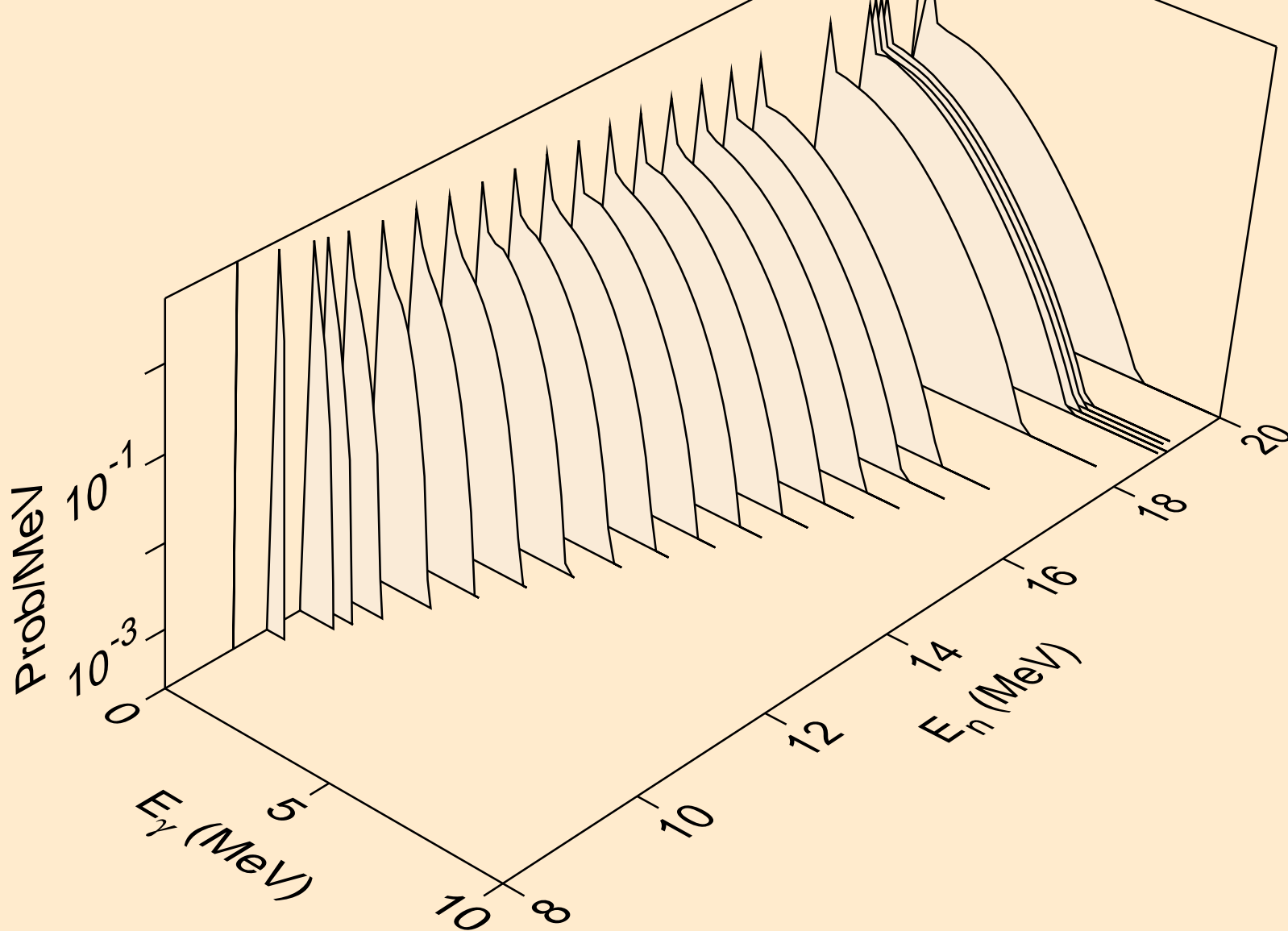

MAT=6431 ACE FILE PRODUCED AT NEA WITH NDEC
Photon emission for (n,3n)

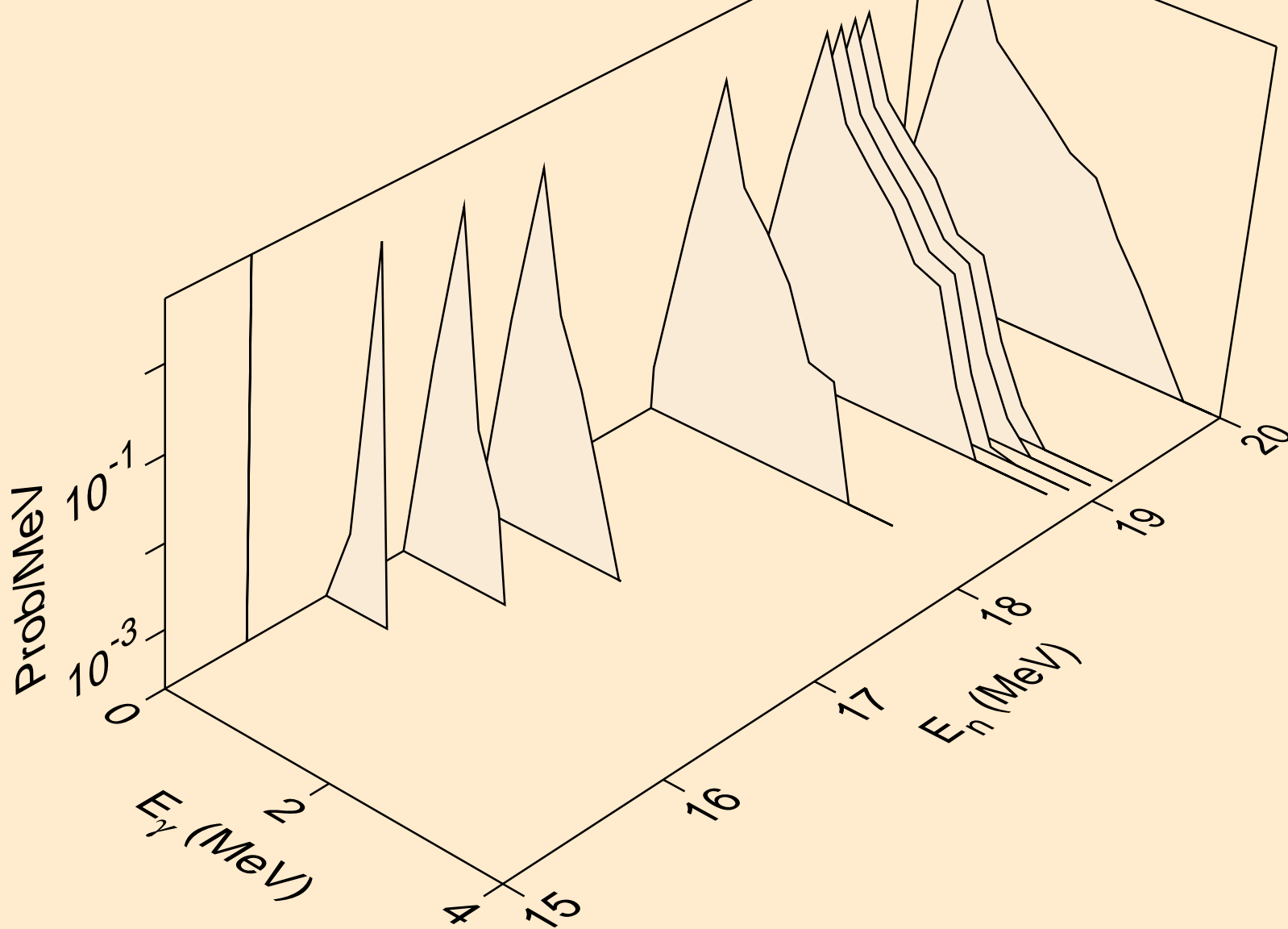

MAT=6431 ACE FILE PRODUCED AT NEA WITH NDEC
Photon emission for (n,n*)a

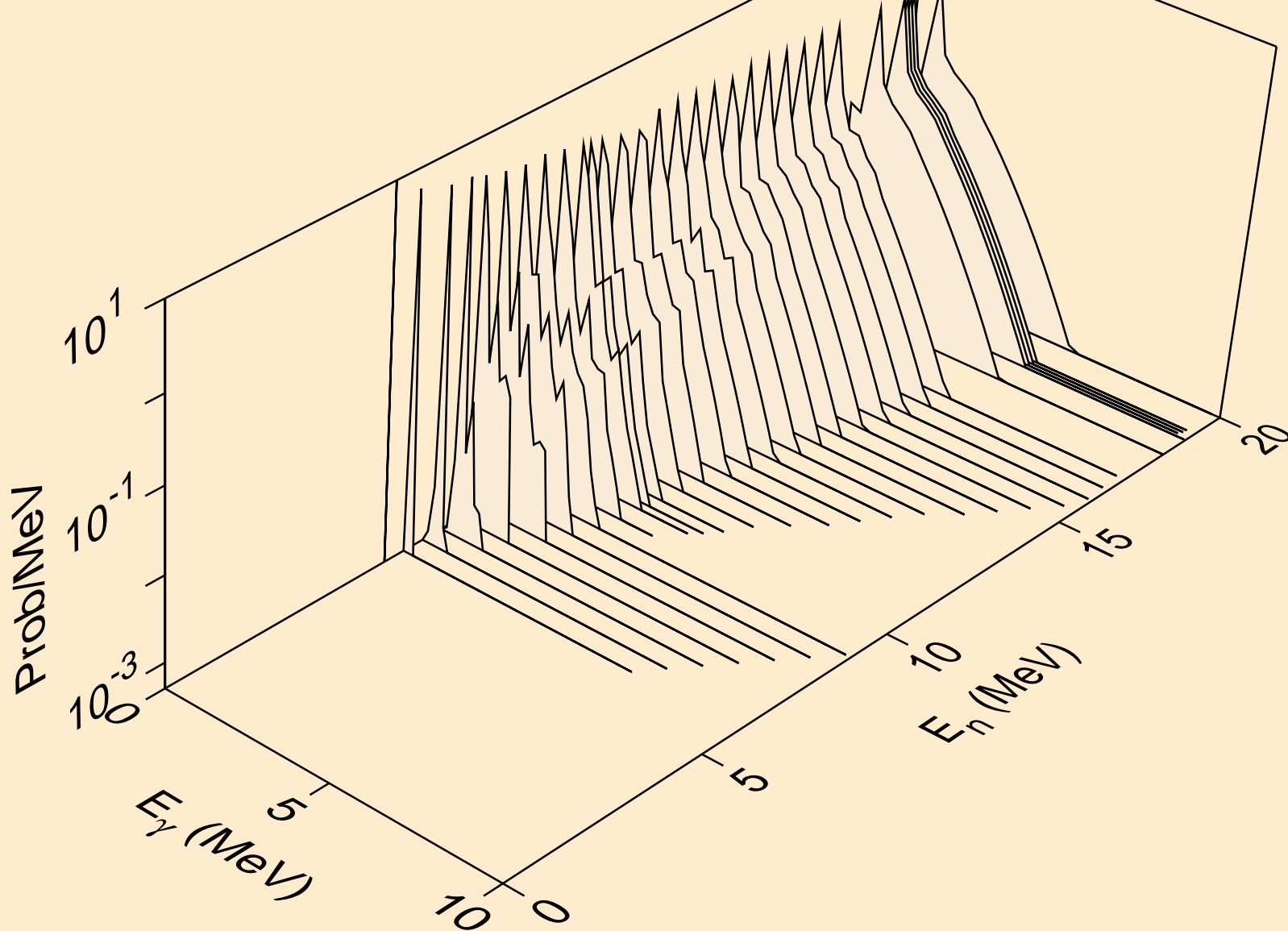

MAT=6431 ACE FILE PRODUCED AT NEA WITH NDEC
Photon emission for (n,2n)a

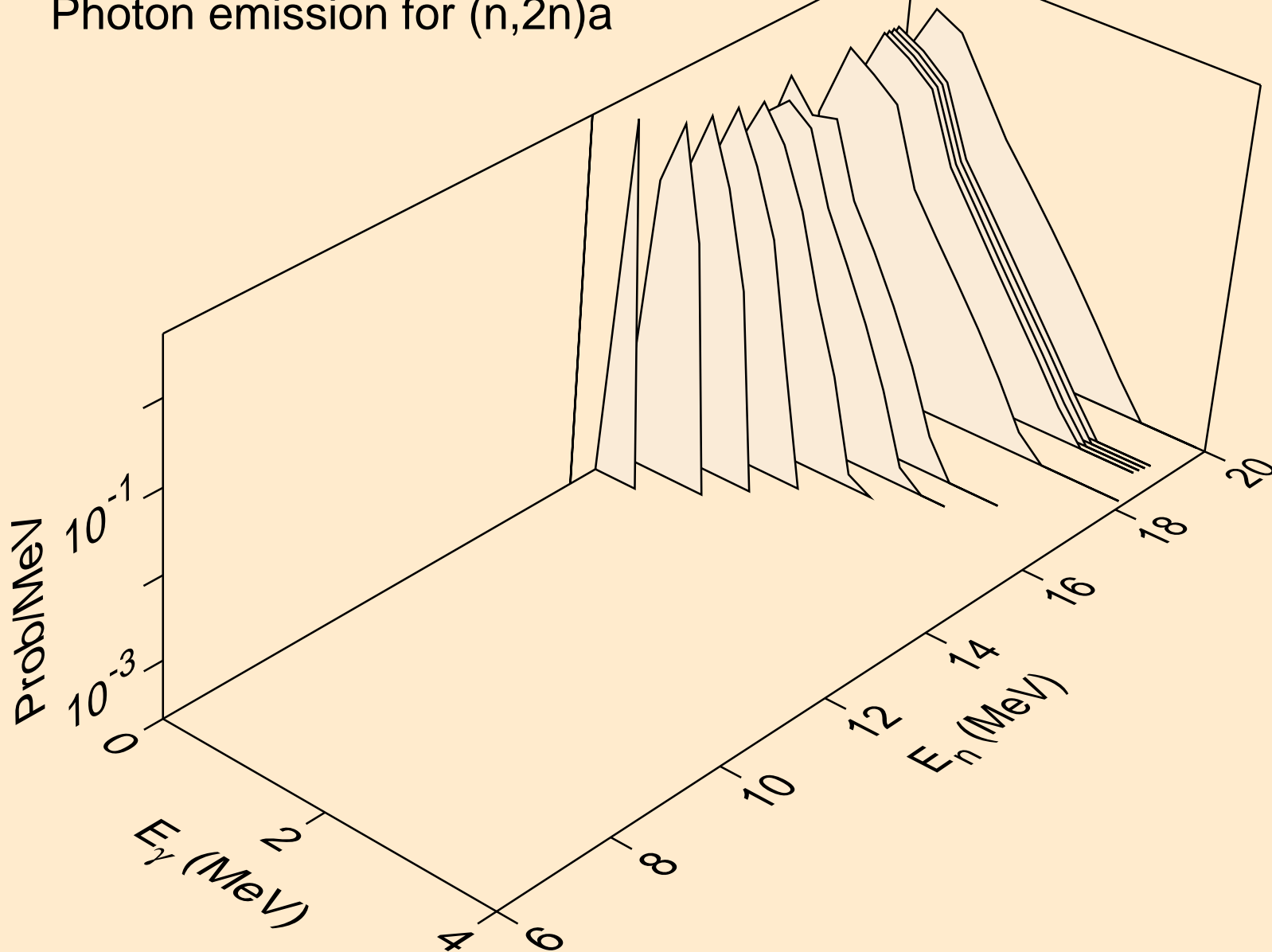

MAT=6431 ACE FILE PRODUCED AT NEA WITH NDEC
Photon emission for (n,n*)p

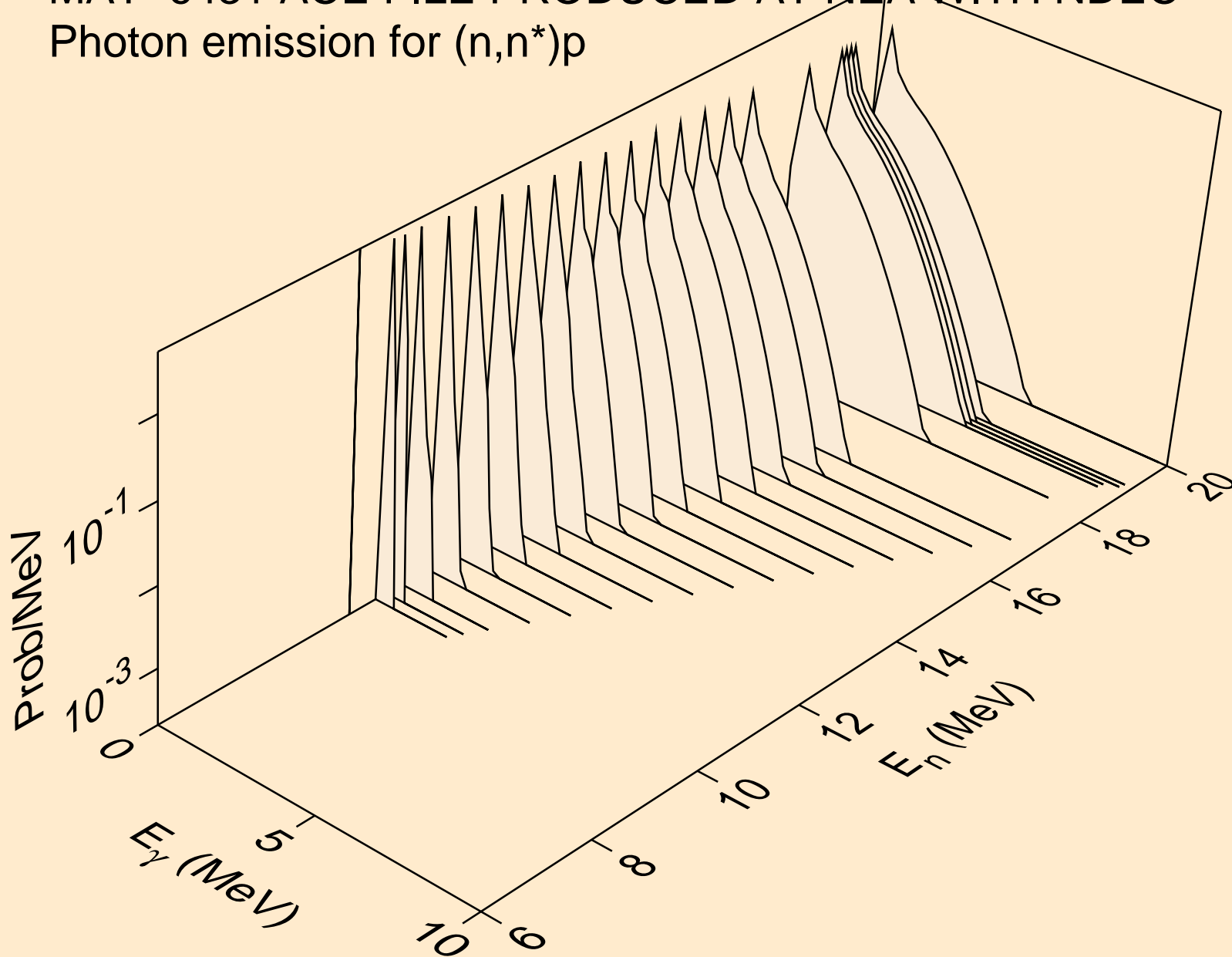

MAT=6431 ACE FILE PRODUCED AT NEA WITH NDEC
Photon emission for (n,2np)

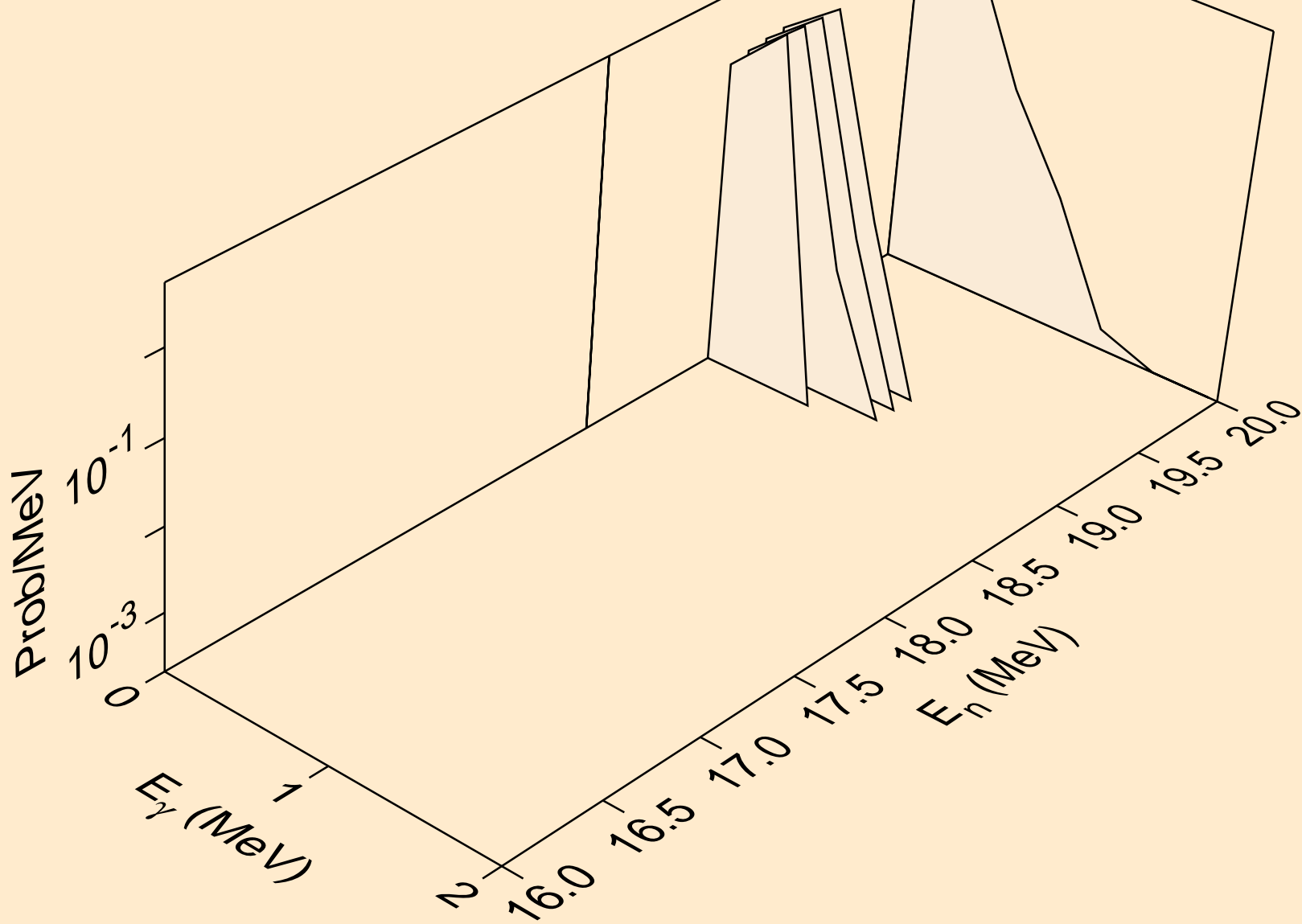

MAT=6431 ACE FILE PRODUCED AT NEA WITH NDEC
Photon emission for (n,n*c)

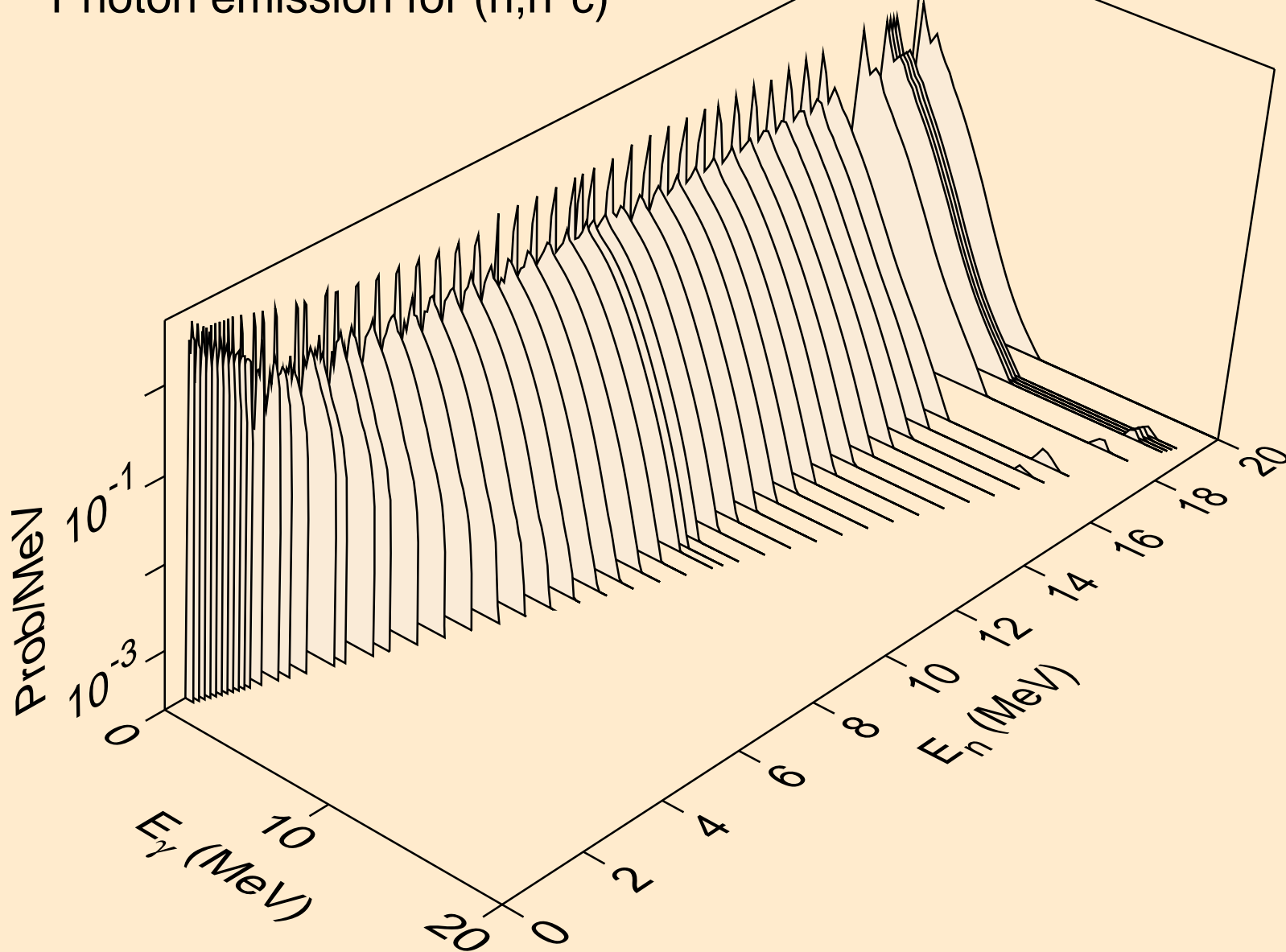

MAT=6431 ACE FILE PRODUCED AT NEA WITH NDEC
Photon emission for (n,gma)

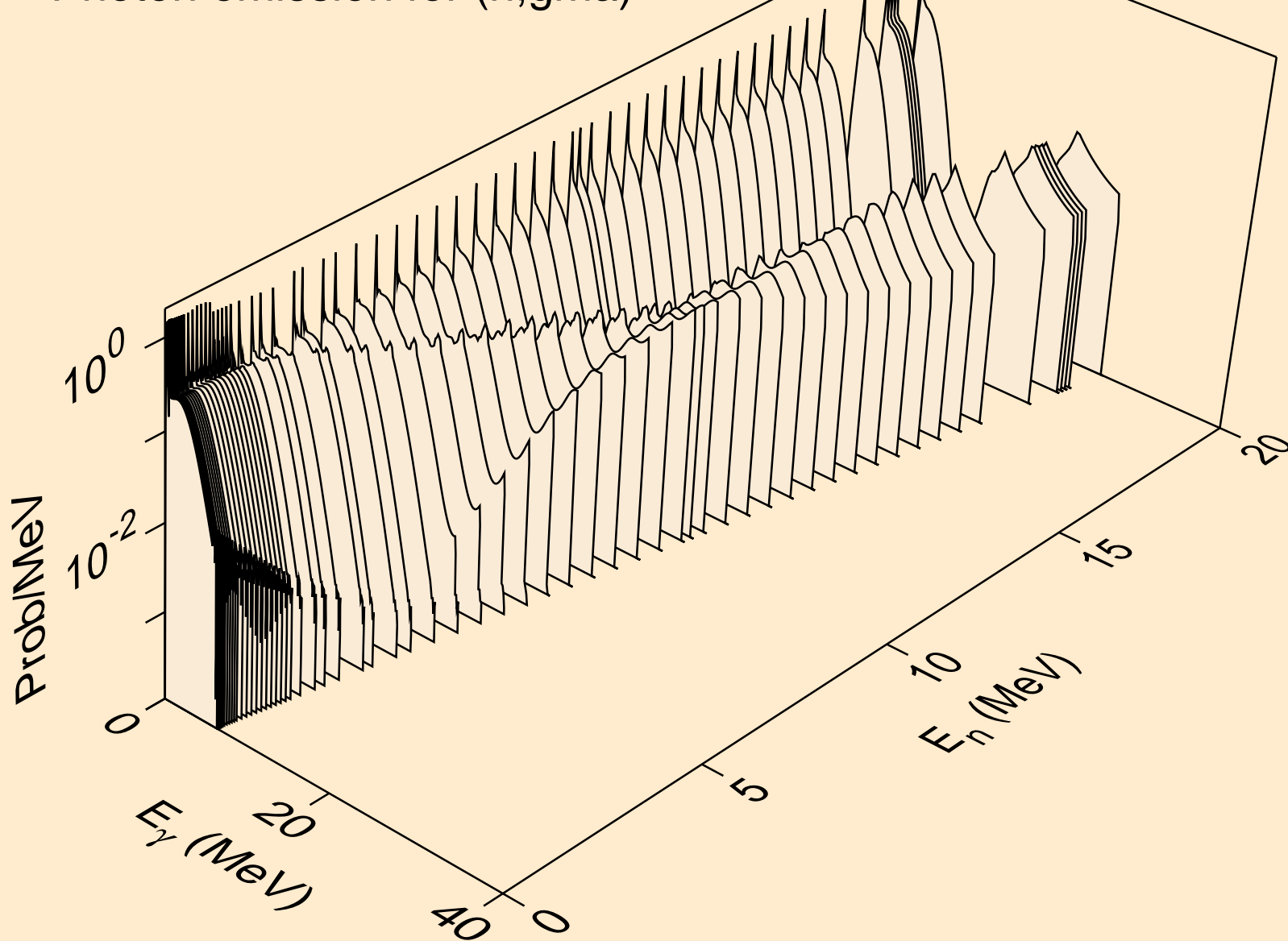

MAT=6431 ACE FILE PRODUCED AT NEA WITH NDEC
Photon emission for (n,p*c)

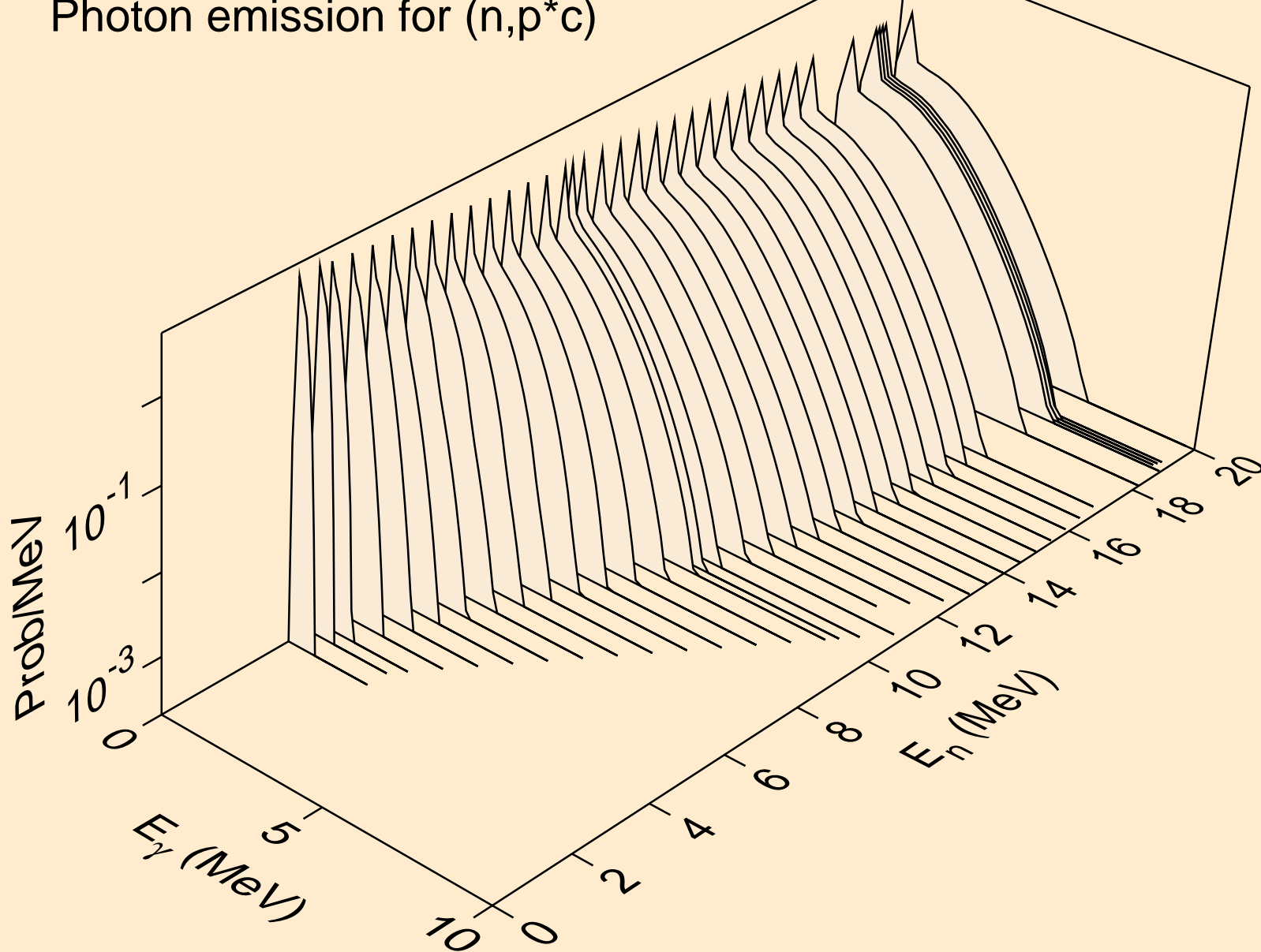

MAT=6431 ACE FILE PRODUCED AT NEA WITH NDEC
Photon emission for (n,a*c)

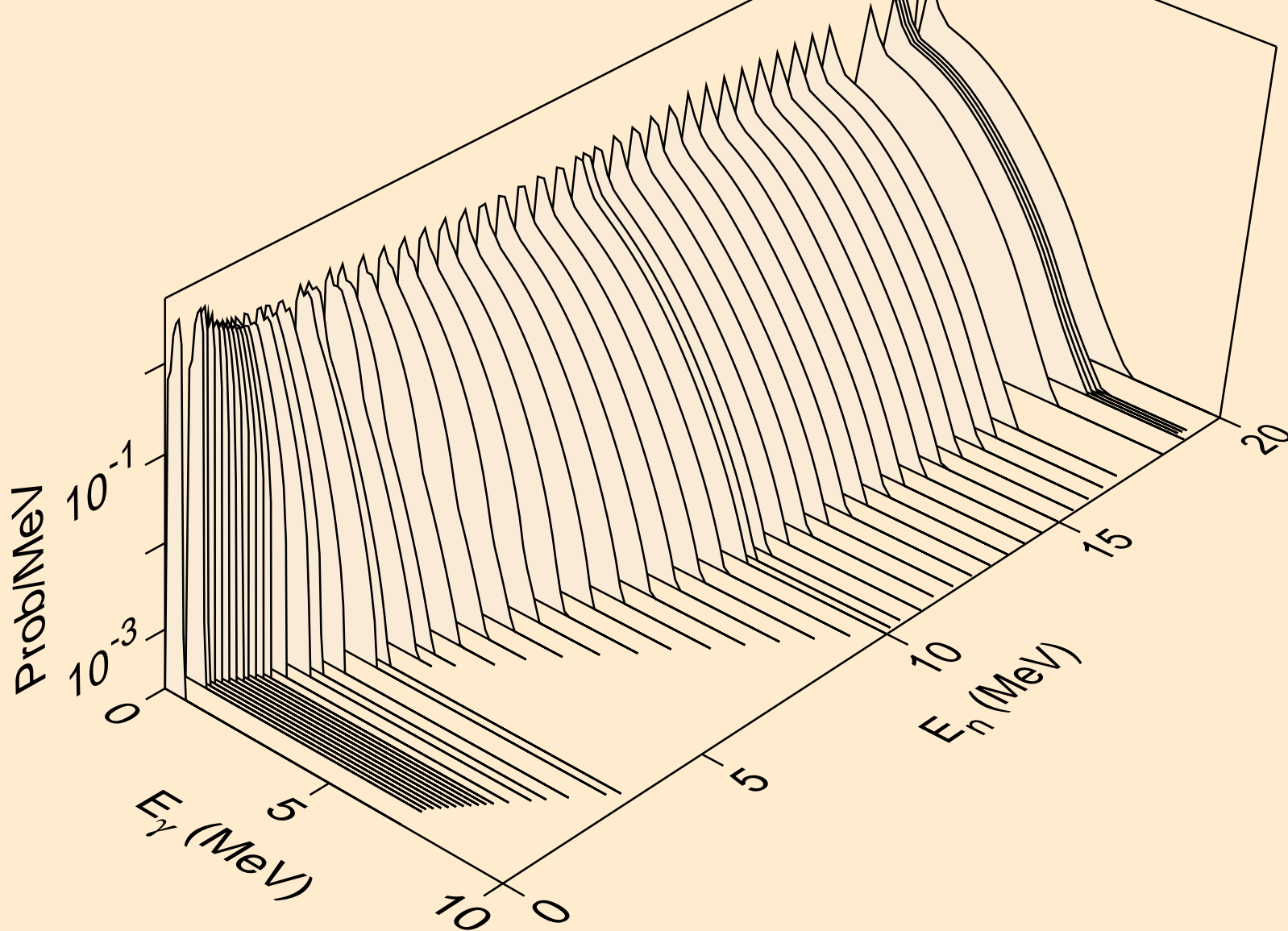

MAT=6431 ACE FILE PRODUCED AT NEA WITH NDEC
thermal capture photon spectrum

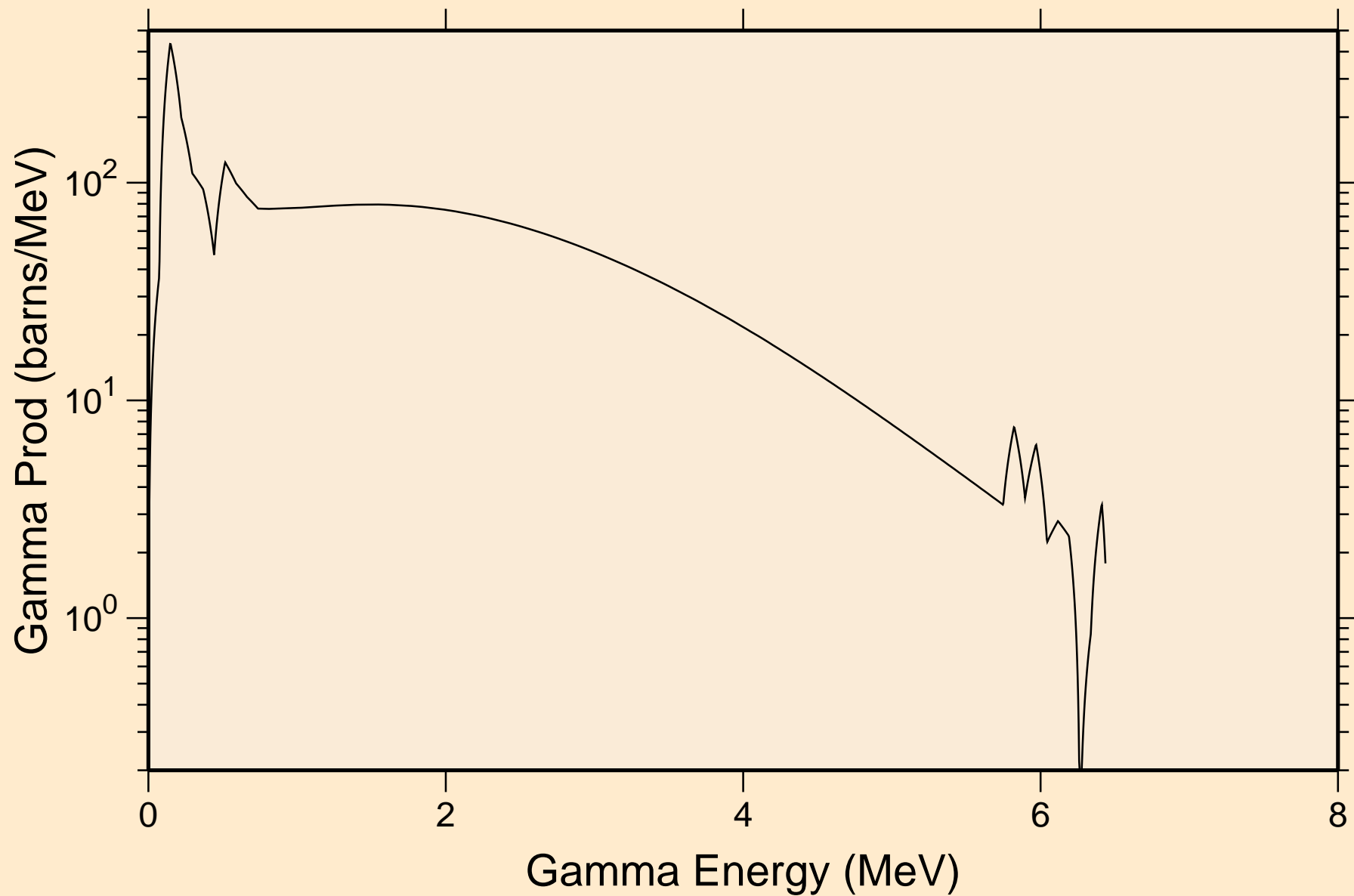

MAT=6431 ACE FILE PRODUCED AT NEA WITH NDEC
14 MeV photon spectrum

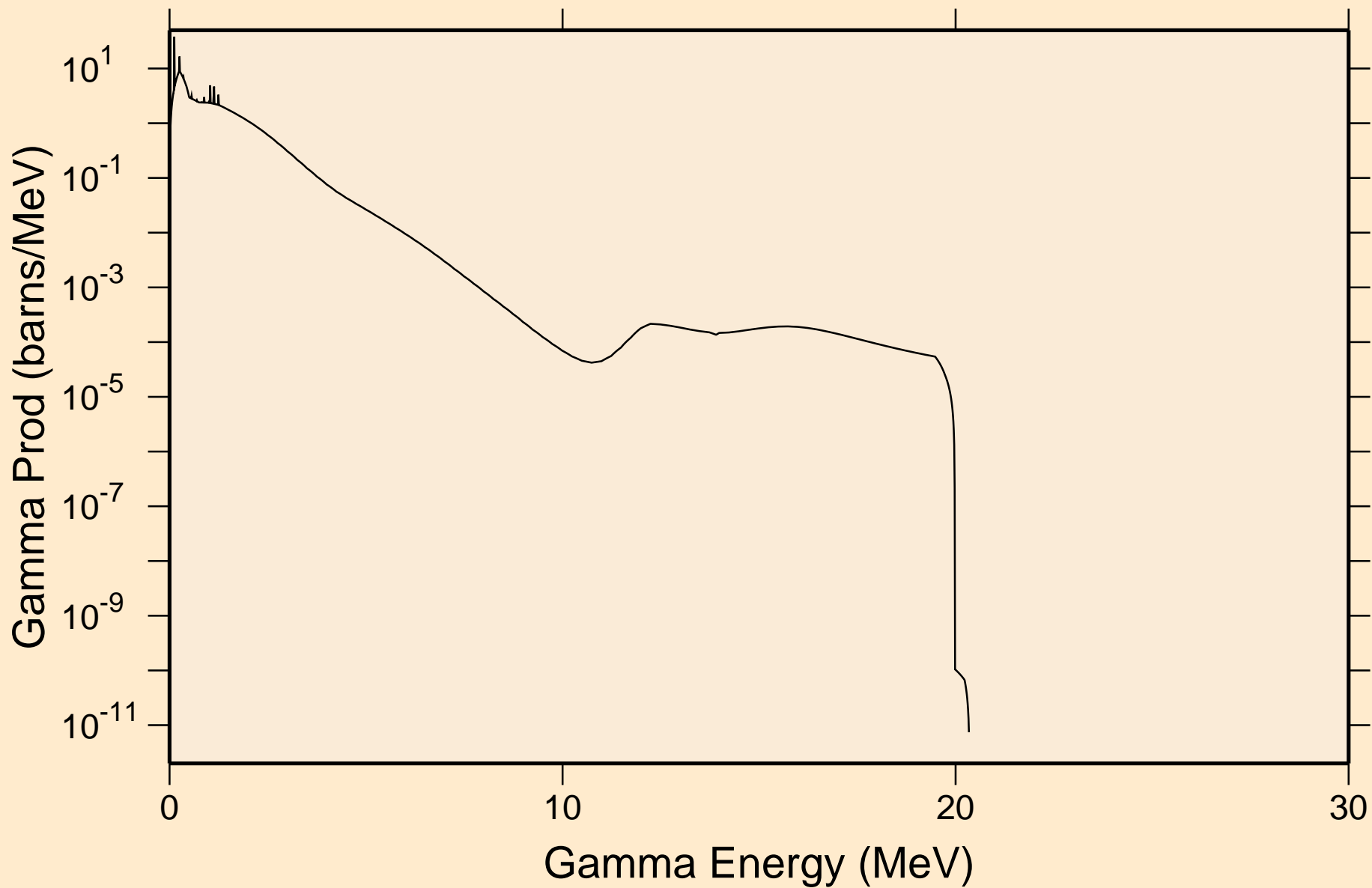

MAT=6431 ACE FILE PRODUCED AT NEA WITH NDEC
Particle heating contributions

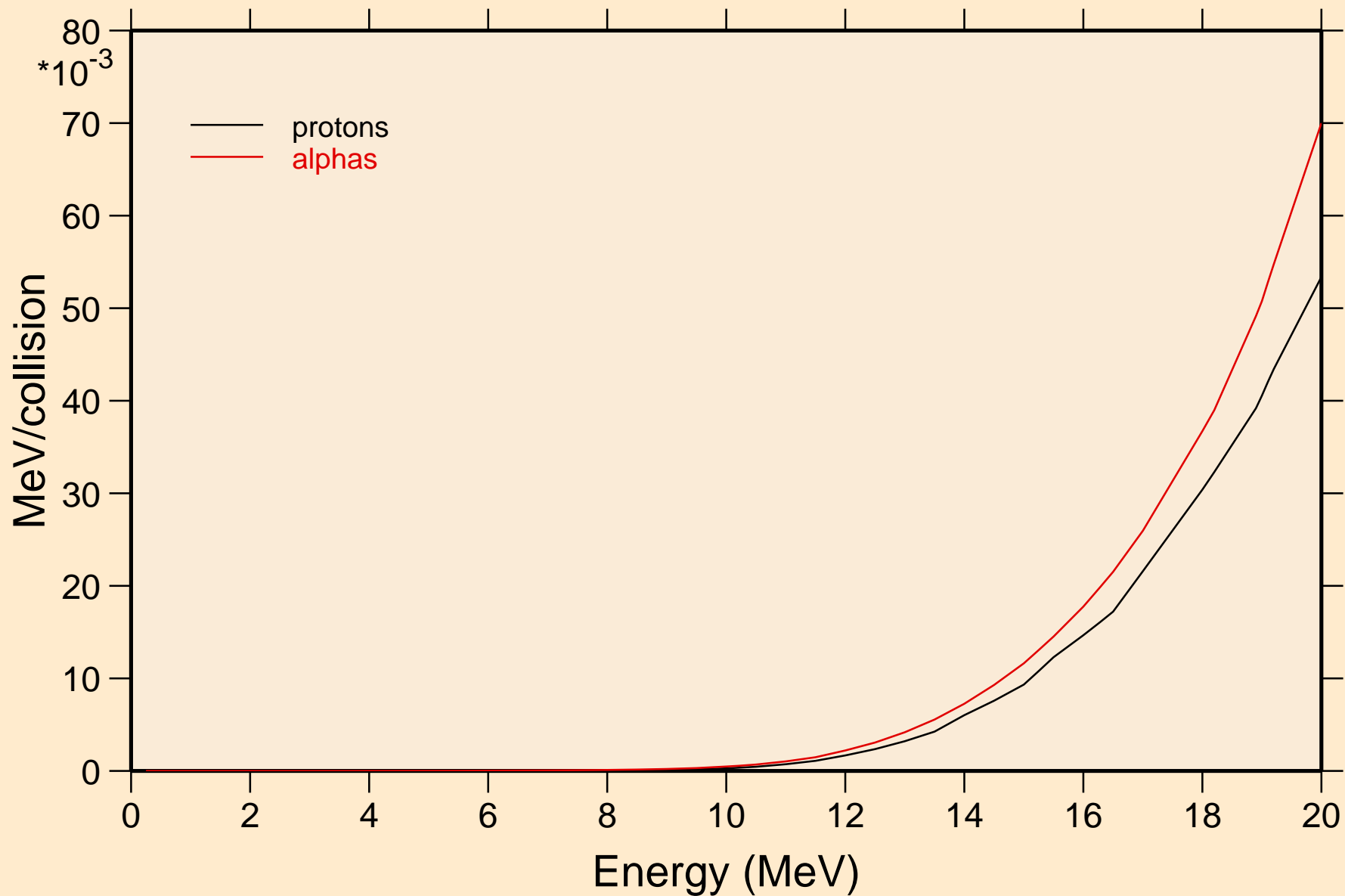

MAT=6431 ACE FILE PRODUCED AT NEA WITH NDEC
Recoil Heating

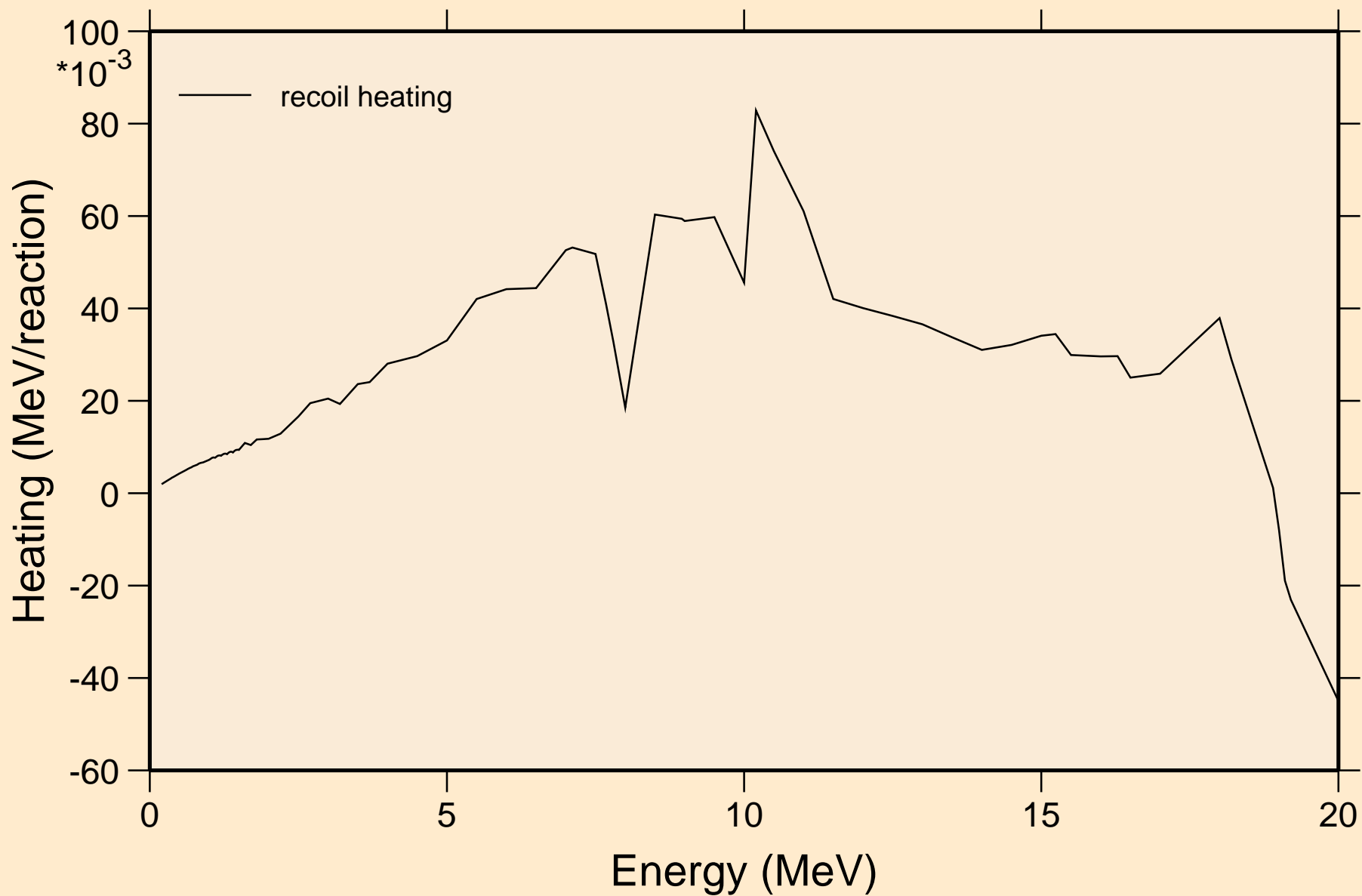

MAT=6431 ACE FILE PRODUCED AT NEA WITH NDEC
Particle production cross sections

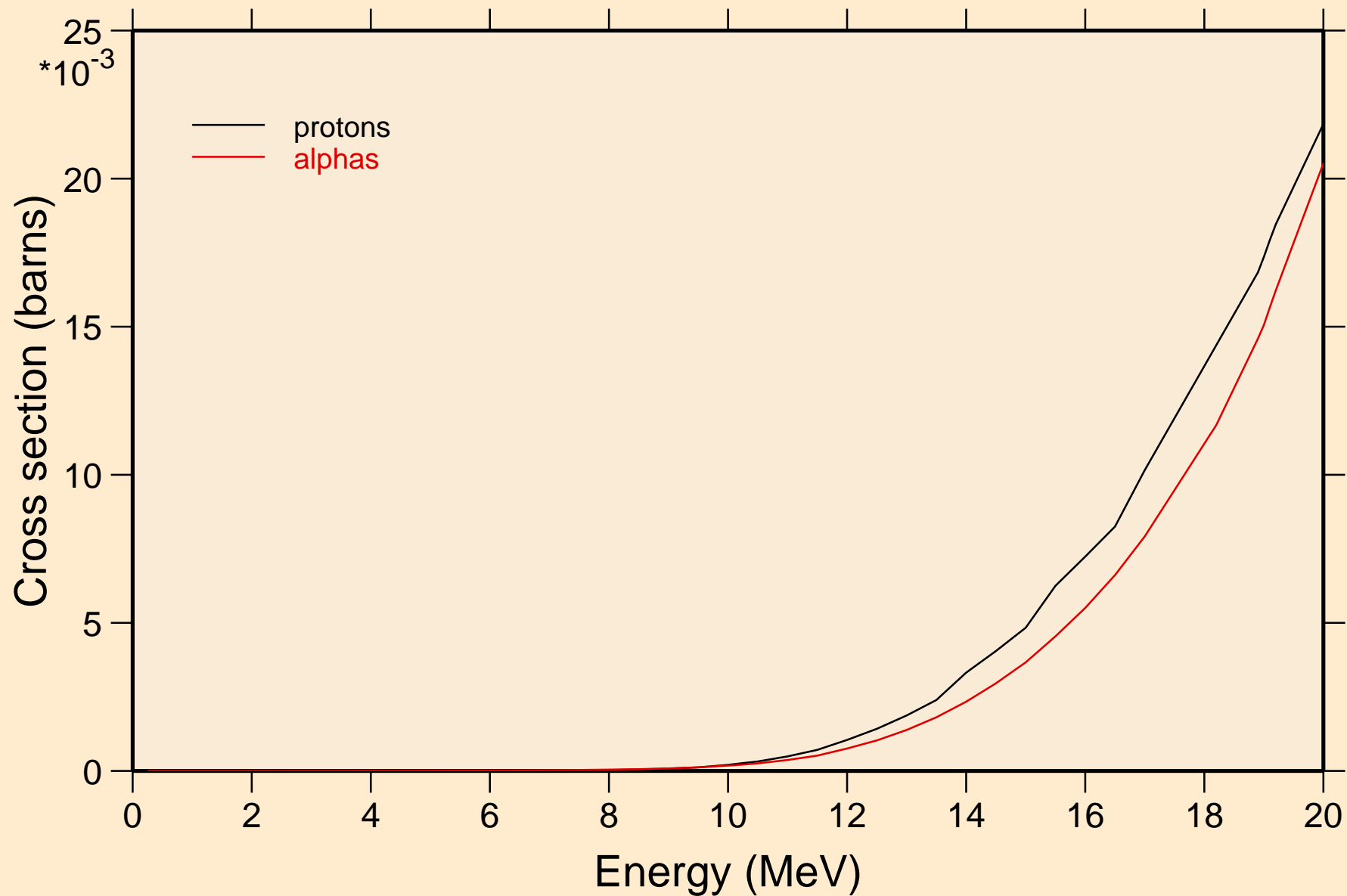

MAT=6431 ACE FILE PRODUCED AT NEA WITH NDEC
protons from (n,n*)p

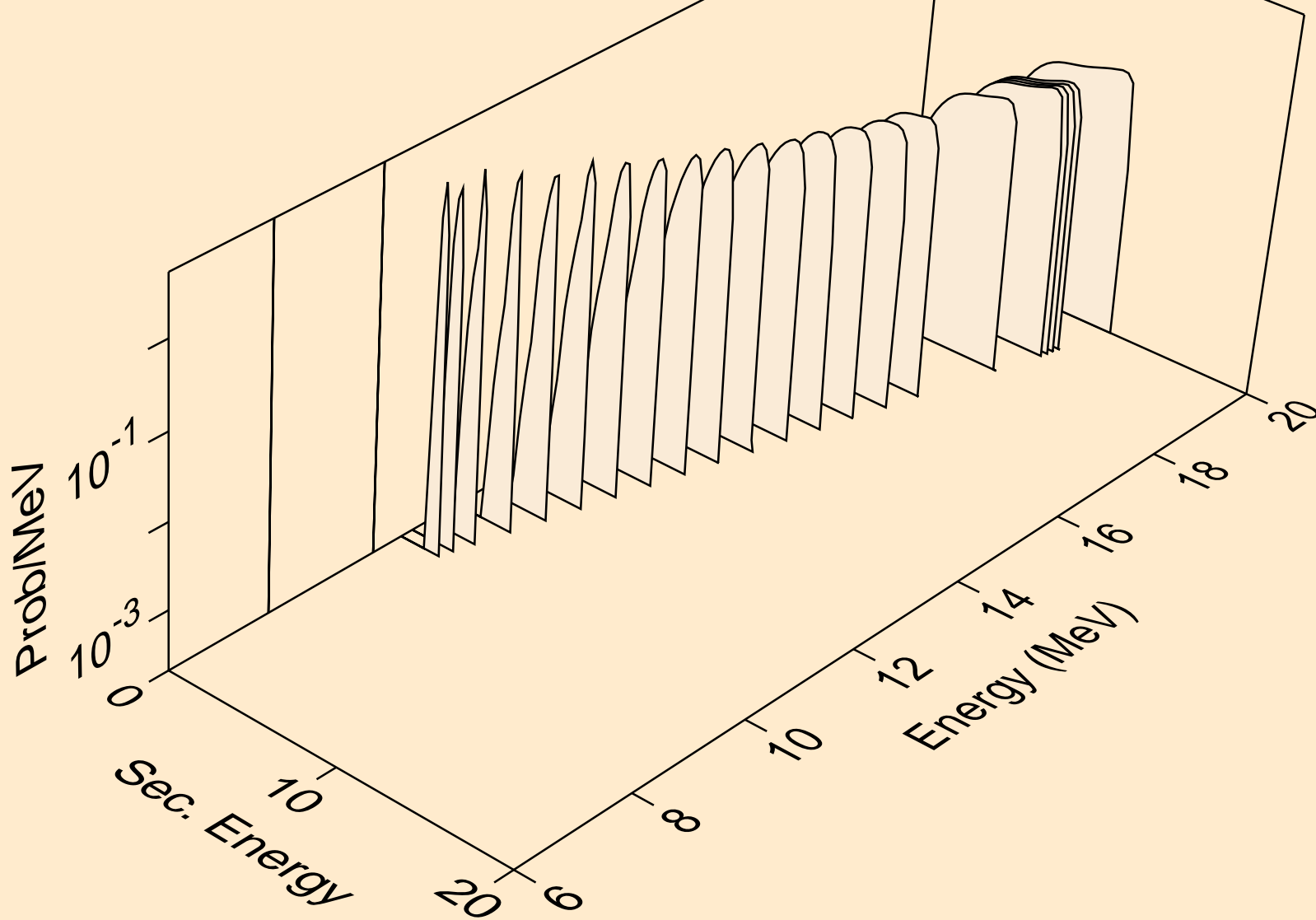

MAT=6431 ACE FILE PRODUCED AT NEA WITH NDEC
protons from (n,2np)

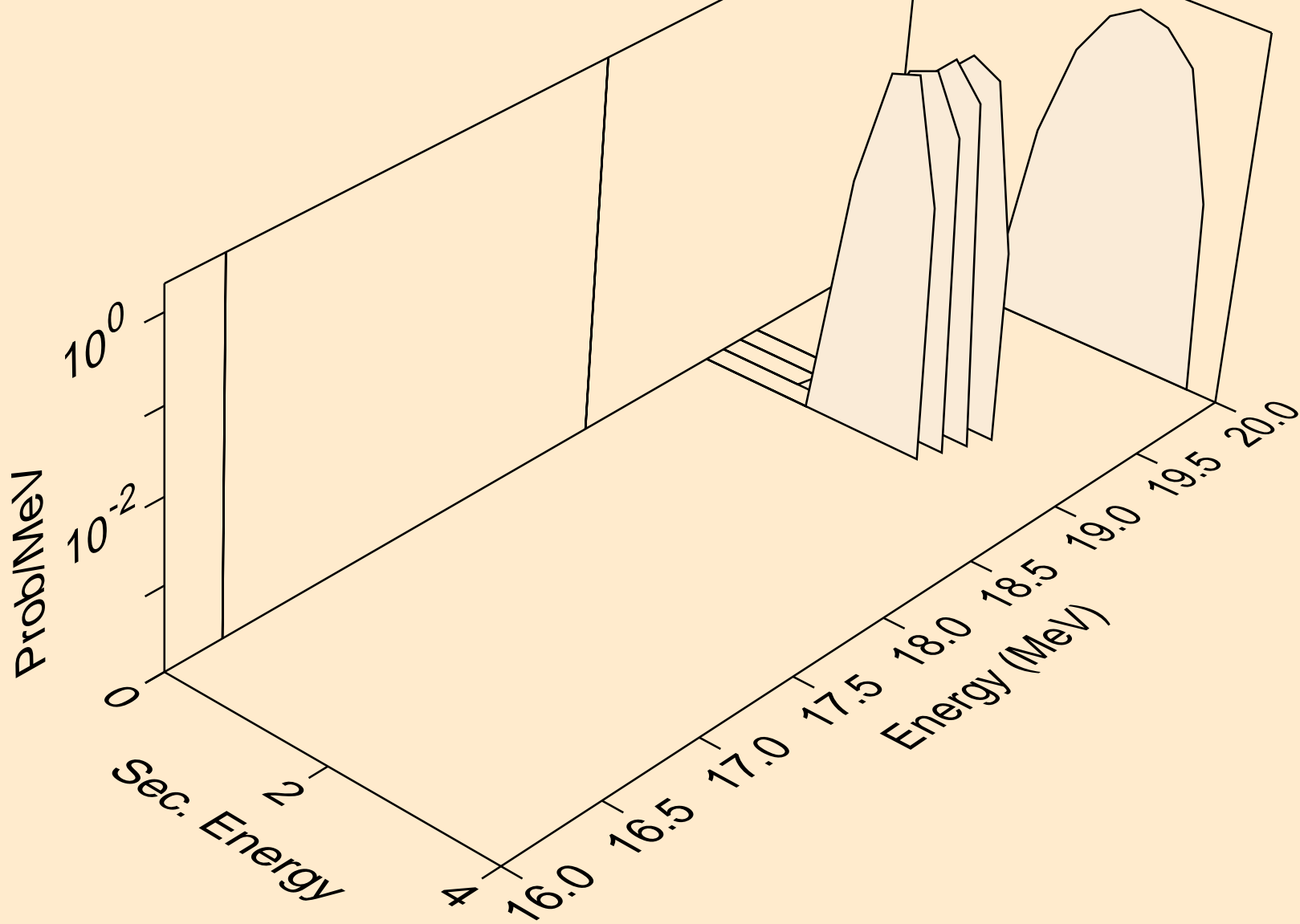

MAT=6431 ACE FILE PRODUCED AT NEA WITH NDEC
angular distribution for (n,p*0) proton

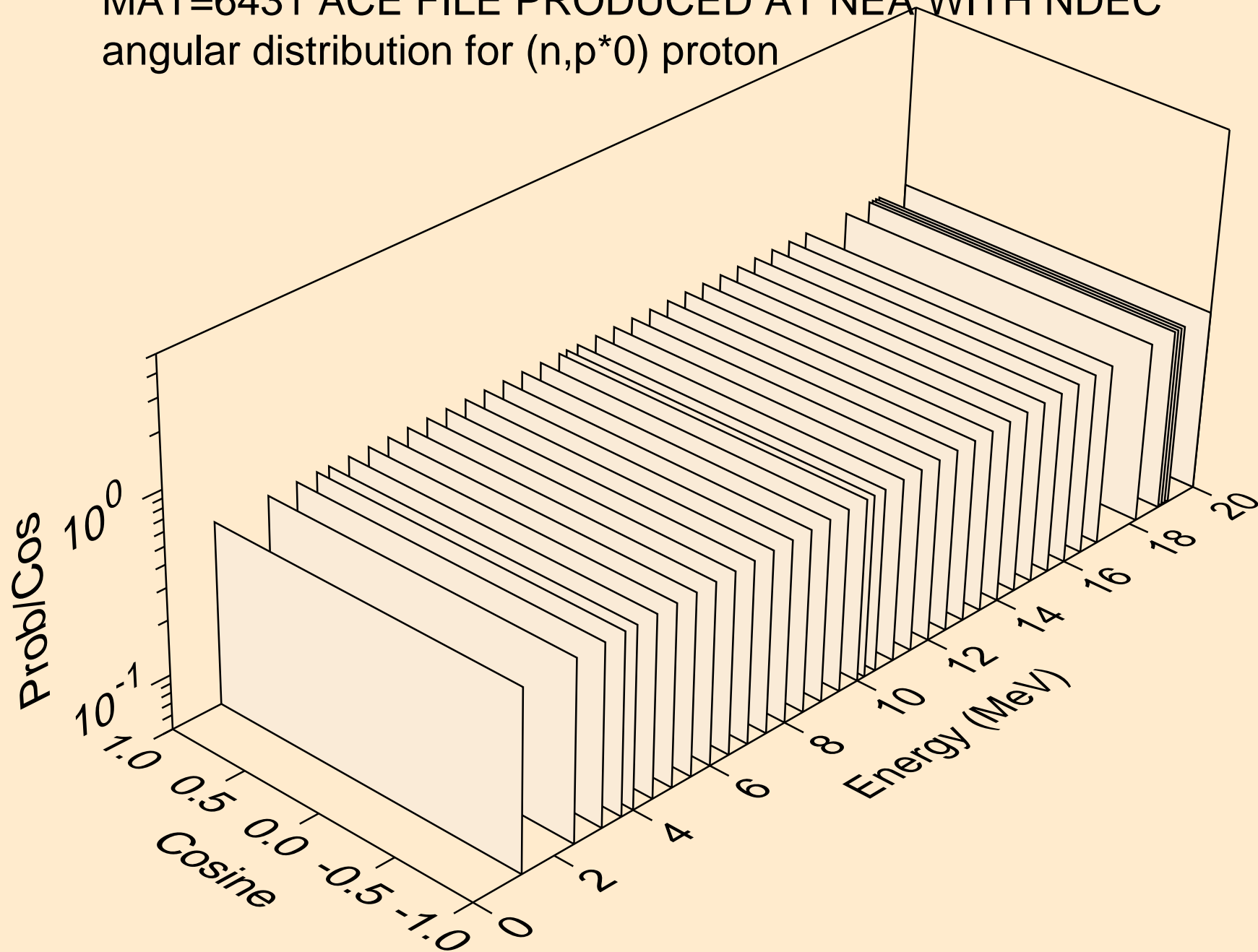

MAT=6431 ACE FILE PRODUCED AT NEA WITH NDEC
angular distribution for (n,p*1) proton

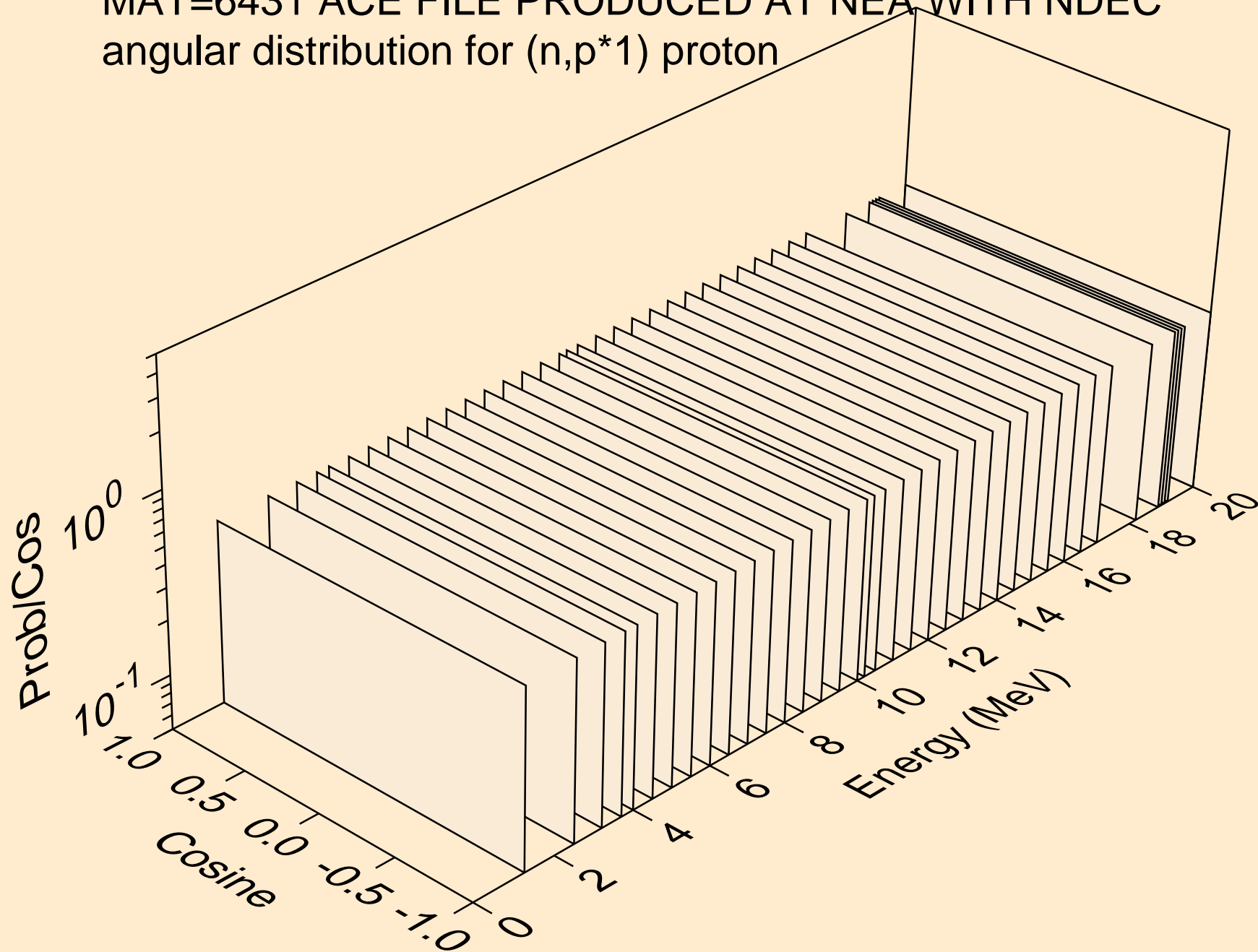

MAT=6431 ACE FILE PRODUCED AT NEA WITH NDEC
angular distribution for (n,p*2) proton

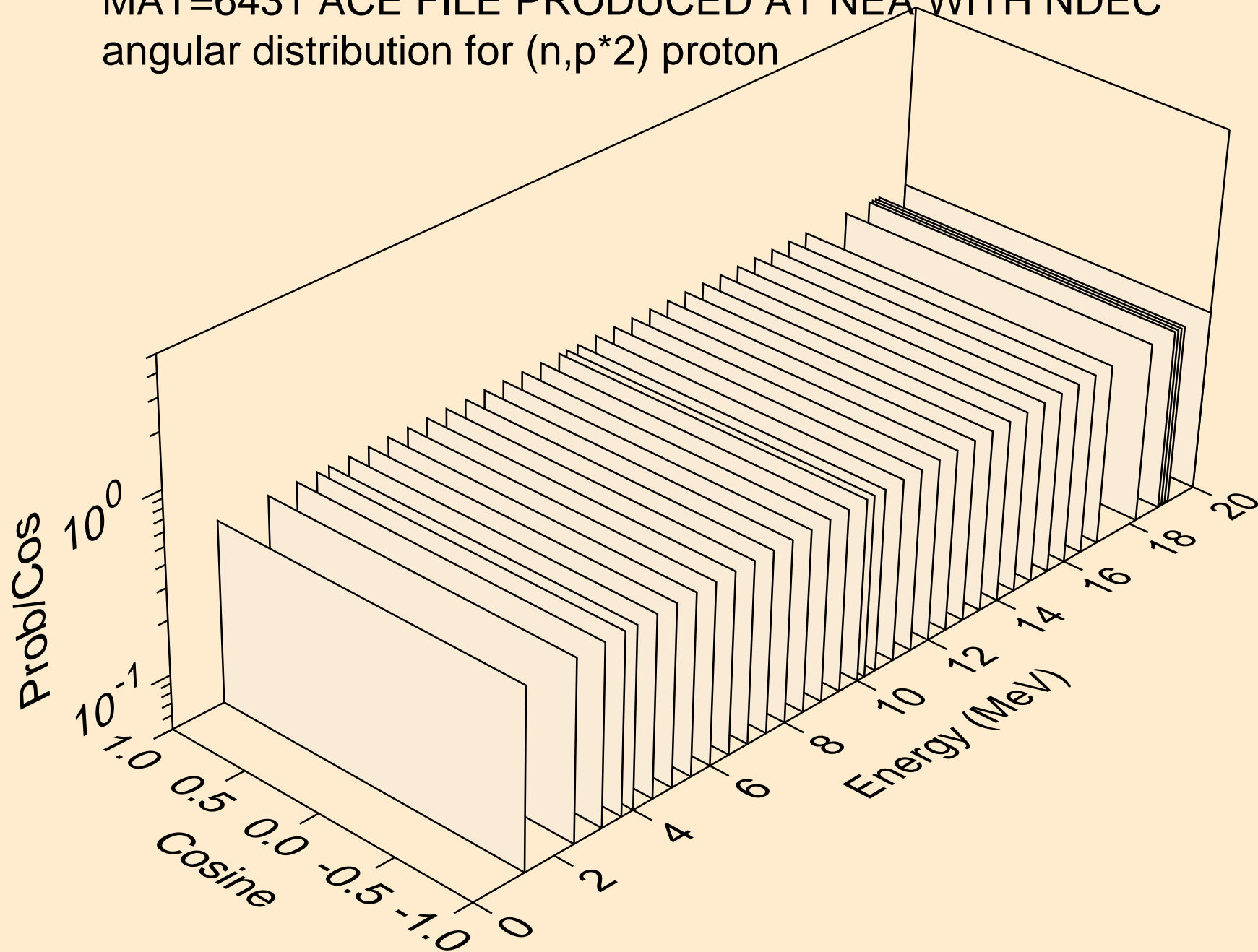

MAT=6431 ACE FILE PRODUCED AT NEA WITH NDEC
angular distribution for (n,p*3) proton

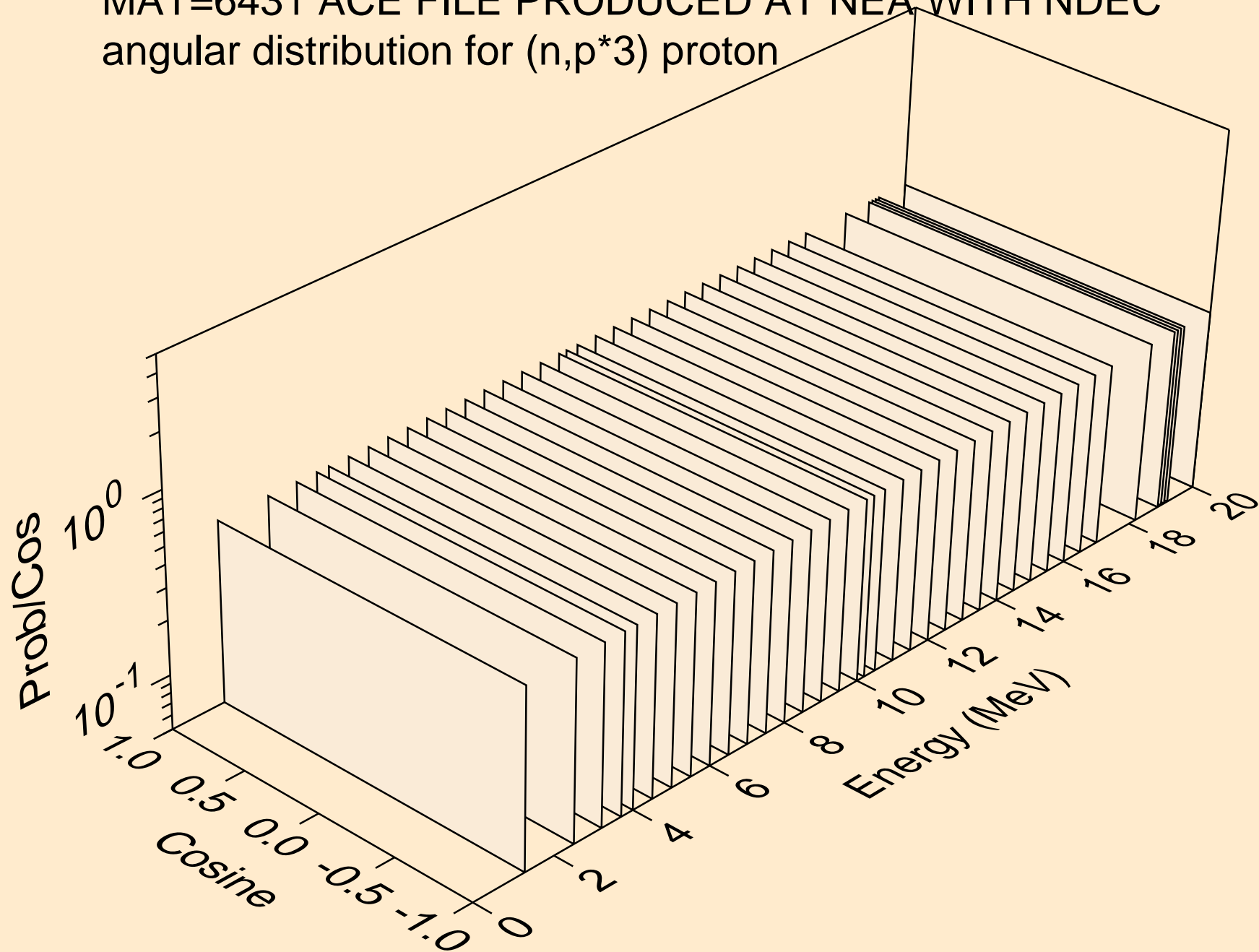

MAT=6431 ACE FILE PRODUCED AT NEA WITH NDEC
angular distribution for (n,p*4) proton

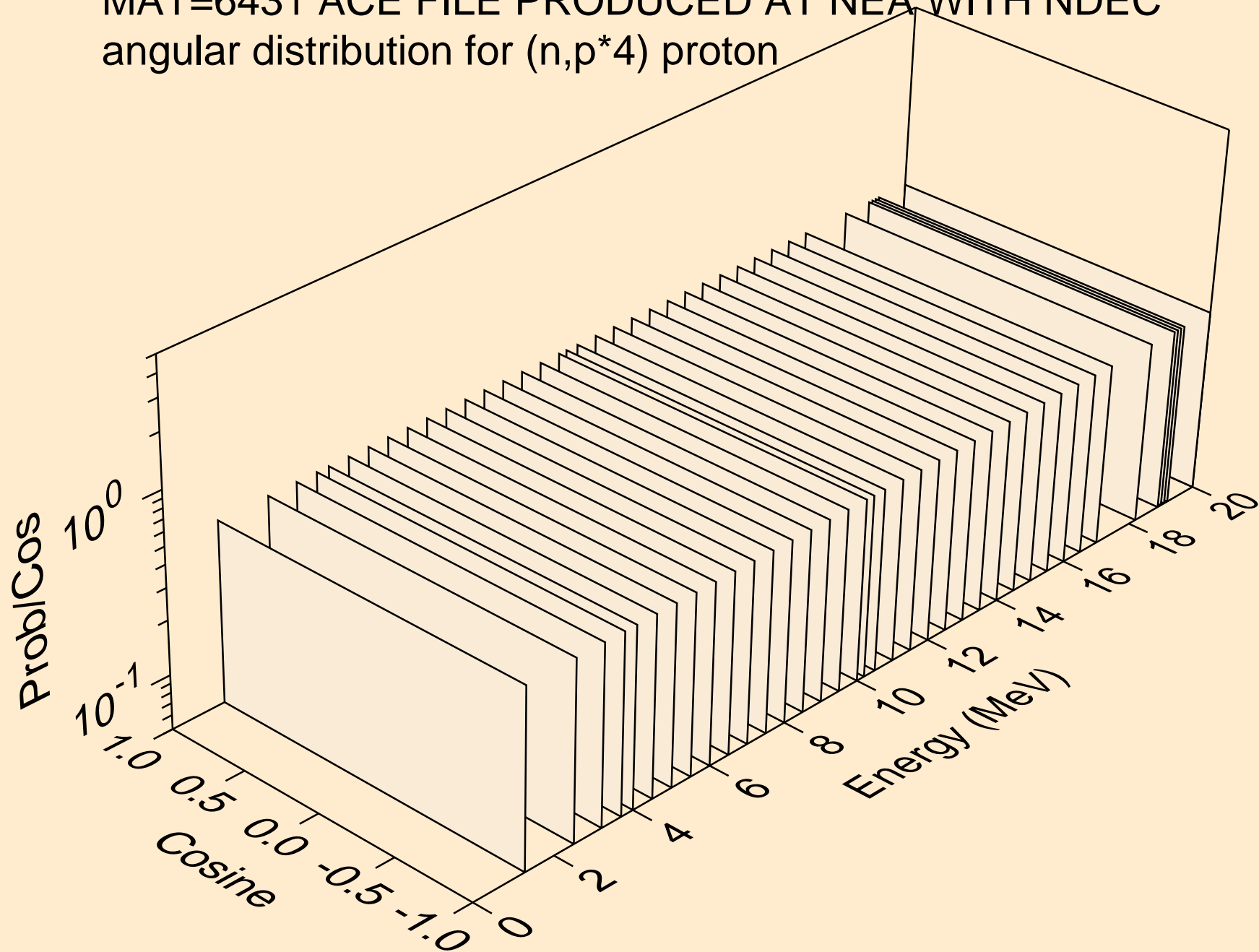

MAT=6431 ACE FILE PRODUCED AT NEA WITH NDEC
angular distribution for (n,p*5) proton

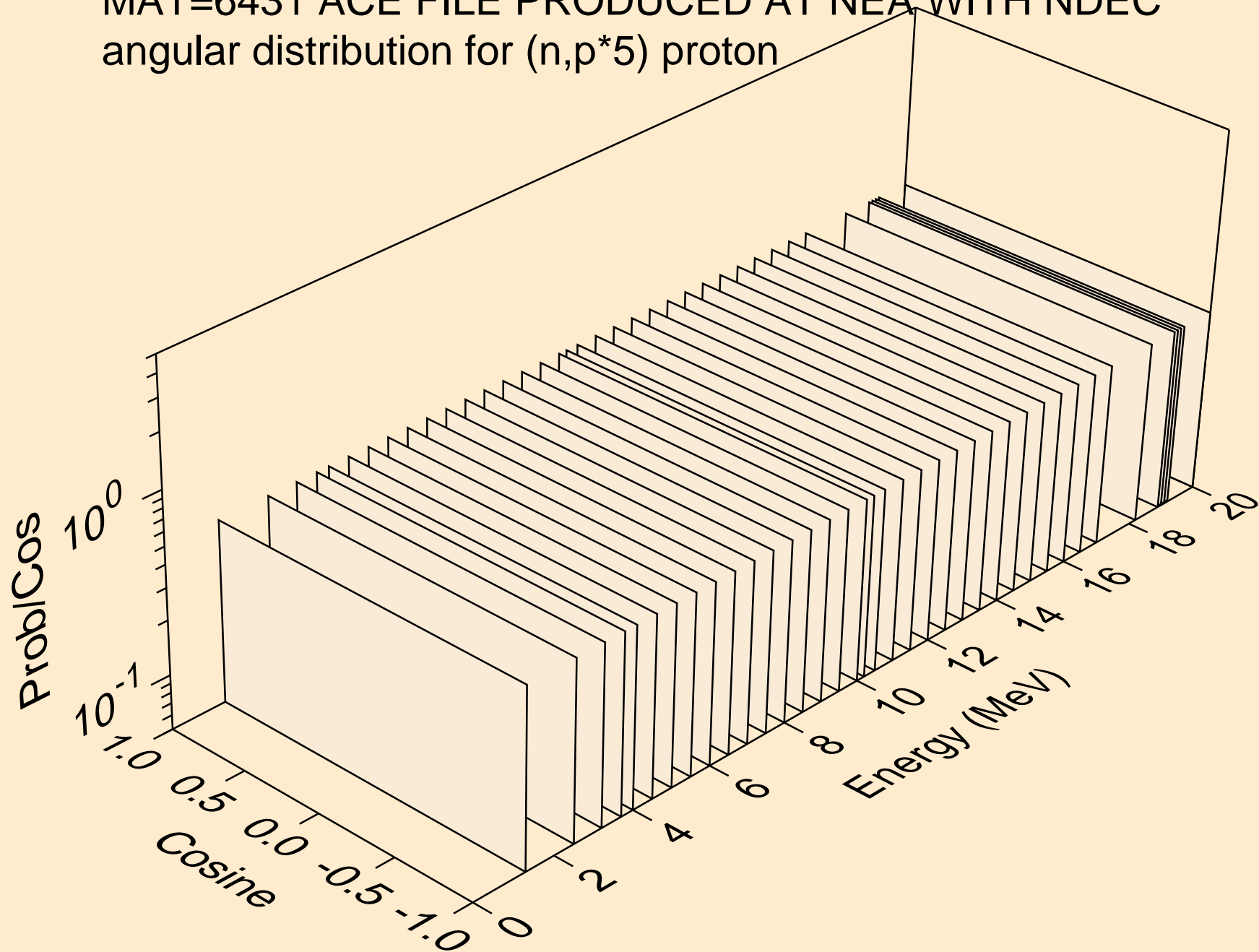

MAT=6431 ACE FILE PRODUCED AT NEA WITH NDEC
angular distribution for (n,p*6) proton

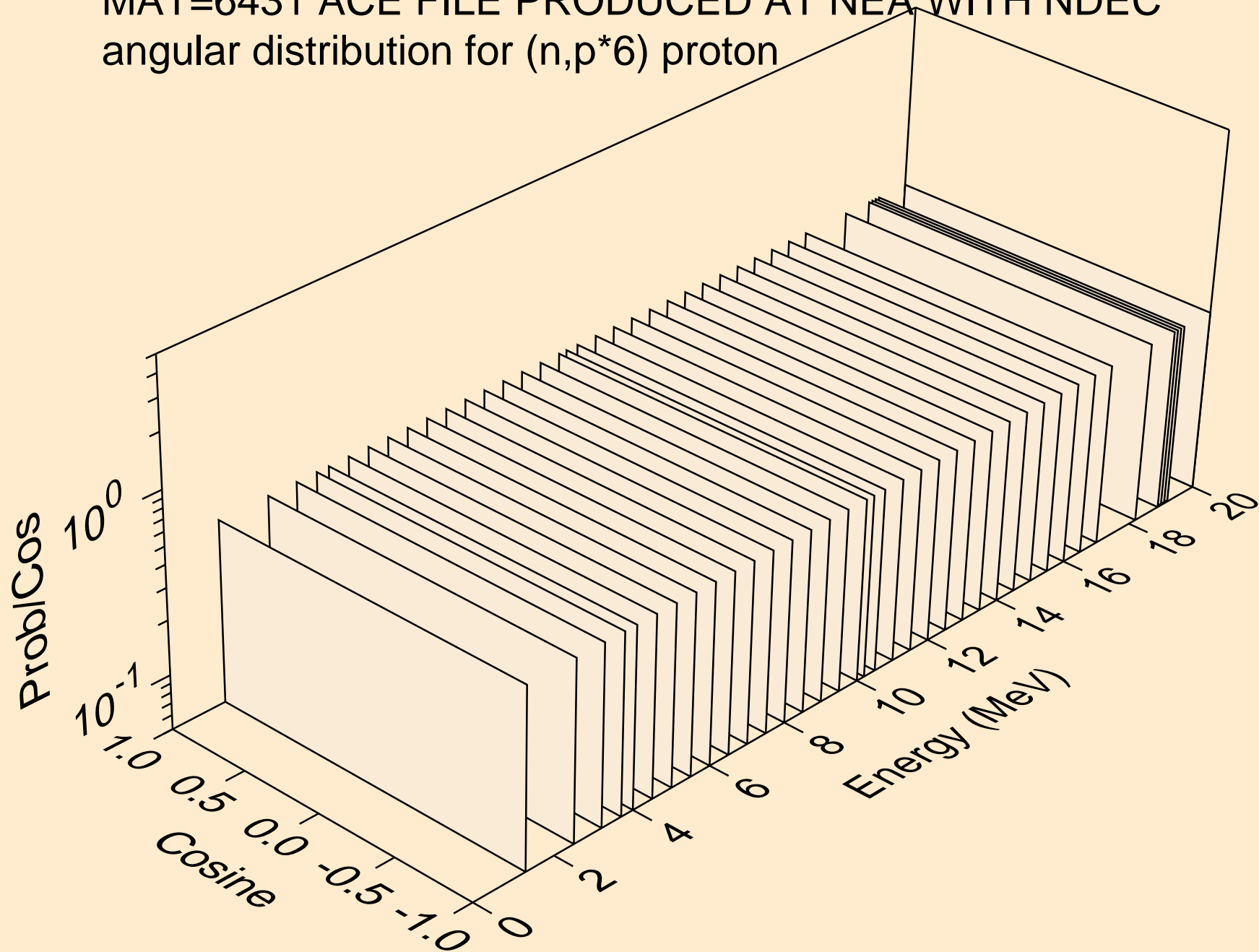

MAT=6431 ACE FILE PRODUCED AT NEA WITH NDEC
angular distribution for (n,p*7) proton

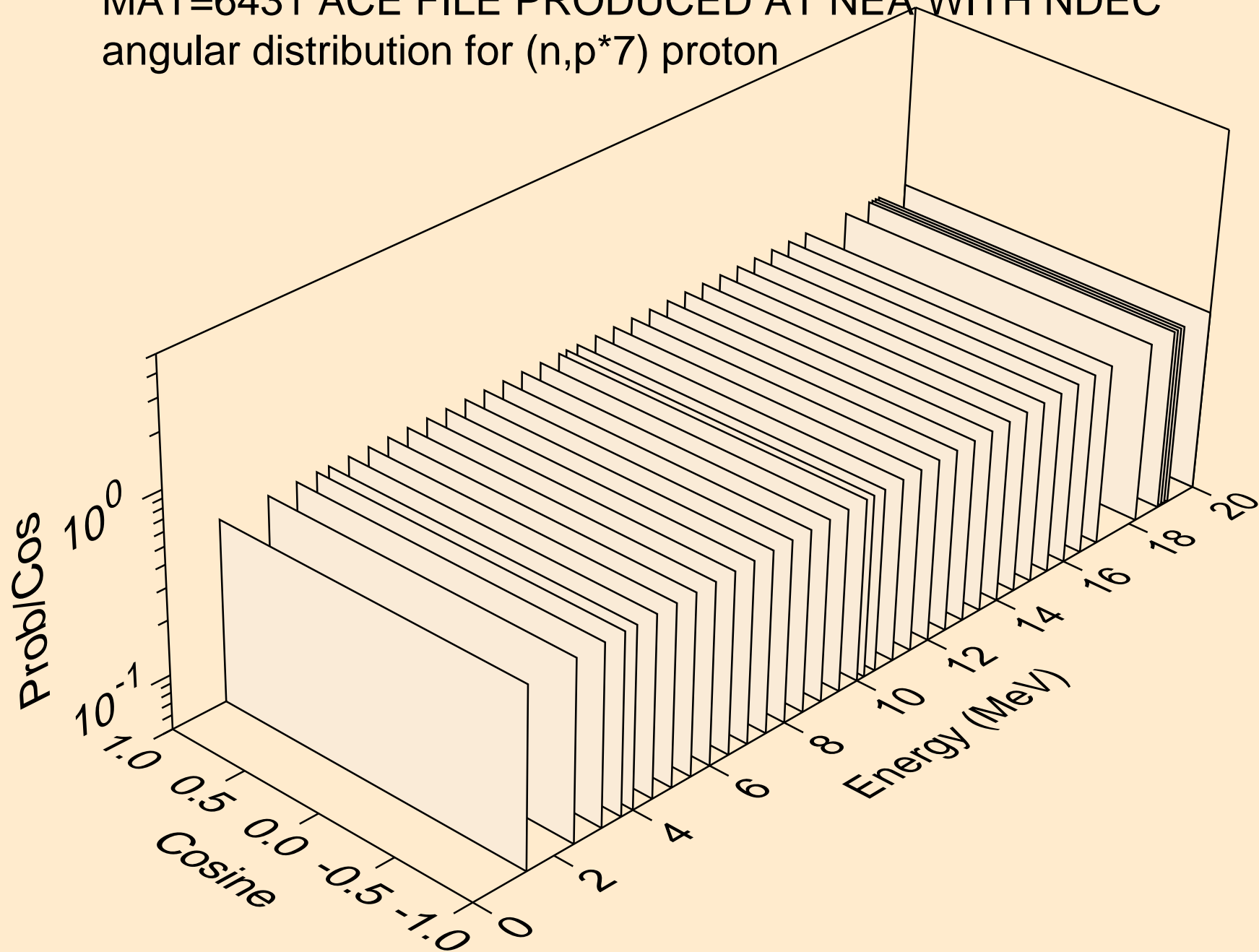

MAT=6431 ACE FILE PRODUCED AT NEA WITH NDEC
angular distribution for (n,p*8) proton

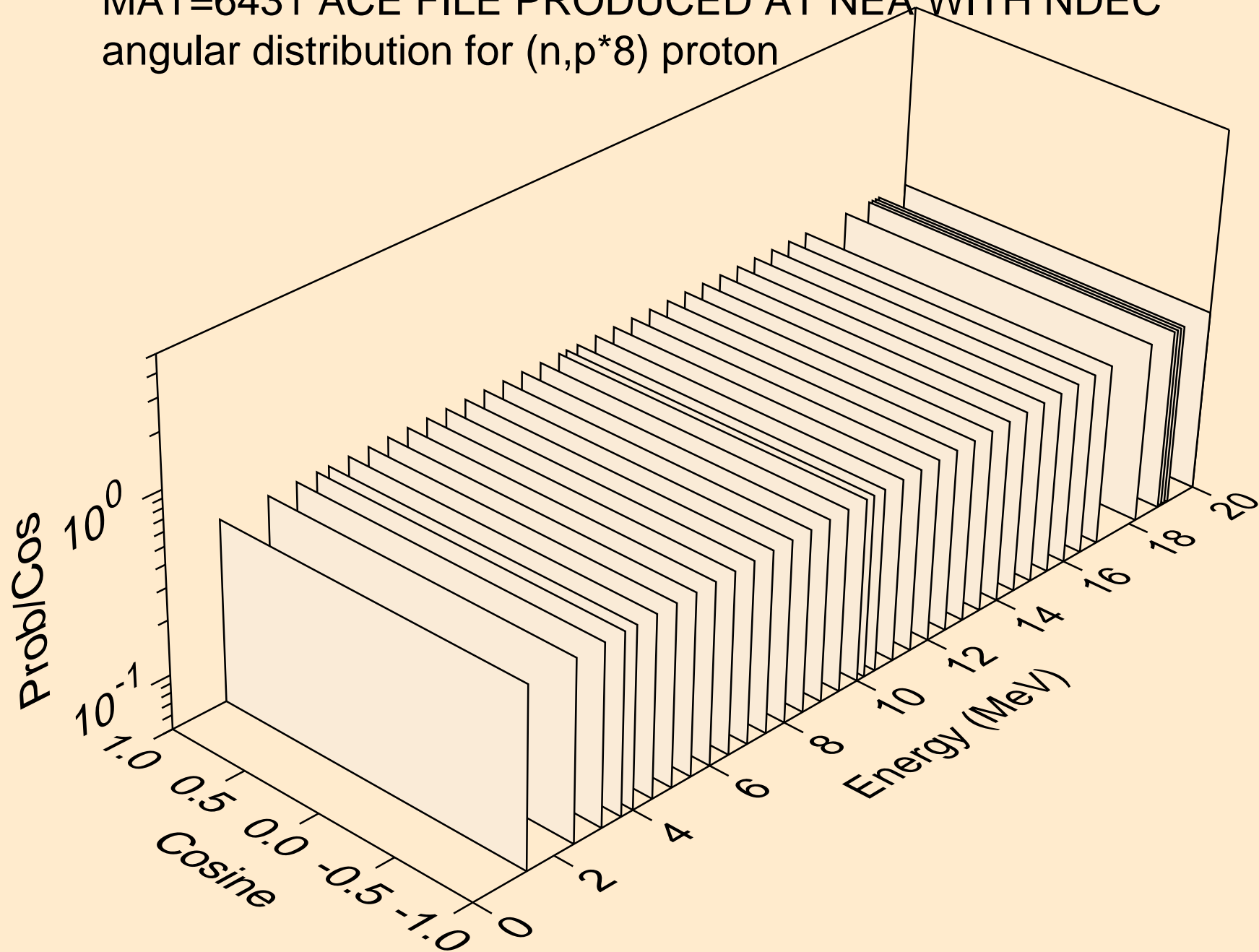

MAT=6431 ACE FILE PRODUCED AT NEA WITH NDEC
angular distribution for (n,p*9) proton

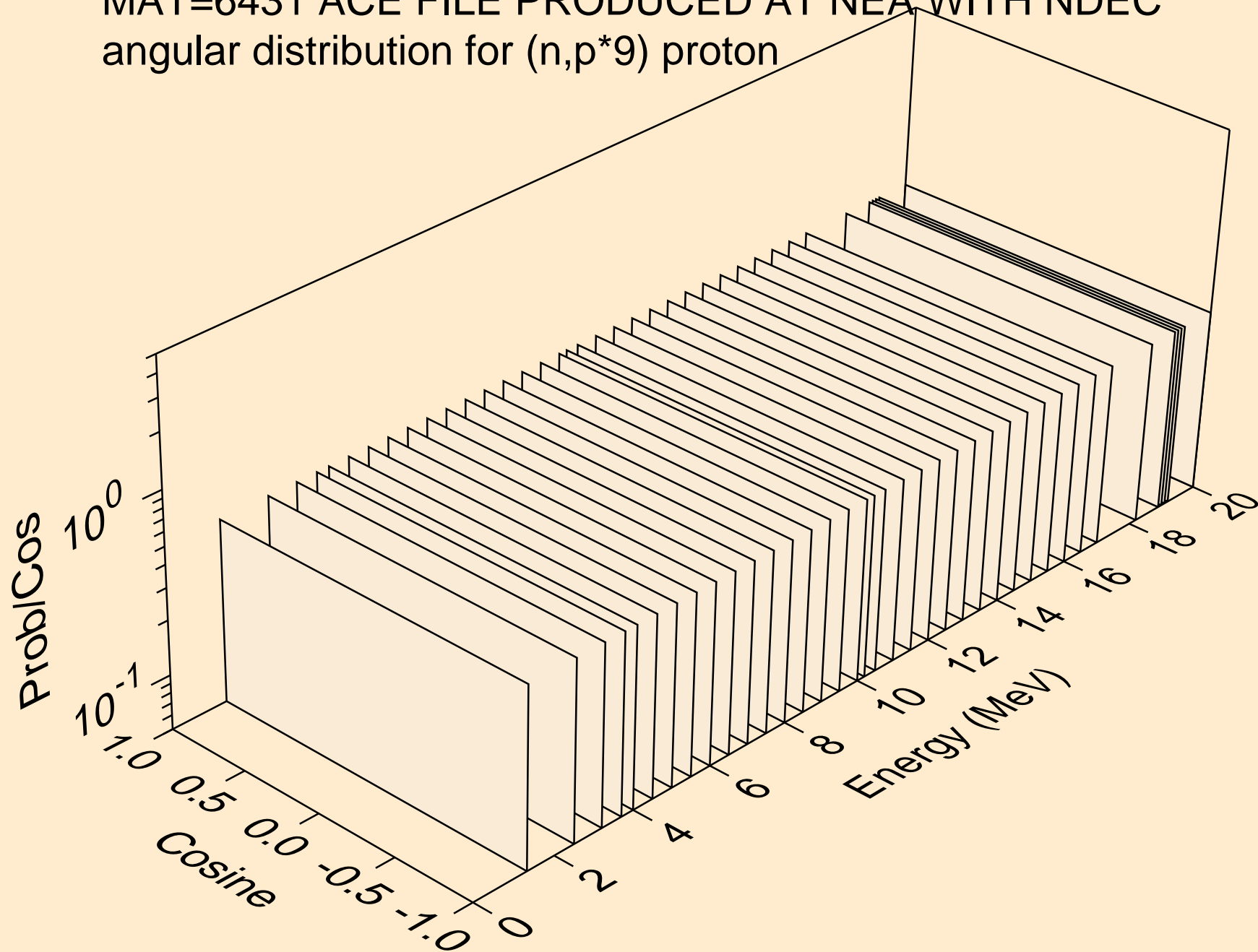

MAT=6431 ACE FILE PRODUCED AT NEA WITH NDEC
angular distribution for (n,p*10) proton

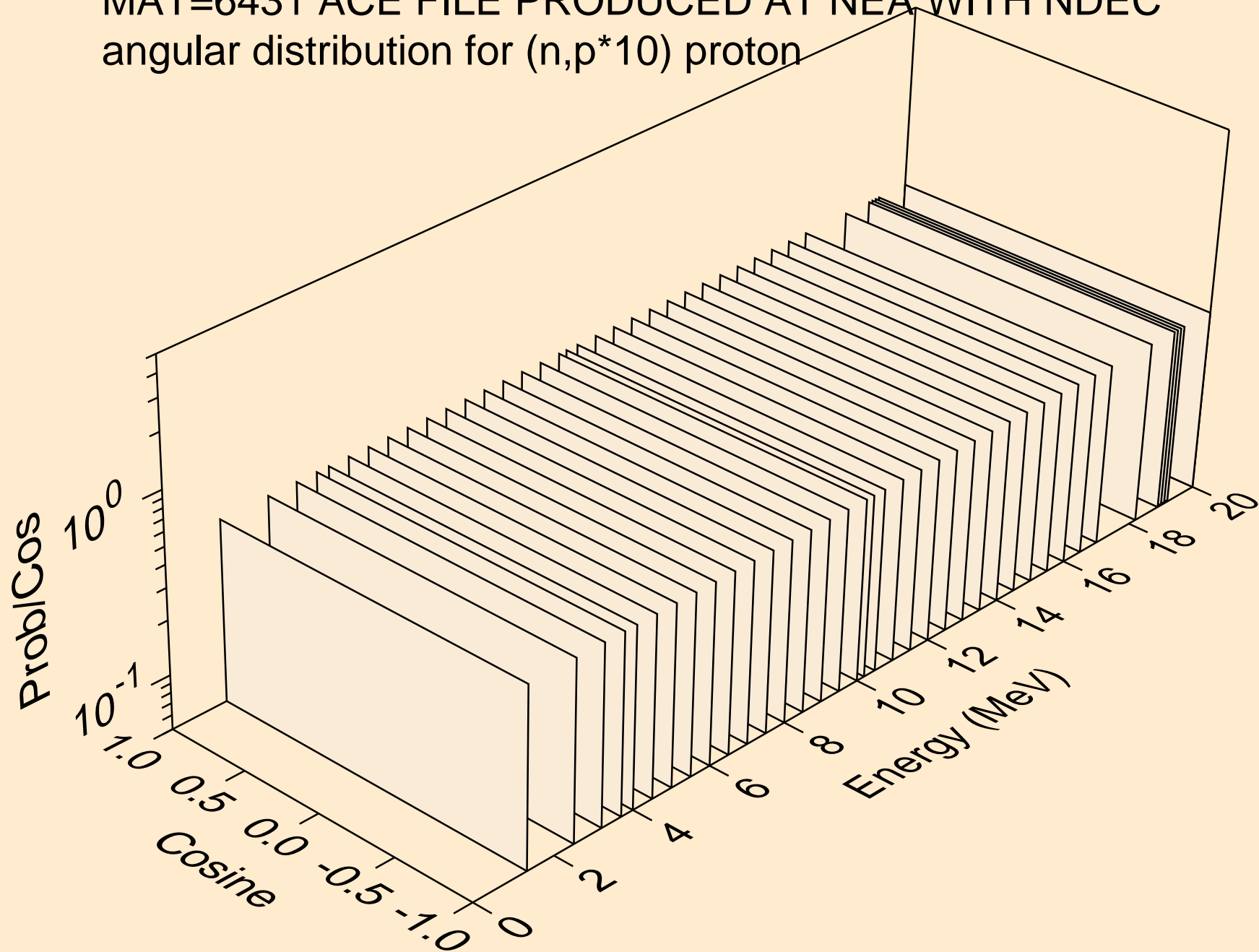

MAT=6431 ACE FILE PRODUCED AT NEA WITH NDEC
angular distribution for (n,p*11) proton

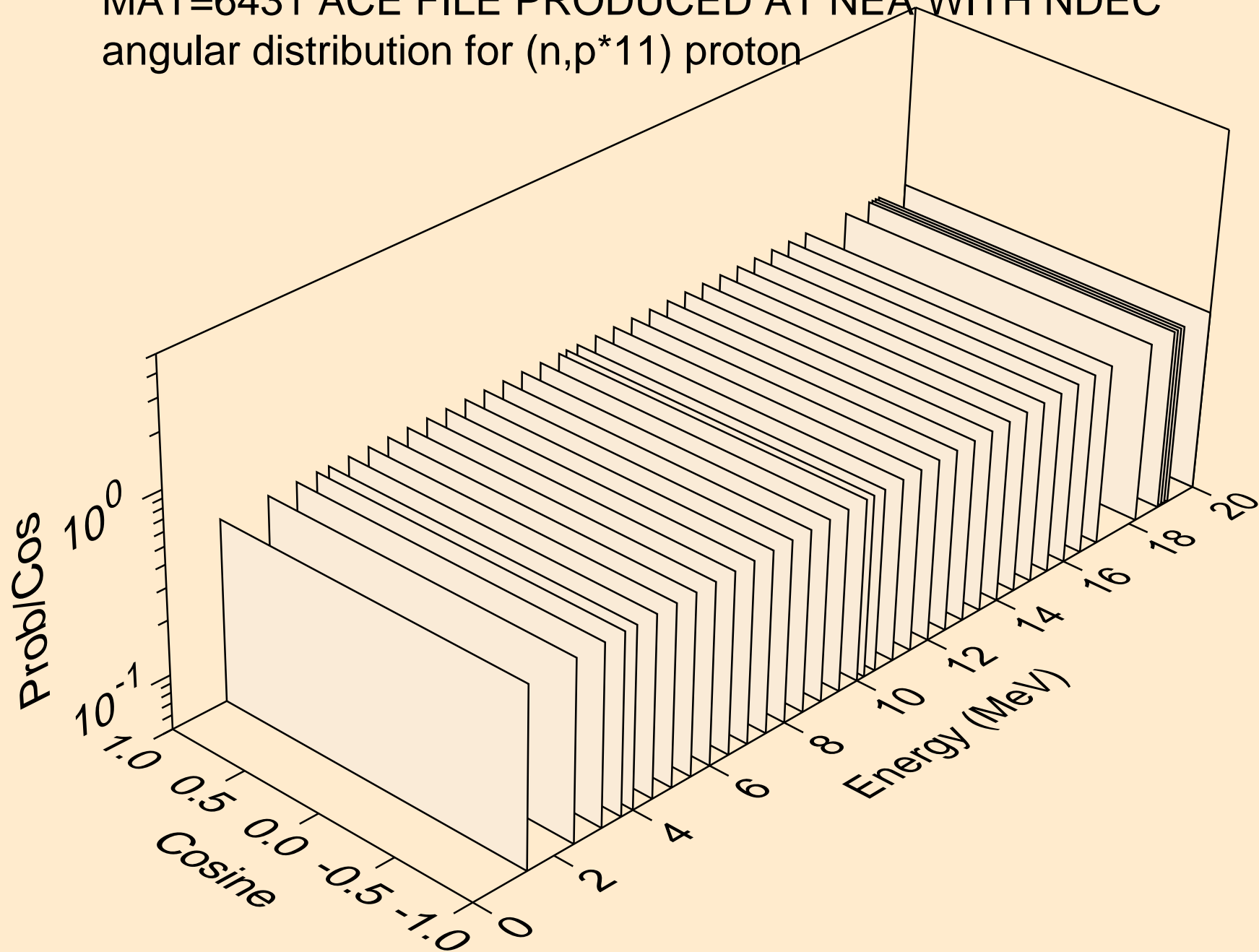

MAT=6431 ACE FILE PRODUCED AT NEA WITH NDEC
angular distribution for (n,p*12) proton

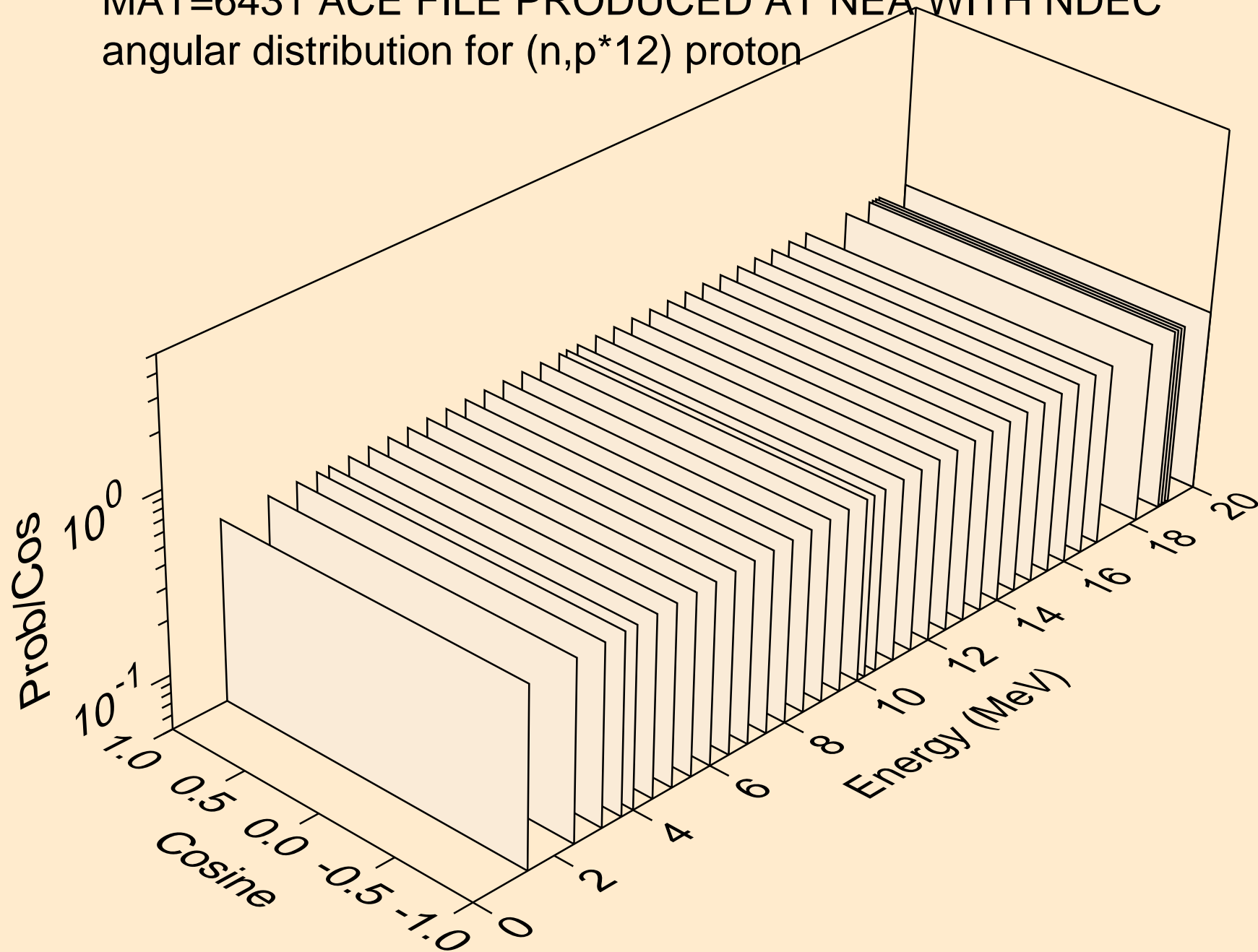

MAT=6431 ACE FILE PRODUCED AT NEA WITH NDEC
angular distribution for (n,p*13) proton

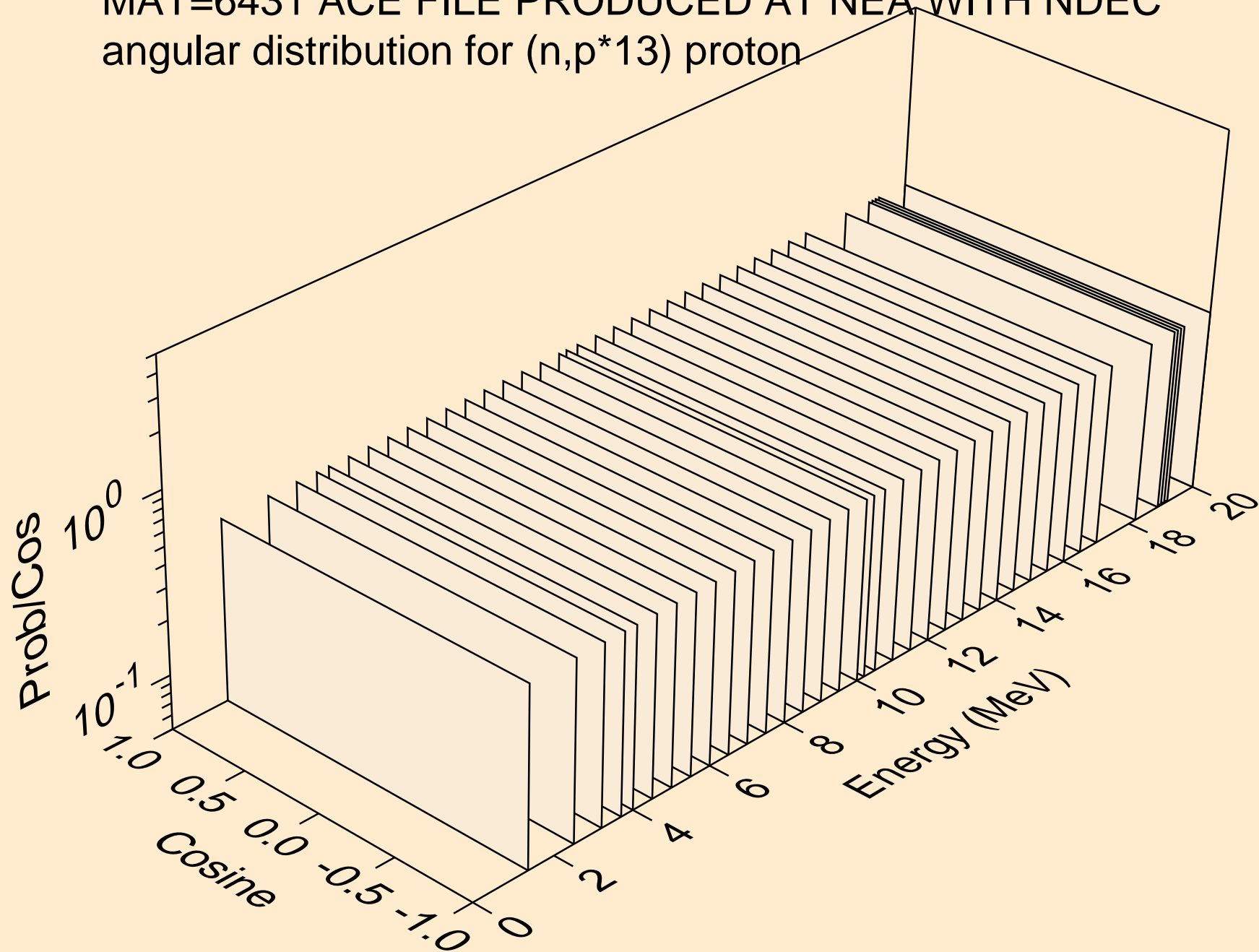

MAT=6431 ACE FILE PRODUCED AT NEA WITH NDEC
angular distribution for (n,p*14) proton

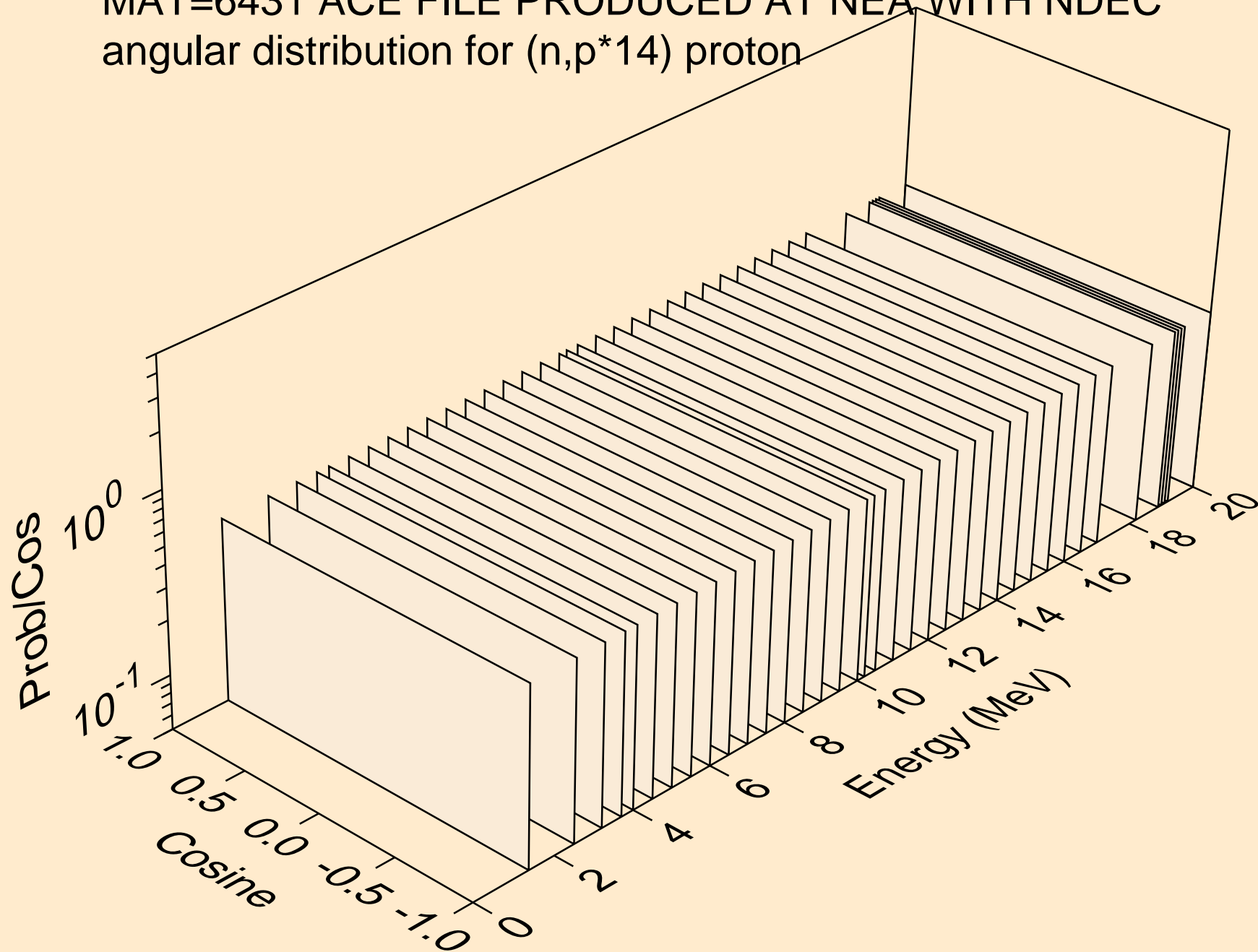

MAT=6431 ACE FILE PRODUCED AT NEA WITH NDEC
angular distribution for (n,p*15) proton

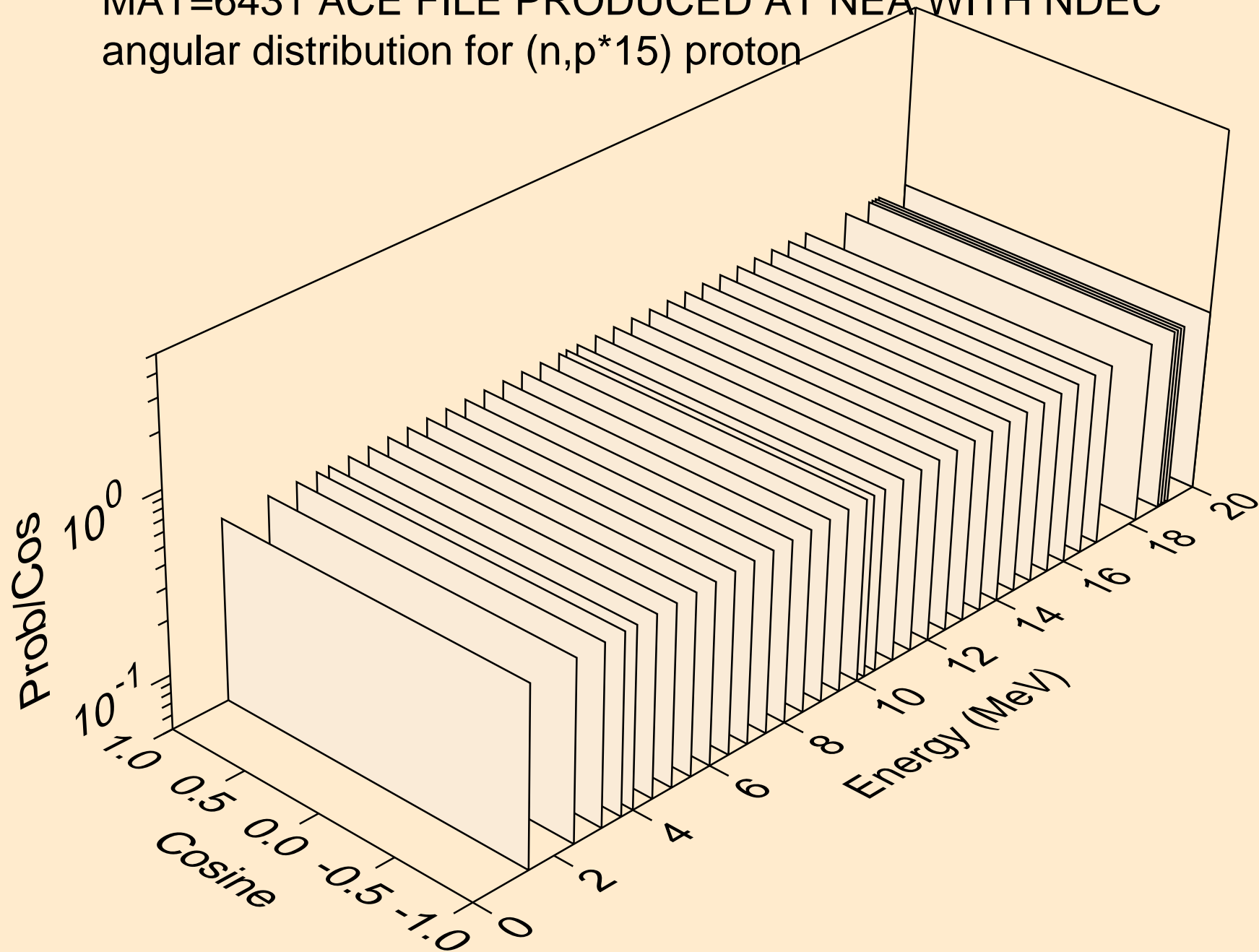

MAT=6431 ACE FILE PRODUCED AT NEA WITH NDEC
angular distribution for (n,p*16) proton

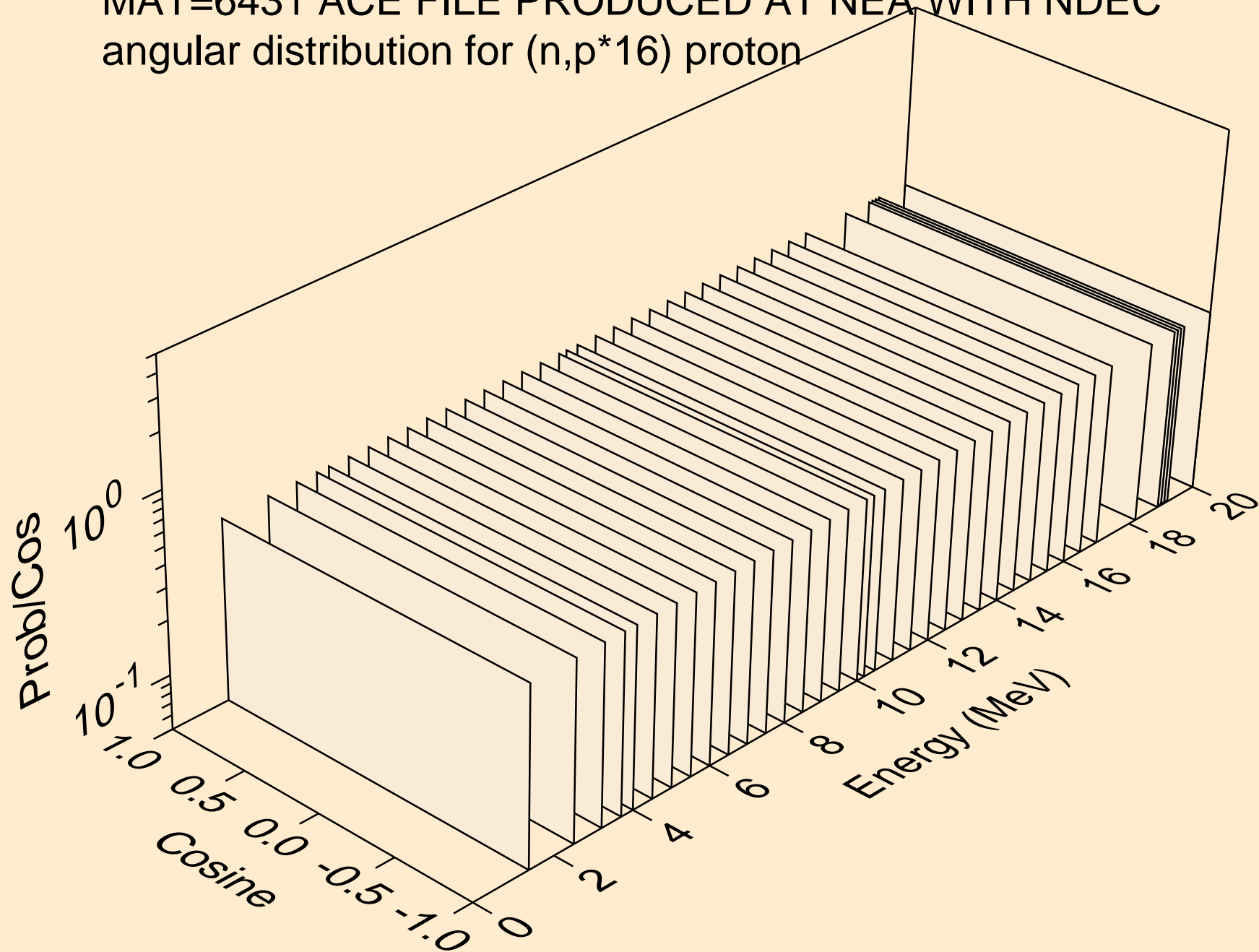

MAT=6431 ACE FILE PRODUCED AT NEA WITH NDEC
angular distribution for (n,p*17) proton

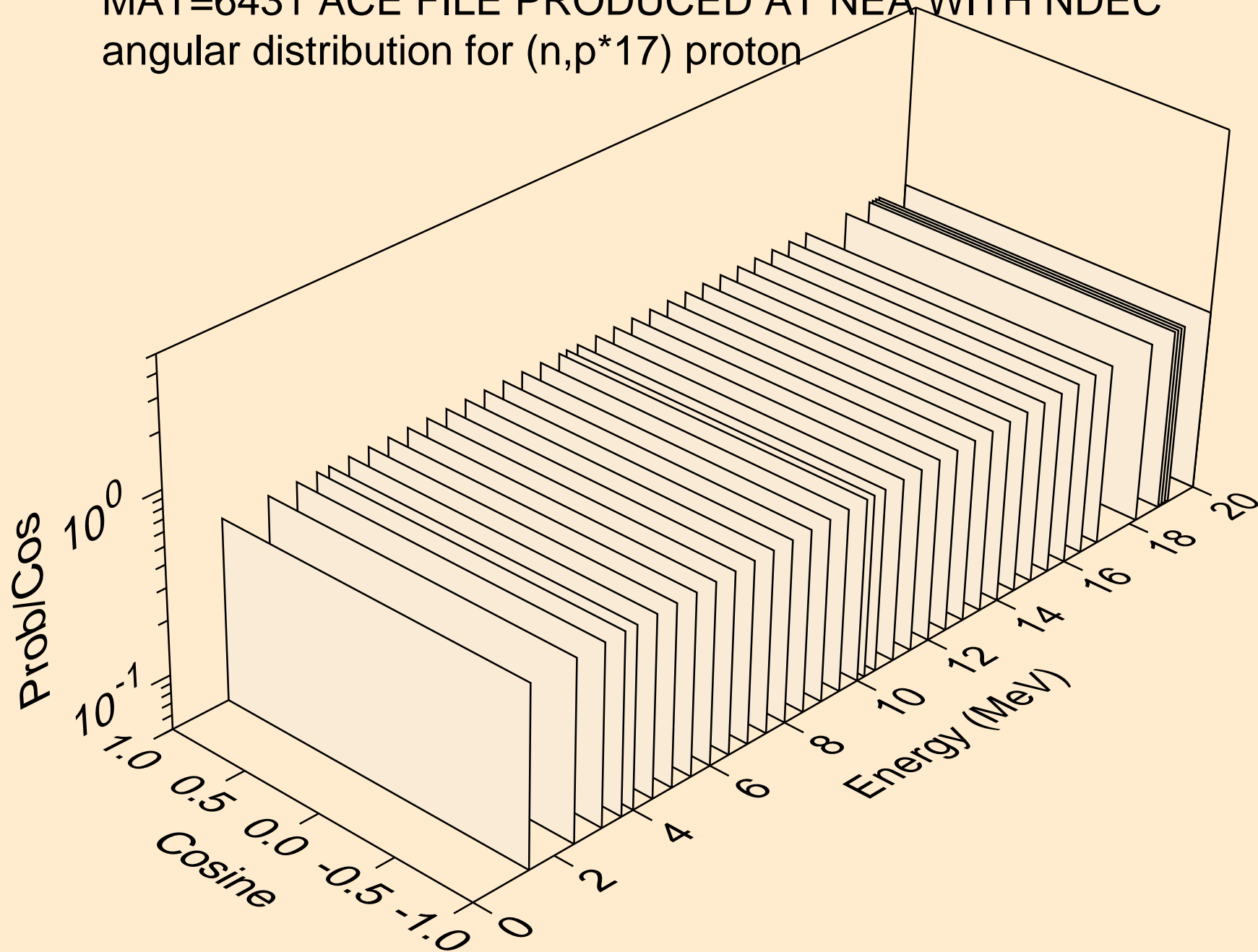

MAT=6431 ACE FILE PRODUCED AT NEA WITH NDEC
angular distribution for (n,p*18) proton

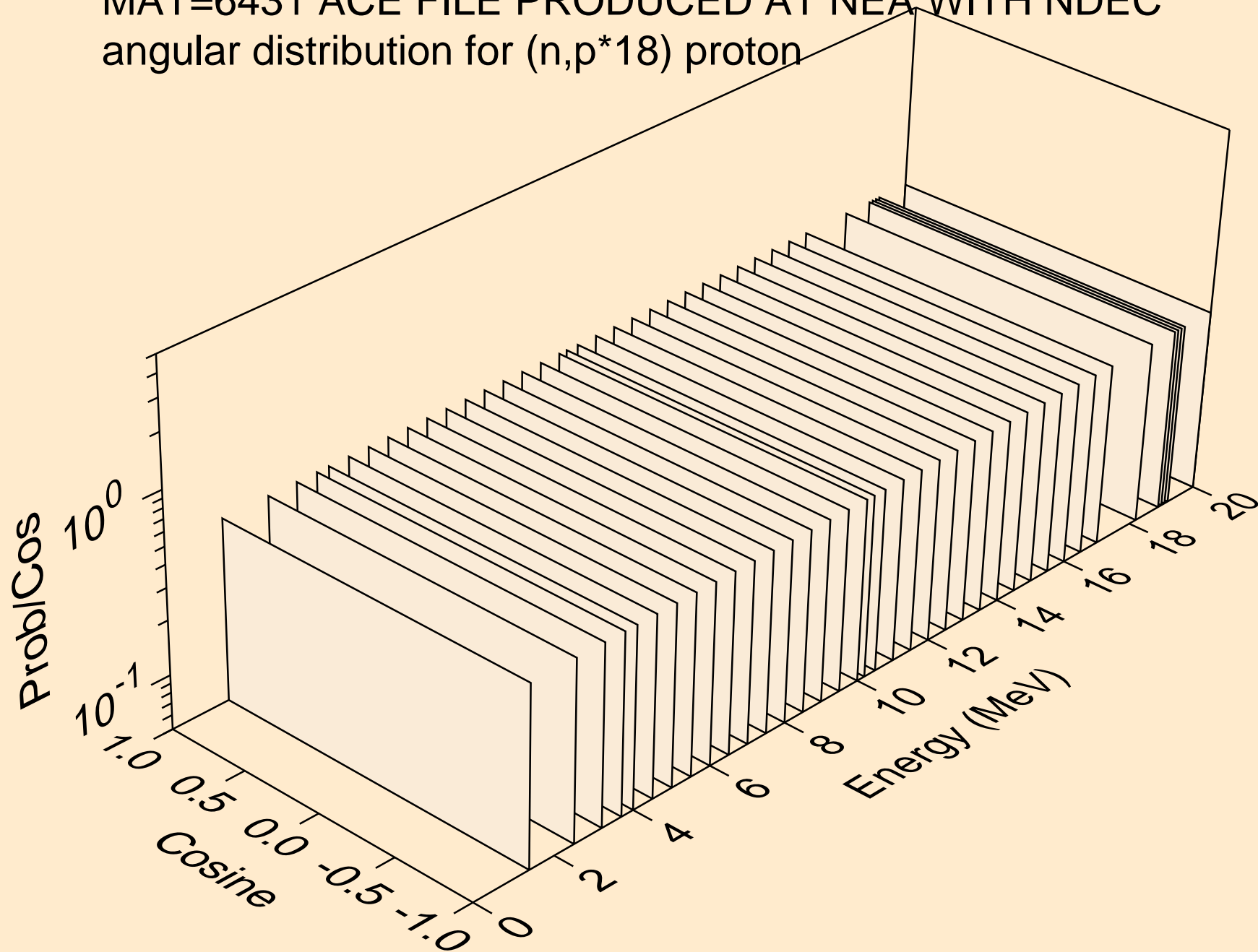

MAT=6431 ACE FILE PRODUCED AT NEA WITH NDEC
angular distribution for (n,p*19) proton

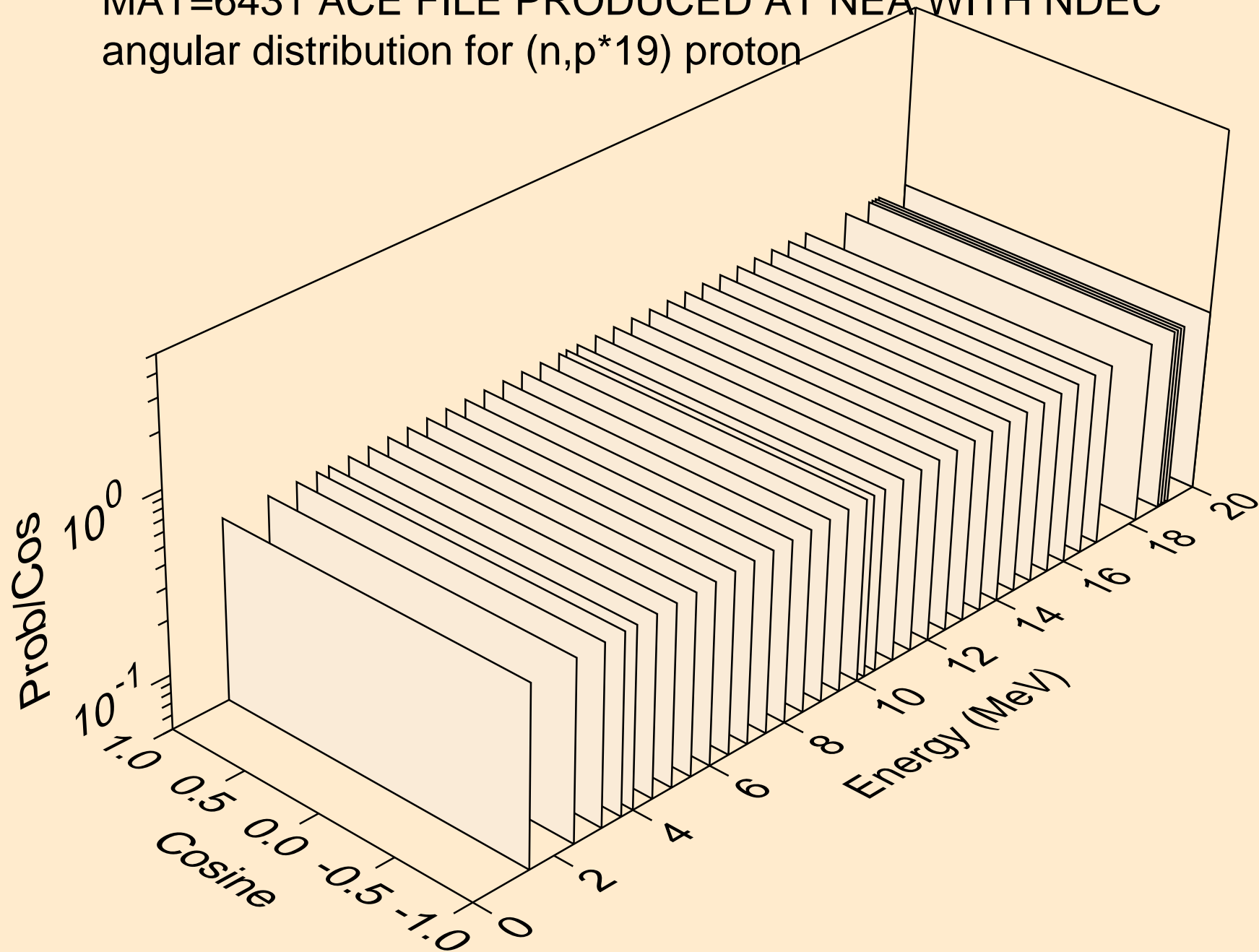

MAT=6431 ACE FILE PRODUCED AT NEA WITH NDEC
angular distribution for (n,p*20) proton

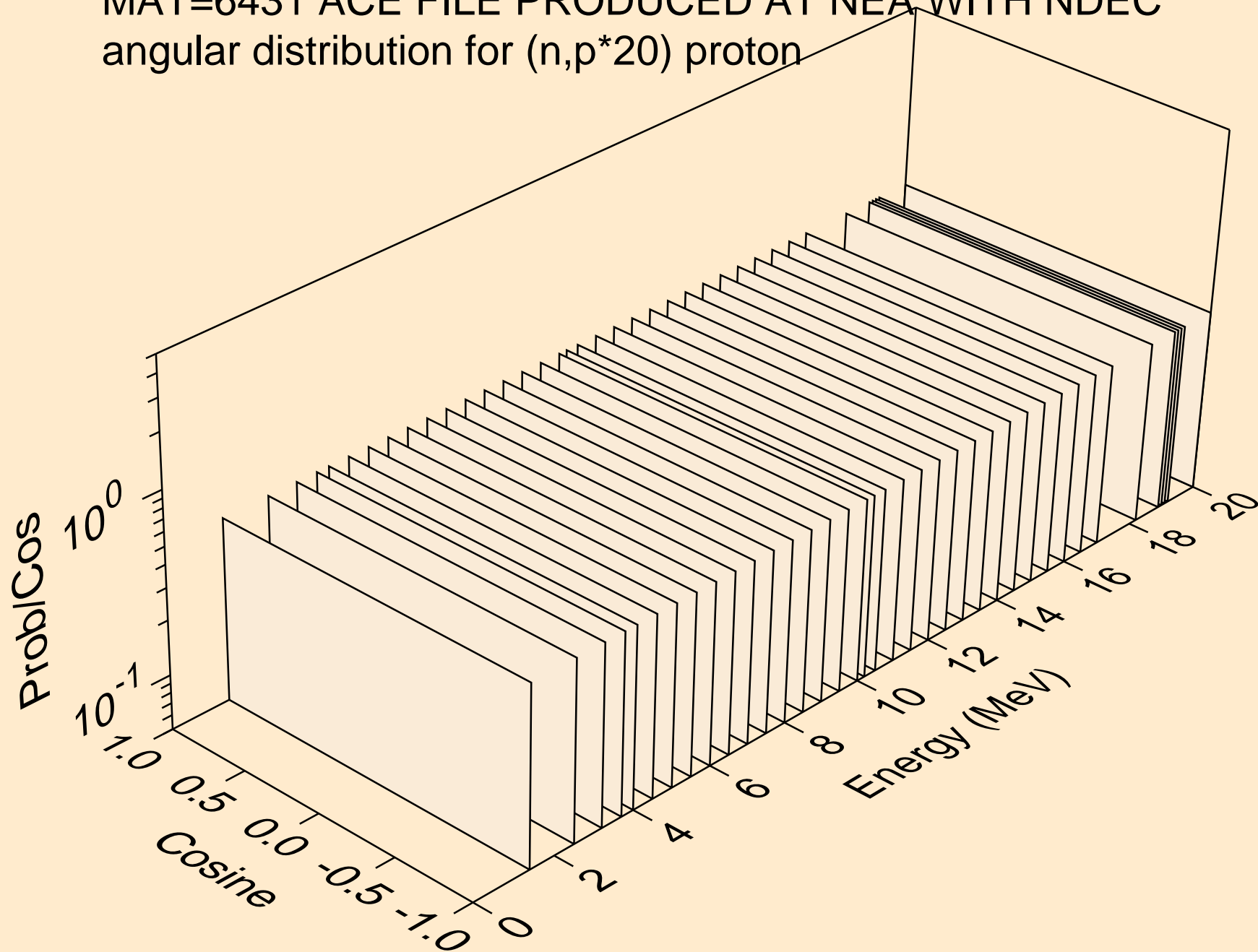

MAT=6431 ACE FILE PRODUCED AT NEA WITH NDEC
angular distribution for (n,p*21) proton

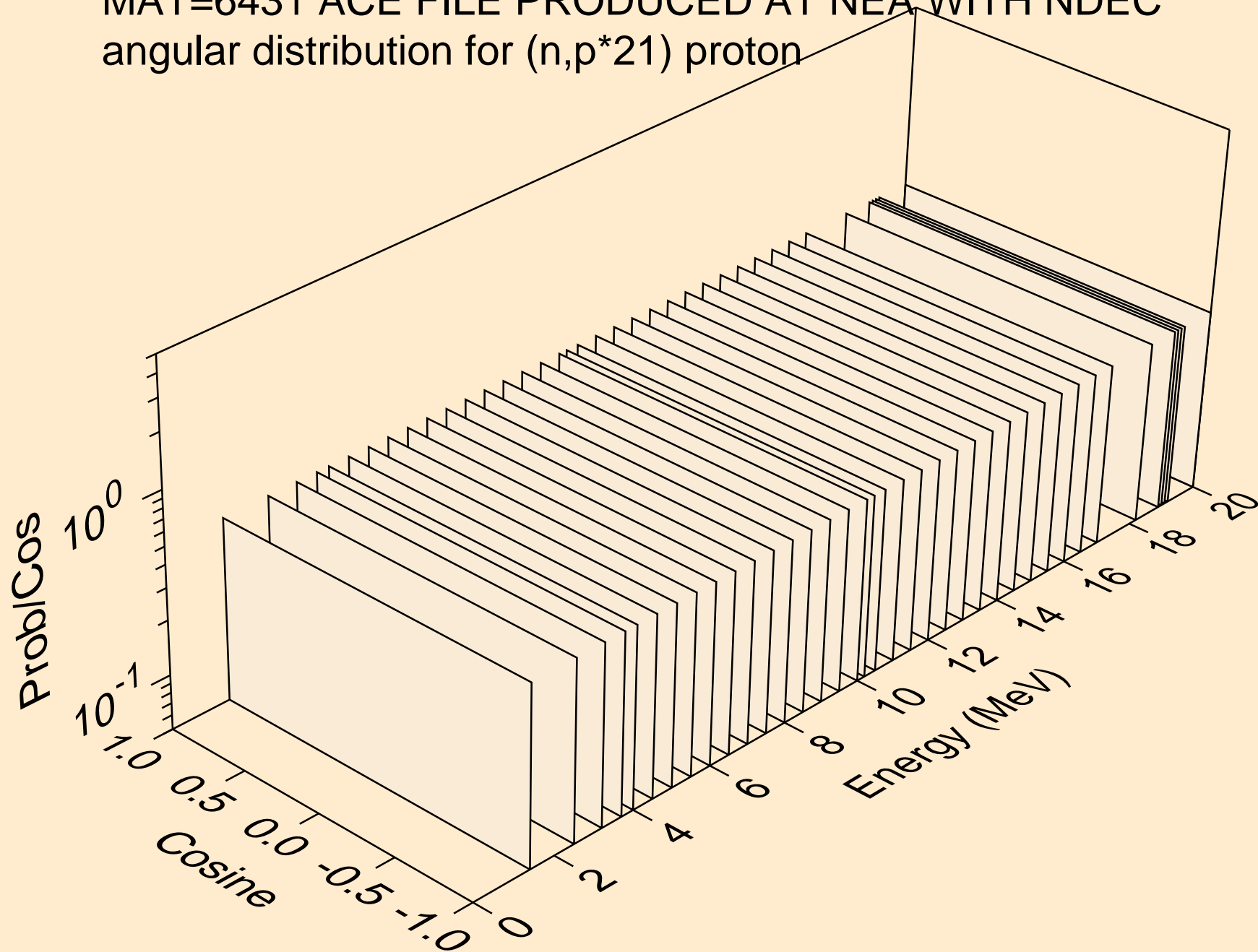

MAT=6431 ACE FILE PRODUCED AT NEA WITH NDEC
angular distribution for (n,p*22) proton

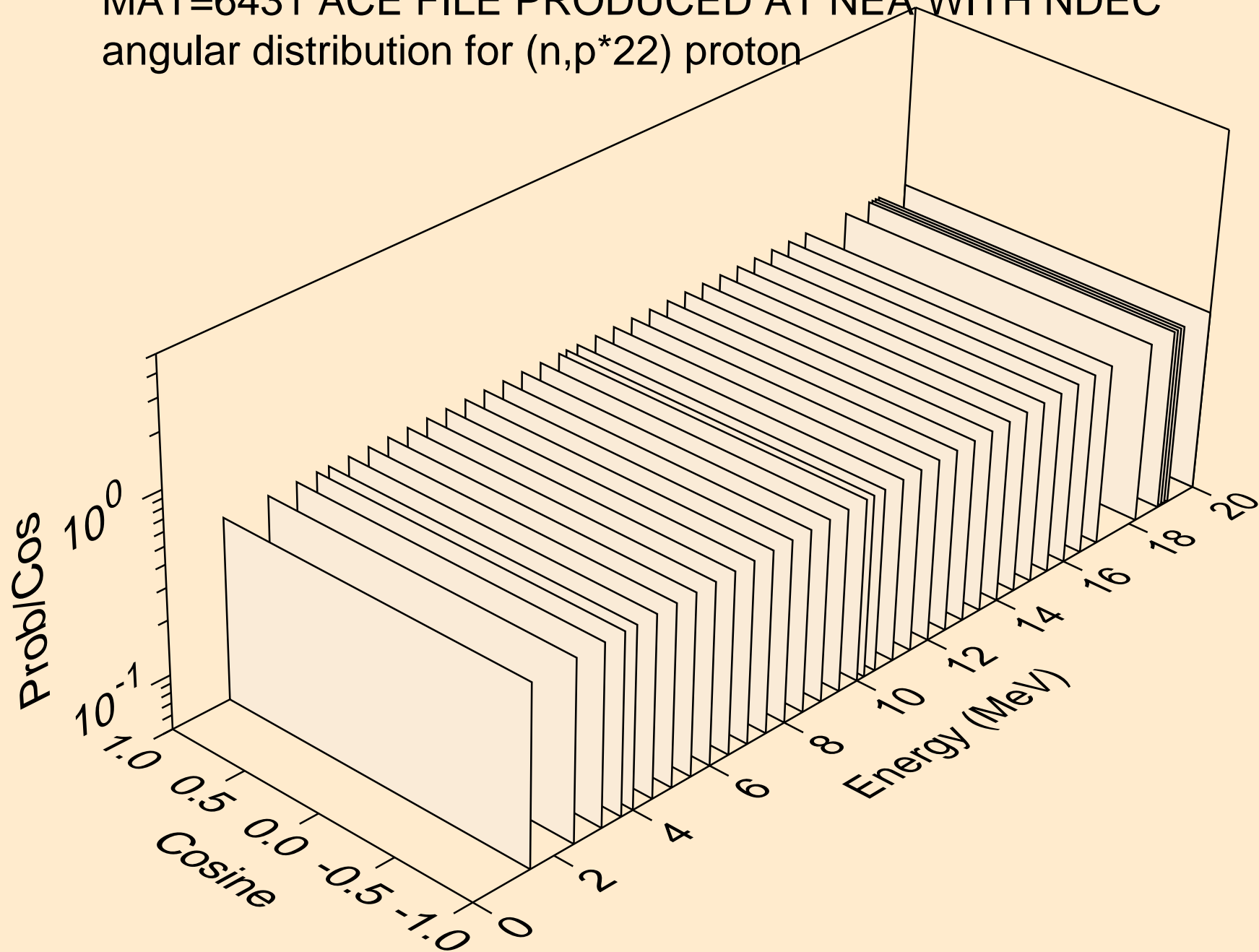

MAT=6431 ACE FILE PRODUCED AT NEA WITH NDEC
angular distribution for (n,p*23) proton

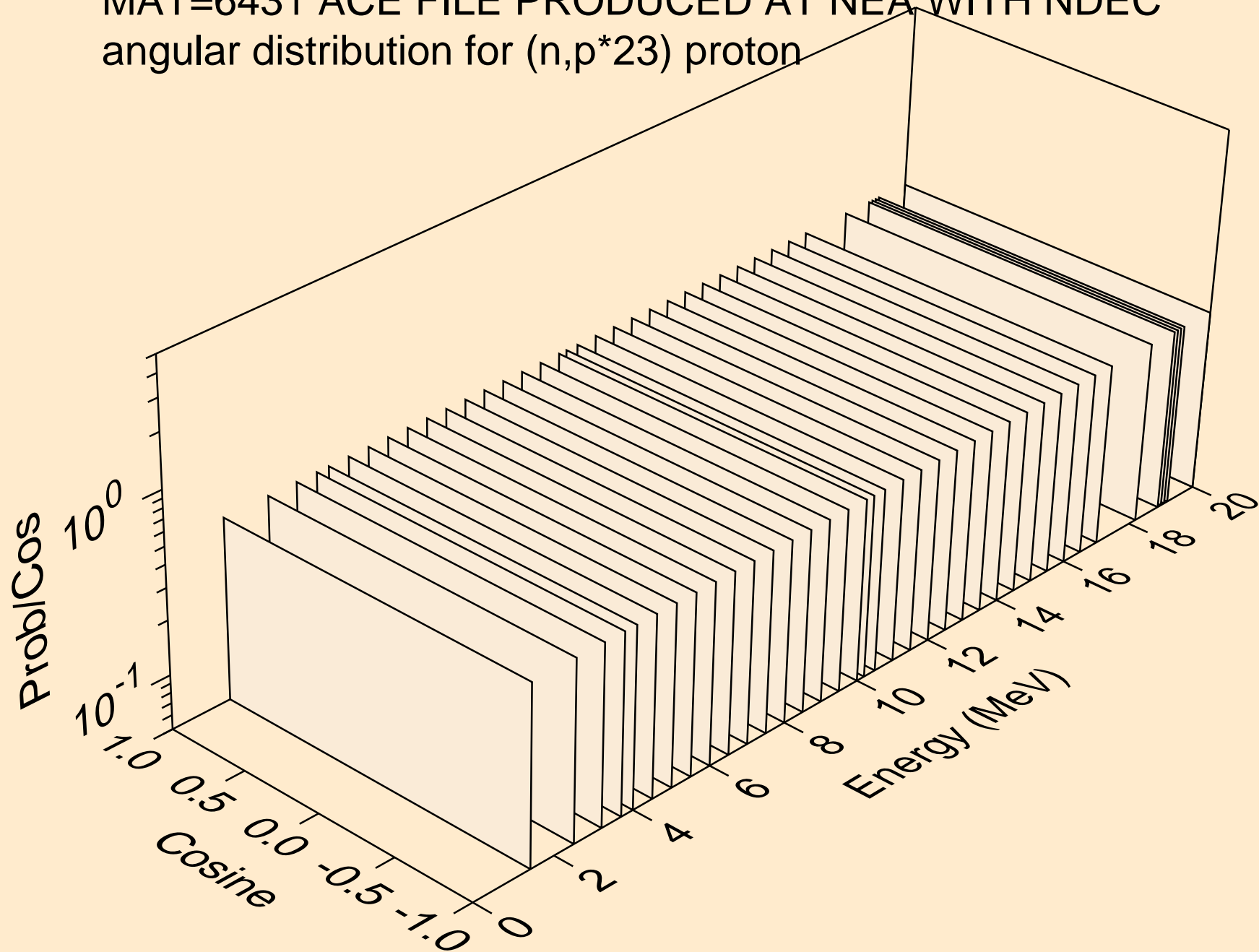

MAT=6431 ACE FILE PRODUCED AT NEA WITH NDEC
angular distribution for (n,p*24) proton

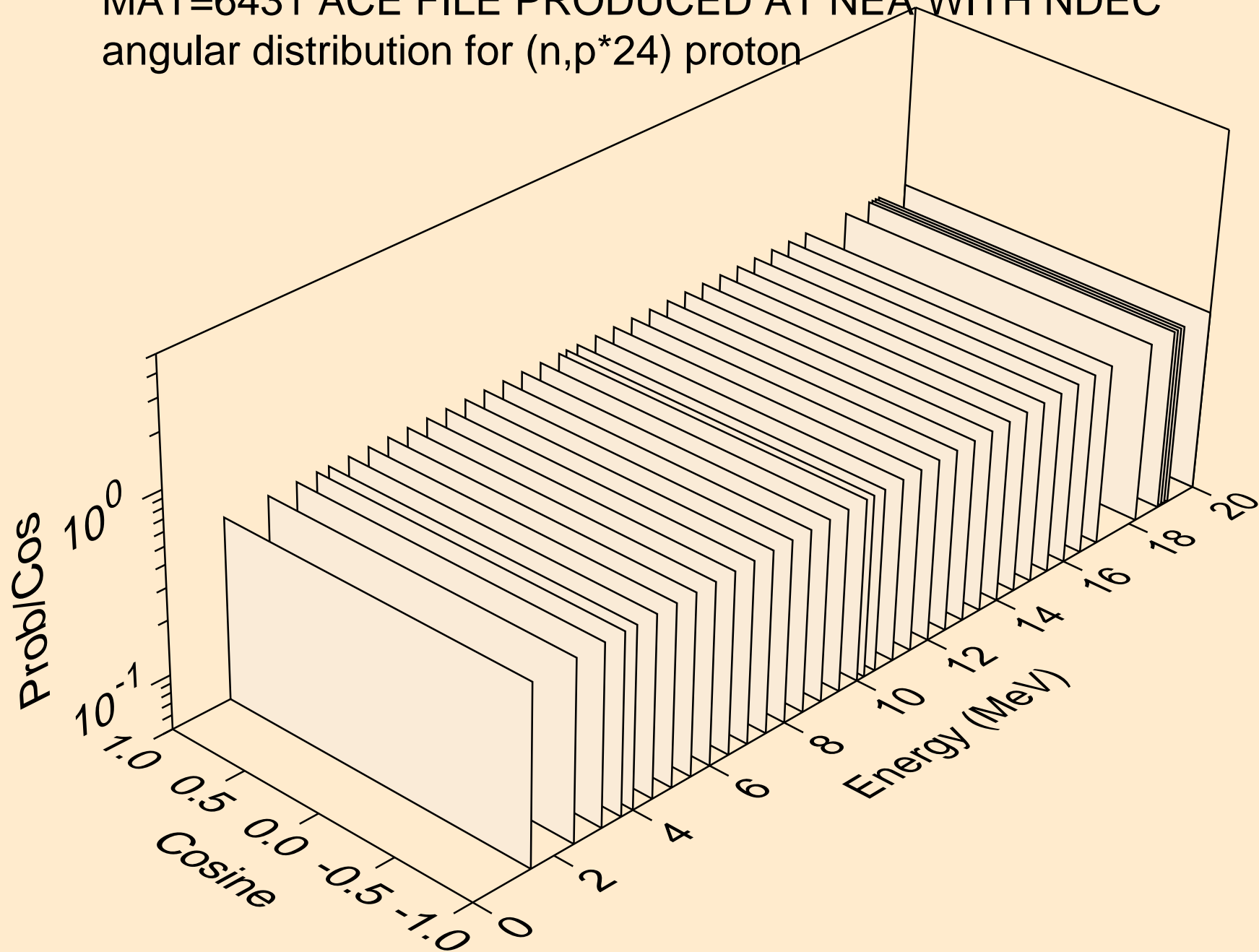

MAT=6431 ACE FILE PRODUCED AT NEA WITH NDEC
angular distribution for (n,p*25) proton

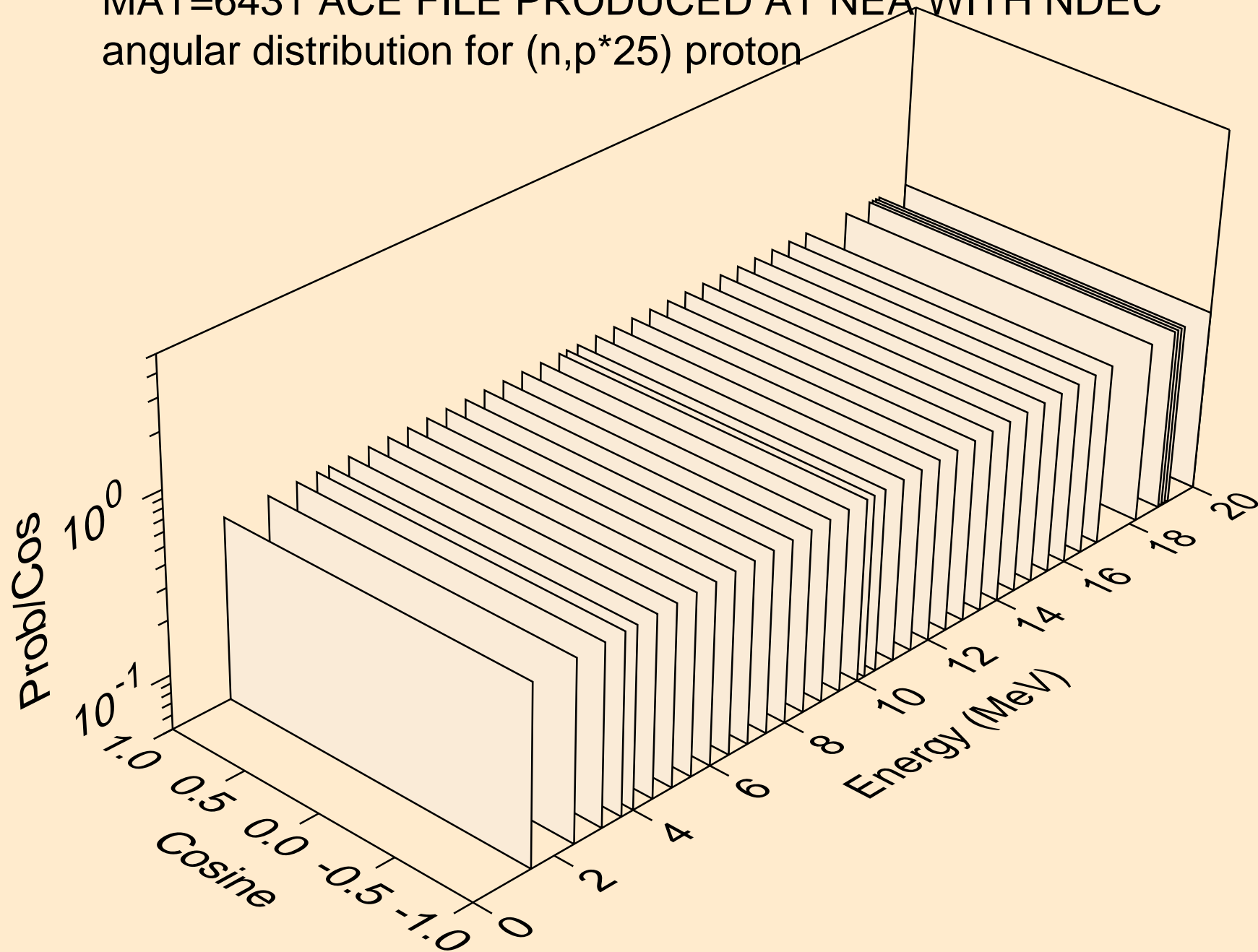

MAT=6431 ACE FILE PRODUCED AT NEA WITH NDEC
angular distribution for (n,p*26) proton

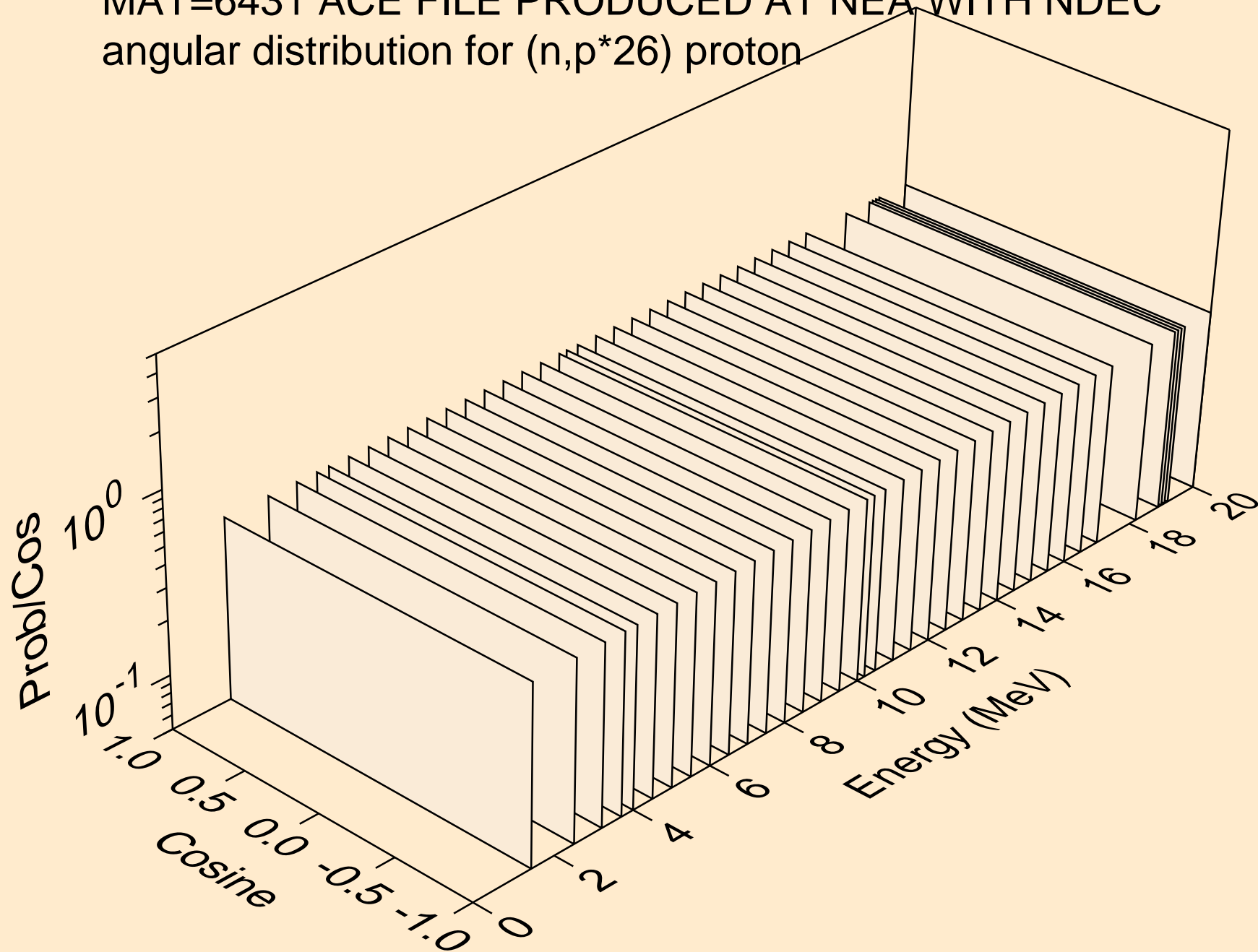

MAT=6431 ACE FILE PRODUCED AT NEA WITH NDEC
angular distribution for (n,p*27) proton

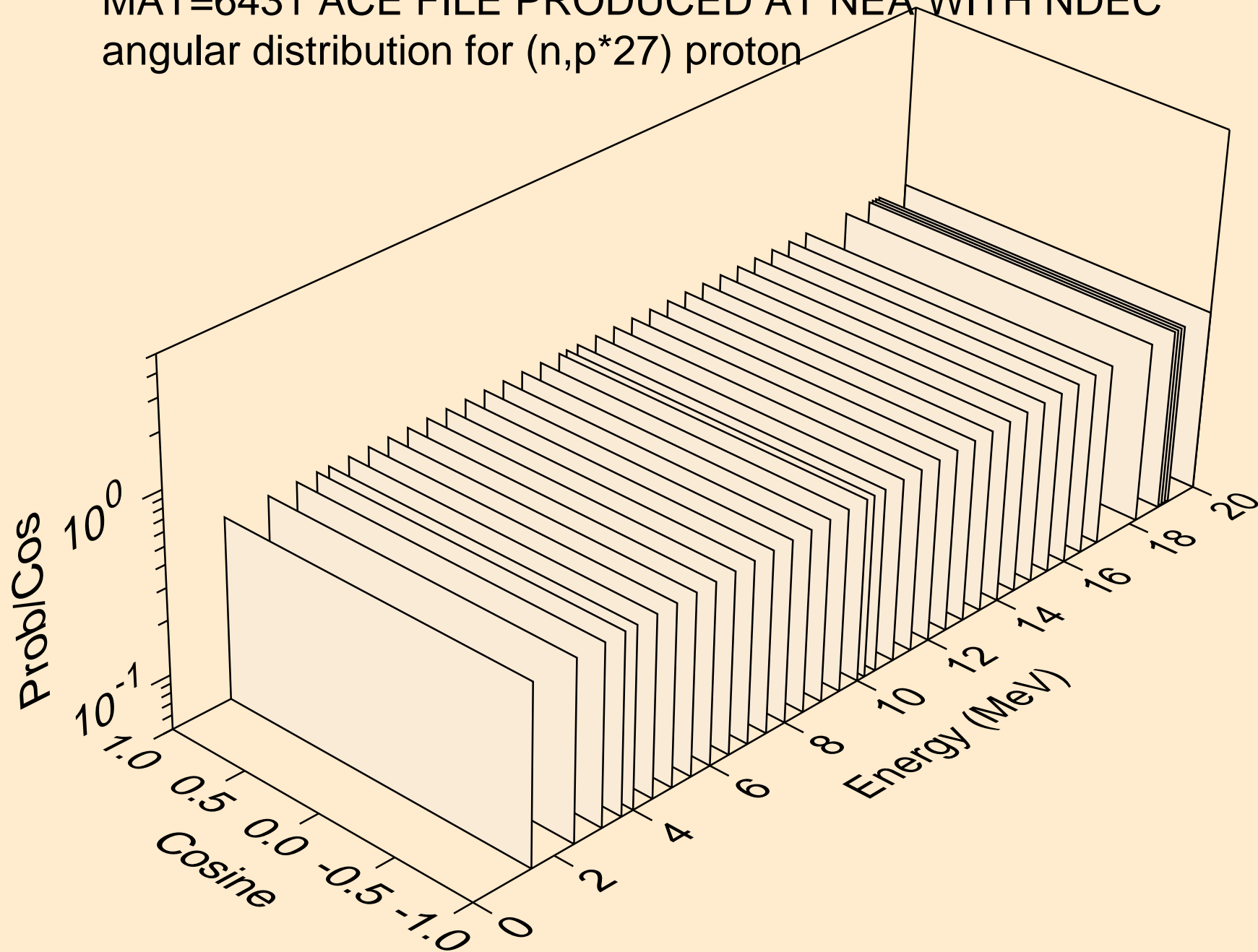

MAT=6431 ACE FILE PRODUCED AT NEA WITH NDEC
angular distribution for (n,p*28) proton

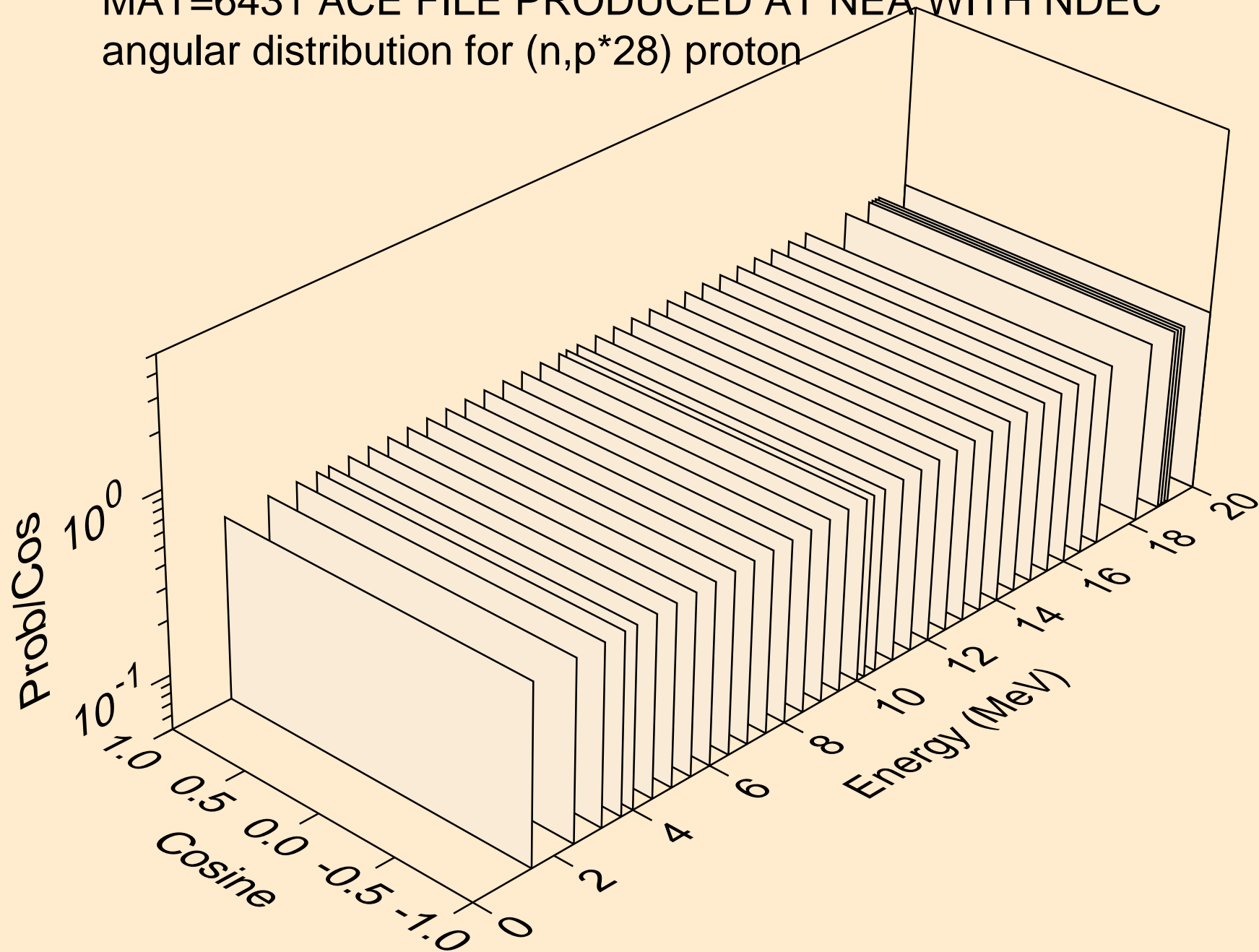

MAT=6431 ACE FILE PRODUCED AT NEA WITH NDEC
angular distribution for (n,p*29) proton

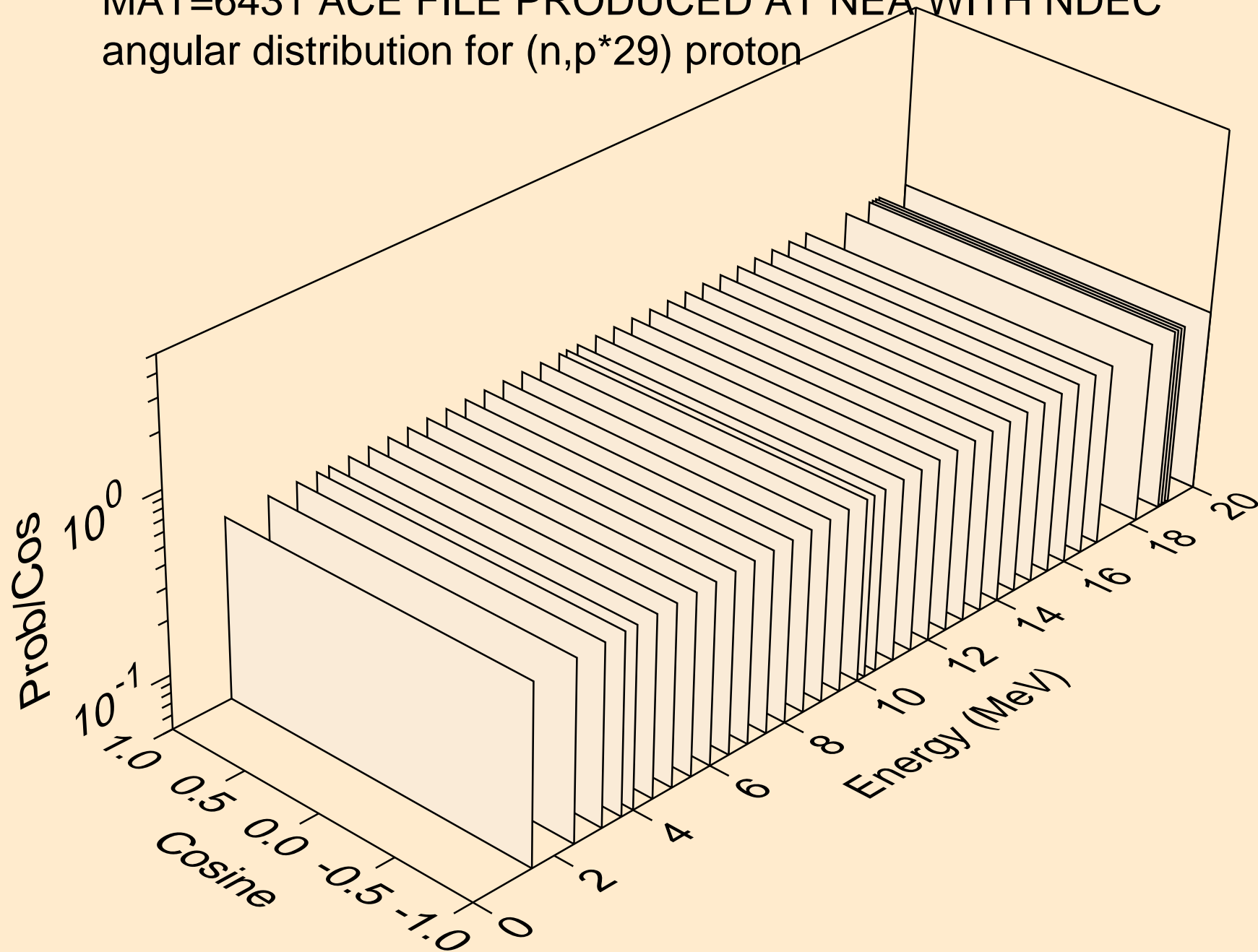

MAT=6431 ACE FILE PRODUCED AT NEA WITH NDEC
angular distribution for (n,p*30) proton

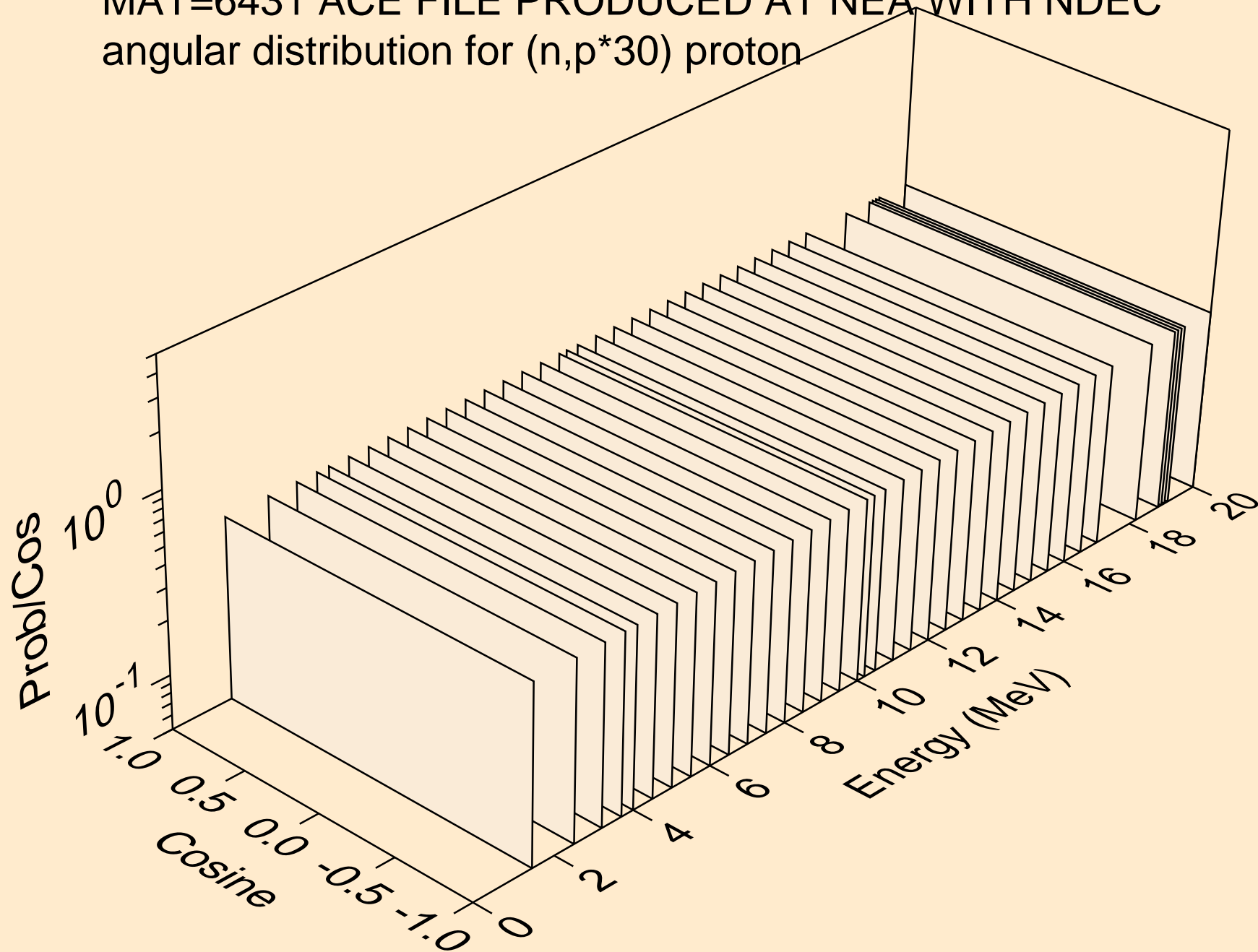

MAT=6431 ACE FILE PRODUCED AT NEA WITH NDEC
angular distribution for (n,p*31) proton

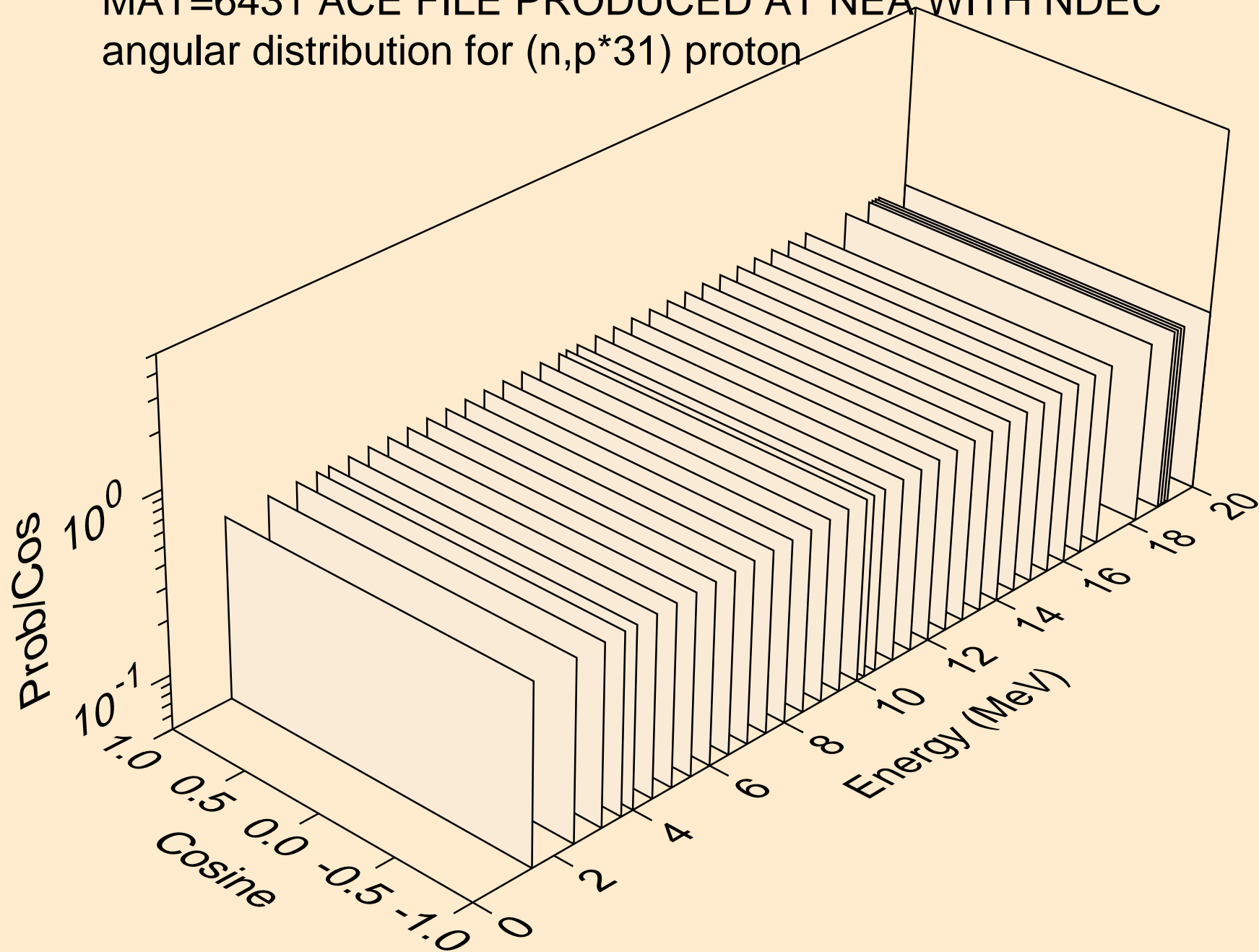

MAT=6431 ACE FILE PRODUCED AT NEA WITH NDEC
angular distribution for (n,p*32) proton

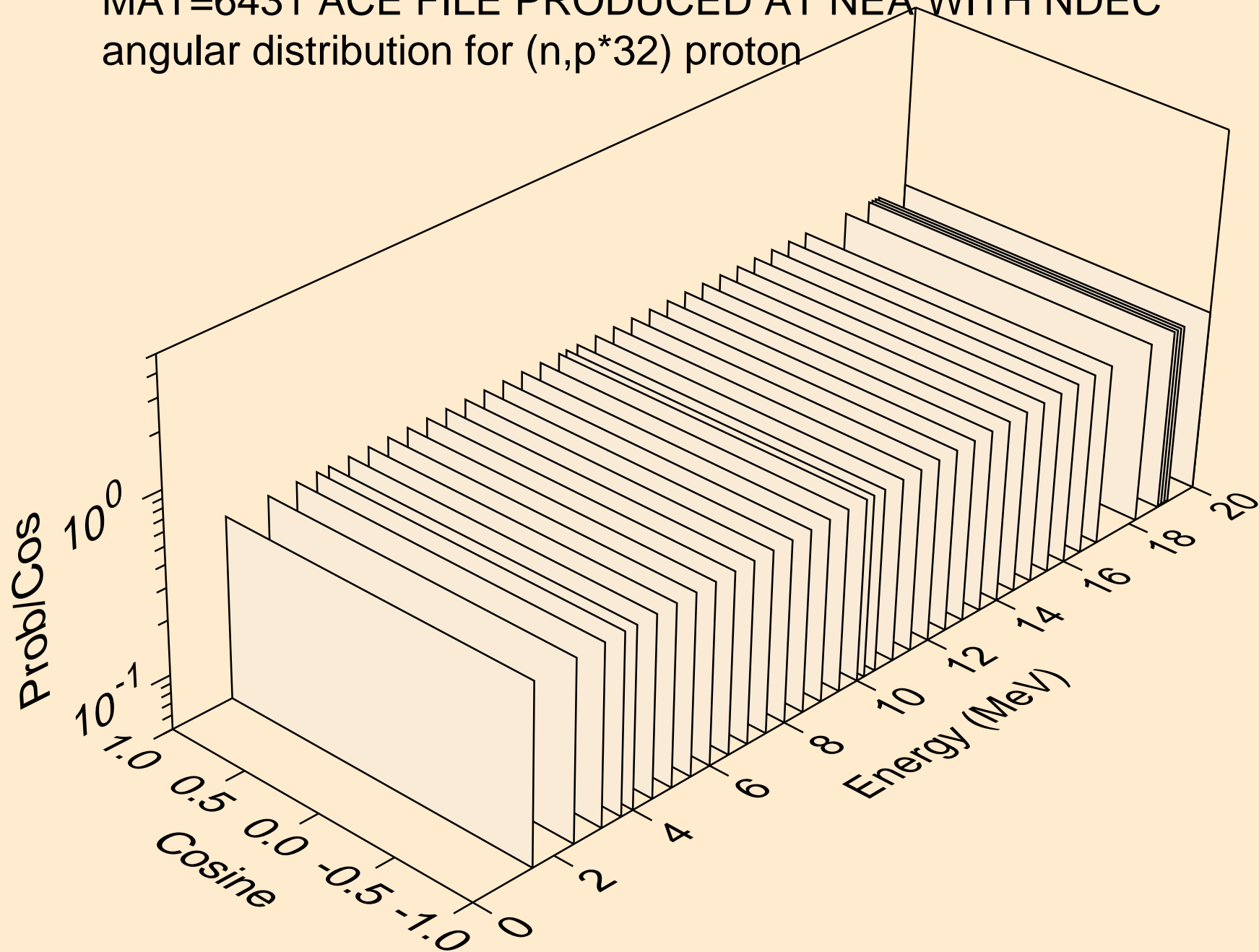

MAT=6431 ACE FILE PRODUCED AT NEA WITH NDEC
angular distribution for (n,p*33) proton

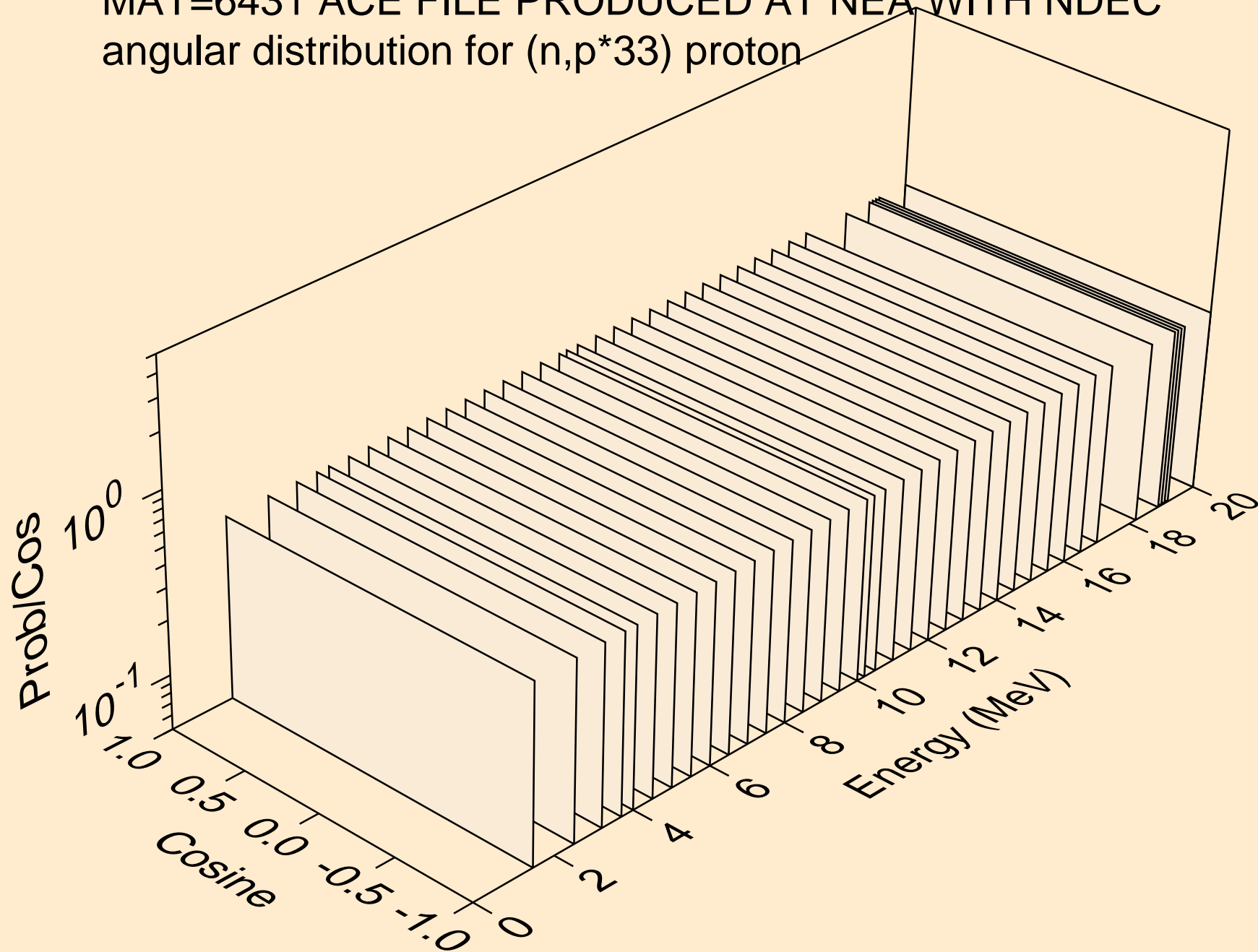

MAT=6431 ACE FILE PRODUCED AT NEA WITH NDEC
angular distribution for (n,p*34) proton

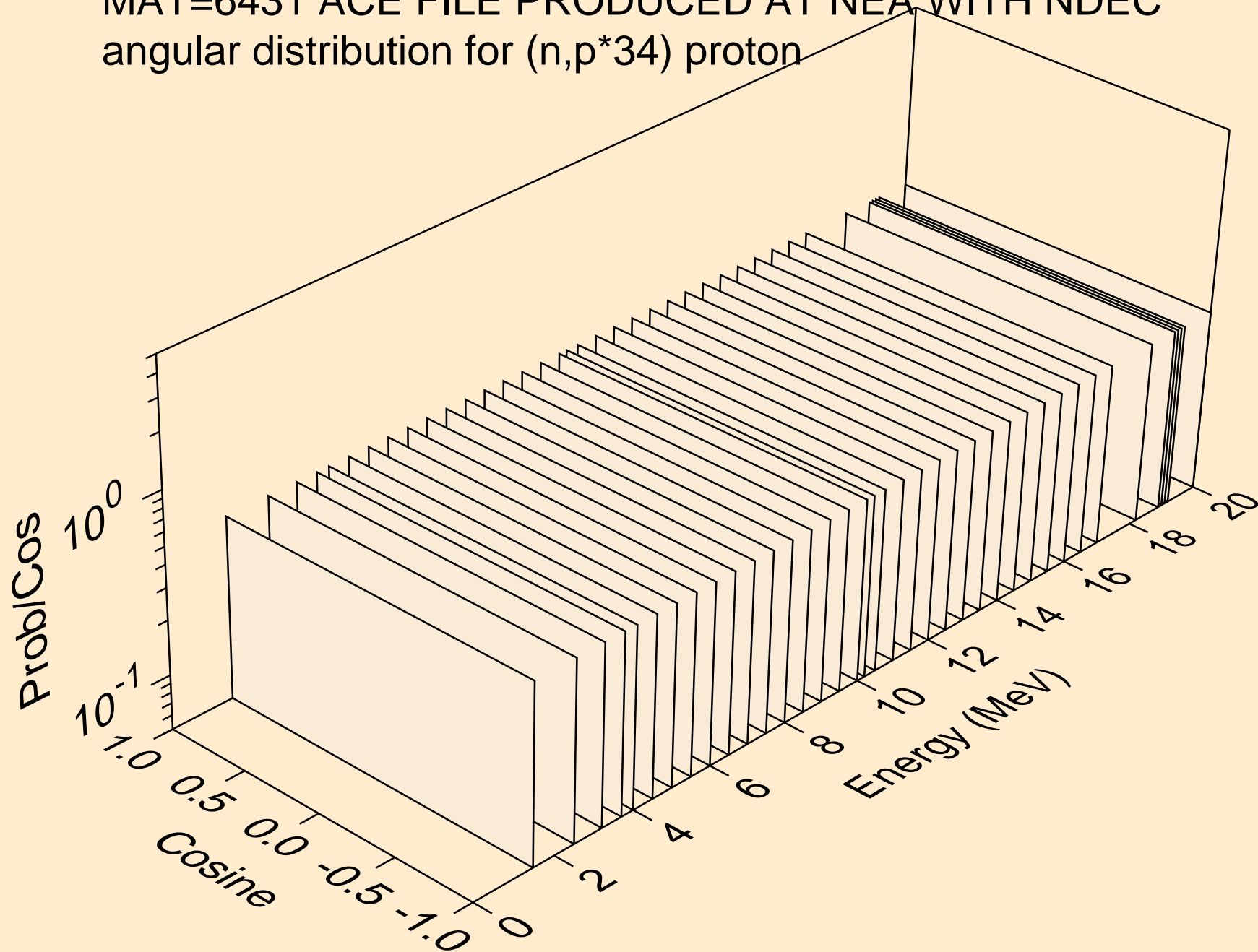

MAT=6431 ACE FILE PRODUCED AT NEA WITH NDEC
angular distribution for (n,p*35) proton

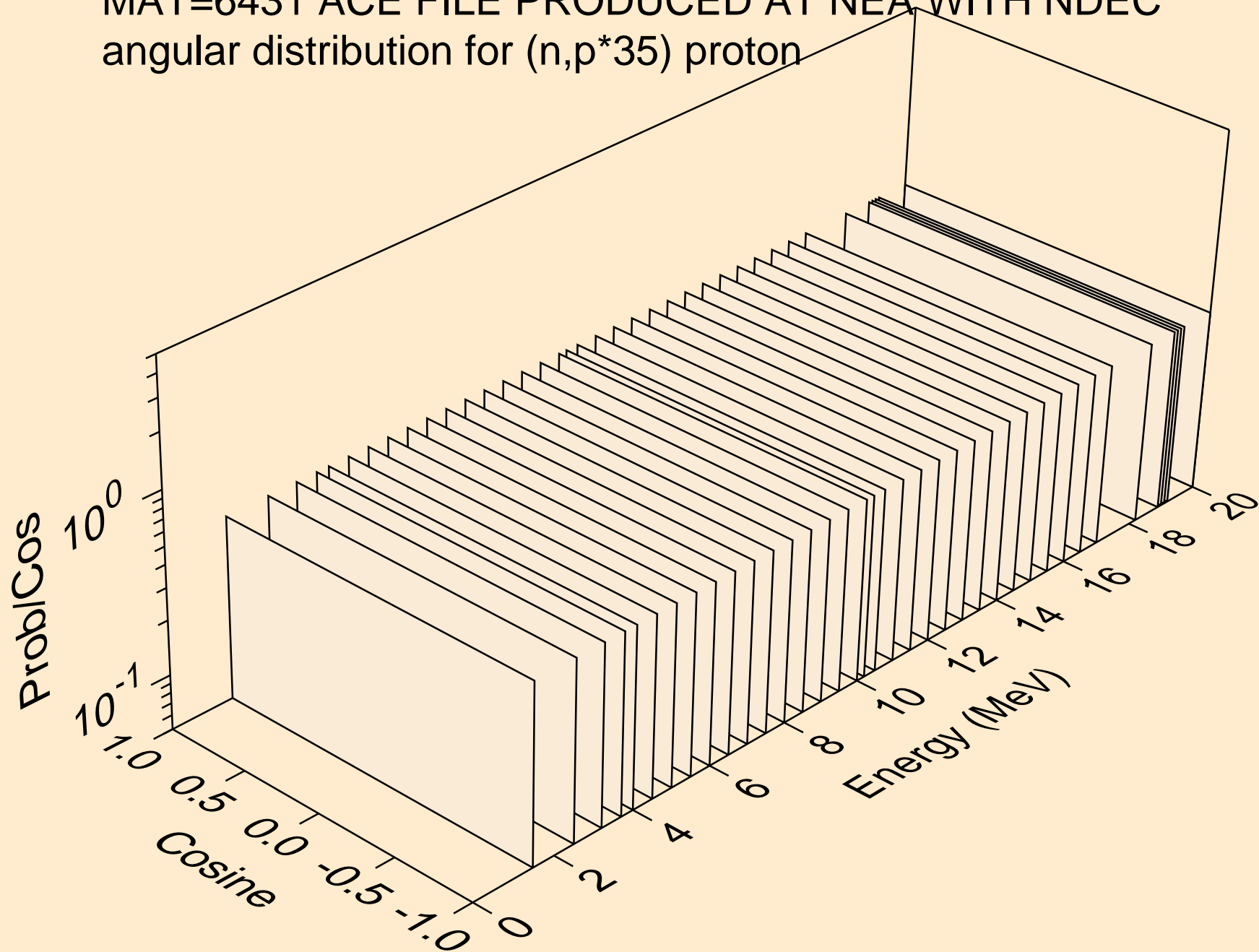

MAT=6431 ACE FILE PRODUCED AT NEA WITH NDEC
angular distribution for (n,p*36) proton

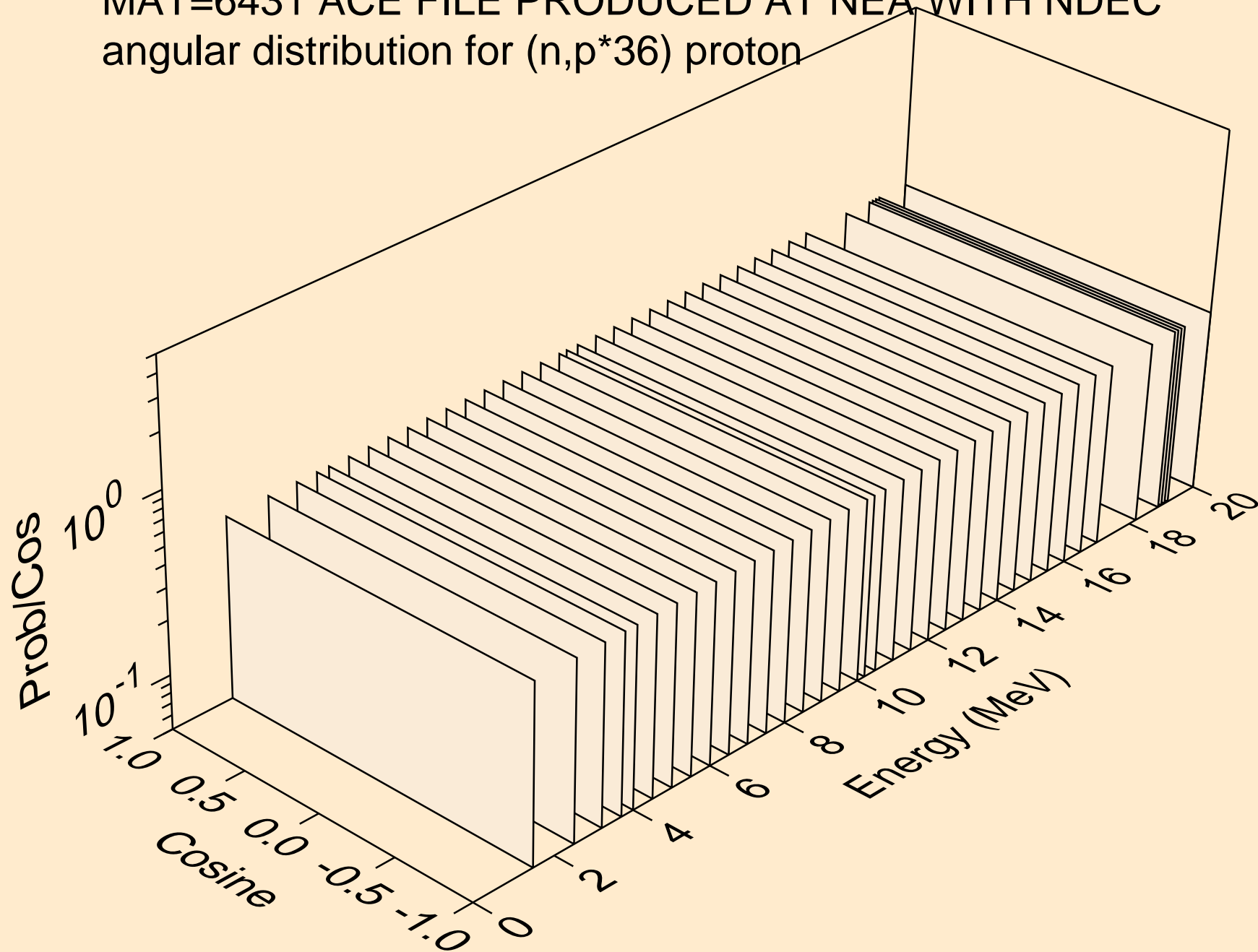

MAT=6431 ACE FILE PRODUCED AT NEA WITH NDEC
angular distribution for (n,p*37) proton

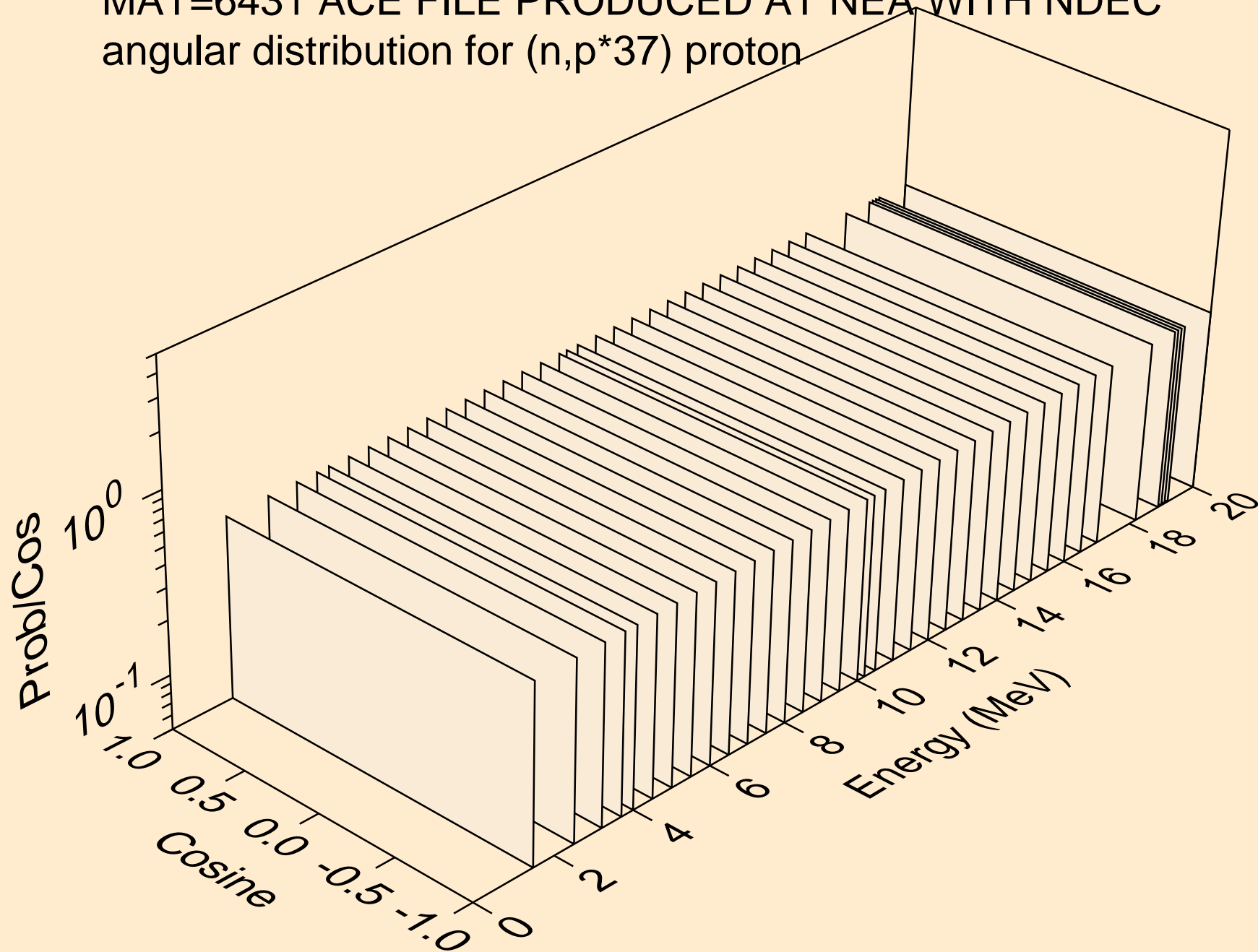

MAT=6431 ACE FILE PRODUCED AT NEA WITH NDEC
angular distribution for (n,p*38) proton

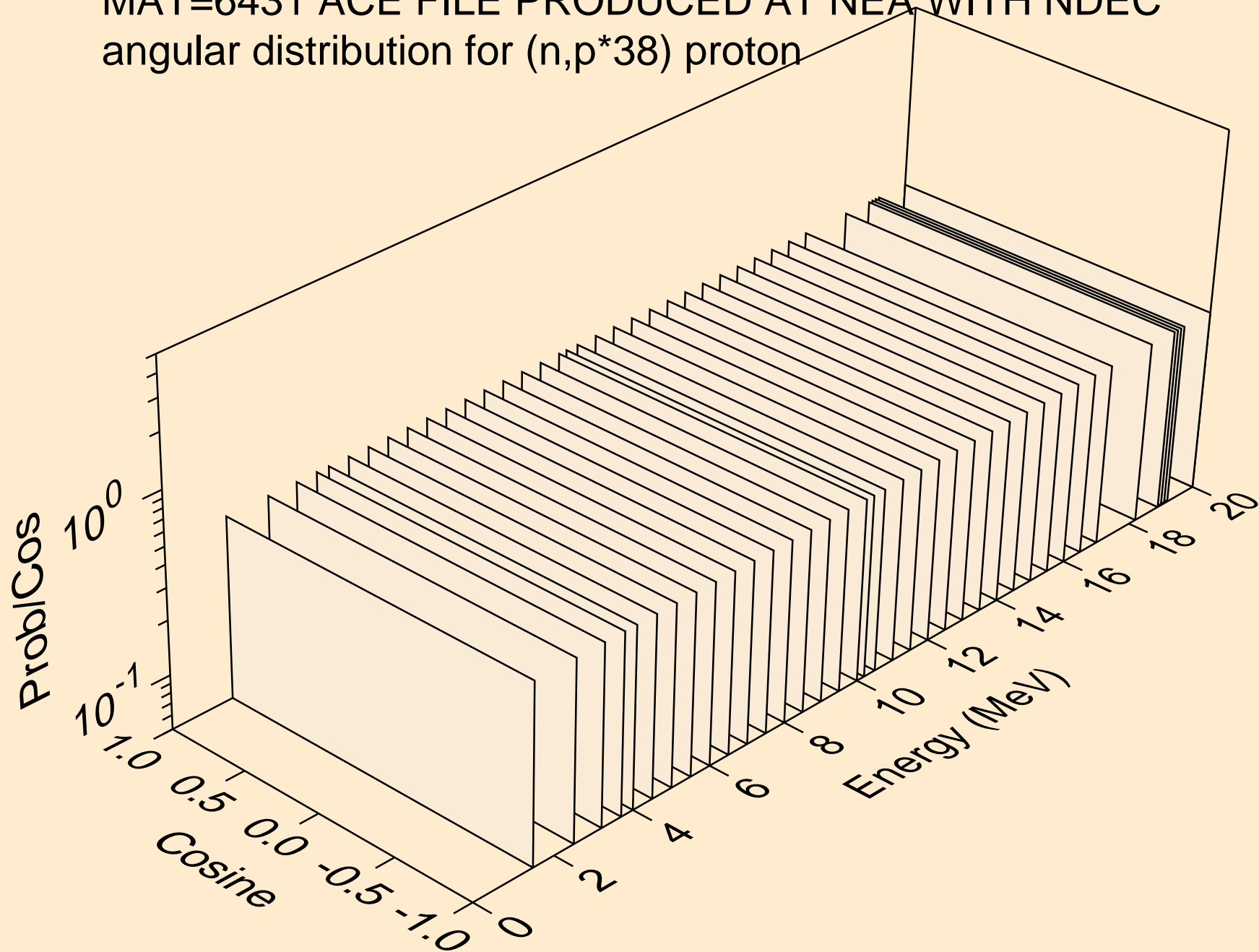

MAT=6431 ACE FILE PRODUCED AT NEA WITH NDEC
angular distribution for (n,p*39) proton

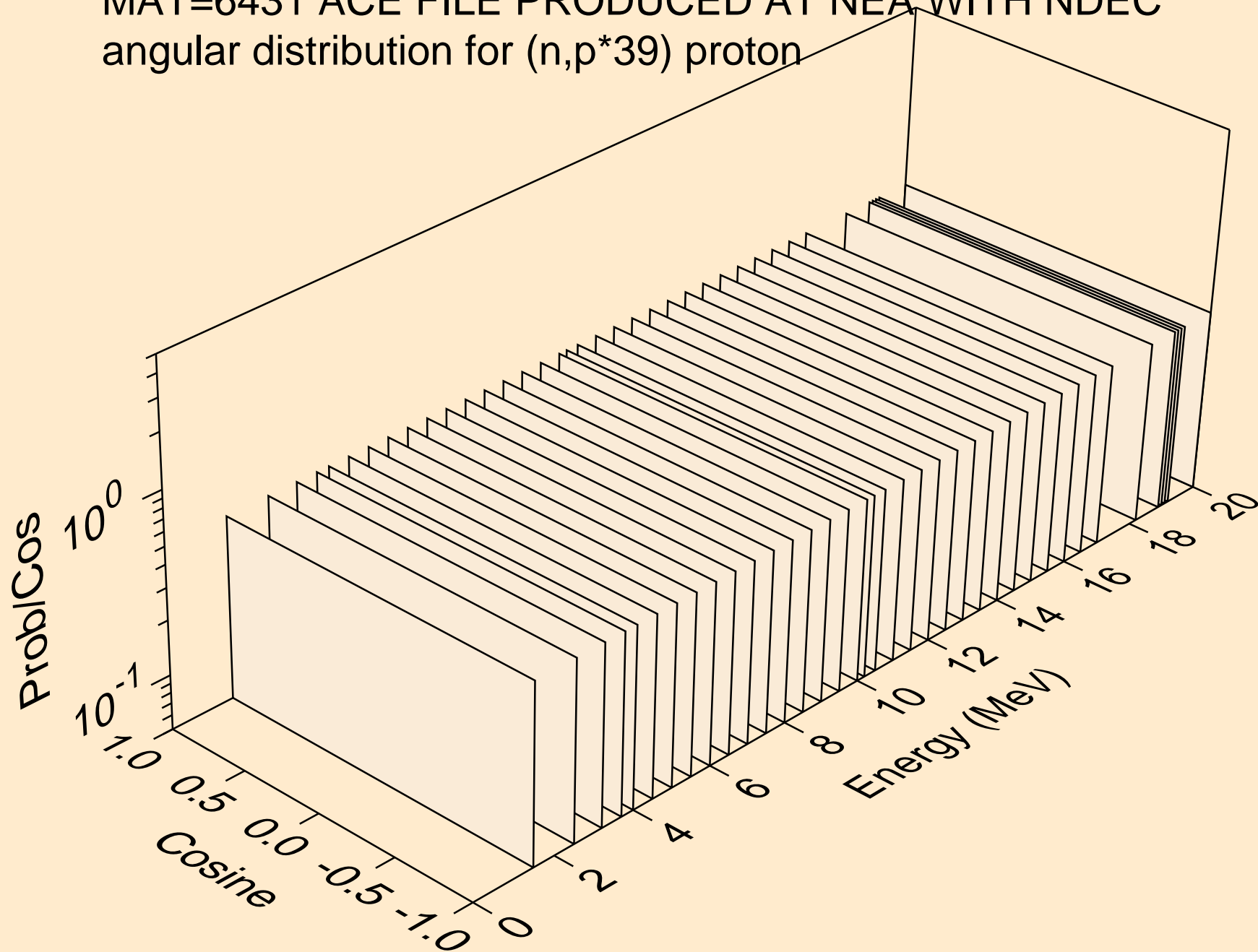

MAT=6431 ACE FILE PRODUCED AT NEA WITH NDEC
protons from (n,p*c)

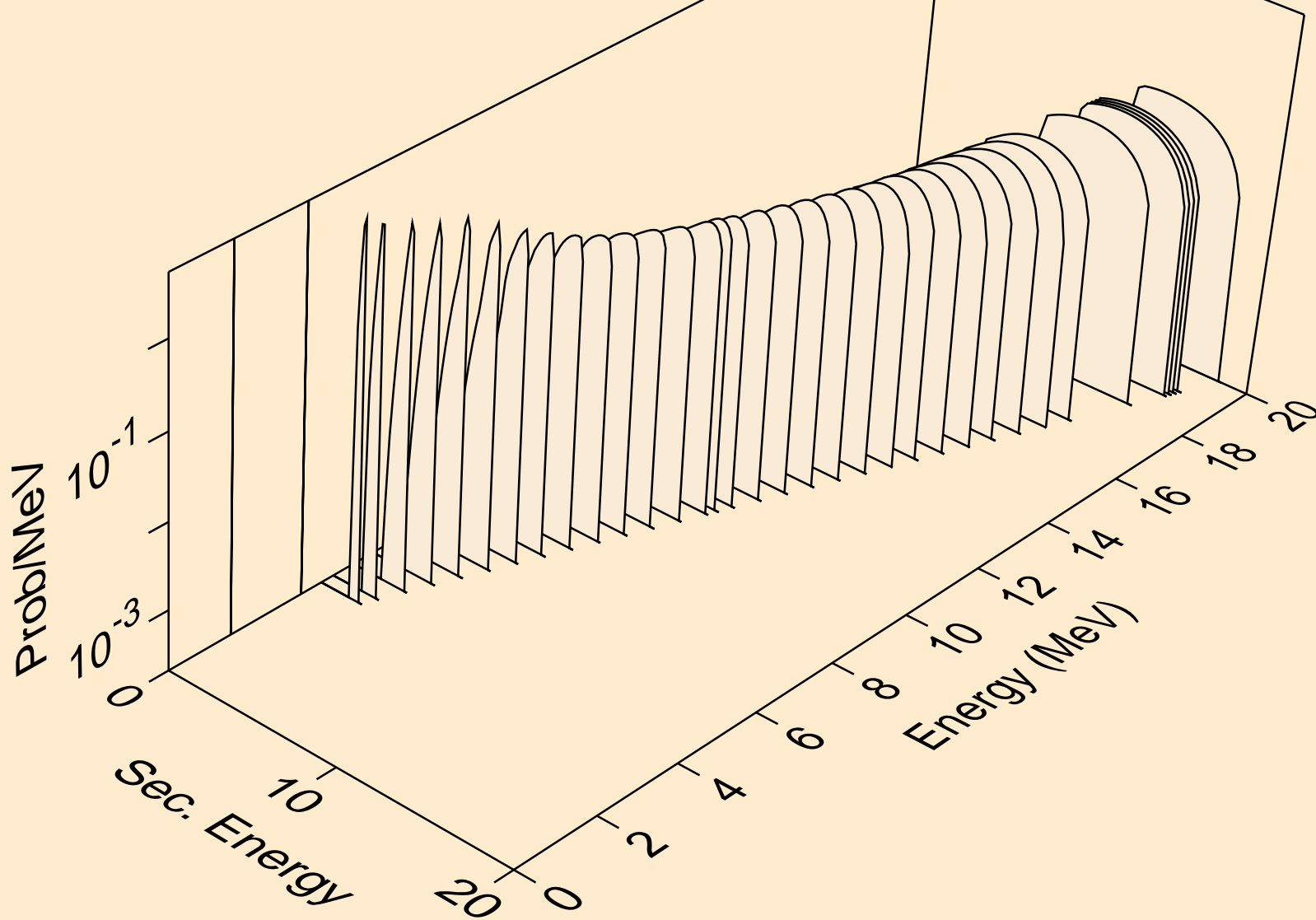

MAT=6431 ACE FILE PRODUCED AT NEA WITH NDEC
alphas from (n,n*)a

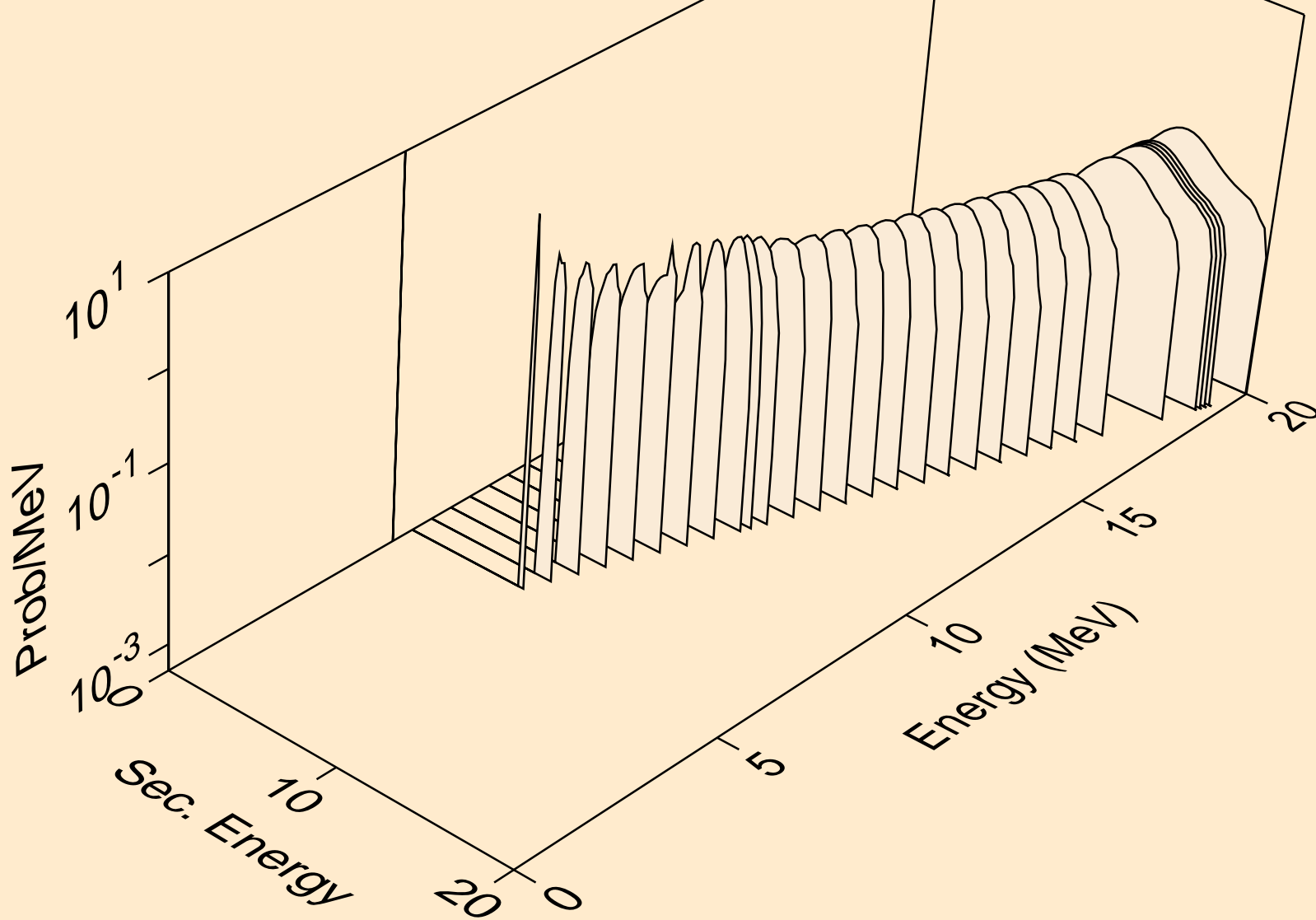

MAT=6431 ACE FILE PRODUCED AT NEA WITH NDEC
alphas from (n,2n)a

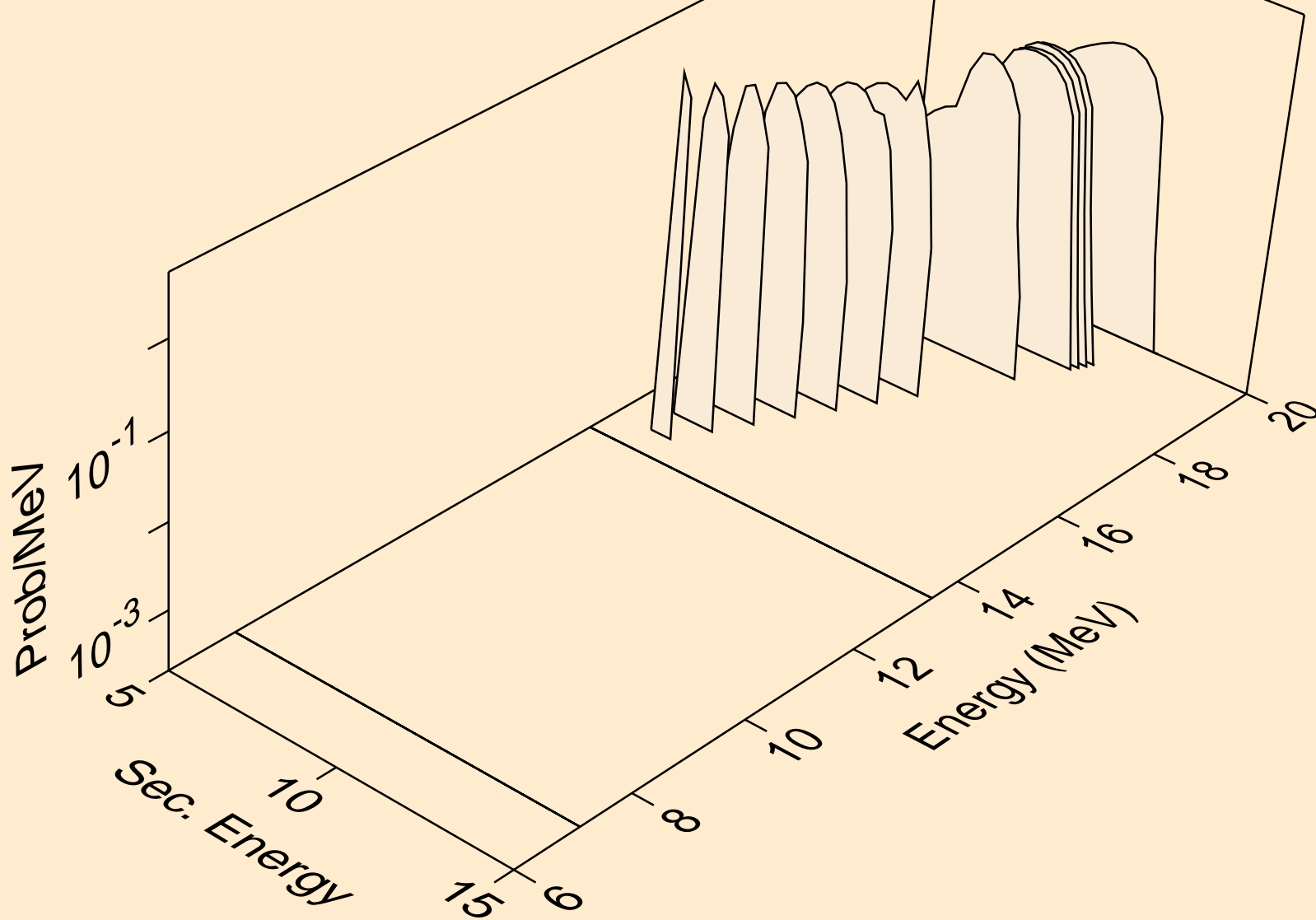

MAT=6431 ACE FILE PRODUCED AT NEA WITH NDEC
angular distribution for (n,a*0) alpha

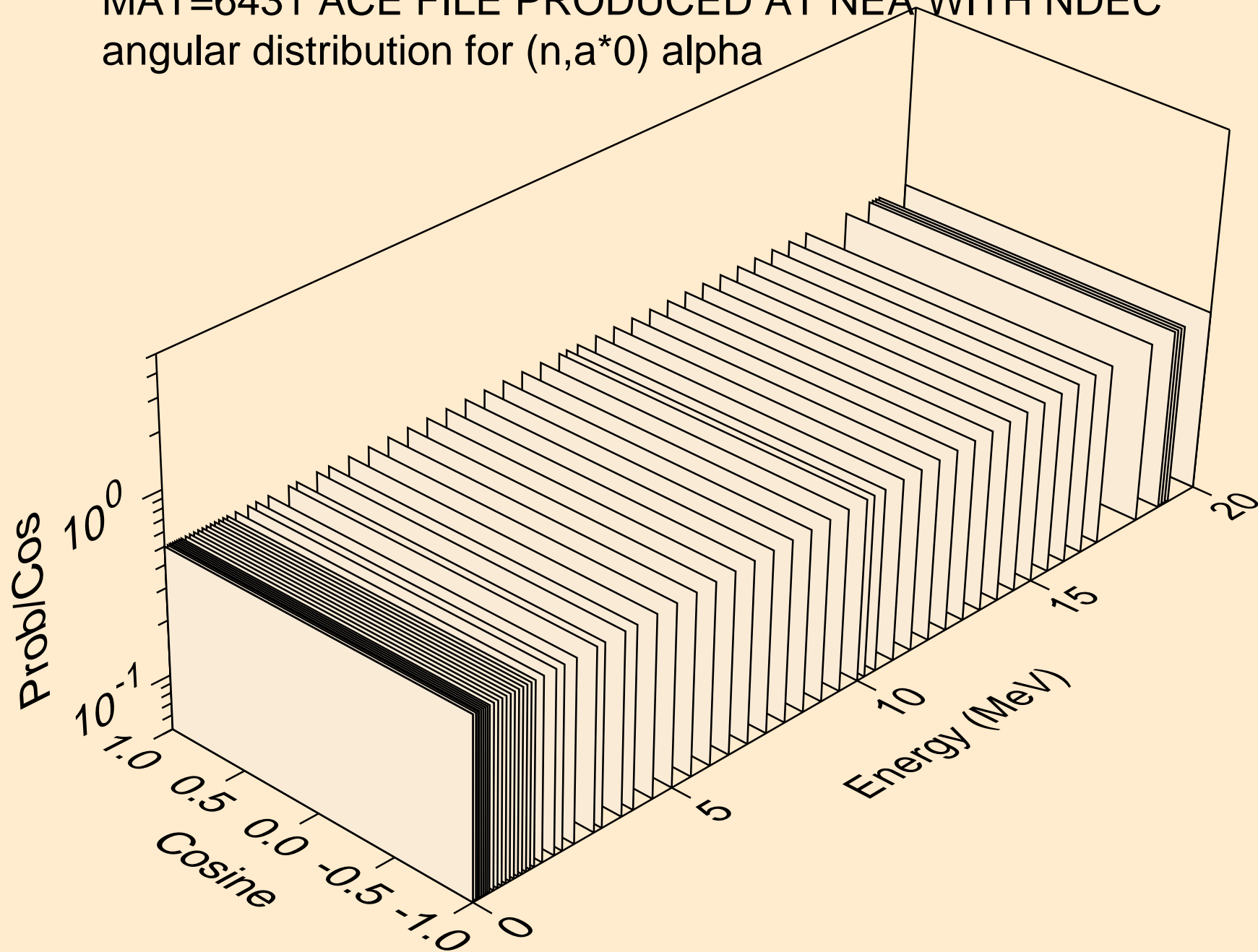

MAT=6431 ACE FILE PRODUCED AT NEA WITH NDEC
angular distribution for (n,a*1) alpha

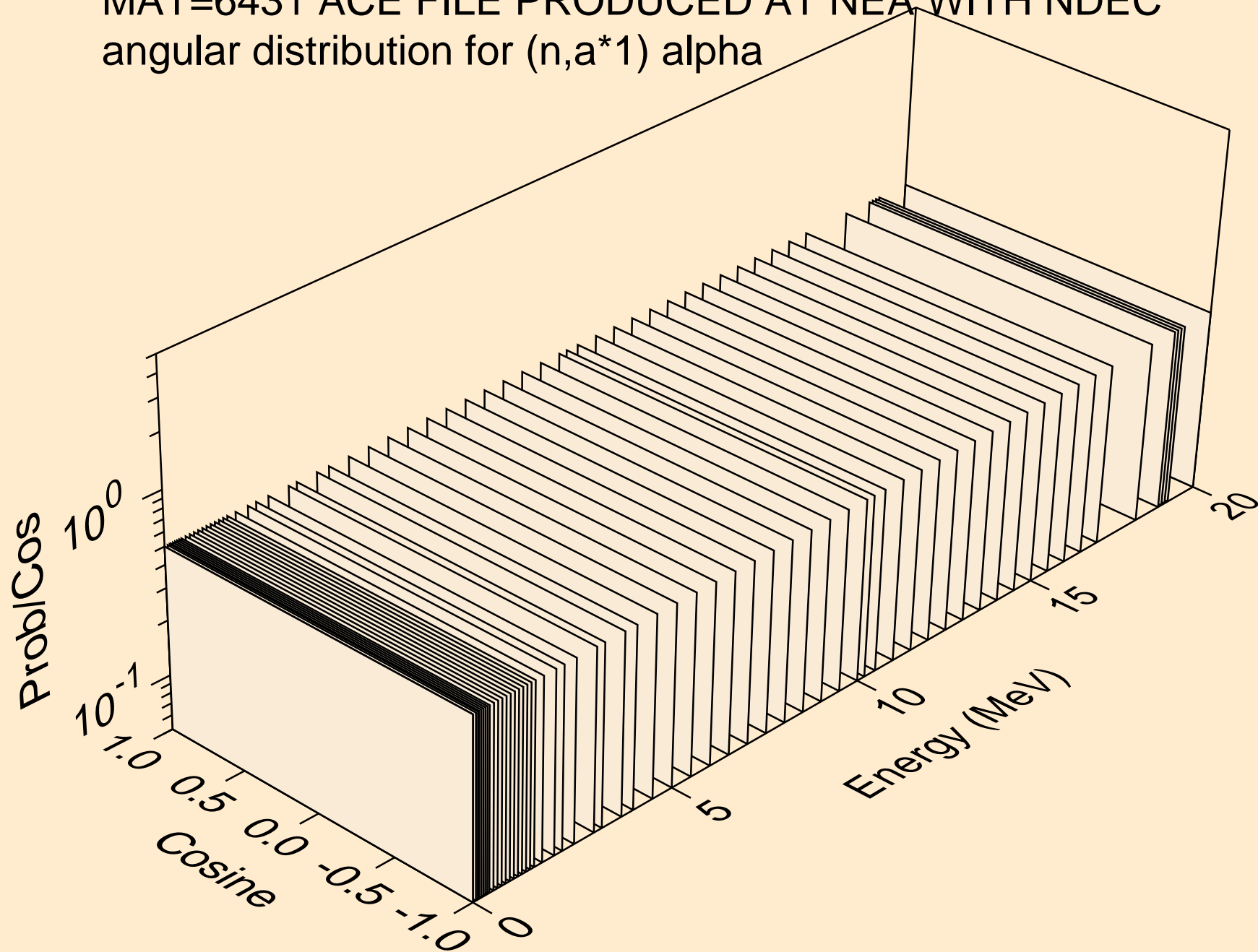

MAT=6431 ACE FILE PRODUCED AT NEA WITH NDEC
angular distribution for (n,a*2) alpha

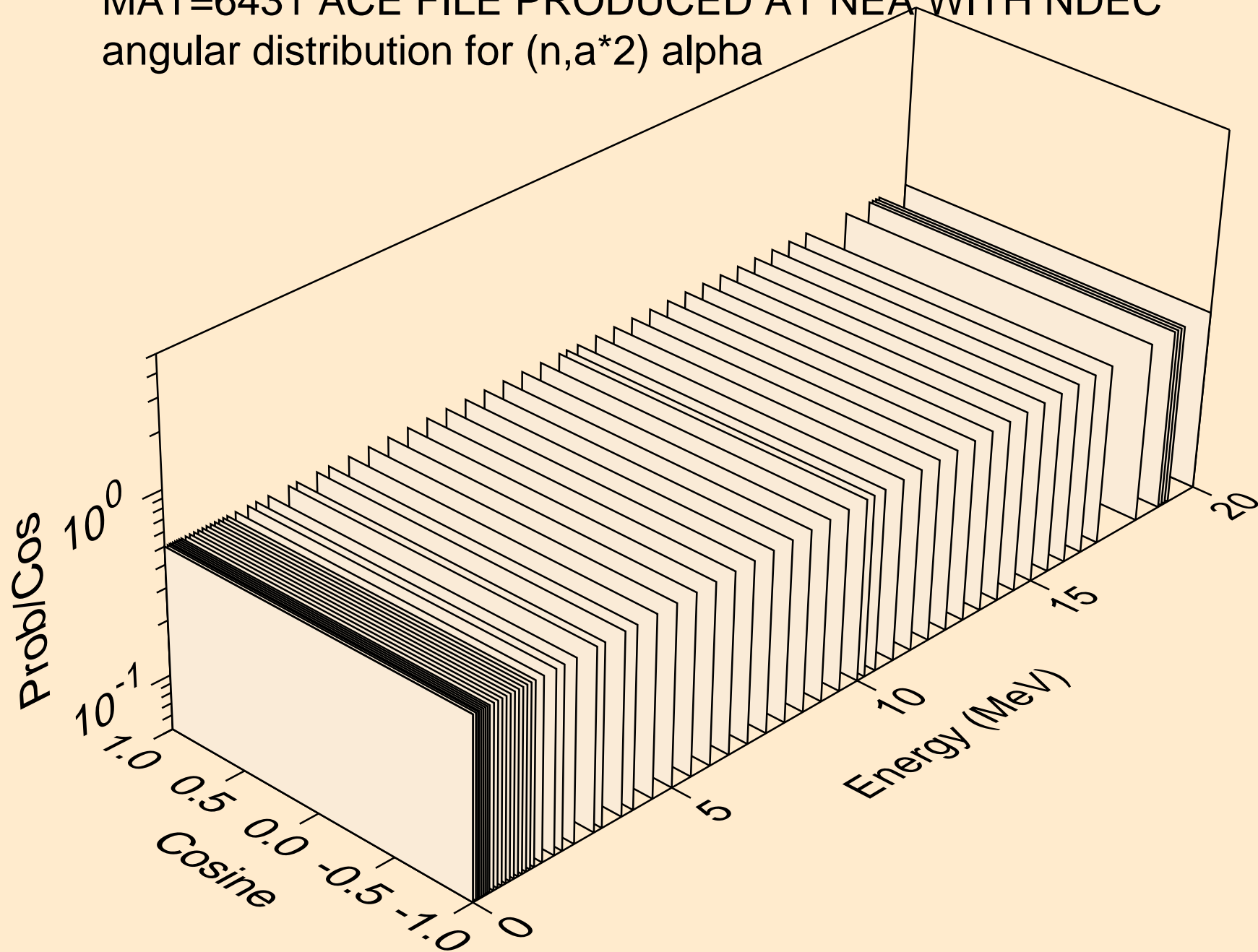

MAT=6431 ACE FILE PRODUCED AT NEA WITH NDEC
angular distribution for (n,a*3) alpha

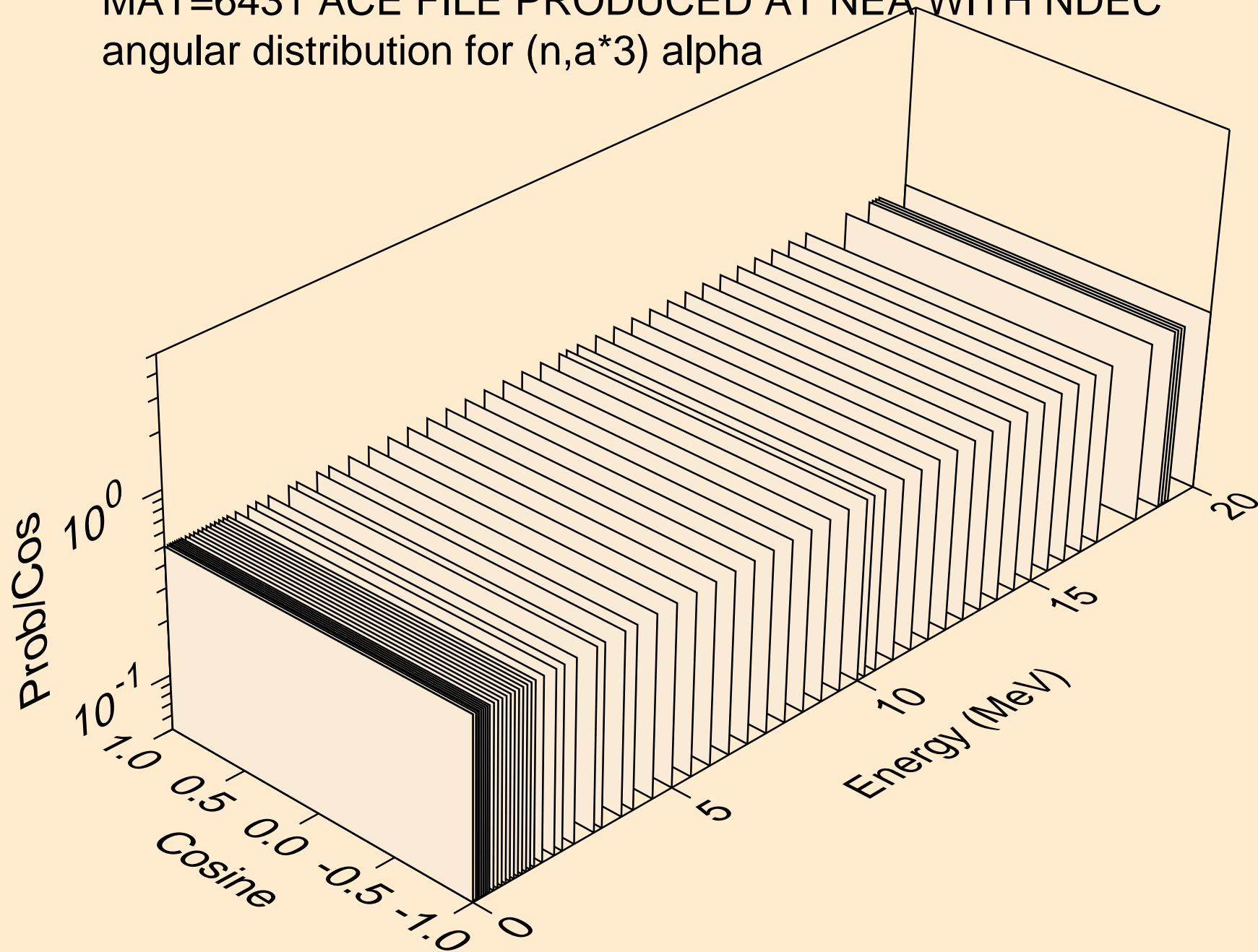

MAT=6431 ACE FILE PRODUCED AT NEA WITH NDEC
angular distribution for (n,a*4) alpha

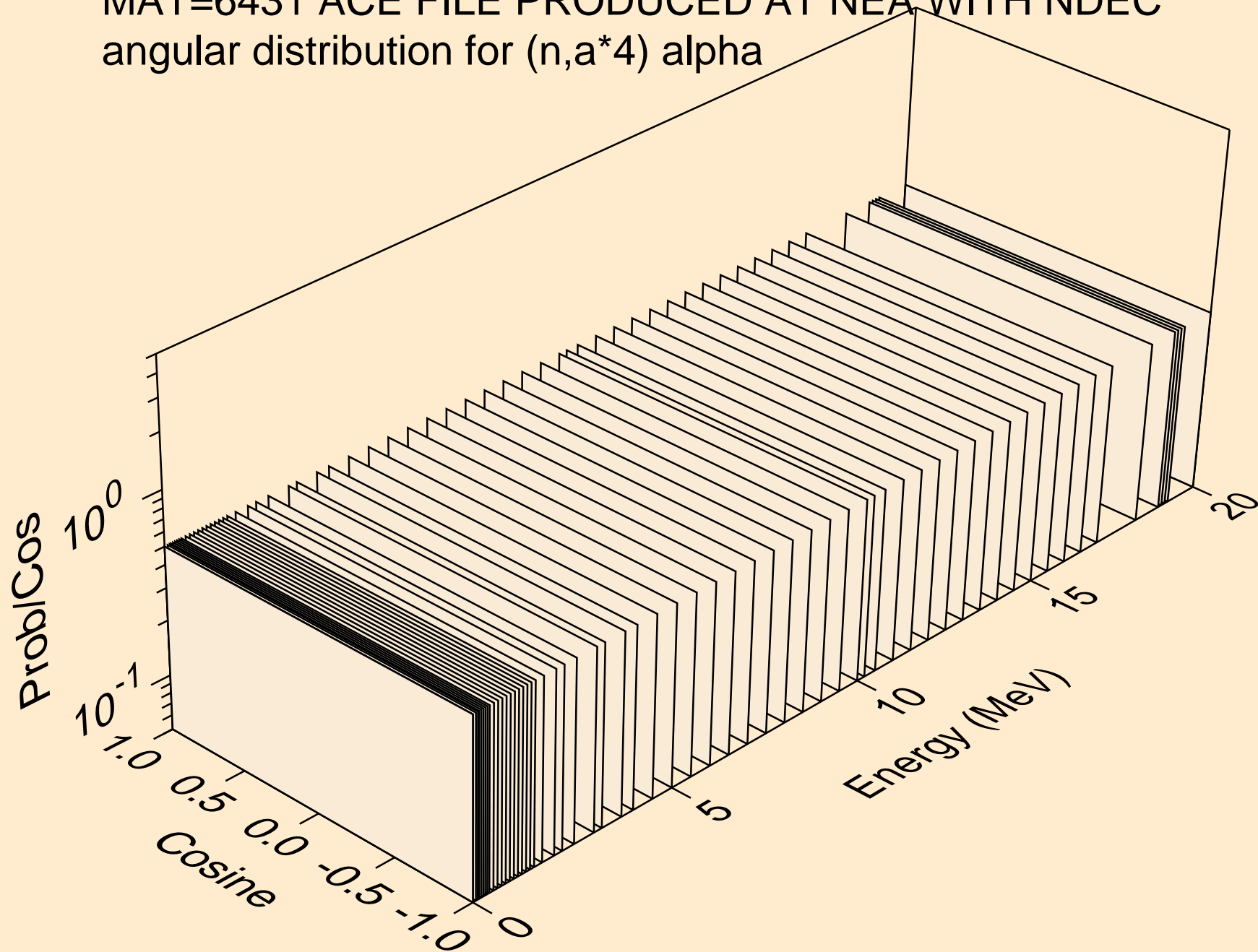

MAT=6431 ACE FILE PRODUCED AT NEA WITH NDEC
angular distribution for (n,a*5) alpha

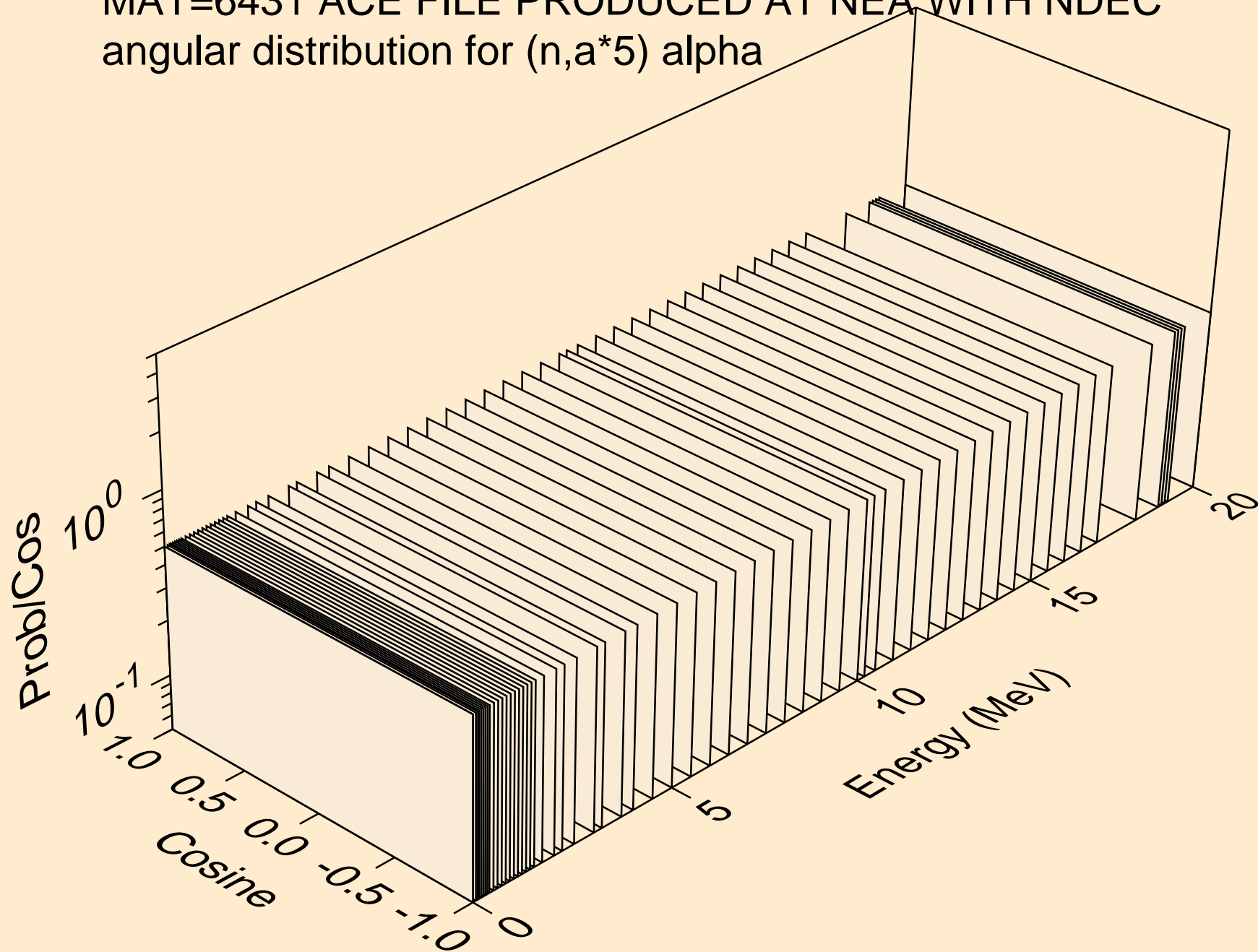

MAT=6431 ACE FILE PRODUCED AT NEA WITH NDEC
angular distribution for (n,a*6) alpha

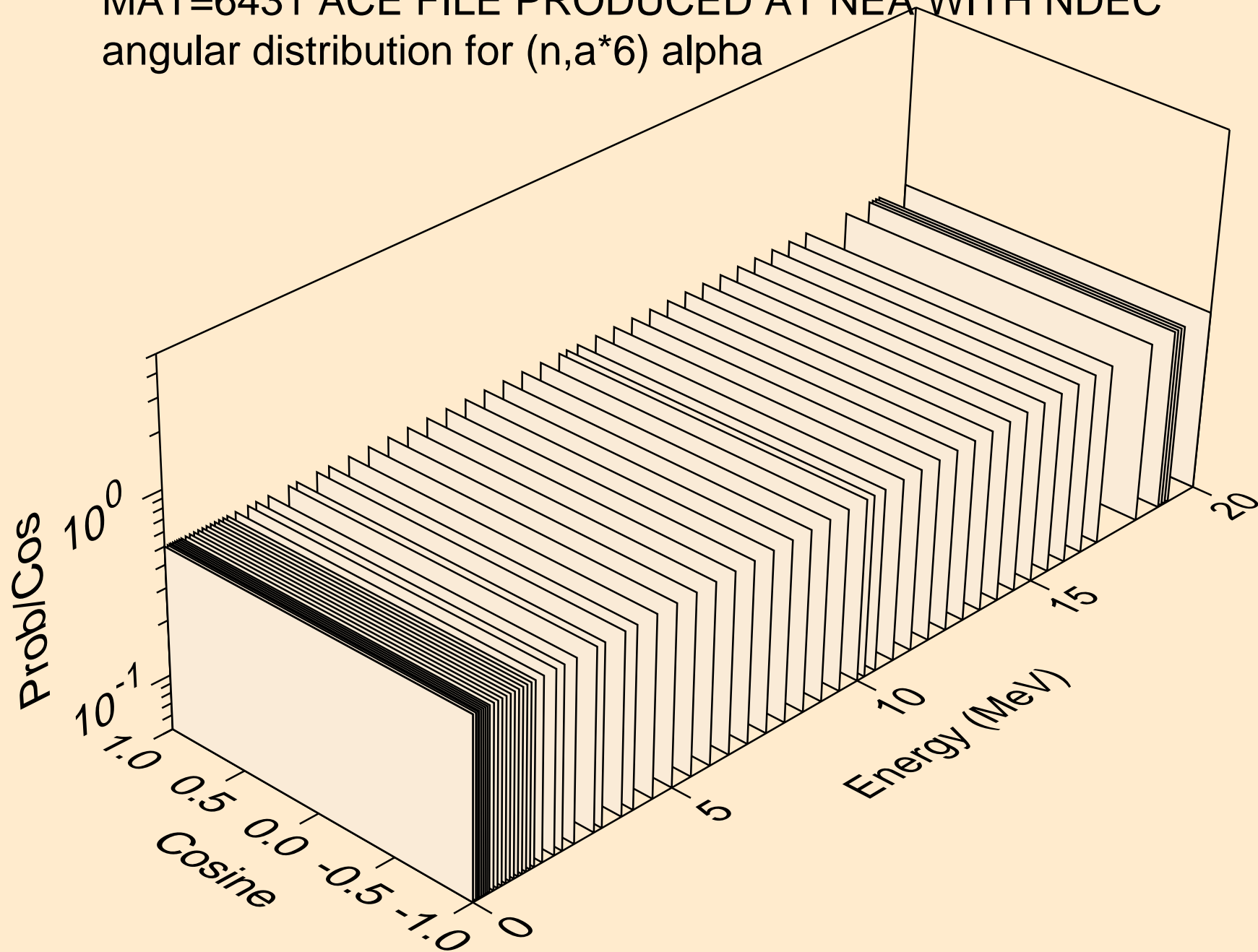

MAT=6431 ACE FILE PRODUCED AT NEA WITH NDEC
angular distribution for (n,a*7) alpha

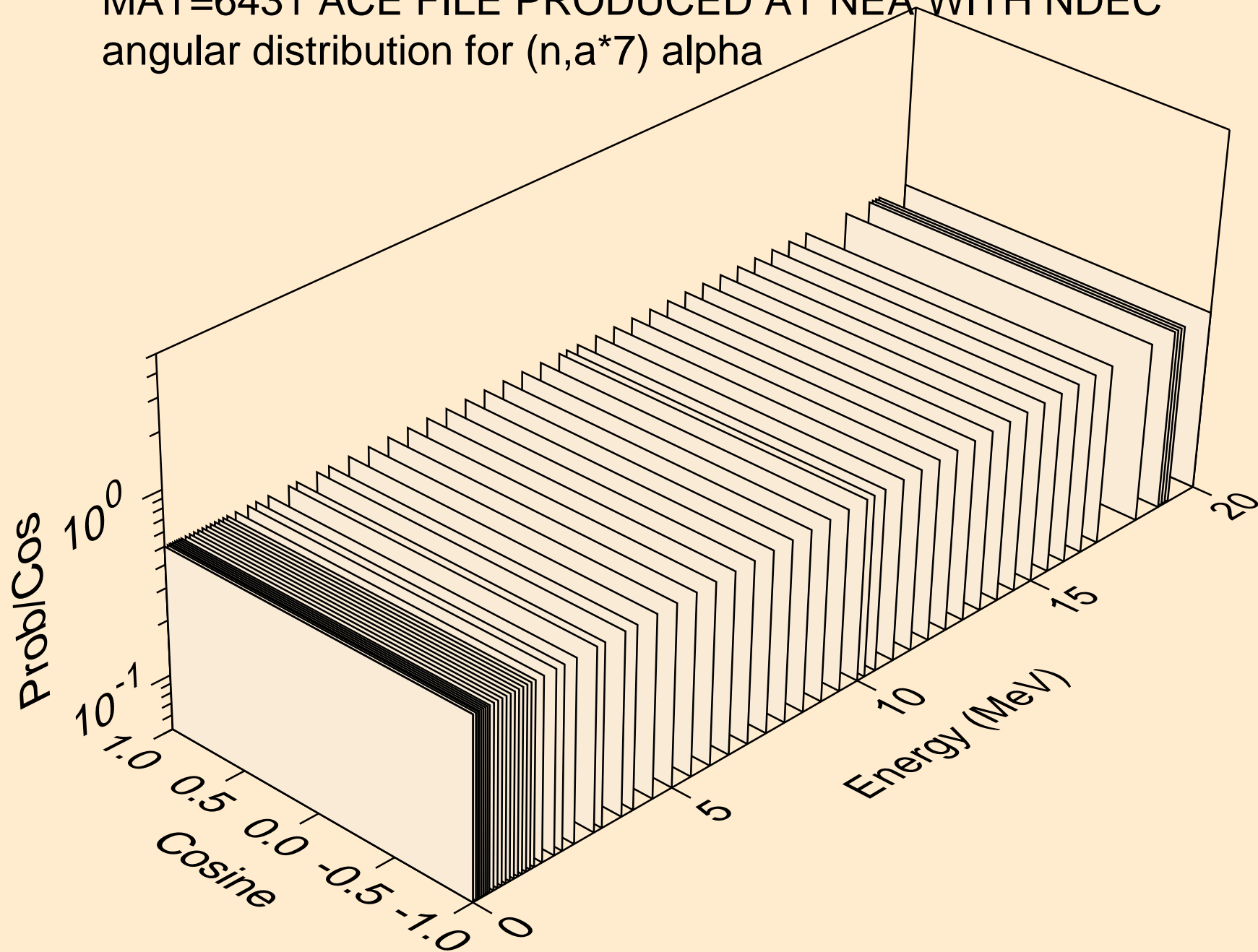

MAT=6431 ACE FILE PRODUCED AT NEA WITH NDEC
angular distribution for (n,a*8) alpha

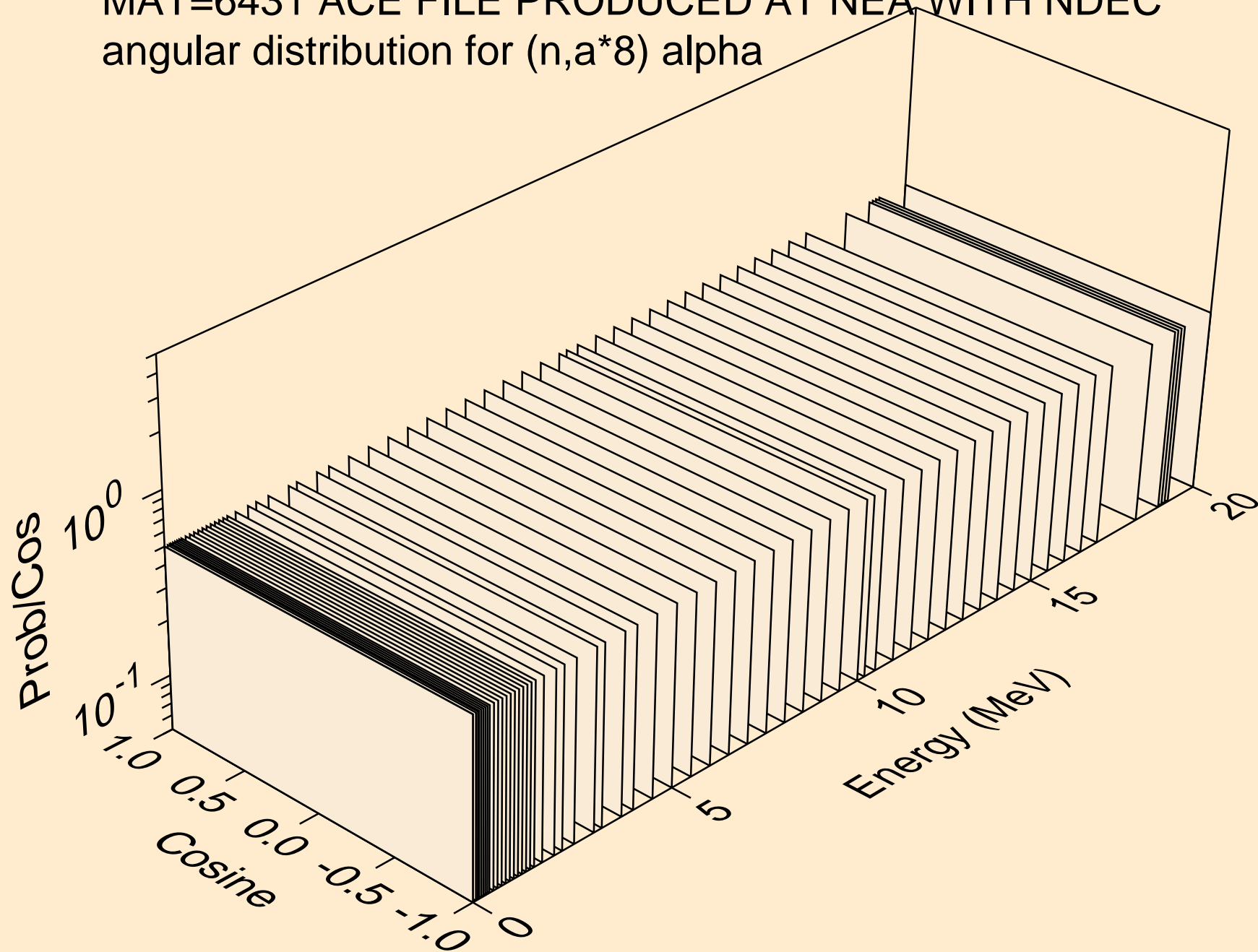

MAT=6431 ACE FILE PRODUCED AT NEA WITH NDEC
angular distribution for (n,a*9) alpha

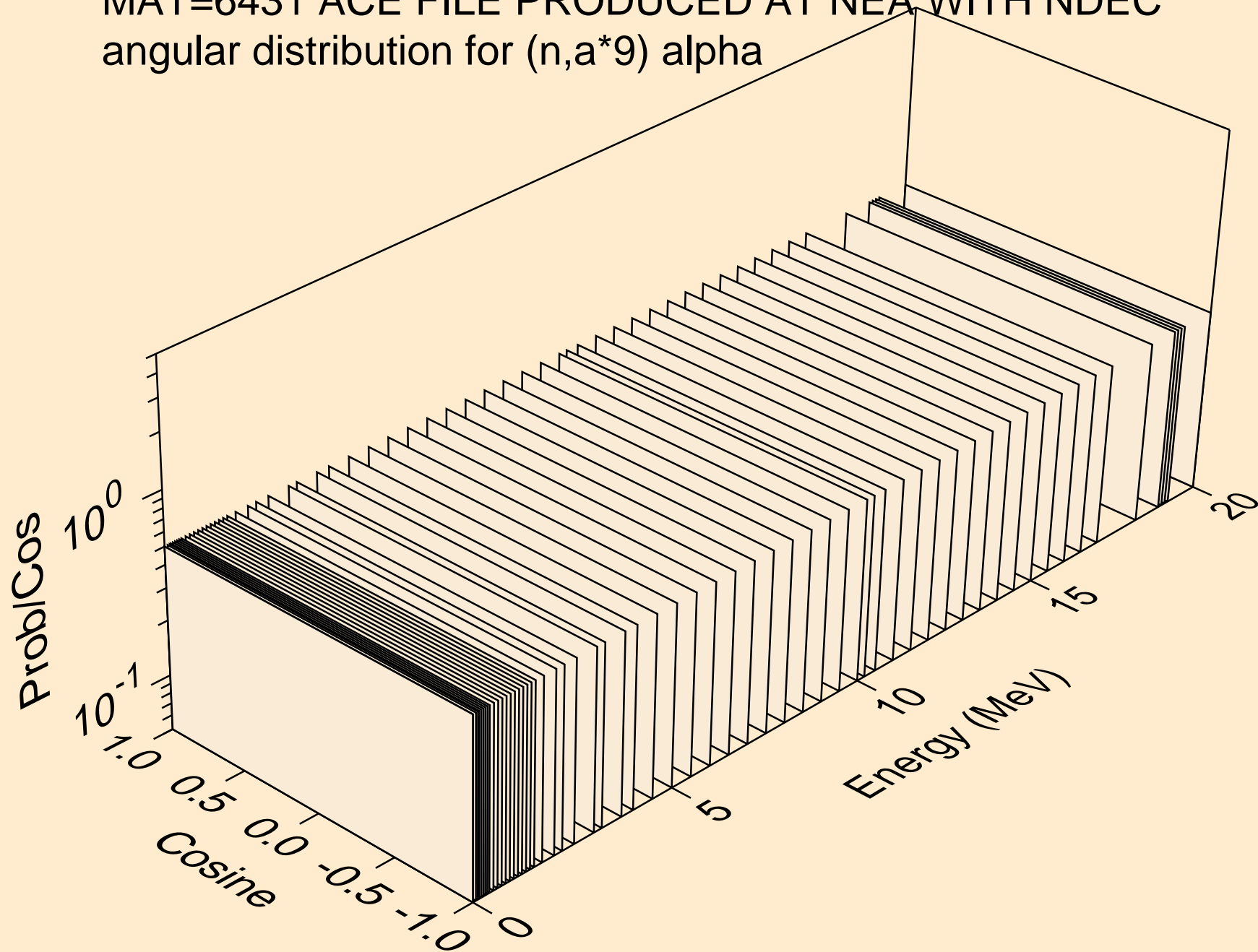

MAT=6431 ACE FILE PRODUCED AT NEA WITH NDEC
alphas from (n,a*c)

