

MAT=1325 ACE FILE PRODUCED AT NEA WITH NDEC  
Principal cross sections

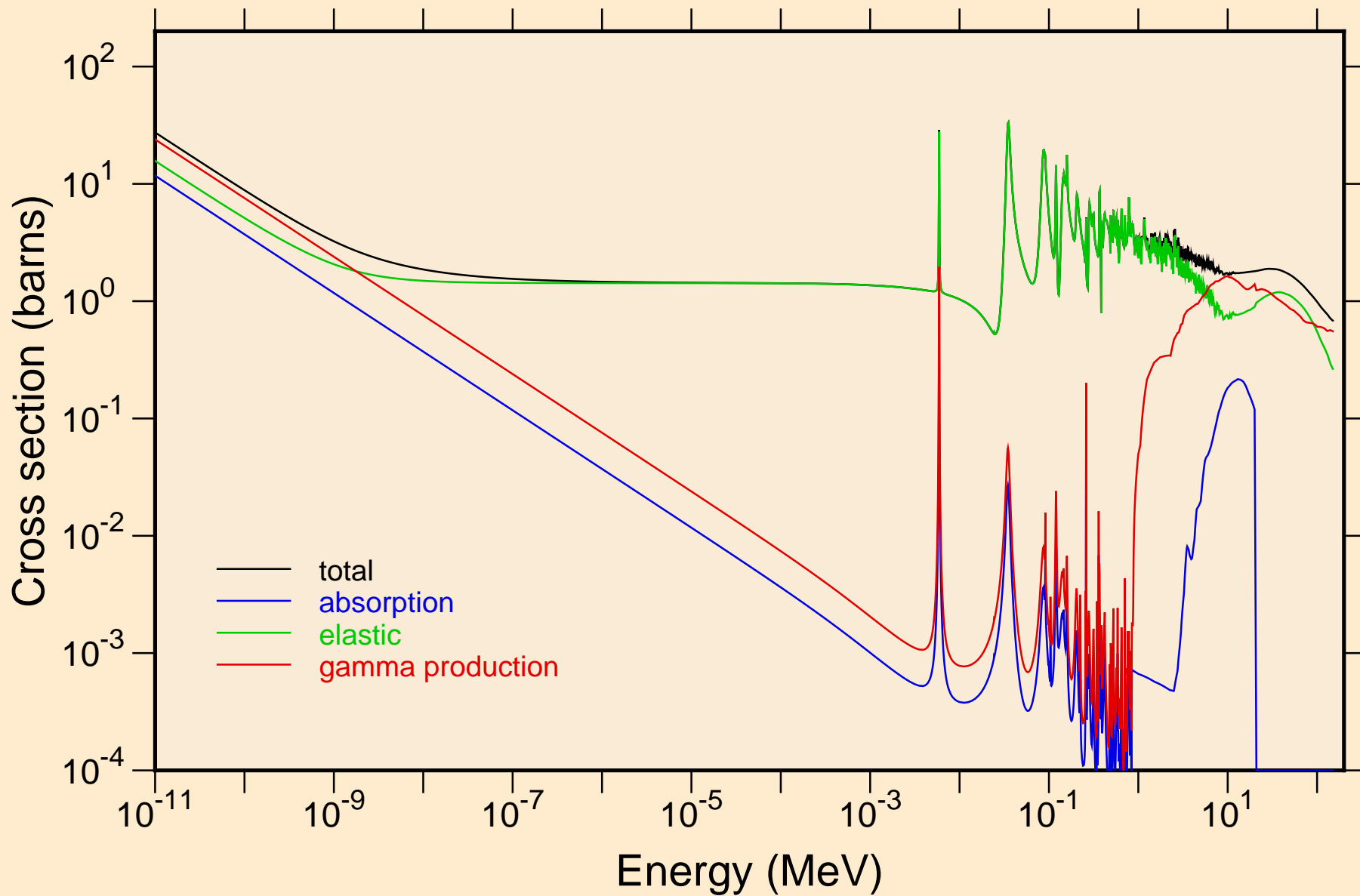

MAT=1325 ACE FILE PRODUCED AT NEA WITH NDEC  
resonance total cross section

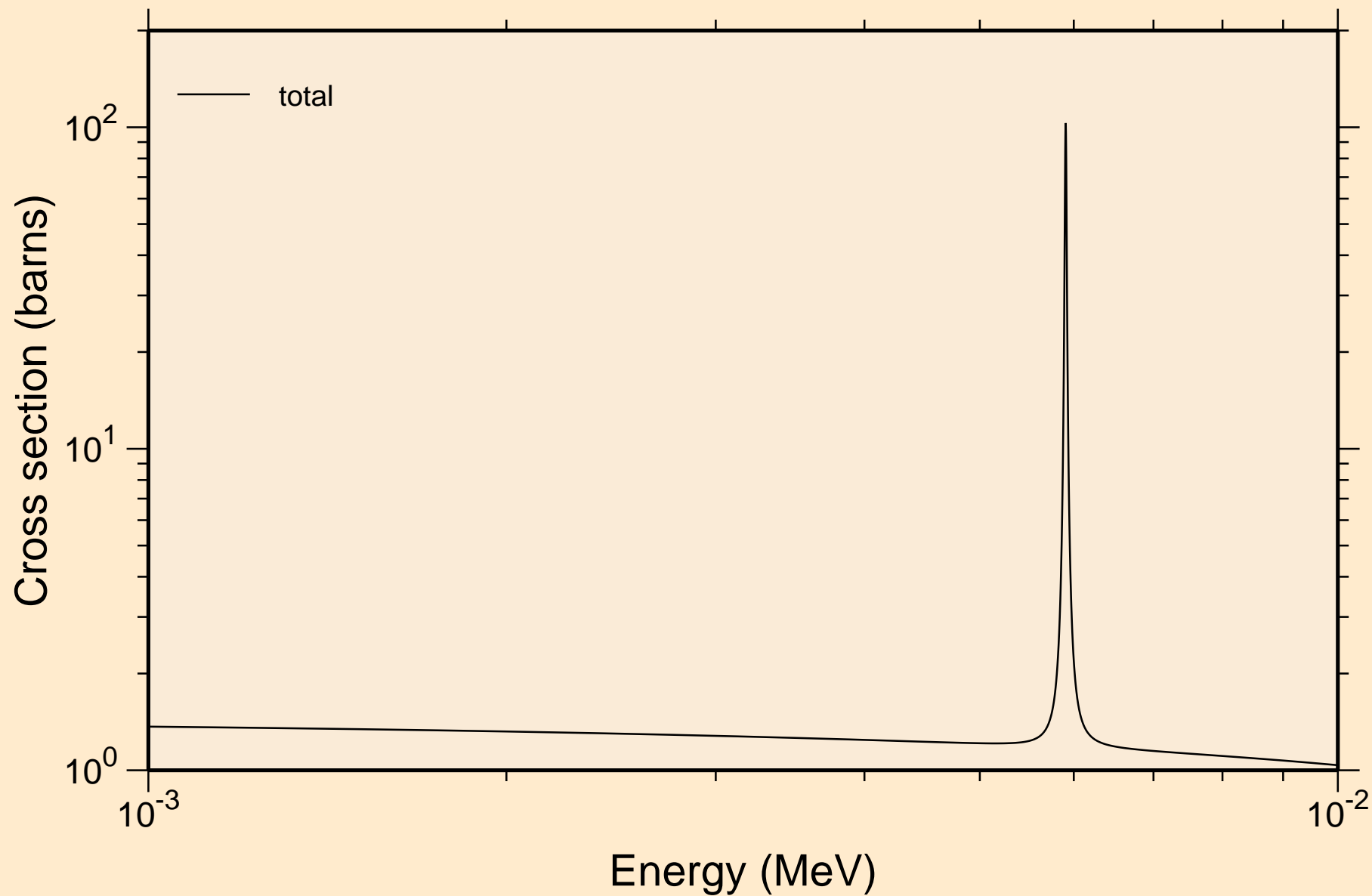

MAT=1325 ACE FILE PRODUCED AT NEA WITH NDEC  
resonance total cross section

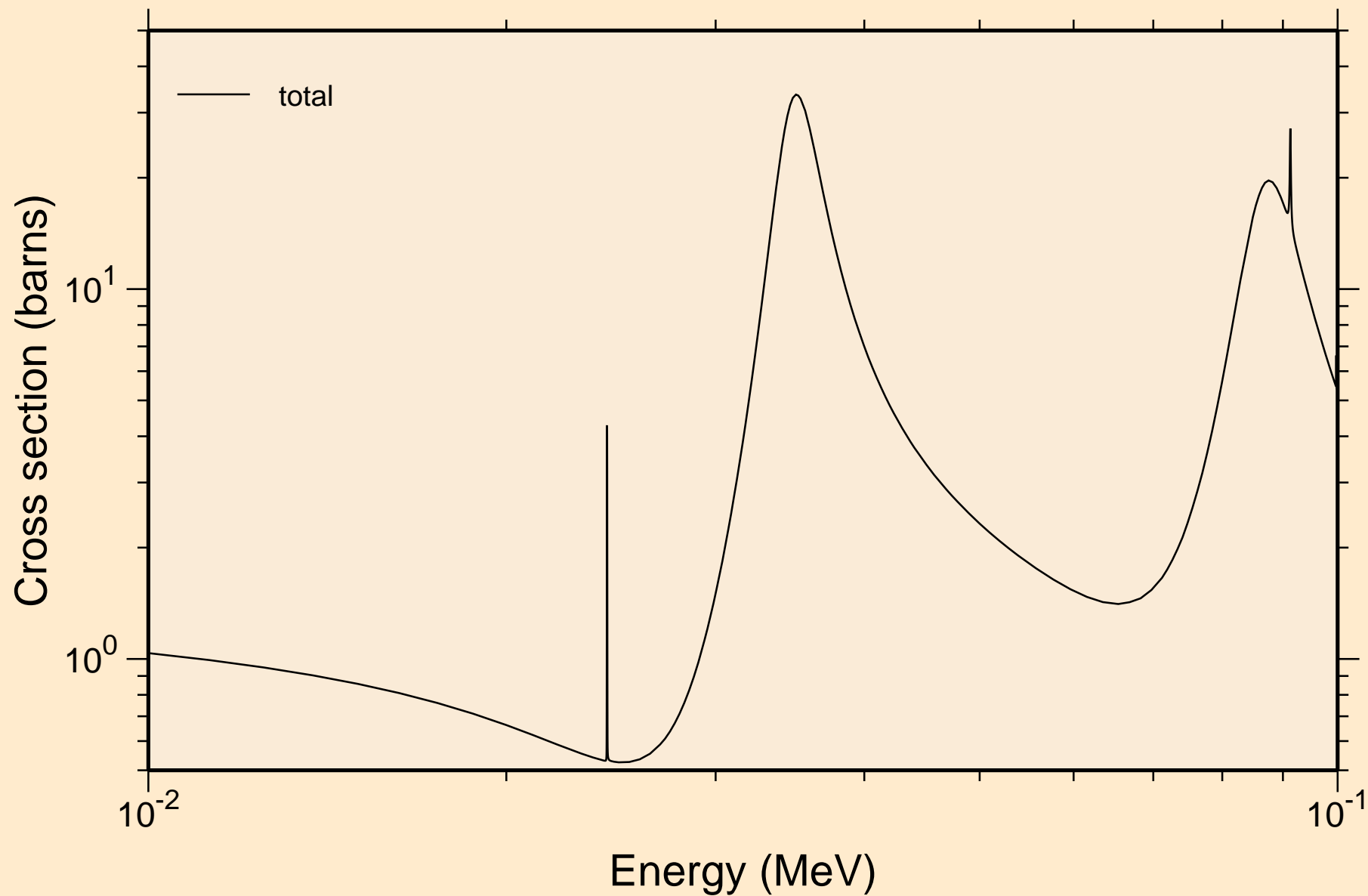

MAT=1325 ACE FILE PRODUCED AT NEA WITH NDEC  
resonance total cross section

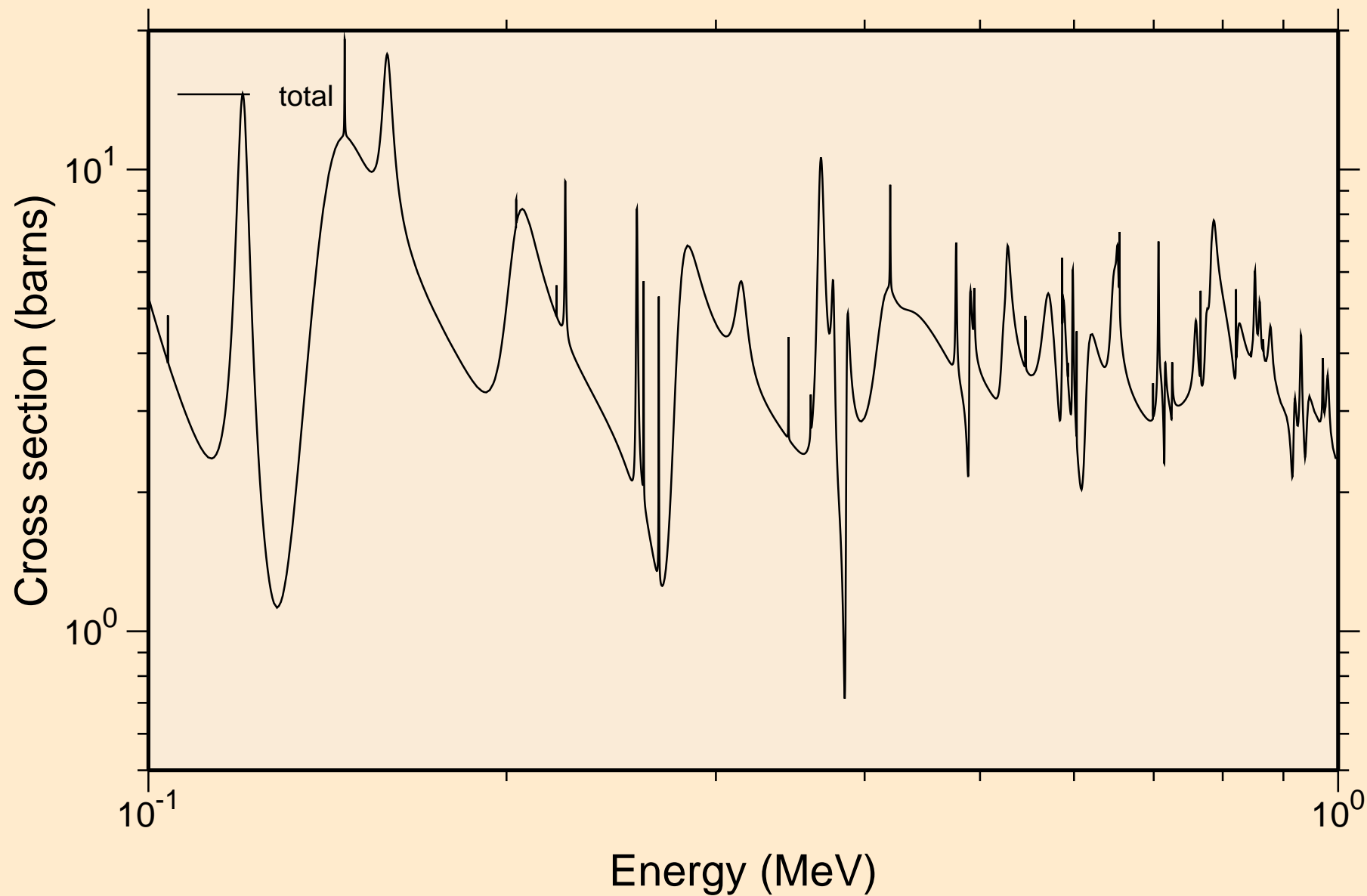

MAT=1325 ACE FILE PRODUCED AT NEA WITH NDEC  
resonance total cross section

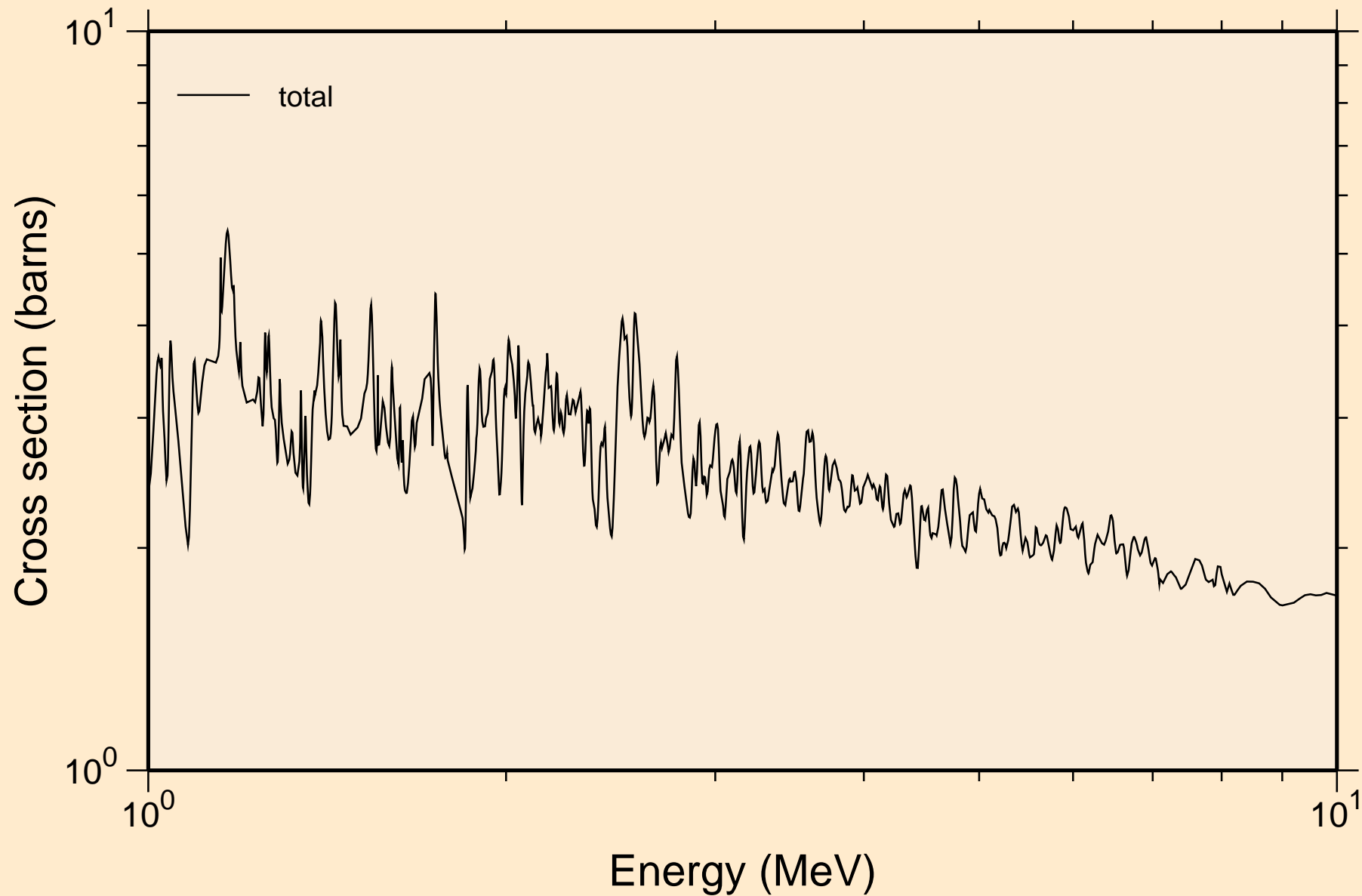

MAT=1325 ACE FILE PRODUCED AT NEA WITH NDEC  
resonance absorption cross sections

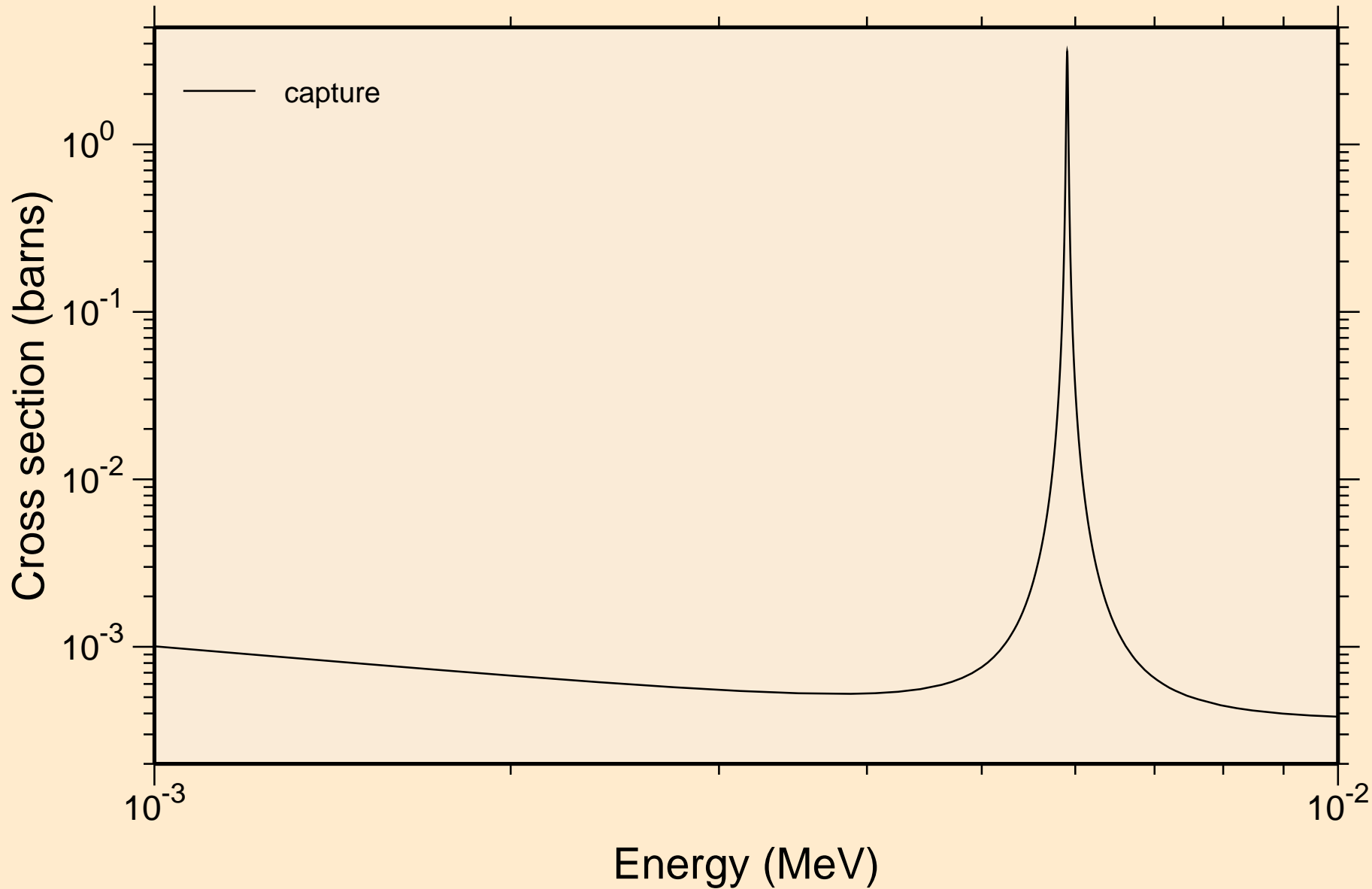

MAT=1325 ACE FILE PRODUCED AT NEA WITH NDEC  
resonance absorption cross sections

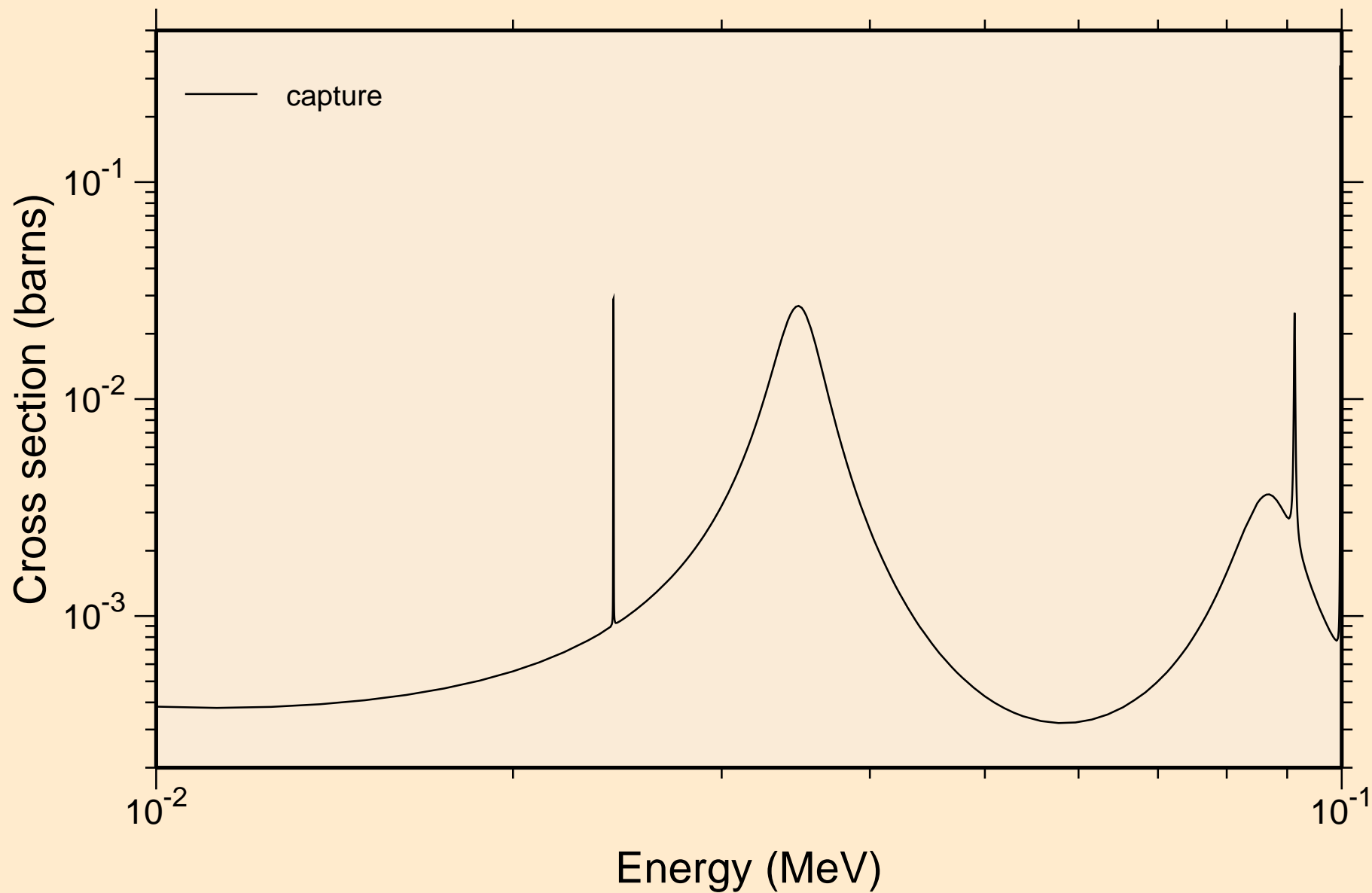

MAT=1325 ACE FILE PRODUCED AT NEA WITH NDEC  
resonance absorption cross sections

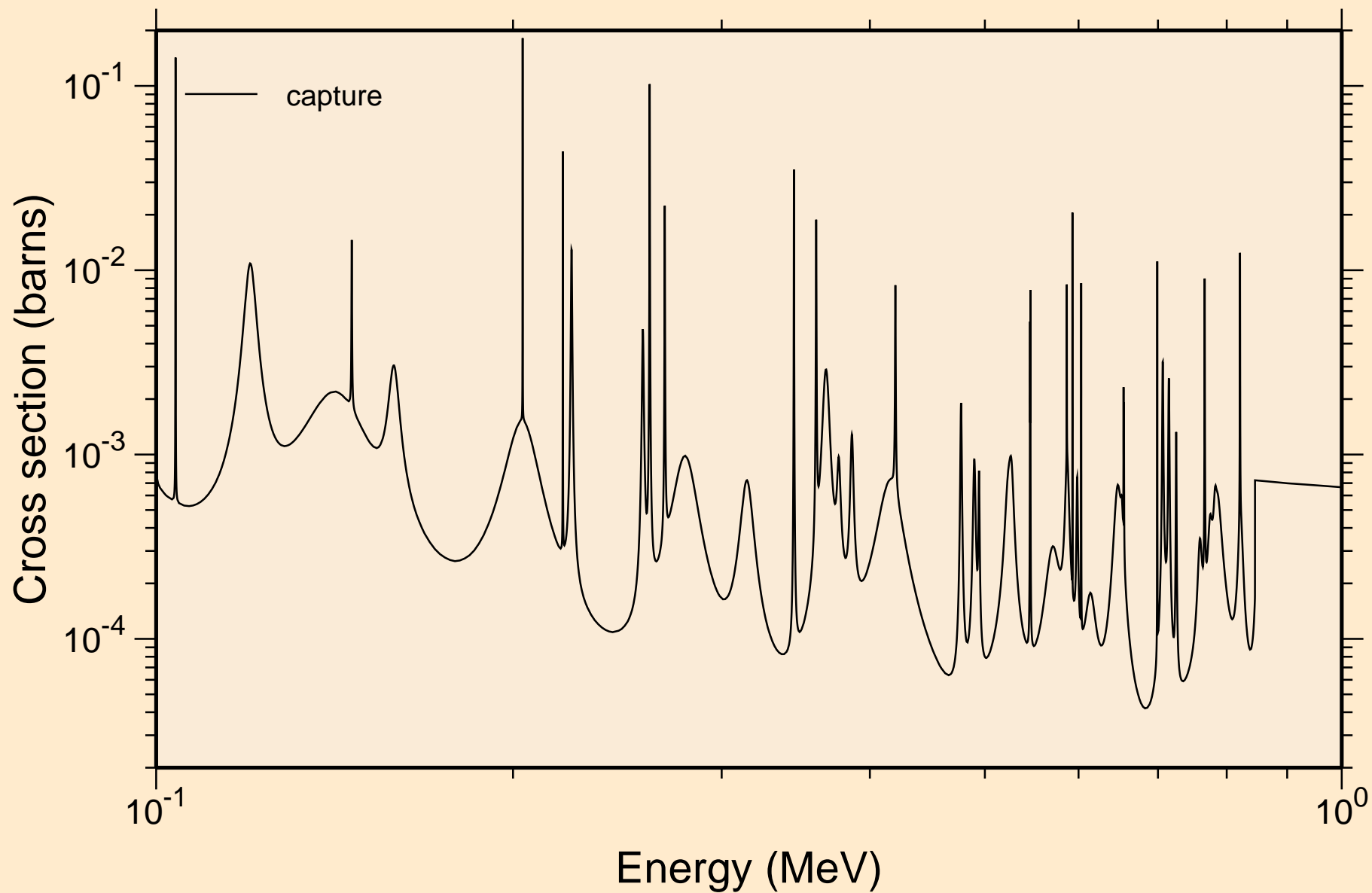



MAT=1325 ACE FILE PRODUCED AT NEA WITH NDEC  
resonance absorption cross sections

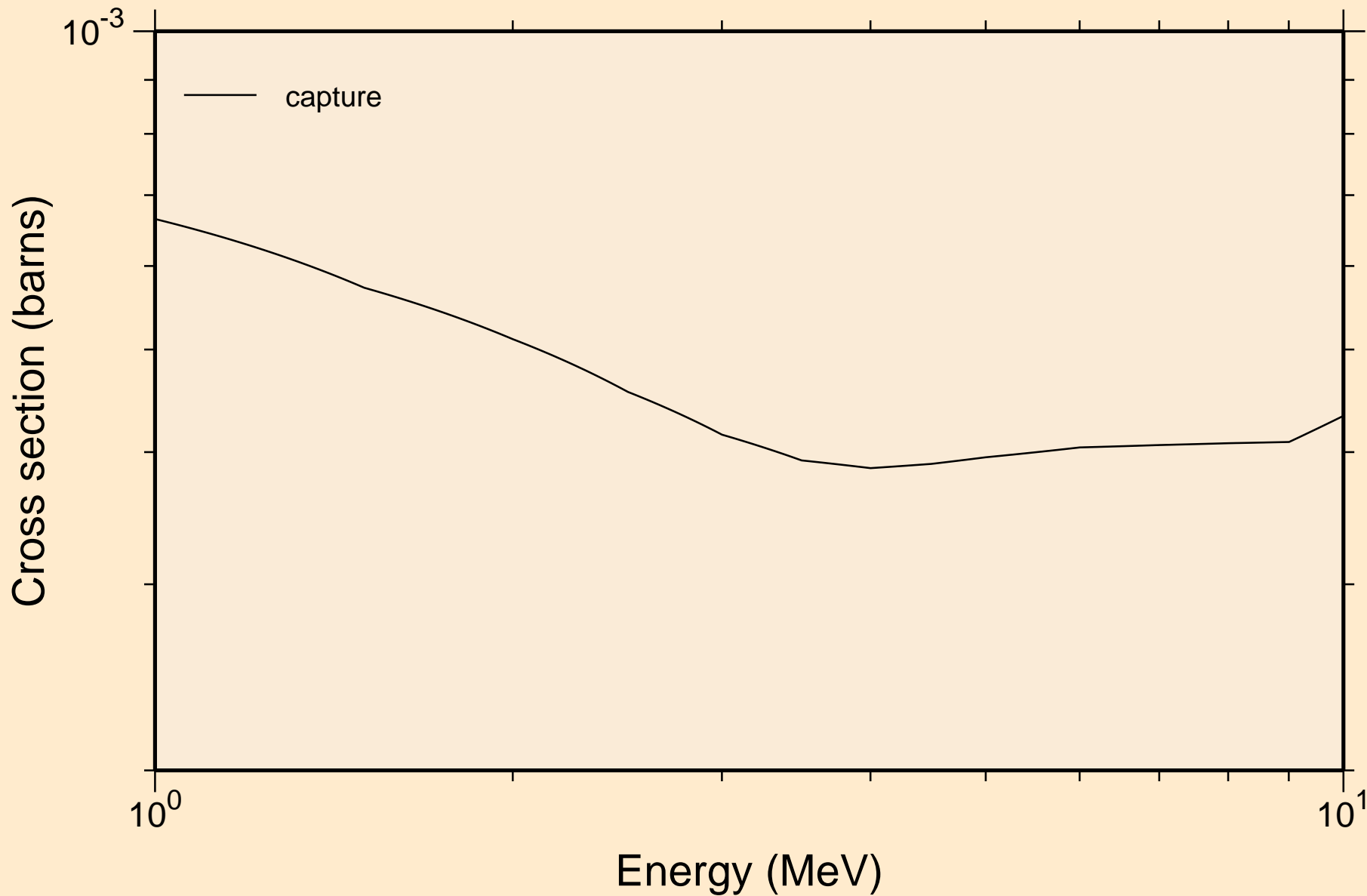

MAT=1325 ACE FILE PRODUCED AT NEA WITH NDEC  
Heating

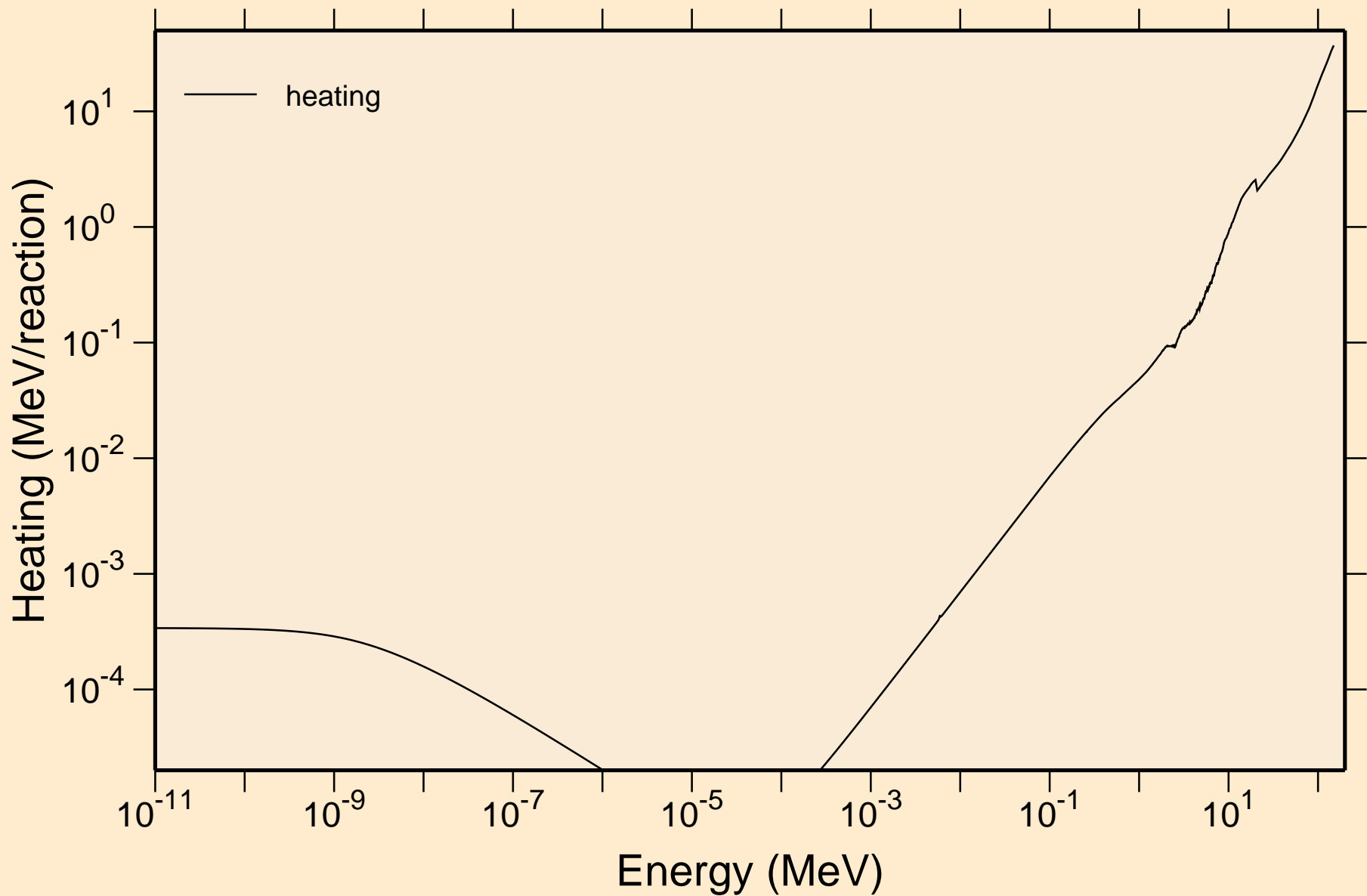

MAT=1325 ACE FILE PRODUCED AT NEA WITH NDEC  
Damage

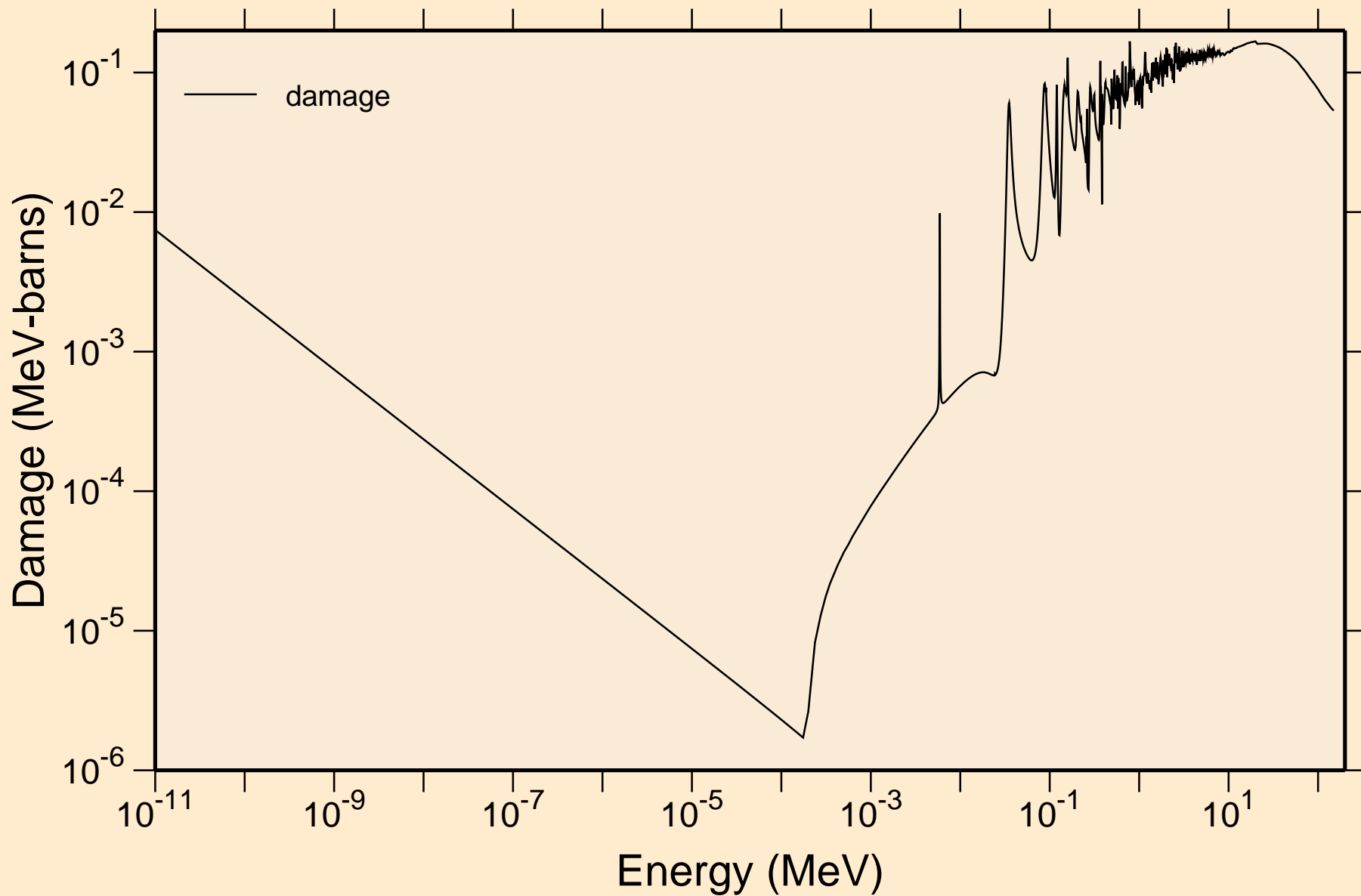

MAT=1325 ACE FILE PRODUCED AT NEA WITH NDEC  
Non-threshold reactions

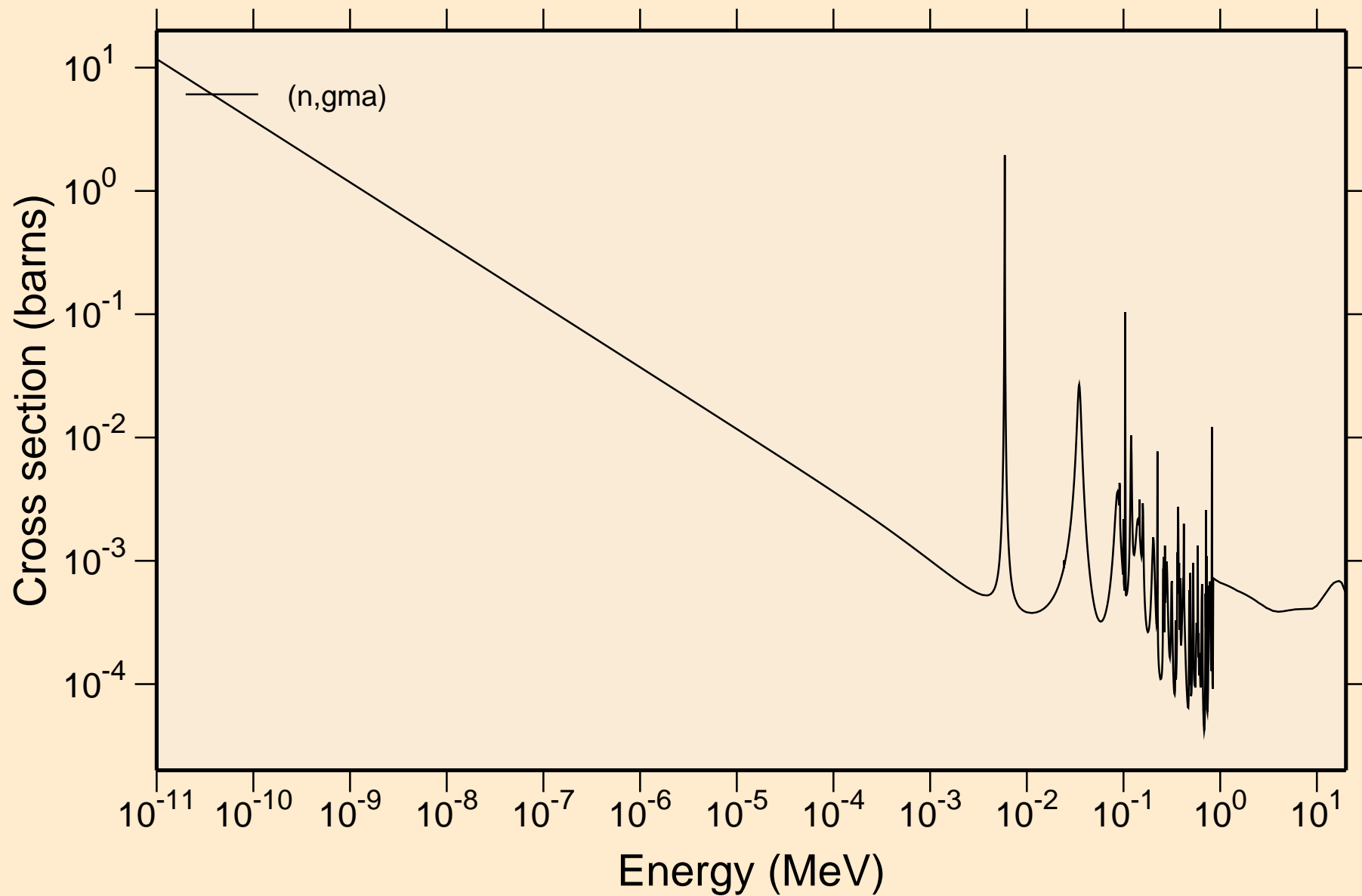

MAT=1325 ACE FILE PRODUCED AT NEA WITH NDEC

Principal cross sections

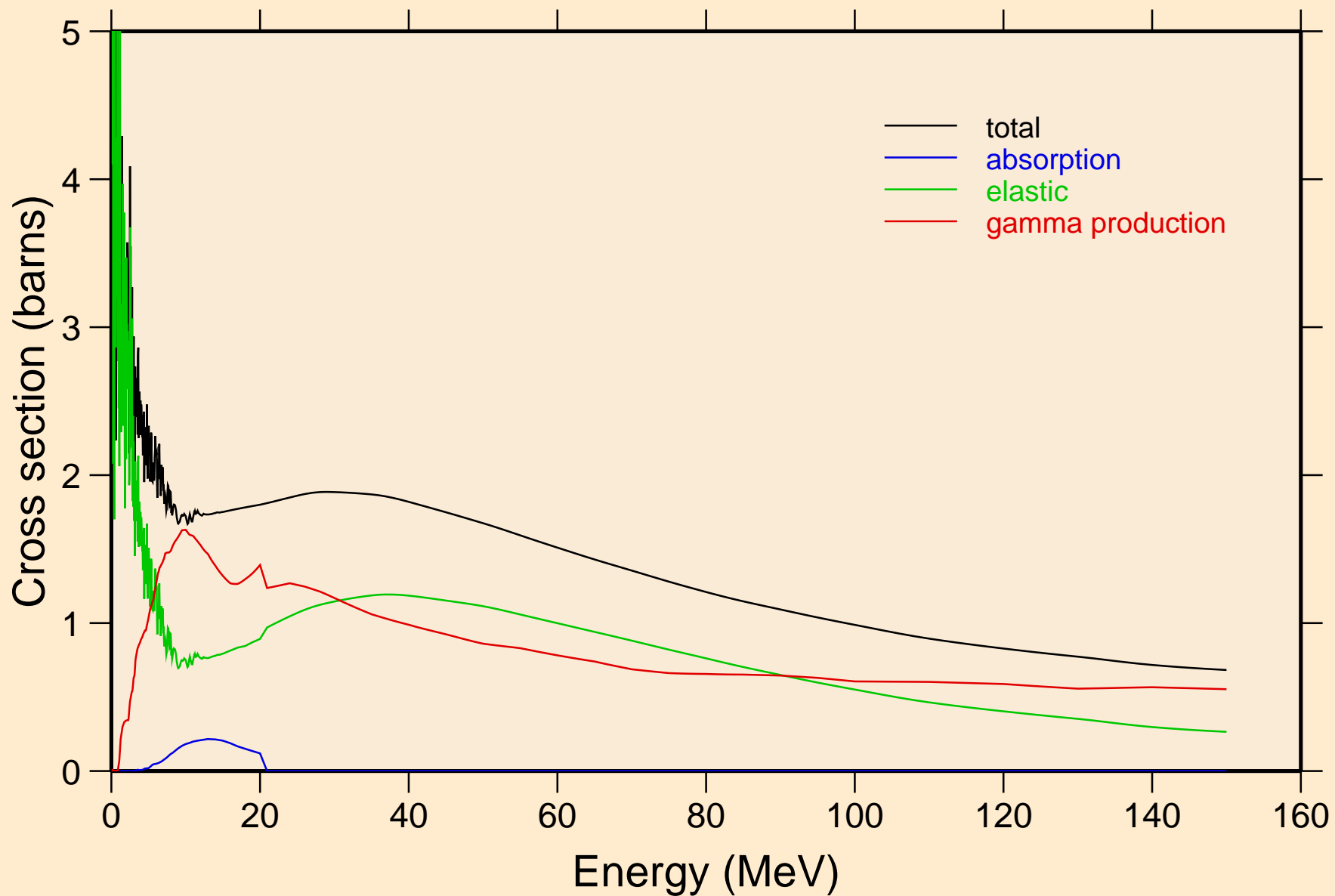

MAT=1325 ACE FILE PRODUCED AT NEA WITH NDEC  
Heating

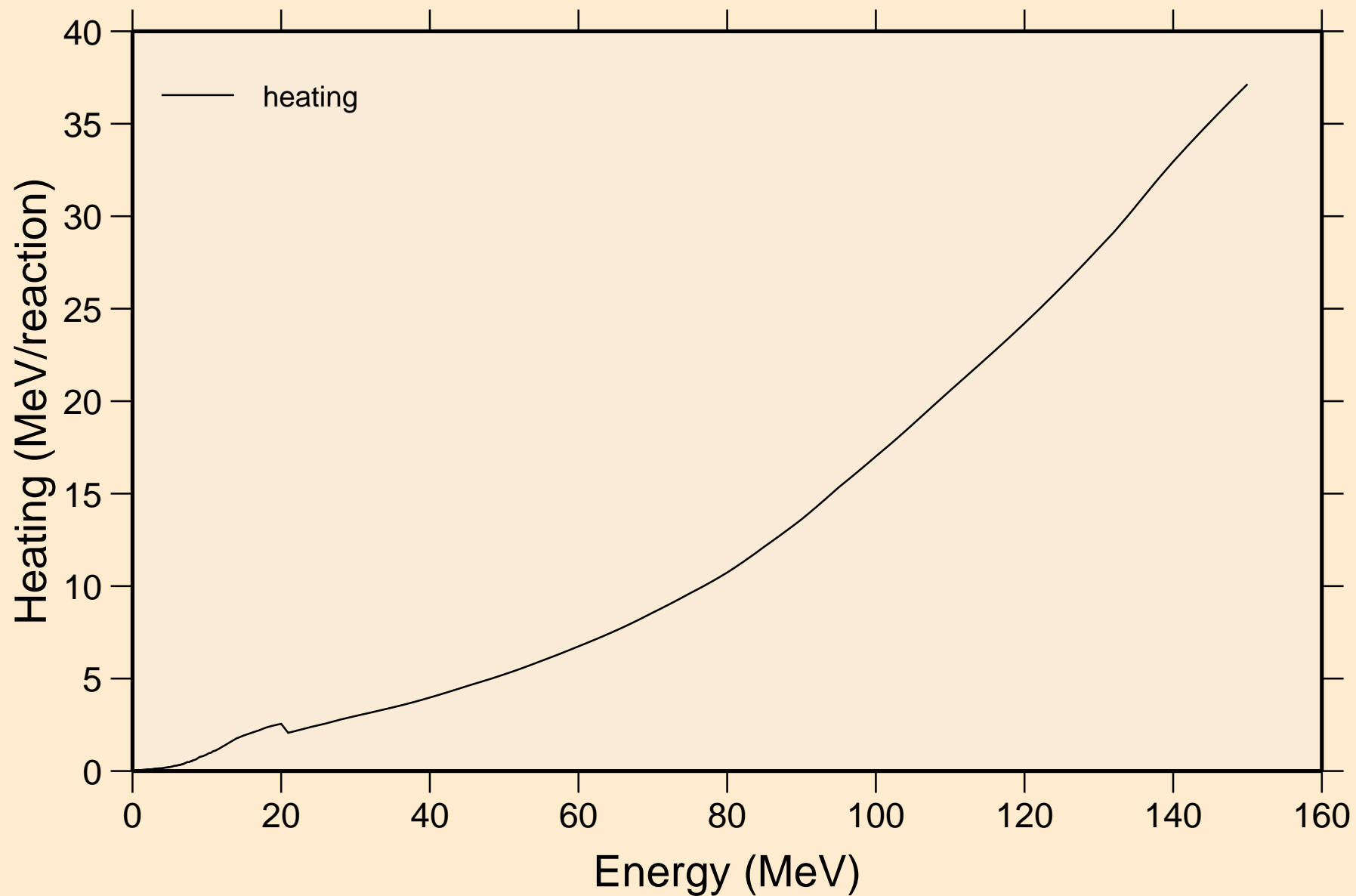

MAT=1325 ACE FILE PRODUCED AT NEA WITH NDEC  
Damage

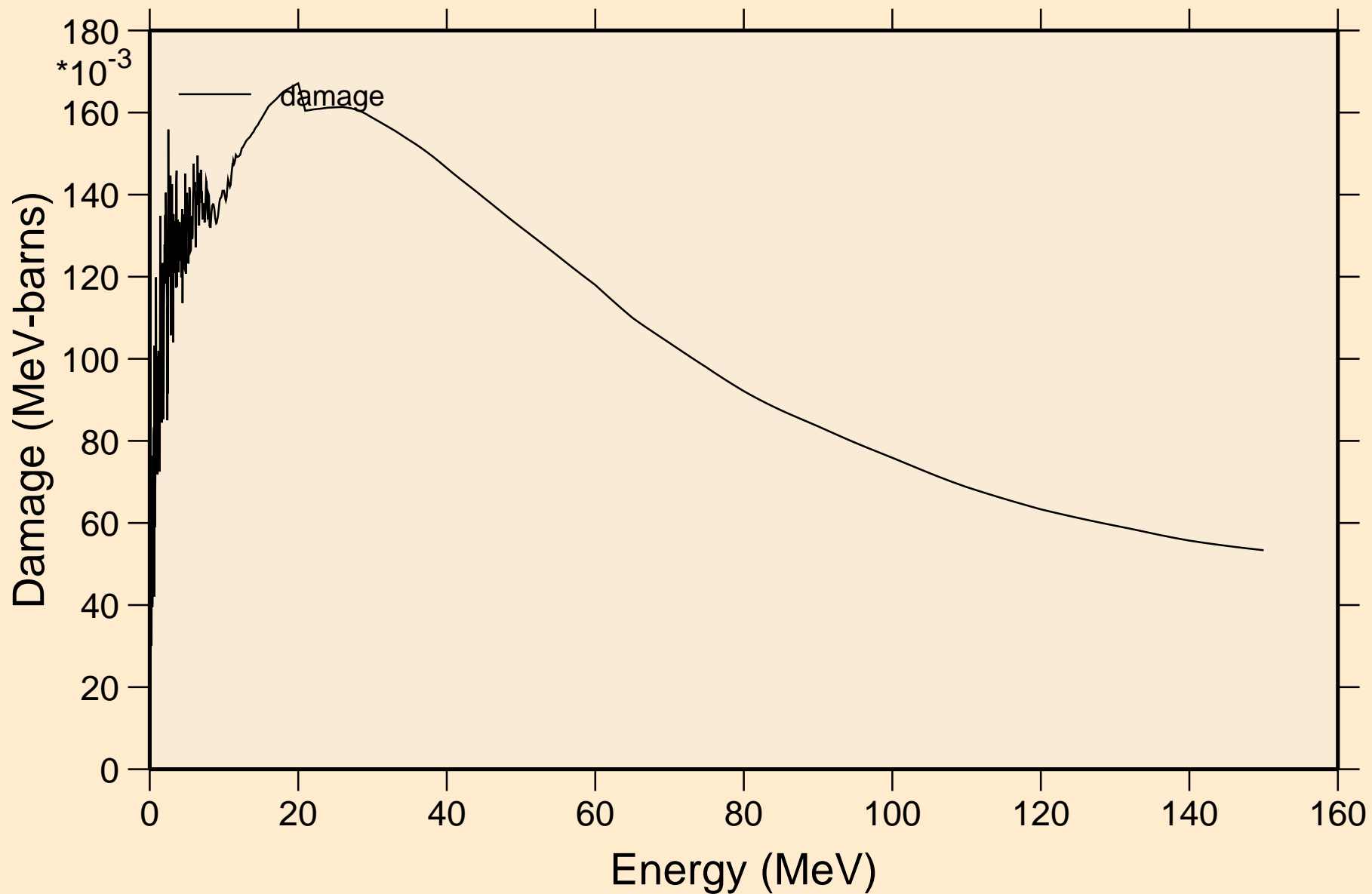

MAT=1325 ACE FILE PRODUCED AT NEA WITH NDEC  
Non-threshold reactions

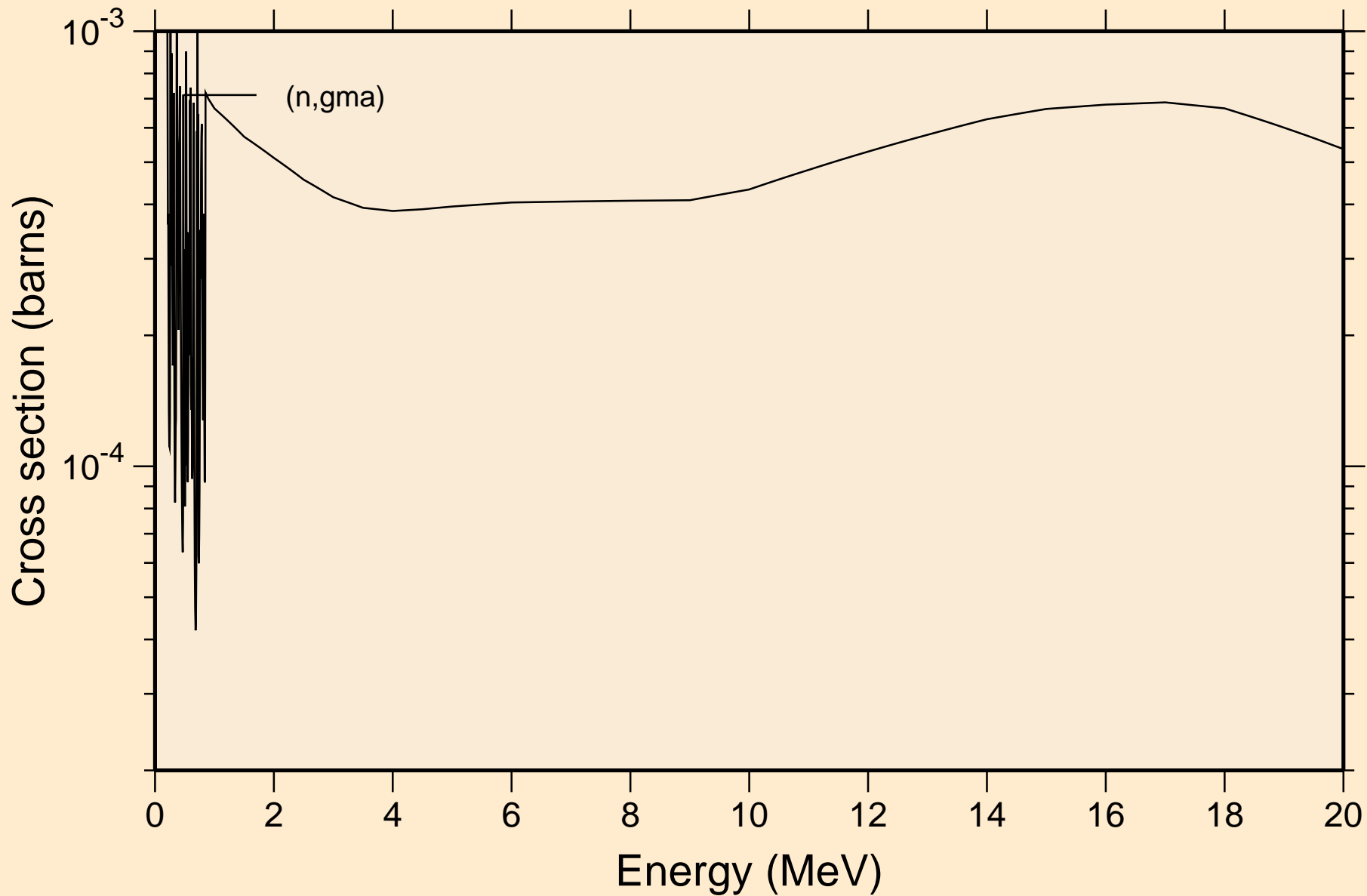



MAT=1325 ACE FILE PRODUCED AT NEA WITH NDEC  
Inelastic levels

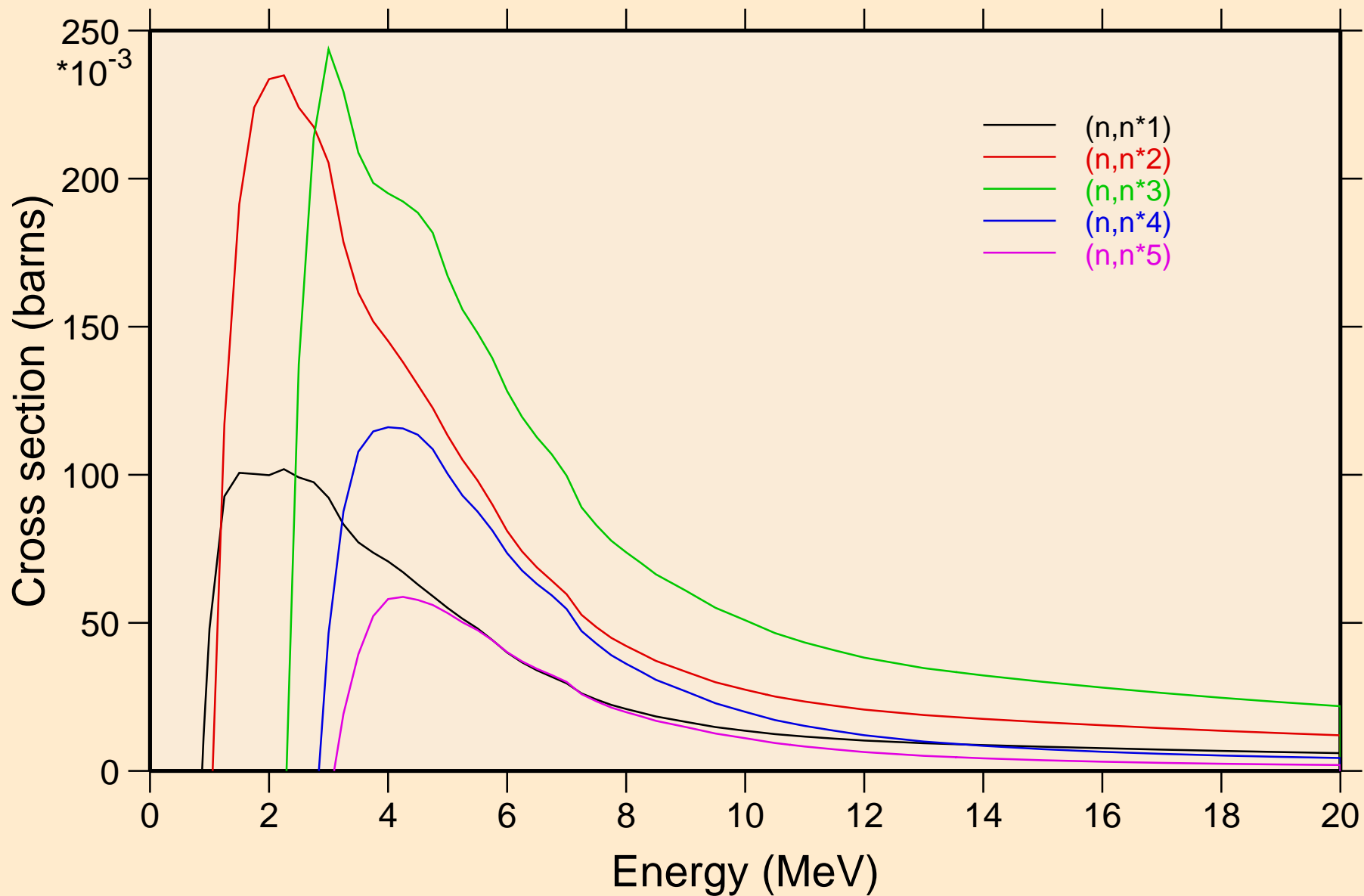

MAT=1325 ACE FILE PRODUCED AT NEA WITH NDEC  
Inelastic levels

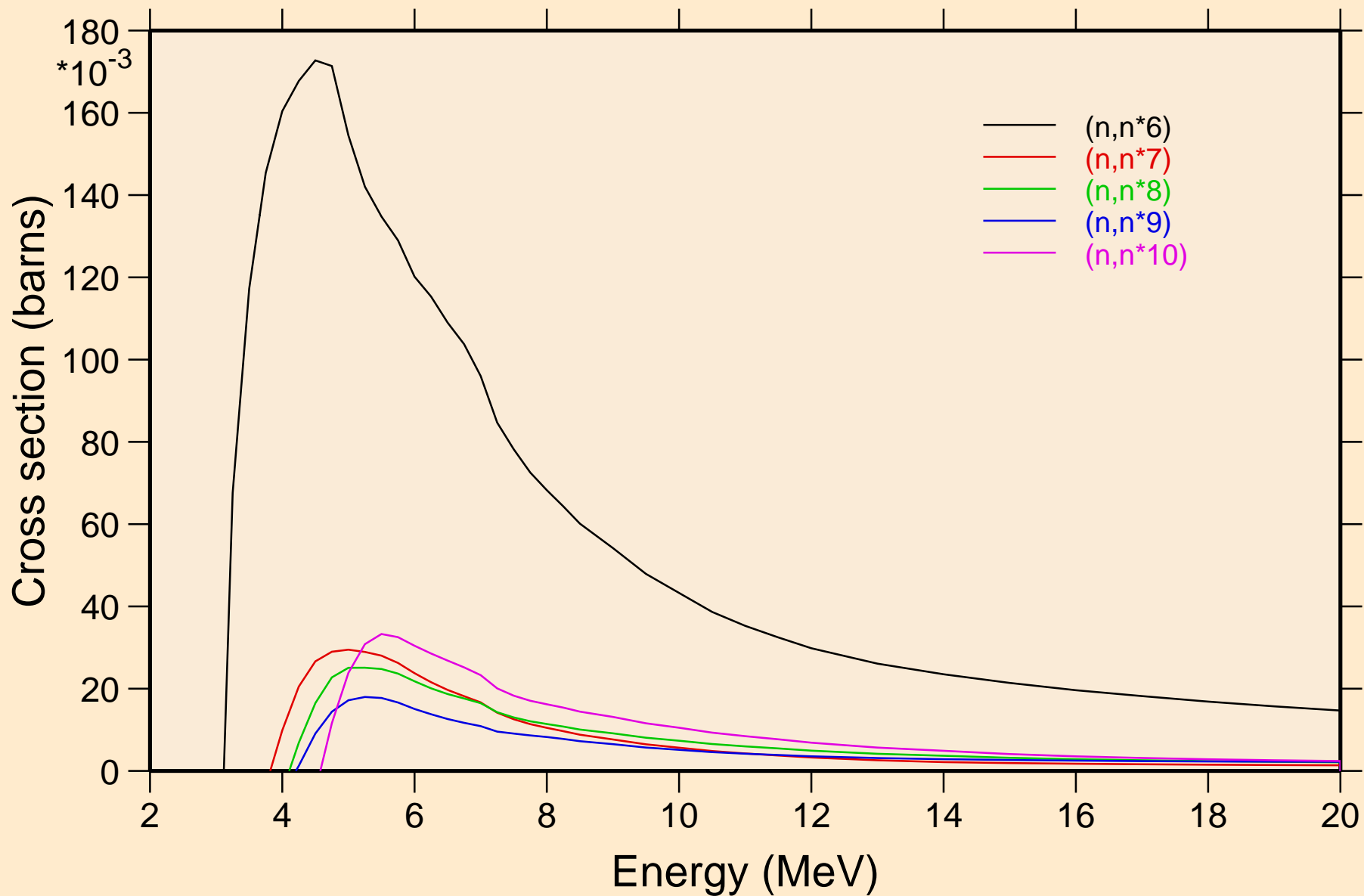

MAT=1325 ACE FILE PRODUCED AT NEA WITH NDEC  
Inelastic levels

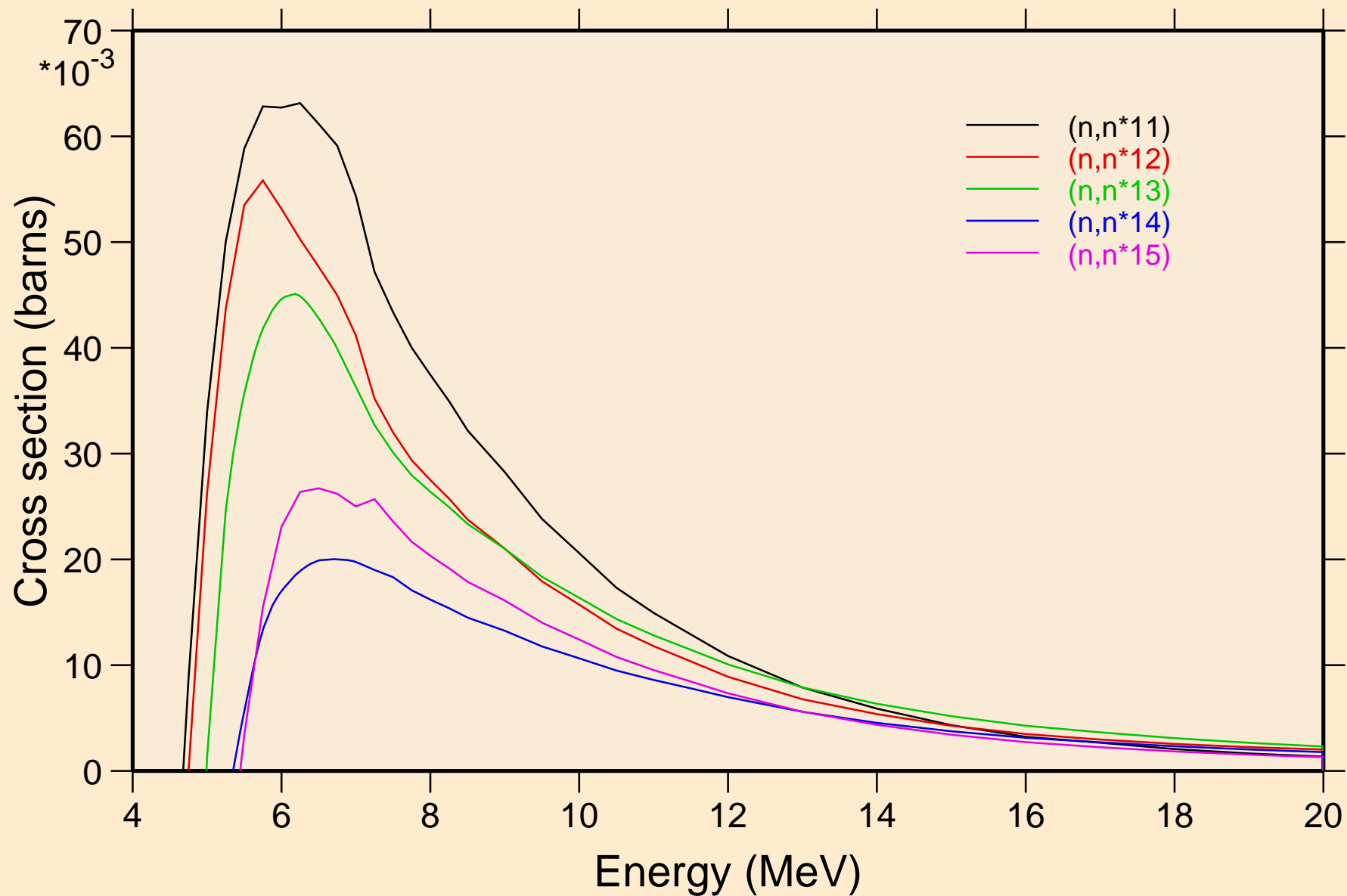

MAT=1325 ACE FILE PRODUCED AT NEA WITH NDEC  
Inelastic levels

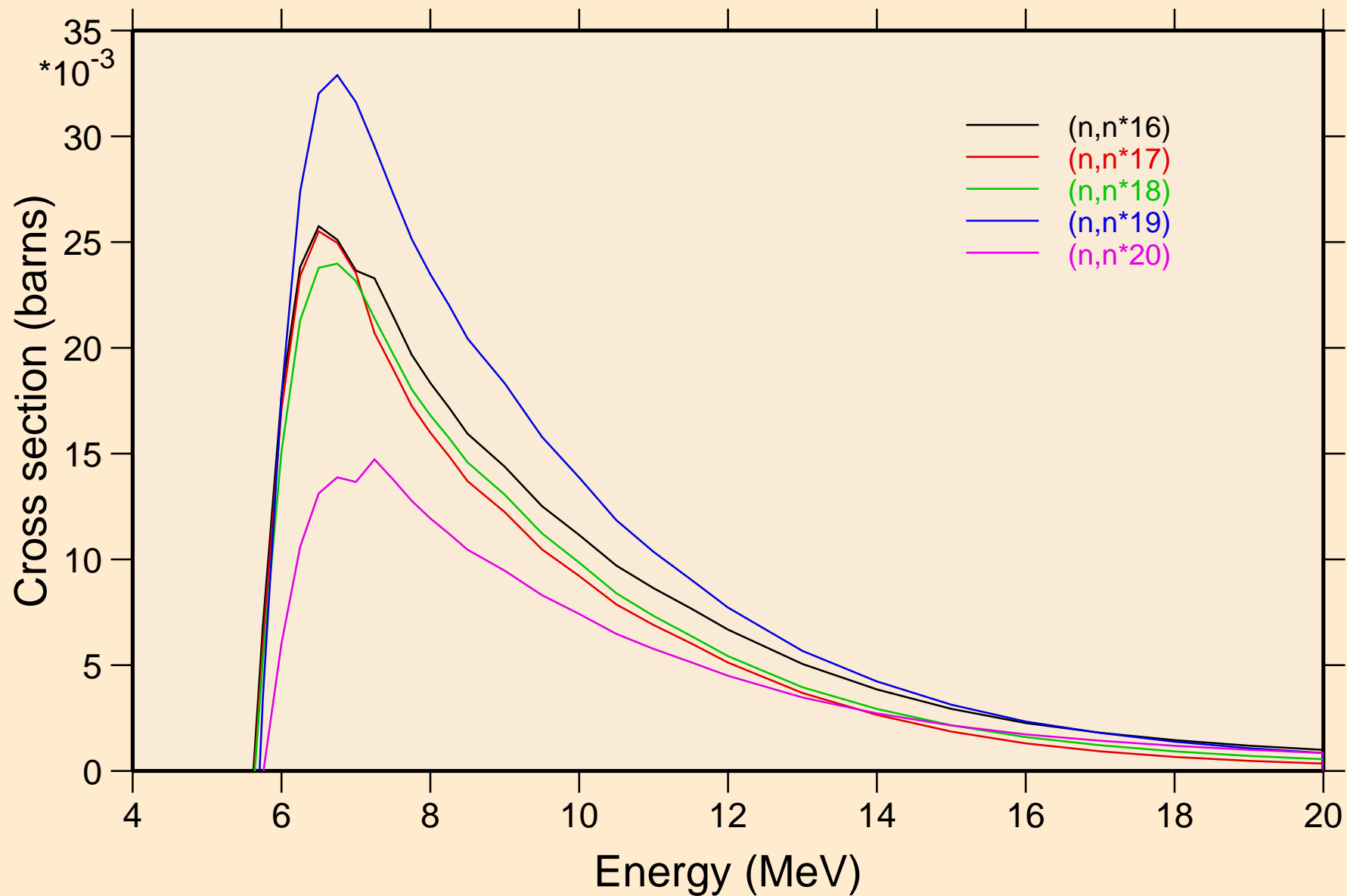

MAT=1325 ACE FILE PRODUCED AT NEA WITH NDEC  
Inelastic levels

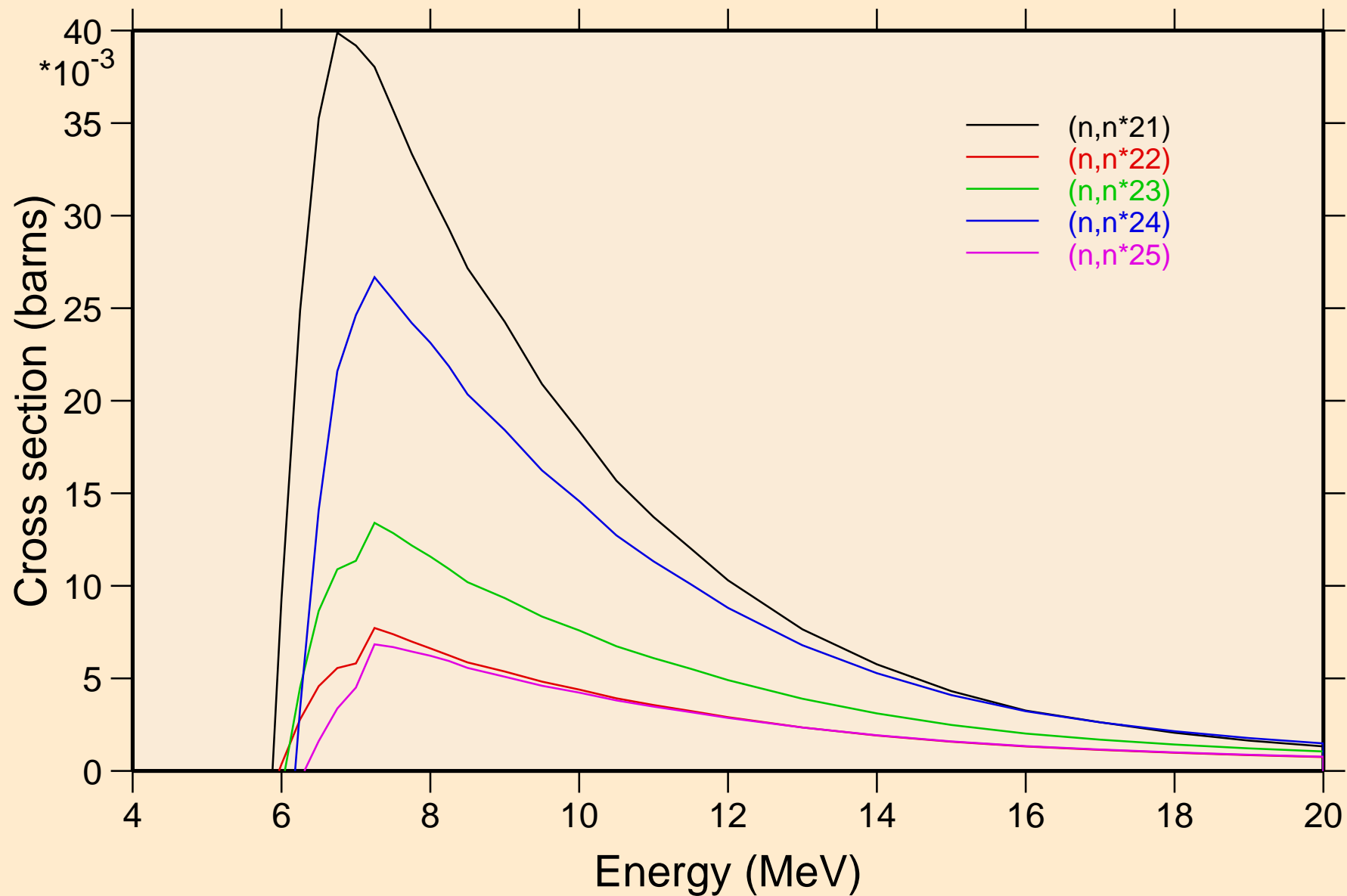

MAT=1325 ACE FILE PRODUCED AT NEA WITH NDEC  
Inelastic levels

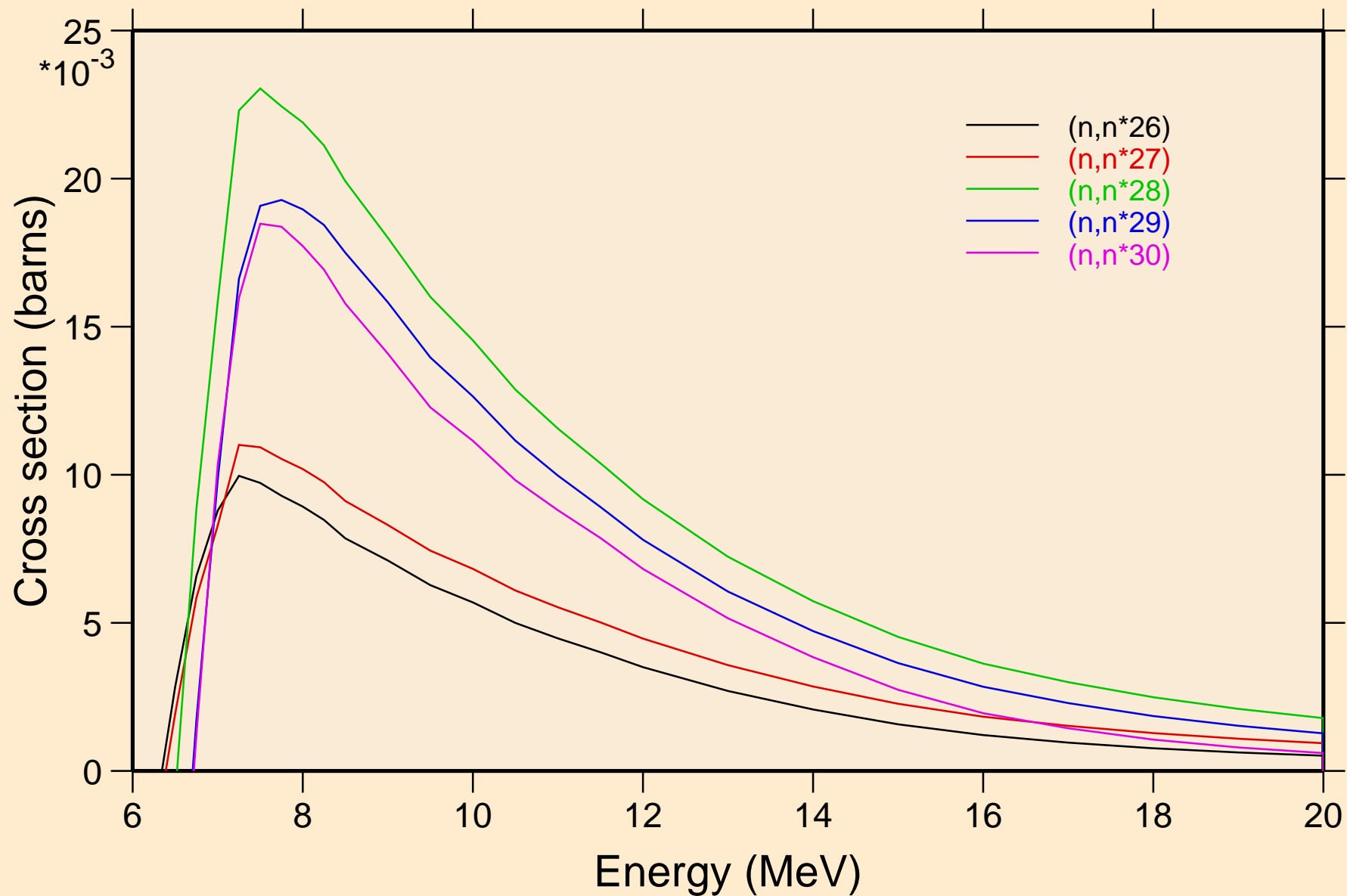

MAT=1325 ACE FILE PRODUCED AT NEA WITH NDEC  
Inelastic levels

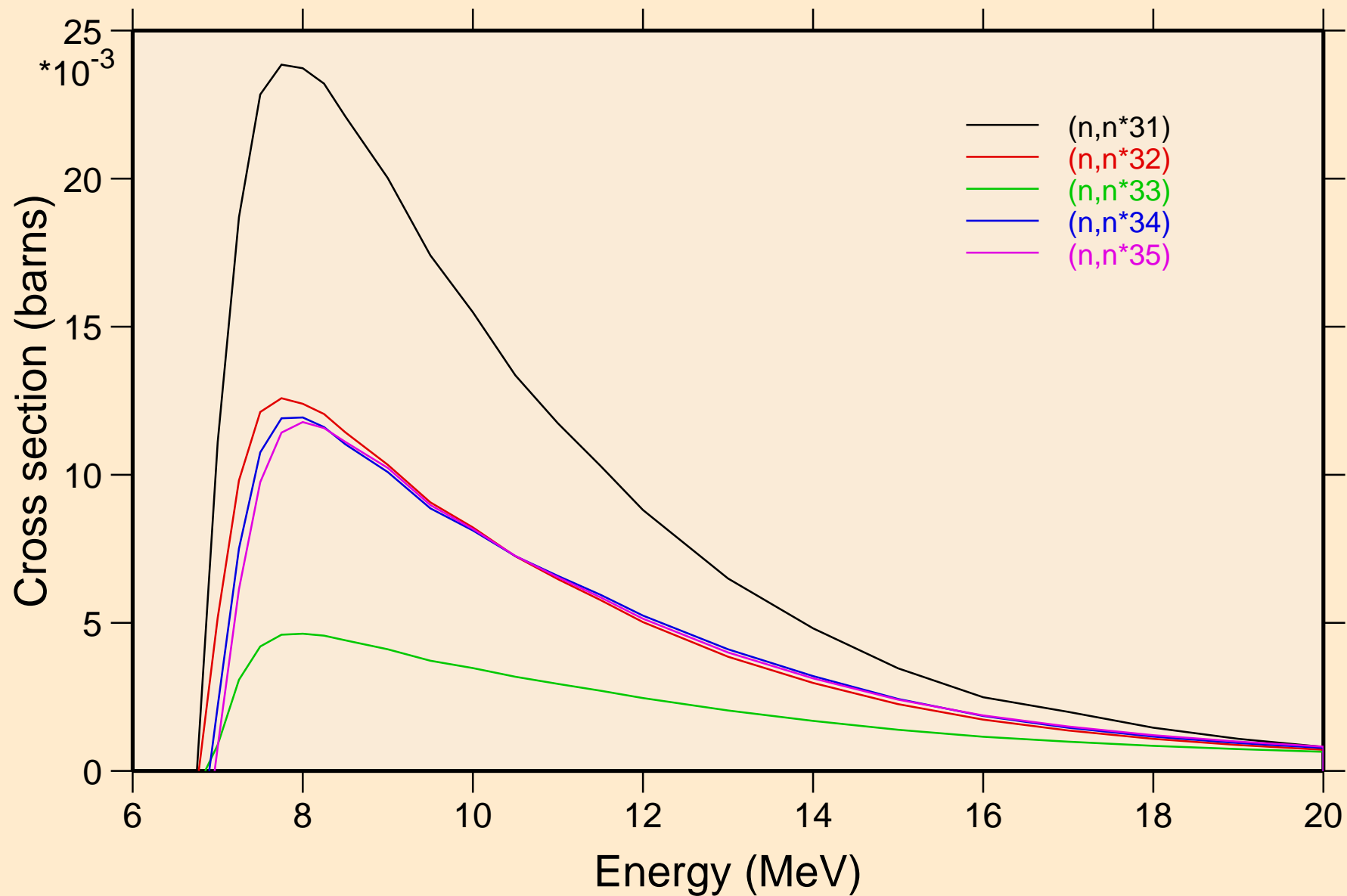

MAT=1325 ACE FILE PRODUCED AT NEA WITH NDEC  
Inelastic levels

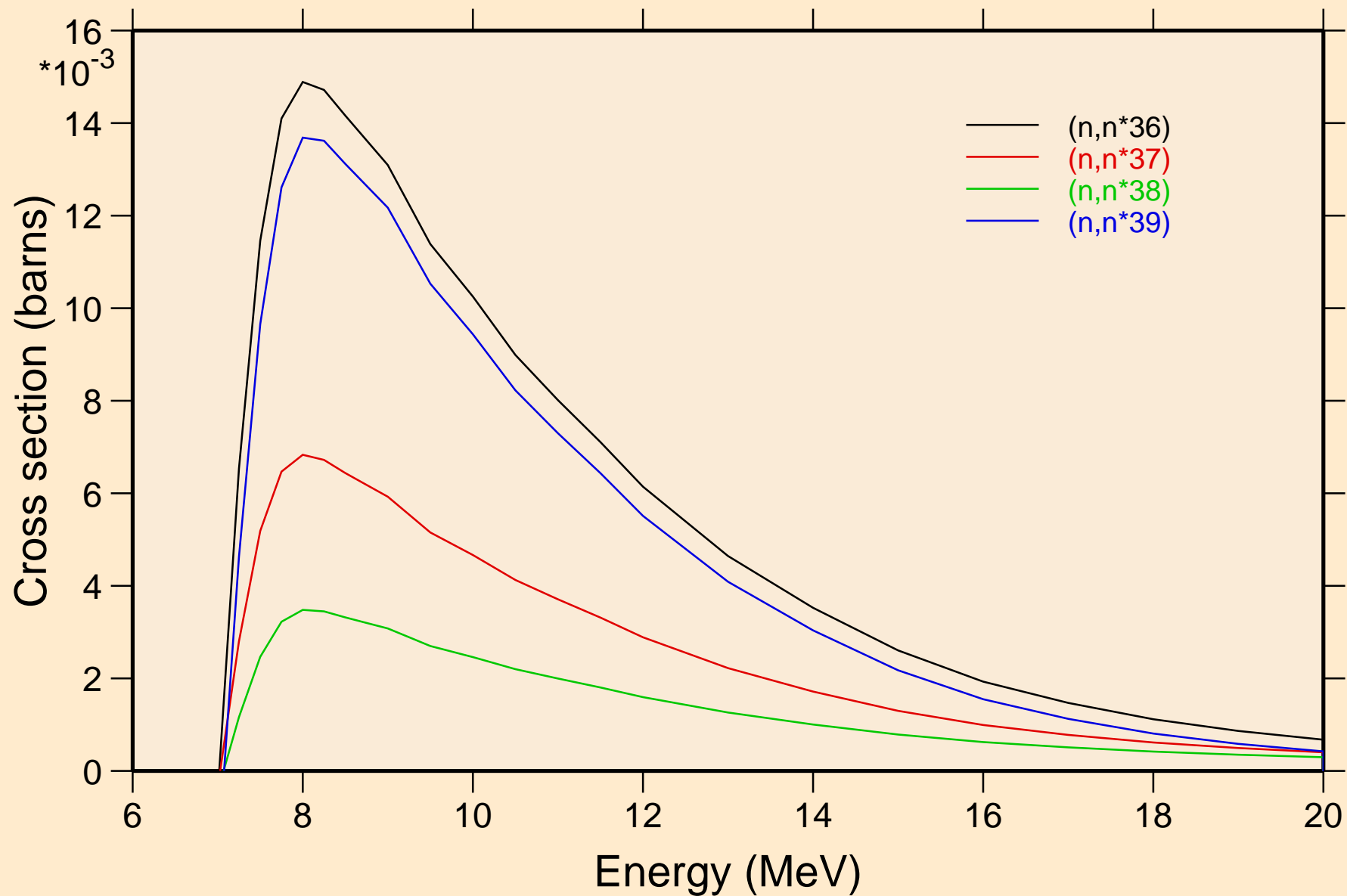



MAT=1325 ACE FILE PRODUCED AT NEA WITH NDEC  
Threshold reactions

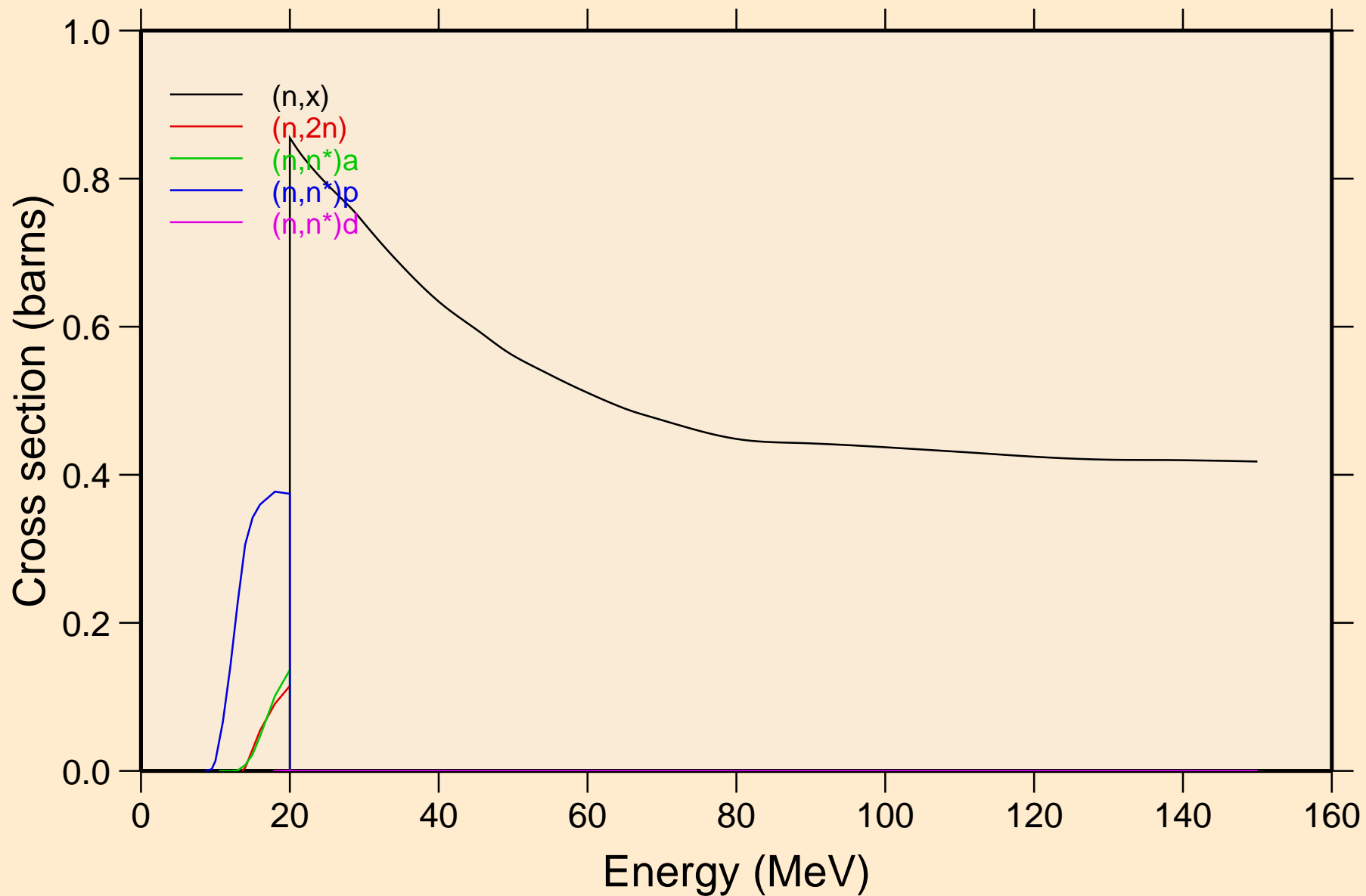

MAT=1325 ACE FILE PRODUCED AT NEA WITH NDEC  
Threshold reactions

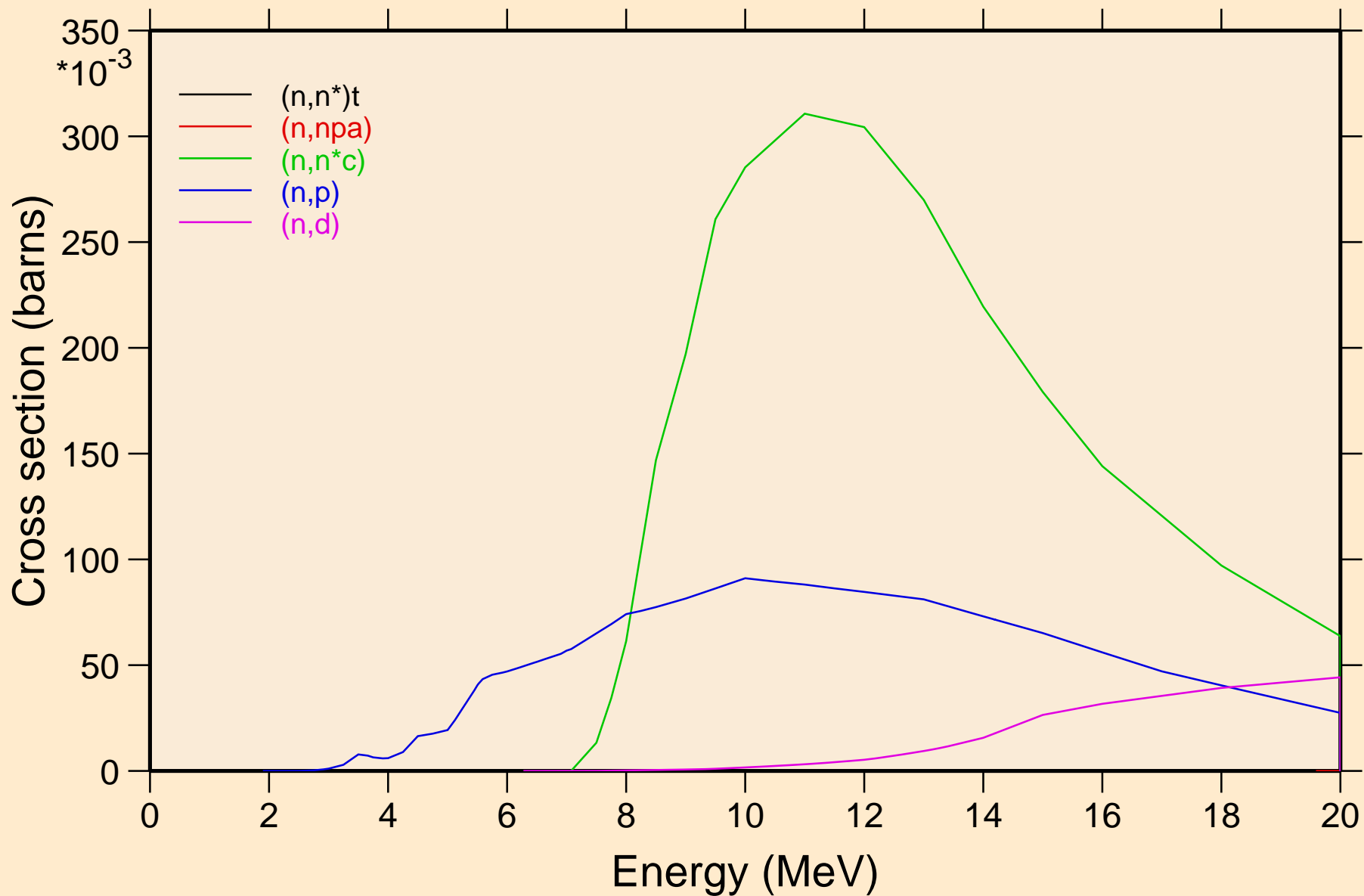

MAT=1325 ACE FILE PRODUCED AT NEA WITH NDEC  
Threshold reactions

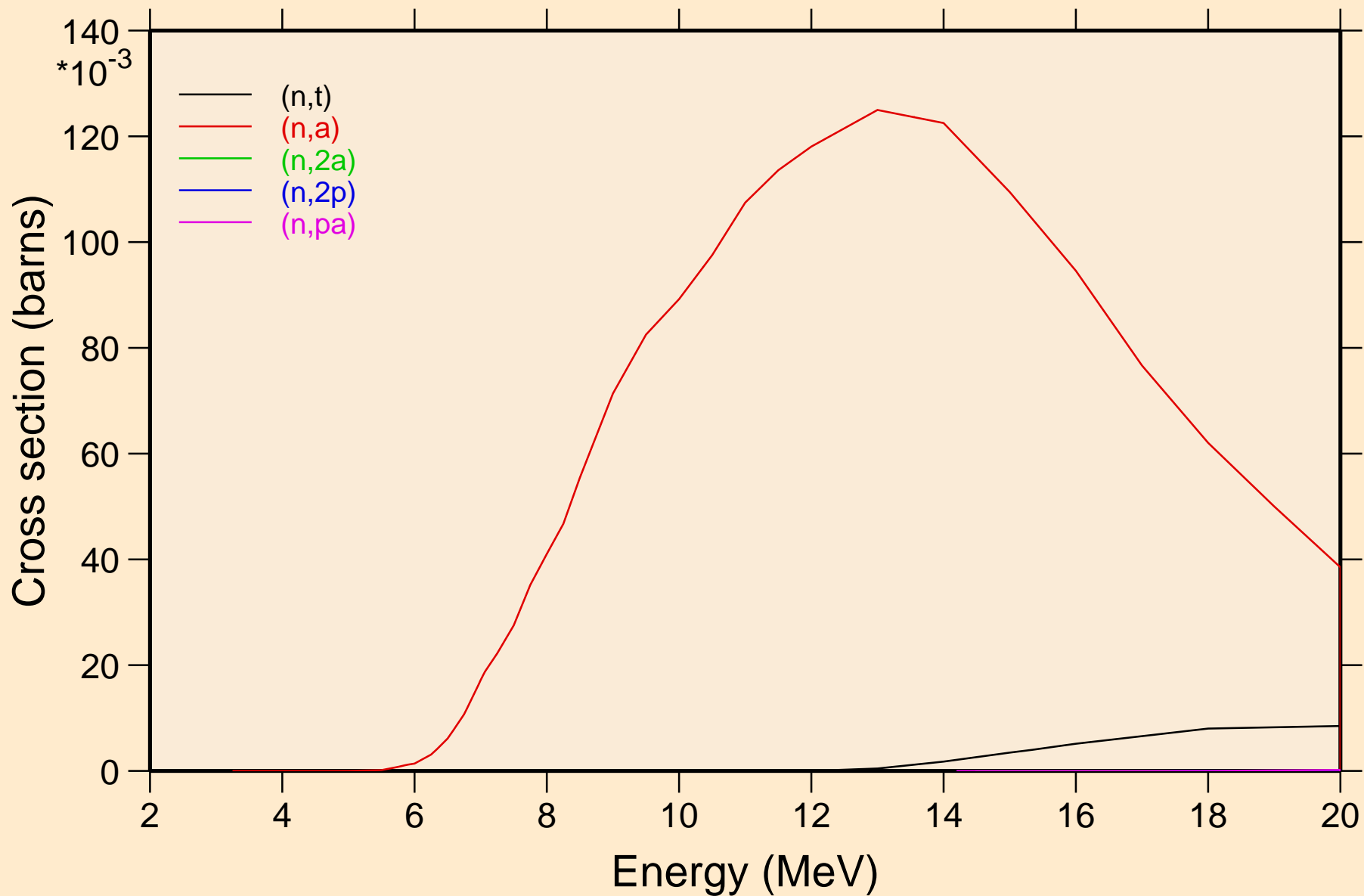

MAT=1325 ACE FILE PRODUCED AT NEA WITH NDEC  
Threshold reactions

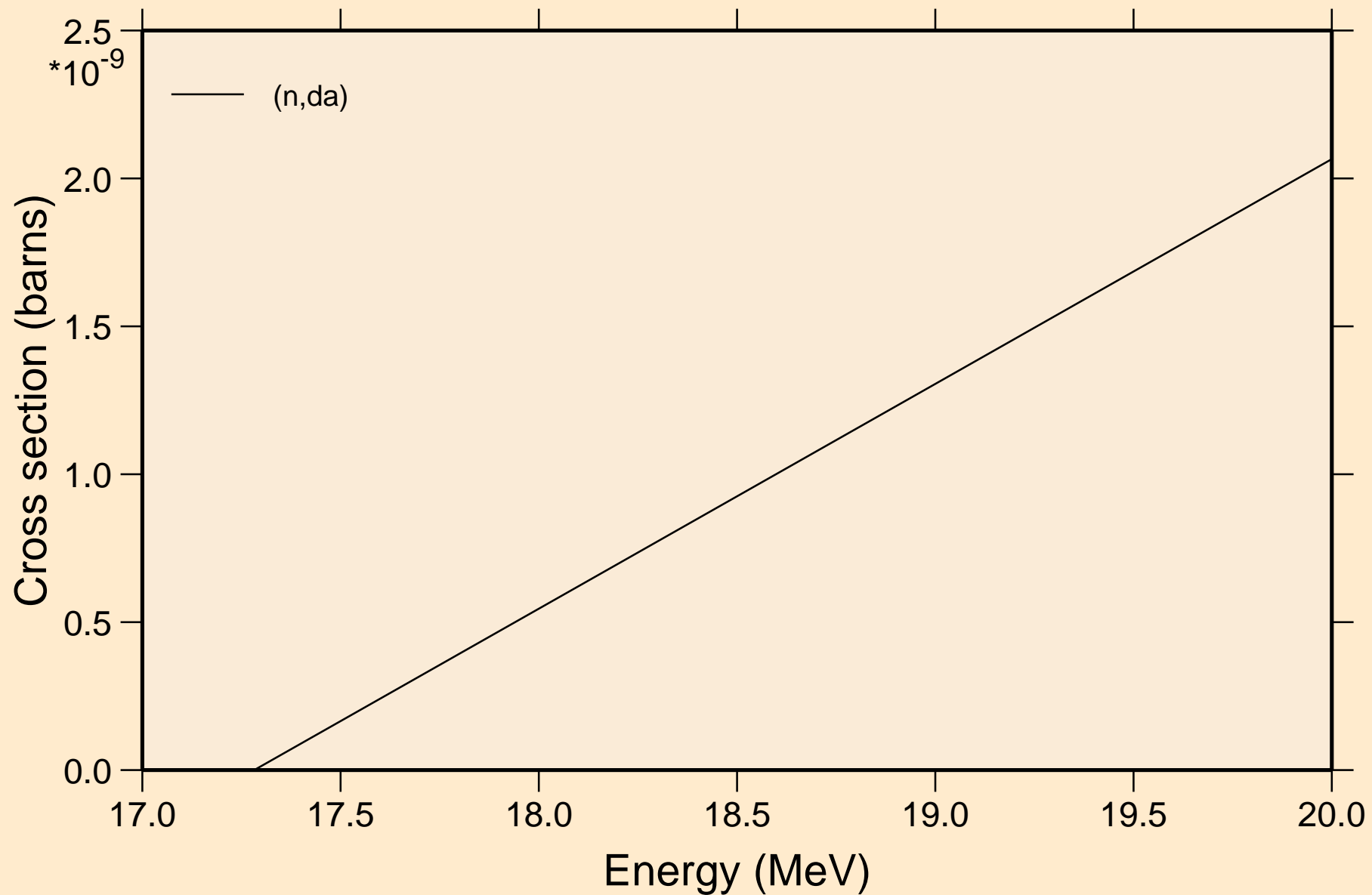

MAT=1325 ACE FILE PRODUCED AT NEA WITH NDEC  
Threshold reactions

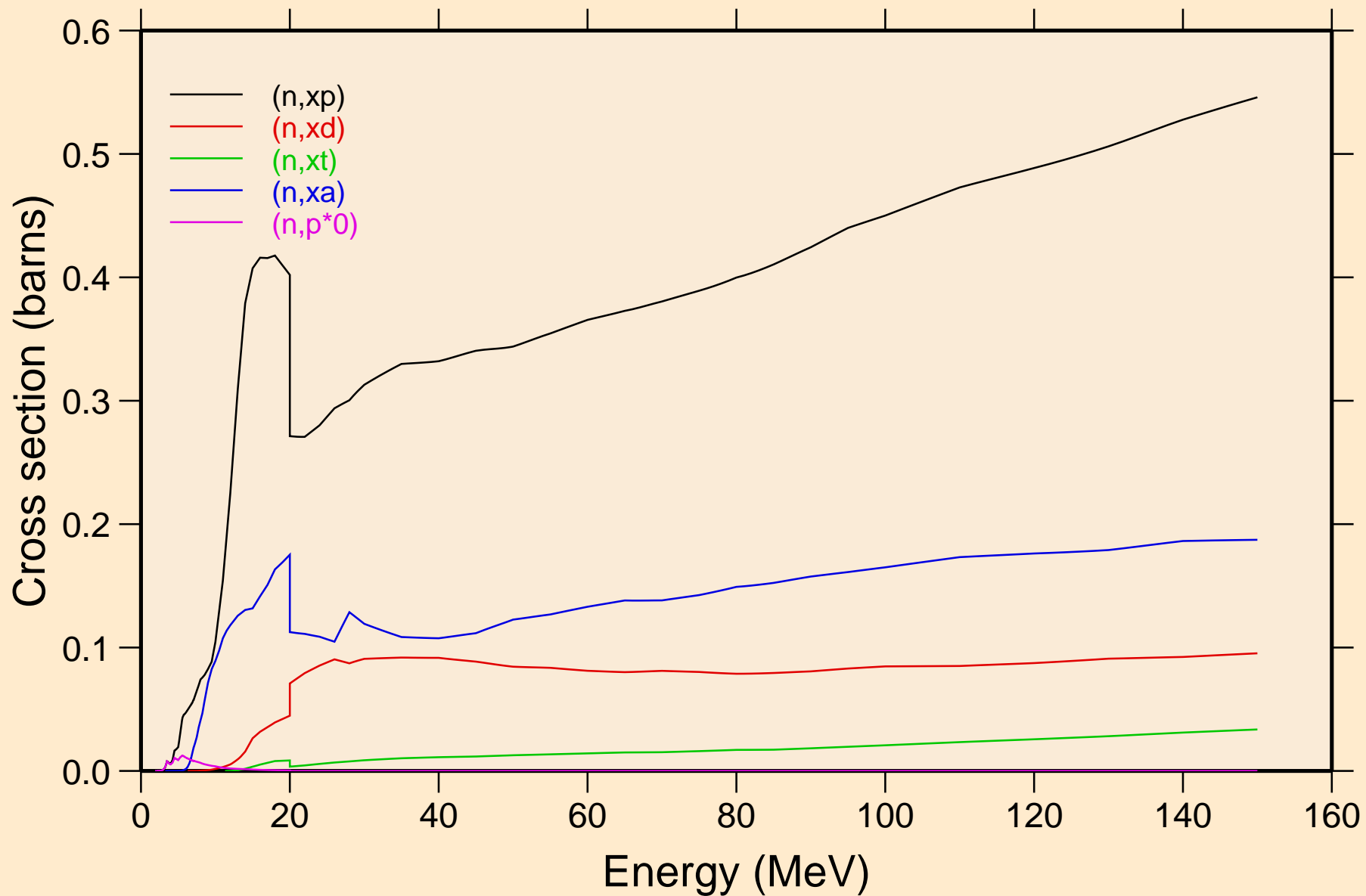

MAT=1325 ACE FILE PRODUCED AT NEA WITH NDEC  
Threshold reactions

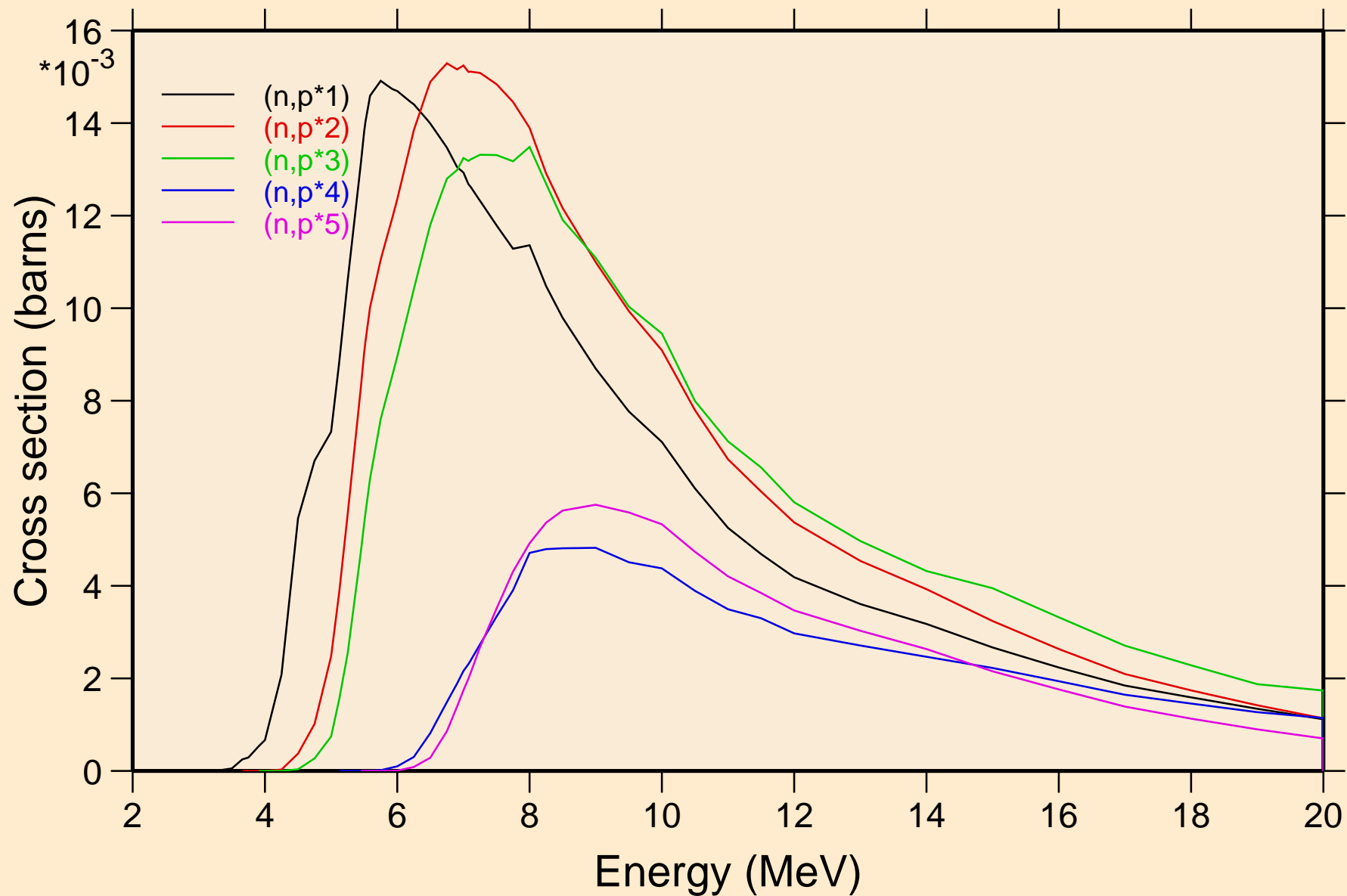

MAT=1325 ACE FILE PRODUCED AT NEA WITH NDEC  
Threshold reactions

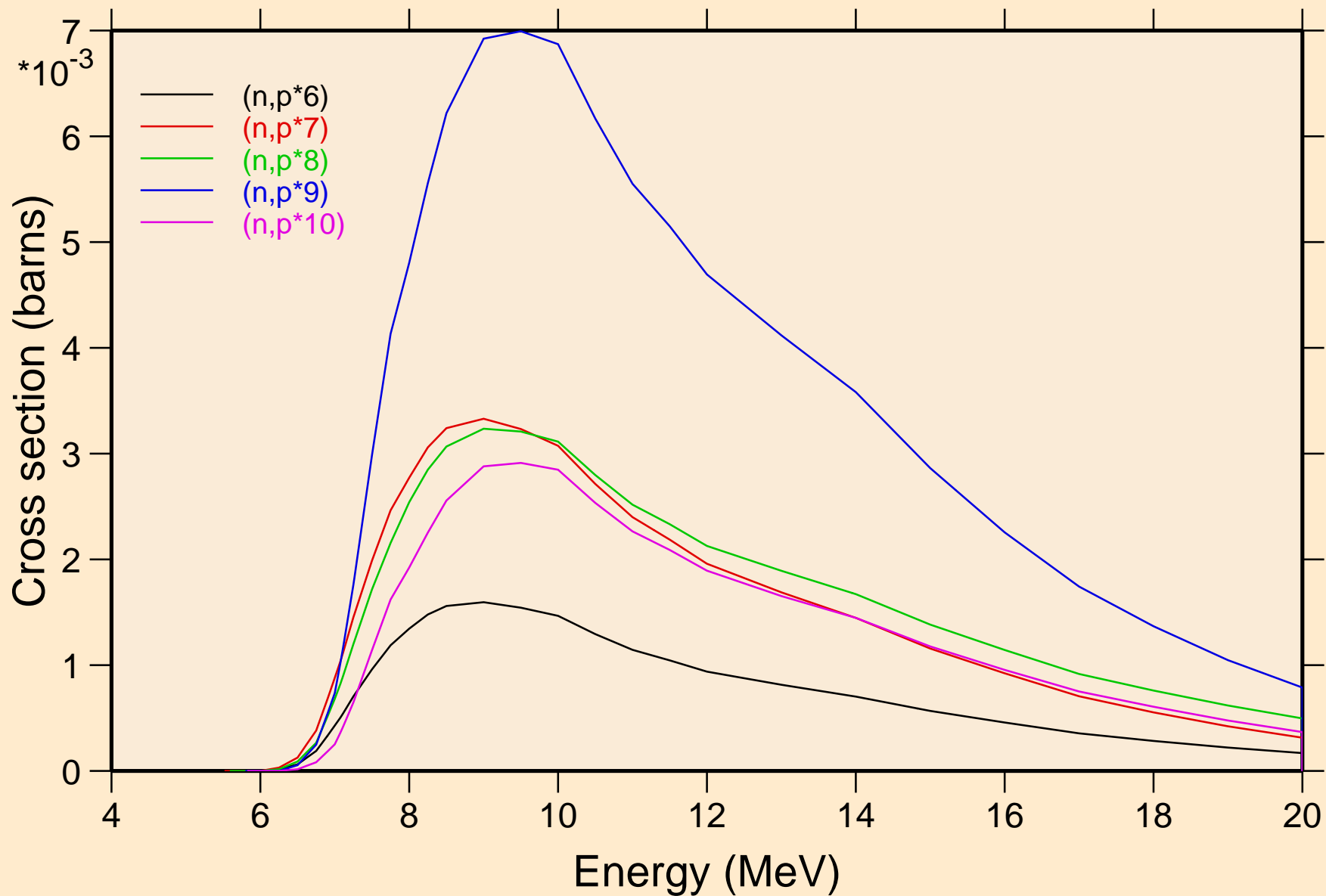

MAT=1325 ACE FILE PRODUCED AT NEA WITH NDEC  
Threshold reactions

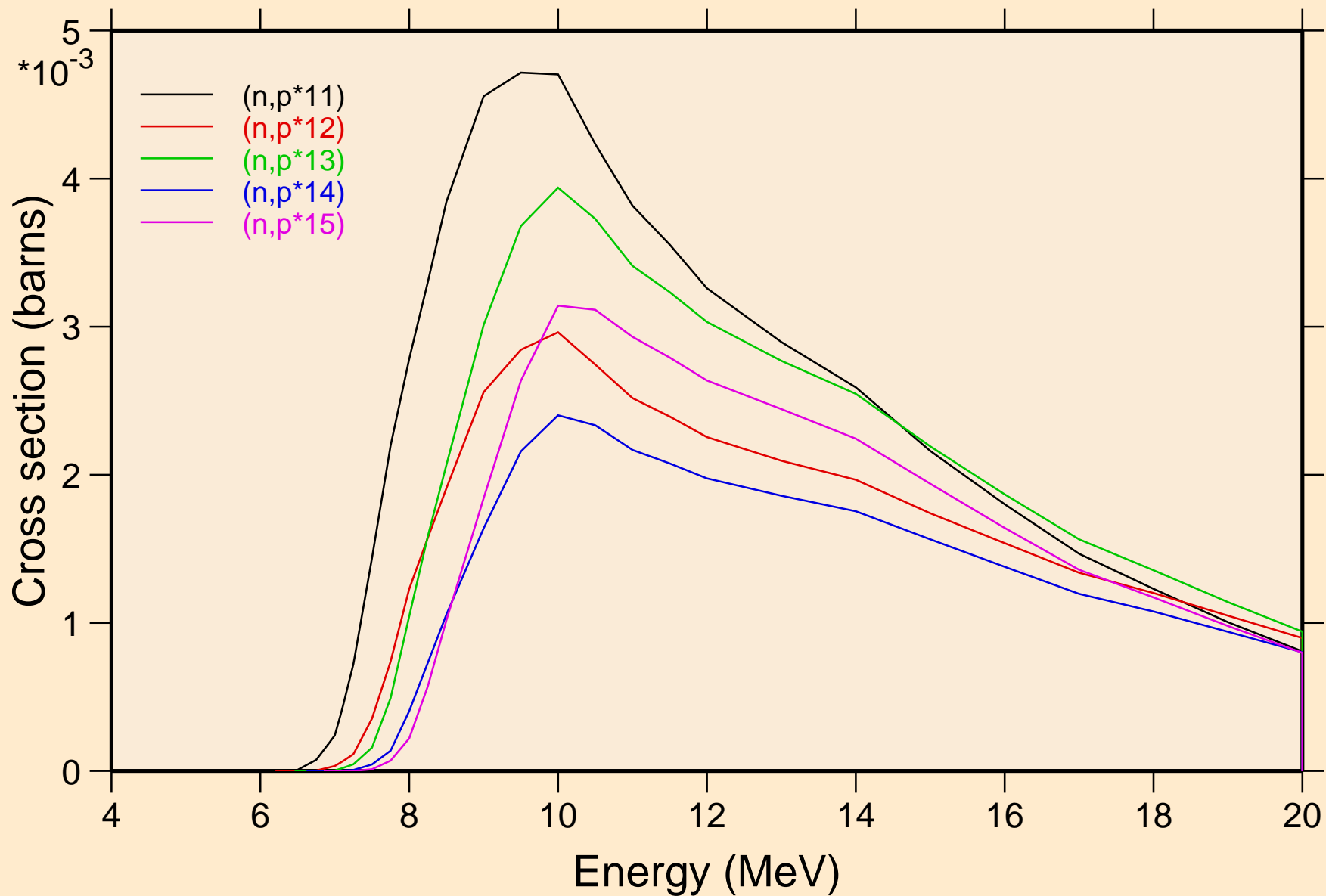



MAT=1325 ACE FILE PRODUCED AT NEA WITH NDEC  
Threshold reactions

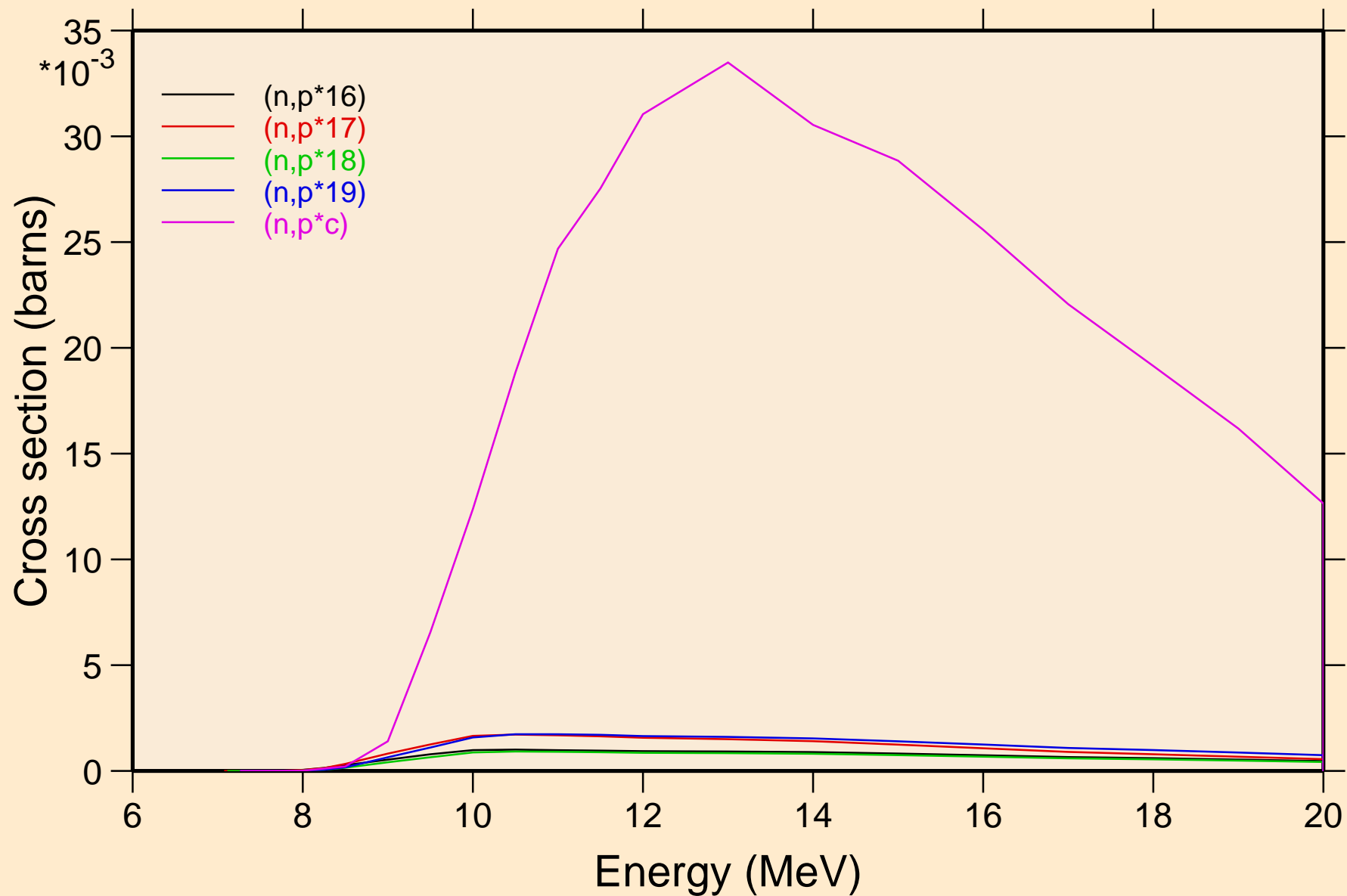

MAT=1325 ACE FILE PRODUCED AT NEA WITH NDEC  
Threshold reactions

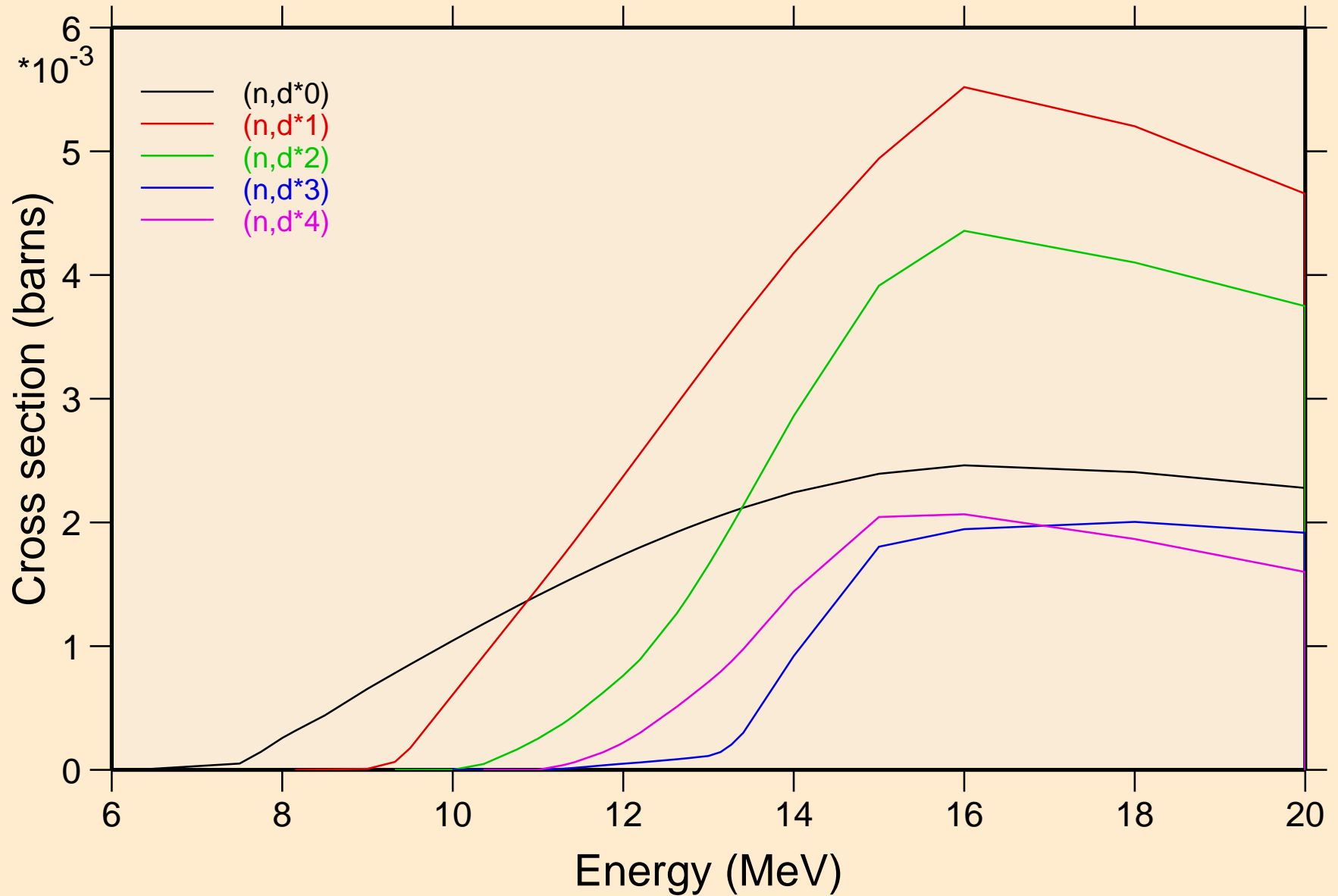

MAT=1325 ACE FILE PRODUCED AT NEA WITH NDEC  
Threshold reactions

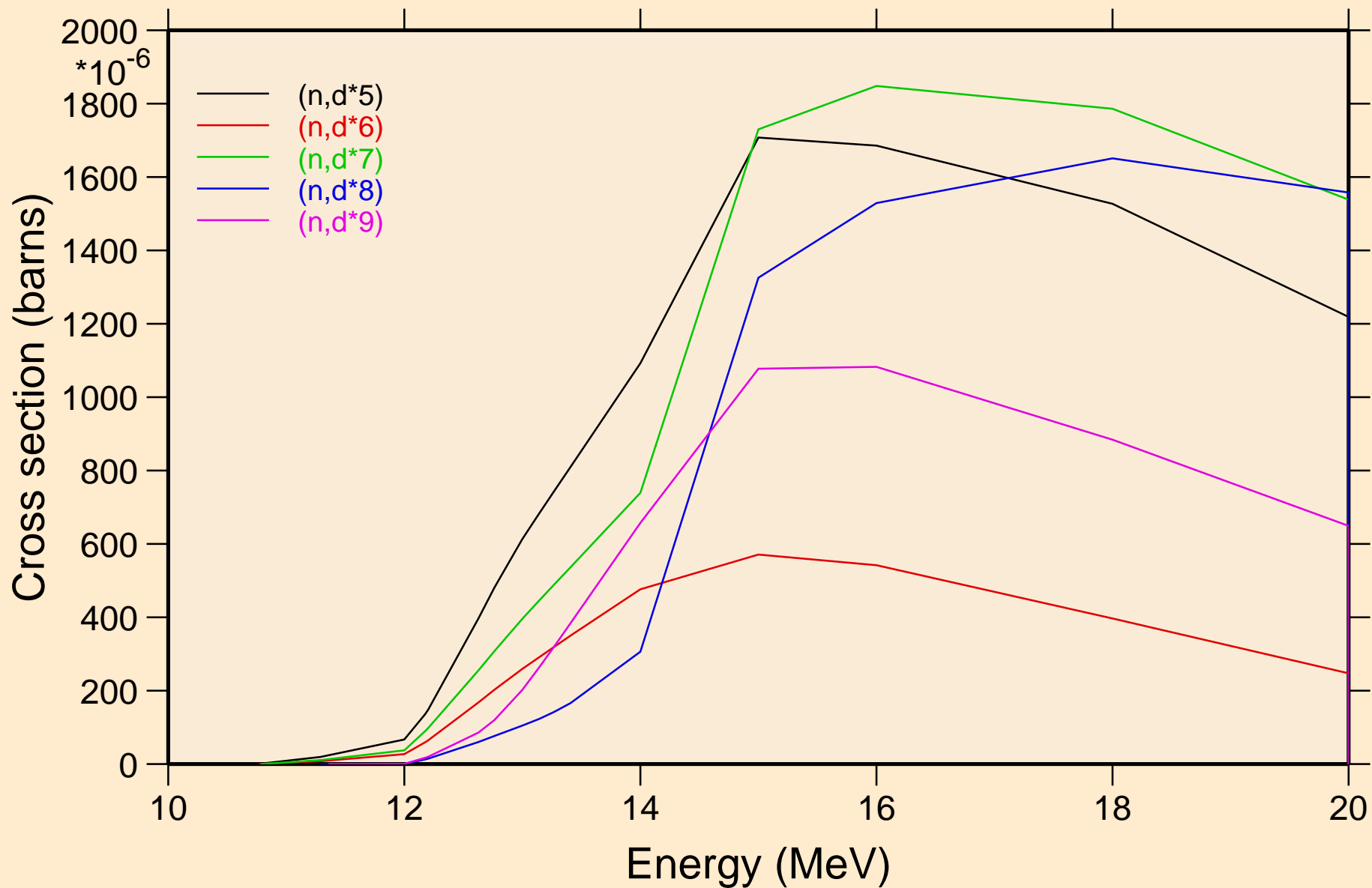

MAT=1325 ACE FILE PRODUCED AT NEA WITH NDEC  
Threshold reactions

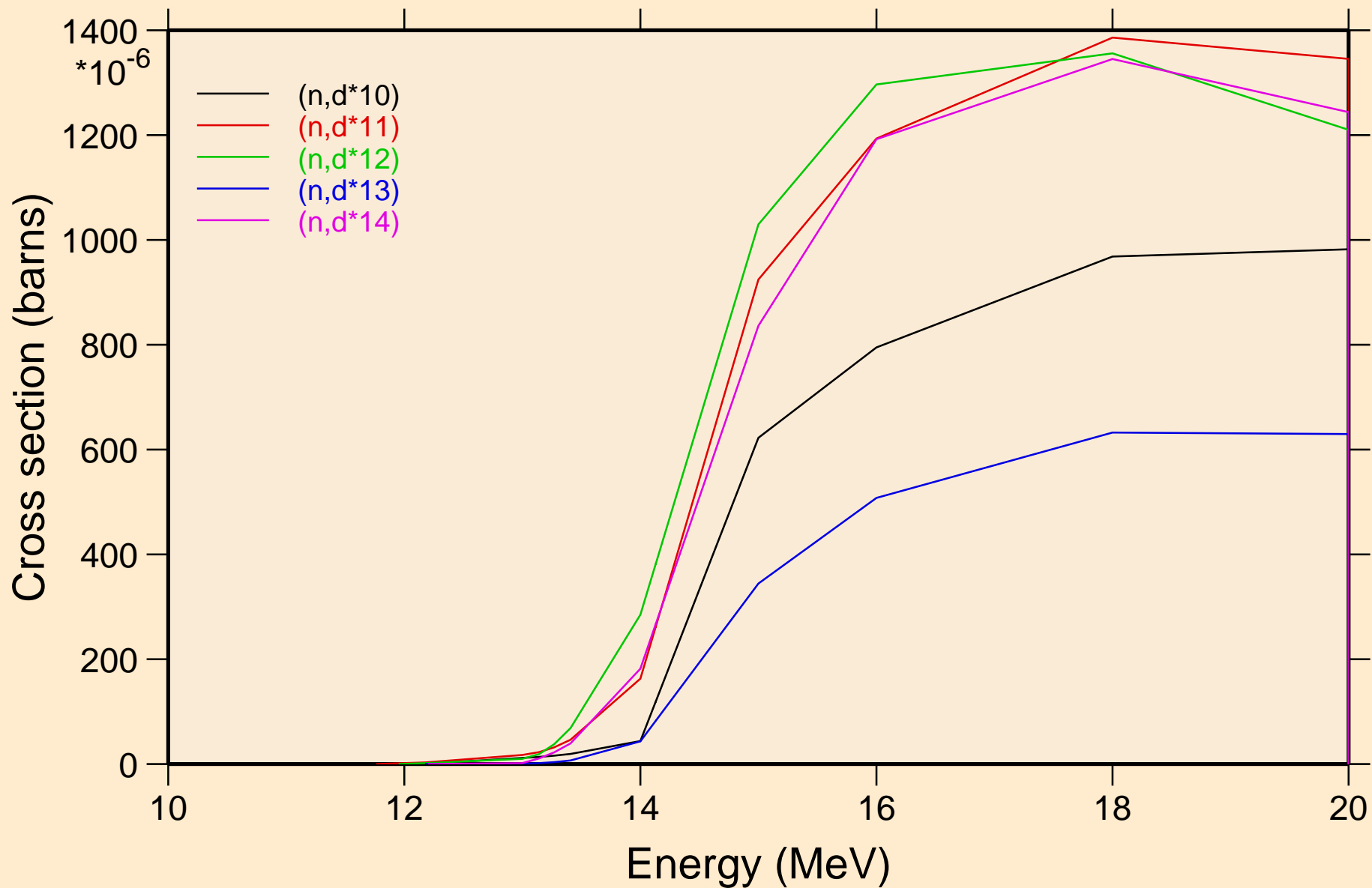

MAT=1325 ACE FILE PRODUCED AT NEA WITH NDEC  
Threshold reactions

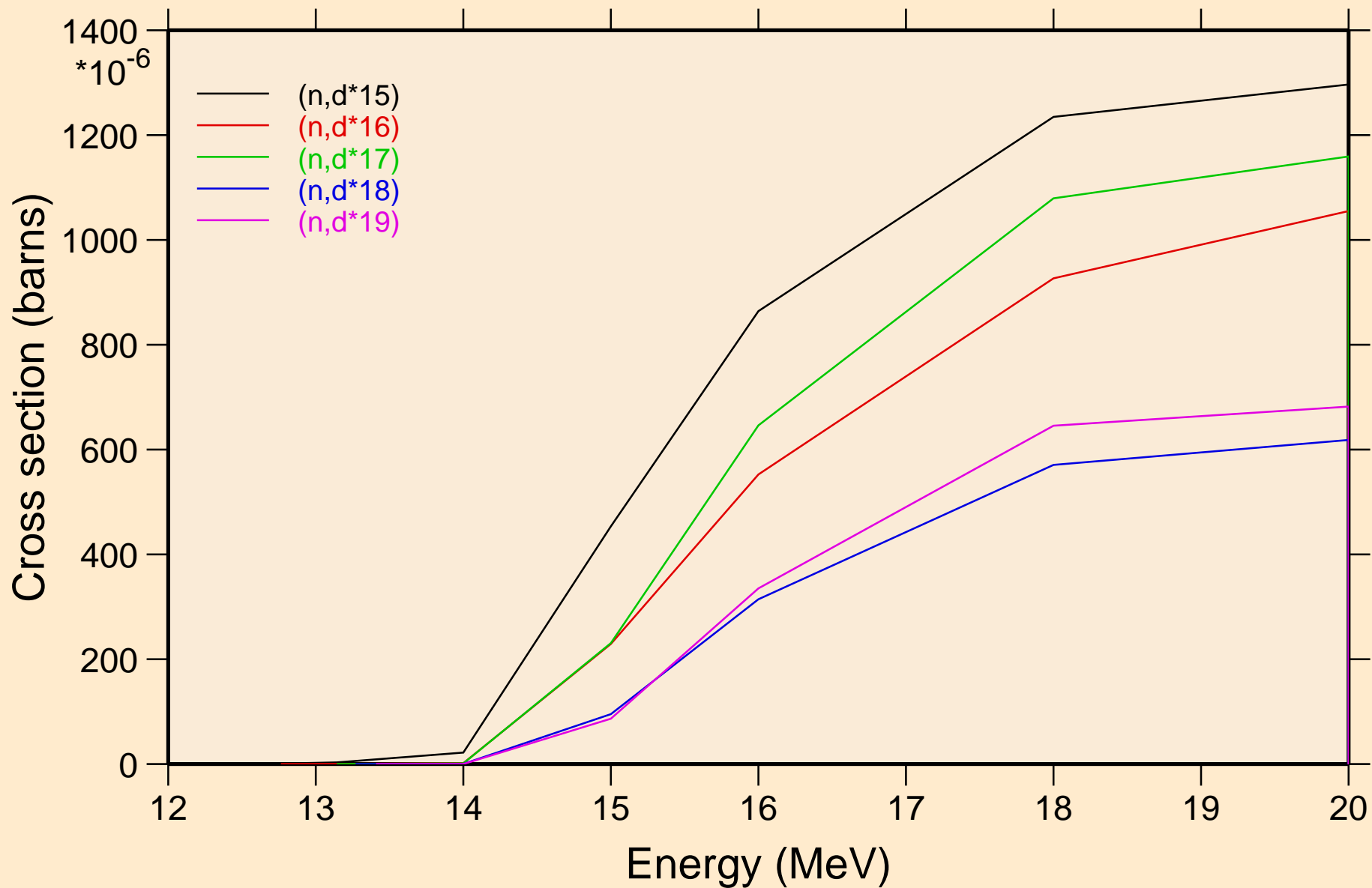

MAT=1325 ACE FILE PRODUCED AT NEA WITH NDEC  
Threshold reactions

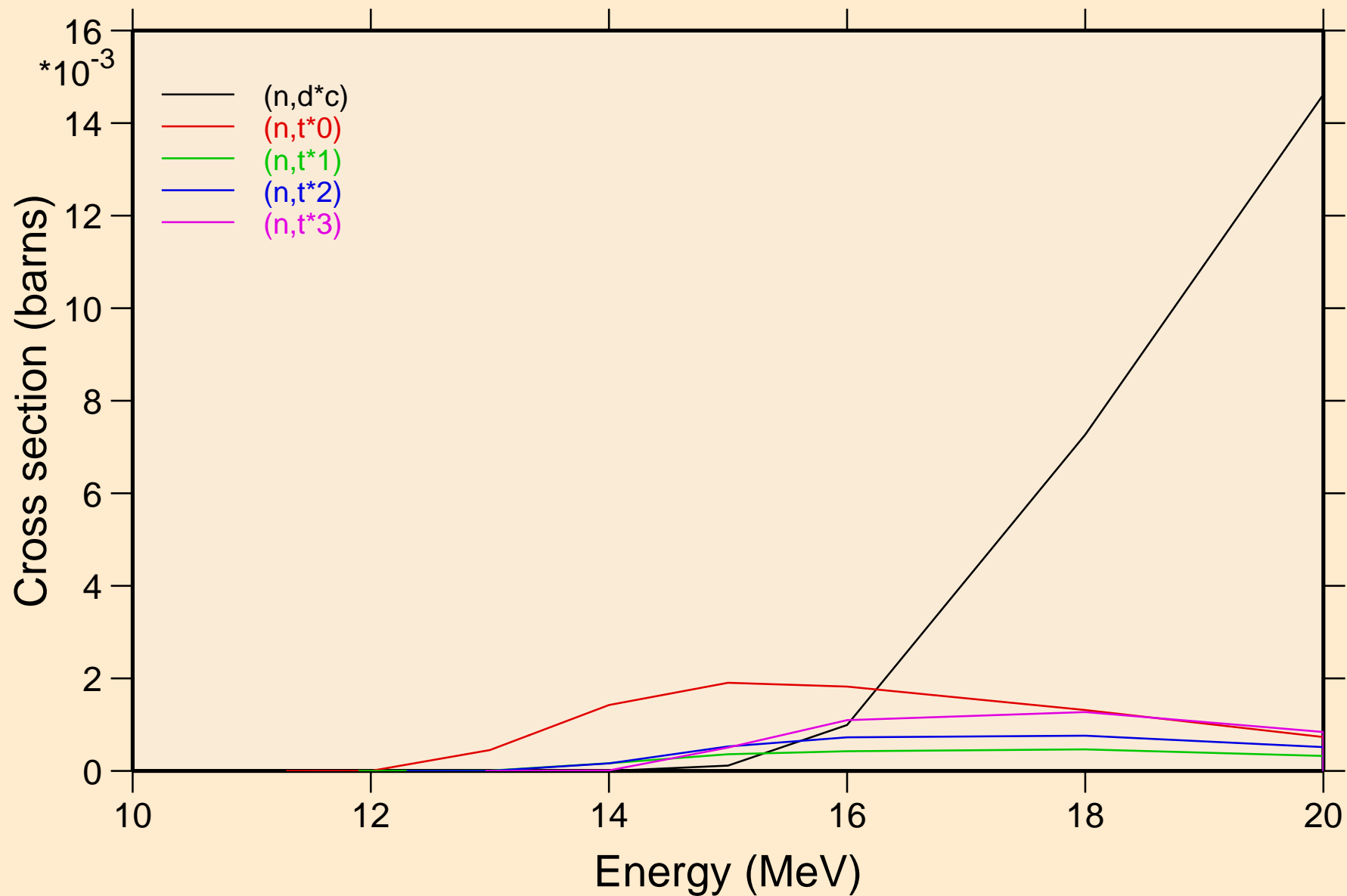

MAT=1325 ACE FILE PRODUCED AT NEA WITH NDEC  
Threshold reactions

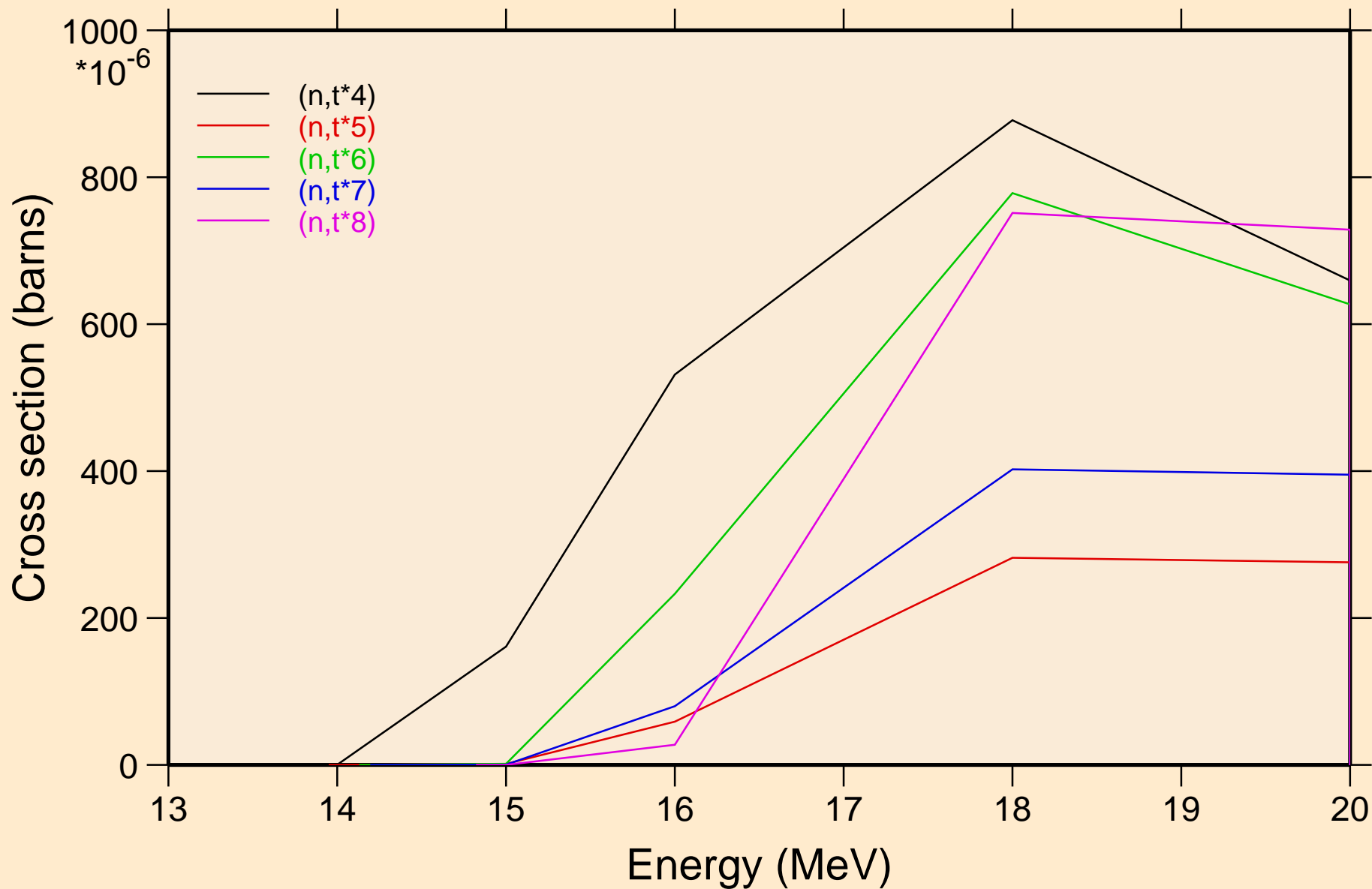

MAT=1325 ACE FILE PRODUCED AT NEA WITH NDEC  
Threshold reactions

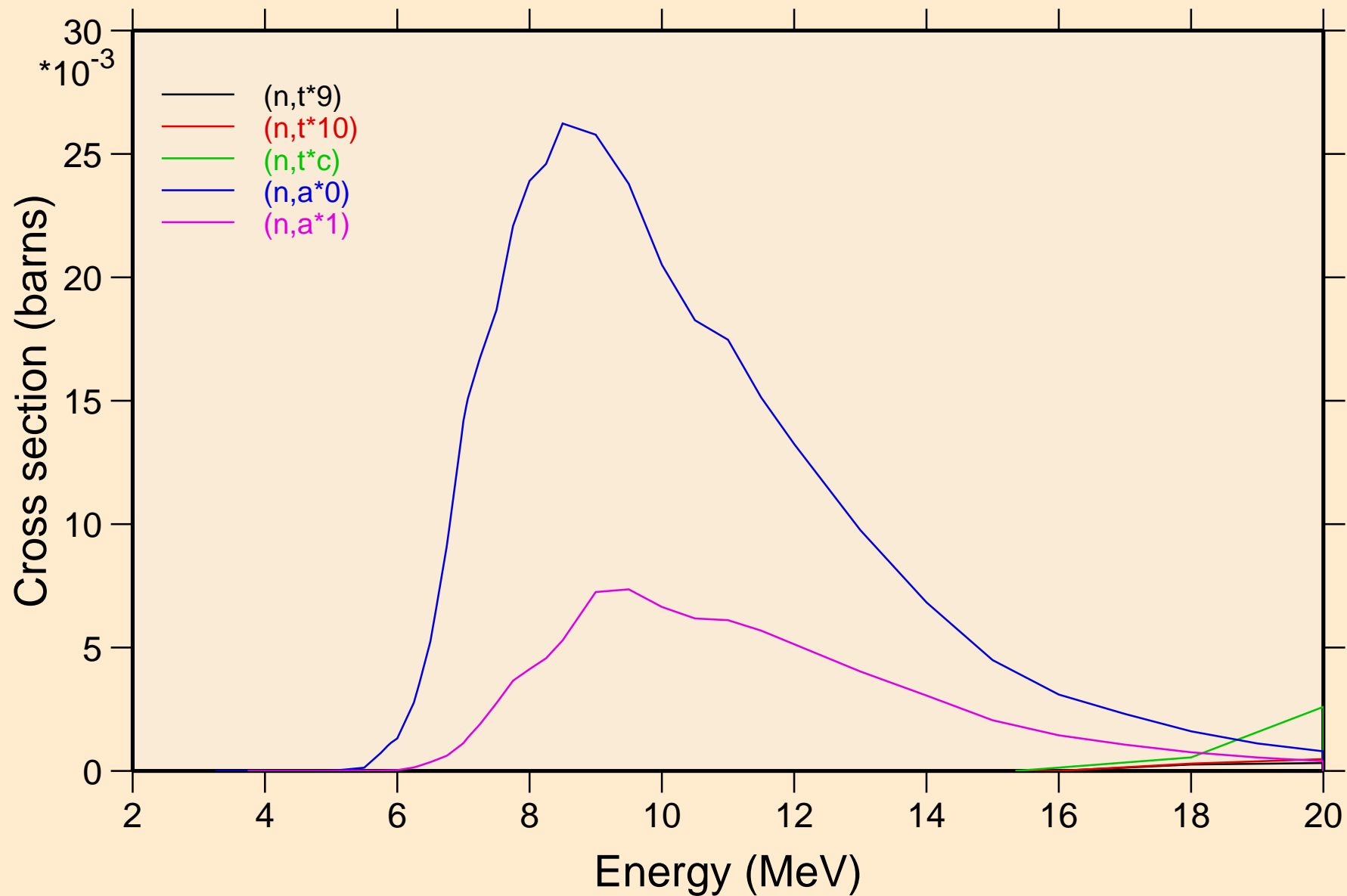



MAT=1325 ACE FILE PRODUCED AT NEA WITH NDEC  
Threshold reactions

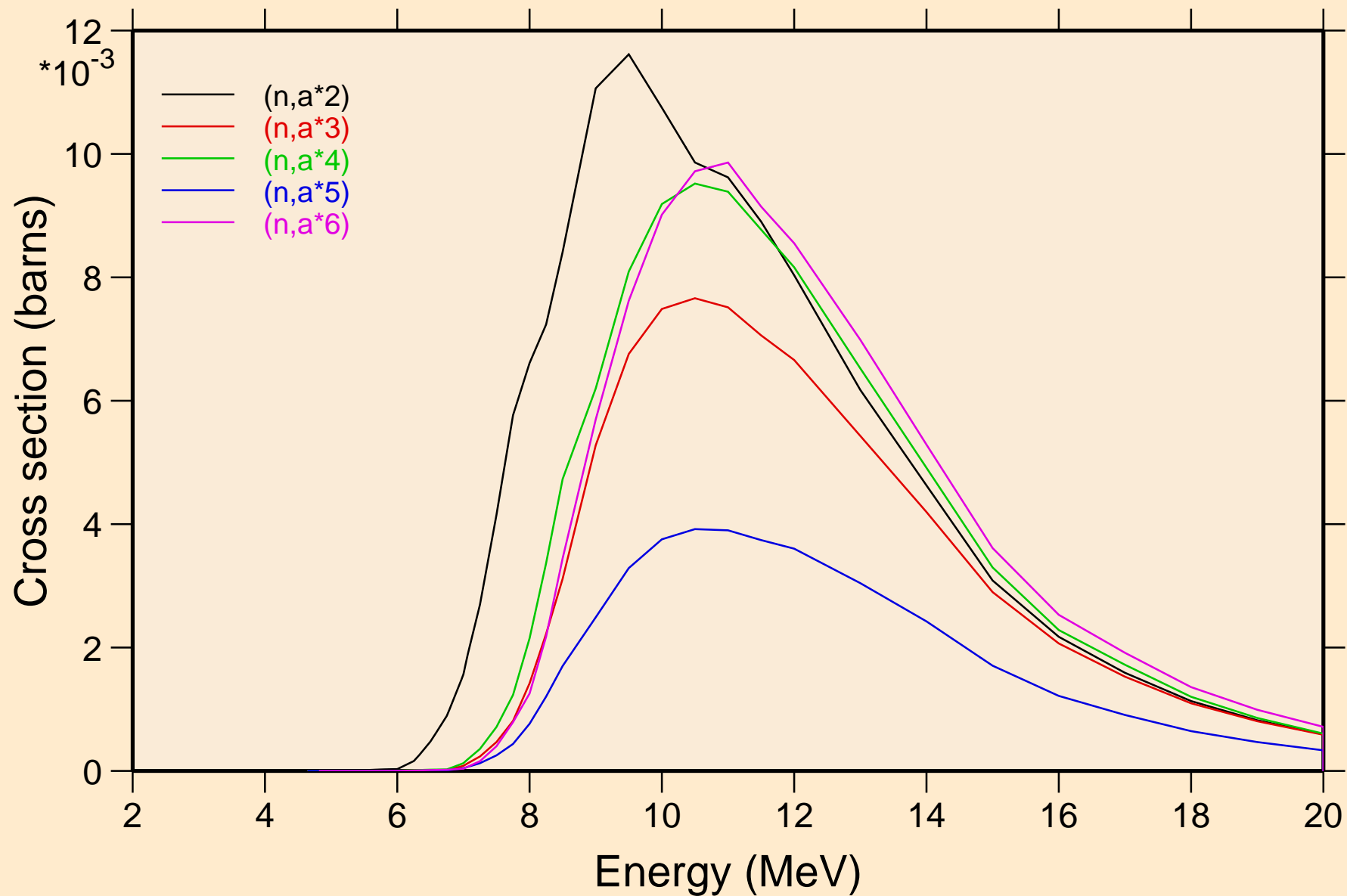

MAT=1325 ACE FILE PRODUCED AT NEA WITH NDEC  
Threshold reactions

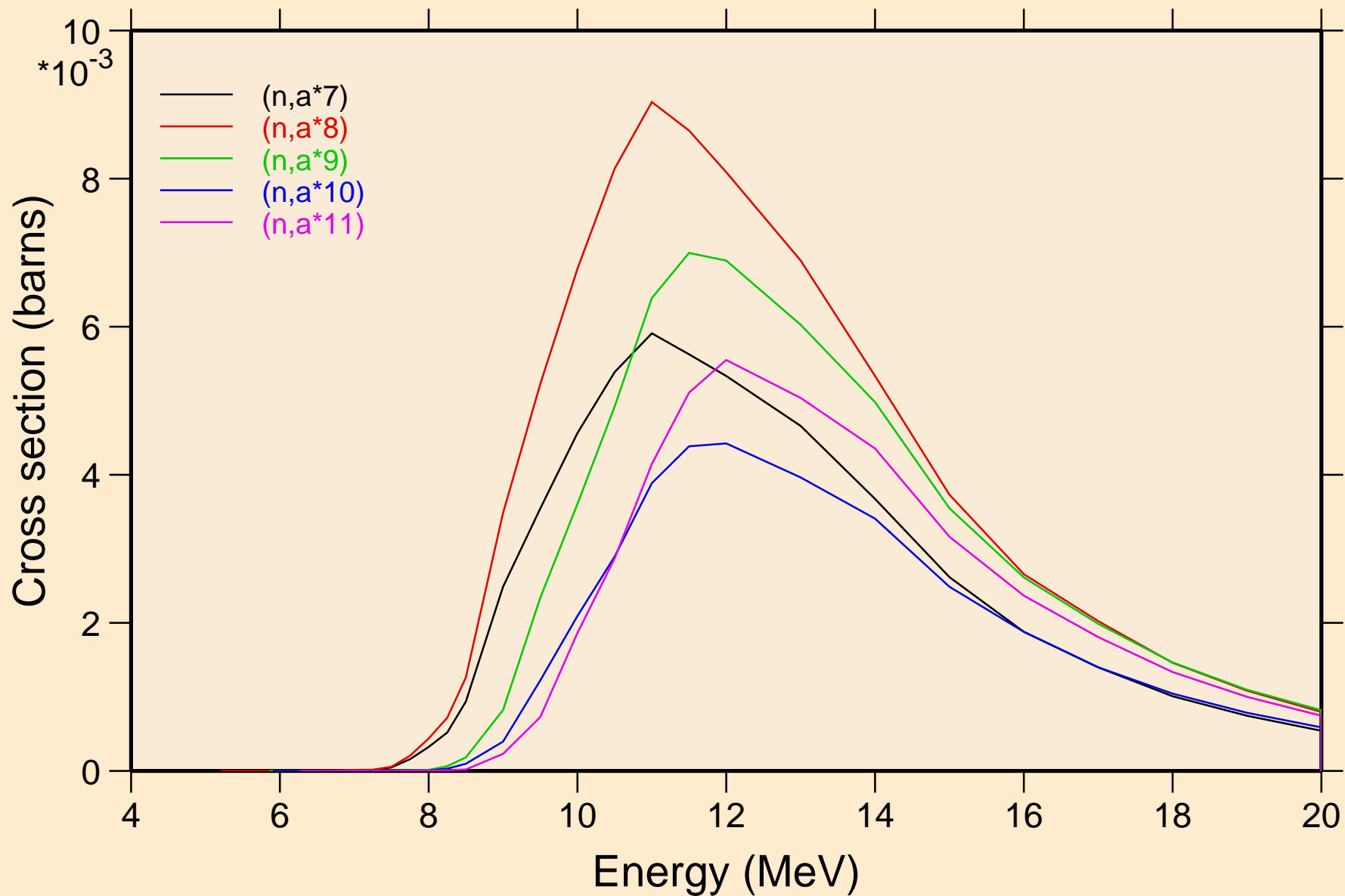

MAT=1325 ACE FILE PRODUCED AT NEA WITH NDEC  
Threshold reactions

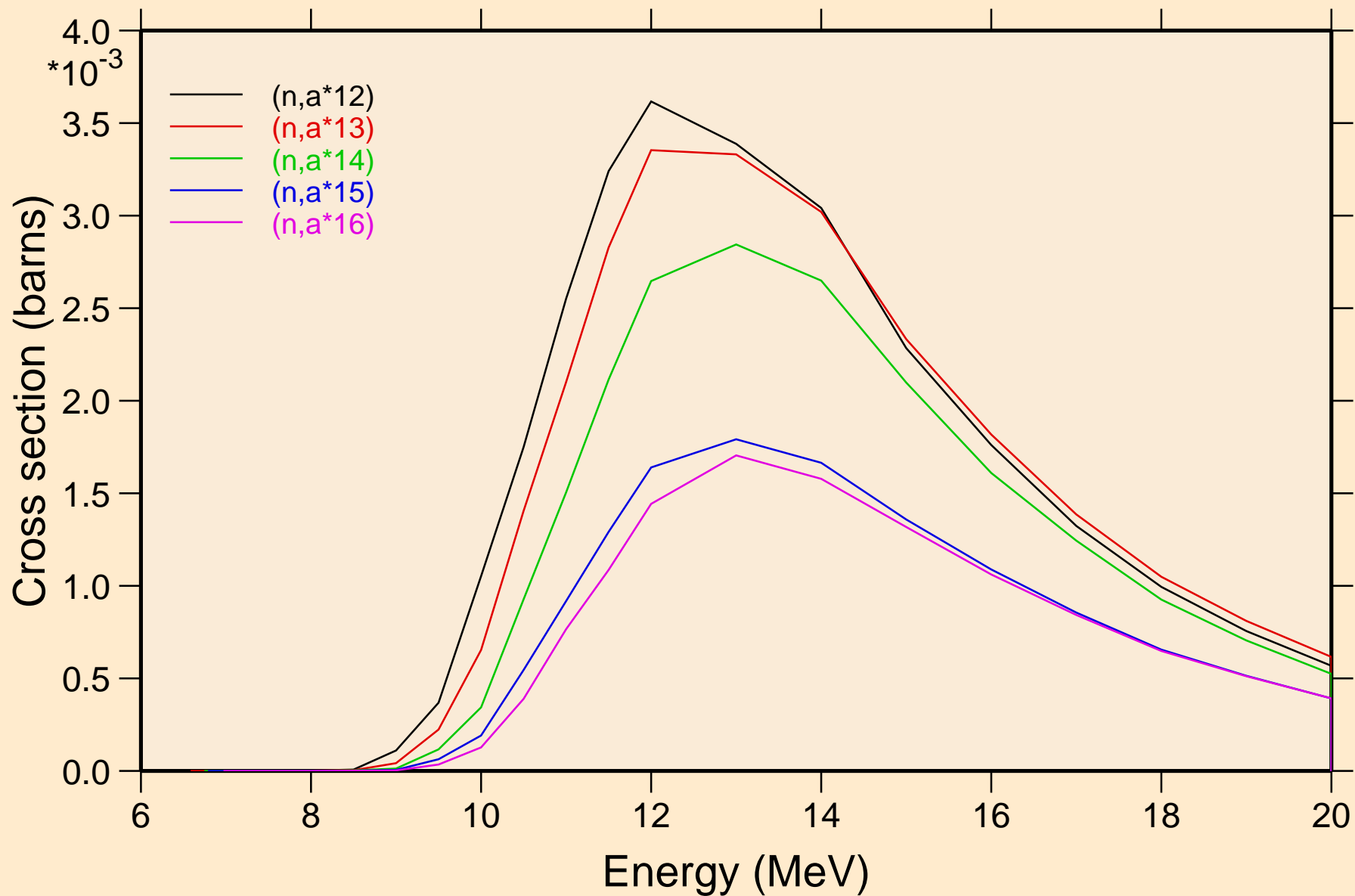

MAT=1325 ACE FILE PRODUCED AT NEA WITH NDEC  
Threshold reactions

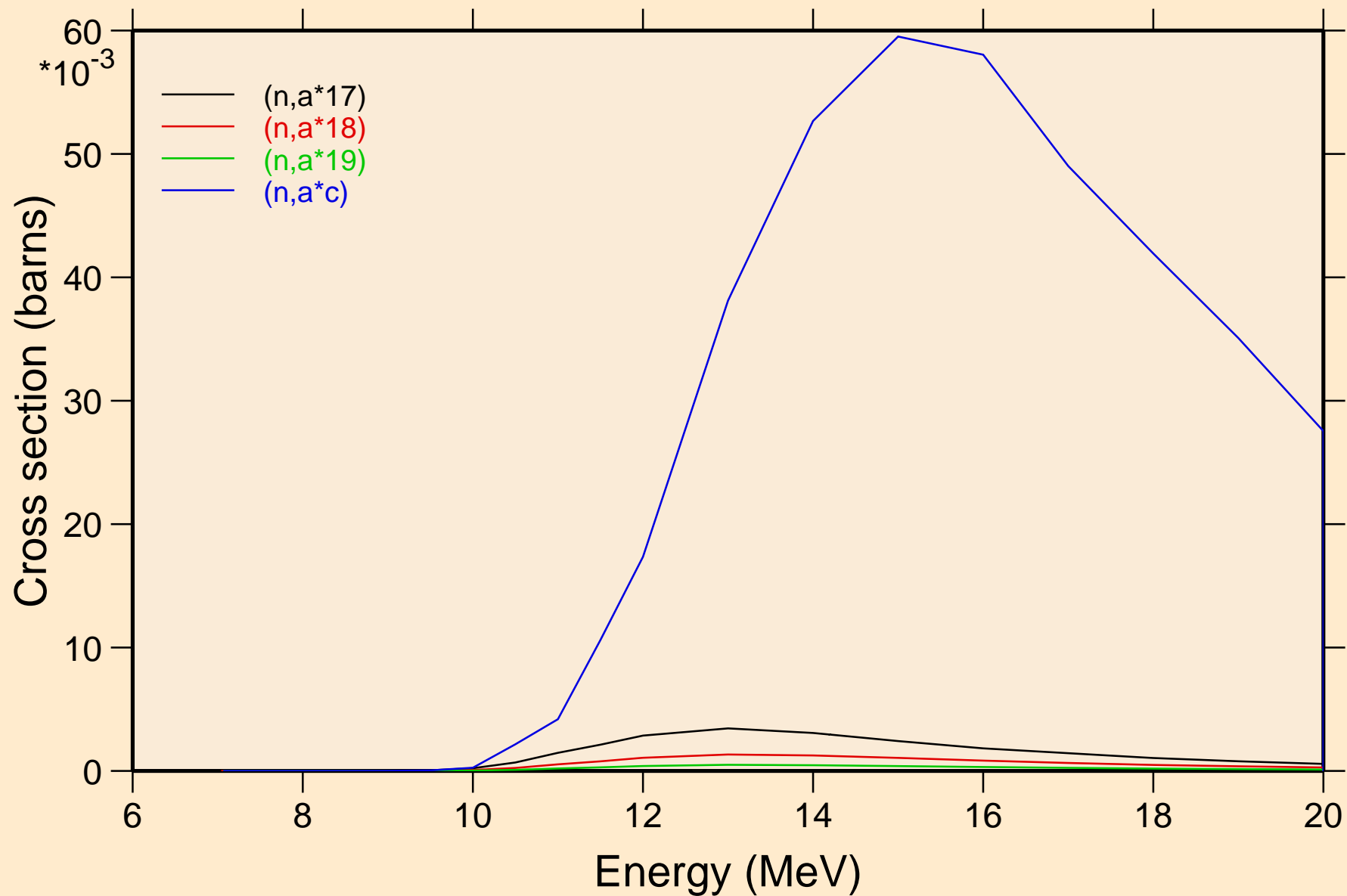

MAT=1325 ACE FILE PRODUCED AT NEA WITH NDEC  
angular distribution for elastic

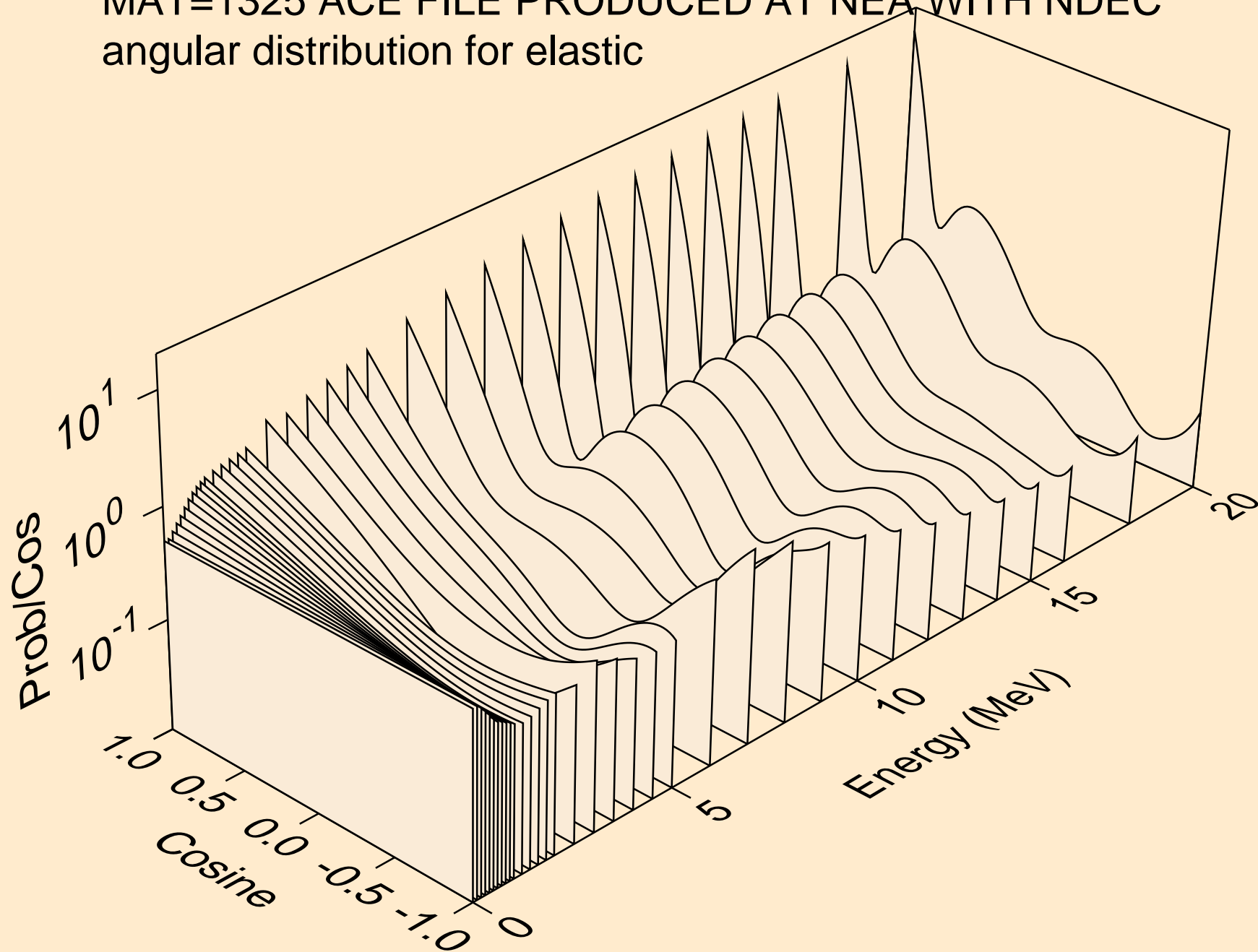

MAT=1325 ACE FILE PRODUCED AT NEA WITH NDEC  
angular distribution for elastic

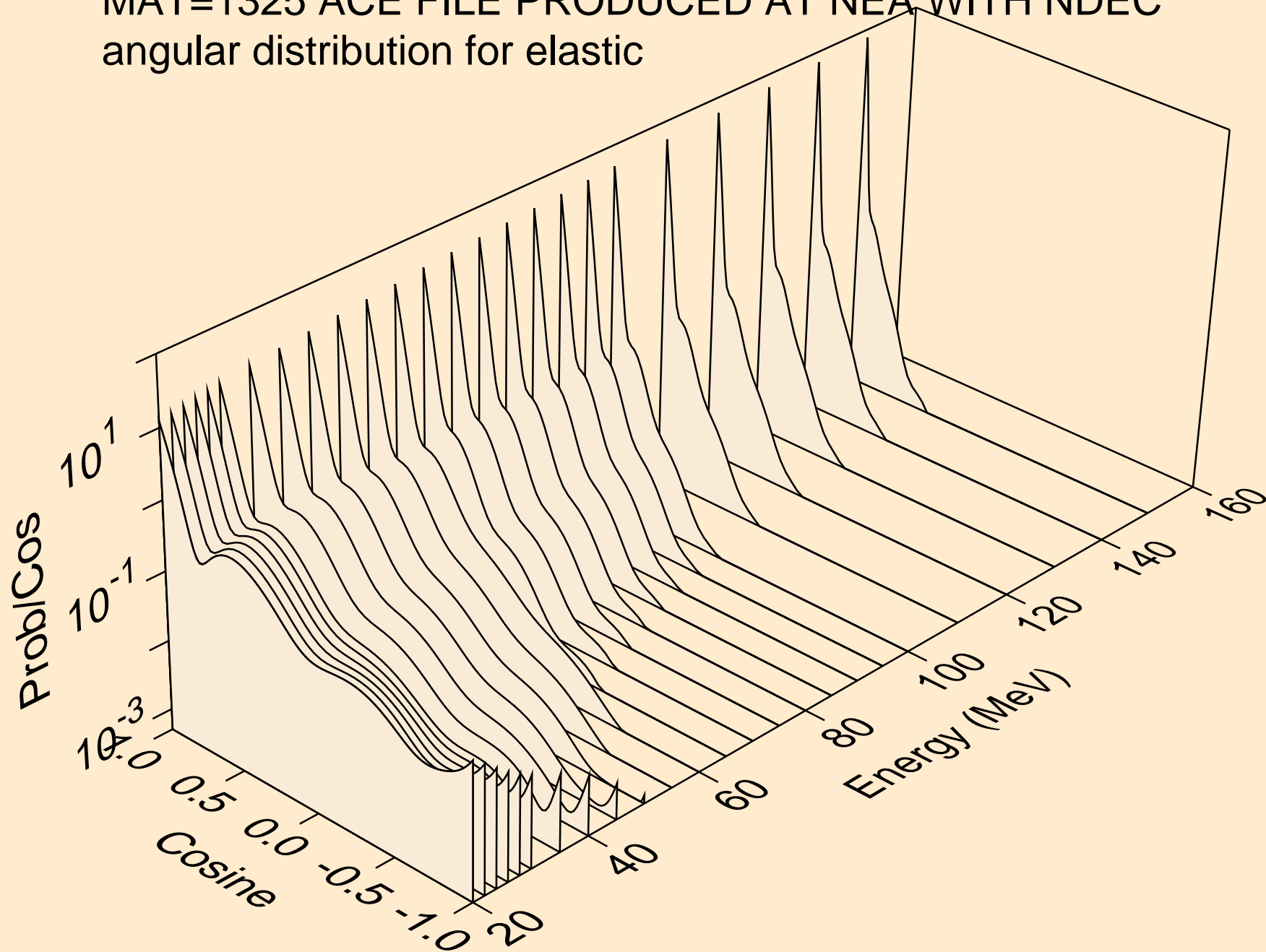

MAT=1325 ACE FILE PRODUCED AT NEA WITH NDEC  
angular distribution for (n,n\*1)

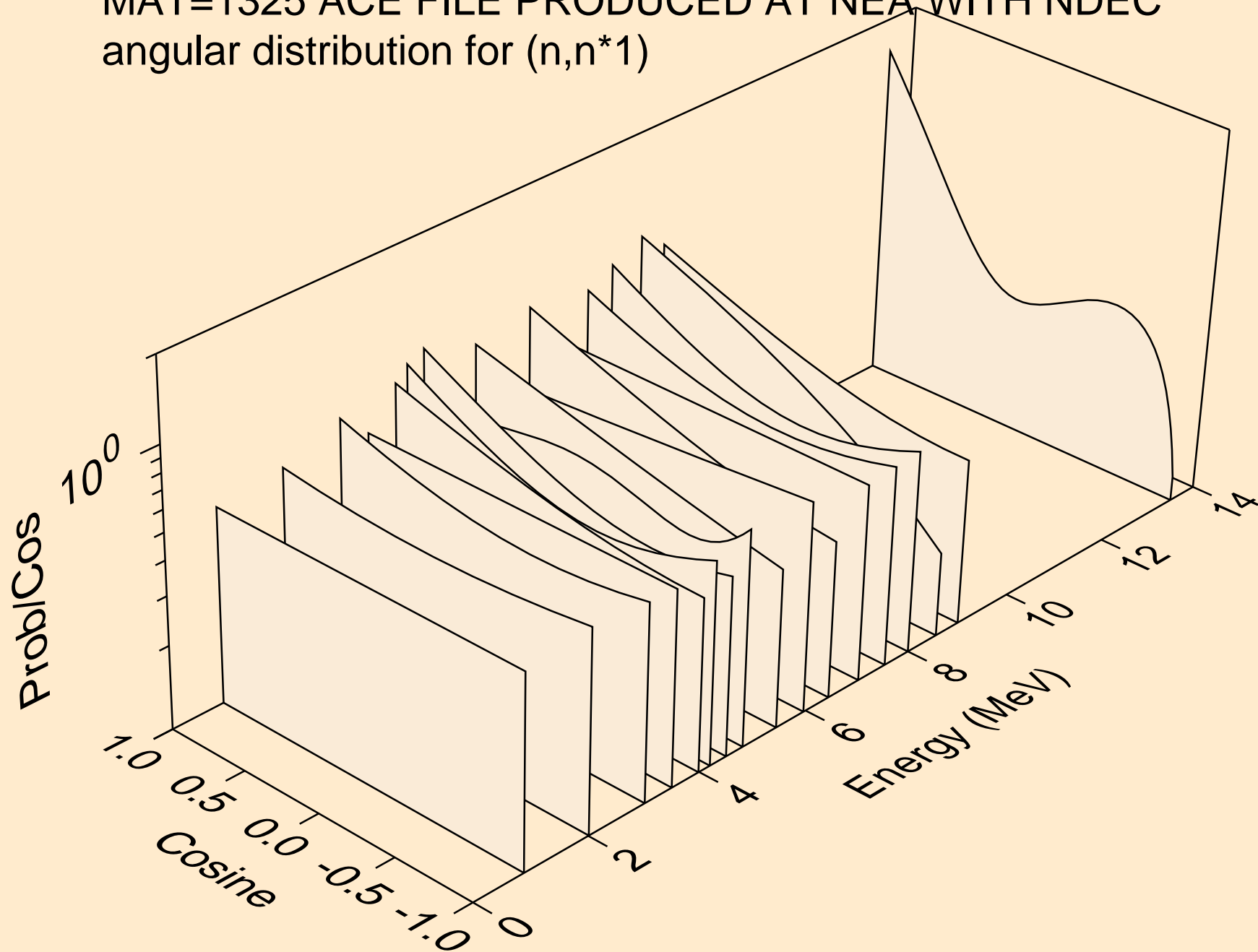

MAT=1325 ACE FILE PRODUCED AT NEA WITH NDEC  
angular distribution for (n,n\*2)

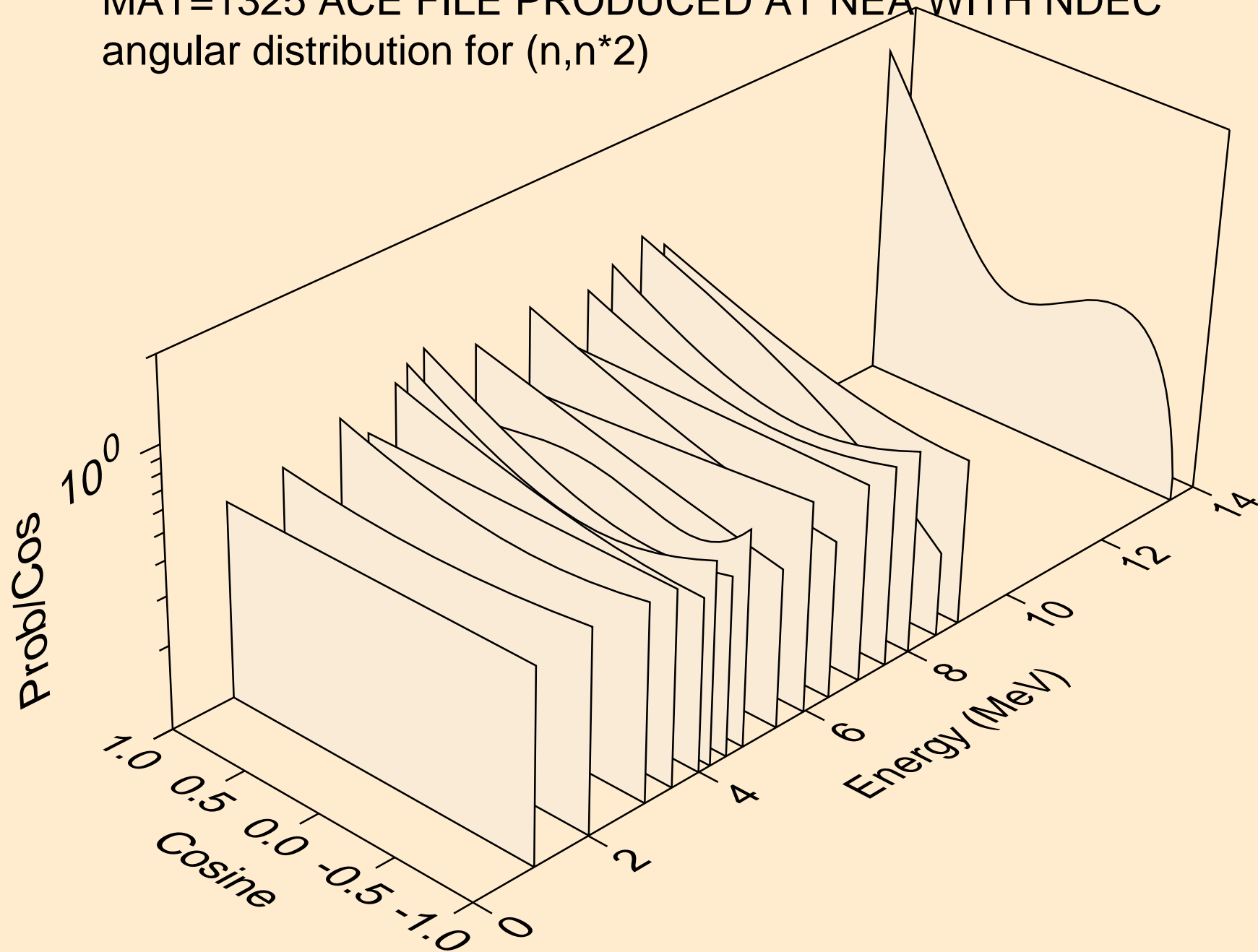



MAT=1325 ACE FILE PRODUCED AT NEA WITH NDEC  
angular distribution for (n,n\*3)

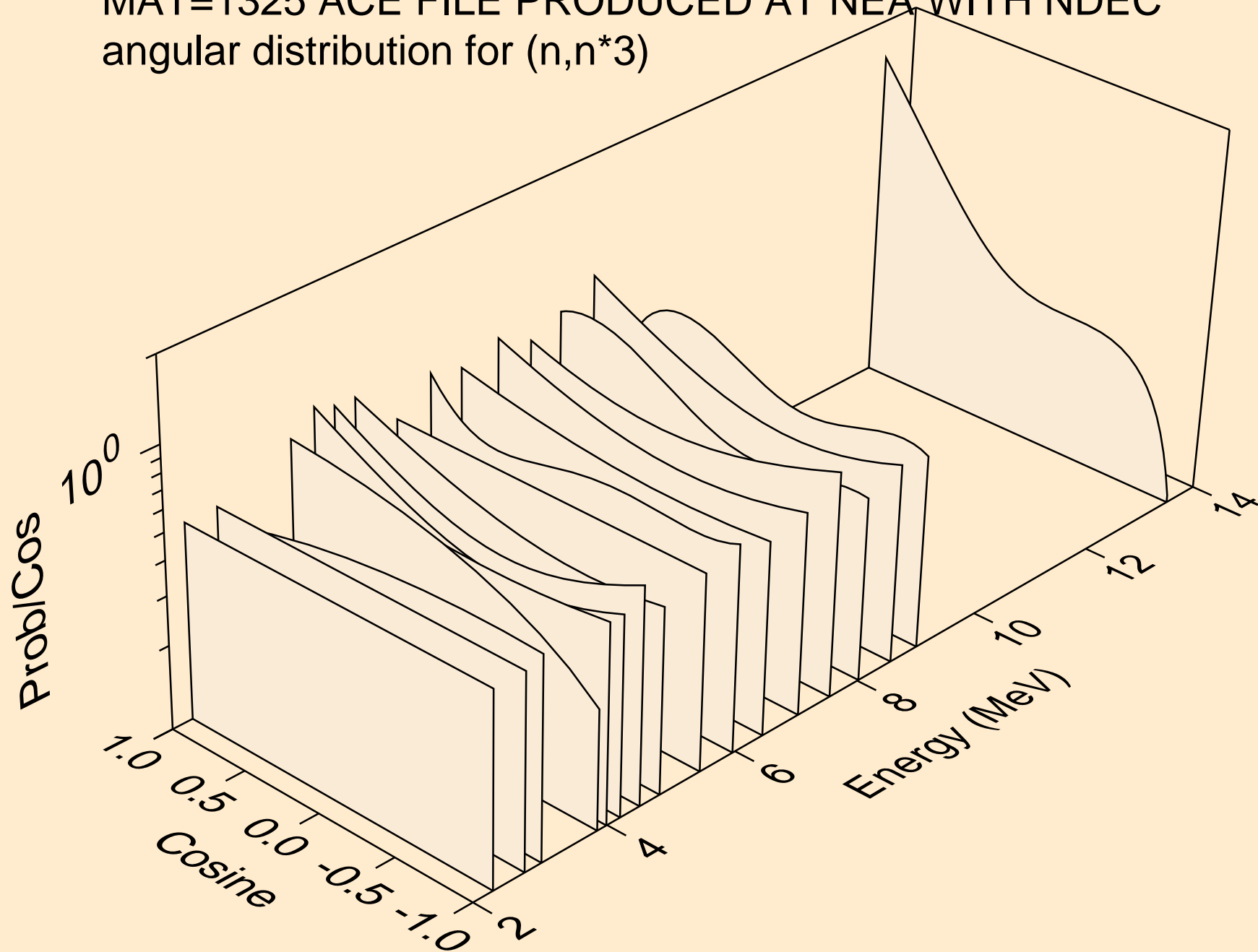

MAT=1325 ACE FILE PRODUCED AT NEA WITH NDEC  
angular distribution for (n,n\*4)

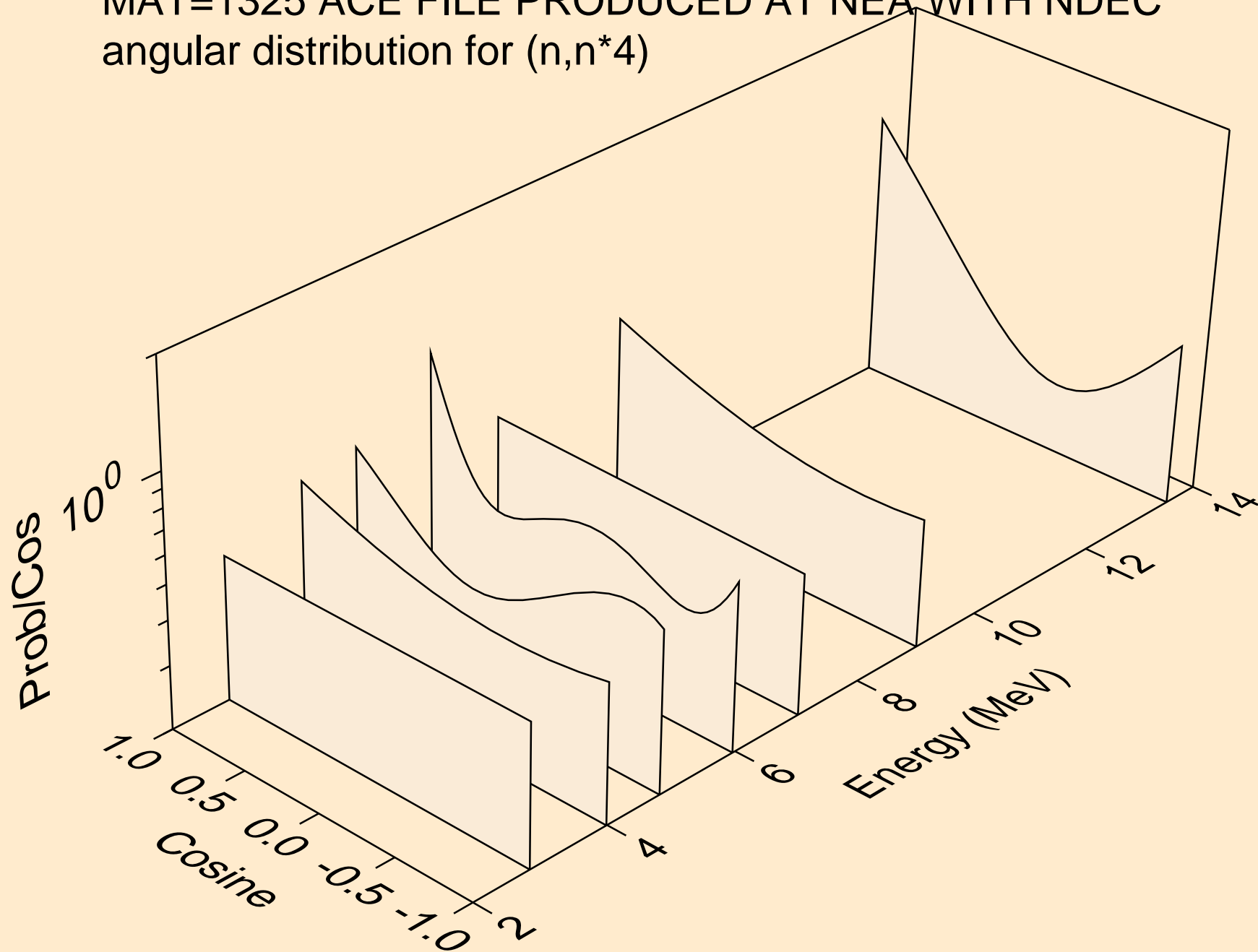

MAT=1325 ACE FILE PRODUCED AT NEA WITH NDEC  
angular distribution for (n,n\*5)

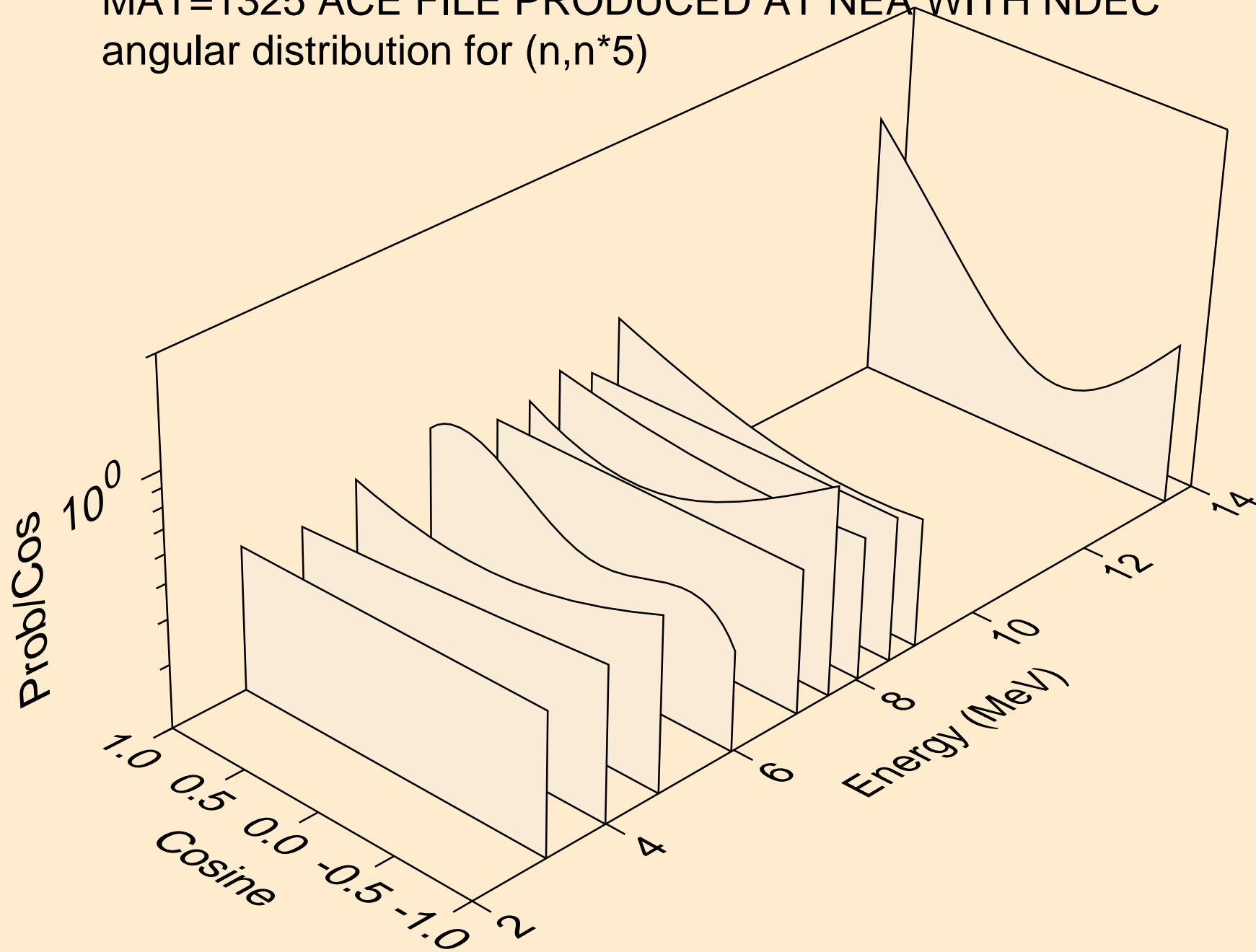

MAT=1325 ACE FILE PRODUCED AT NEA WITH NDEC  
angular distribution for (n,n\*6)

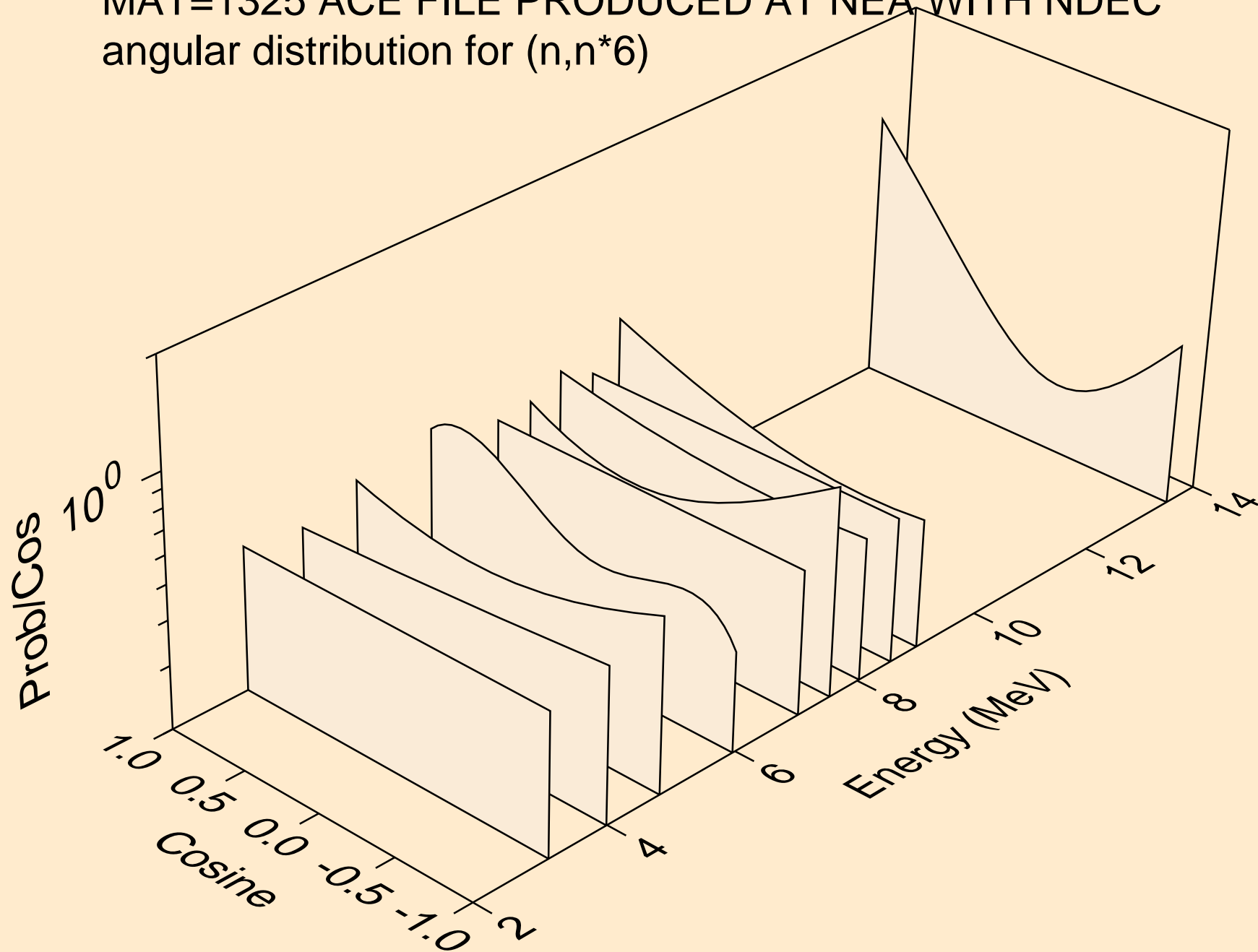

MAT=1325 ACE FILE PRODUCED AT NEA WITH NDEC  
angular distribution for (n,n\*7)

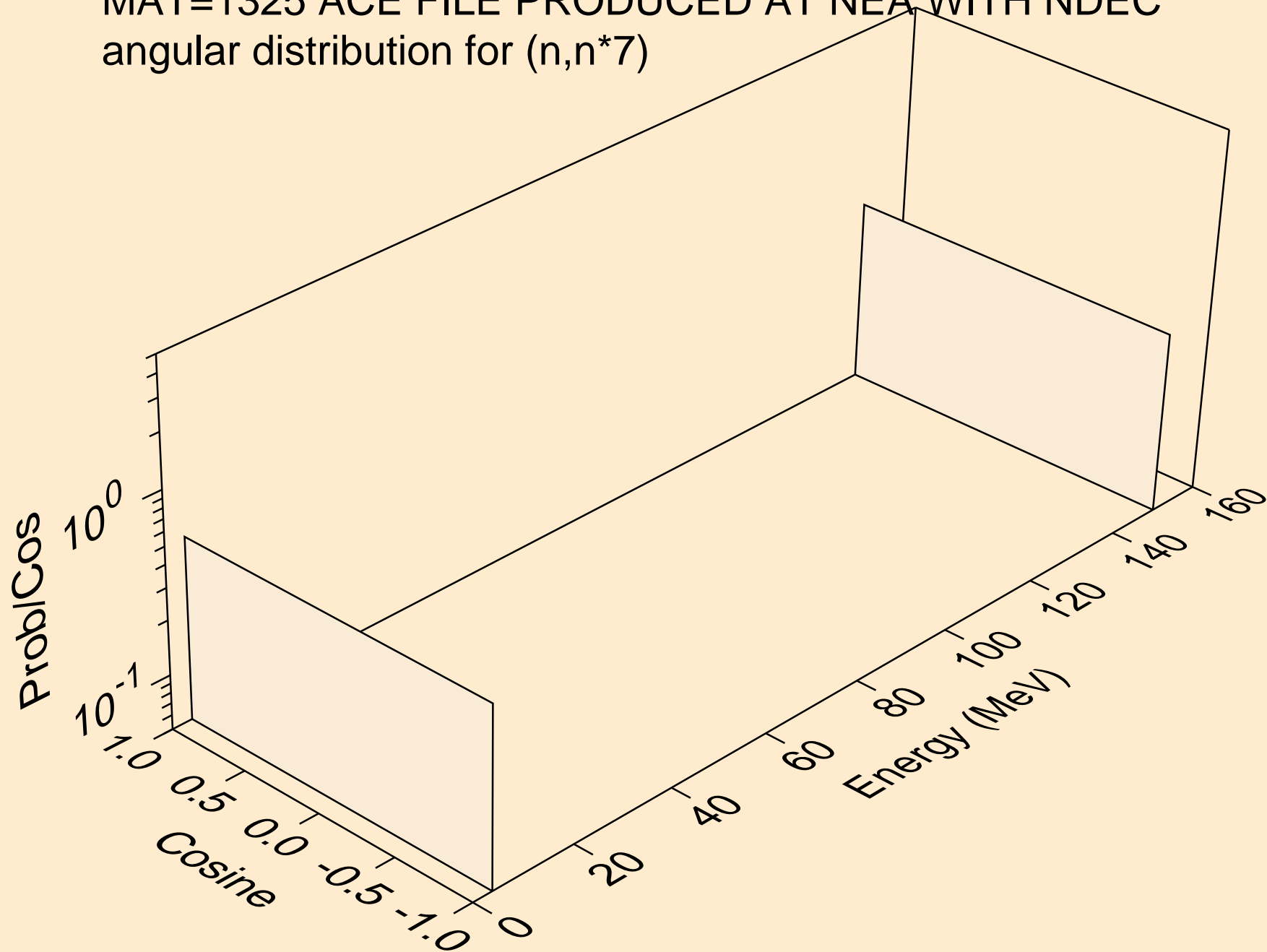

MAT=1325 ACE FILE PRODUCED AT NEA WITH NDEC  
angular distribution for (n,n\*8)

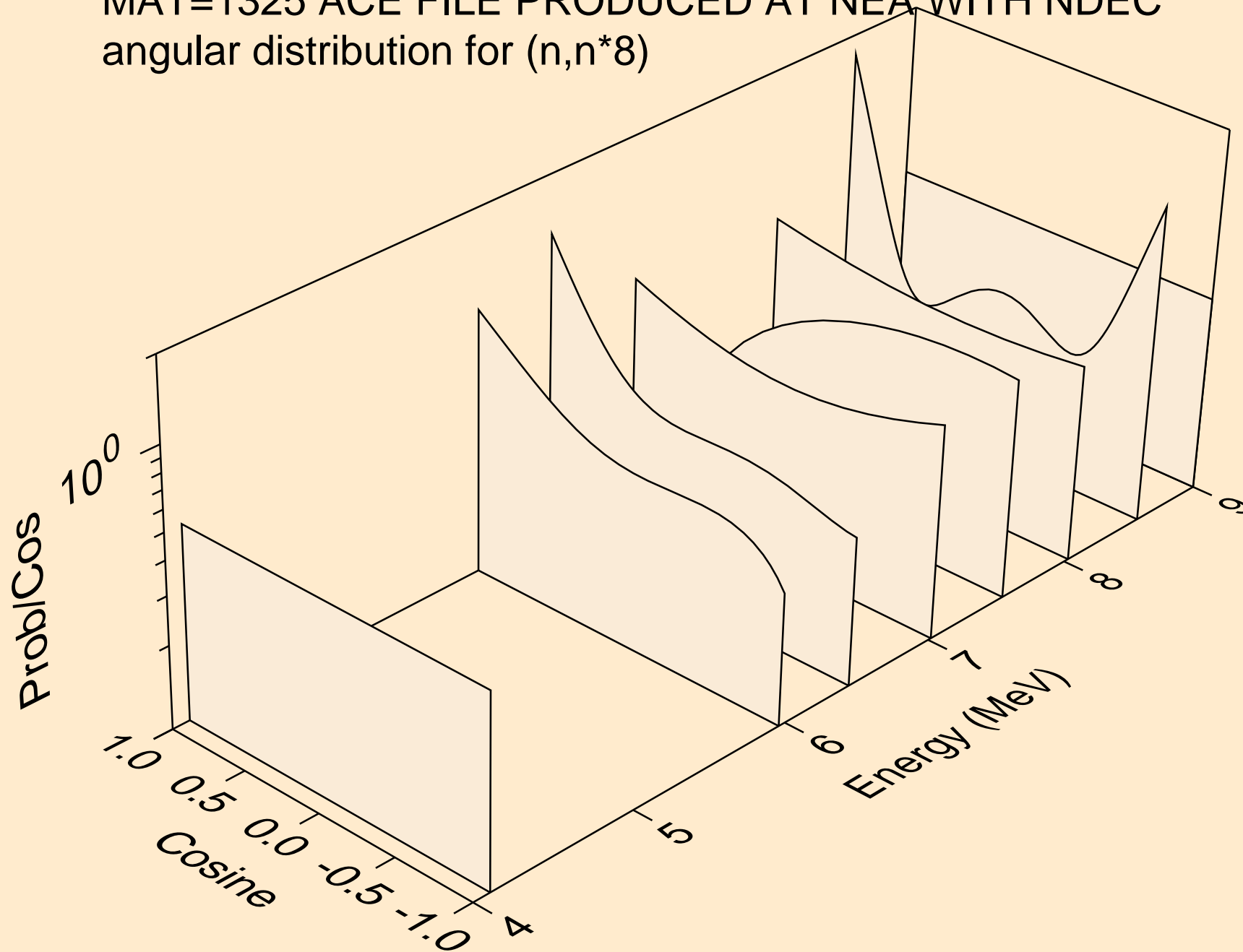

MAT=1325 ACE FILE PRODUCED AT NEA WITH NDEC  
angular distribution for (n,n\*9)

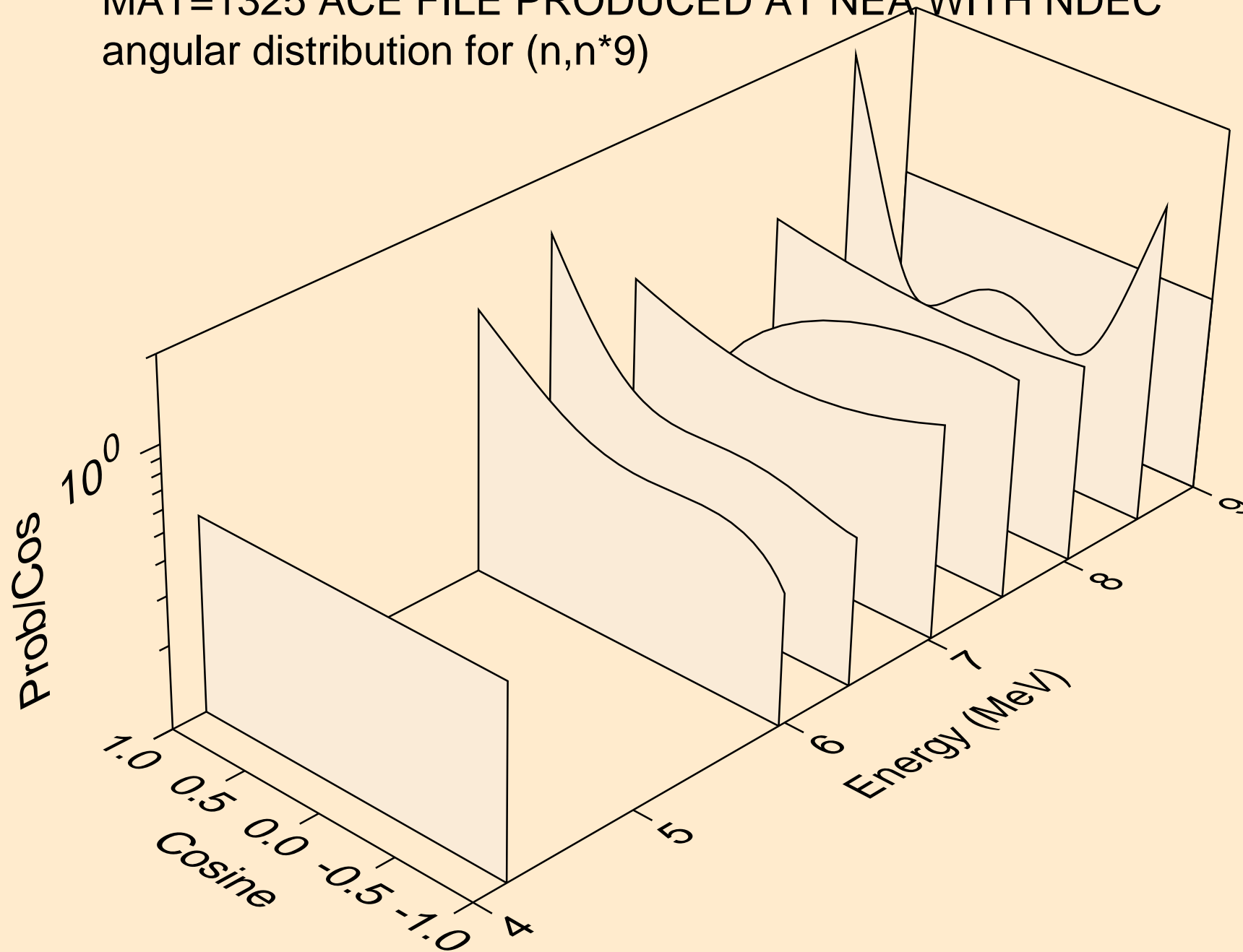

MAT=1325 ACE FILE PRODUCED AT NEA WITH NDEC  
angular distribution for (n,n\*10)

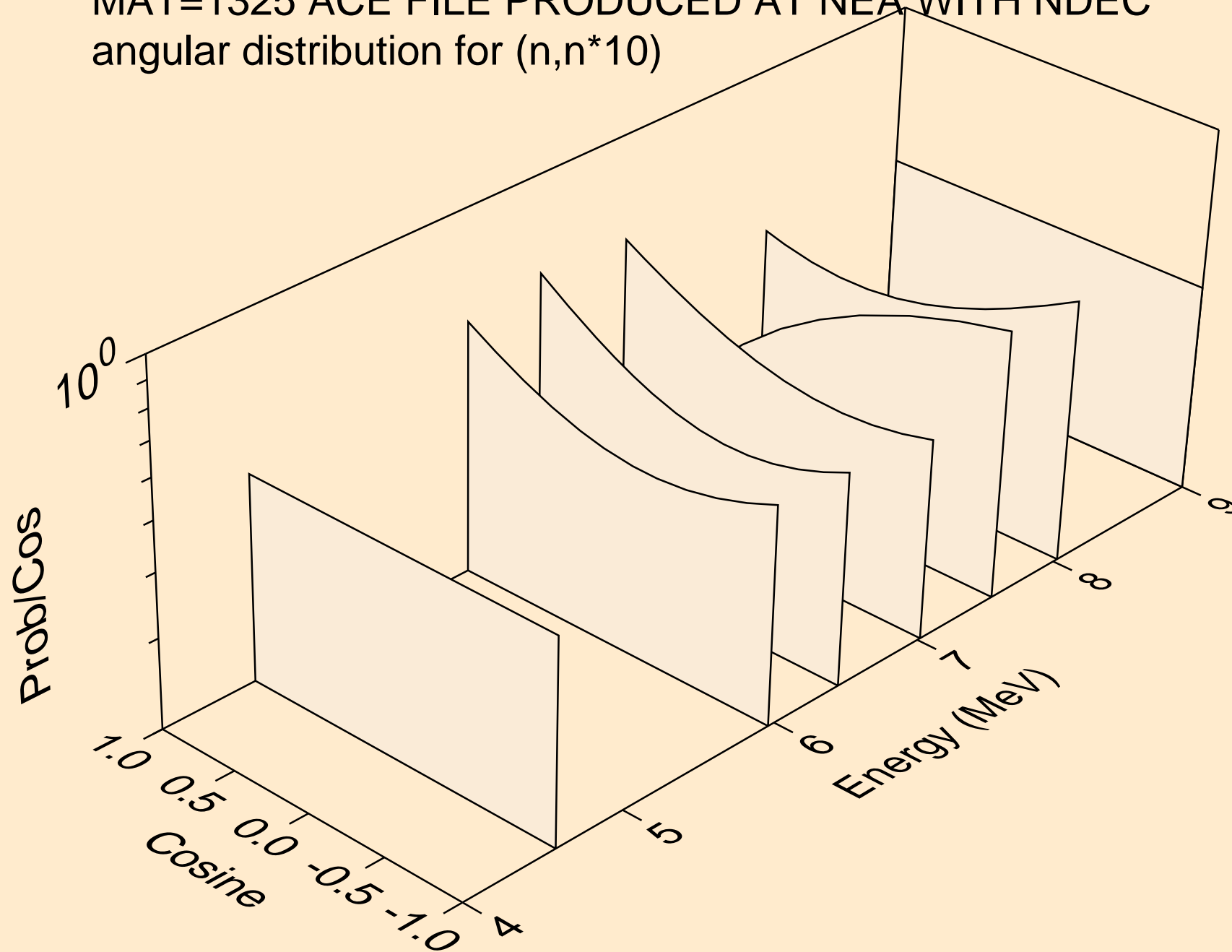



MAT=1325 ACE FILE PRODUCED AT NEA WITH NDEC  
angular distribution for (n,n\*11)

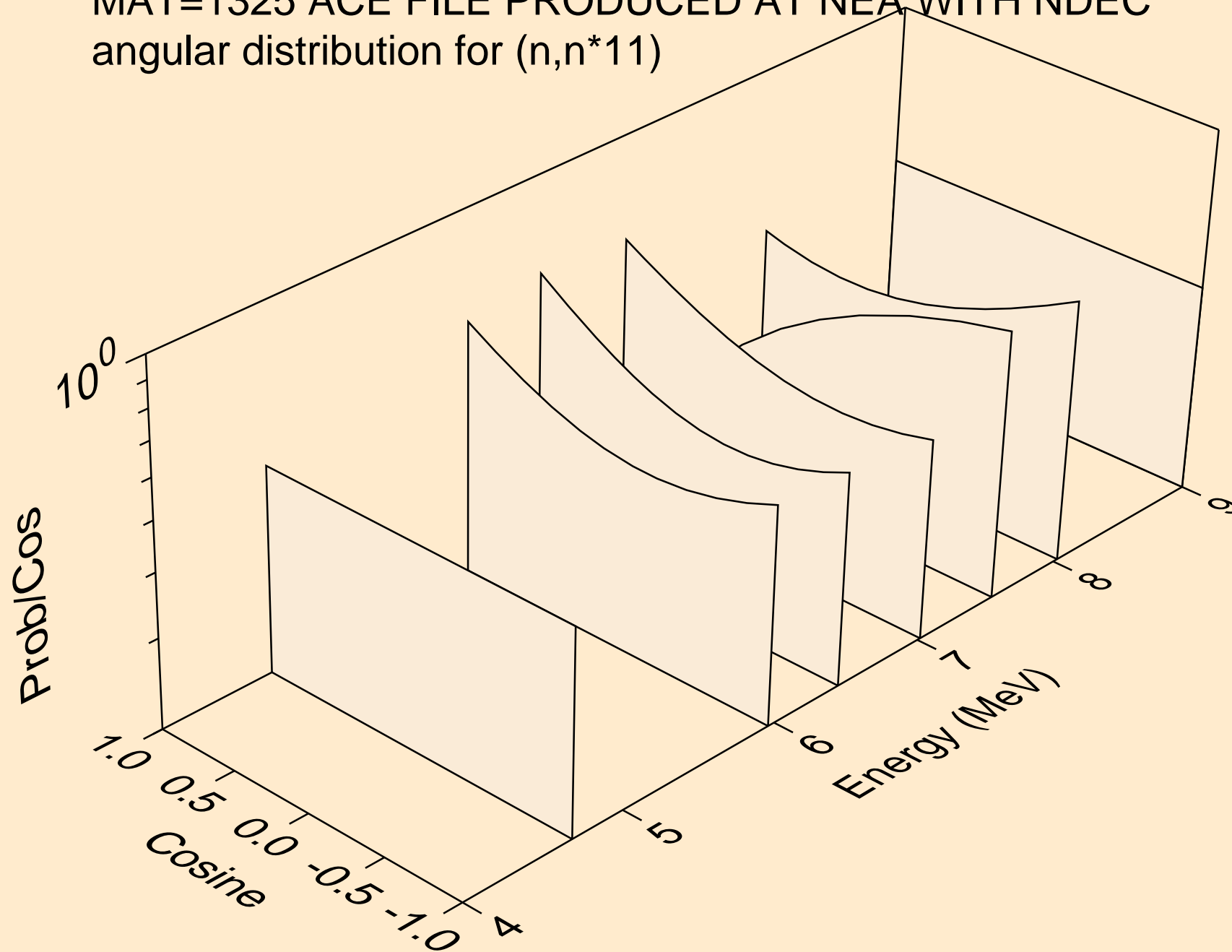

MAT=1325 ACE FILE PRODUCED AT NEA WITH NDEC  
angular distribution for (n,n\*12)

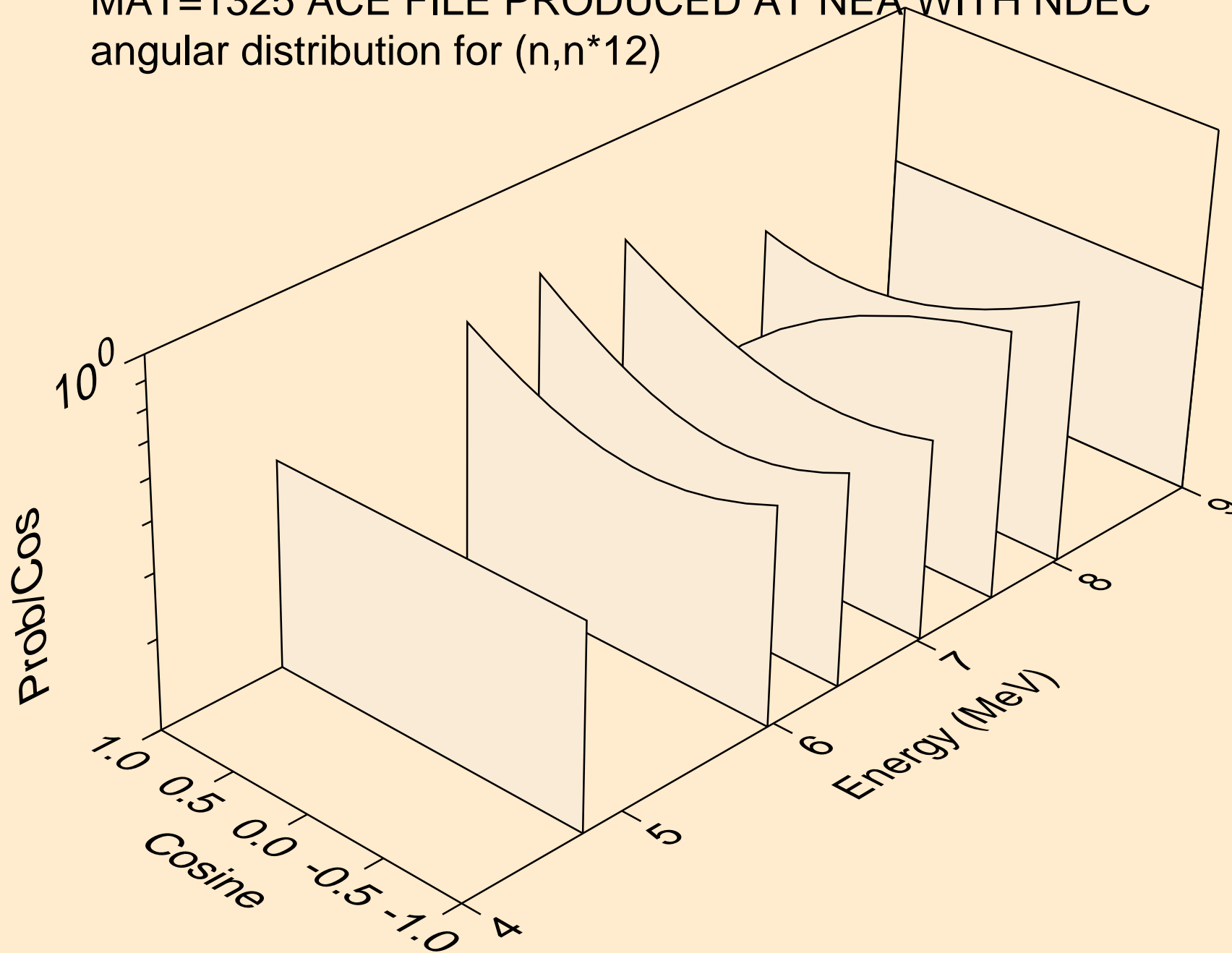

MAT=1325 ACE FILE PRODUCED AT NEA WITH NDEC  
angular distribution for (n,n\*13)

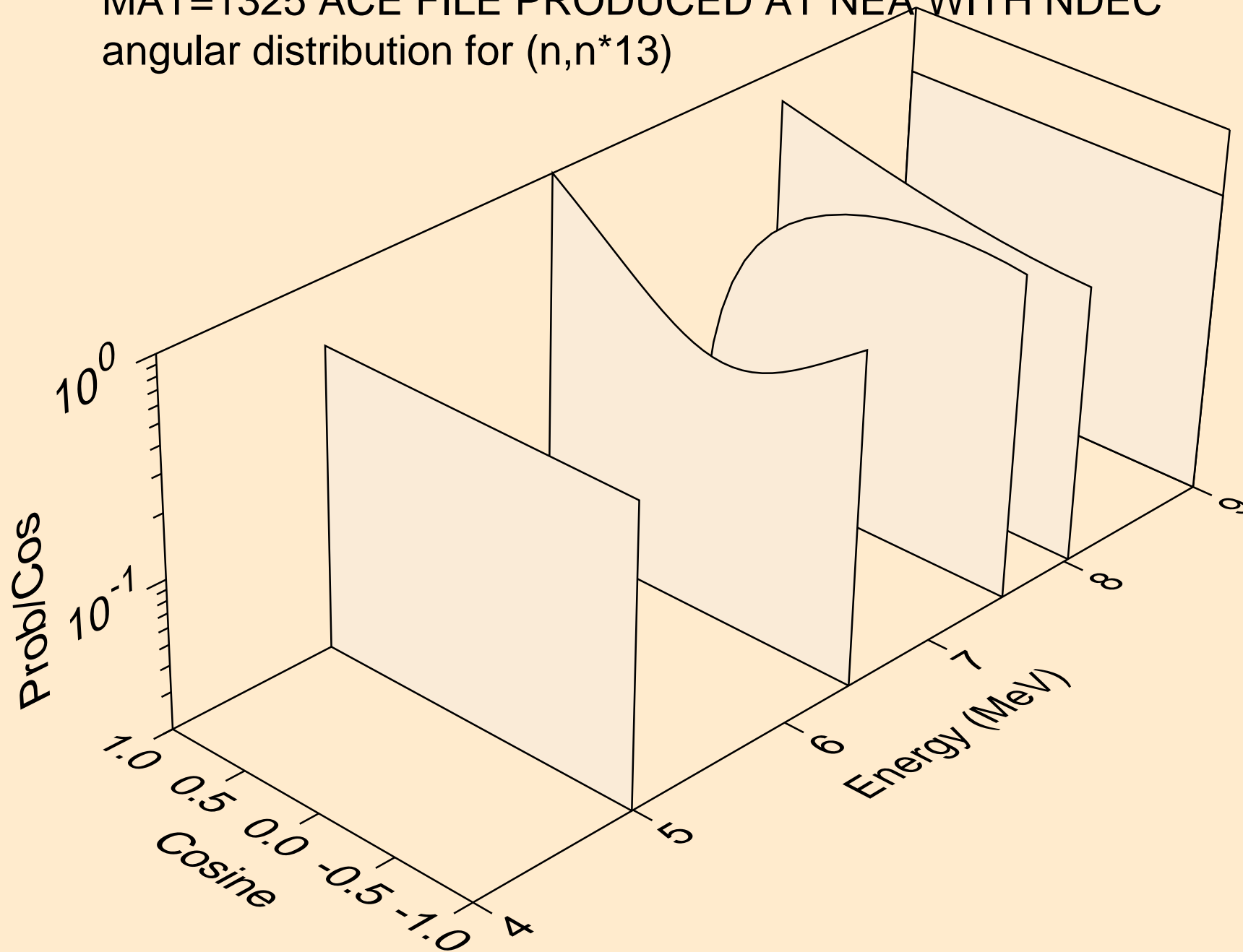

MAT=1325 ACE FILE PRODUCED AT NEA WITH NDEC  
angular distribution for (n,n\*14)

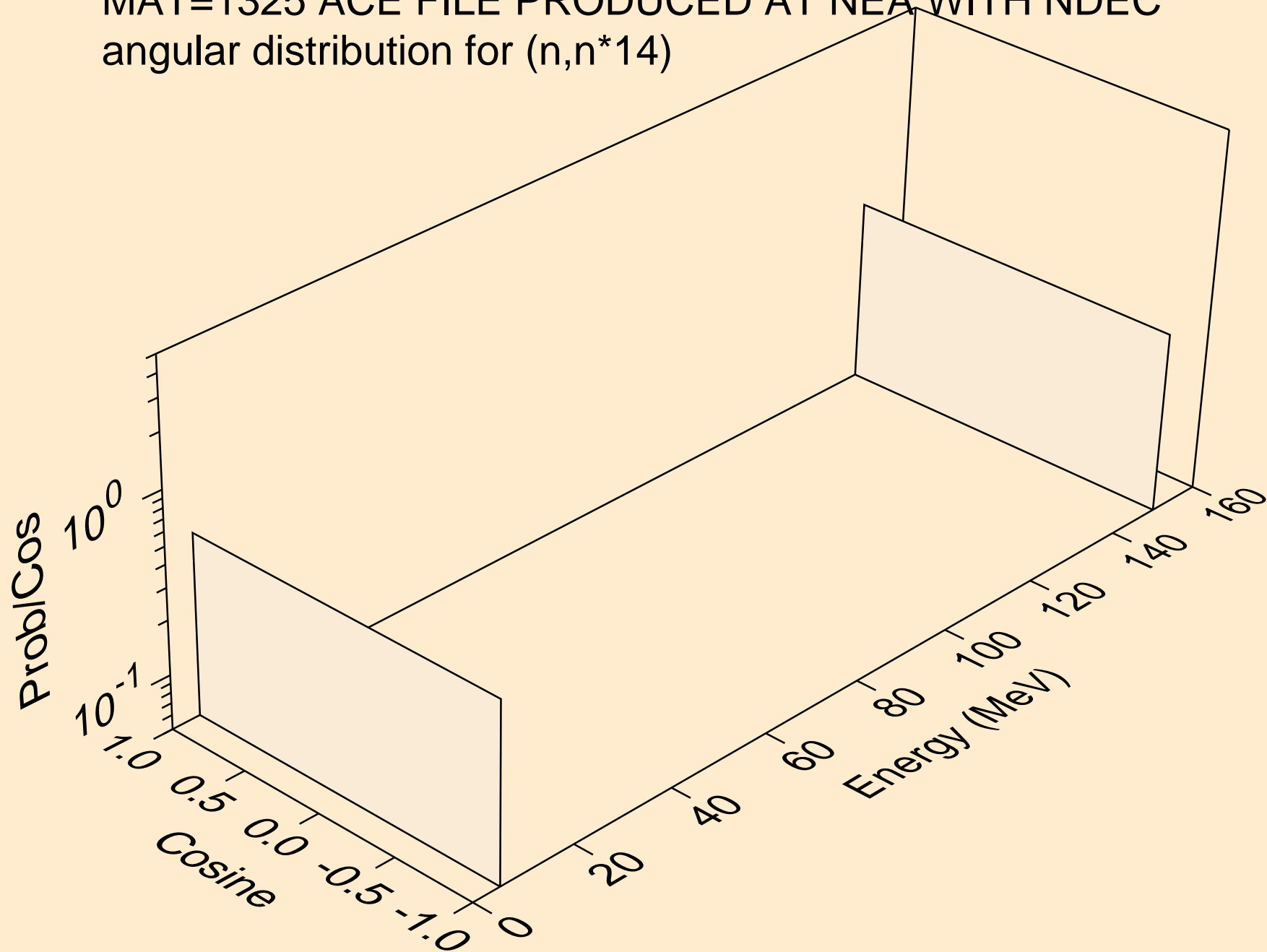

MAT=1325 ACE FILE PRODUCED AT NEA WITH NDEC  
angular distribution for (n,n\*15)

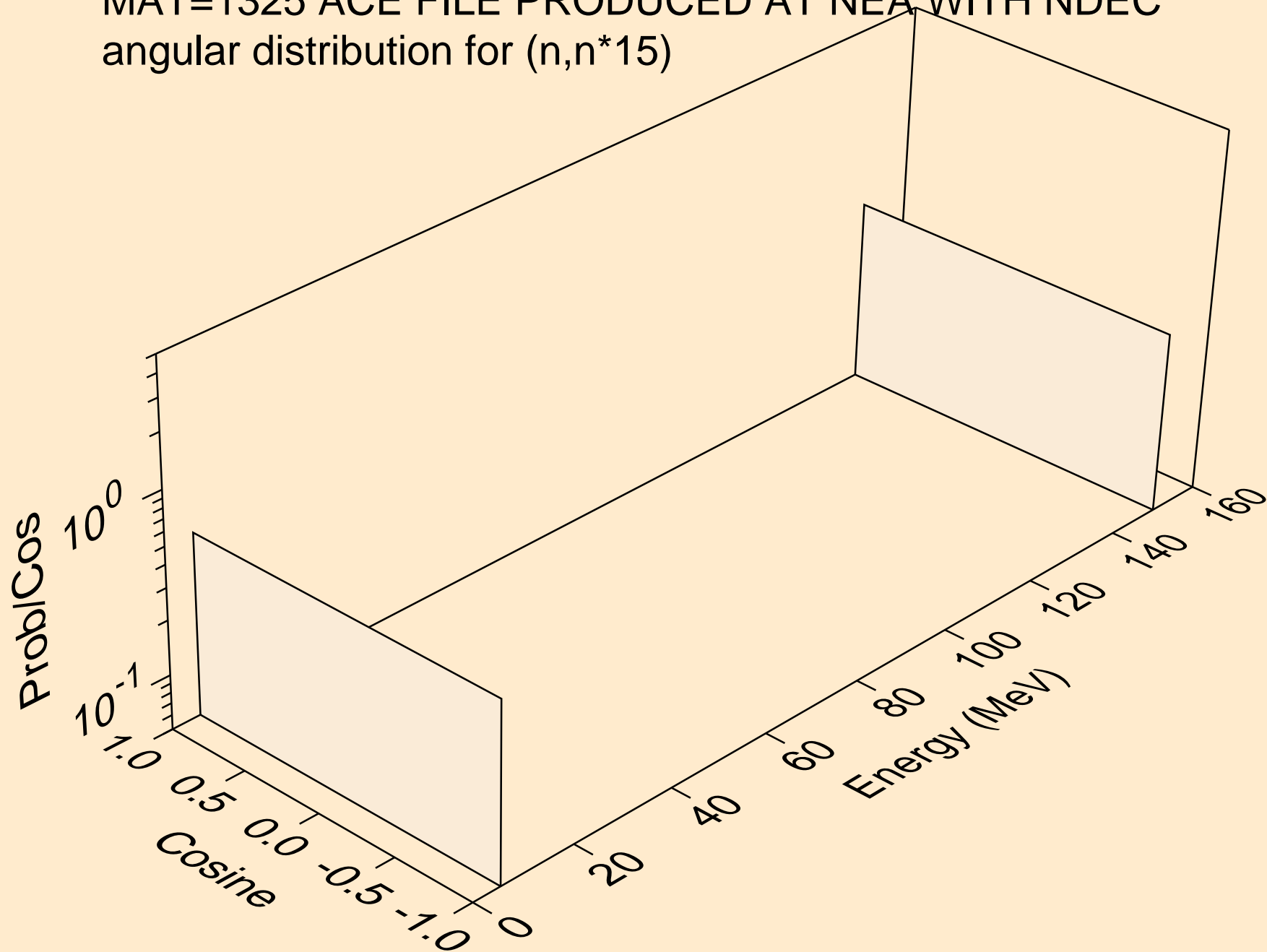

MAT=1325 ACE FILE PRODUCED AT NEA WITH NDEC  
angular distribution for (n,n\*16)

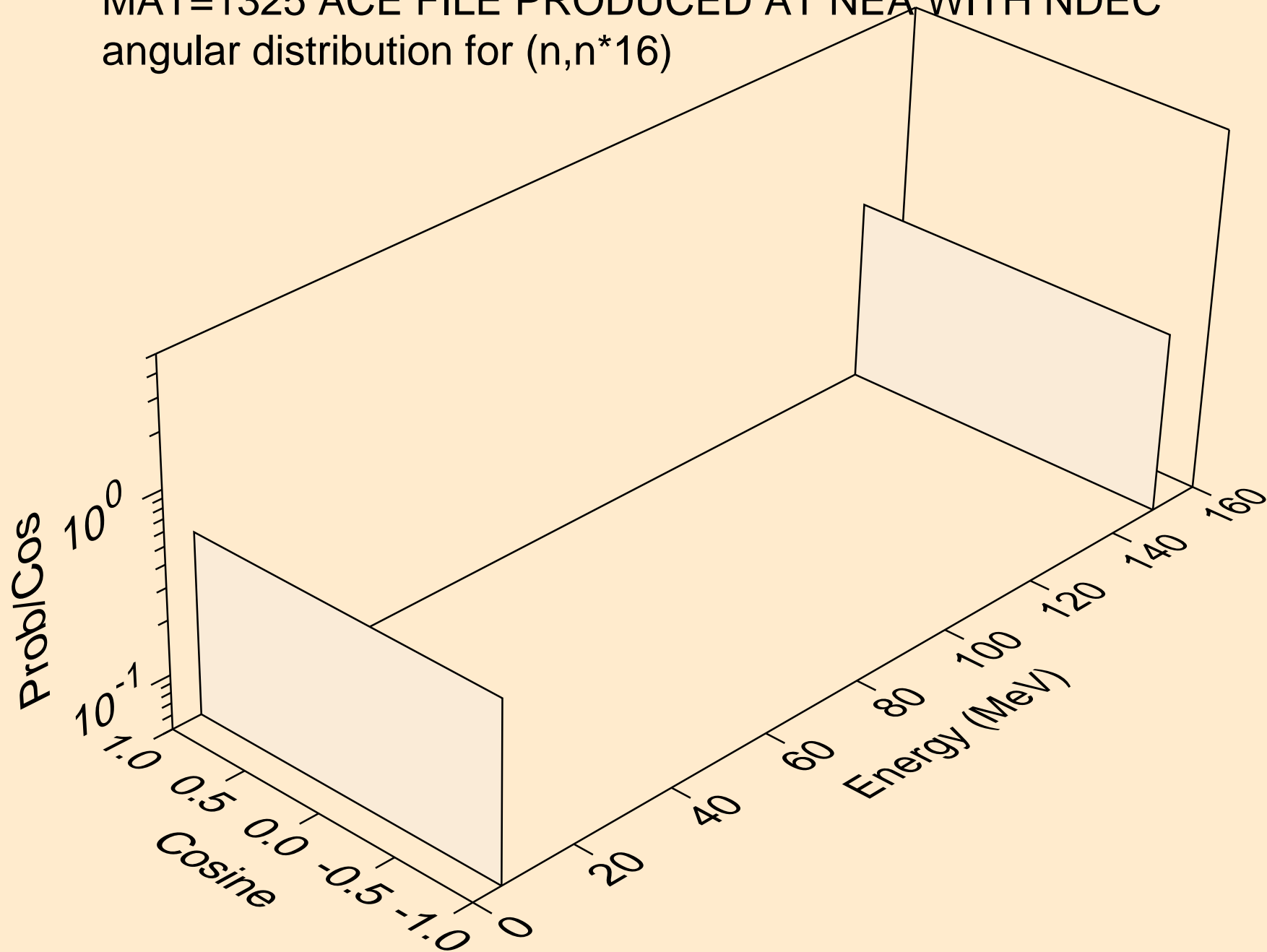

MAT=1325 ACE FILE PRODUCED AT NEA WITH NDEC  
angular distribution for (n,n\*17)

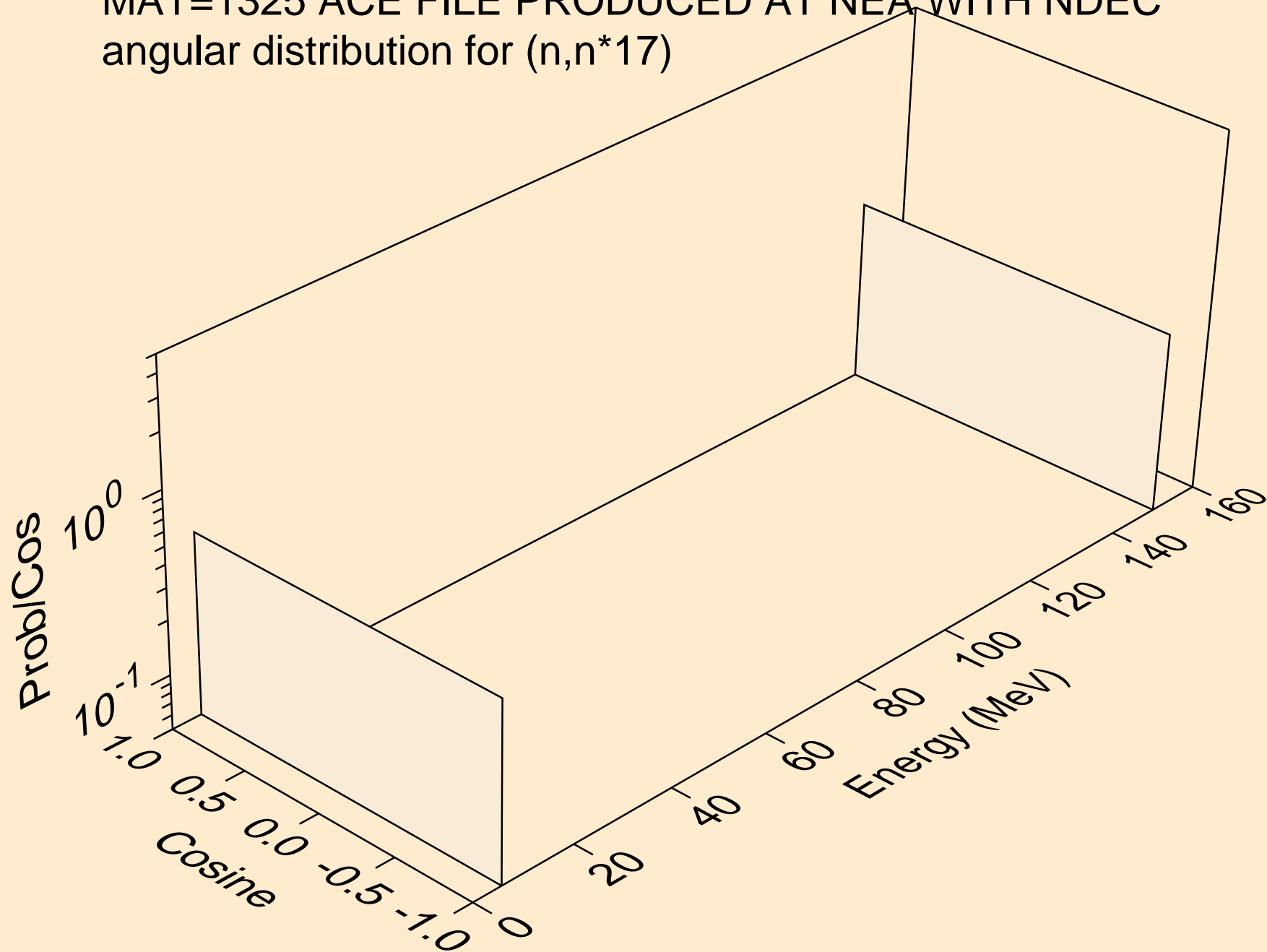

MAT=1325 ACE FILE PRODUCED AT NEA WITH NDEC  
angular distribution for (n,n\*18)

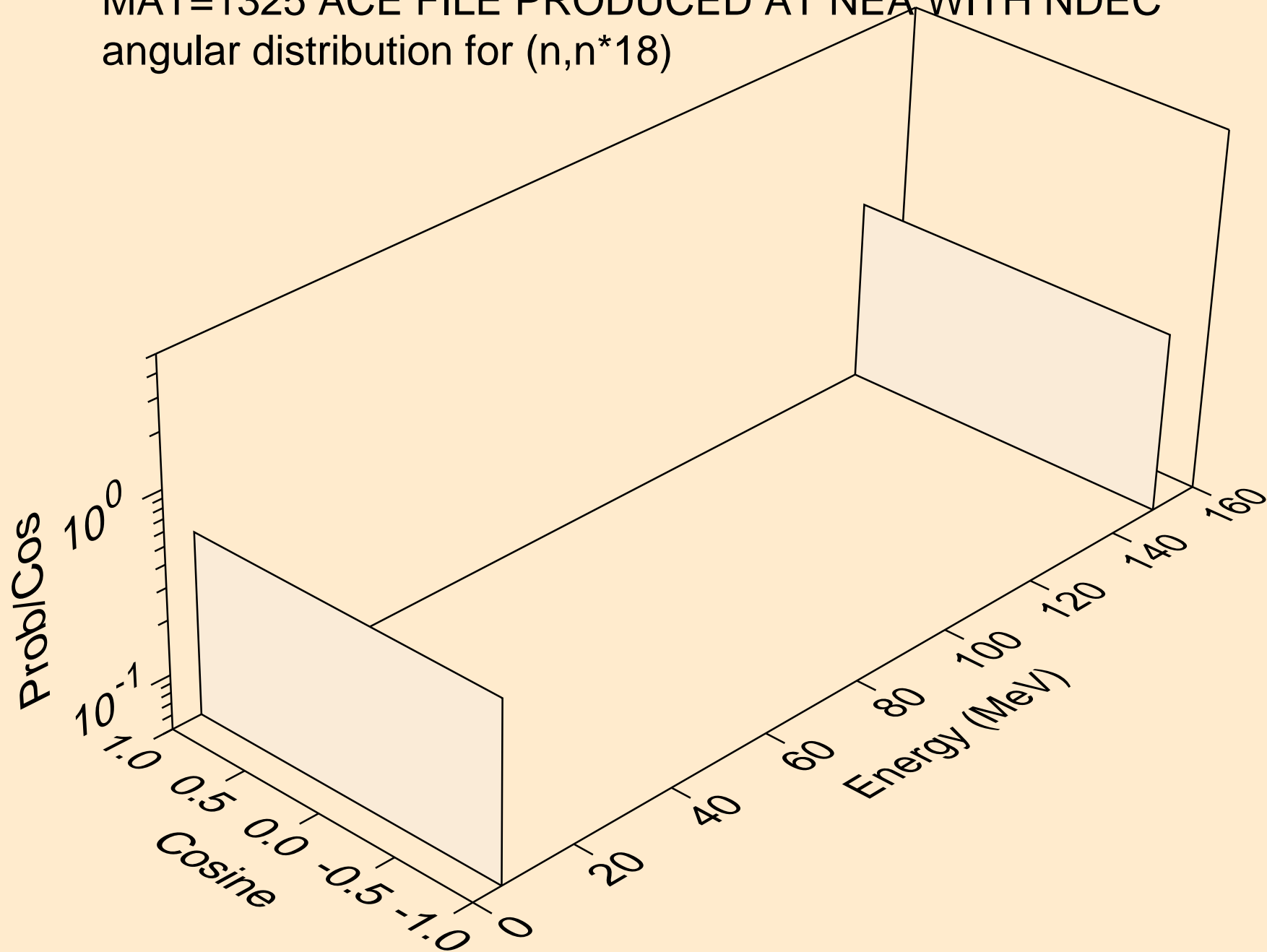



MAT=1325 ACE FILE PRODUCED AT NEA WITH NDEC  
angular distribution for (n,n\*19)

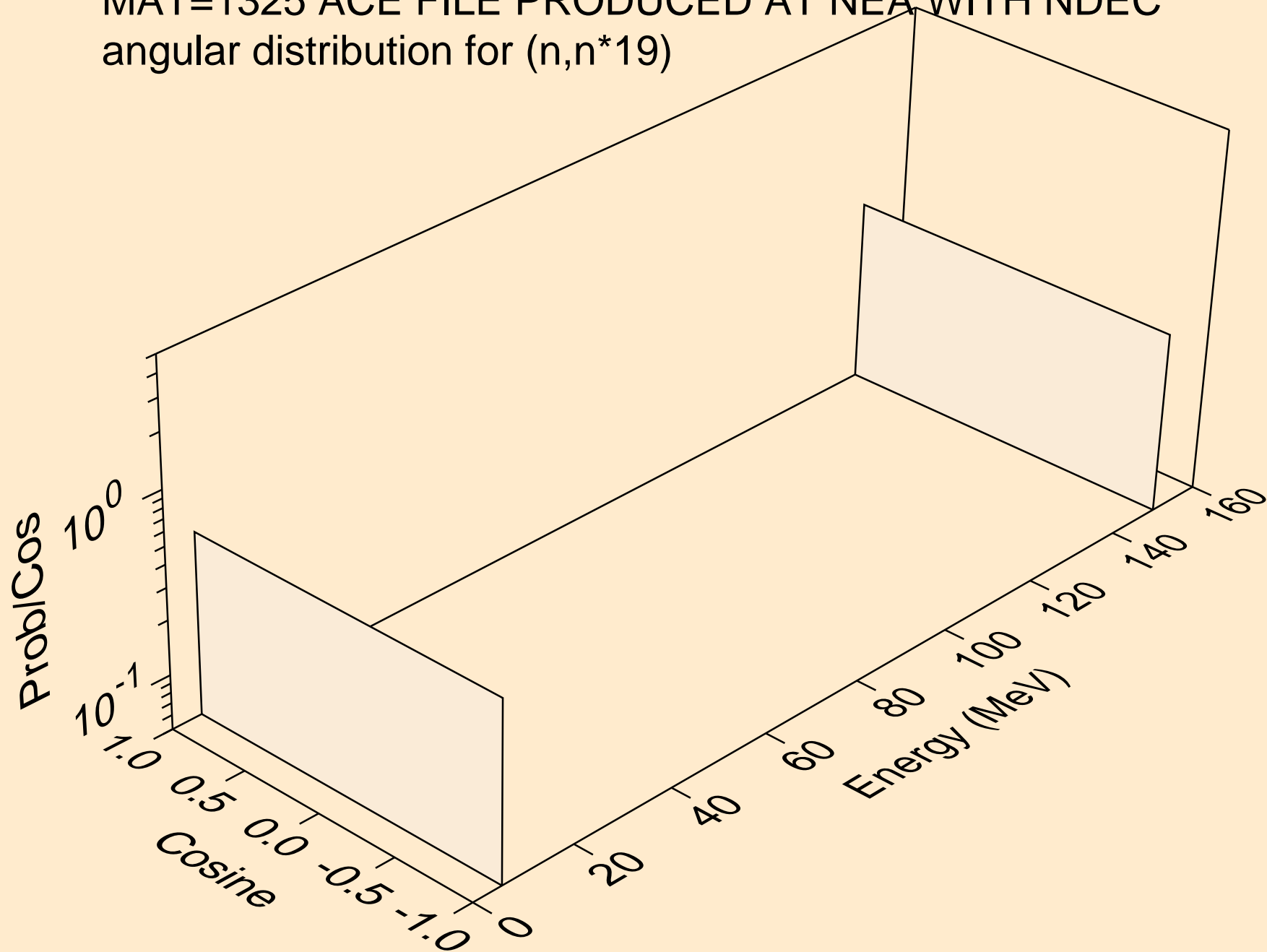

MAT=1325 ACE FILE PRODUCED AT NEA WITH NDEC  
angular distribution for (n,n\*20)

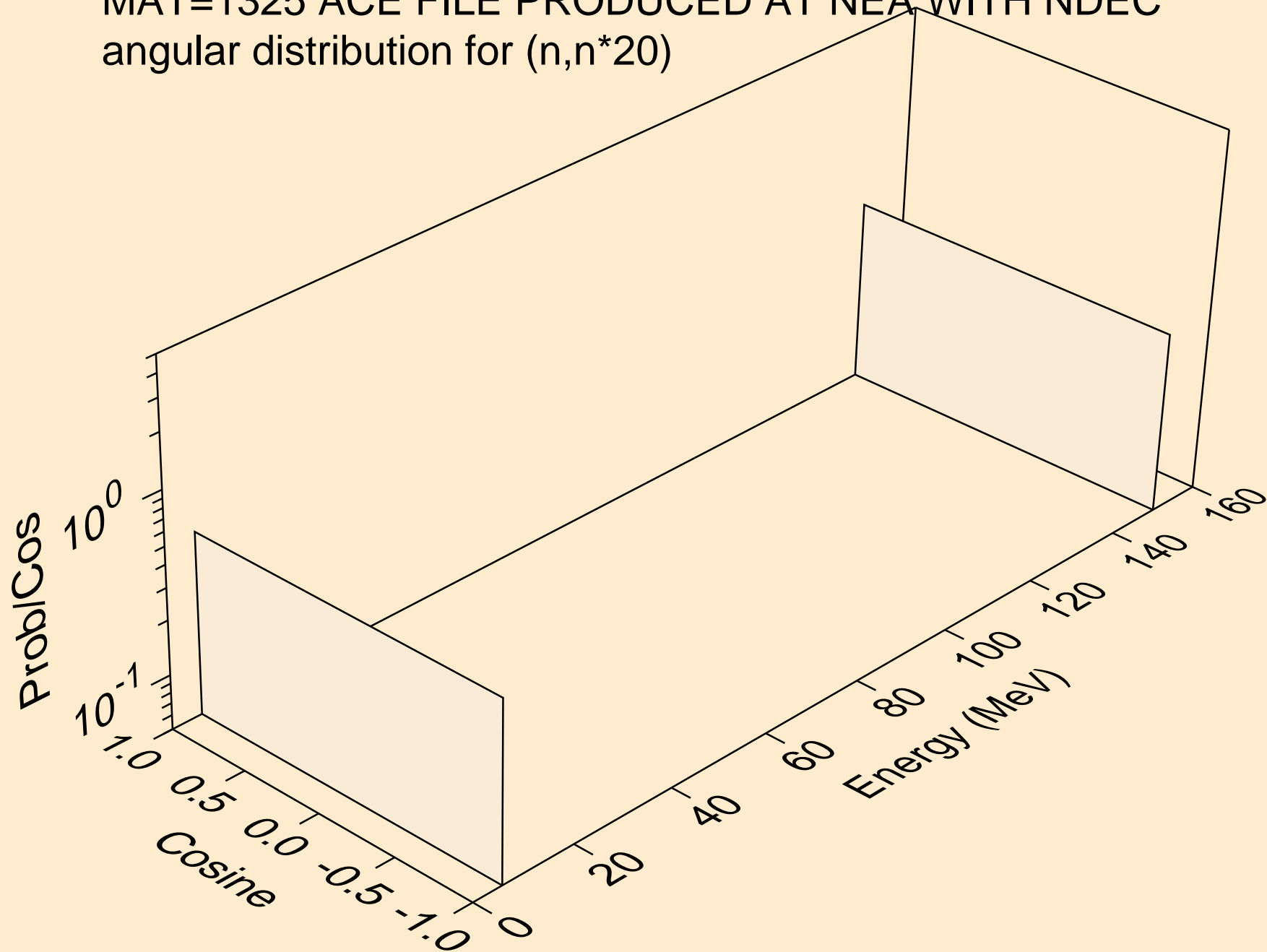

MAT=1325 ACE FILE PRODUCED AT NEA WITH NDEC  
angular distribution for (n,n\*21)

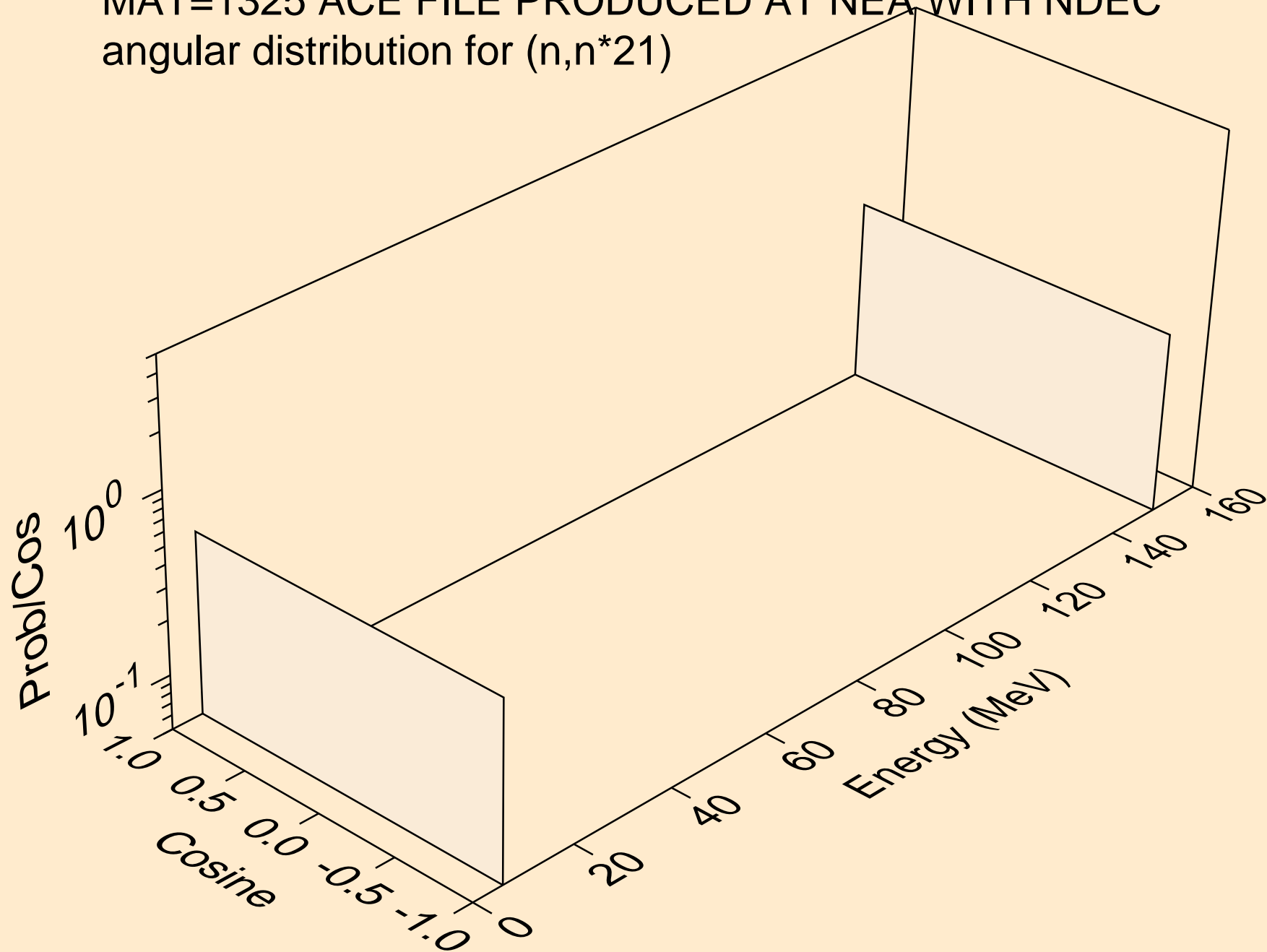

MAT=1325 ACE FILE PRODUCED AT NEA WITH NDEC  
angular distribution for (n,n\*22)

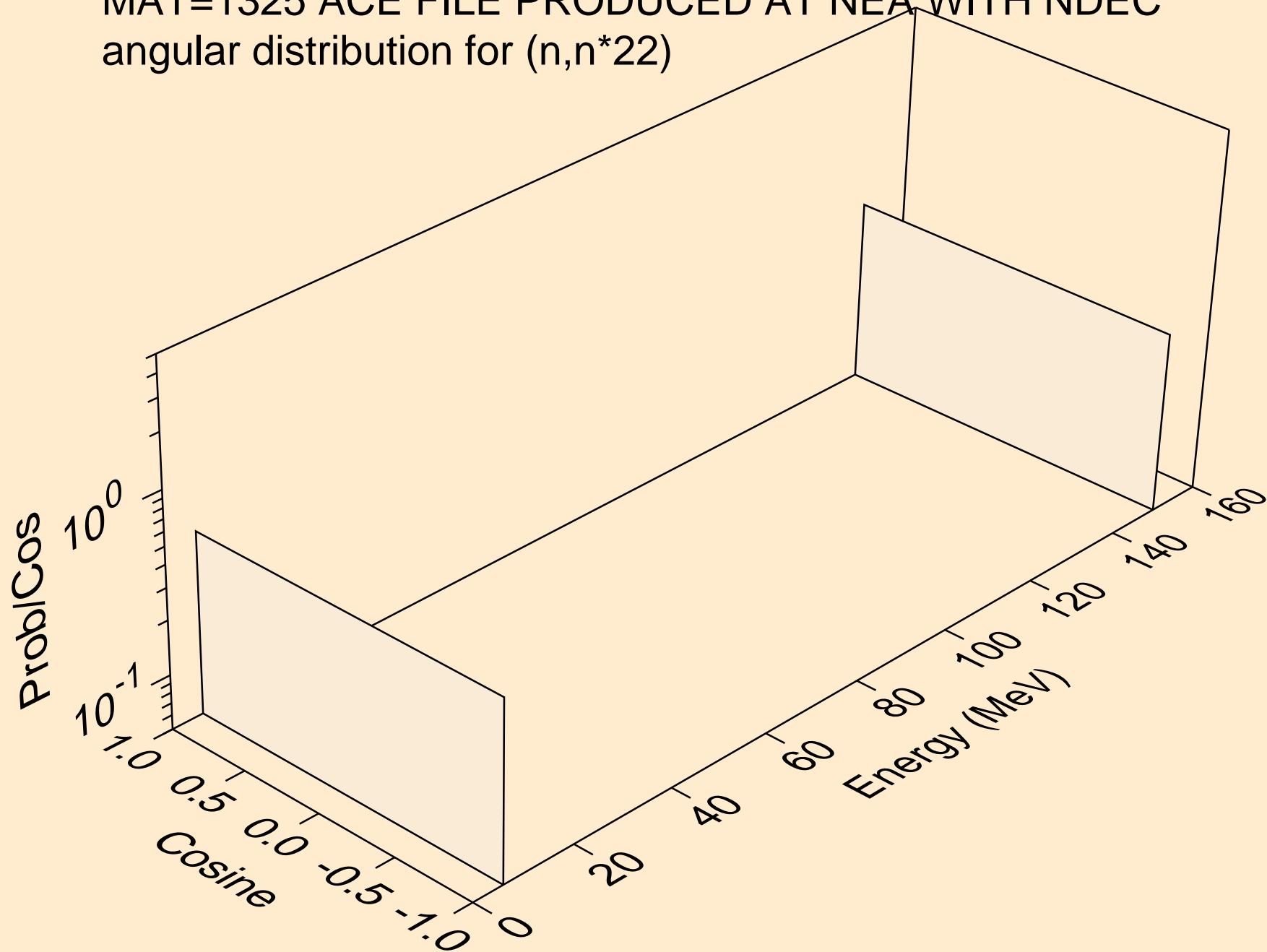

MAT=1325 ACE FILE PRODUCED AT NEA WITH NDEC  
angular distribution for (n,n\*23)

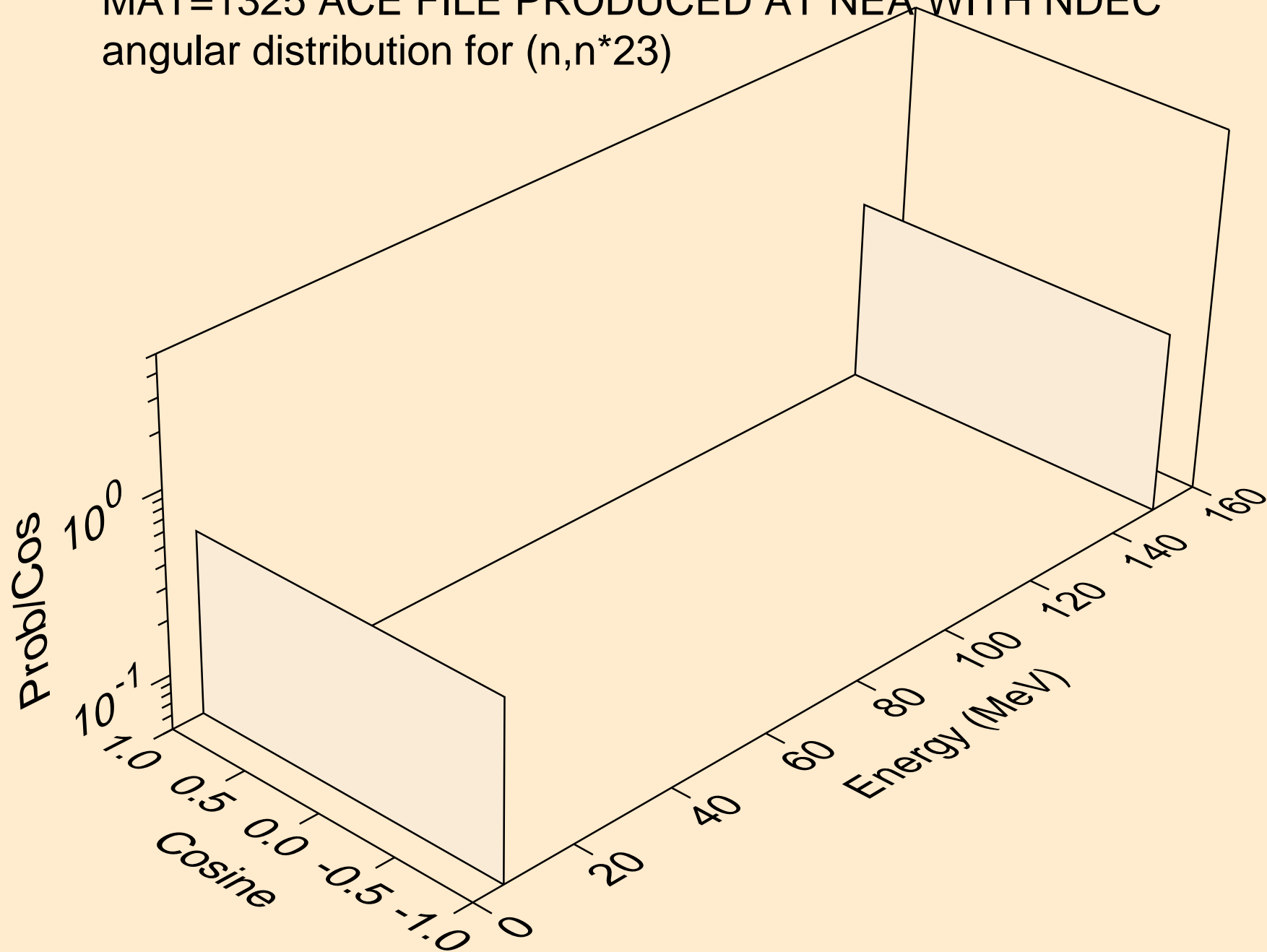

MAT=1325 ACE FILE PRODUCED AT NEA WITH NDEC  
angular distribution for (n,n\*24)

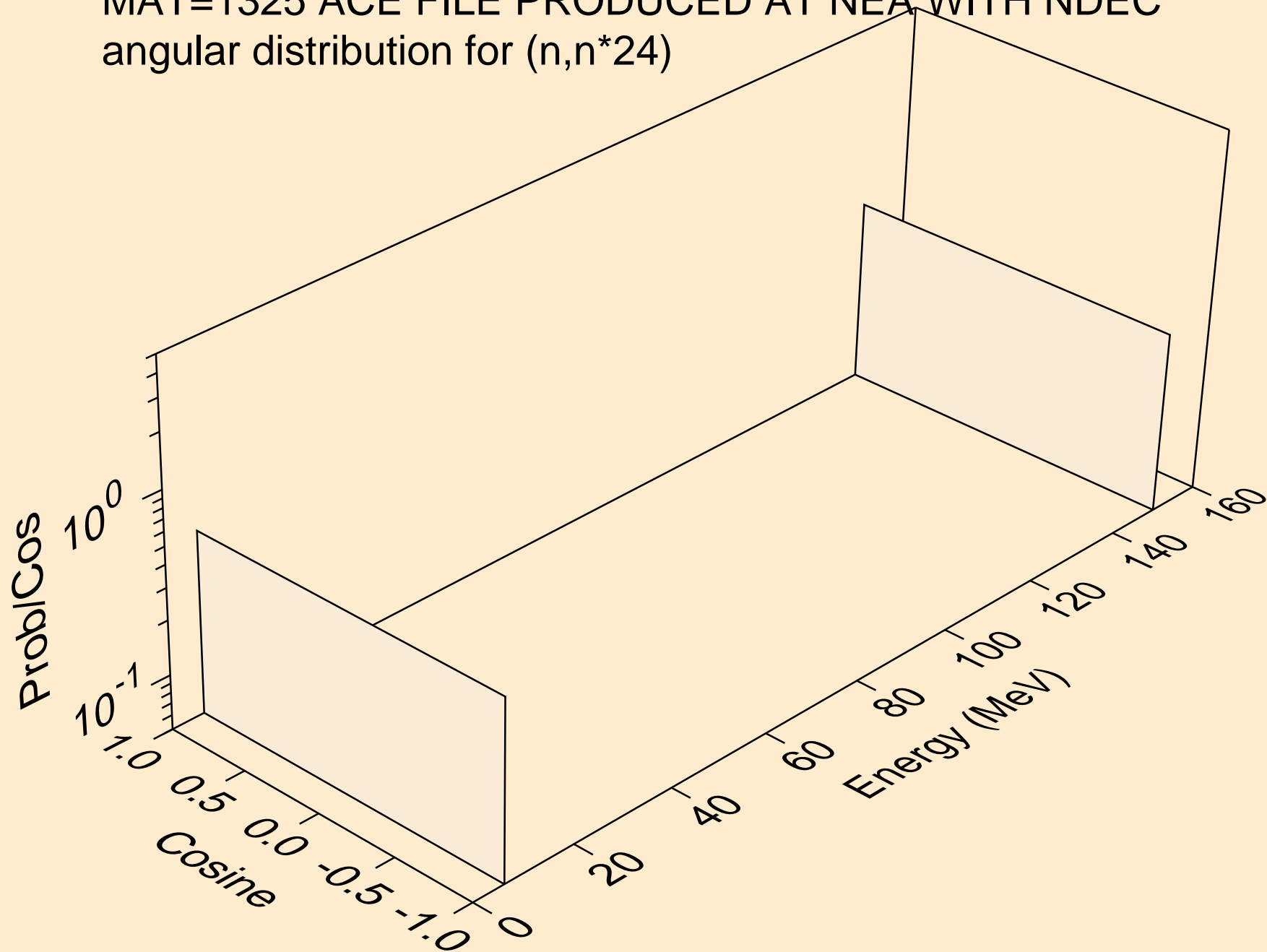

MAT=1325 ACE FILE PRODUCED AT NEA WITH NDEC  
angular distribution for (n,n\*25)

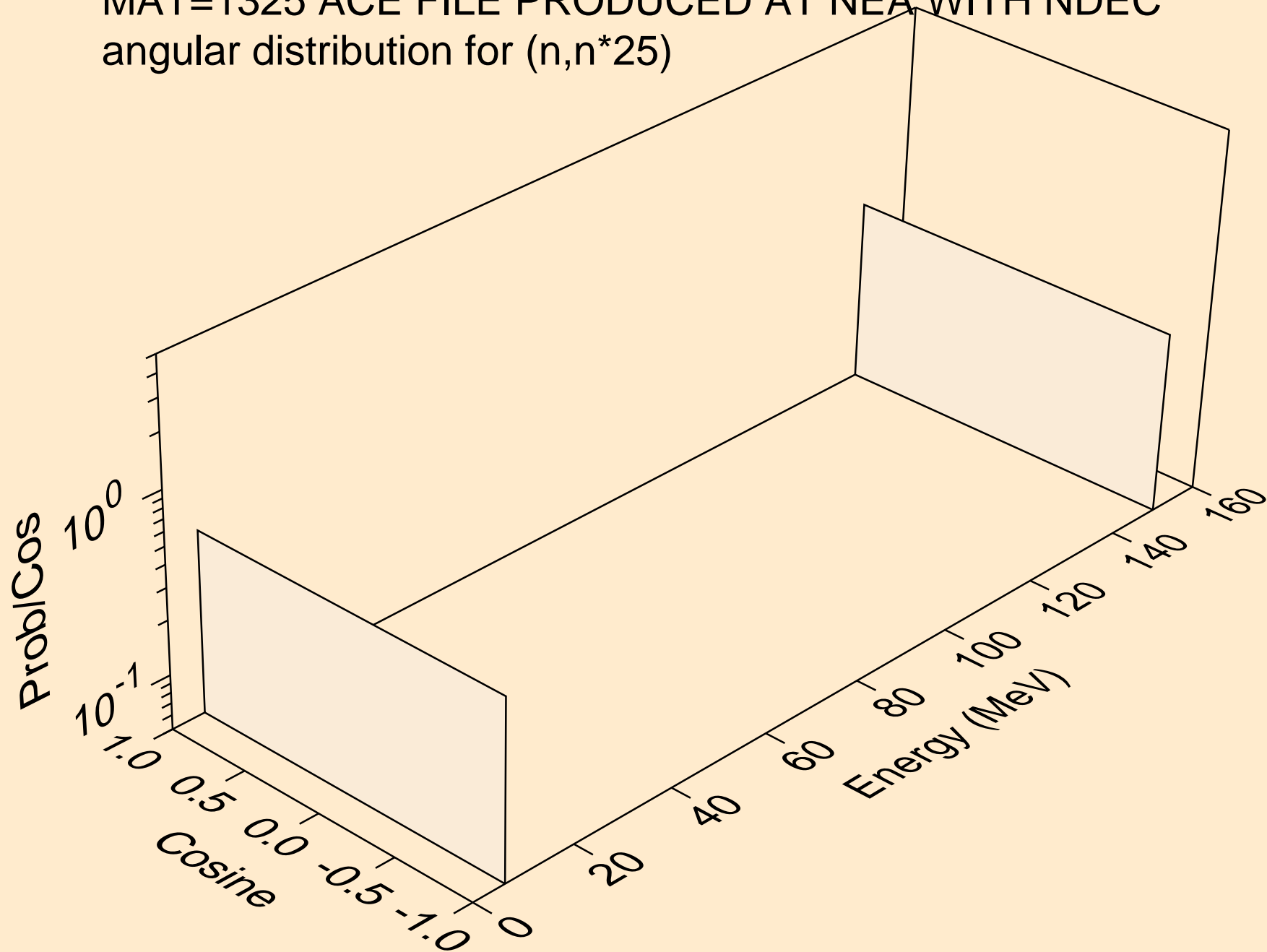

MAT=1325 ACE FILE PRODUCED AT NEA WITH NDEC  
angular distribution for (n,n\*26)

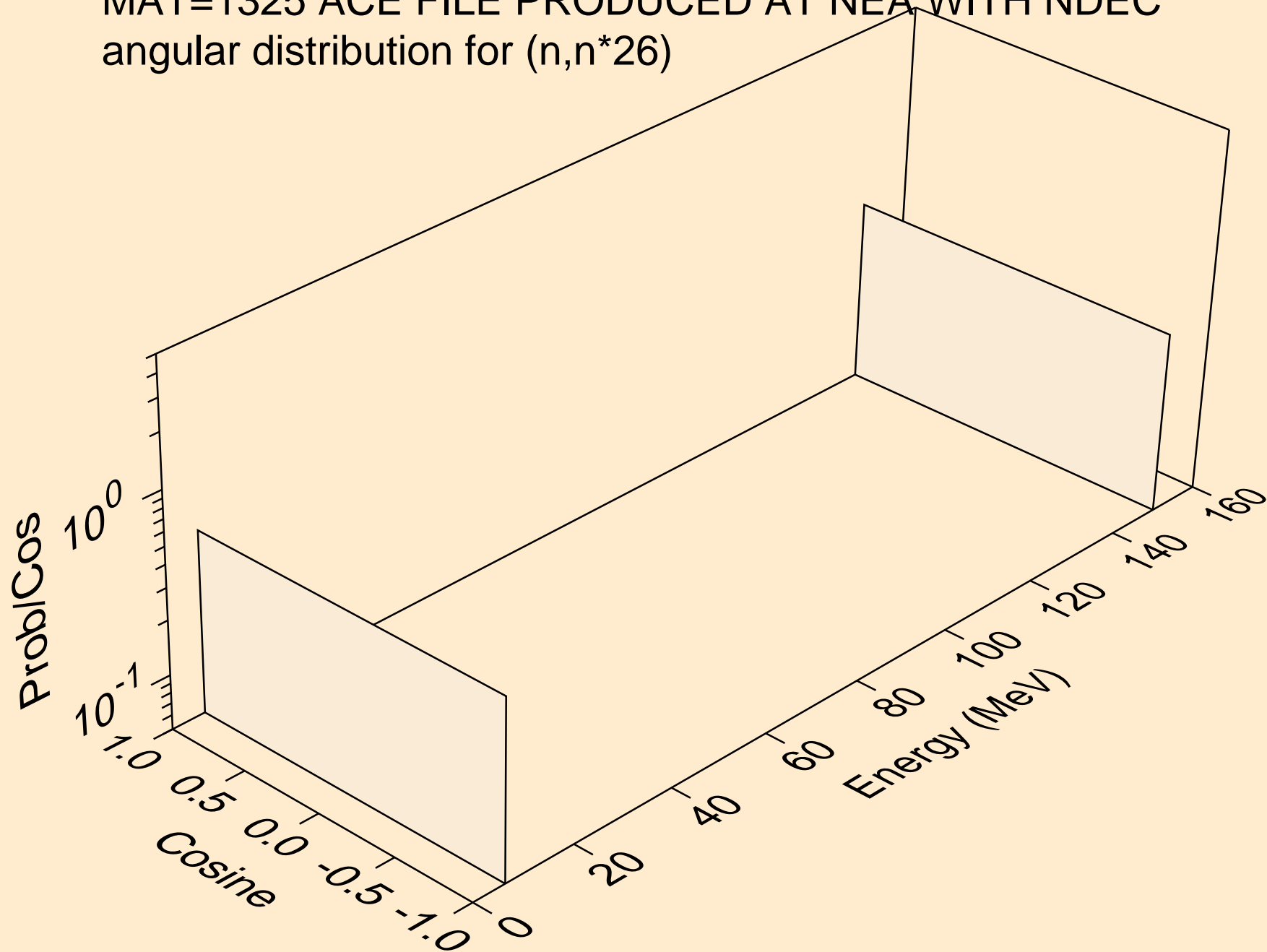



MAT=1325 ACE FILE PRODUCED AT NEA WITH NDEC  
angular distribution for (n,n\*27)

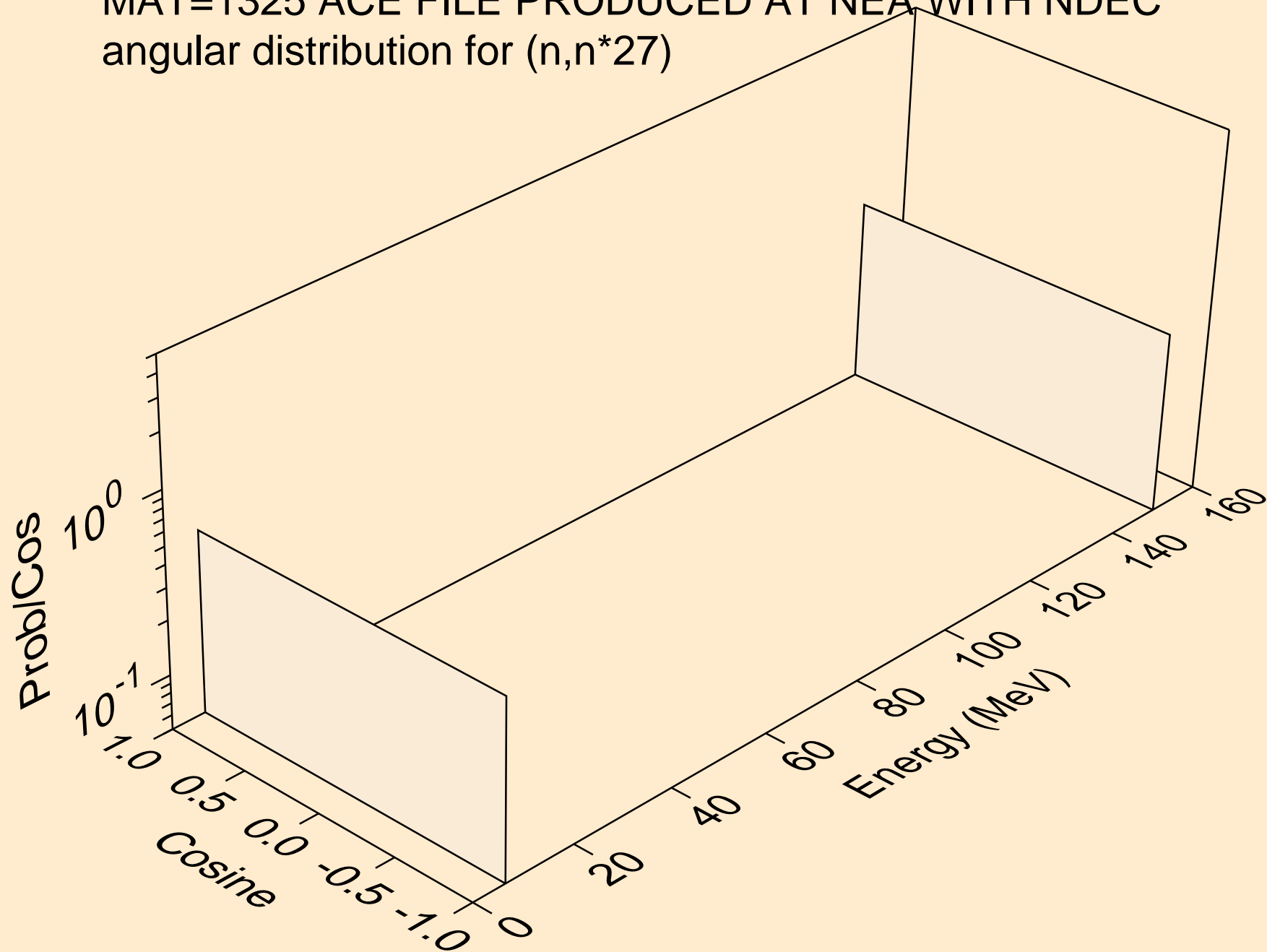

MAT=1325 ACE FILE PRODUCED AT NEA WITH NDEC  
angular distribution for (n,n\*28)

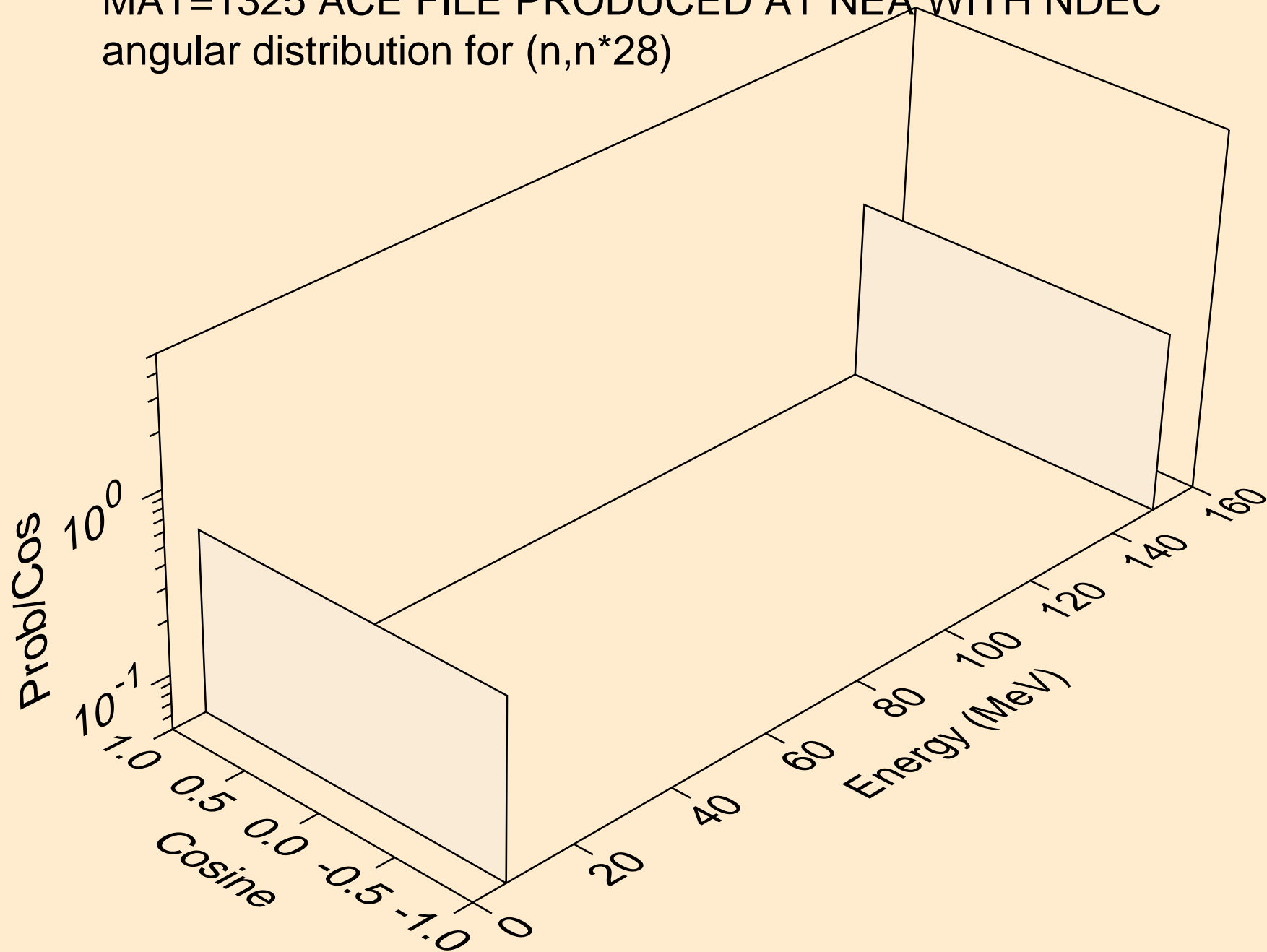

MAT=1325 ACE FILE PRODUCED AT NEA WITH NDEC  
angular distribution for (n,n\*29)

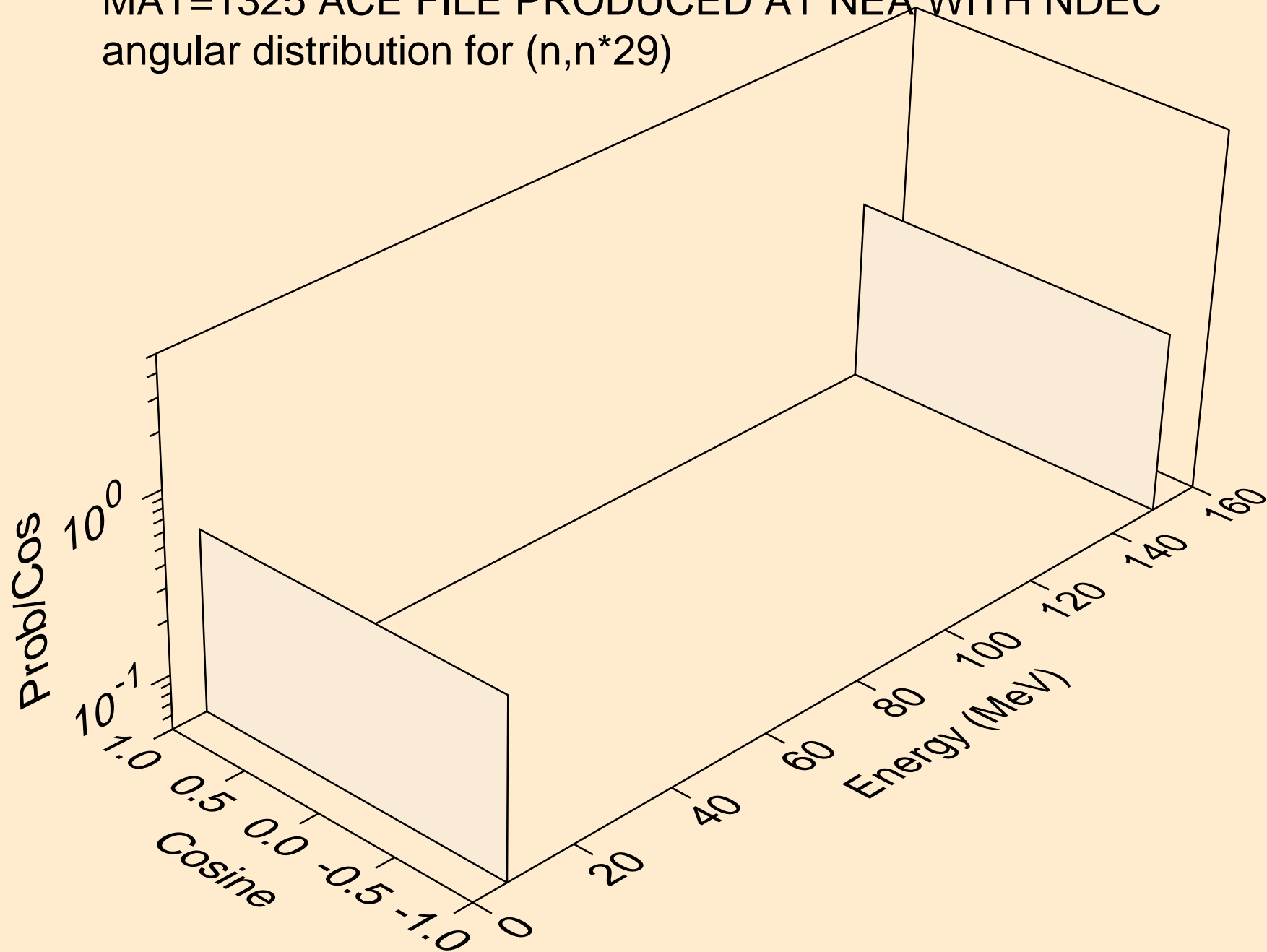

MAT=1325 ACE FILE PRODUCED AT NEA WITH NDEC  
angular distribution for (n,n\*30)

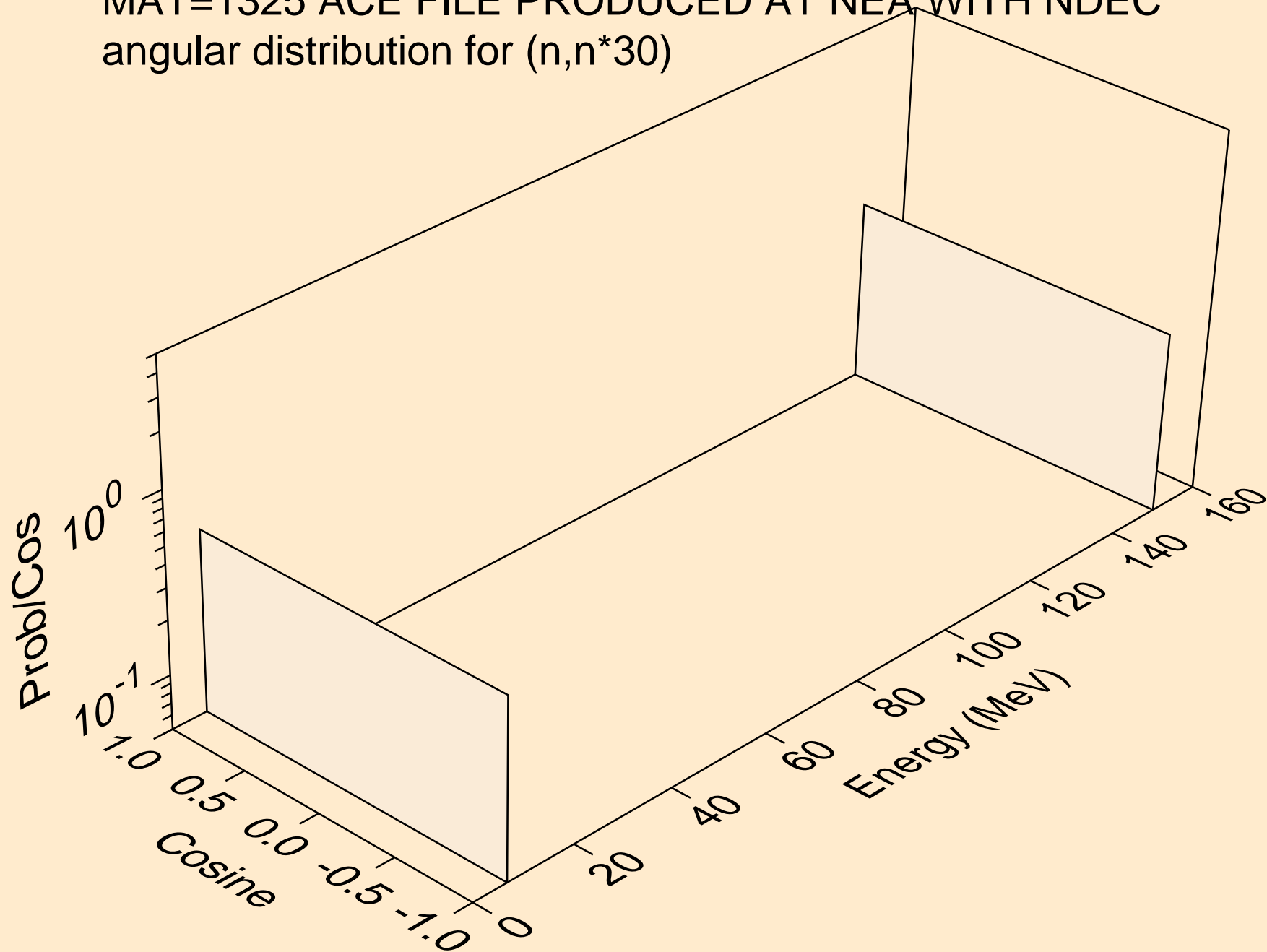

MAT=1325 ACE FILE PRODUCED AT NEA WITH NDEC  
angular distribution for (n,n\*31)

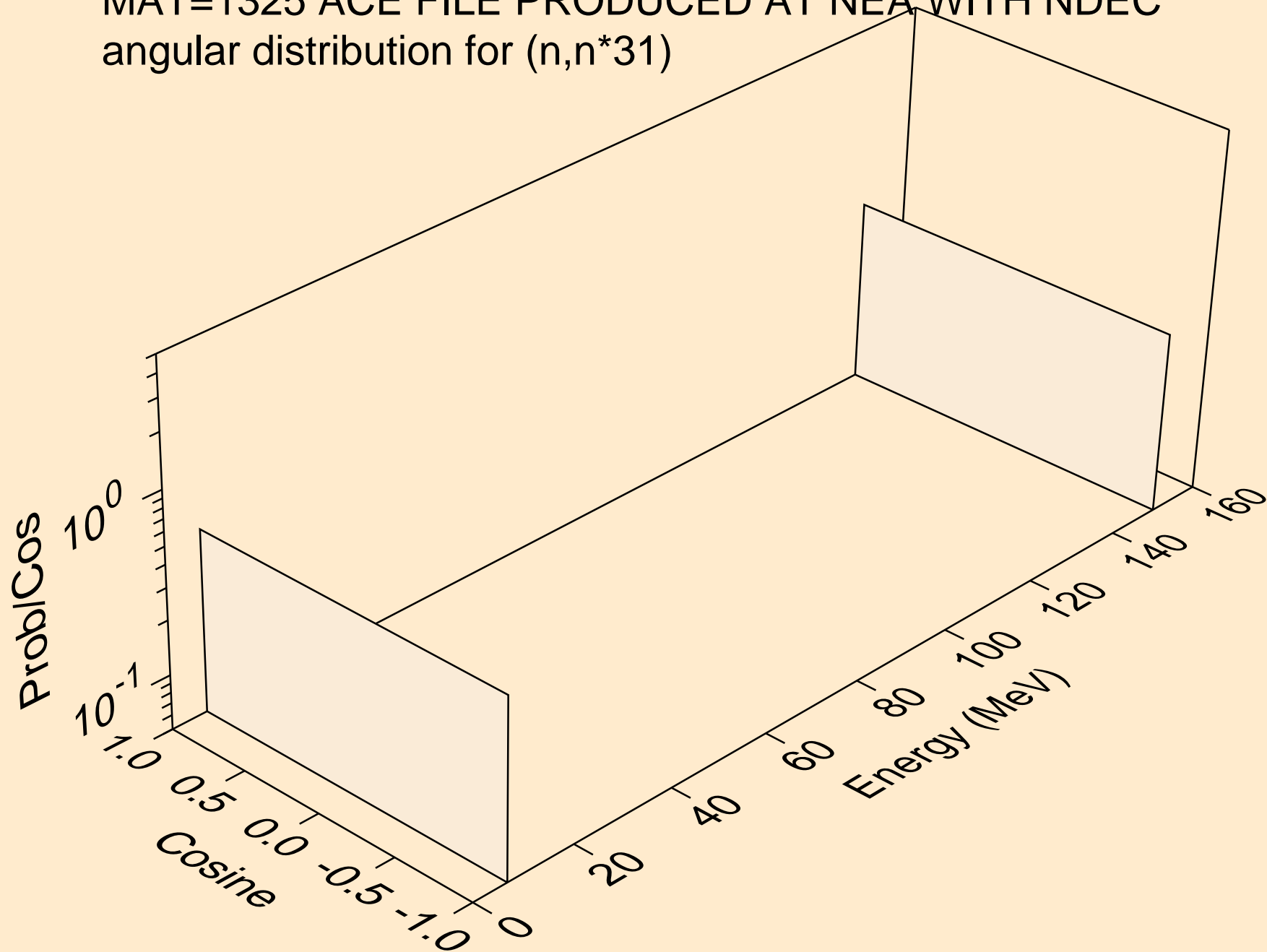

MAT=1325 ACE FILE PRODUCED AT NEA WITH NDEC  
angular distribution for (n,n\*32)

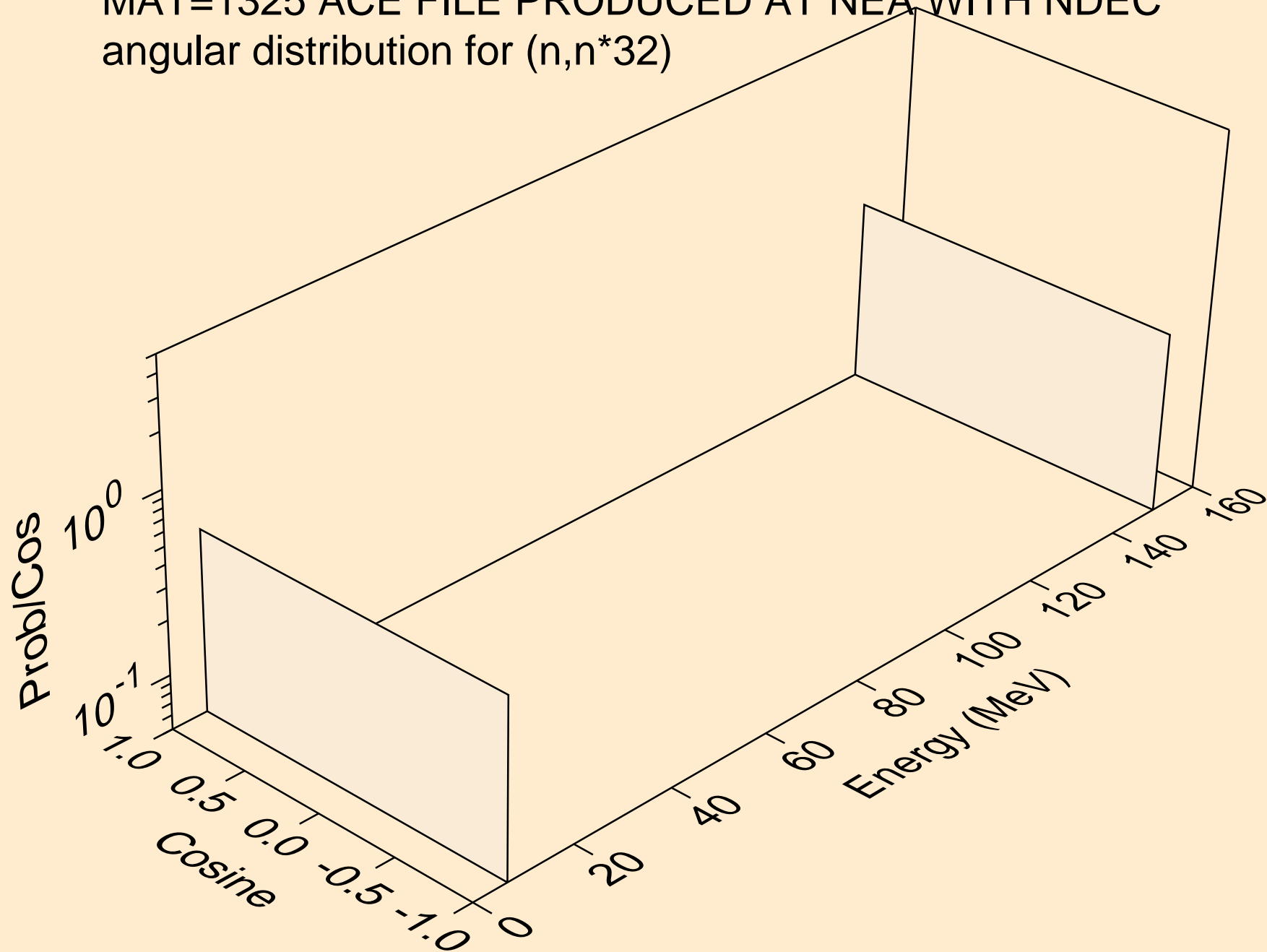

MAT=1325 ACE FILE PRODUCED AT NEA WITH NDEC  
angular distribution for (n,n\*33)

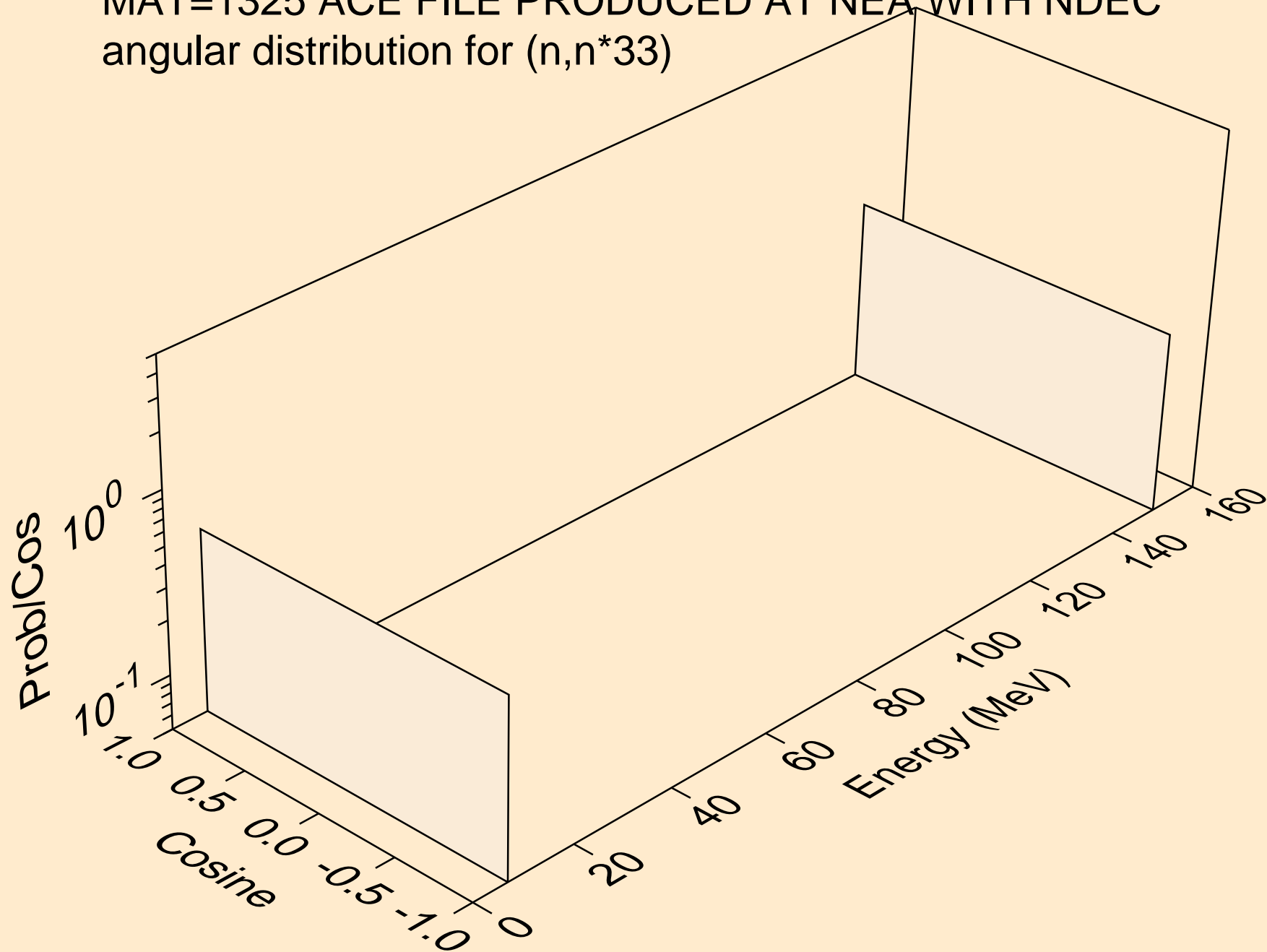

MAT=1325 ACE FILE PRODUCED AT NEA WITH NDEC  
angular distribution for (n,n\*34)

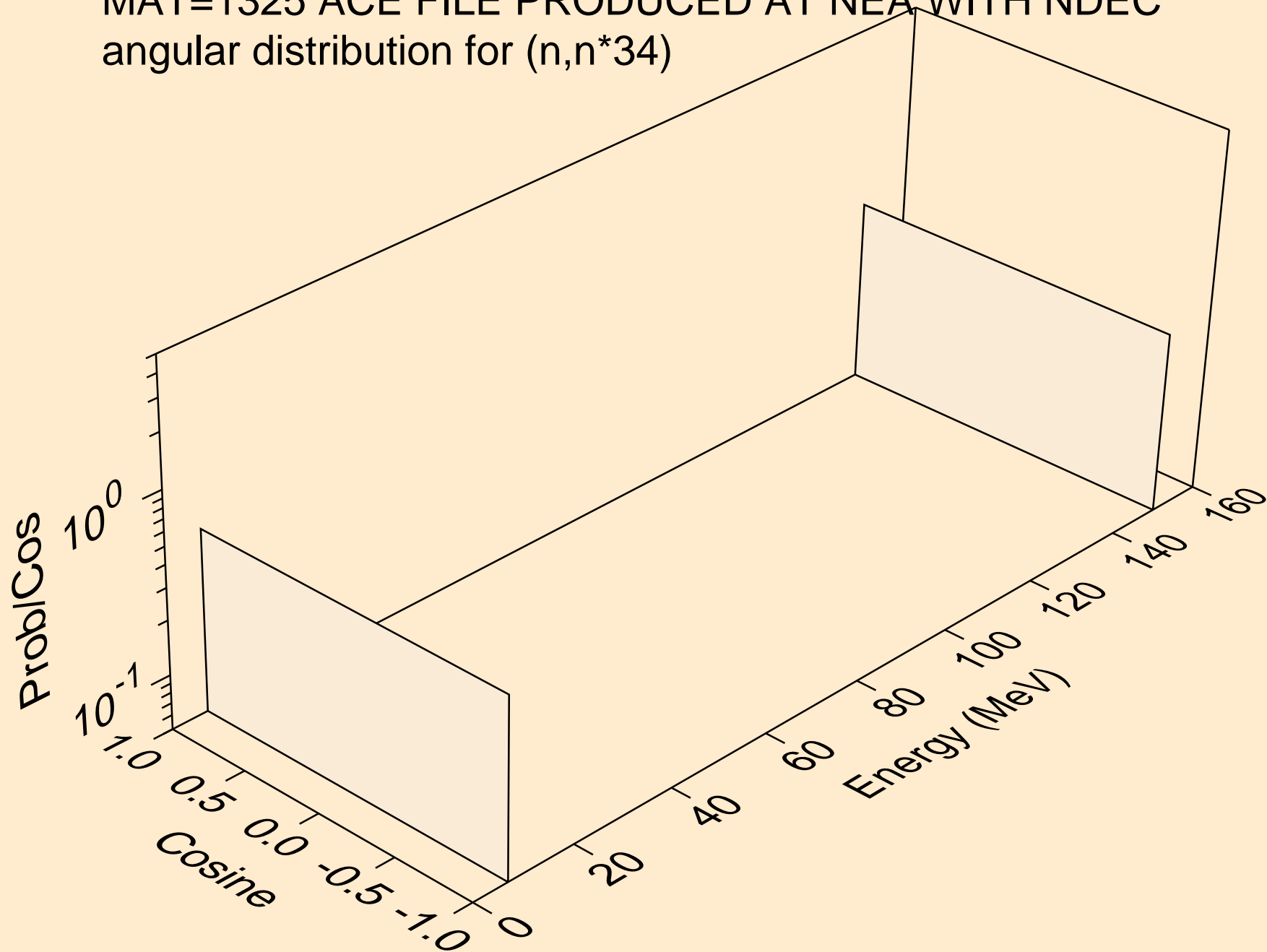



MAT=1325 ACE FILE PRODUCED AT NEA WITH NDEC  
angular distribution for (n,n\*35)

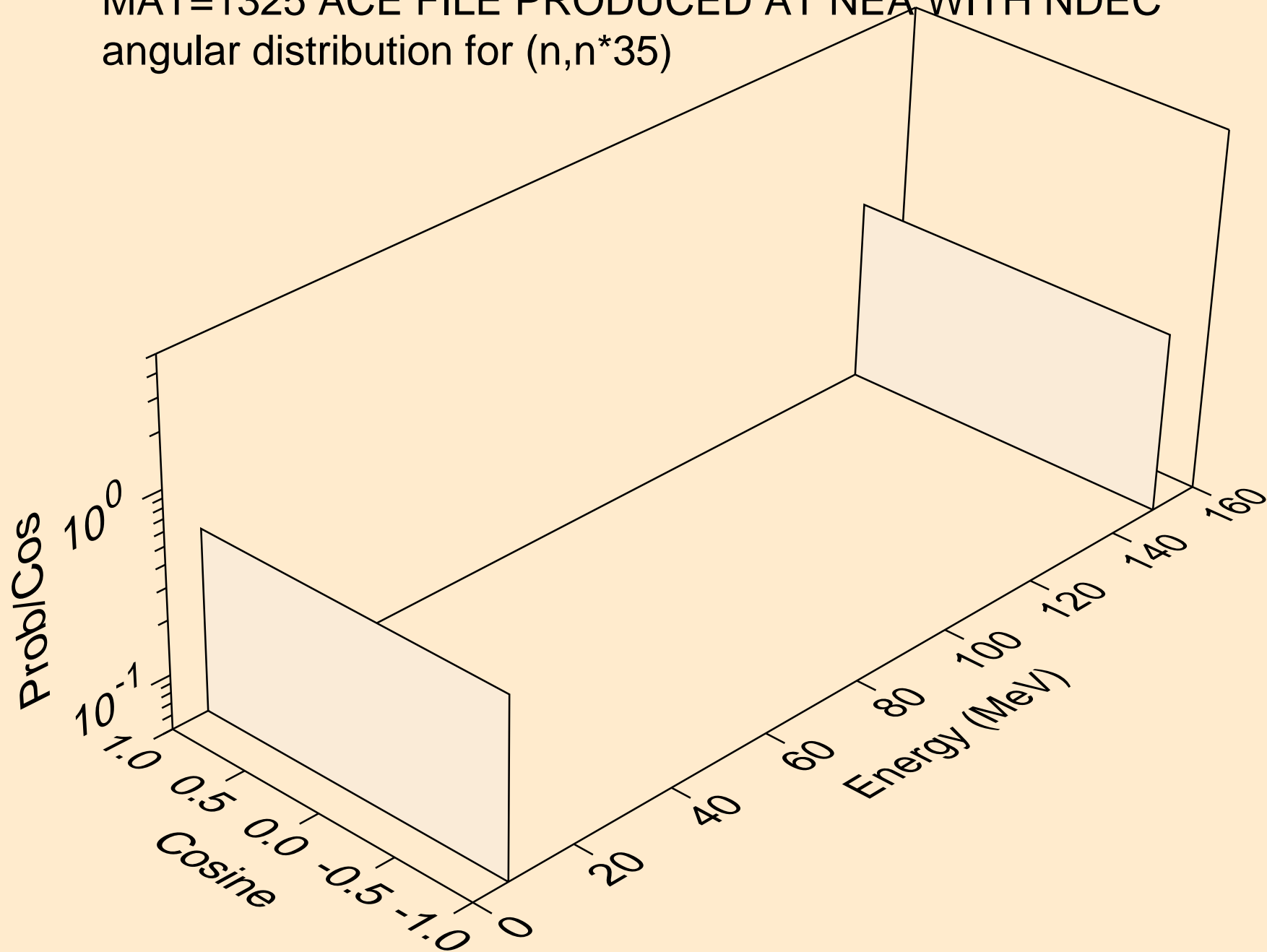

MAT=1325 ACE FILE PRODUCED AT NEA WITH NDEC  
angular distribution for (n,n\*36)

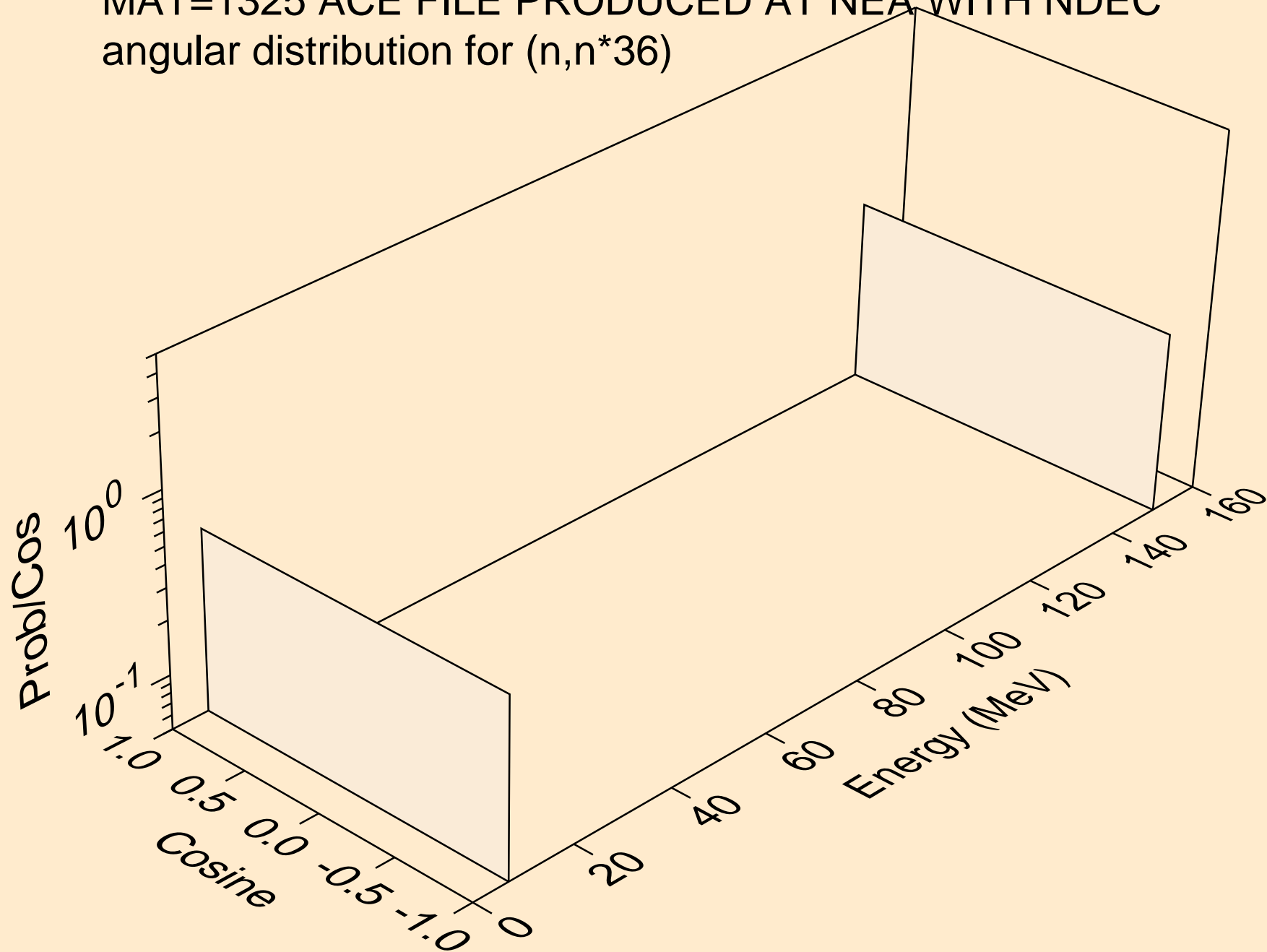

MAT=1325 ACE FILE PRODUCED AT NEA WITH NDEC  
angular distribution for (n,n\*37)

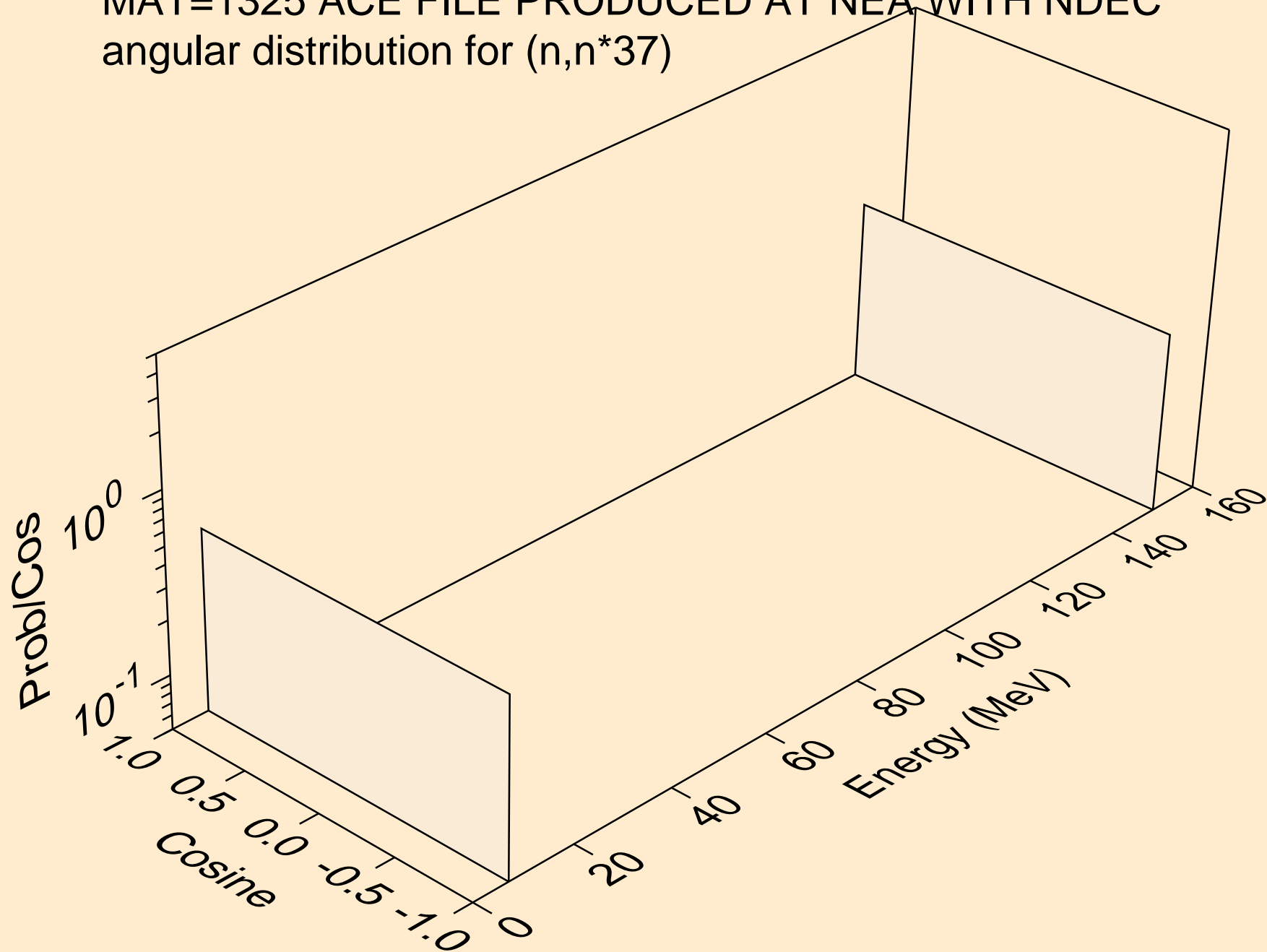

MAT=1325 ACE FILE PRODUCED AT NEA WITH NDEC  
angular distribution for (n,n\*38)

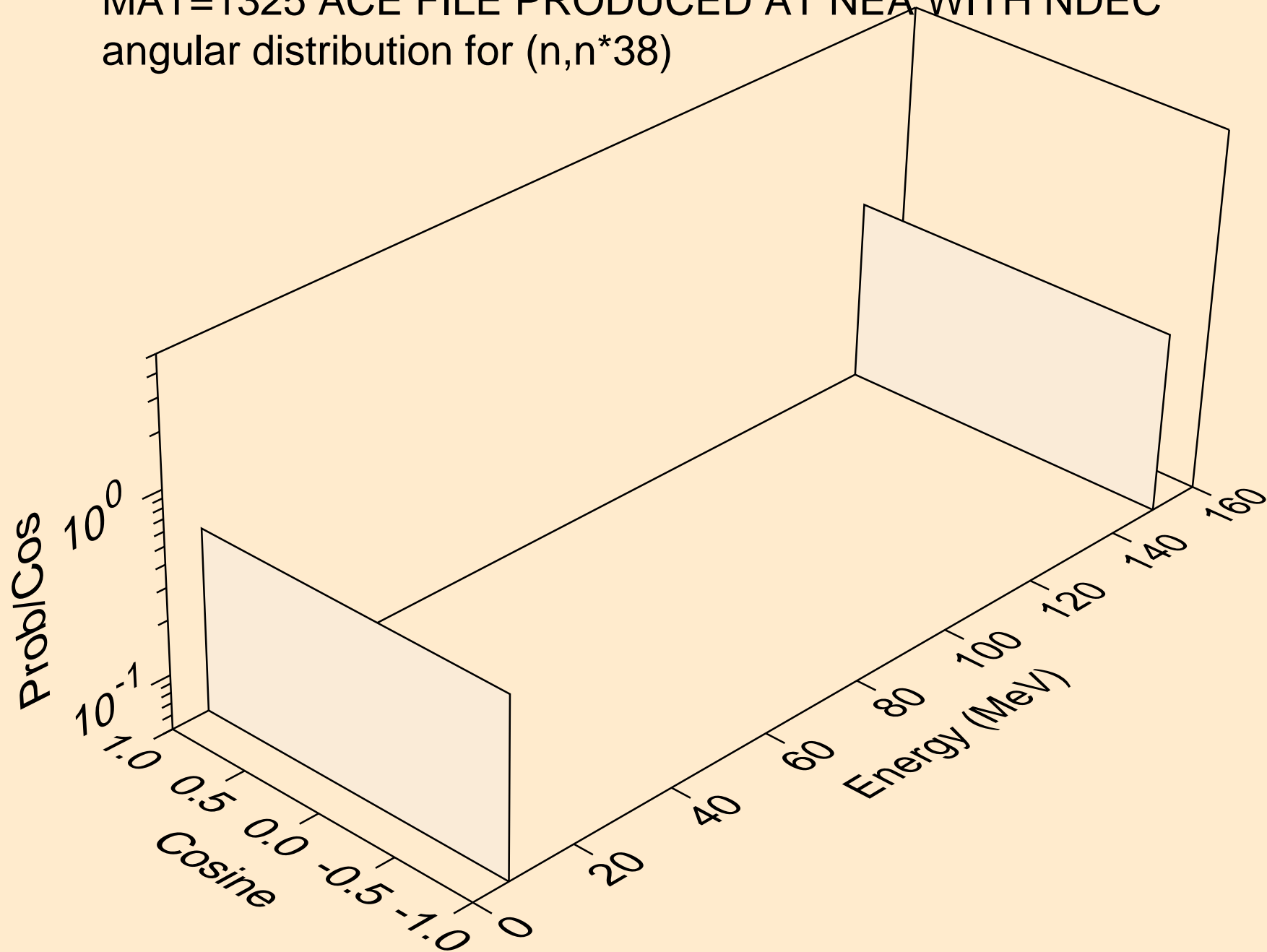

MAT=1325 ACE FILE PRODUCED AT NEA WITH NDEC  
angular distribution for (n,n\*39)

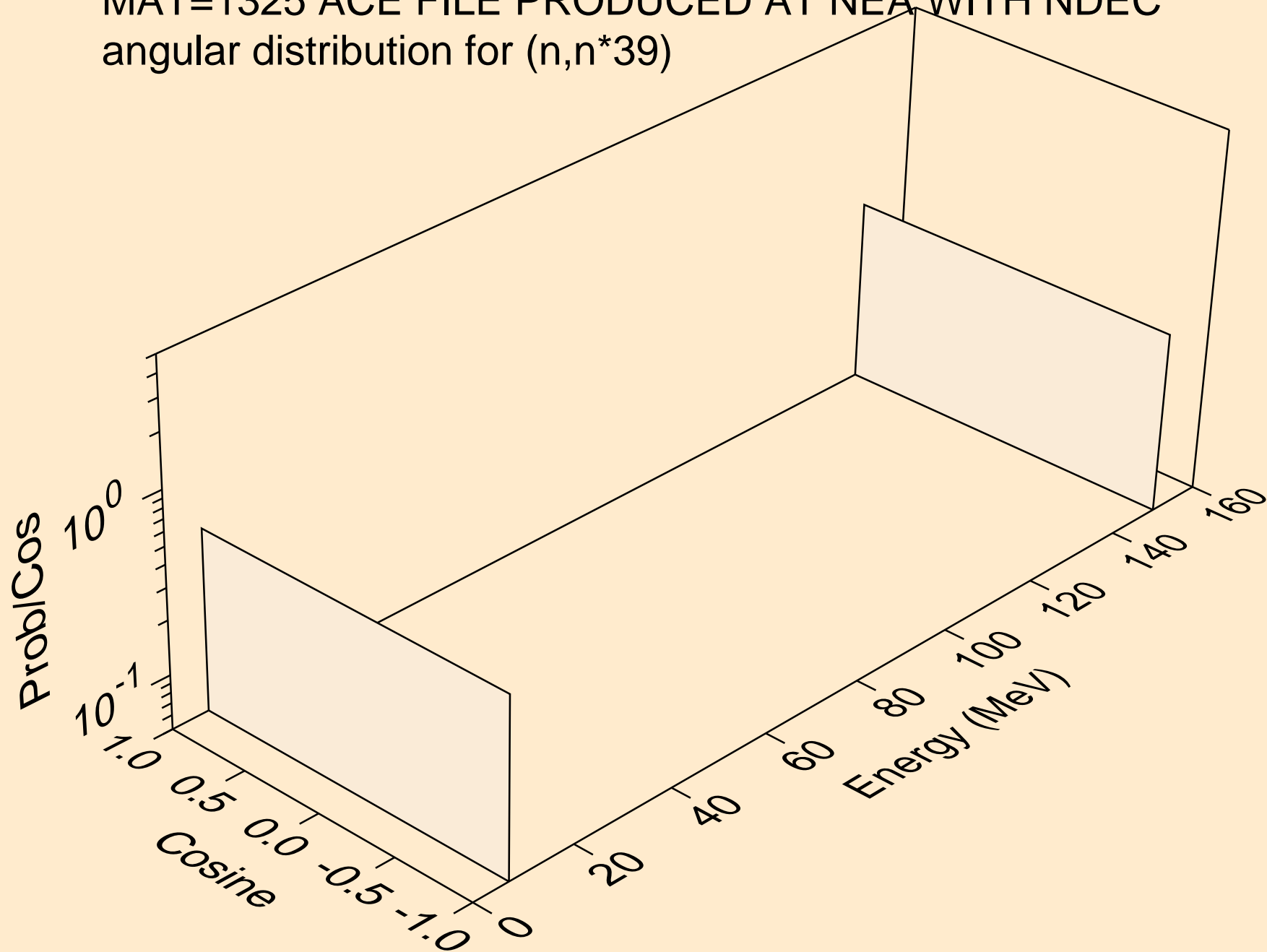

MAT=1325 ACE FILE PRODUCED AT NEA WITH NDEC  
Neutron emission for (n,x)

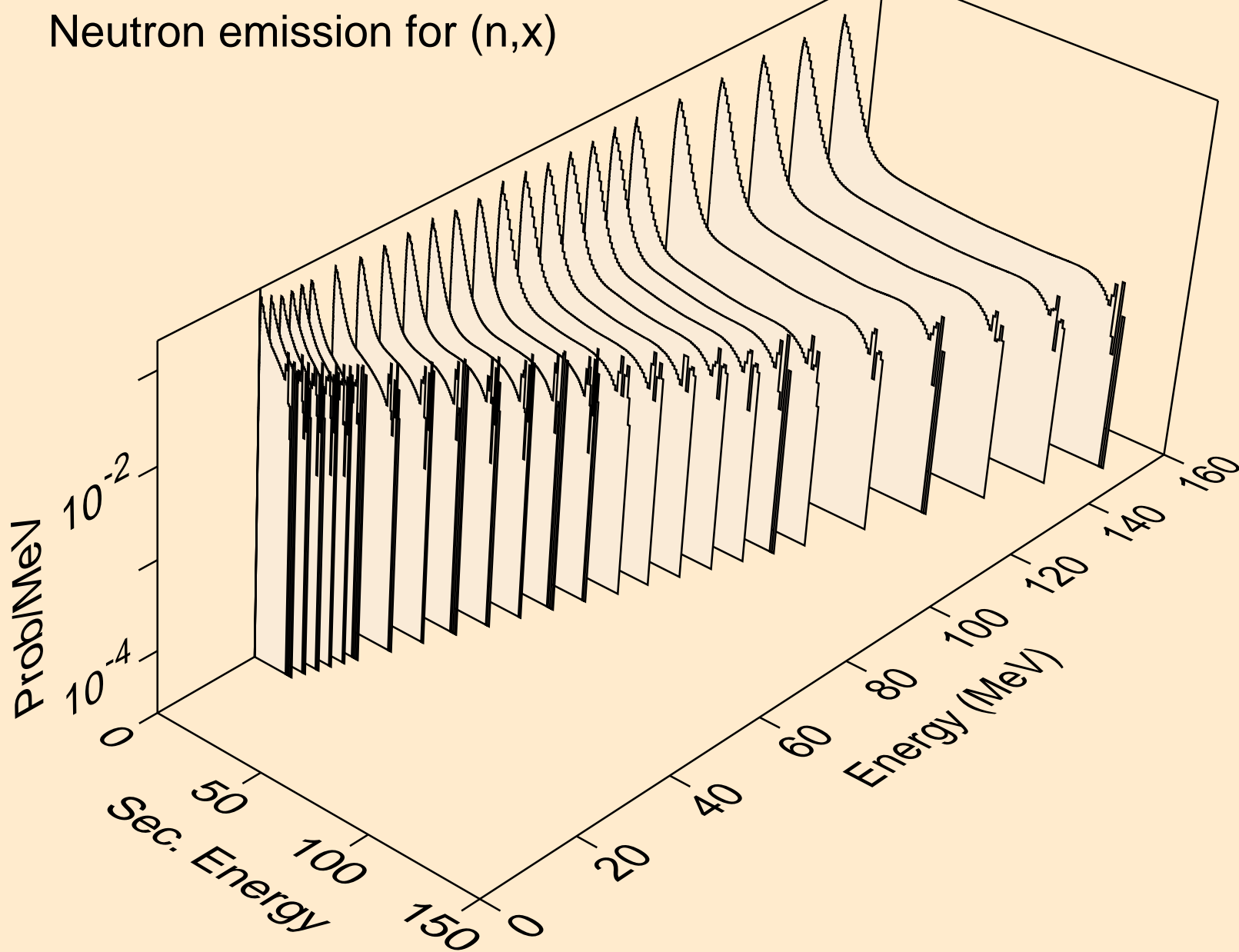

MAT=1325 ACE FILE PRODUCED AT NEA WITH NDEC  
Neutron emission for (n,2n)

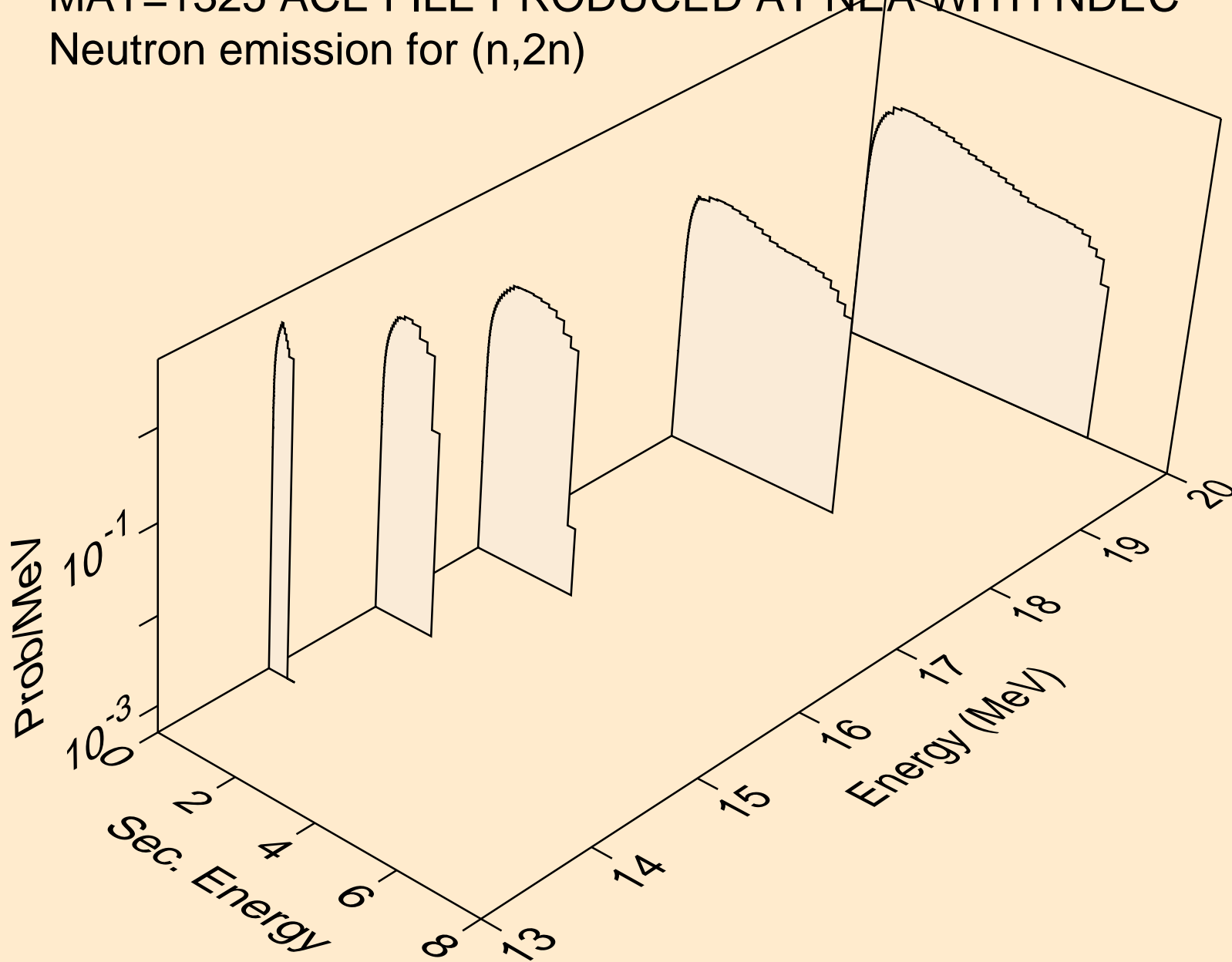

MAT=1325 ACE FILE PRODUCED AT NEA WITH NDEC  
Neutron emission for (n,n\*)a

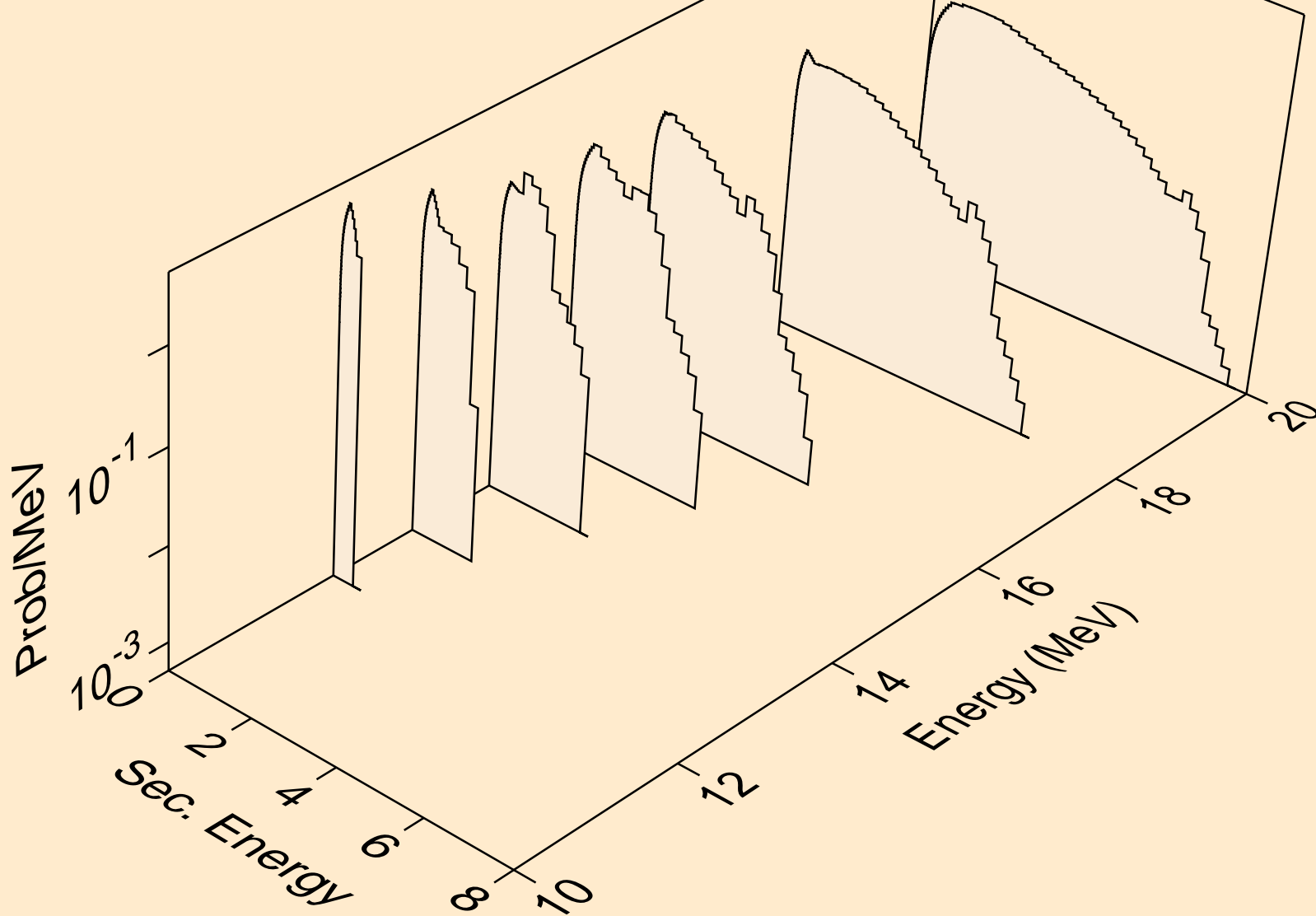



MAT=1325 ACE FILE PRODUCED AT NEA WITH NDEC  
Neutron emission for (n,n\*)p

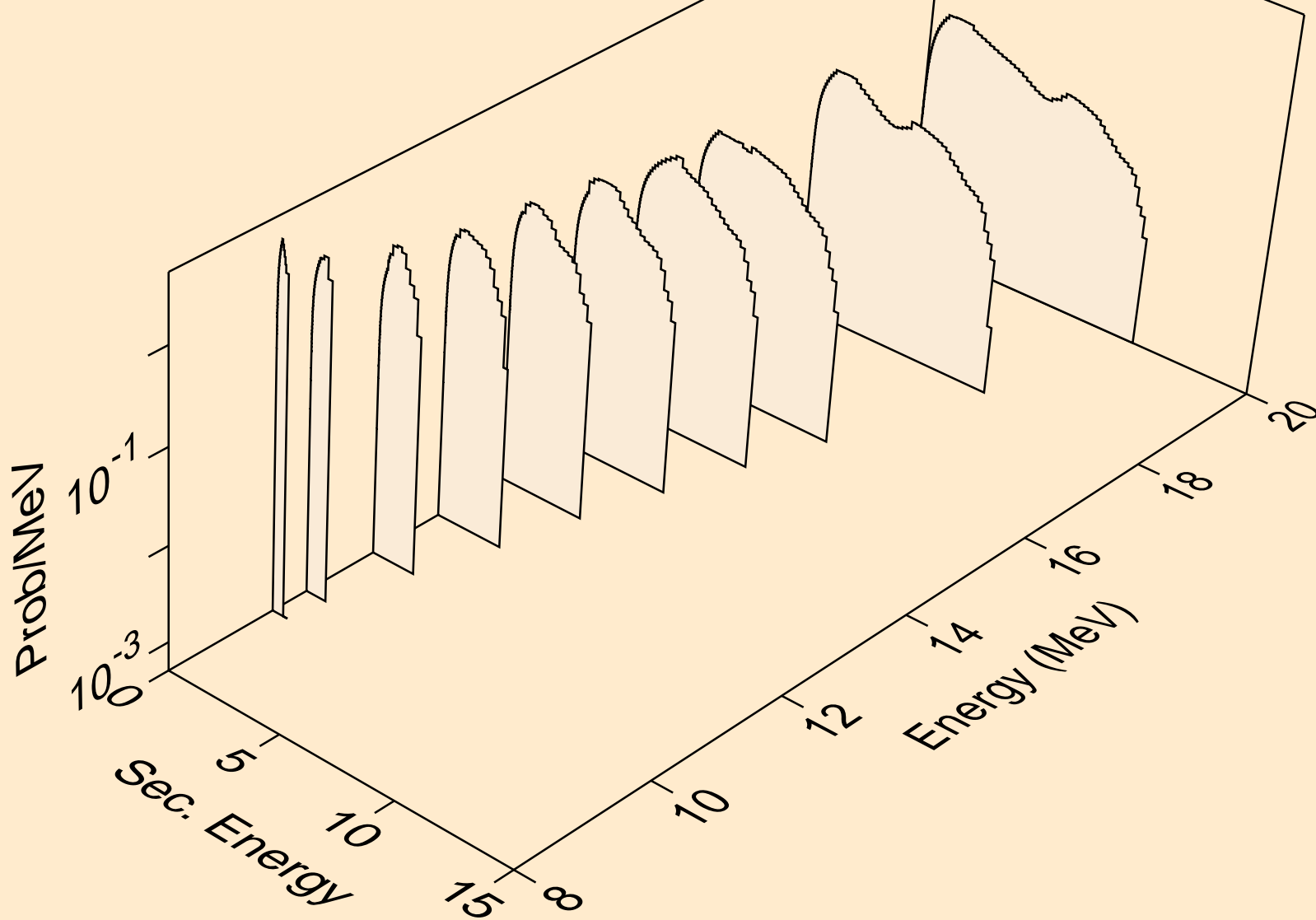

MAT=1325 ACE FILE PRODUCED AT NEA WITH NDEC  
Neutron emission for (n,n\*)d

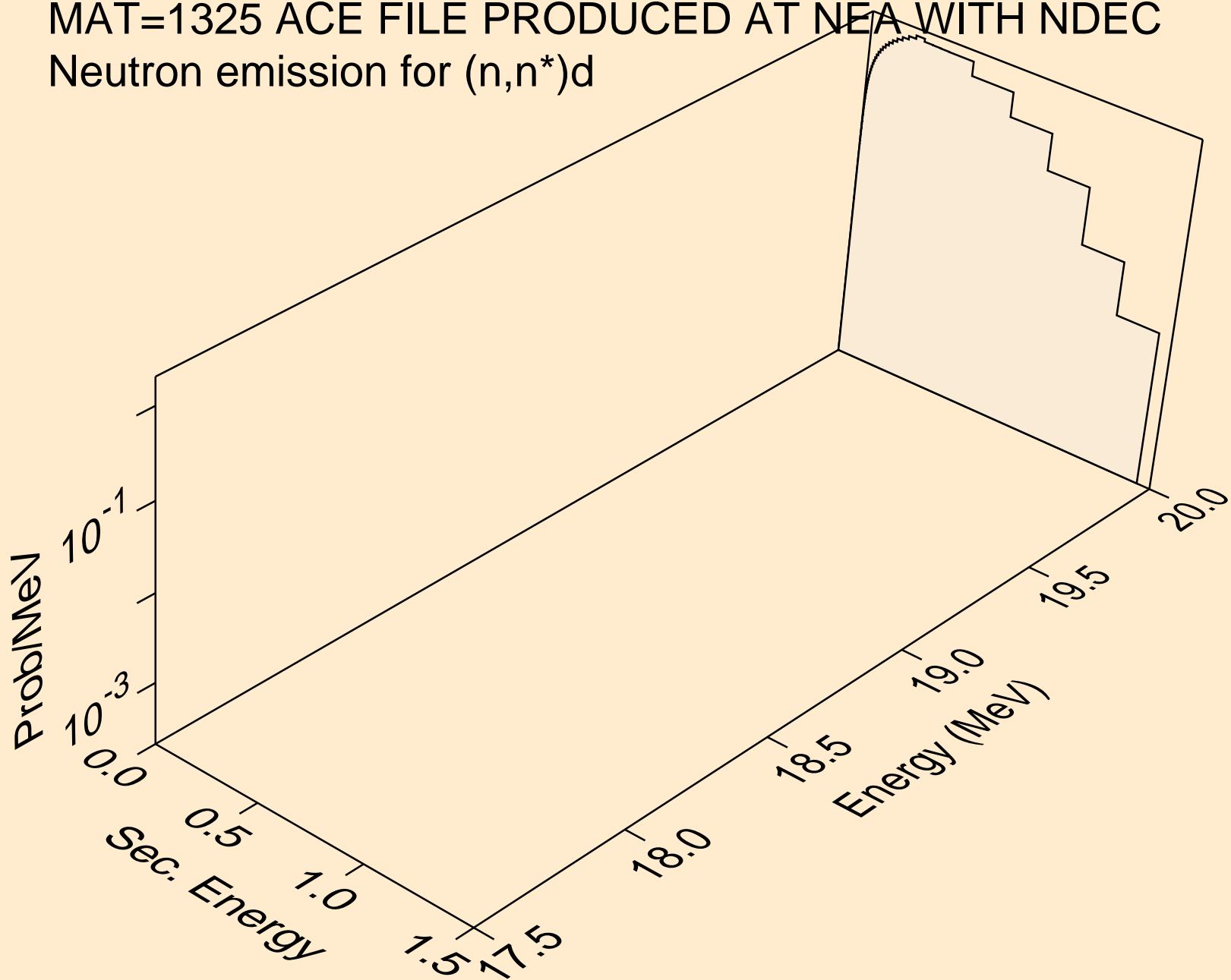

MAT=1325 ACE FILE PRODUCED AT NEA WITH NDEC  
Neutron emission for (n,n\*)t

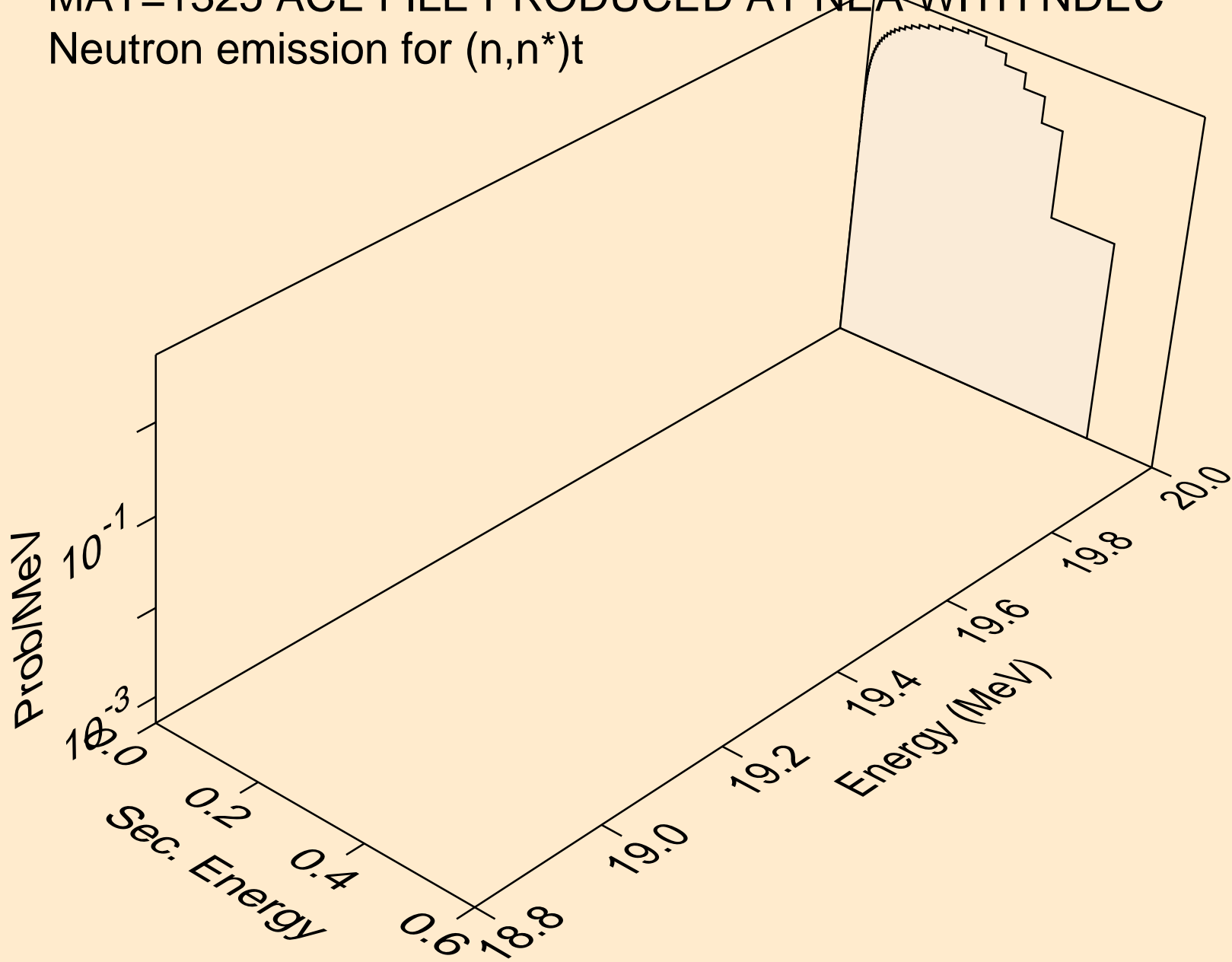

MAT=1325 ACE FILE PRODUCED AT NEA WITH NDEC  
Neutron emission for (n,n\*c)

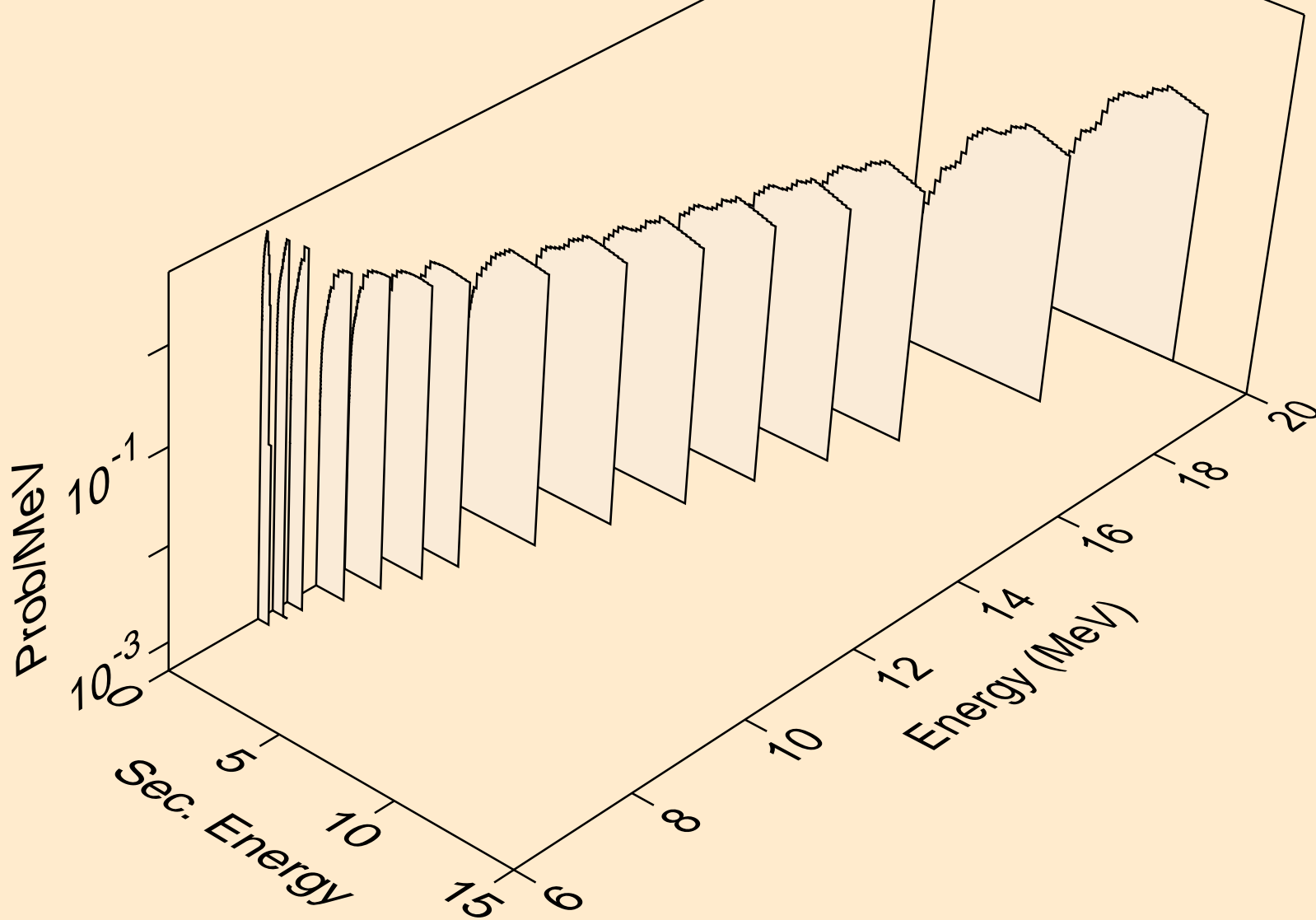

MAT=1325 ACE FILE PRODUCED AT NEA WITH NDEC  
Photon emission for (n,gma)

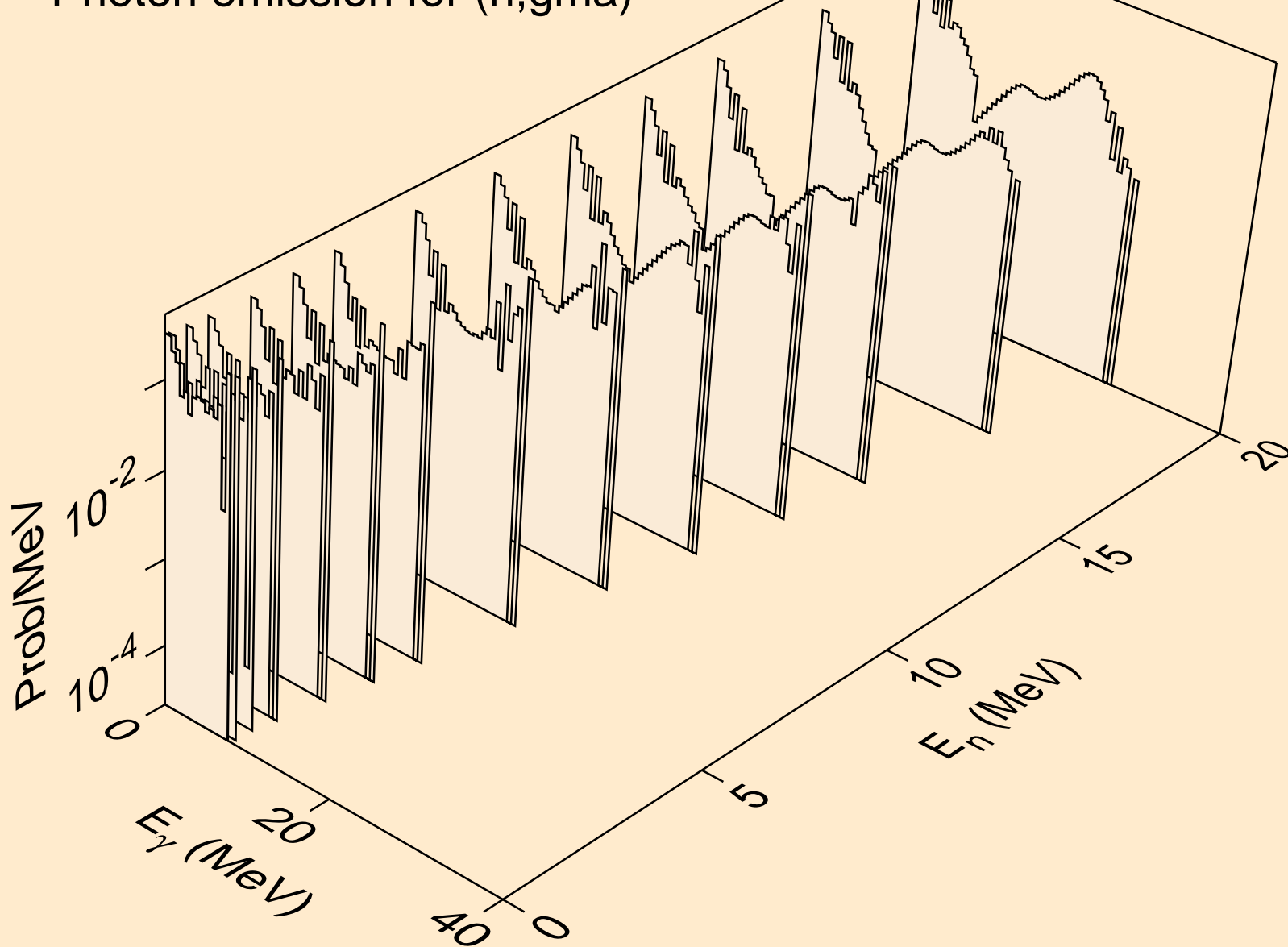

MAT=1325 ACE FILE PRODUCED AT NEA WITH NDEC  
Photon emission for (n,x)

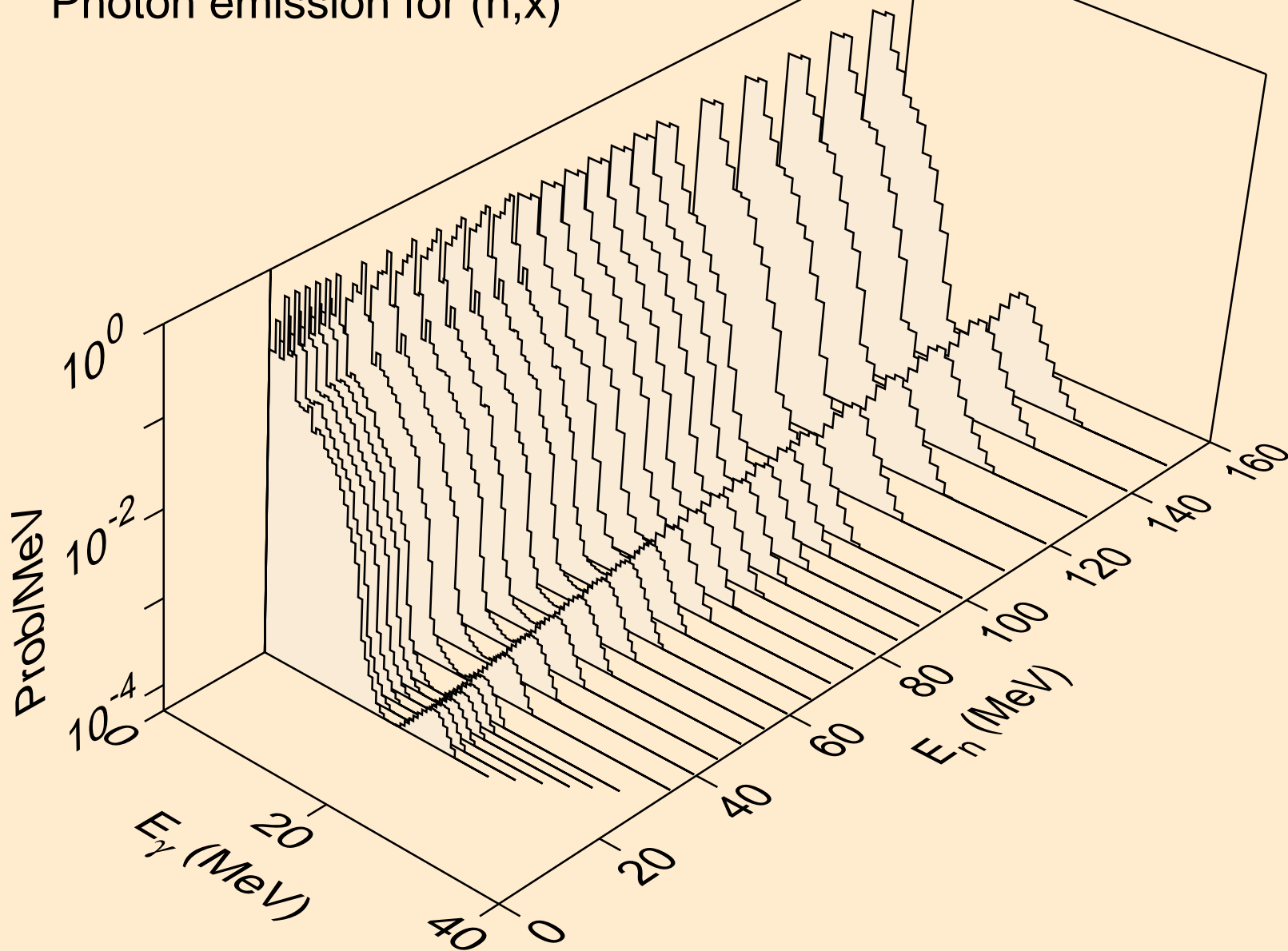

MAT=1325 ACE FILE PRODUCED AT NEA WITH NDEC  
Photon emission for (n,2n)

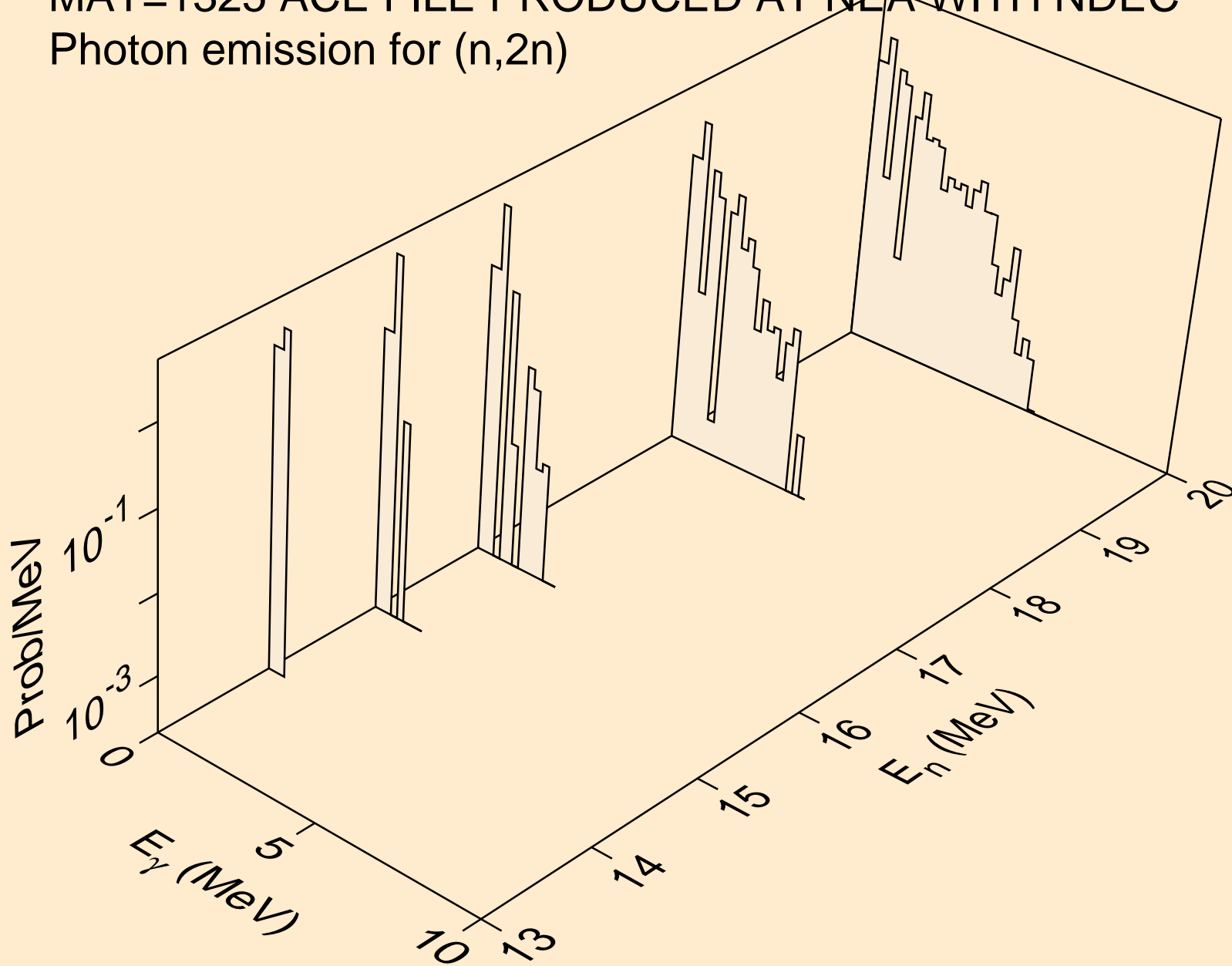

MAT=1325 ACE FILE PRODUCED AT NEA WITH NDEC  
Photon emission for (n,n\*)a

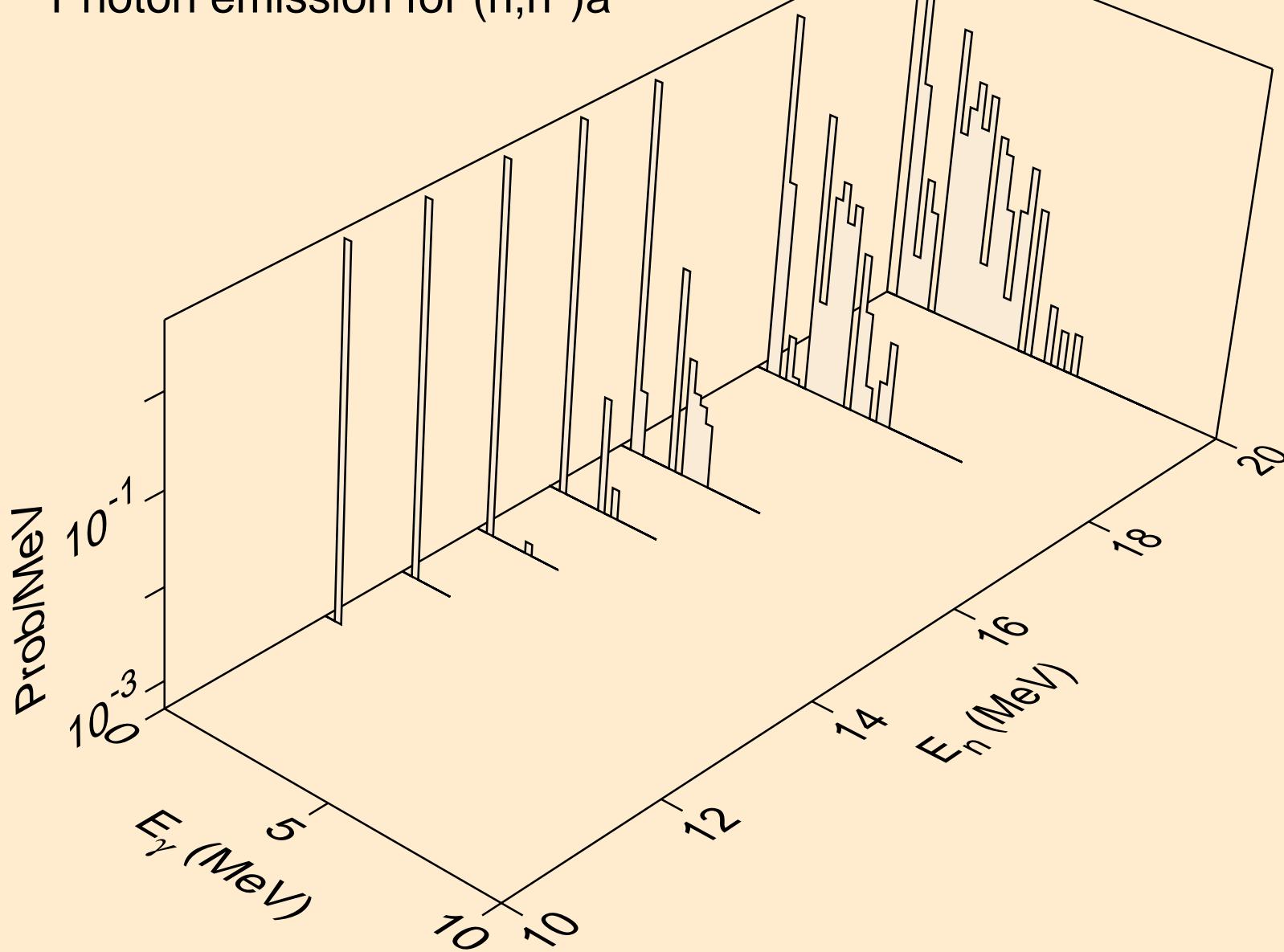



MAT=1325 ACE FILE PRODUCED AT NEA WITH NDEC  
Photon emission for (n,n\*)p

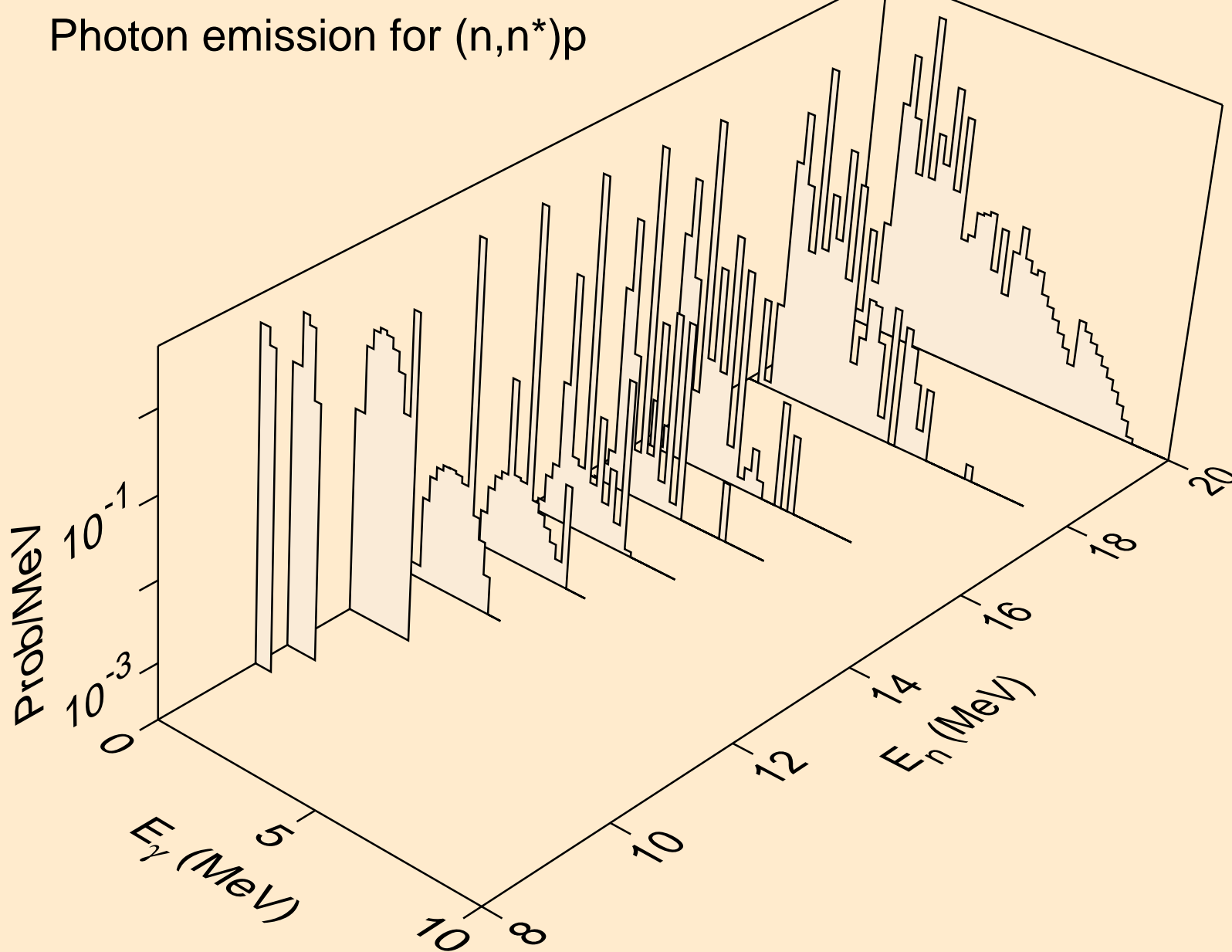

MAT=1325 ACE FILE PRODUCED AT NEA WITH NDEC  
Photon emission for (n,n\*)d

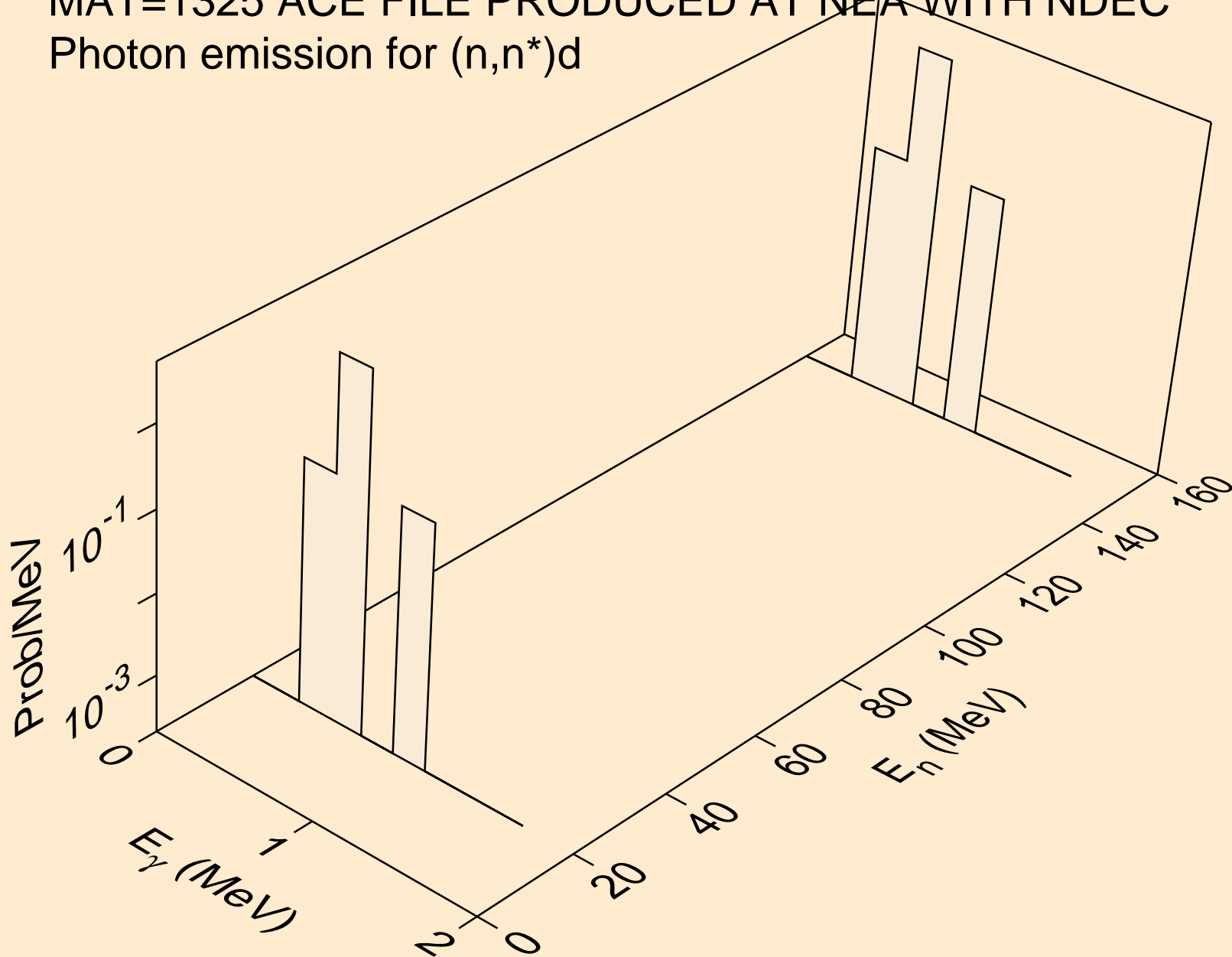

MAT=1325 ACE FILE PRODUCED AT NEA WITH NDEC  
Photon emission for (n,n\*)t

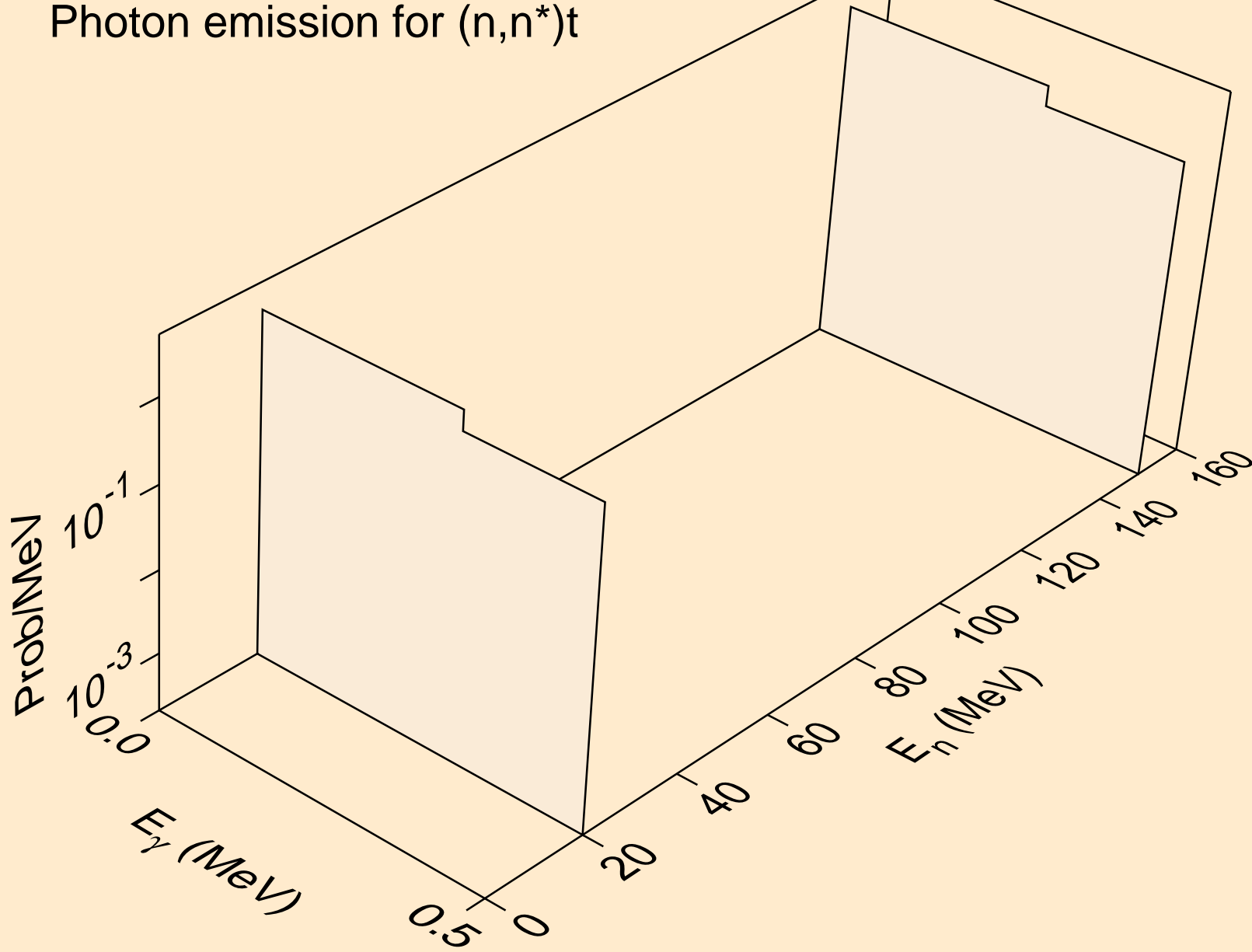

MAT=1325 ACE FILE PRODUCED AT NEA WITH NDEC  
Photon emission for (n,n\*c)

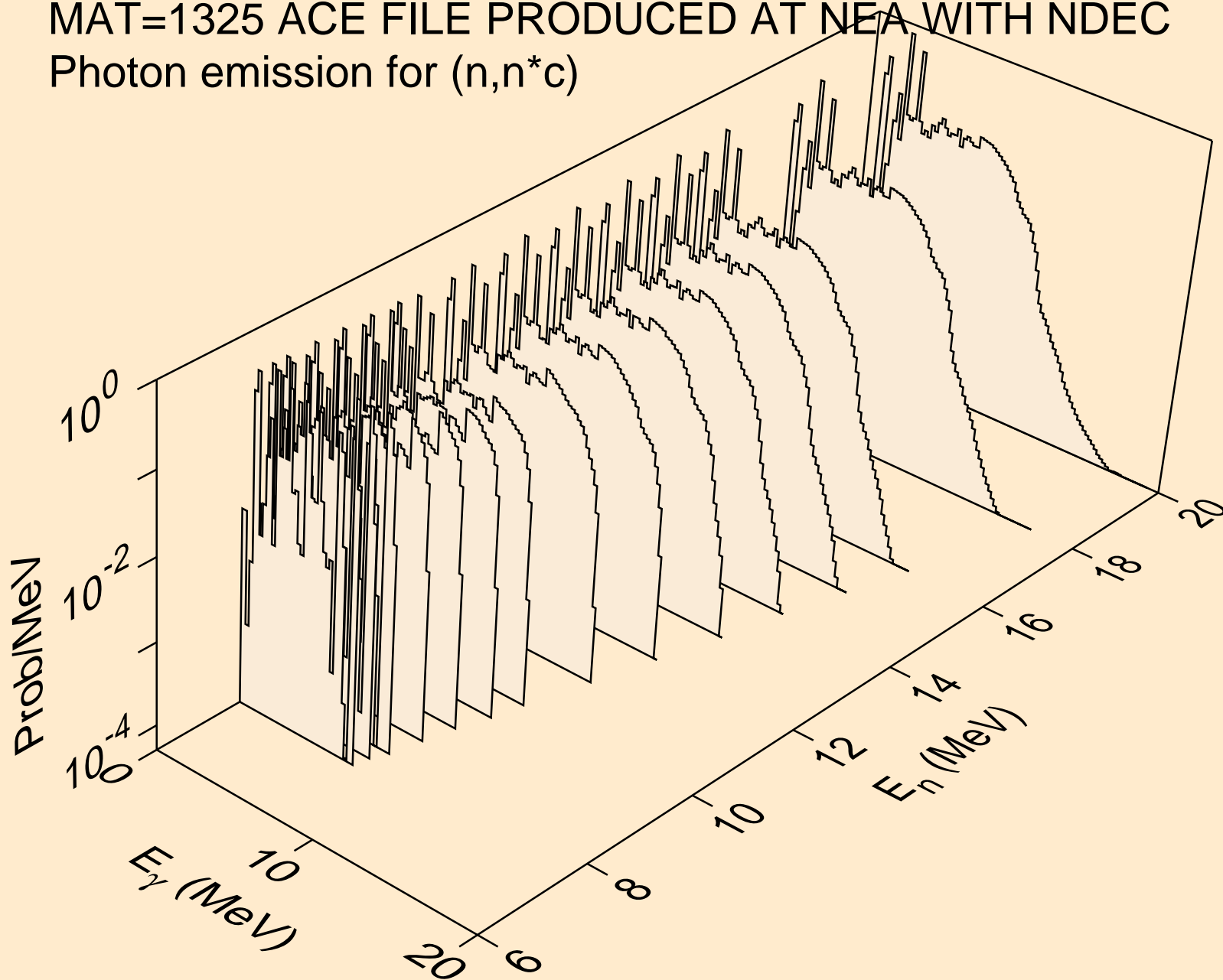

MAT=1325 ACE FILE PRODUCED AT NEA WITH NDEC  
Photon emission for (n,2a)

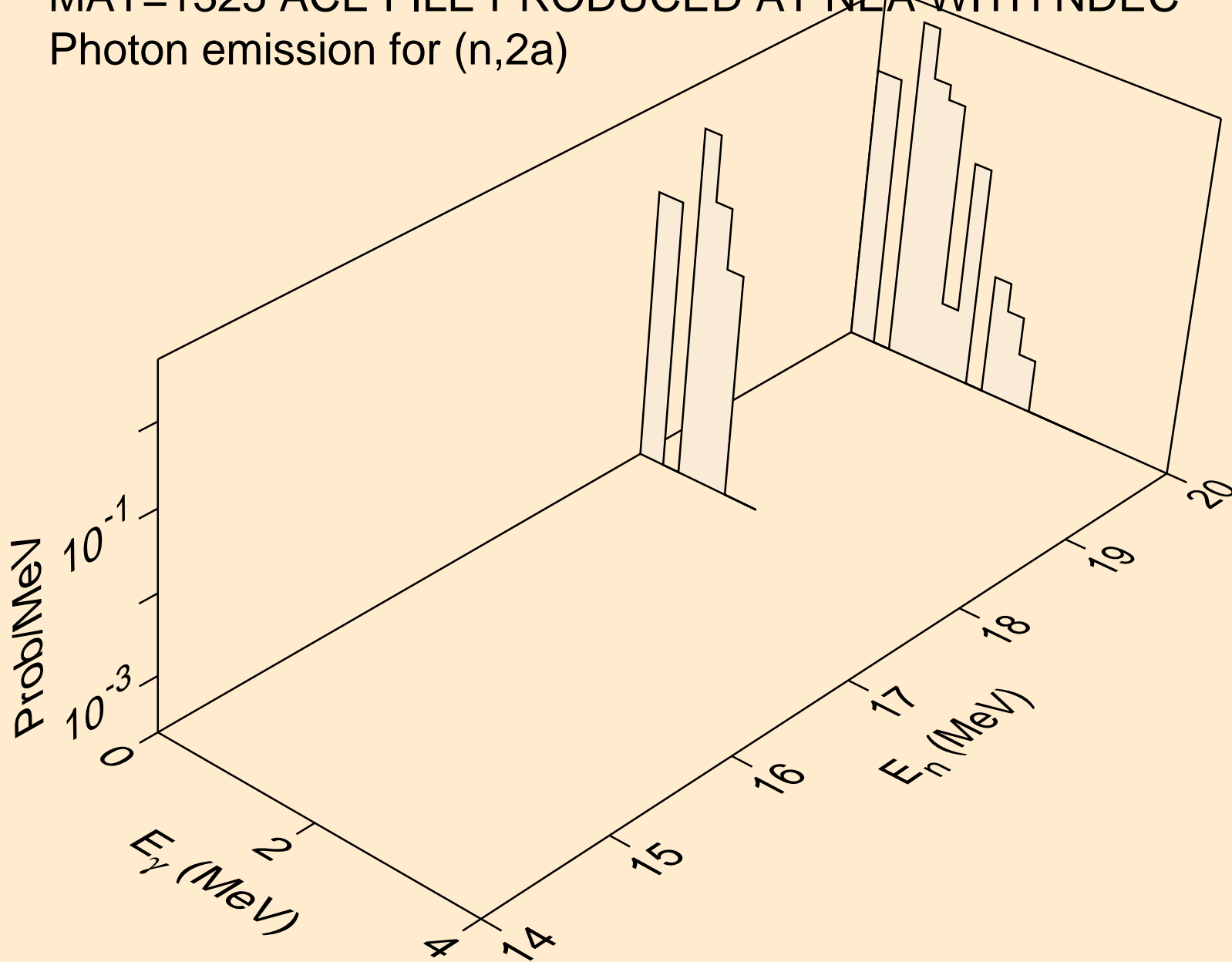

MAT=1325 ACE FILE PRODUCED AT NEA WITH NDEC  
Photon emission for (n,2p)

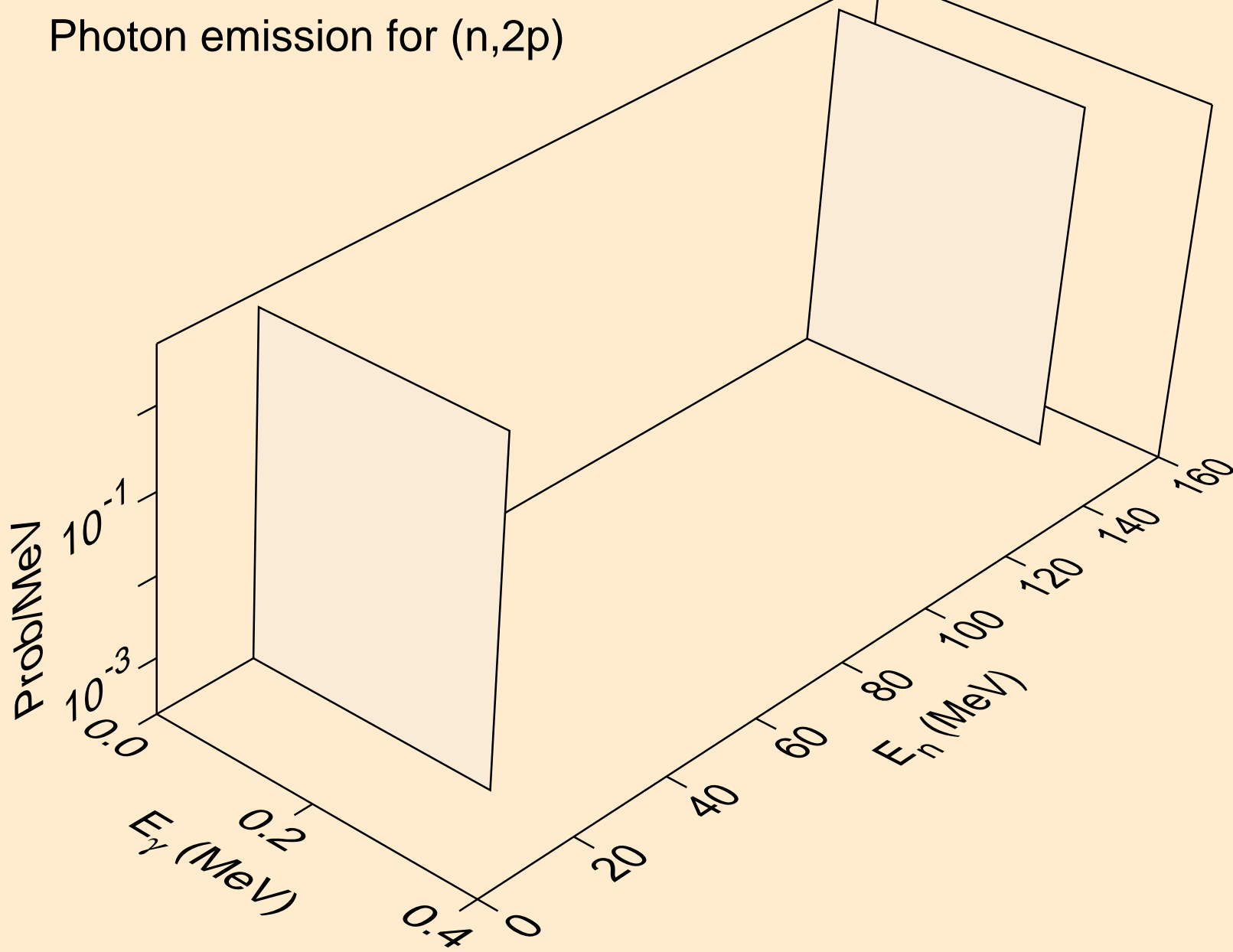

MAT=1325 ACE FILE PRODUCED AT NEA WITH NDEC  
Photon emission for (n,pa)

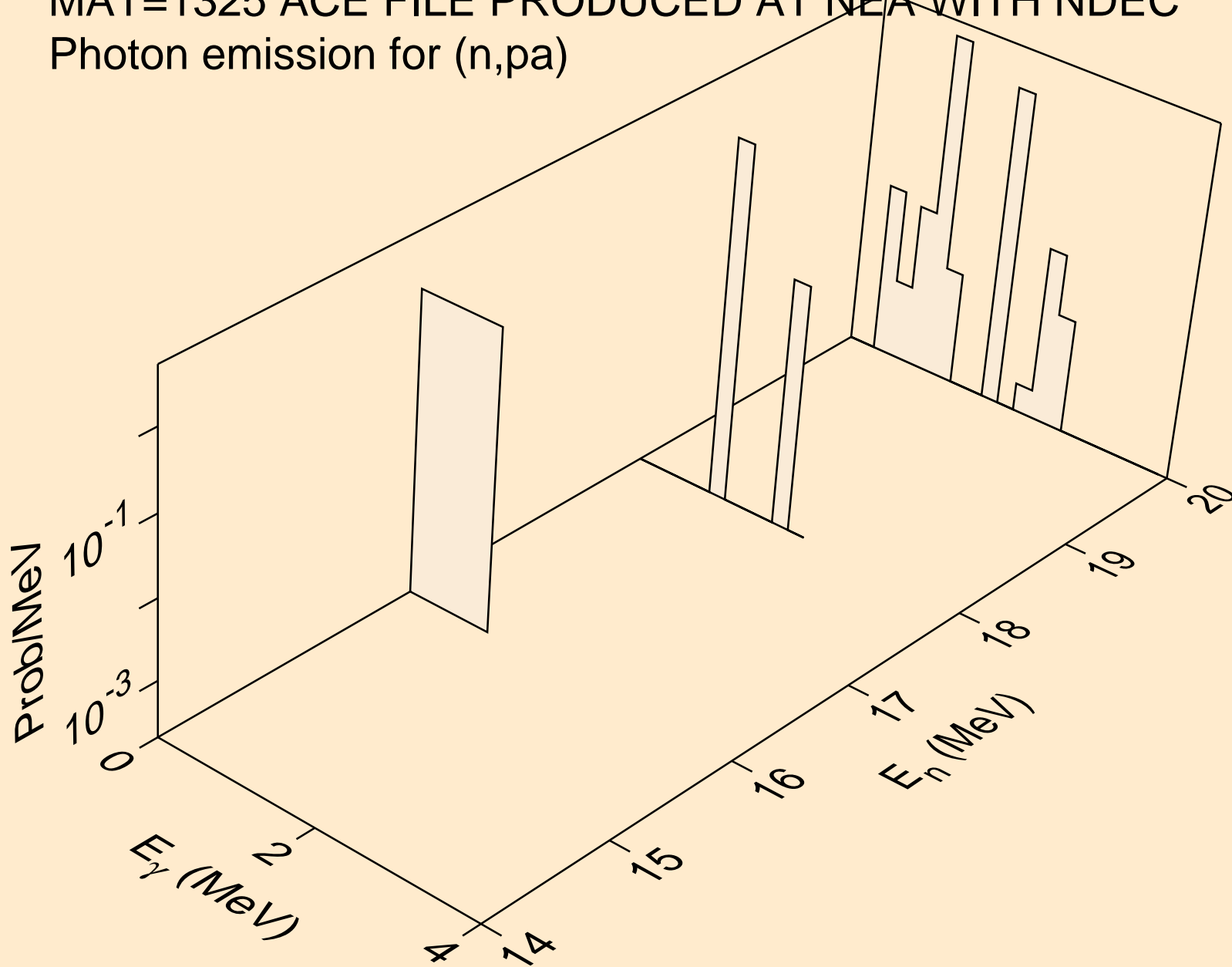

MAT=1325 ACE FILE PRODUCED AT NEA WITH NDEC  
Photon emission for (n,da)

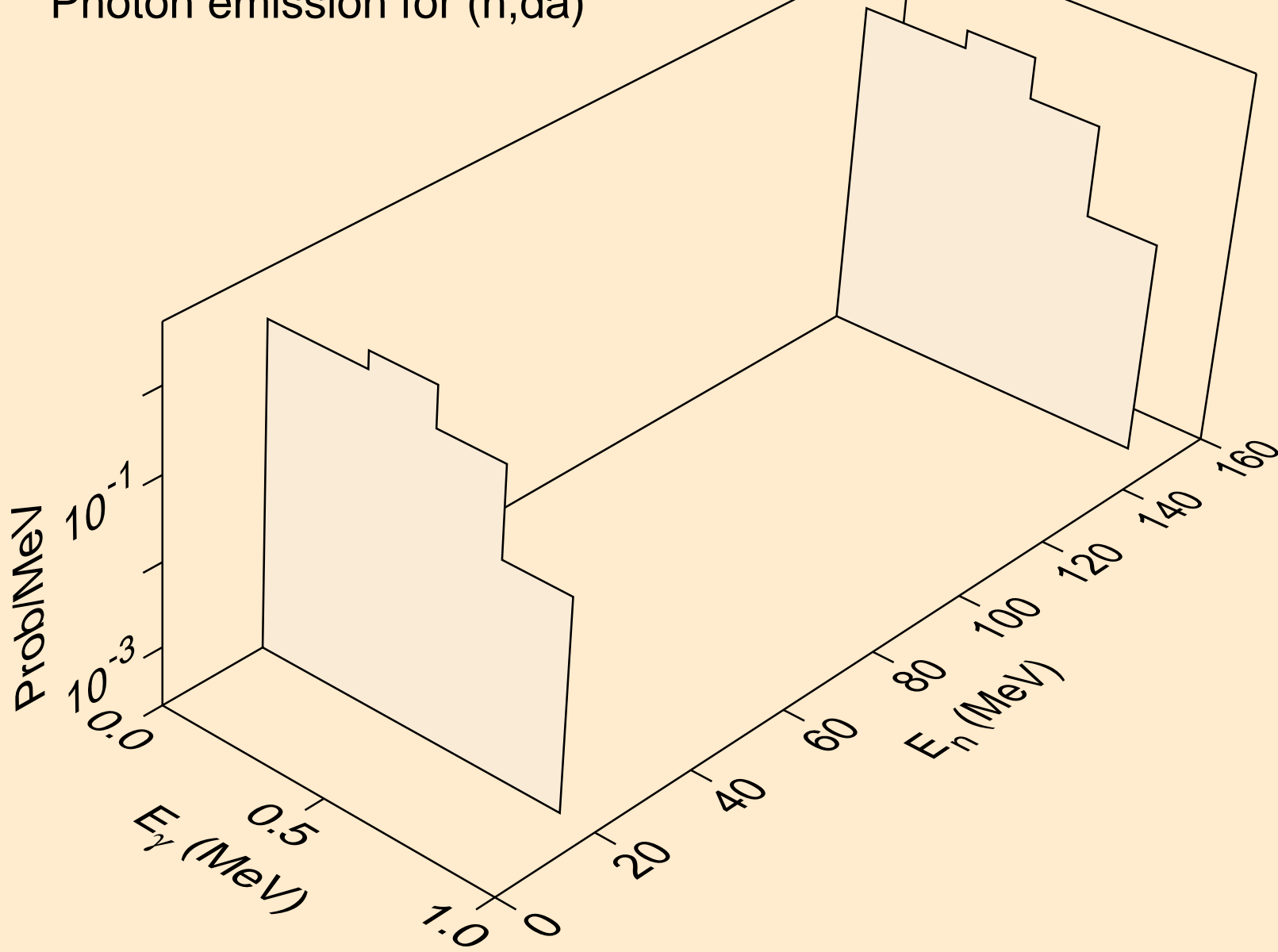



MAT=1325 ACE FILE PRODUCED AT NEA WITH NDEC  
Photon emission for (n,p\*1)

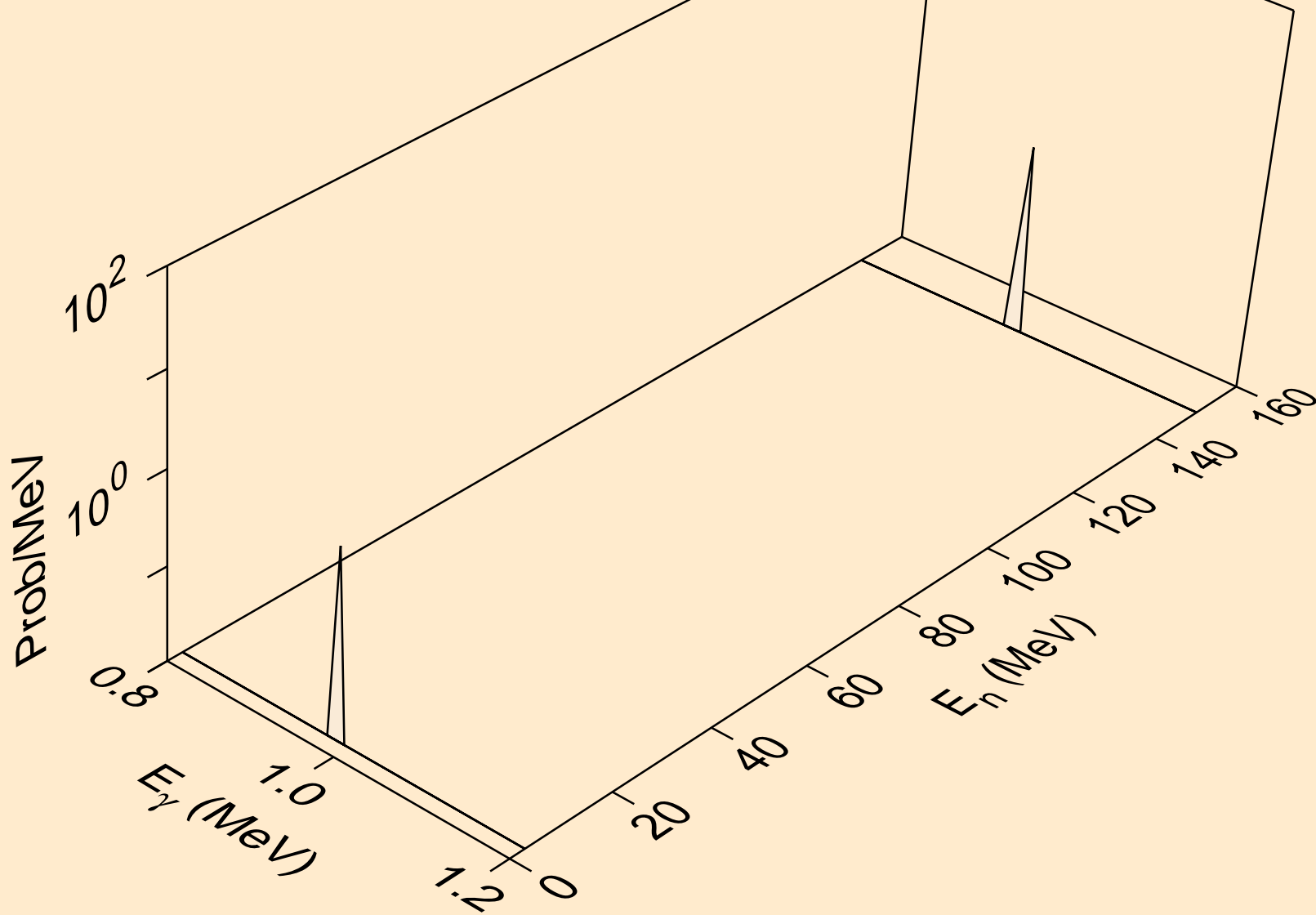

MAT=1325 ACE FILE PRODUCED AT NEA WITH NDEC  
Photon emission for (n,p\*2)

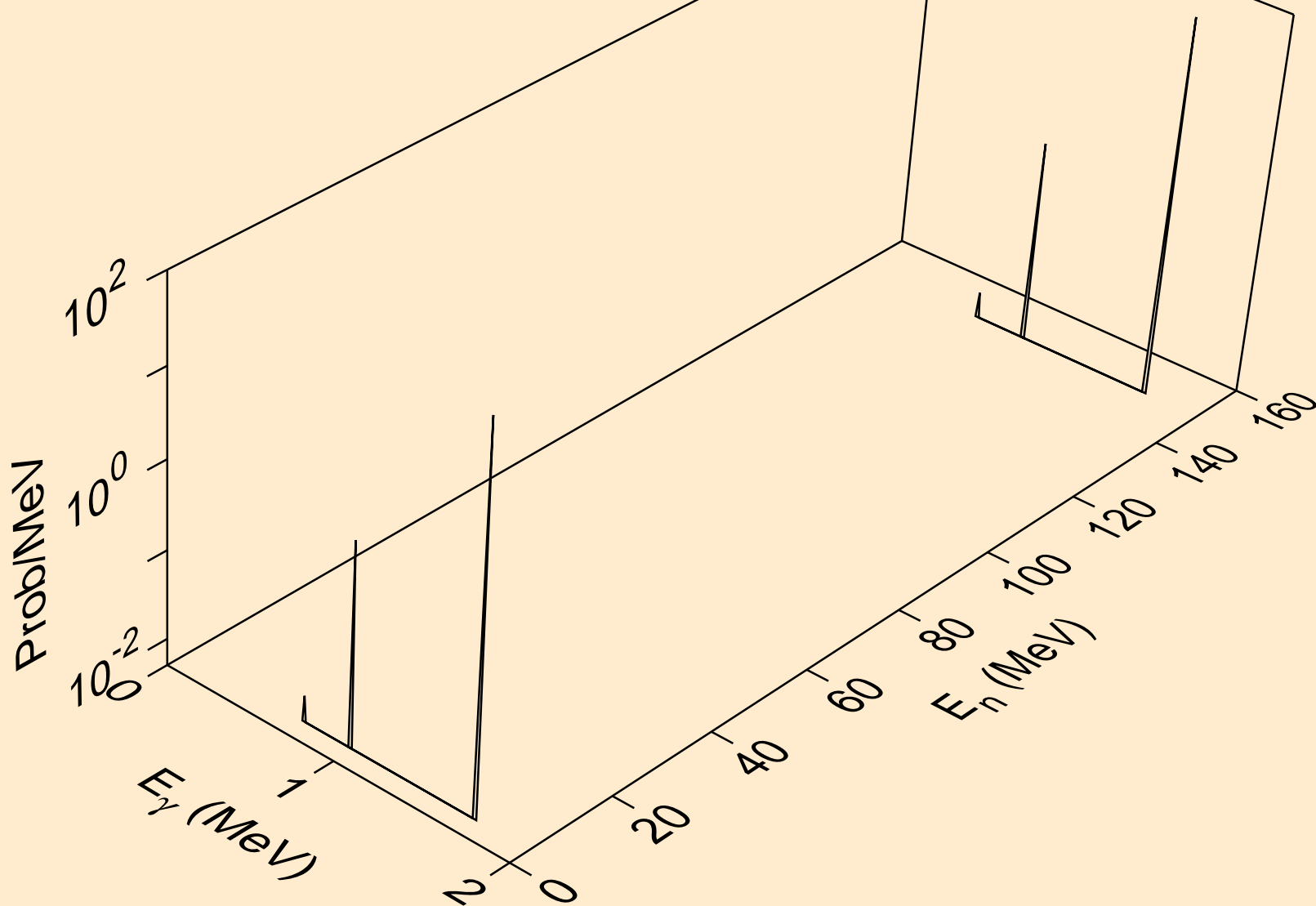

MAT=1325 ACE FILE PRODUCED AT NEA WITH NDEC  
Photon emission for (n,p\*3)

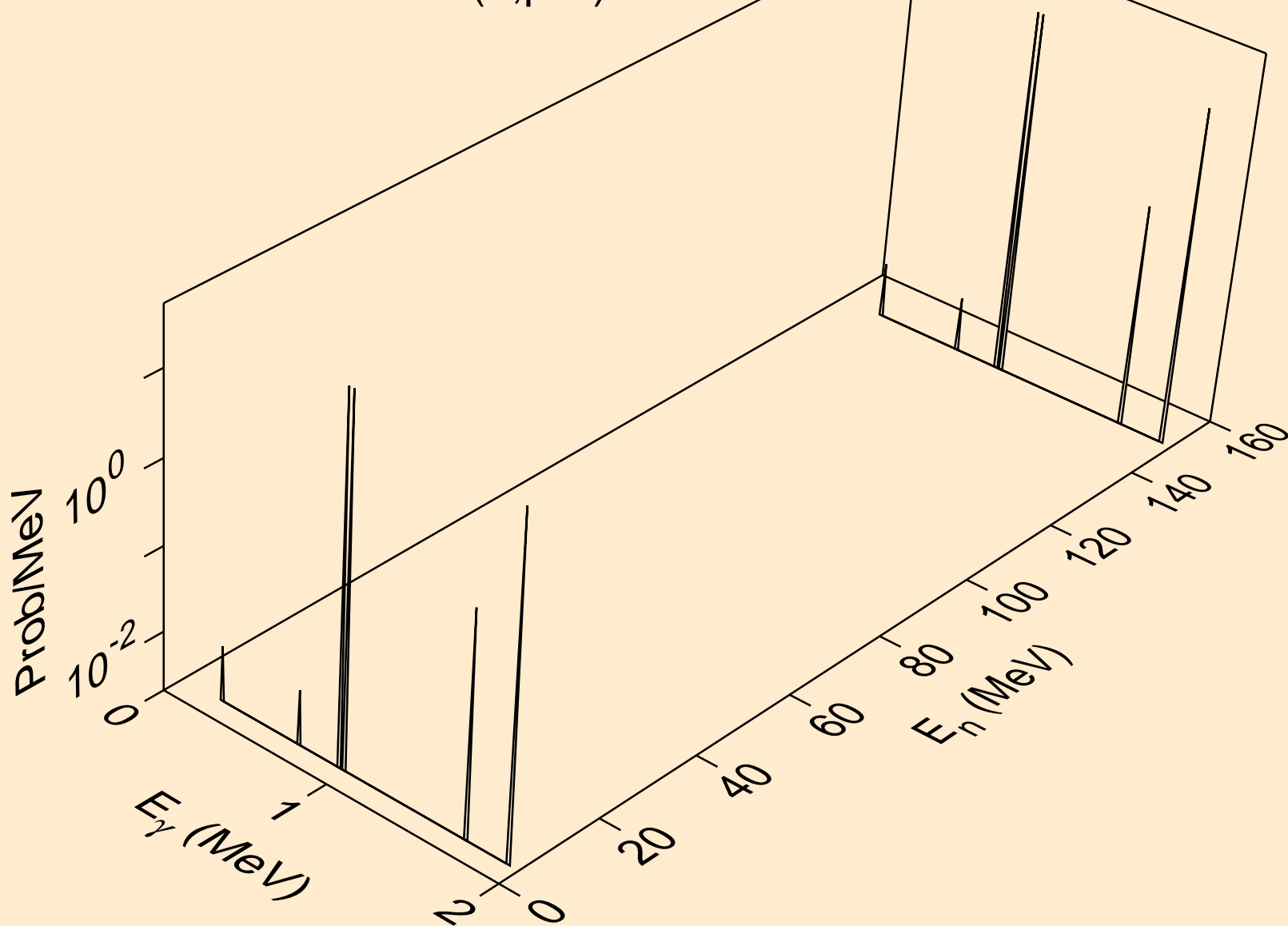

MAT=1325 ACE FILE PRODUCED AT NEA WITH NDEC  
Photon emission for (n,p\*4)

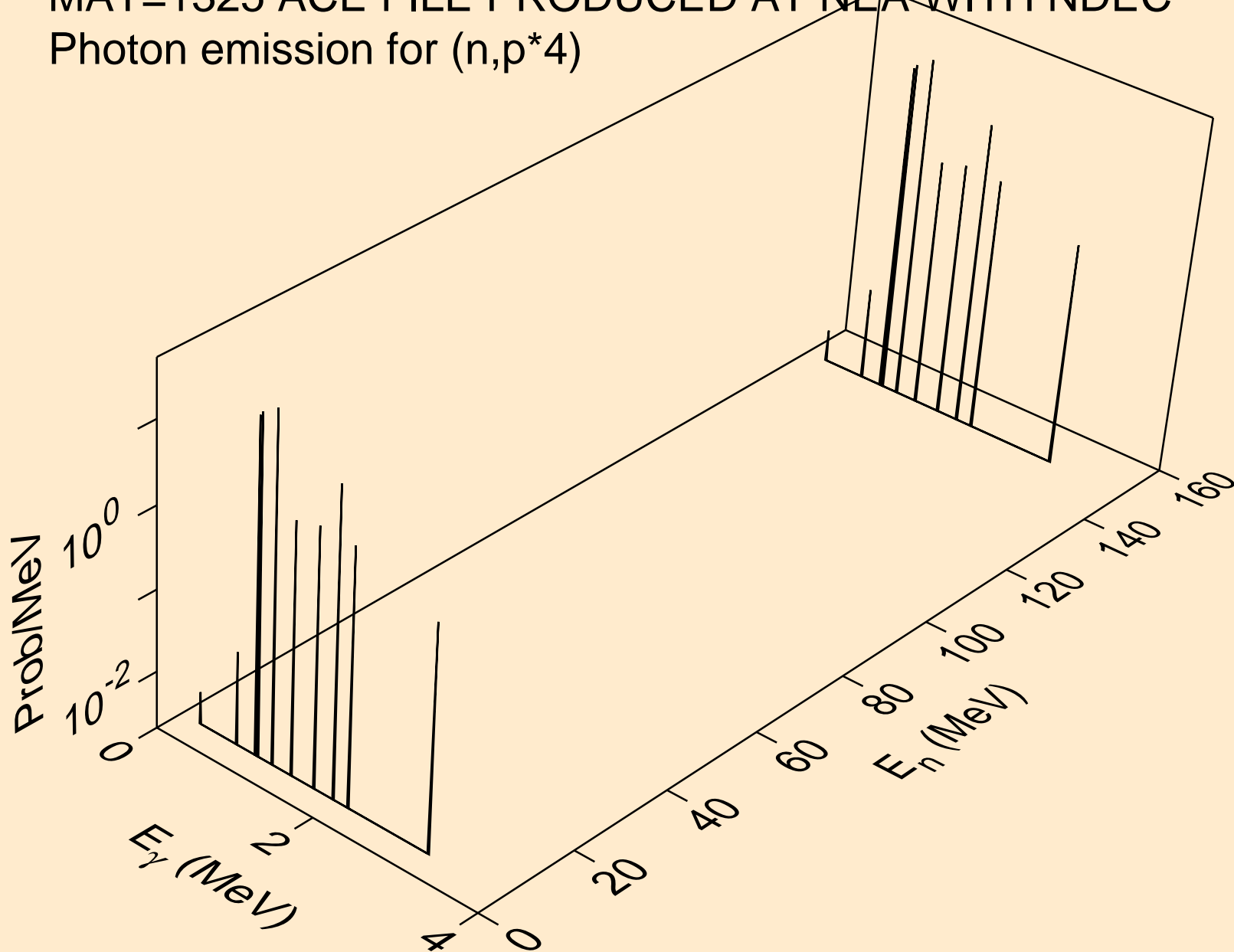

MAT=1325 ACE FILE PRODUCED AT NEA WITH NDEC  
Photon emission for (n,p\*5)

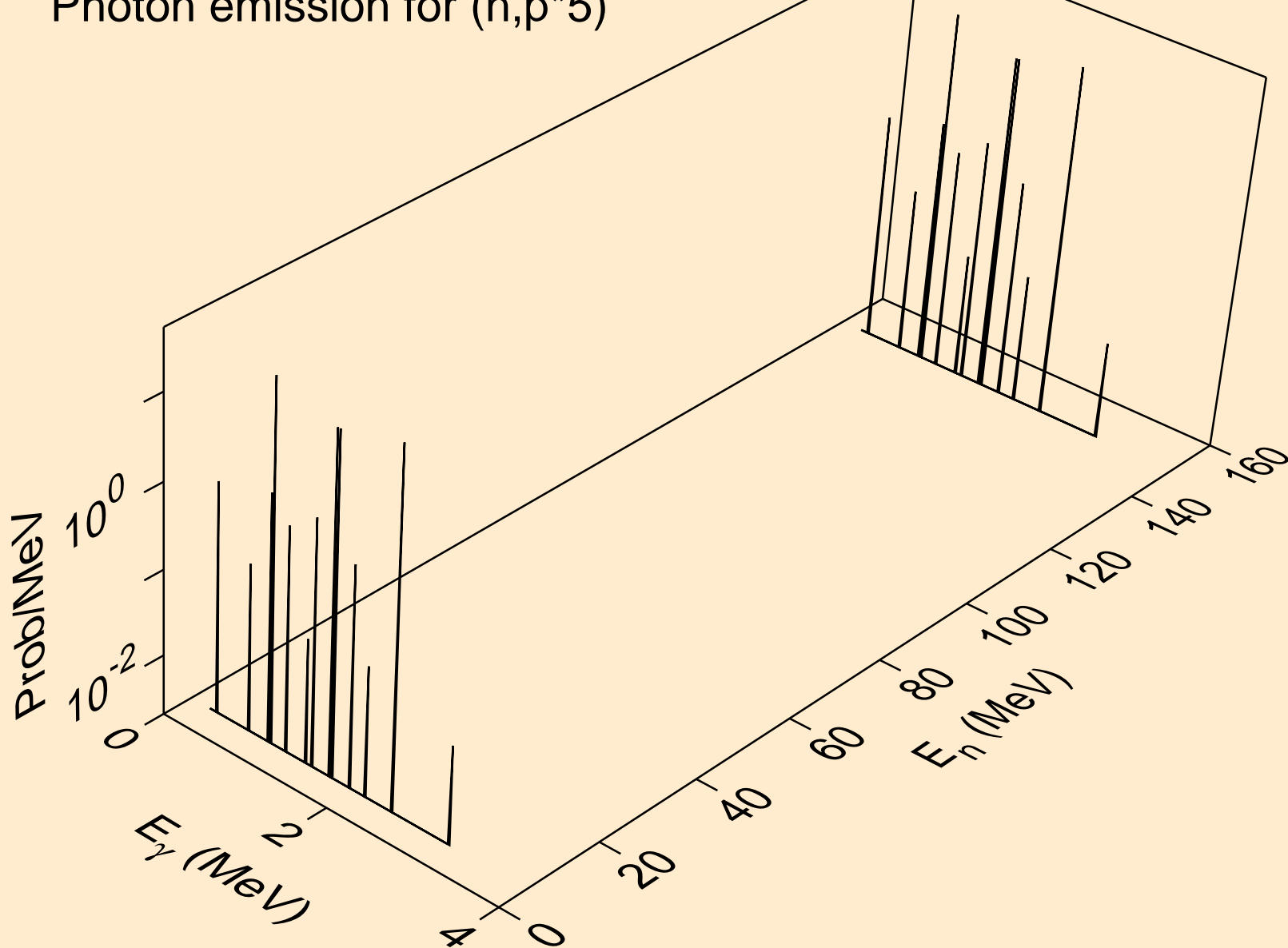

MAT=1325 ACE FILE PRODUCED AT NEA WITH NDEC  
Photon emission for (n,p\*6)

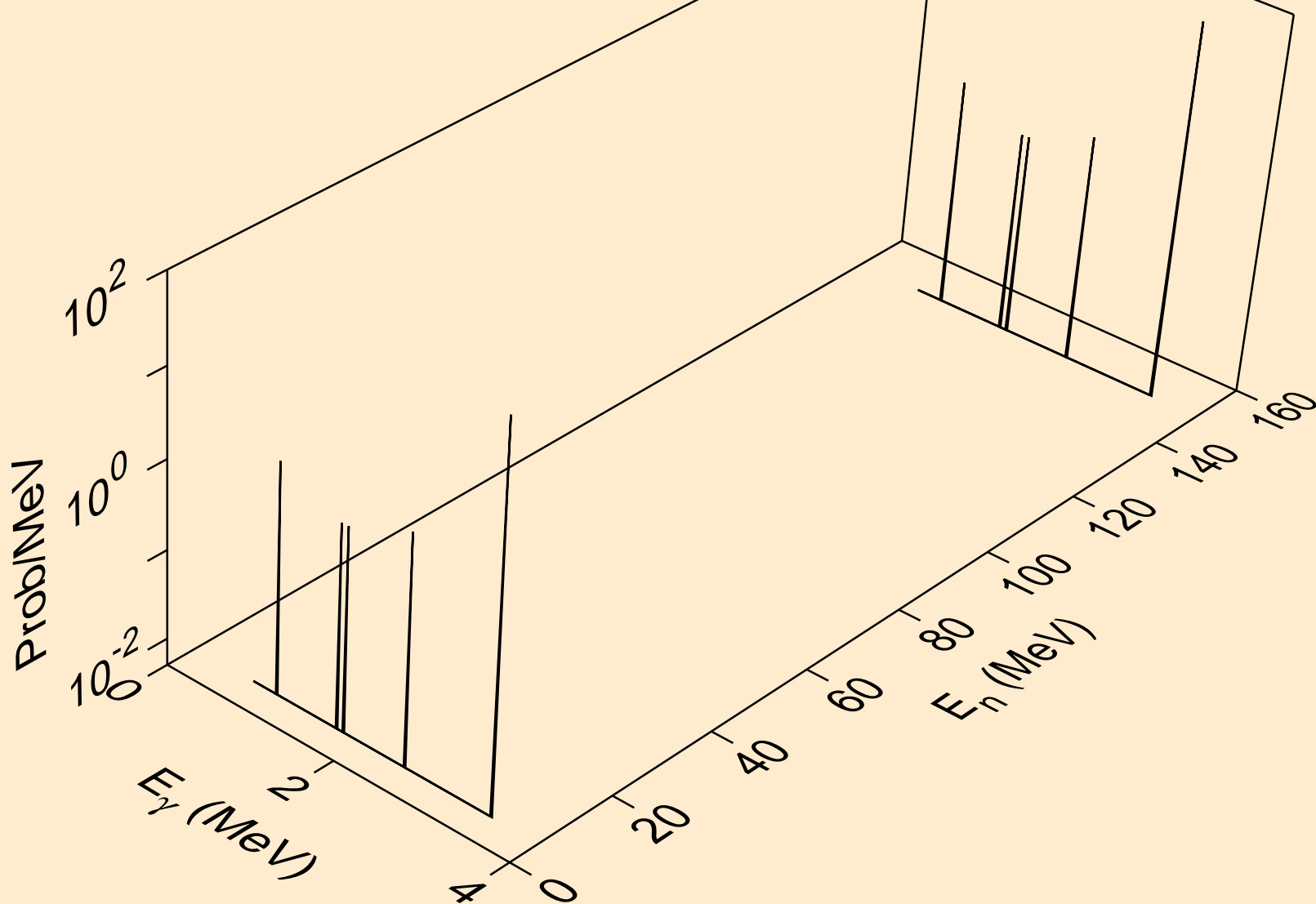

MAT=1325 ACE FILE PRODUCED AT NEA WITH NDEC  
Photon emission for (n,p\*7)

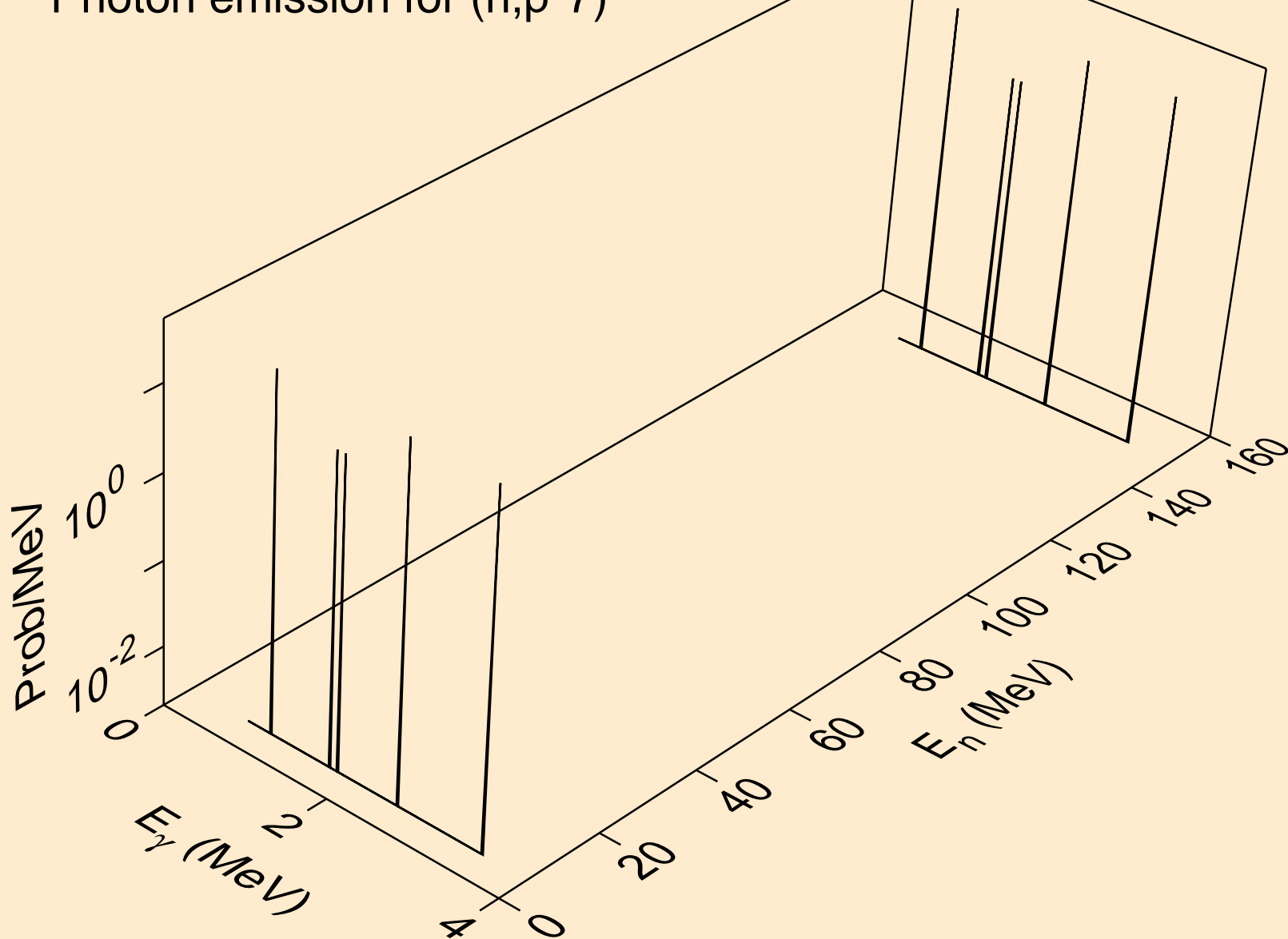

MAT=1325 ACE FILE PRODUCED AT NEA WITH NDEC  
Photon emission for (n,p\*8)

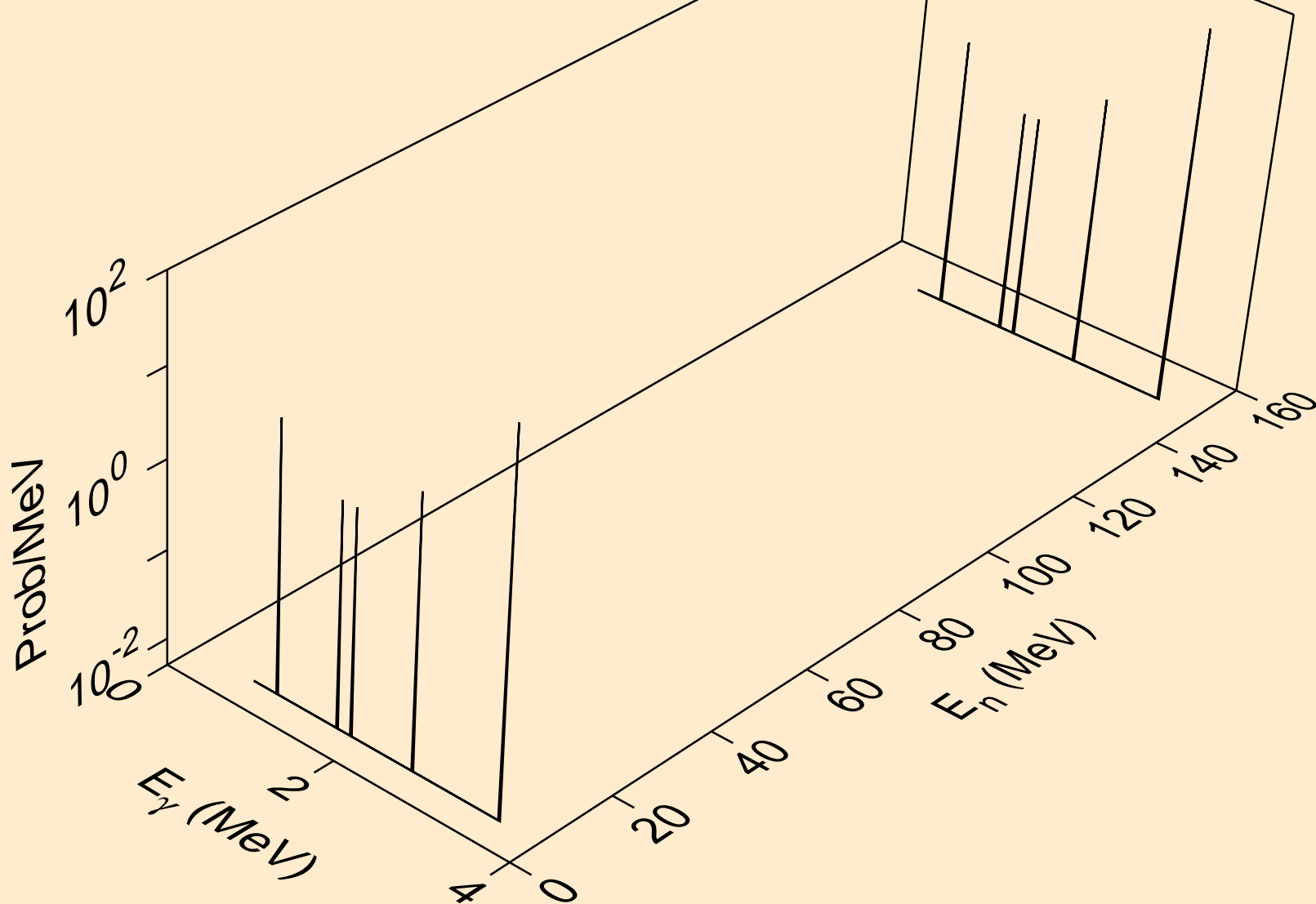



MAT=1325 ACE FILE PRODUCED AT NEA WITH NDEC  
Photon emission for (n,p\*9)

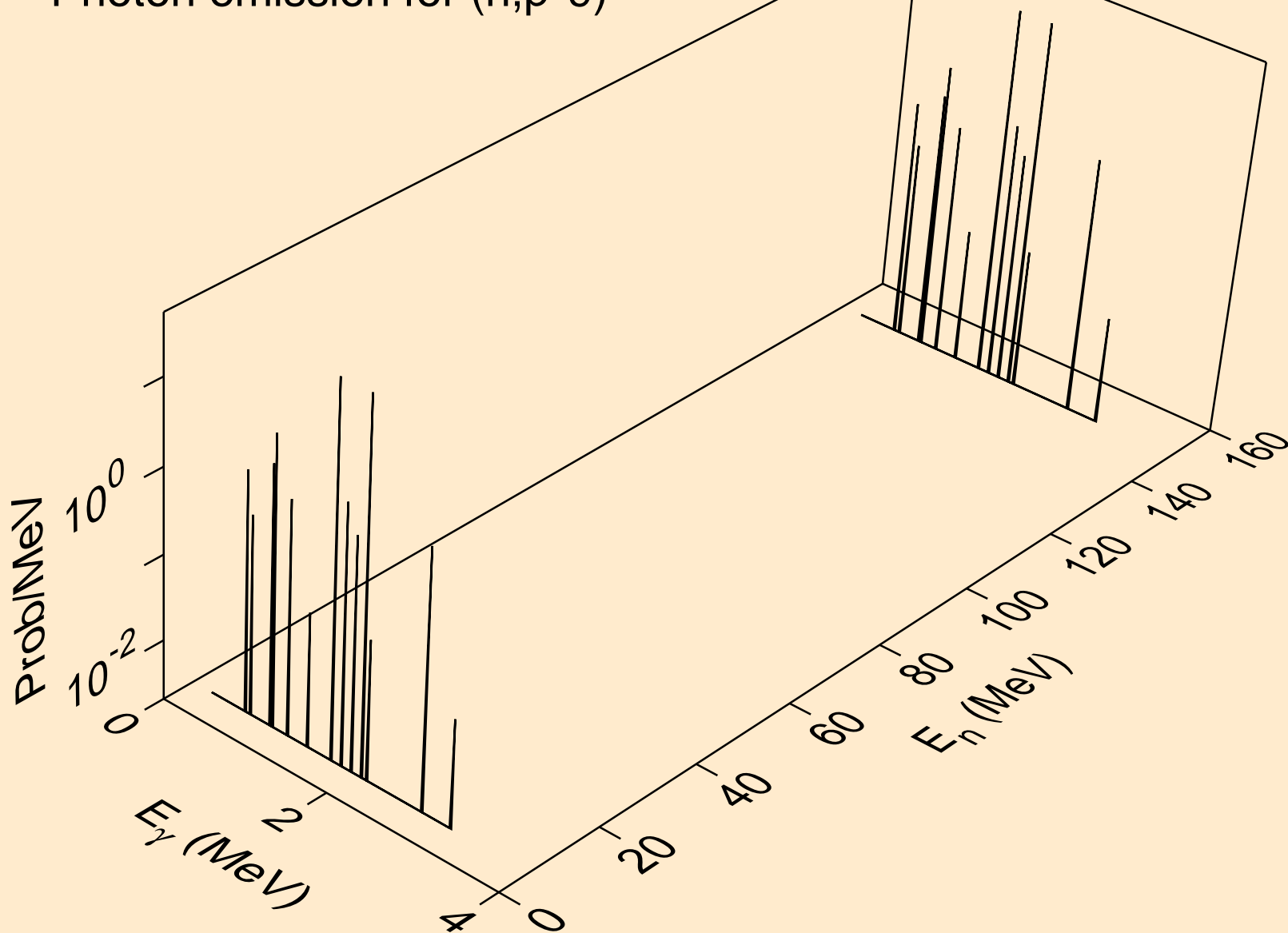

MAT=1325 ACE FILE PRODUCED AT NEA WITH NDEC  
Photon emission for (n,p\*10)

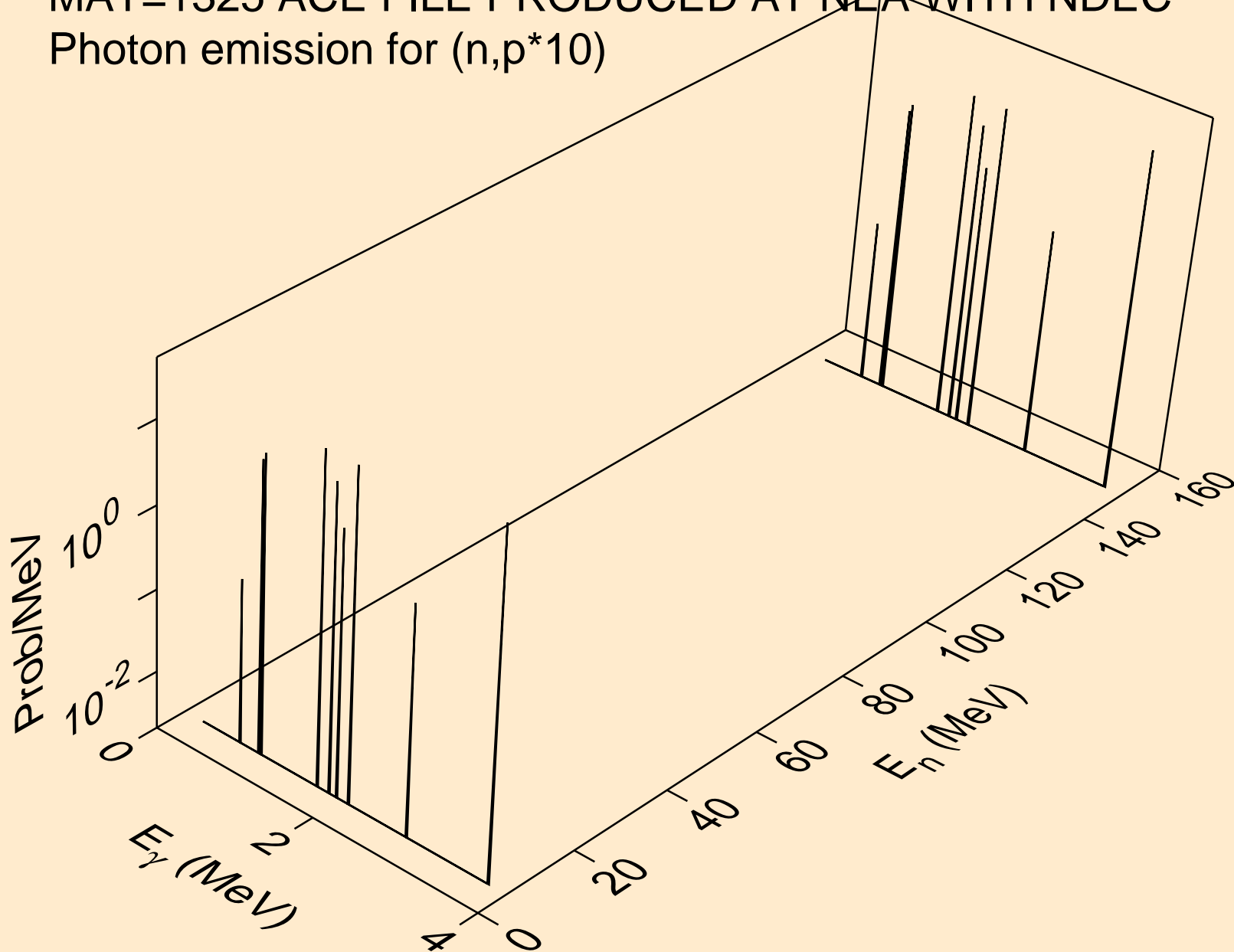

MAT=1325 ACE FILE PRODUCED AT NEA WITH NDEC  
Photon emission for (n,p\*11)

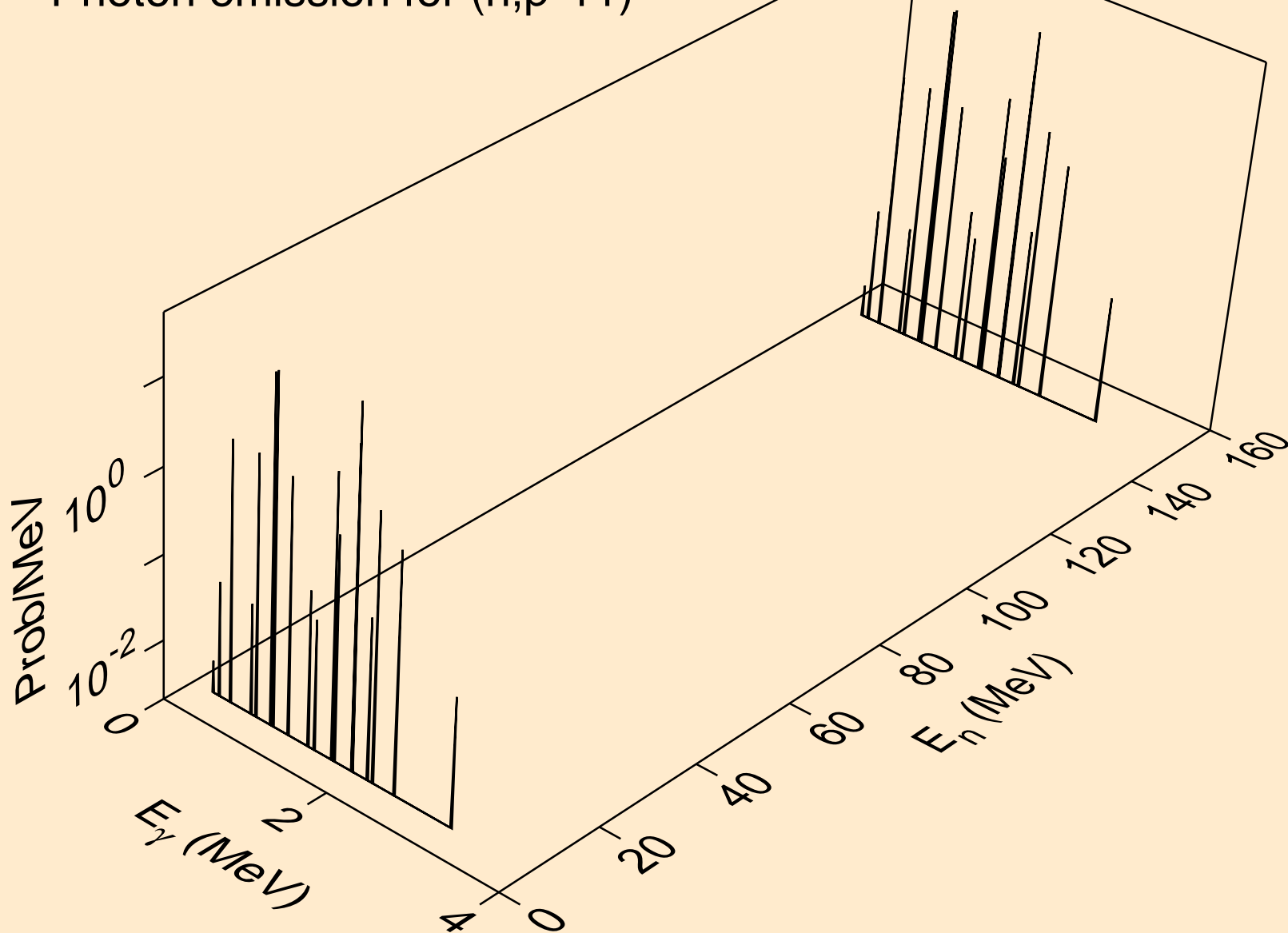

MAT=1325 ACE FILE PRODUCED AT NEA WITH NDEC  
Photon emission for (n,p\*12)

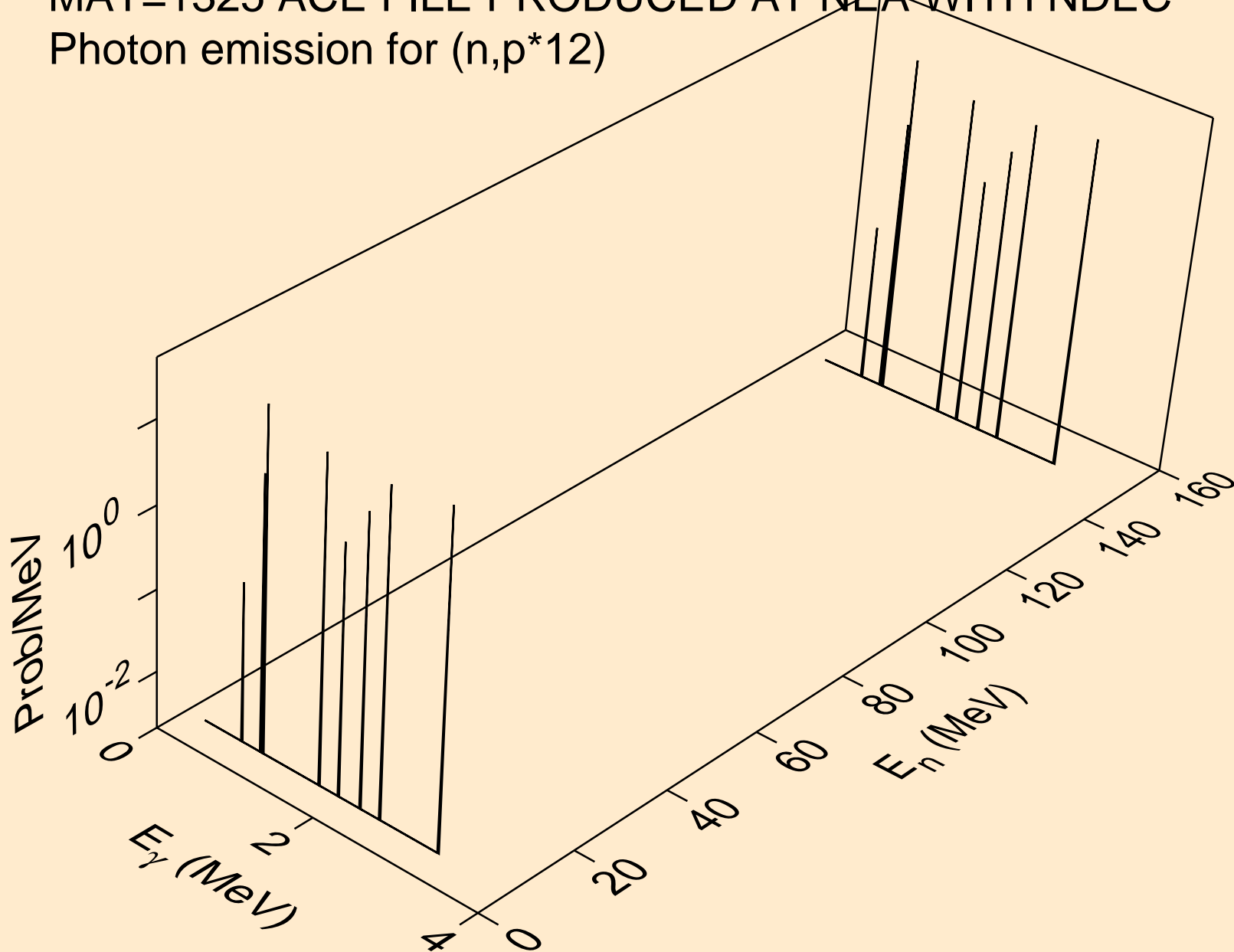

MAT=1325 ACE FILE PRODUCED AT NEA WITH NDEC  
Photon emission for (n,p\*13)

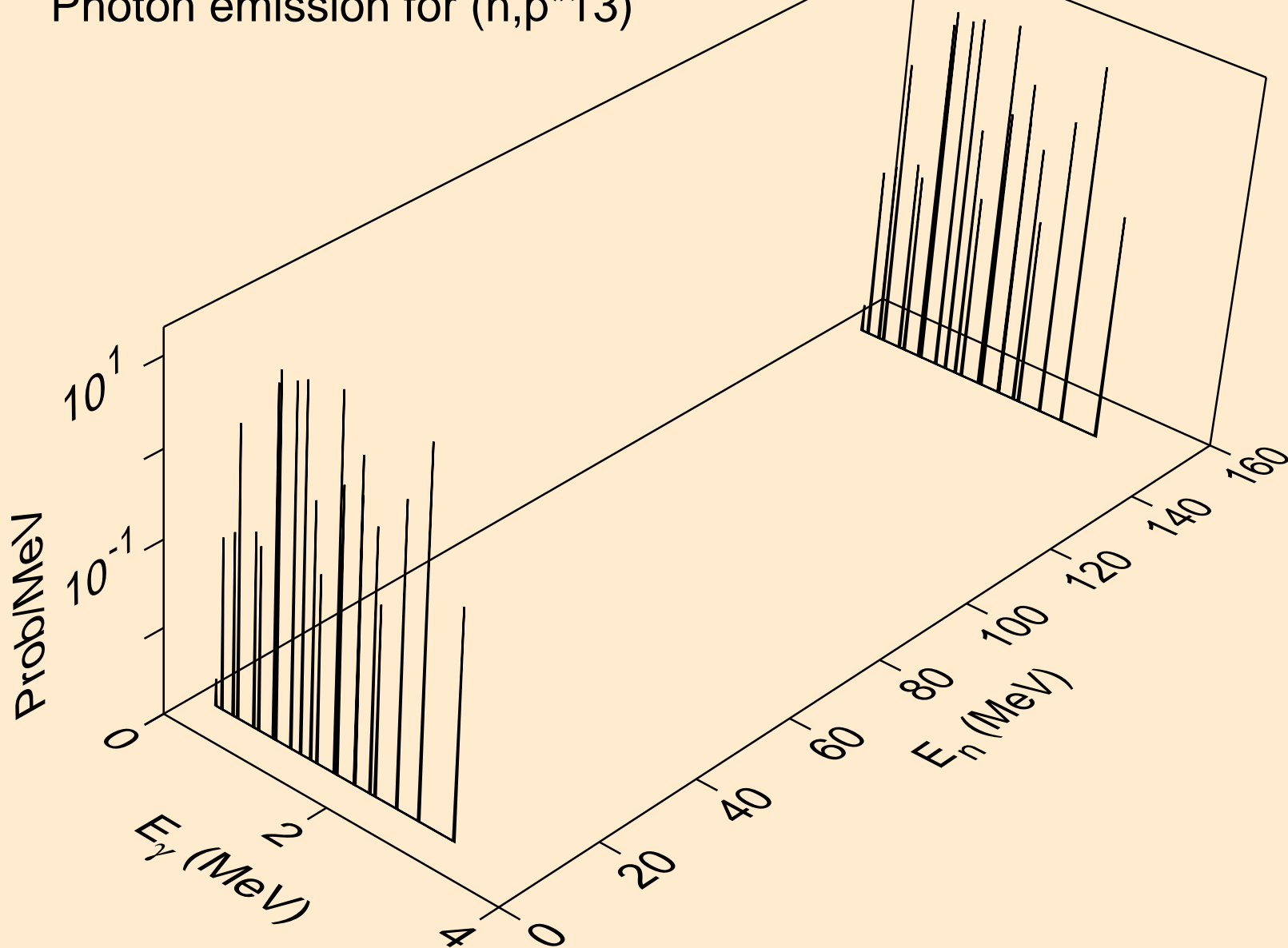

MAT=1325 ACE FILE PRODUCED AT NEA WITH NDEC  
Photon emission for (n,p\*14)

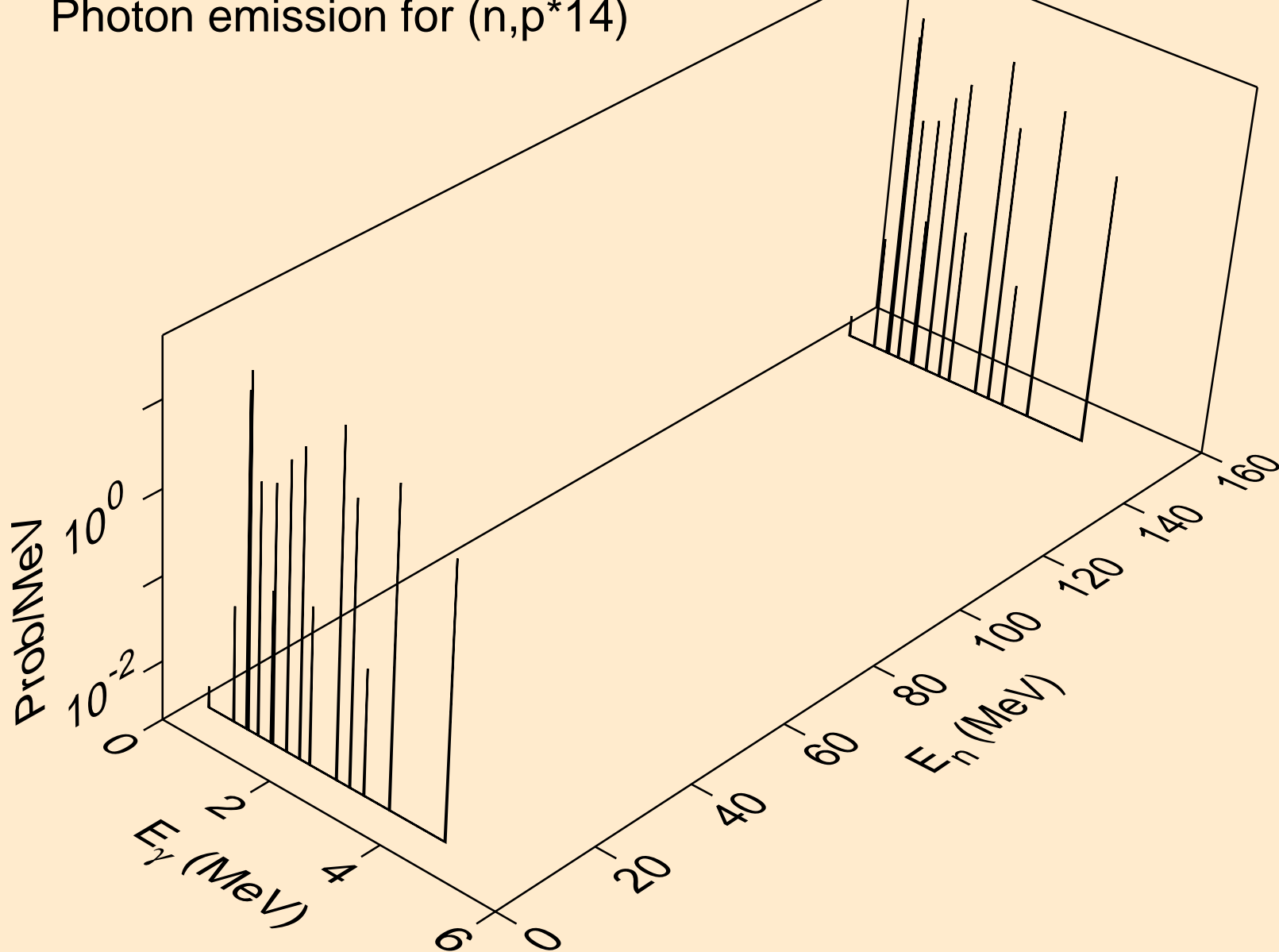

MAT=1325 ACE FILE PRODUCED AT NEA WITH NDEC  
Photon emission for (n,p\*15)

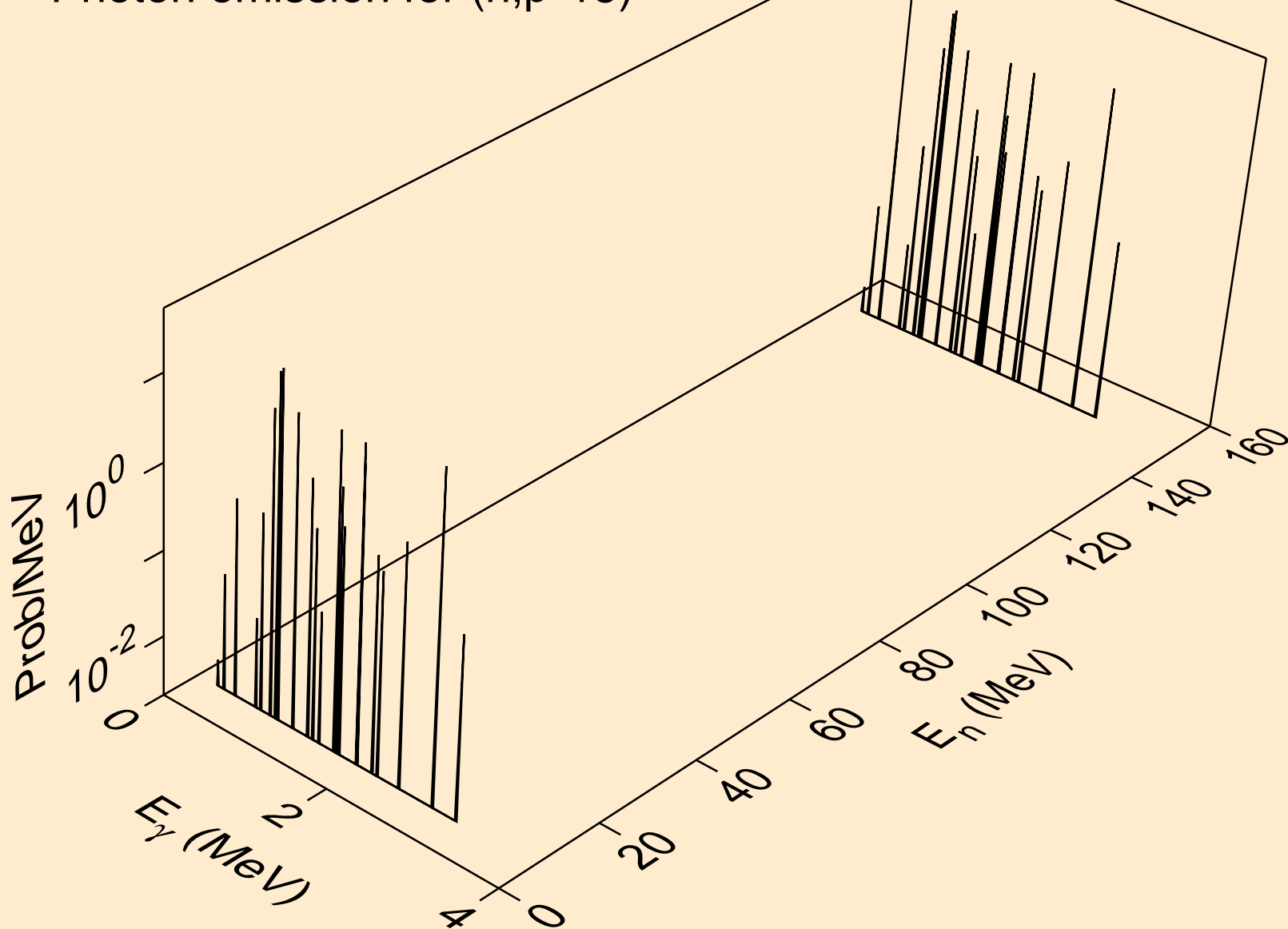

MAT=1325 ACE FILE PRODUCED AT NEA WITH NDEC  
Photon emission for (n,p\*16)

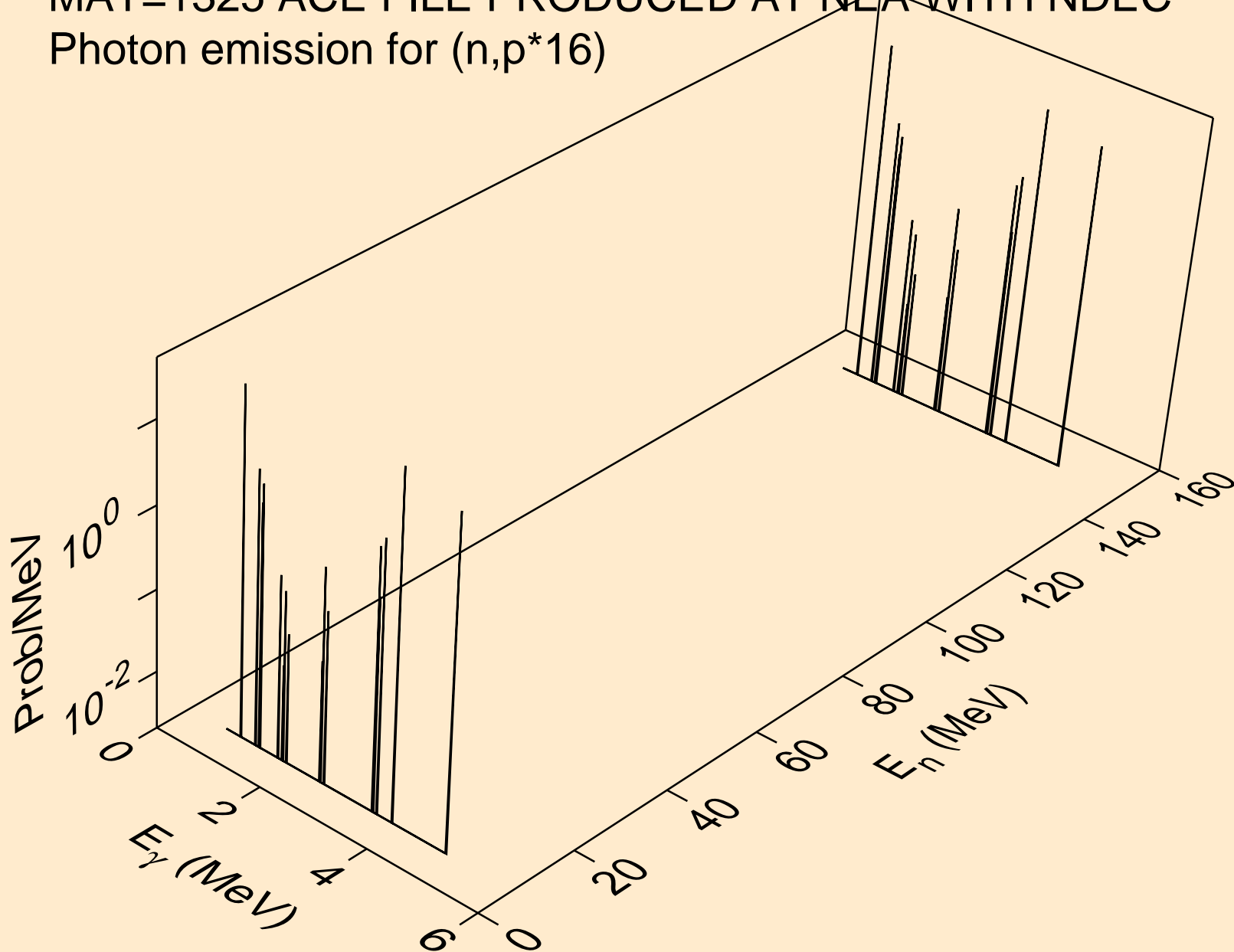



MAT=1325 ACE FILE PRODUCED AT NEA WITH NDEC  
Photon emission for (n,p\*17)

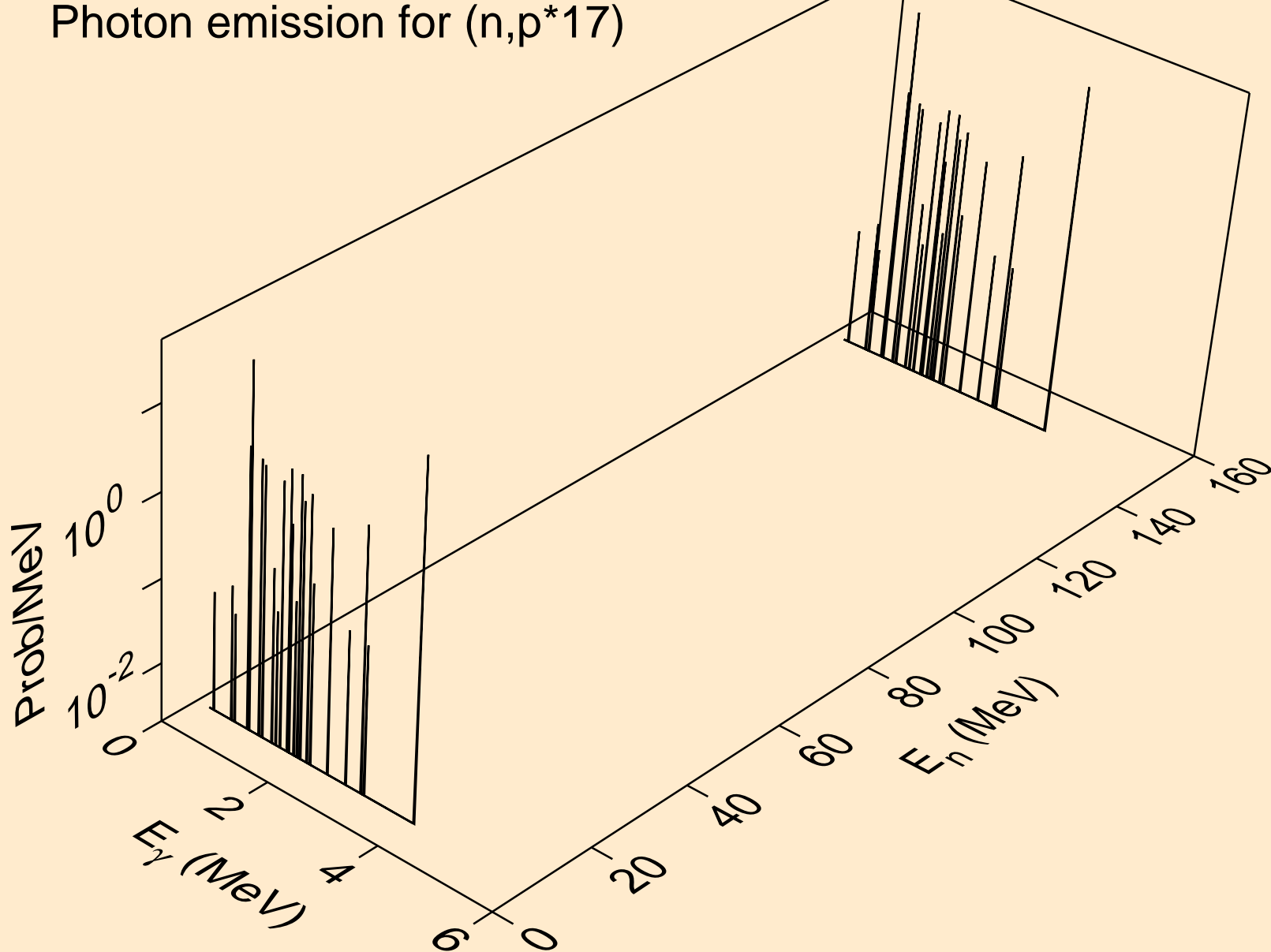

MAT=1325 ACE FILE PRODUCED AT NEA WITH NDEC  
Photon emission for (n,p\*18)

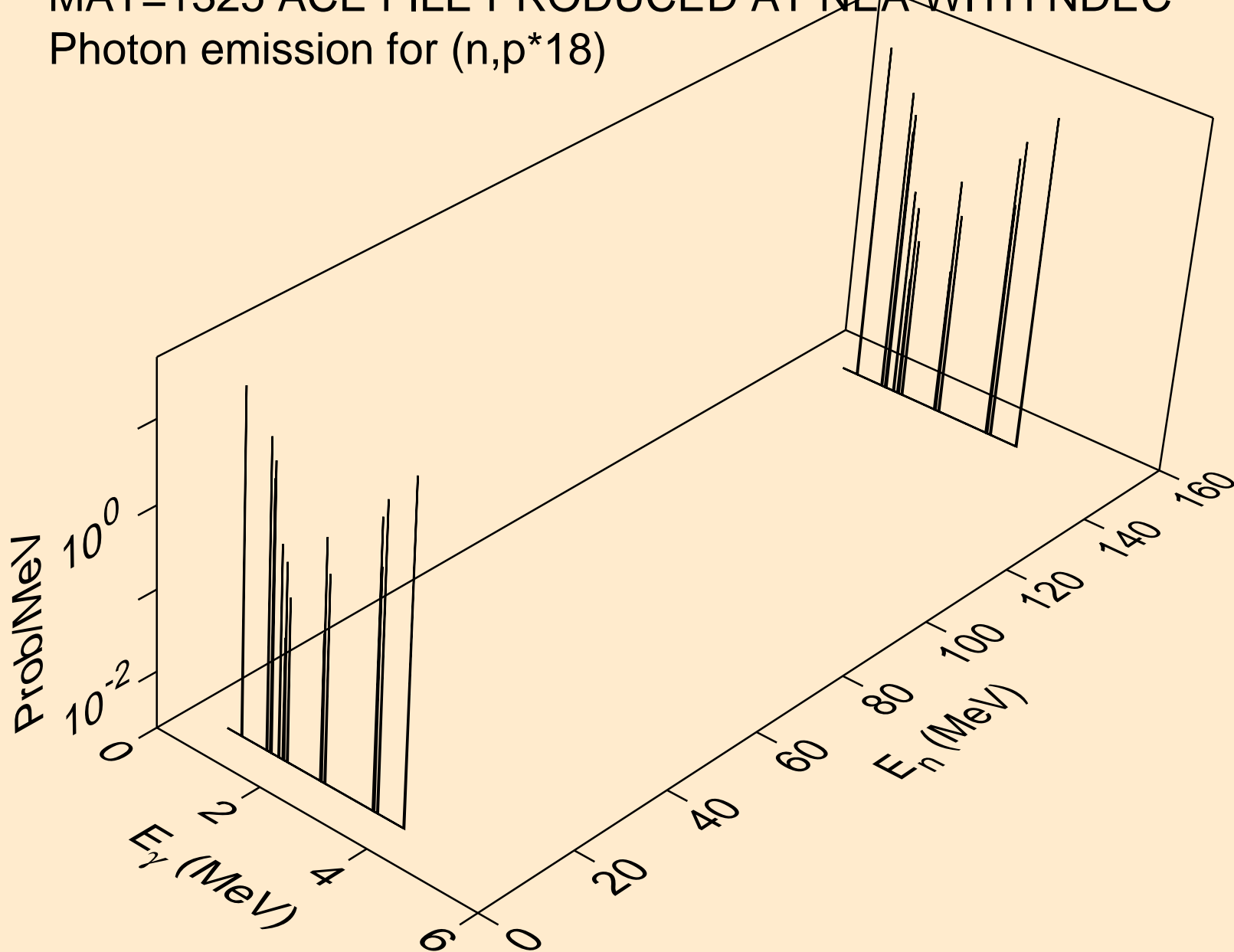

MAT=1325 ACE FILE PRODUCED AT NEA WITH NDEC  
Photon emission for (n,p\*19)

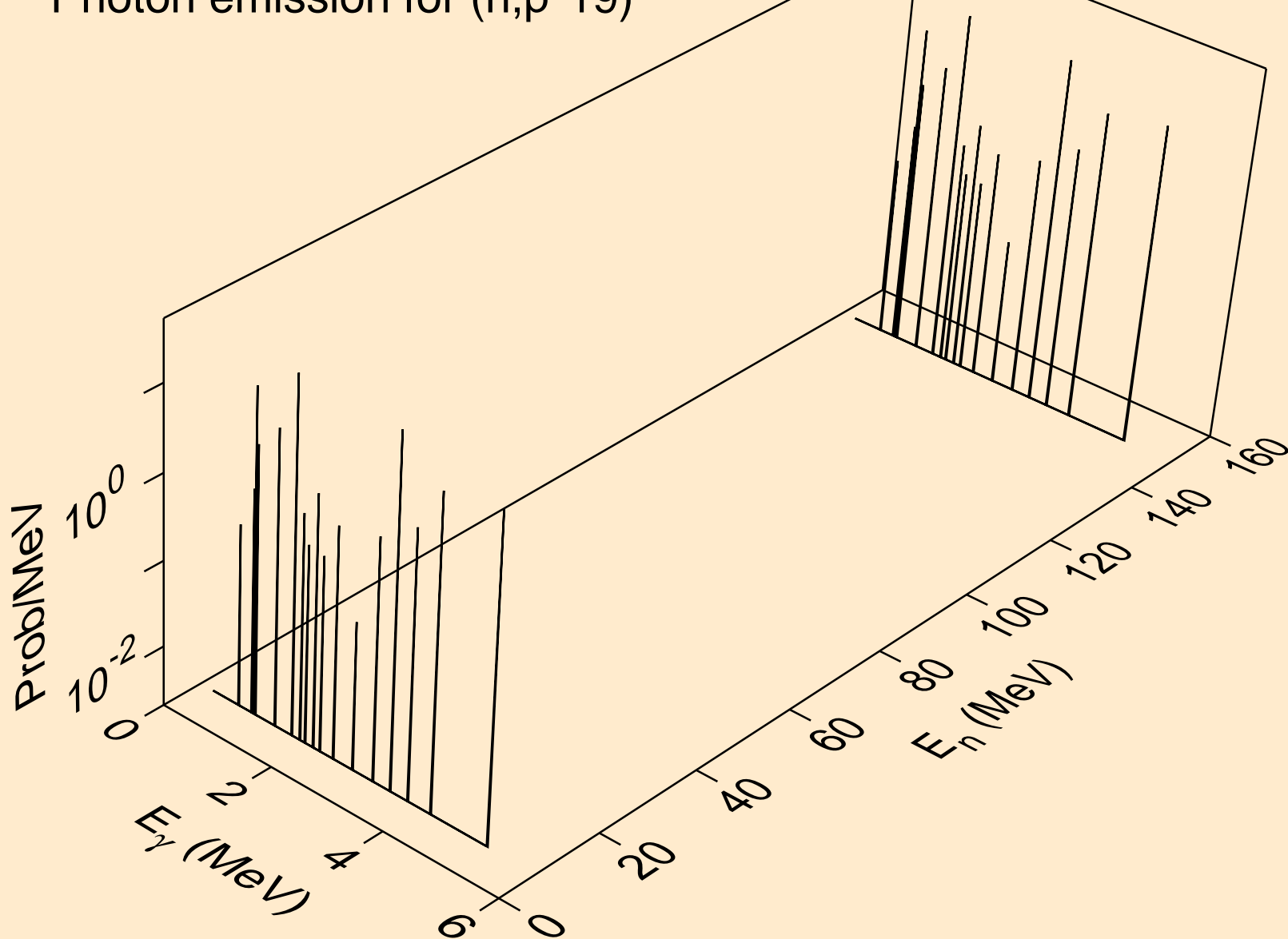

MAT=1325 ACE FILE PRODUCED AT NEA WITH NDEC  
Photon emission for (n,p\*c)

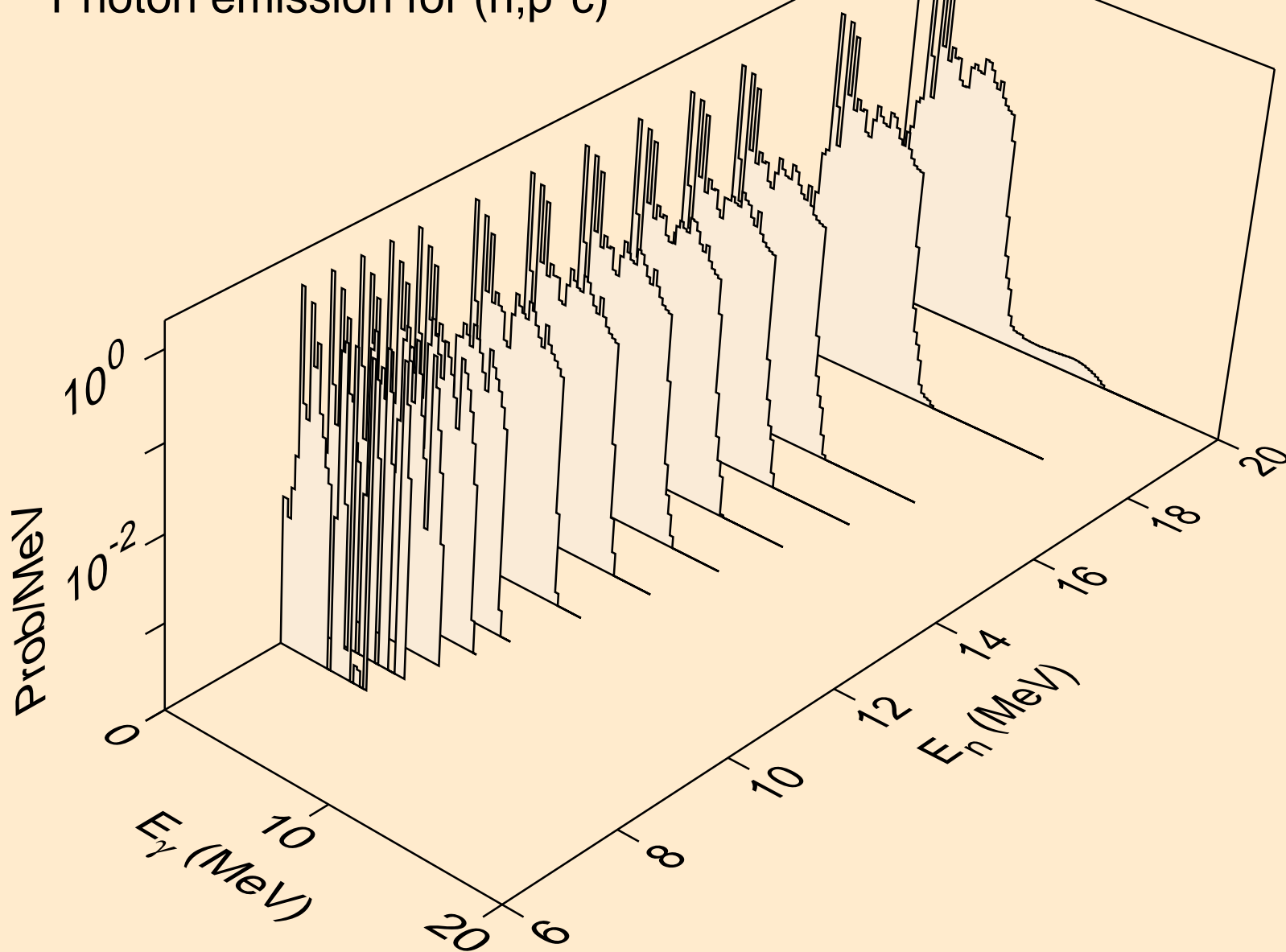

MAT=1325 ACE FILE PRODUCED AT NEA WITH NDEC  
Photon emission for (n,d\*1)

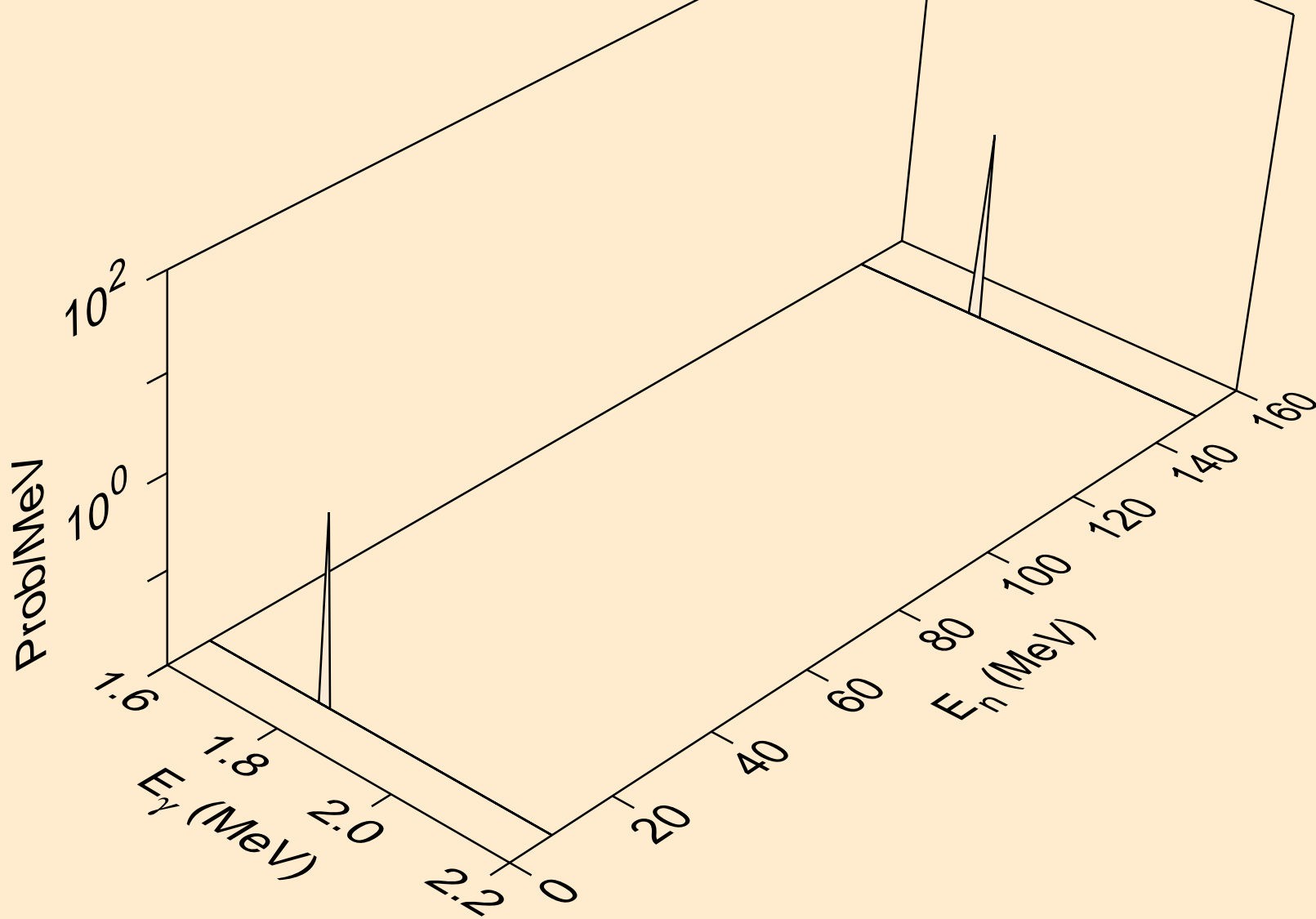

MAT=1325 ACE FILE PRODUCED AT NEA WITH NDEC  
Photon emission for (n,d\*2)

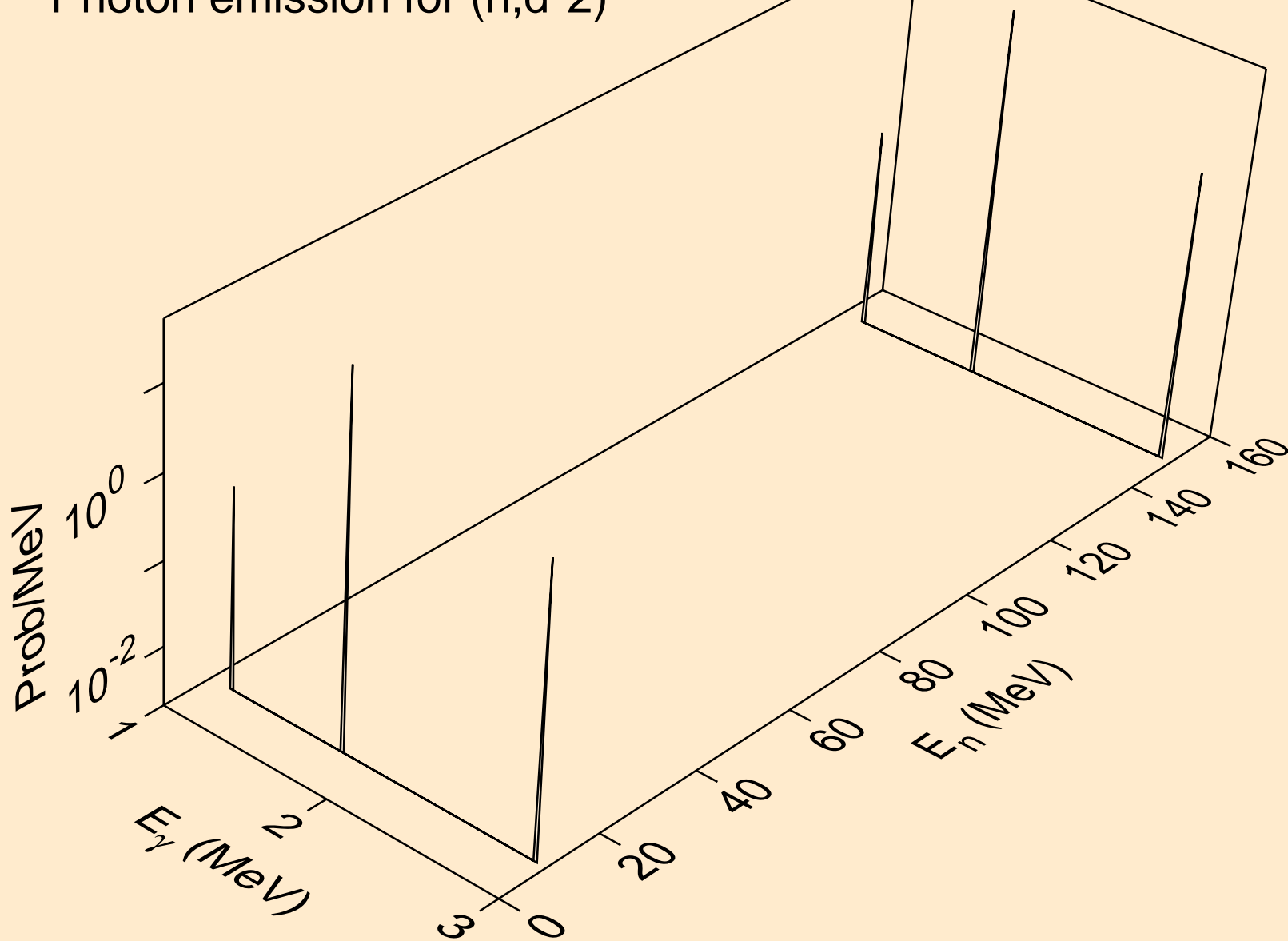

MAT=1325 ACE FILE PRODUCED AT NEA WITH NDEC  
Photon emission for (n,d\*3)

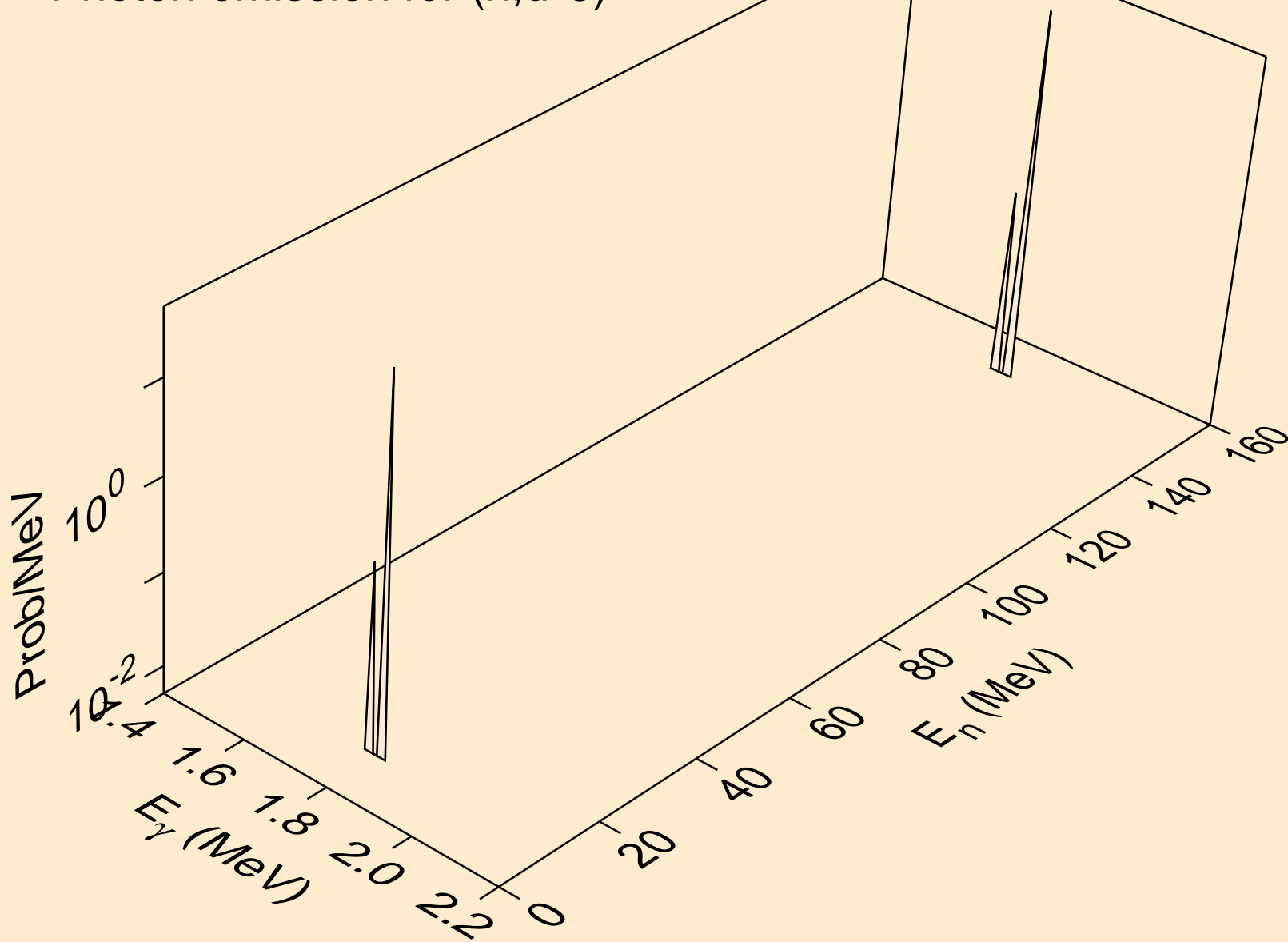

MAT=1325 ACE FILE PRODUCED AT NEA WITH NDEC  
Photon emission for (n,d\*4)

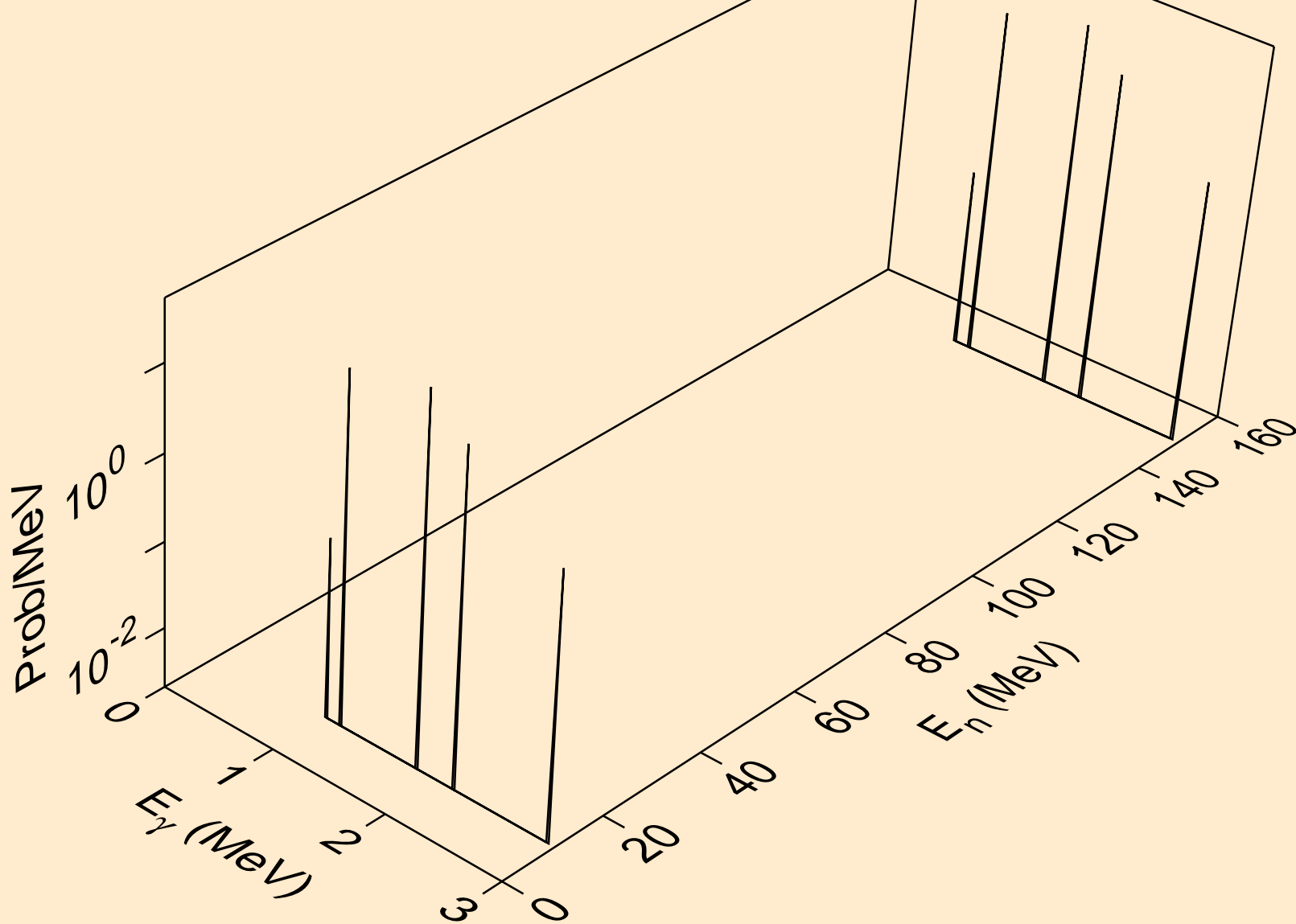



MAT=1325 ACE FILE PRODUCED AT NEA WITH NDEC  
Photon emission for (n,d\*5)

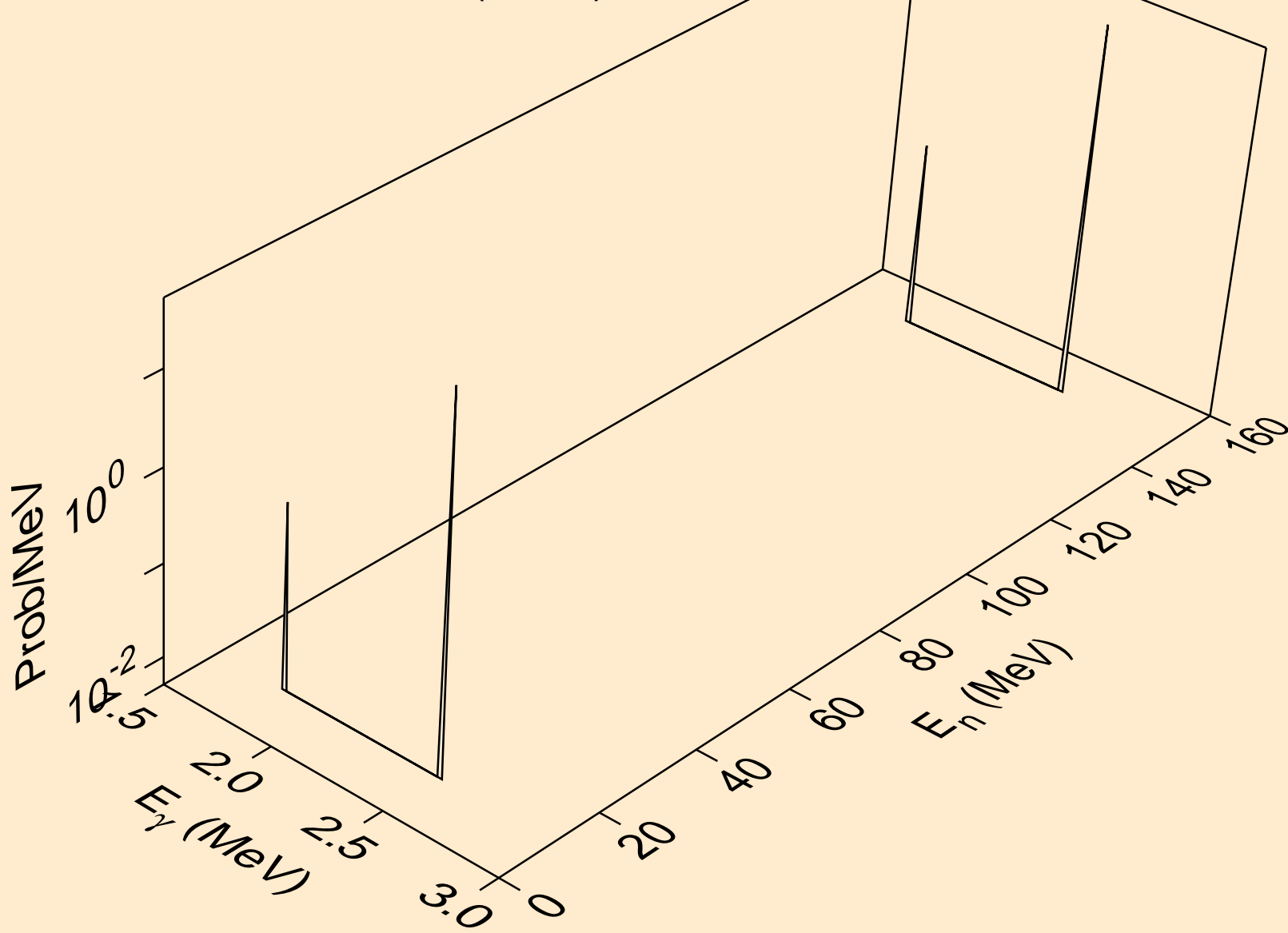

MAT=1325 ACE FILE PRODUCED AT NEA WITH NDEC  
Photon emission for (n,d\*6)

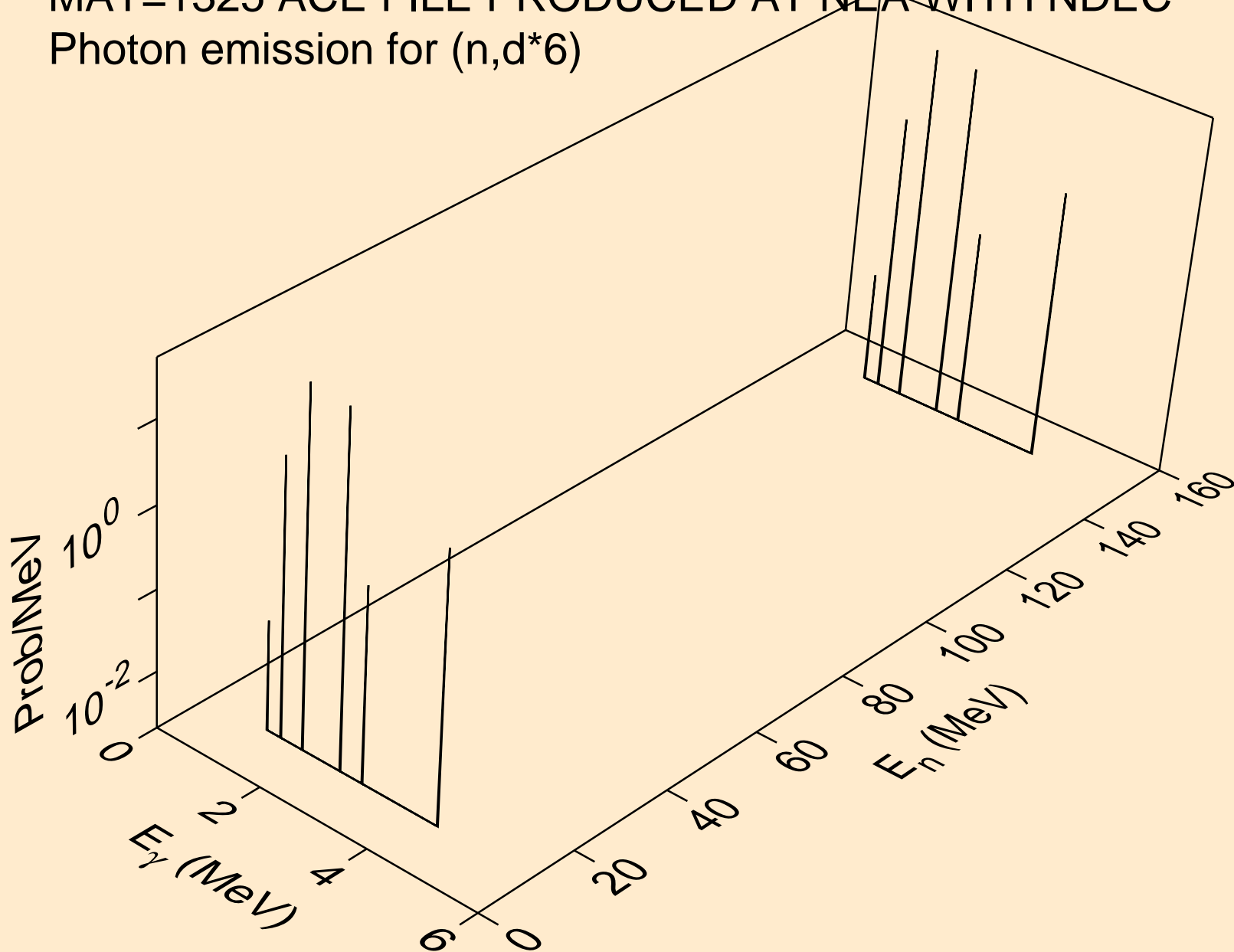

MAT=1325 ACE FILE PRODUCED AT NEA WITH NDEC  
Photon emission for (n,d\*7)

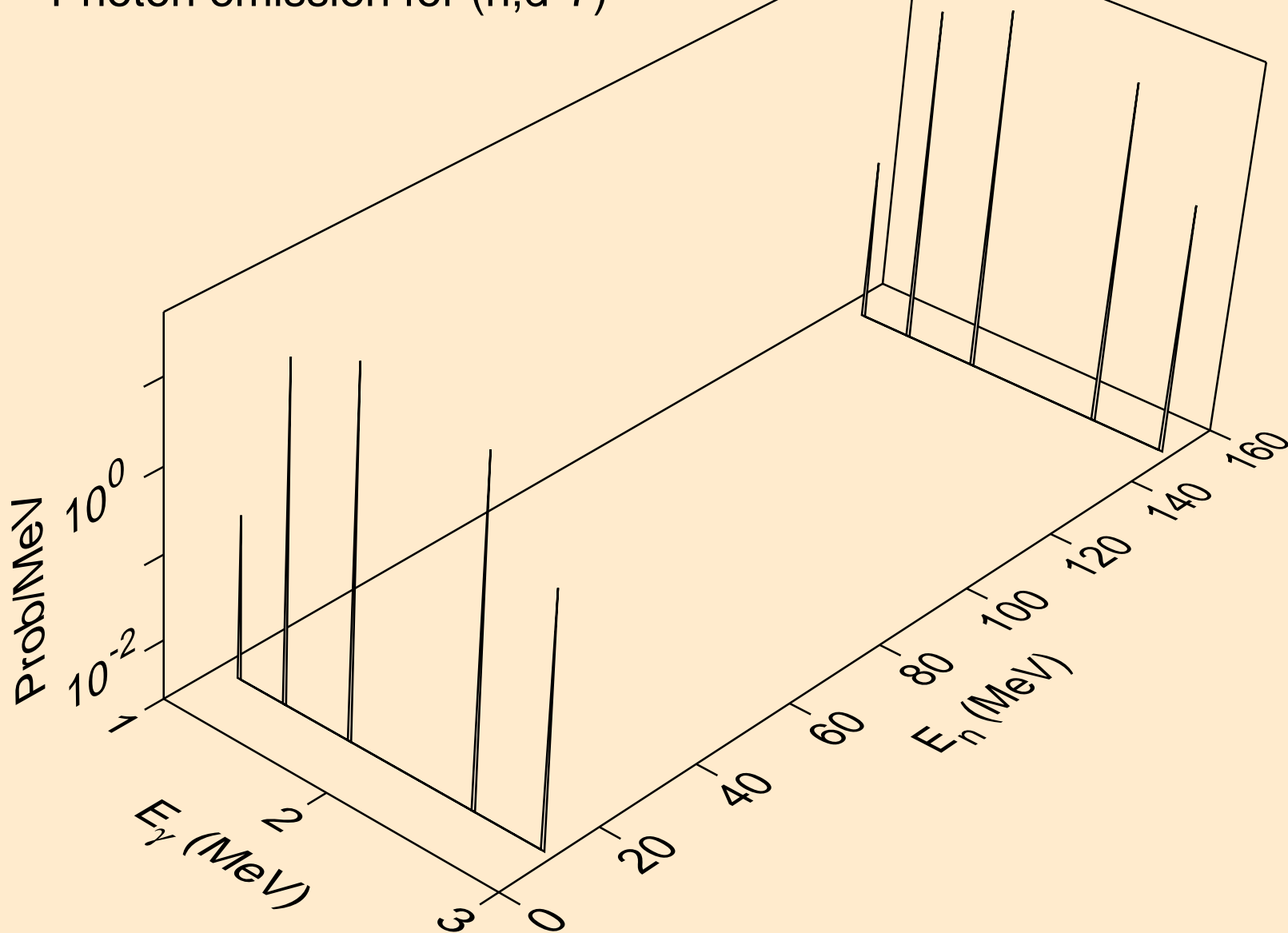

MAT=1325 ACE FILE PRODUCED AT NEA WITH NDEC  
Photon emission for (n,d\*8)

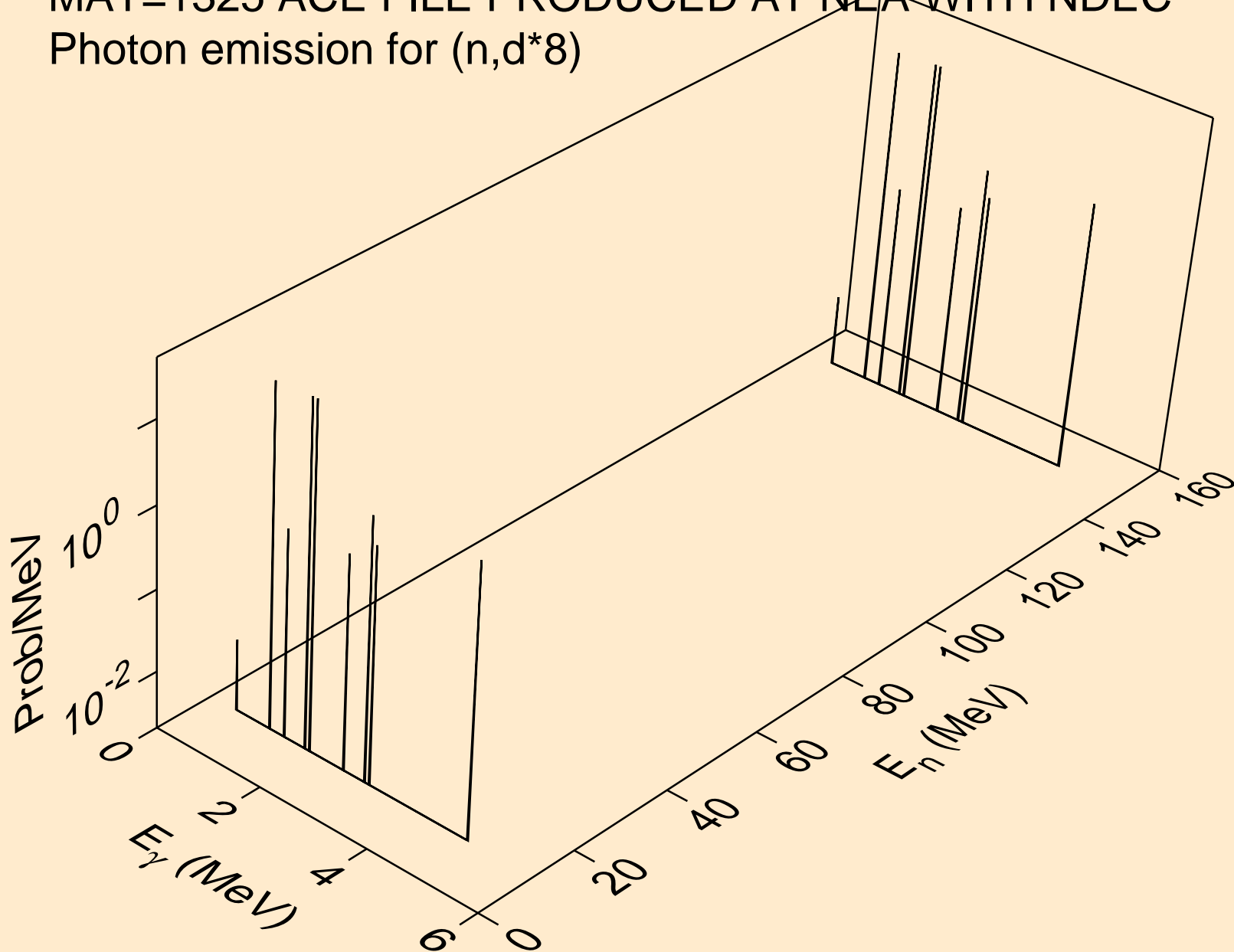

MAT=1325 ACE FILE PRODUCED AT NEA WITH NDEC  
Photon emission for (n,d\*9)

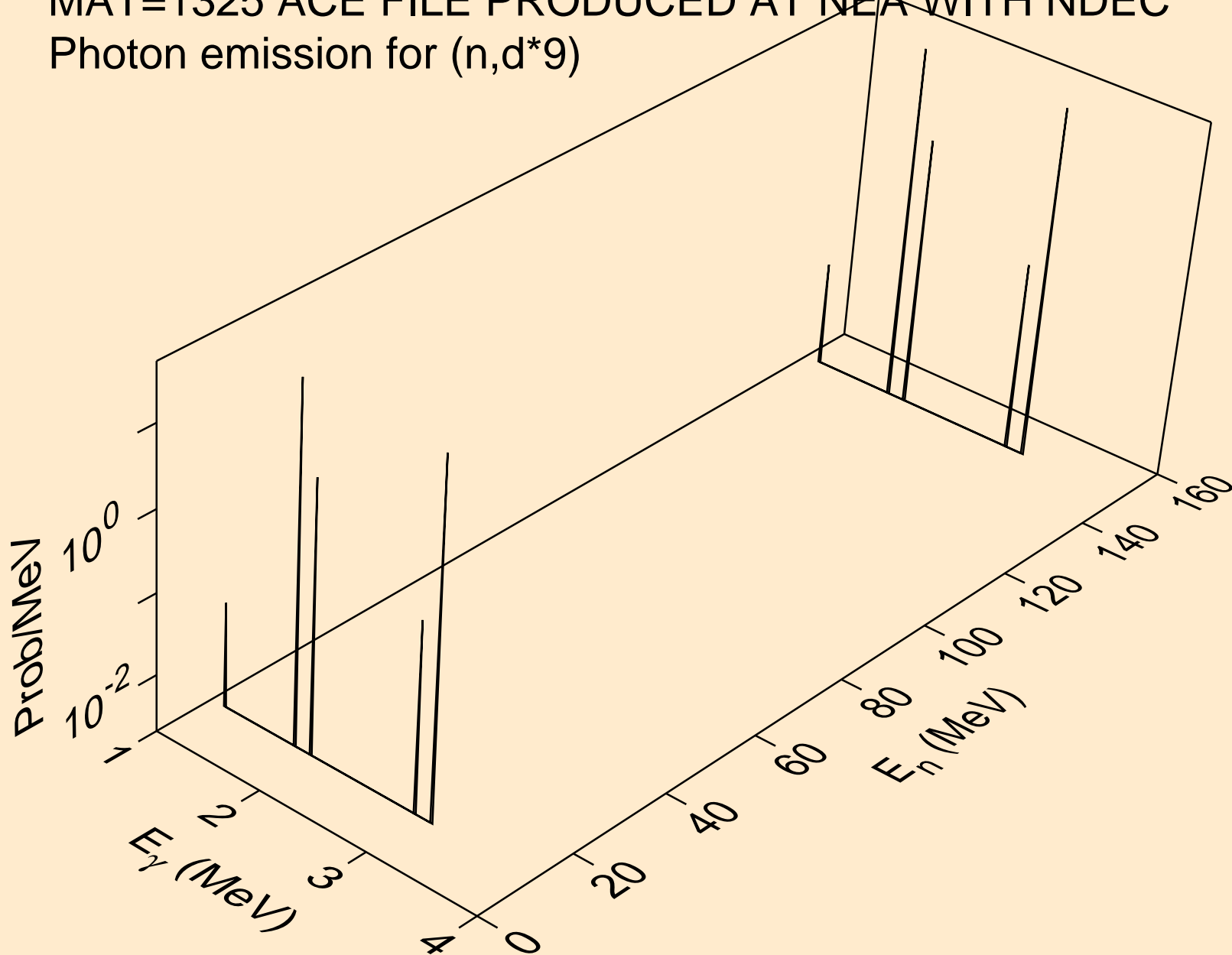

MAT=1325 ACE FILE PRODUCED AT NEA WITH NDEC  
Photon emission for (n,d\*10)

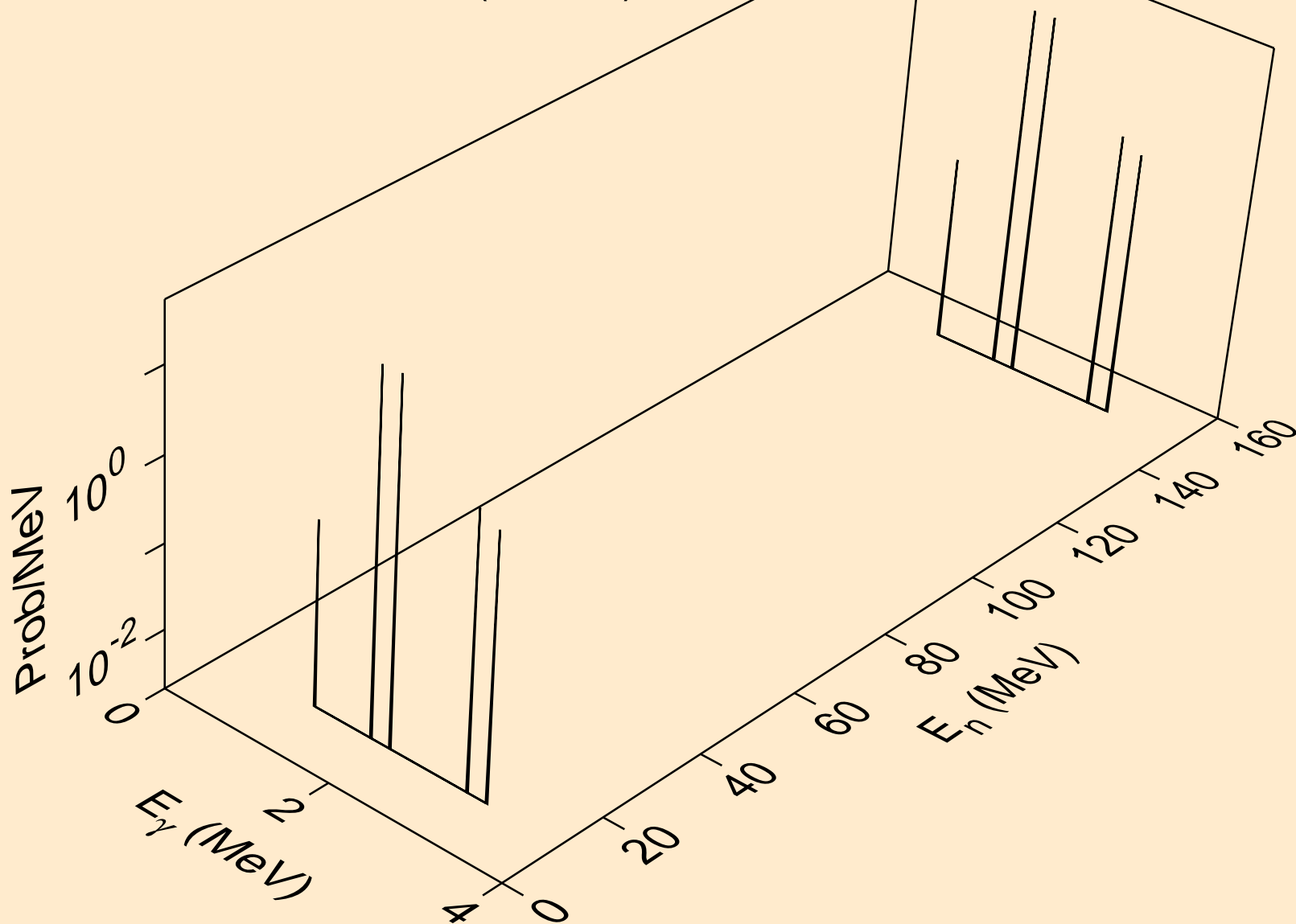

MAT=1325 ACE FILE PRODUCED AT NEA WITH NDEC  
Photon emission for (n,d\*11)

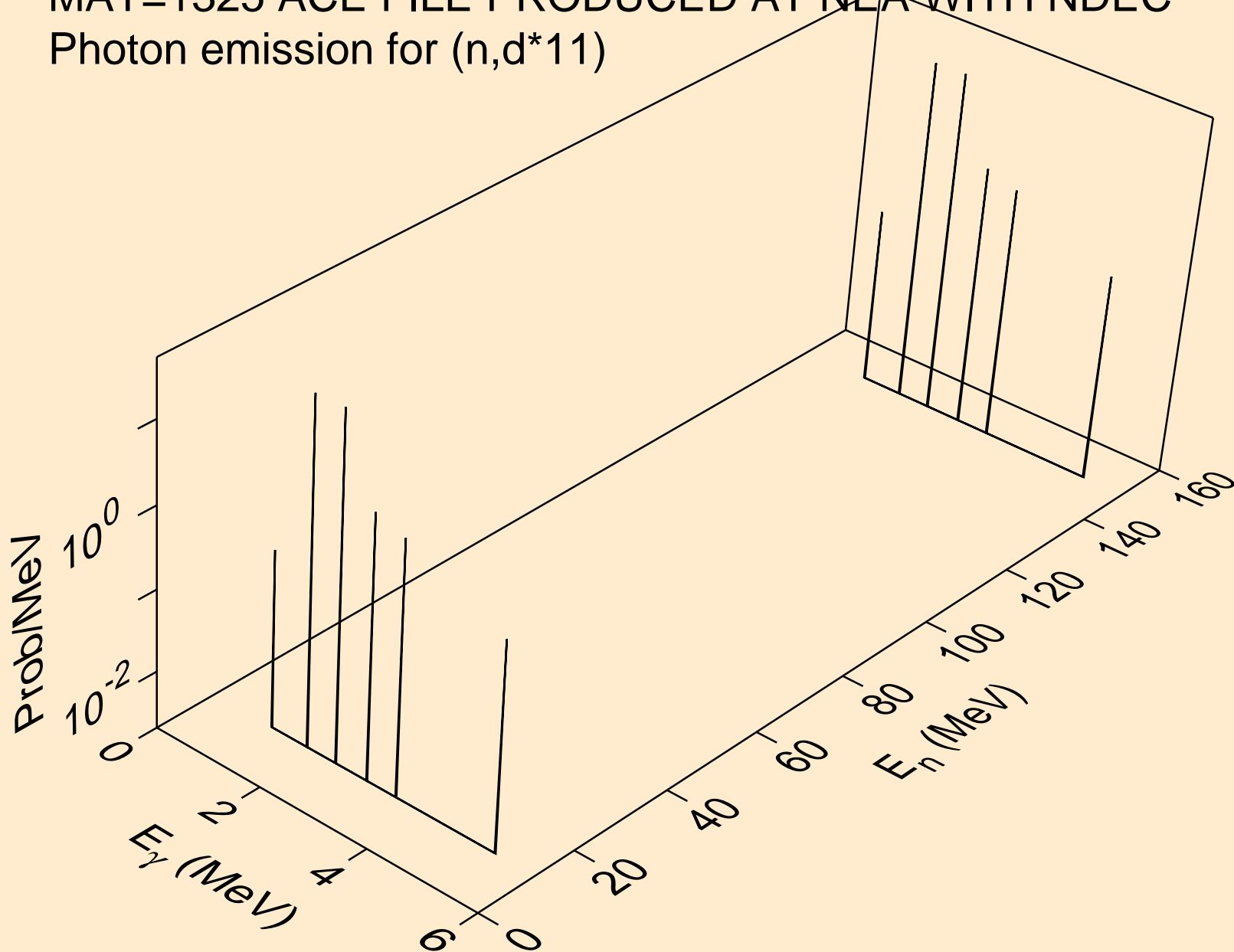

MAT=1325 ACE FILE PRODUCED AT NEA WITH NDEC  
Photon emission for (n,d\*12)

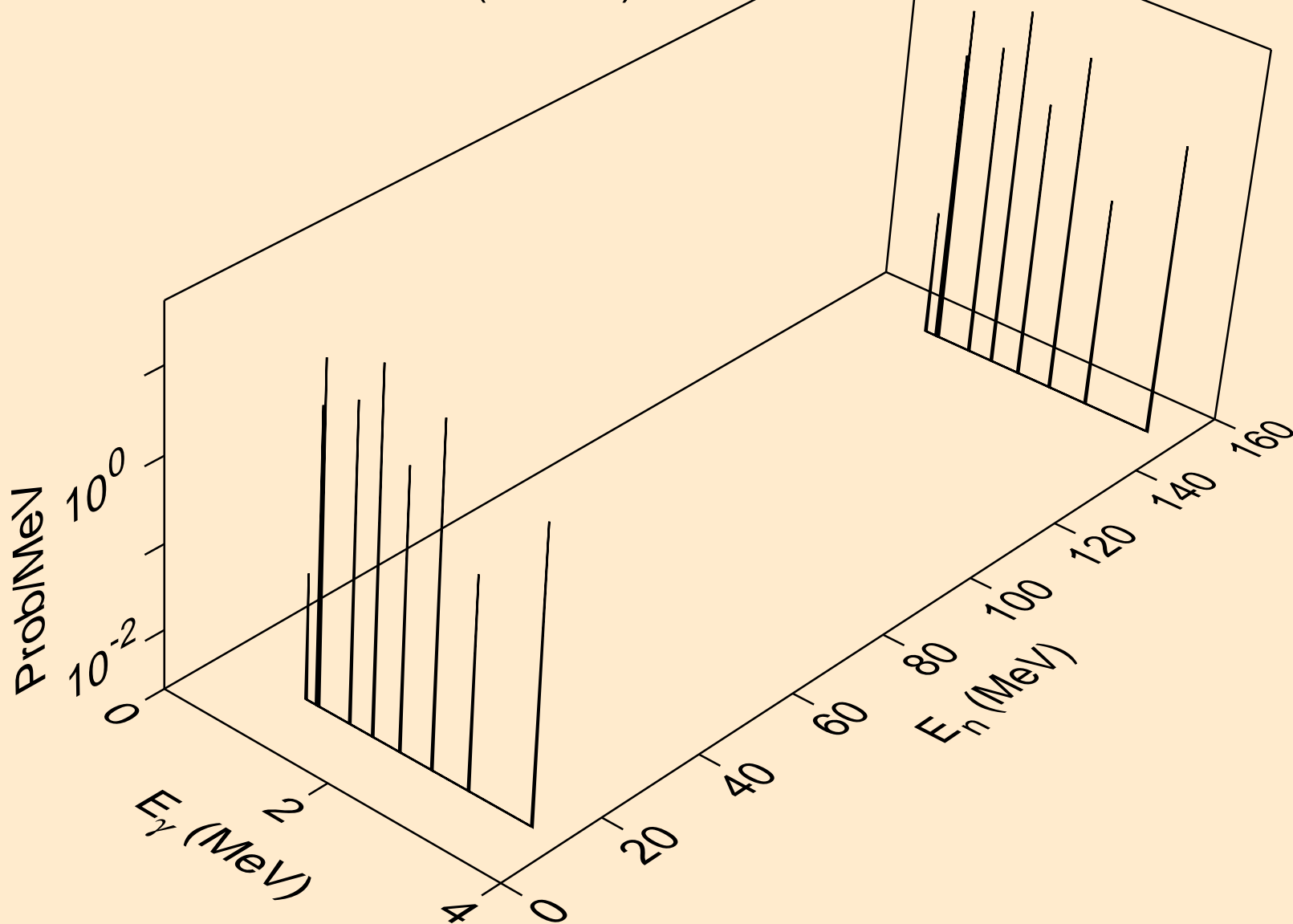



MAT=1325 ACE FILE PRODUCED AT NEA WITH NDEC  
Photon emission for (n,d\*13)

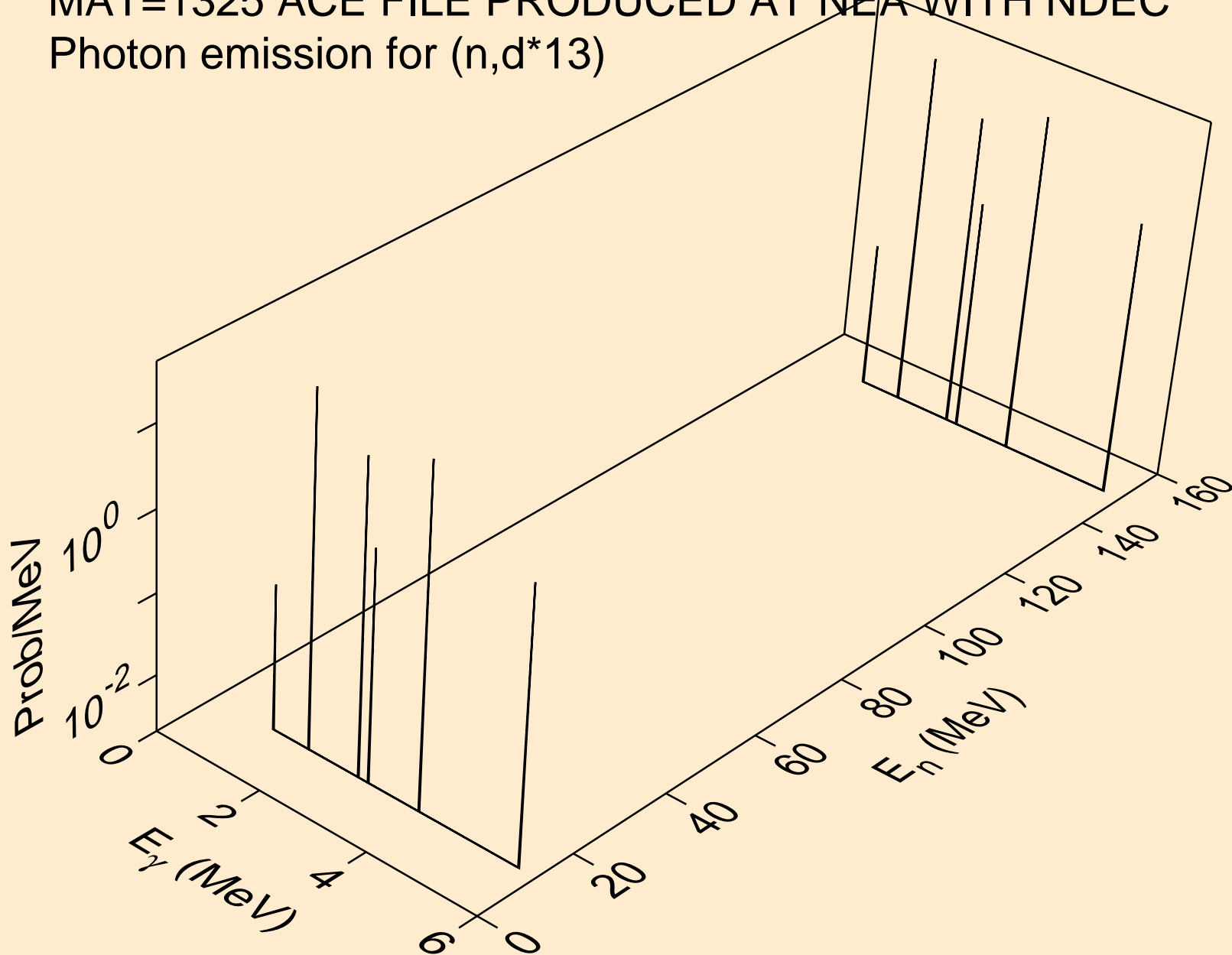

MAT=1325 ACE FILE PRODUCED AT NEA WITH NDEC  
Photon emission for (n,d\*14)

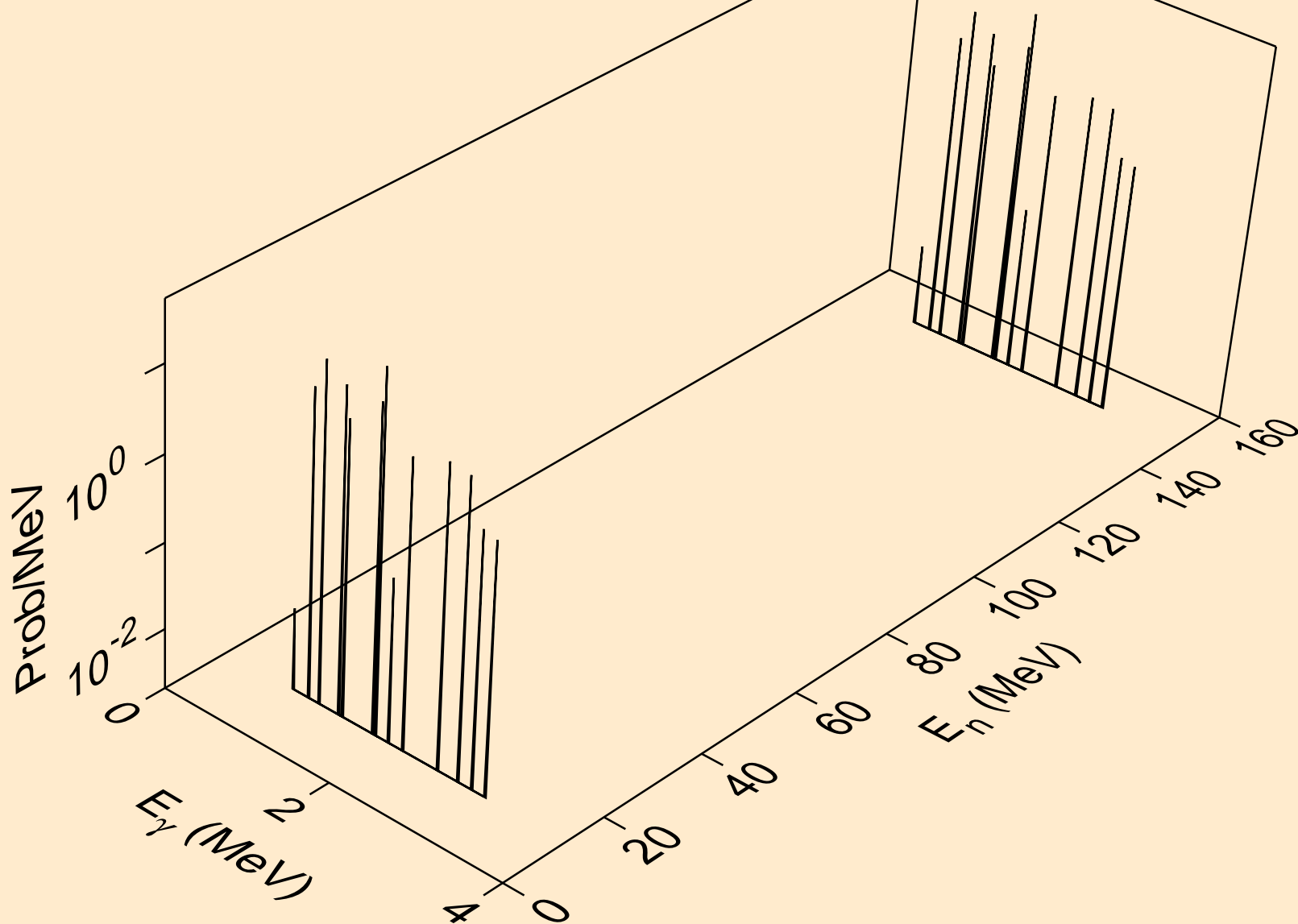

MAT=1325 ACE FILE PRODUCED AT NEA WITH NDEC  
Photon emission for (n,d\*15)

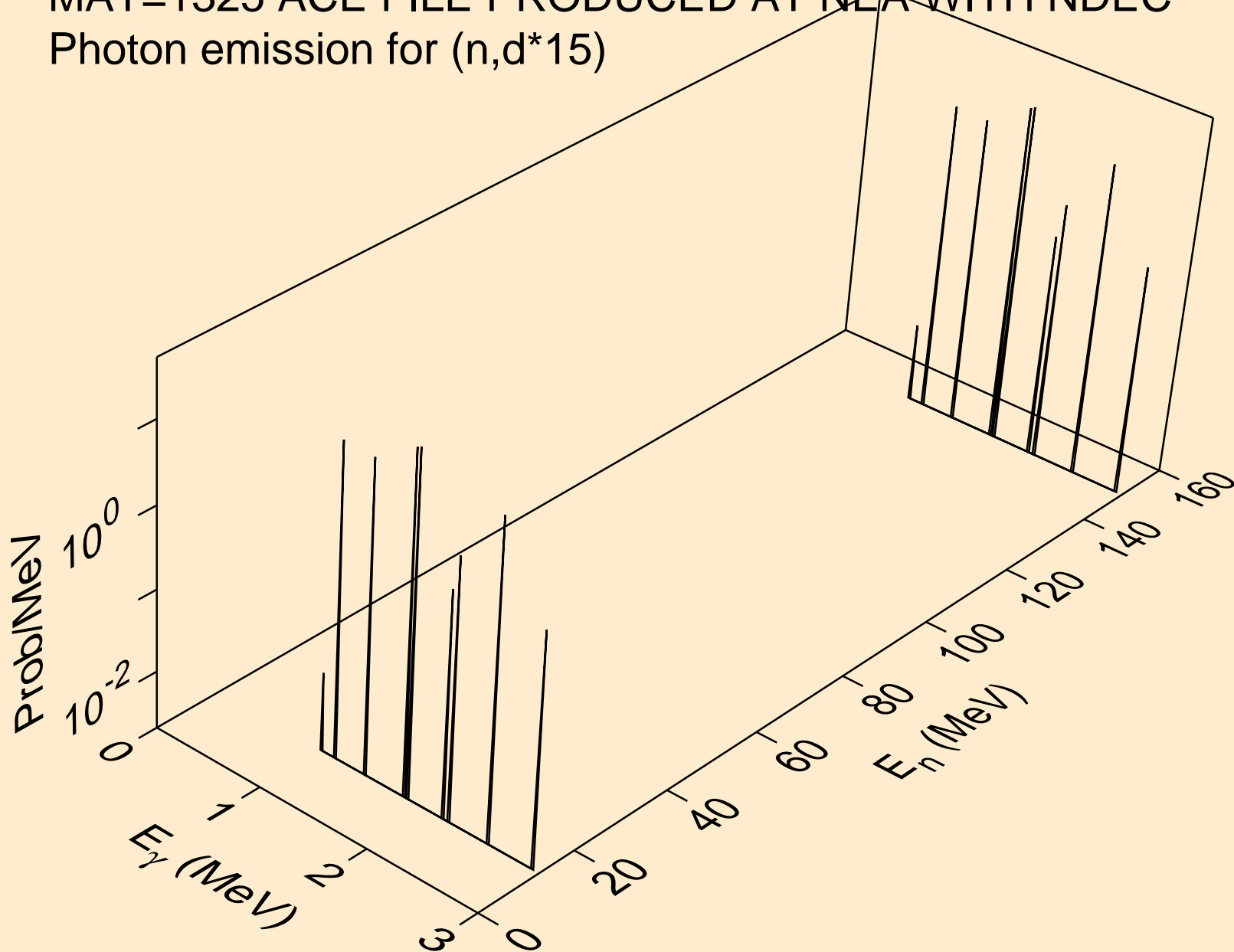

MAT=1325 ACE FILE PRODUCED AT NEA WITH NDEC  
Photon emission for (n,d\*16)

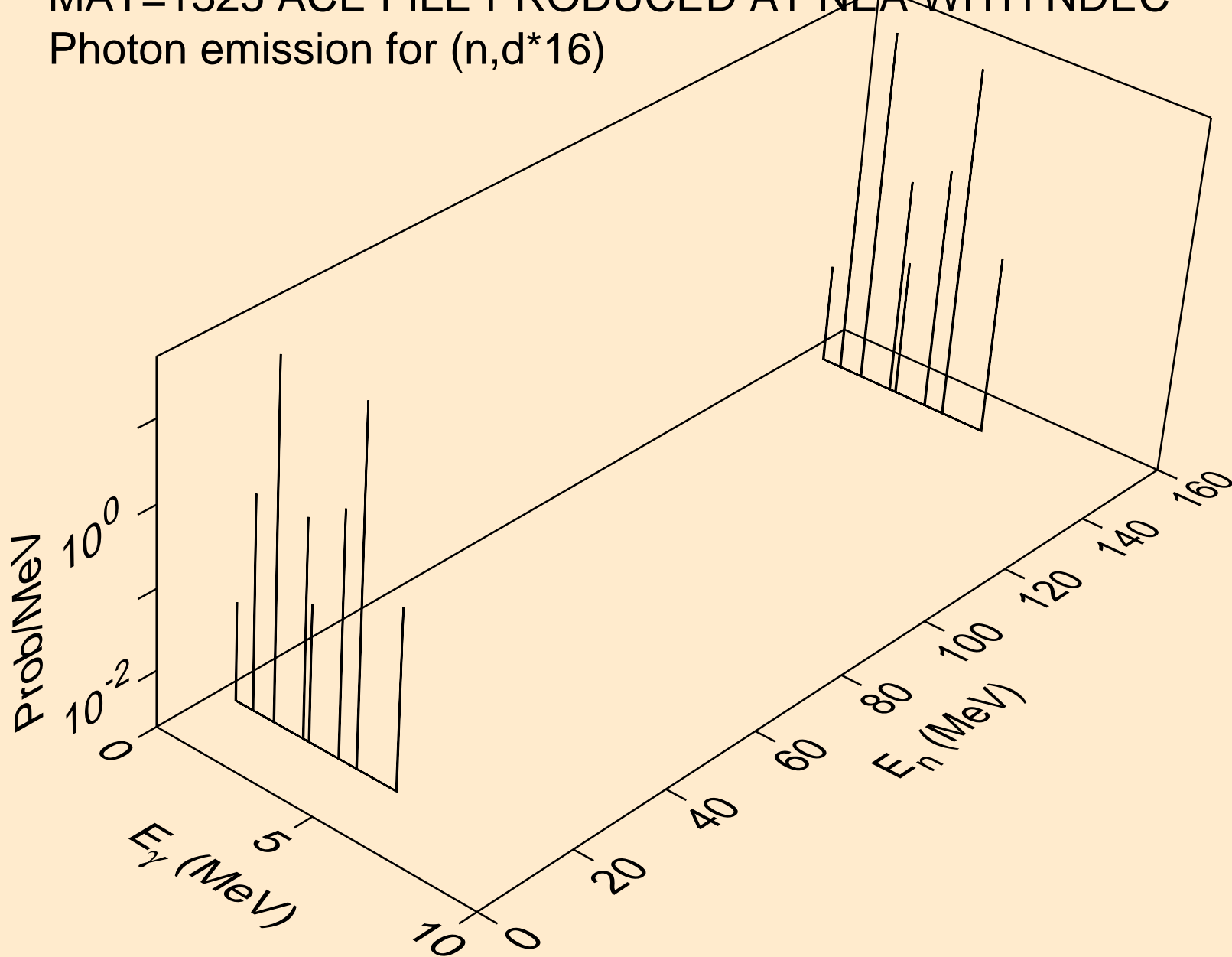

MAT=1325 ACE FILE PRODUCED AT NEA WITH NDEC  
Photon emission for (n,d\*17)

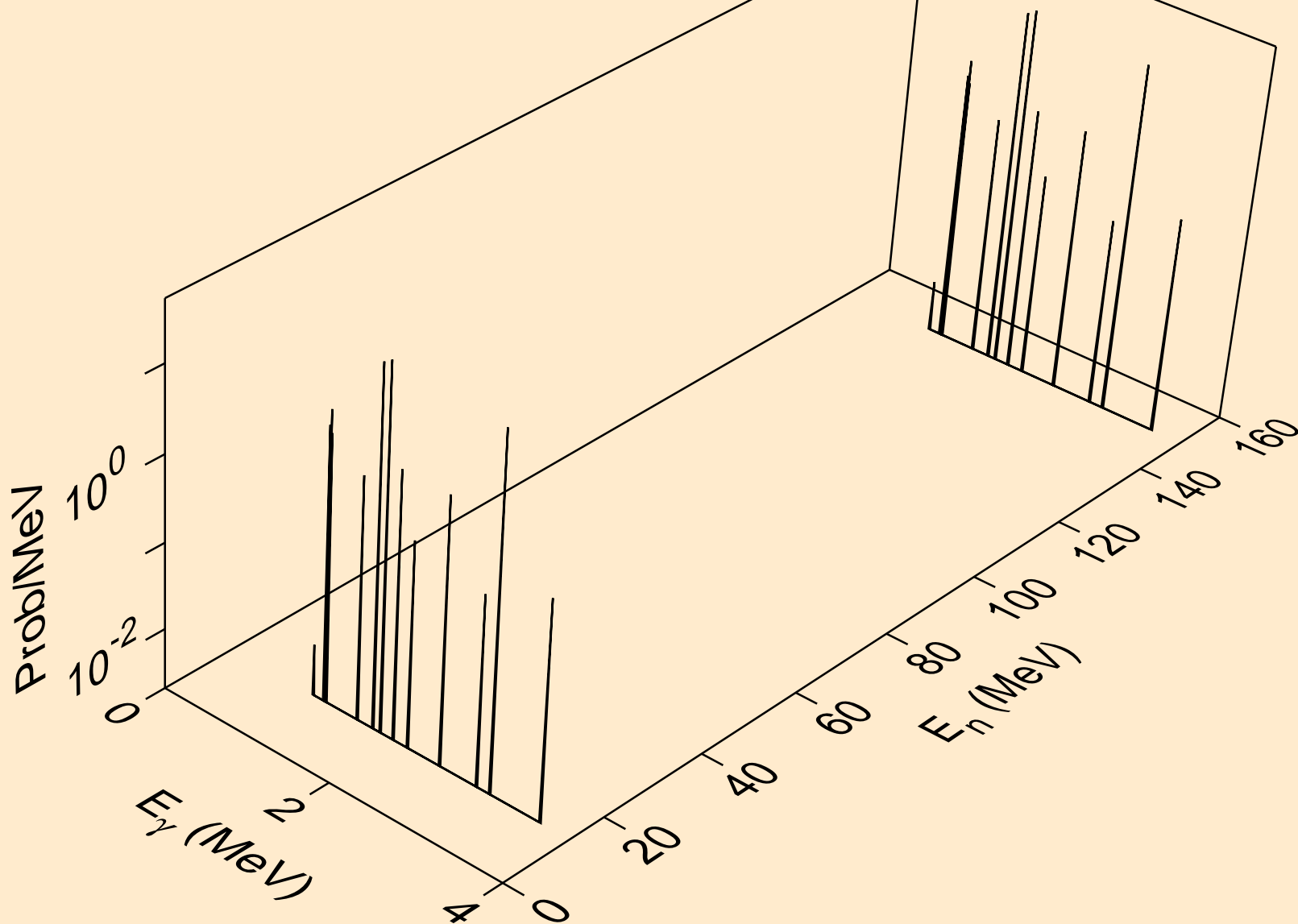

MAT=1325 ACE FILE PRODUCED AT NEA WITH NDEC  
Photon emission for (n,d\*18)

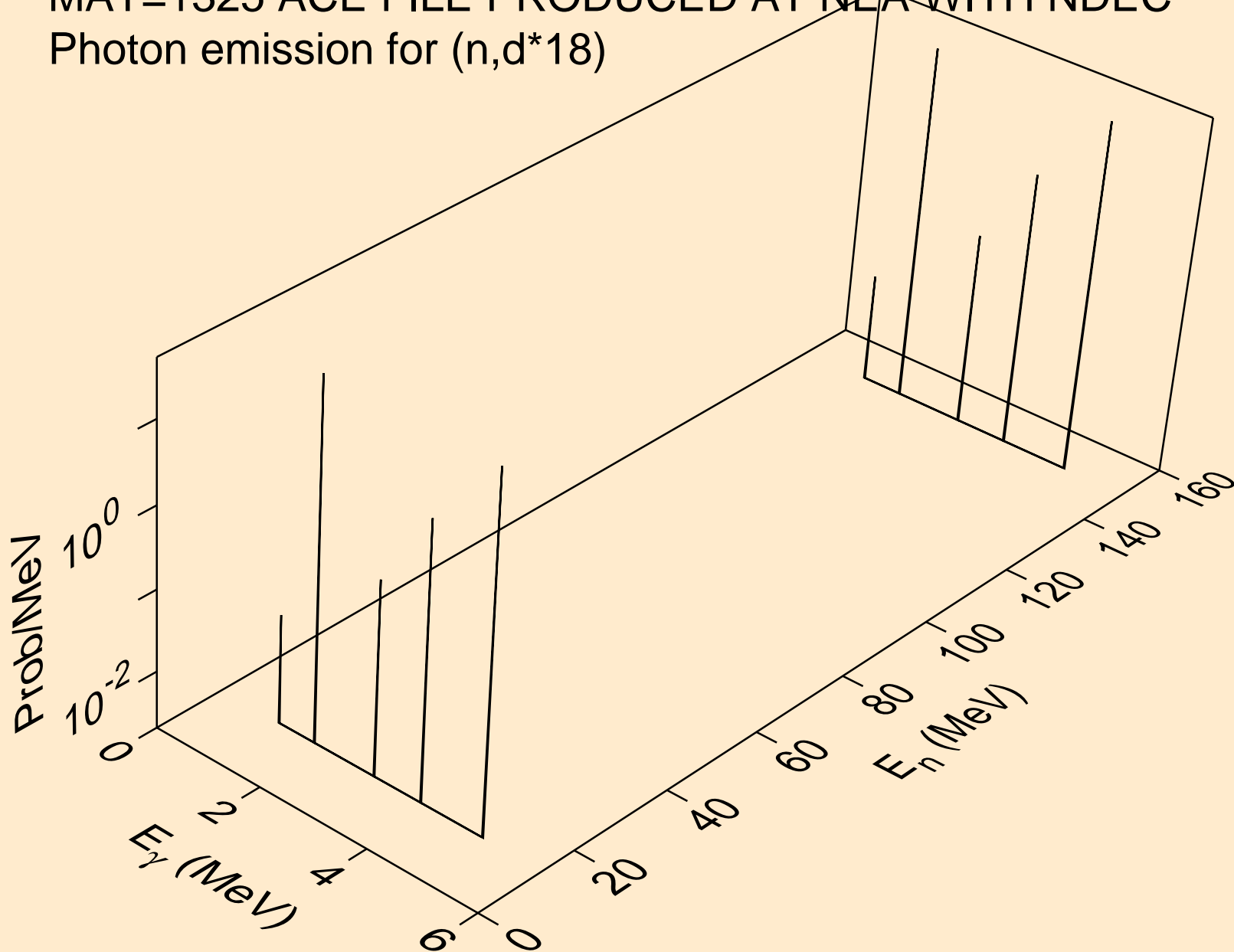

MAT=1325 ACE FILE PRODUCED AT NEA WITH NDEC  
Photon emission for (n,d\*19)

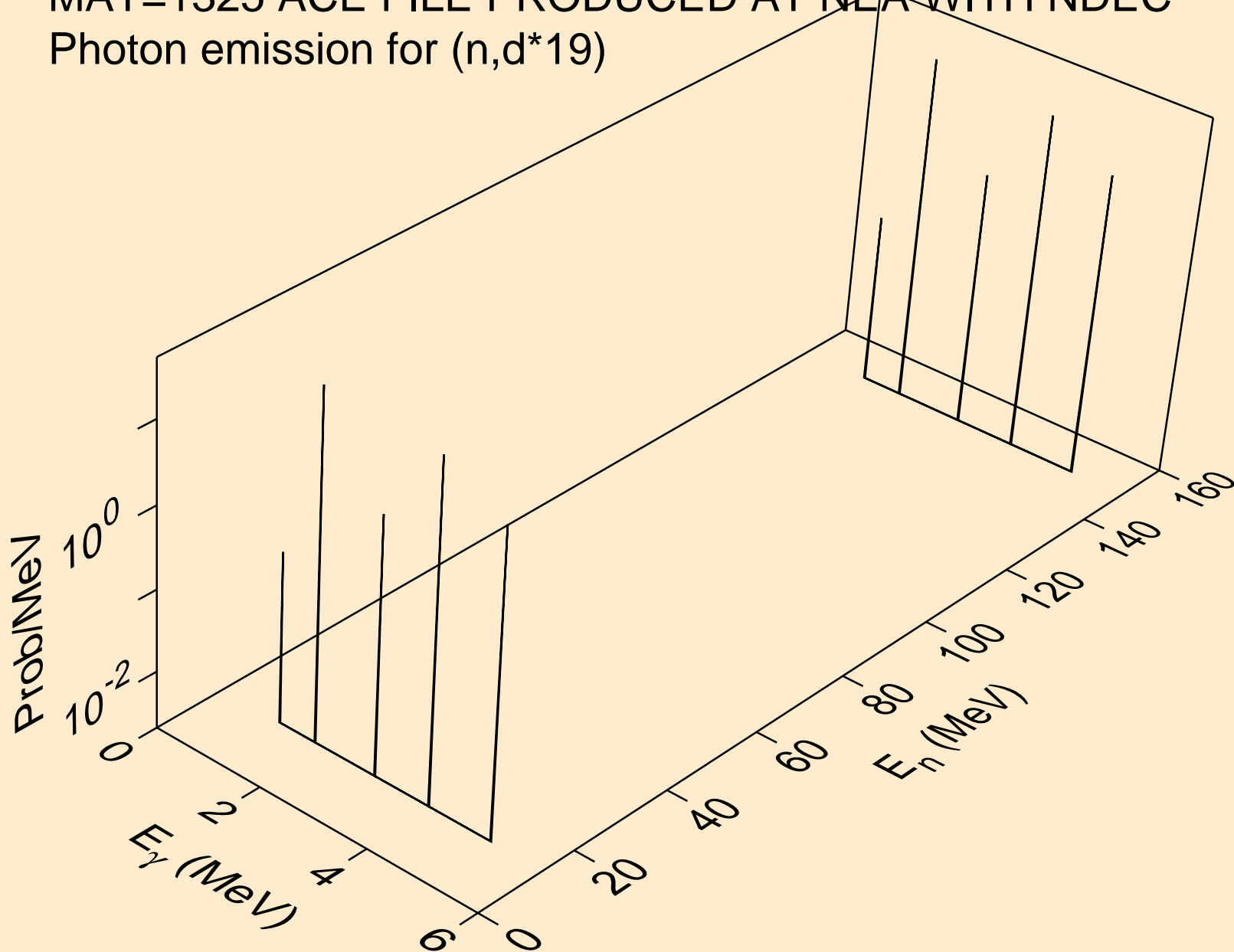

MAT=1325 ACE FILE PRODUCED AT NEA WITH NDEC  
Photon emission for (n,d\*c)

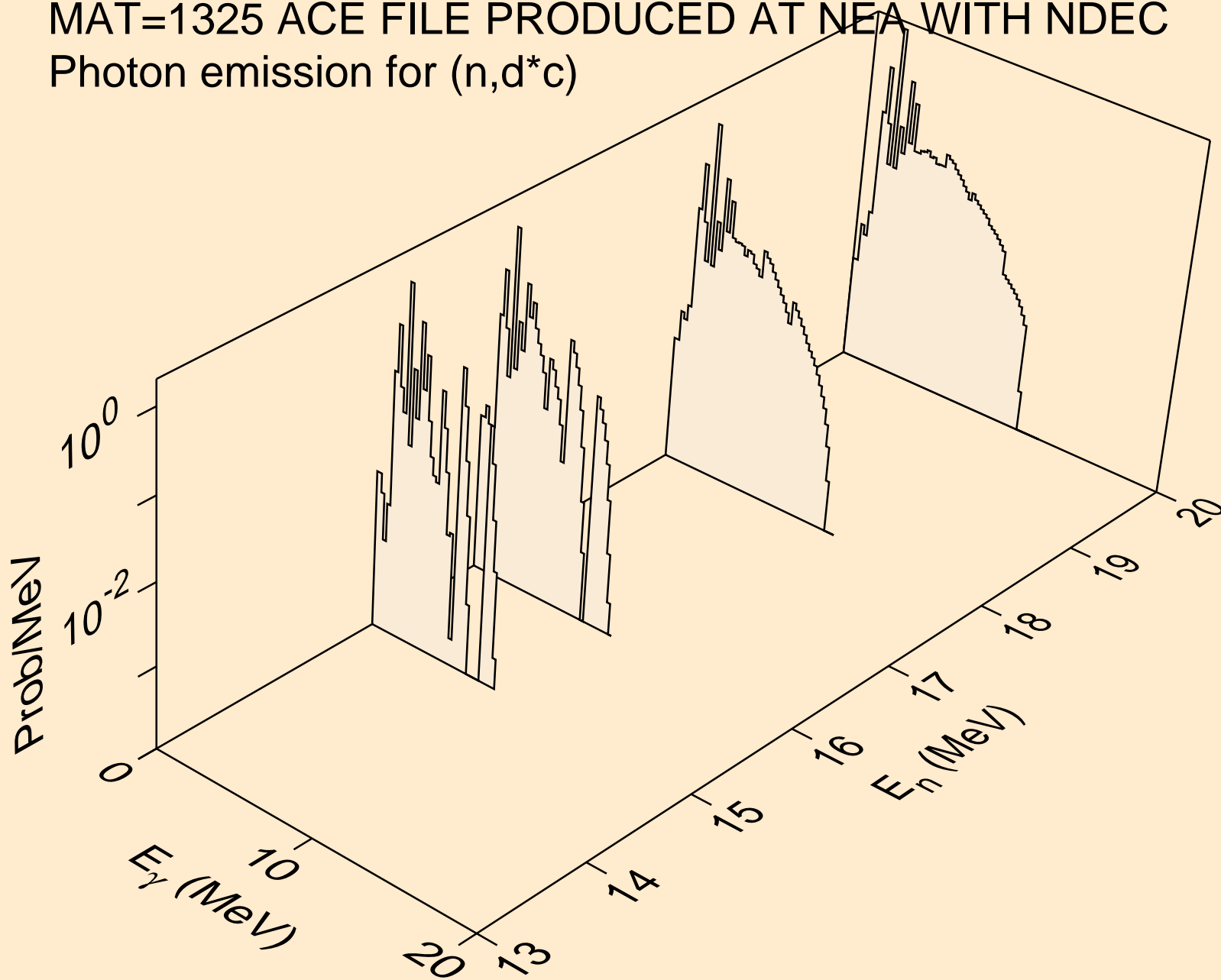



MAT=1325 ACE FILE PRODUCED AT NEA WITH NDEC  
Photon emission for (n,t\*1)

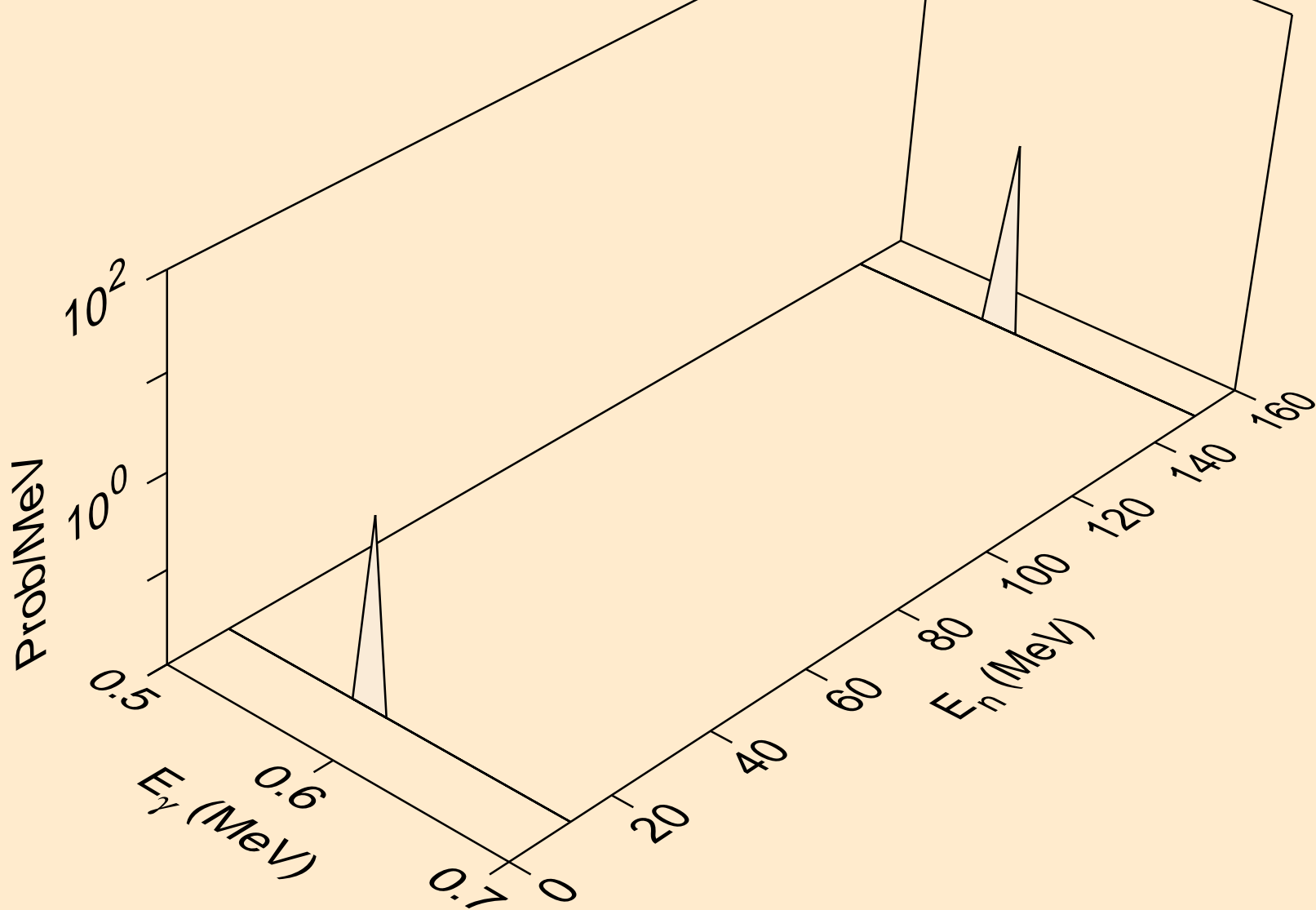

MAT=1325 ACE FILE PRODUCED AT NEA WITH NDEC  
Photon emission for (n,t\*2)

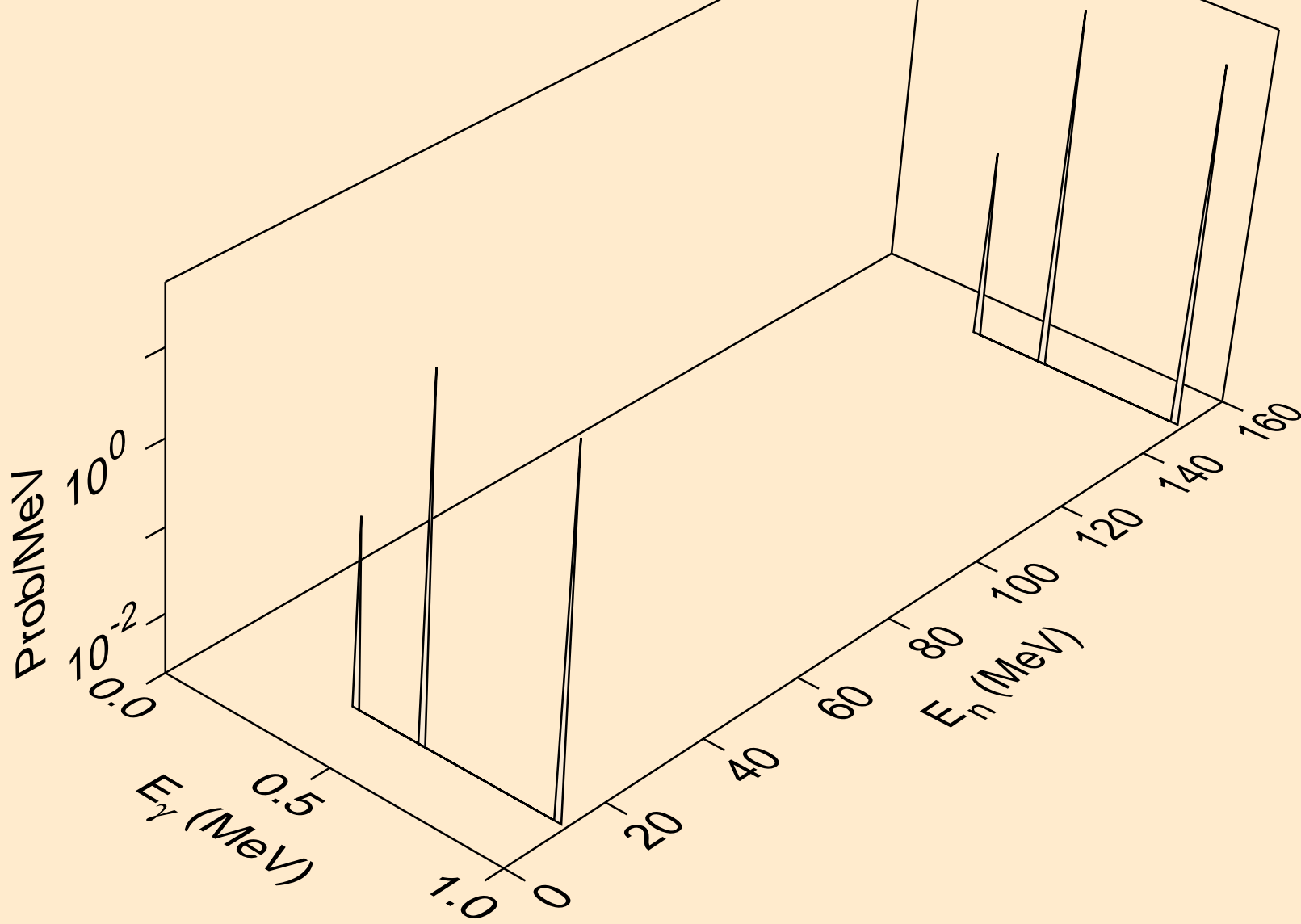

MAT=1325 ACE FILE PRODUCED AT NEA WITH NDEC  
Photon emission for (n,t\*3)

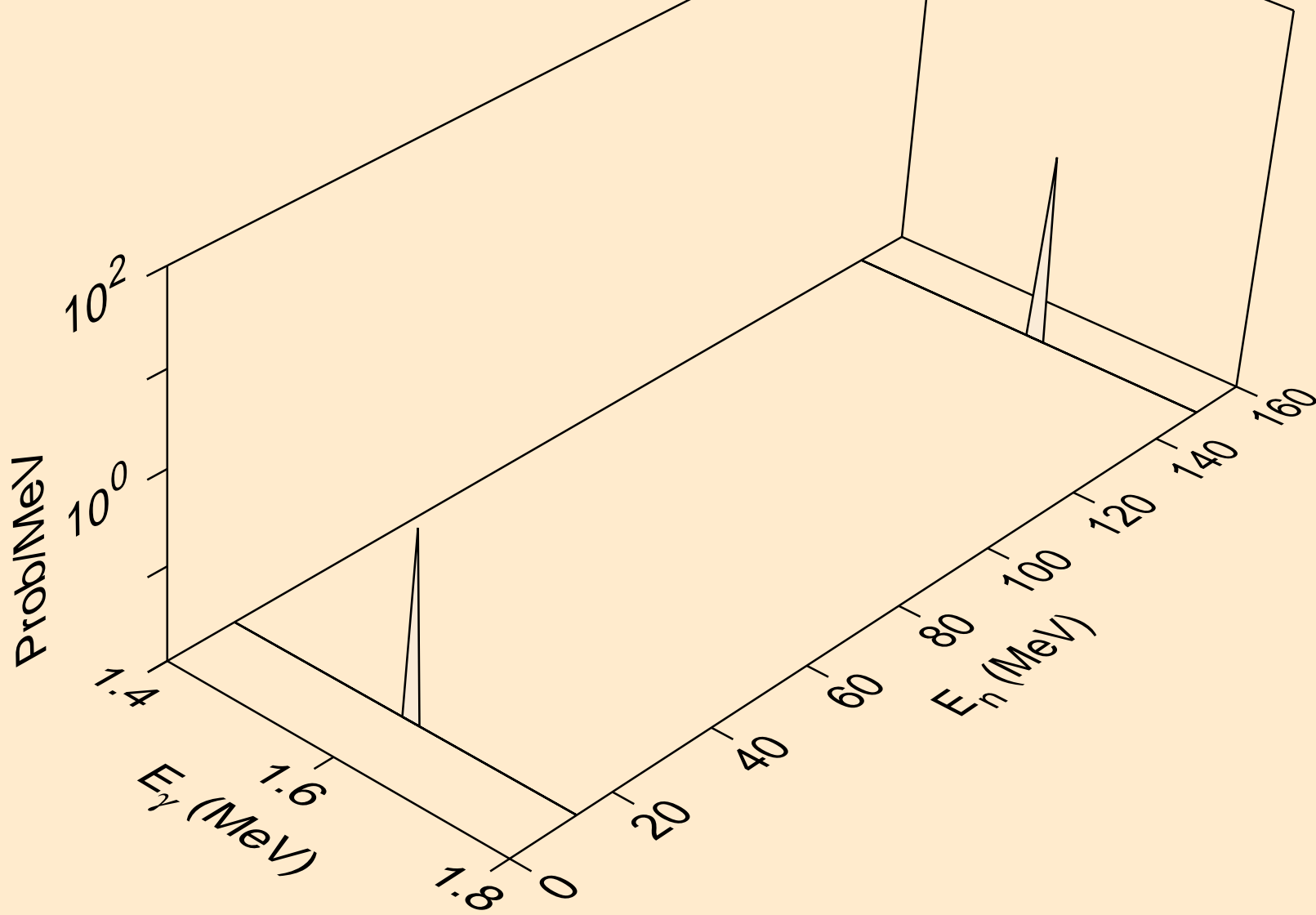

MAT=1325 ACE FILE PRODUCED AT NEA WITH NDEC  
Photon emission for (n,t\*4)

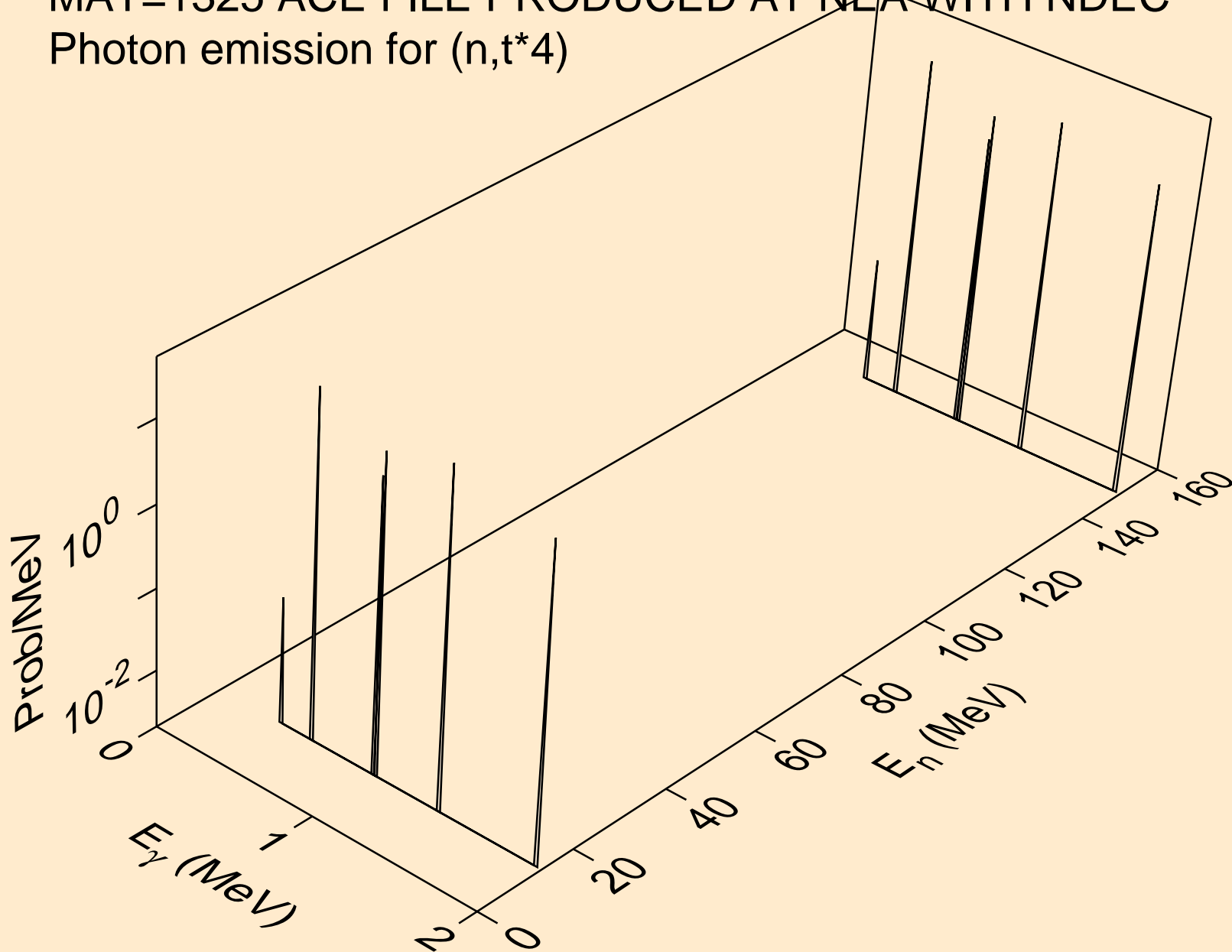

MAT=1325 ACE FILE PRODUCED AT NEA WITH NDEC  
Photon emission for (n,t\*5)

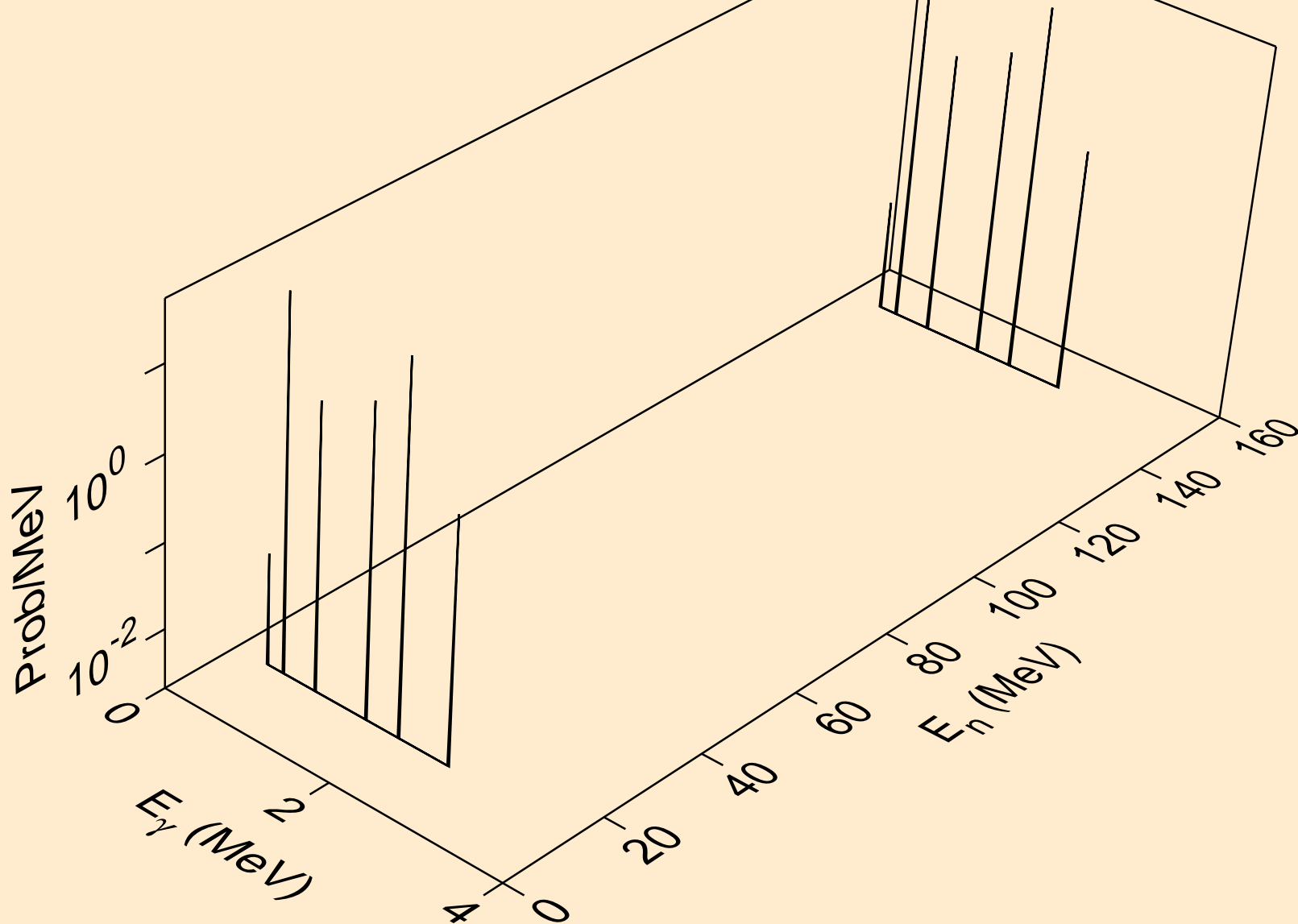

MAT=1325 ACE FILE PRODUCED AT NEA WITH NDEC  
Photon emission for (n,t\*6)

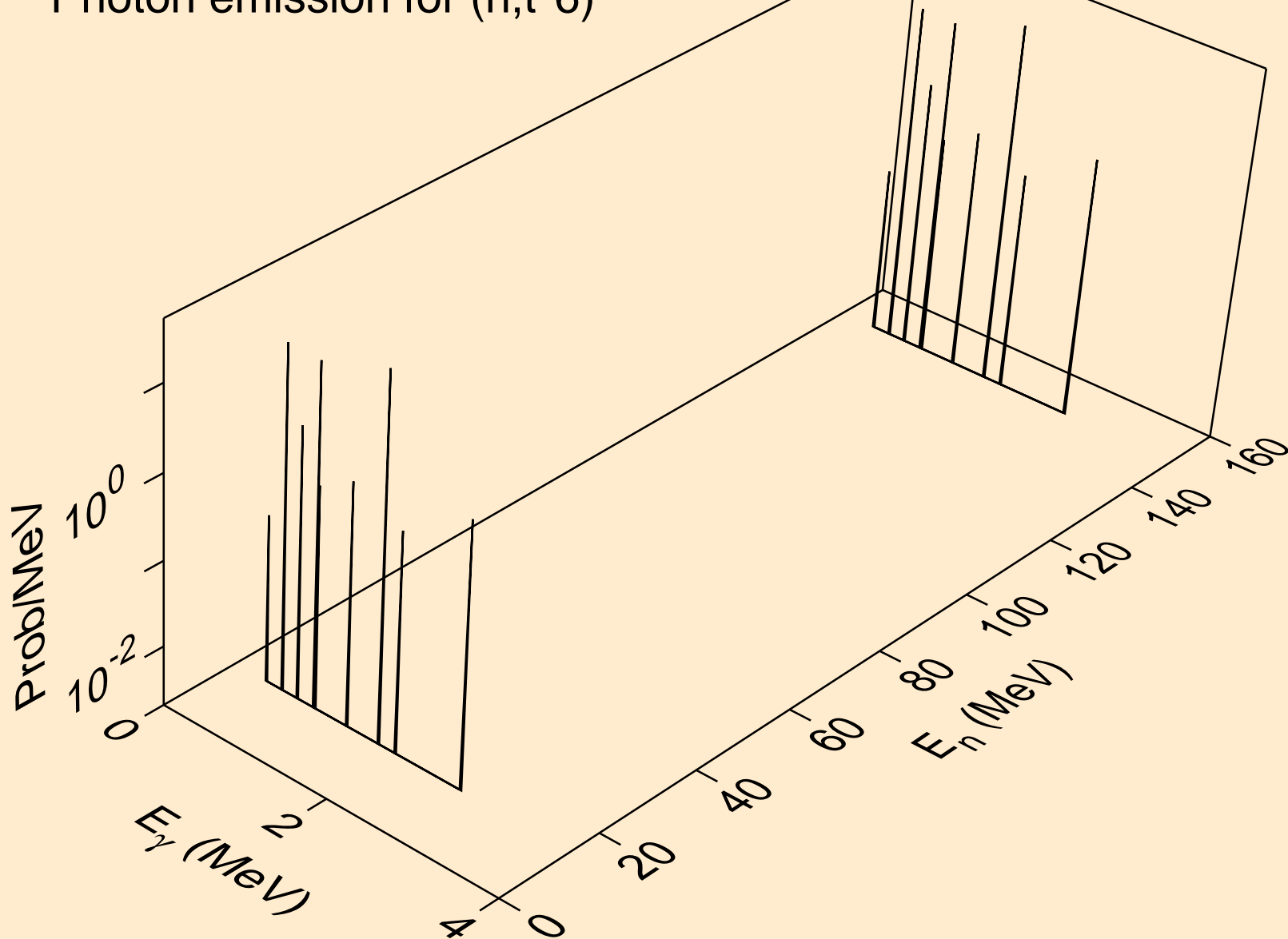

MAT=1325 ACE FILE PRODUCED AT NEA WITH NDEC  
Photon emission for (n,t\*7)

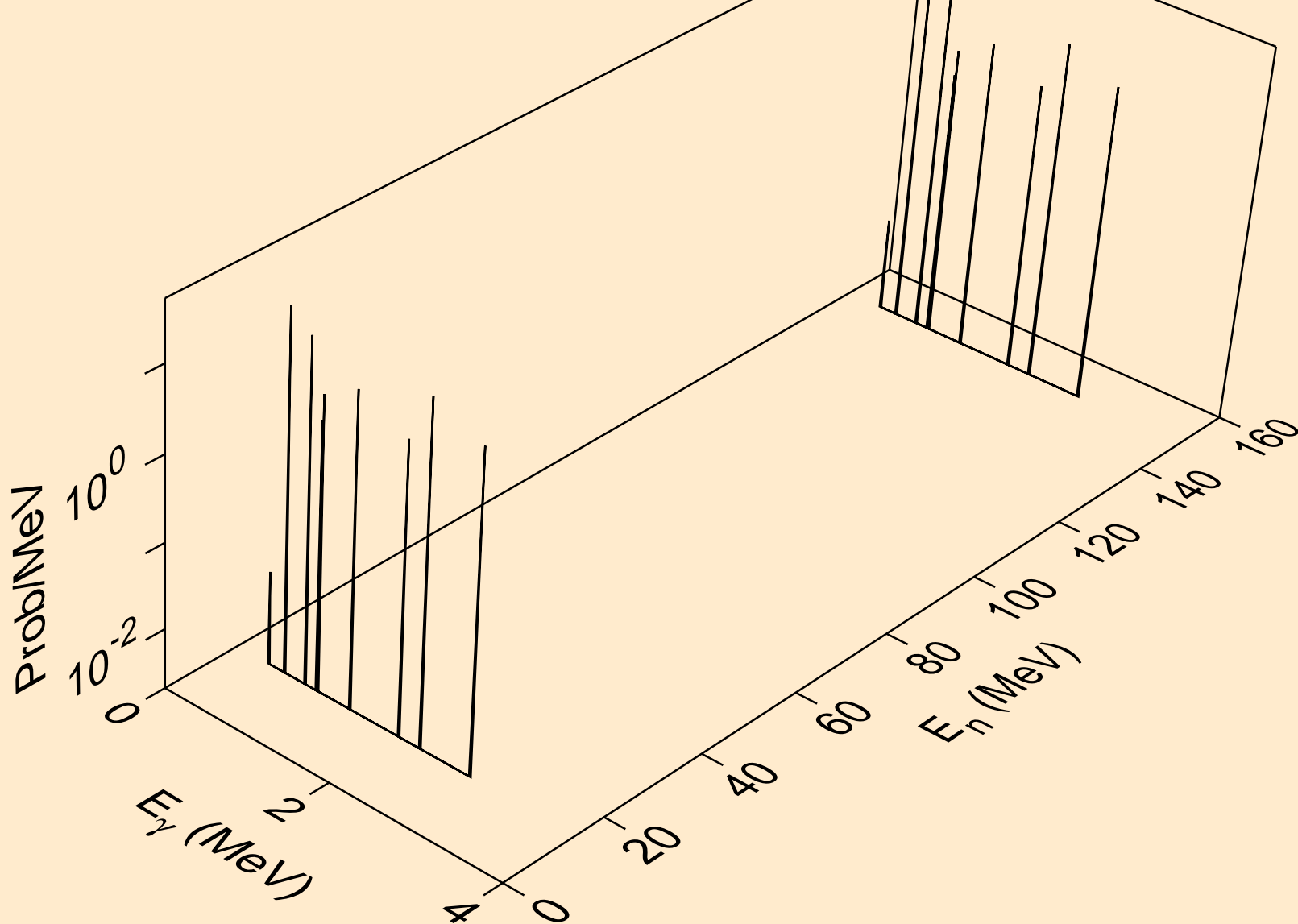

MAT=1325 ACE FILE PRODUCED AT NEA WITH NDEC  
Photon emission for (n,t\*8)

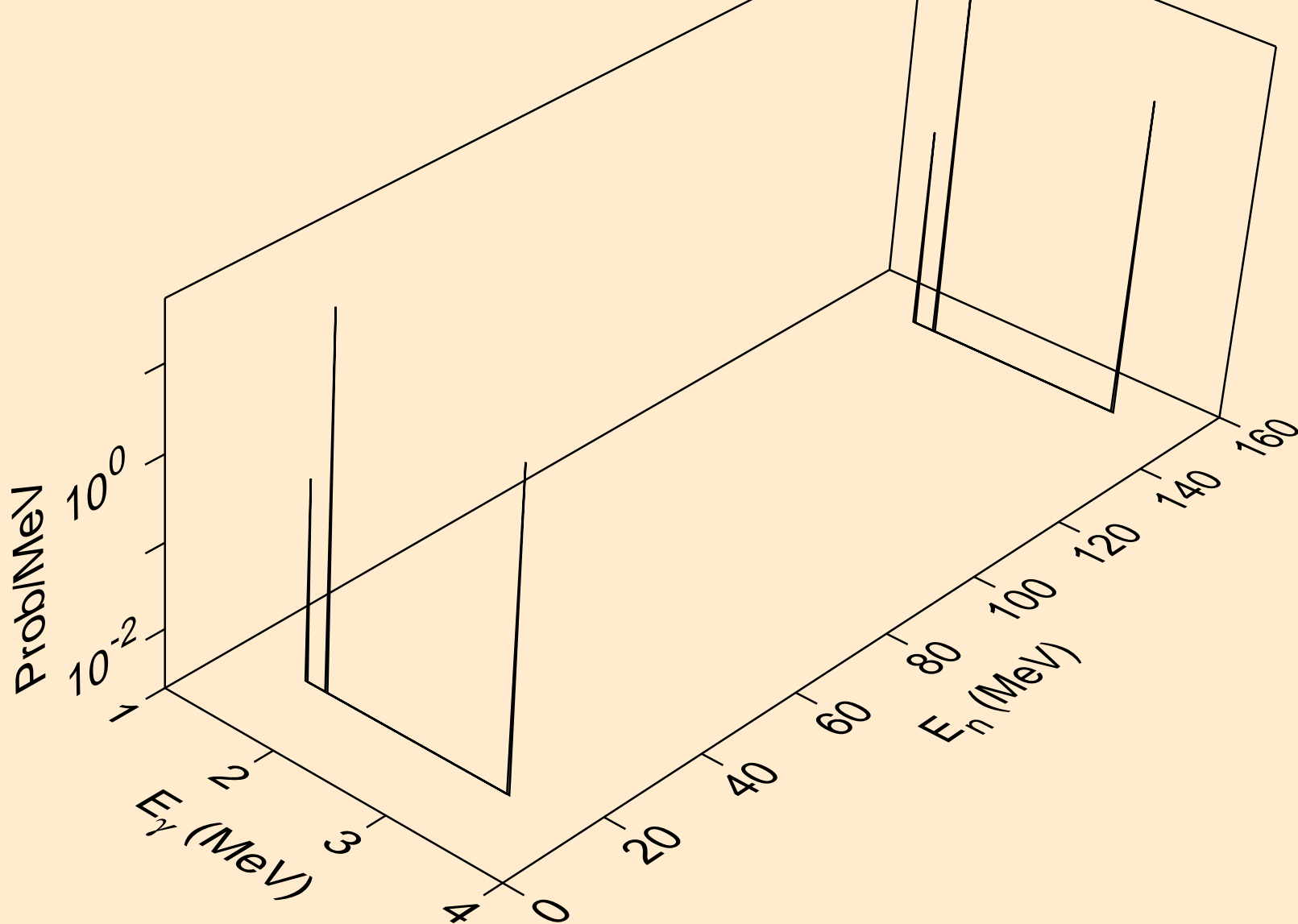



MAT=1325 ACE FILE PRODUCED AT NEA WITH NDEC  
Photon emission for (n,t\*9)

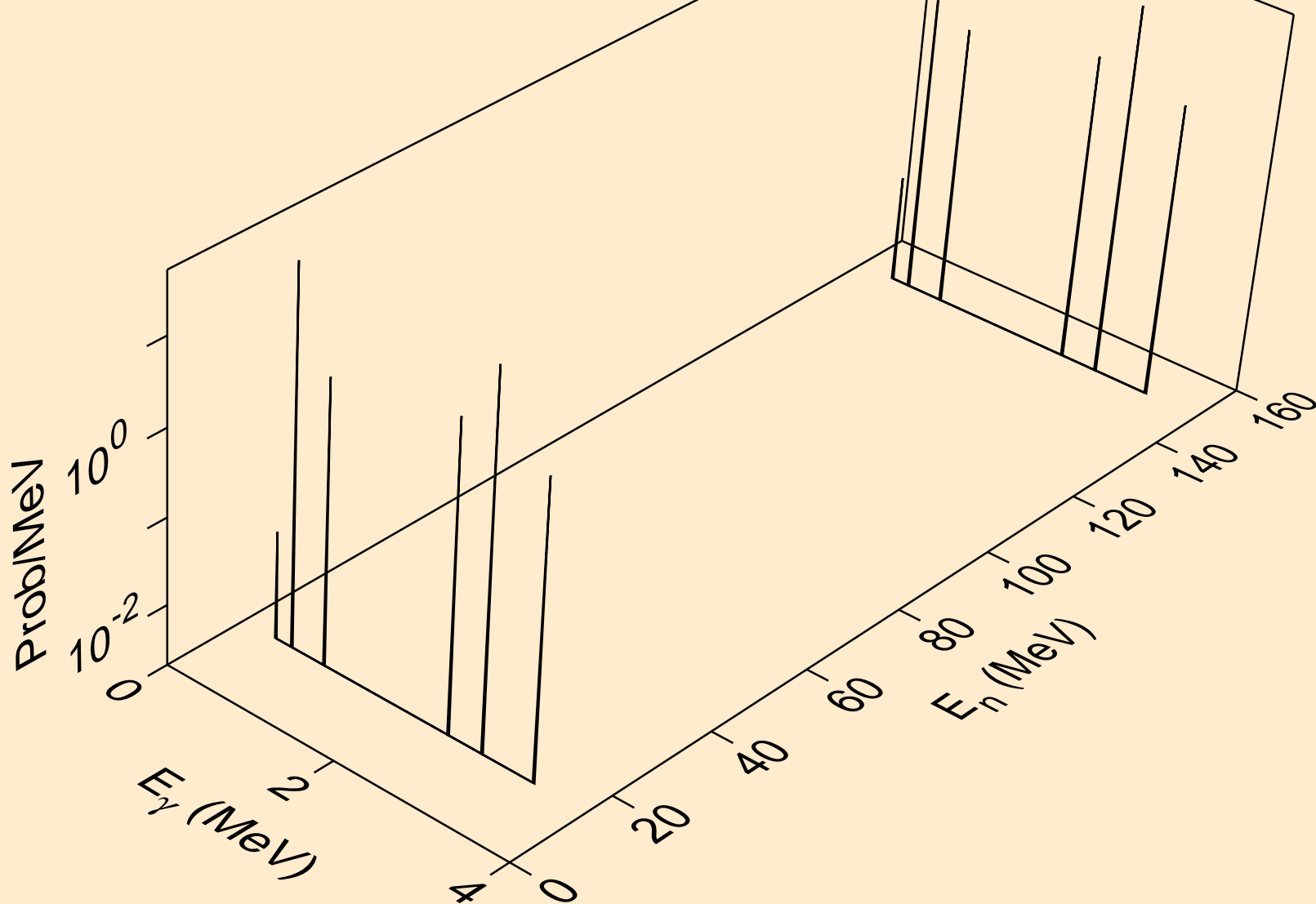

MAT=1325 ACE FILE PRODUCED AT NEA WITH NDEC  
Photon emission for (n,t\*10)

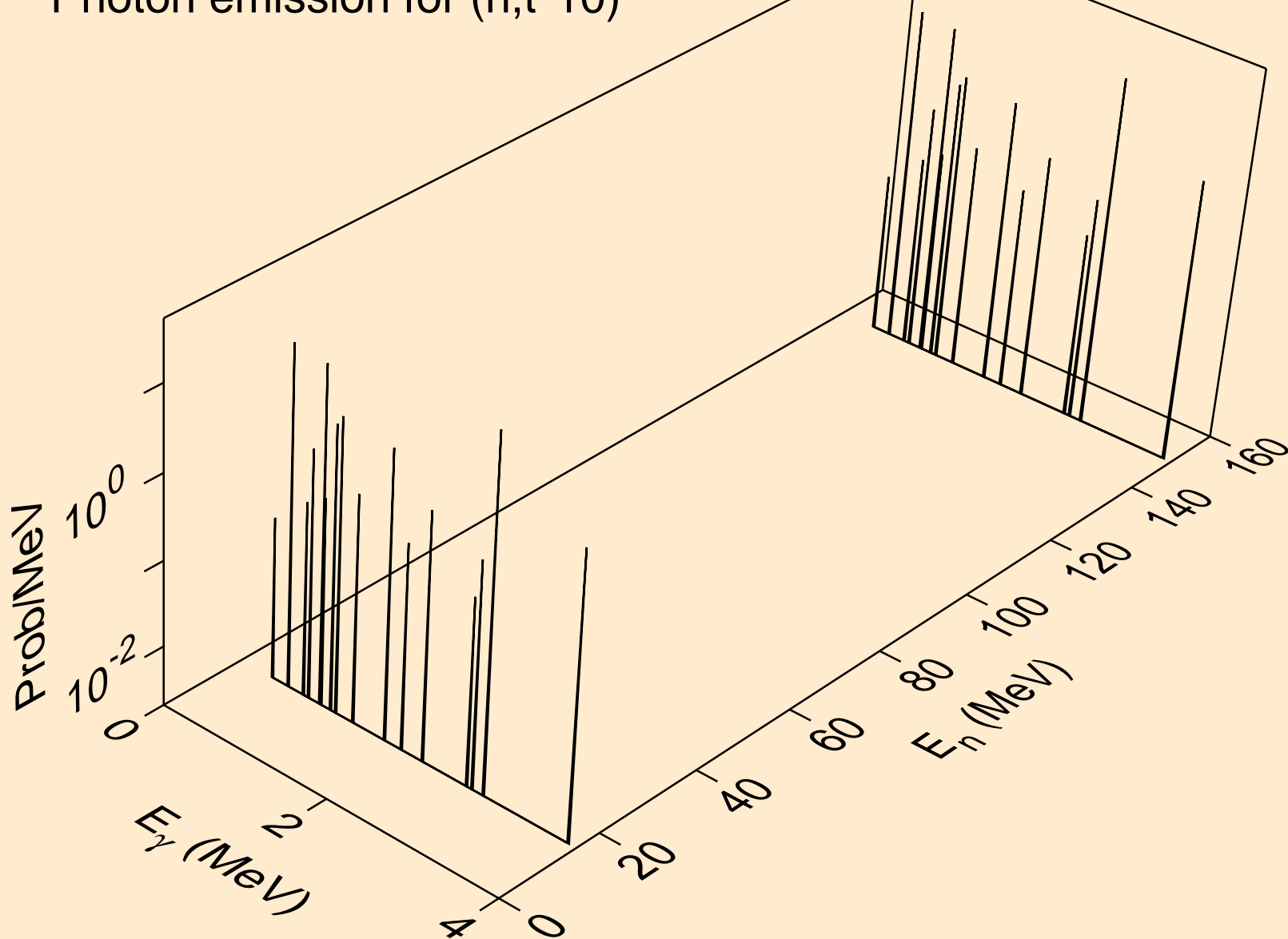

MAT=1325 ACE FILE PRODUCED AT NEA WITH NDEC  
Photon emission for (n,t\*c)

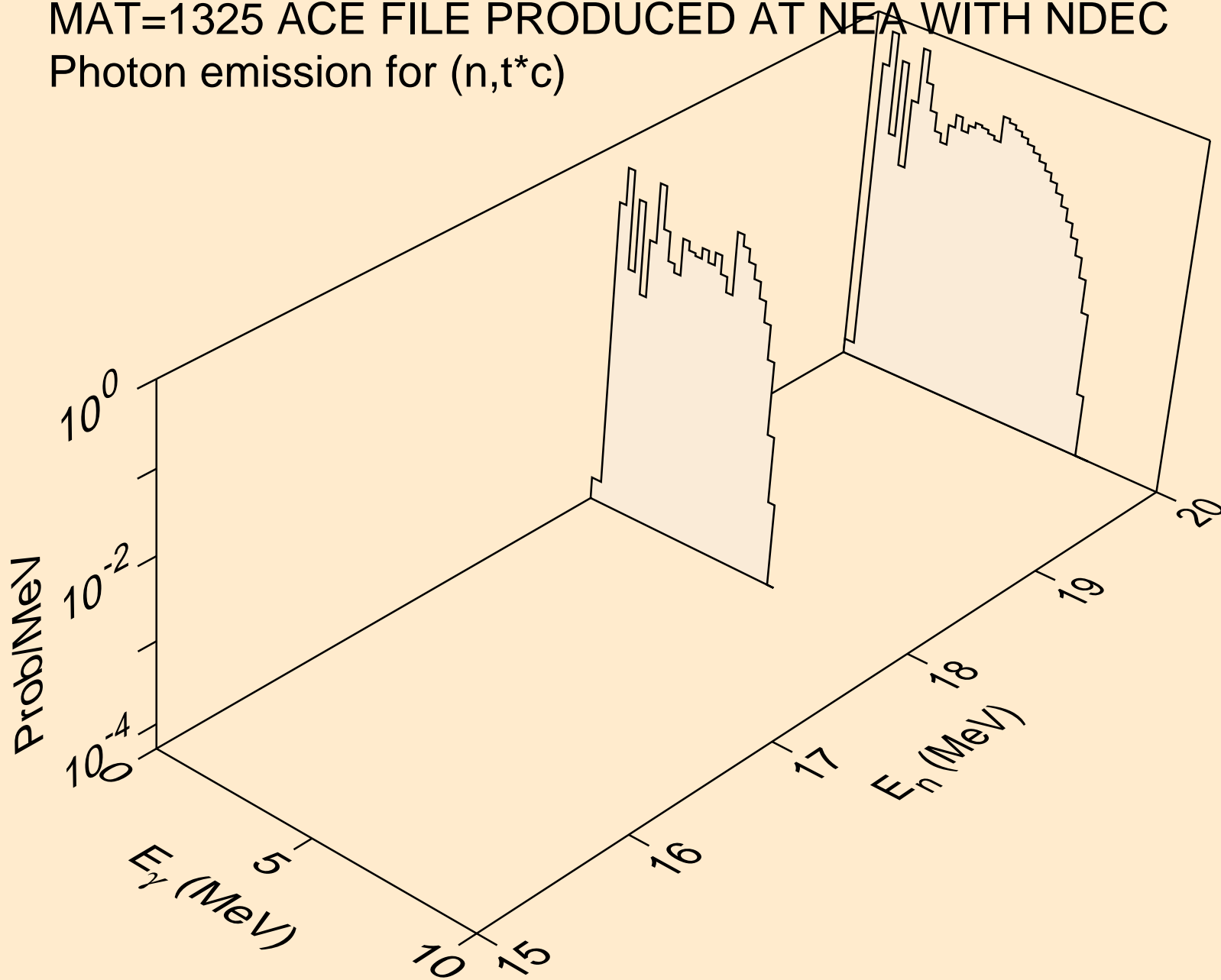

MAT=1325 ACE FILE PRODUCED AT NEA WITH NDEC  
Photon emission for (n,a\*1)

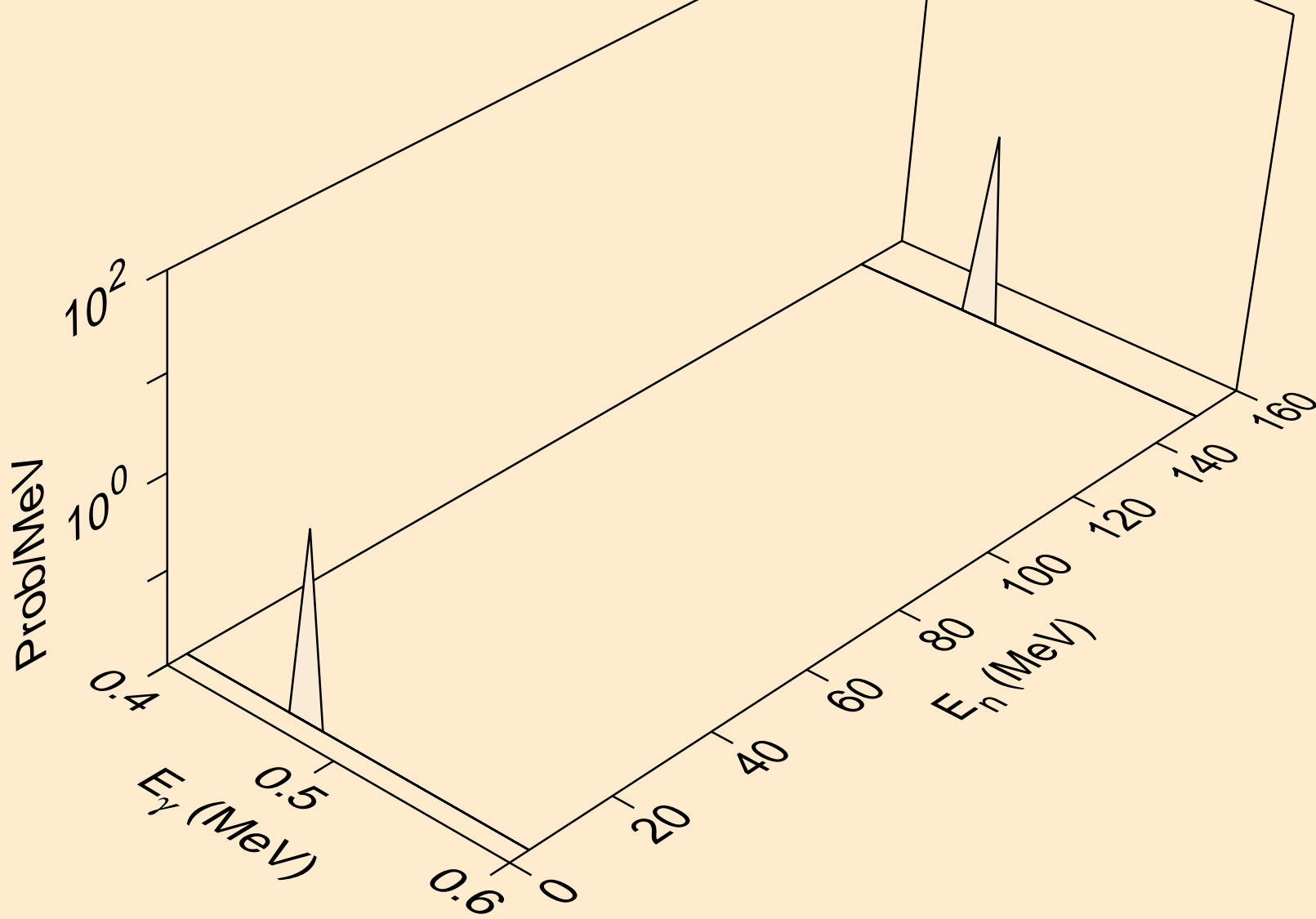

MAT=1325 ACE FILE PRODUCED AT NEA WITH NDEC  
Photon emission for (n,a\*2)

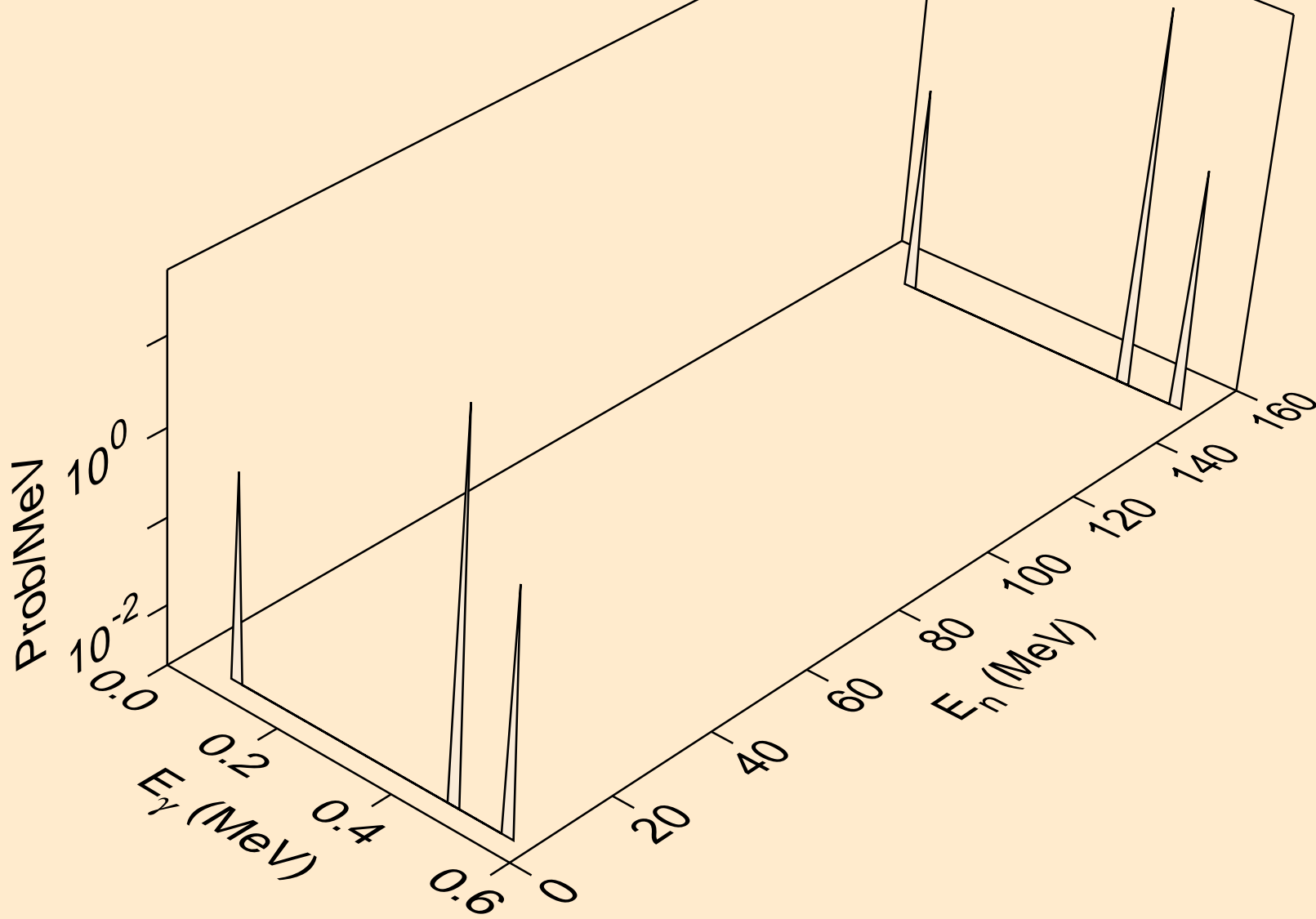

MAT=1325 ACE FILE PRODUCED AT NEA WITH NDEC  
Photon emission for (n,a\*3)

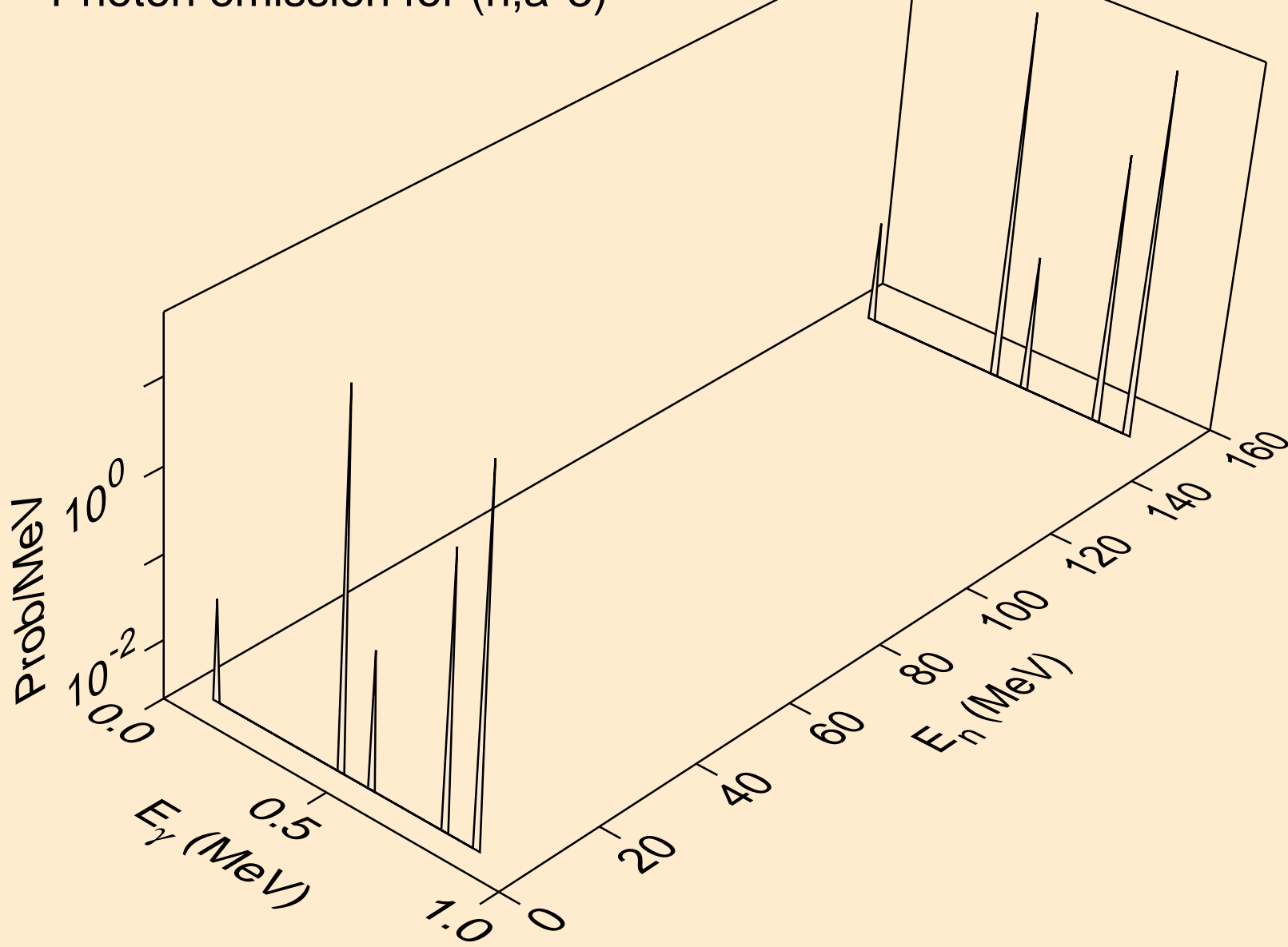

MAT=1325 ACE FILE PRODUCED AT NEA WITH NDEC  
Photon emission for (n,a\*4)

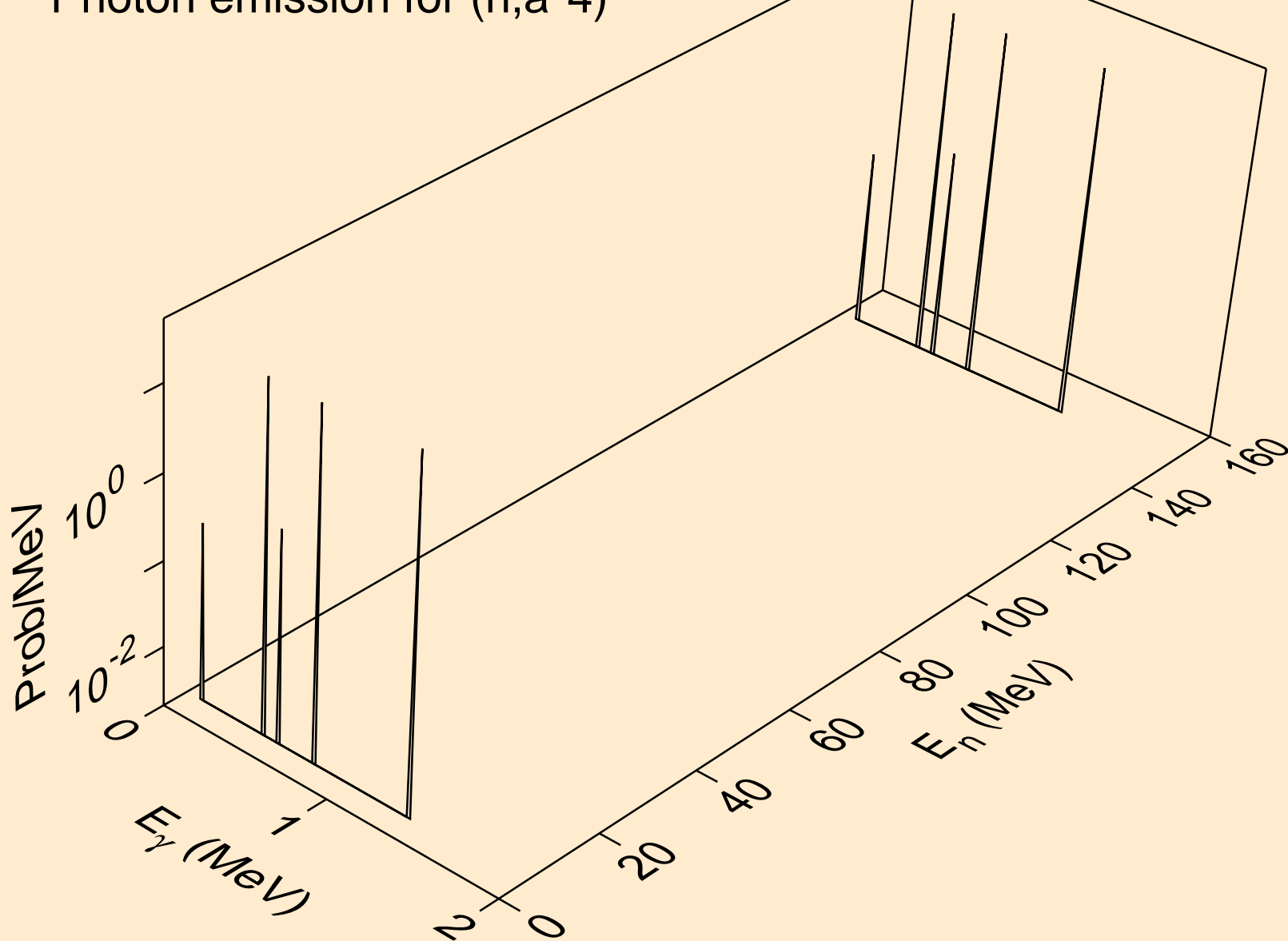

MAT=1325 ACE FILE PRODUCED AT NEA WITH NDEC  
Photon emission for (n,a\*5)

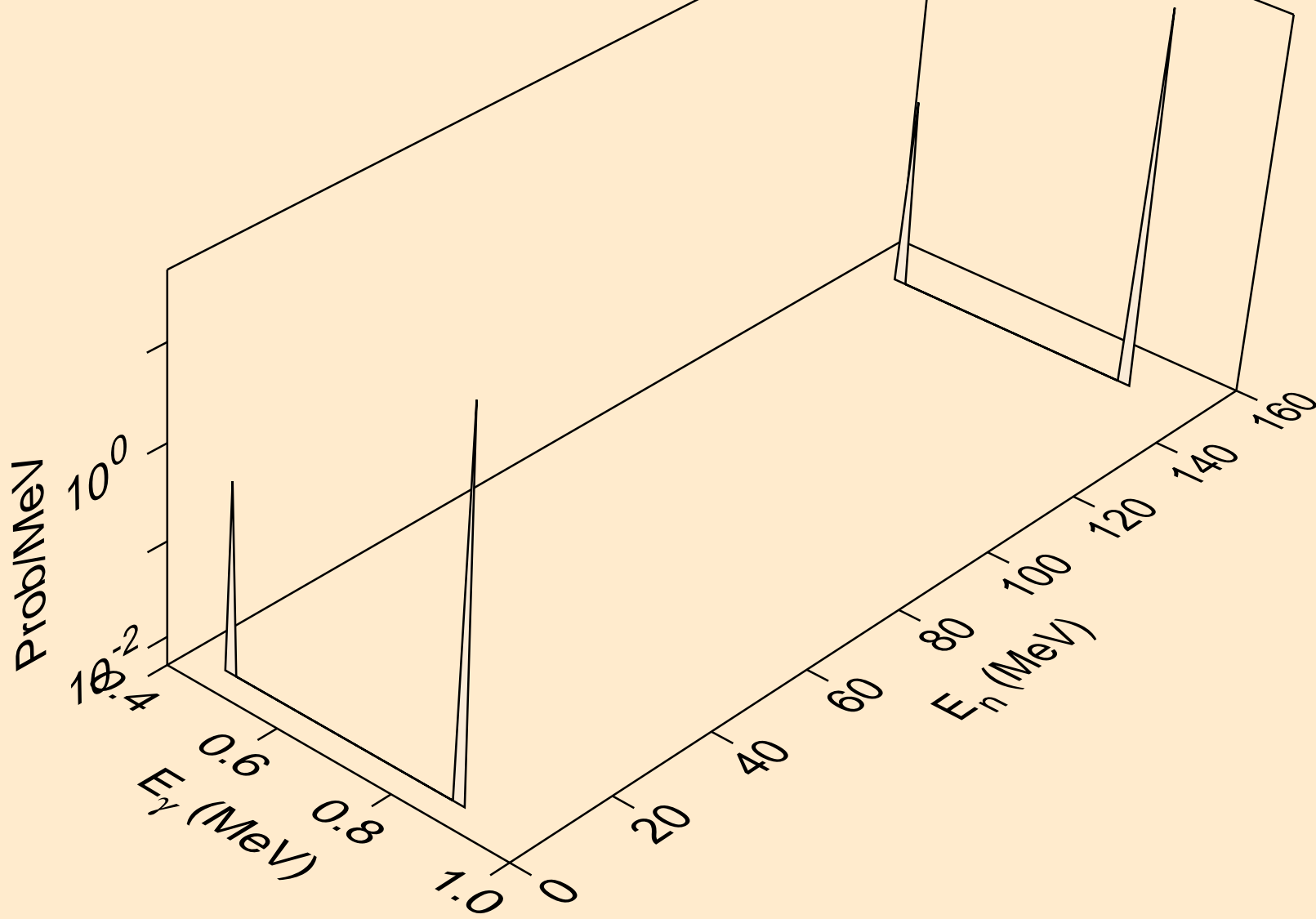



MAT=1325 ACE FILE PRODUCED AT NEA WITH NDEC  
Photon emission for (n,a\*6)

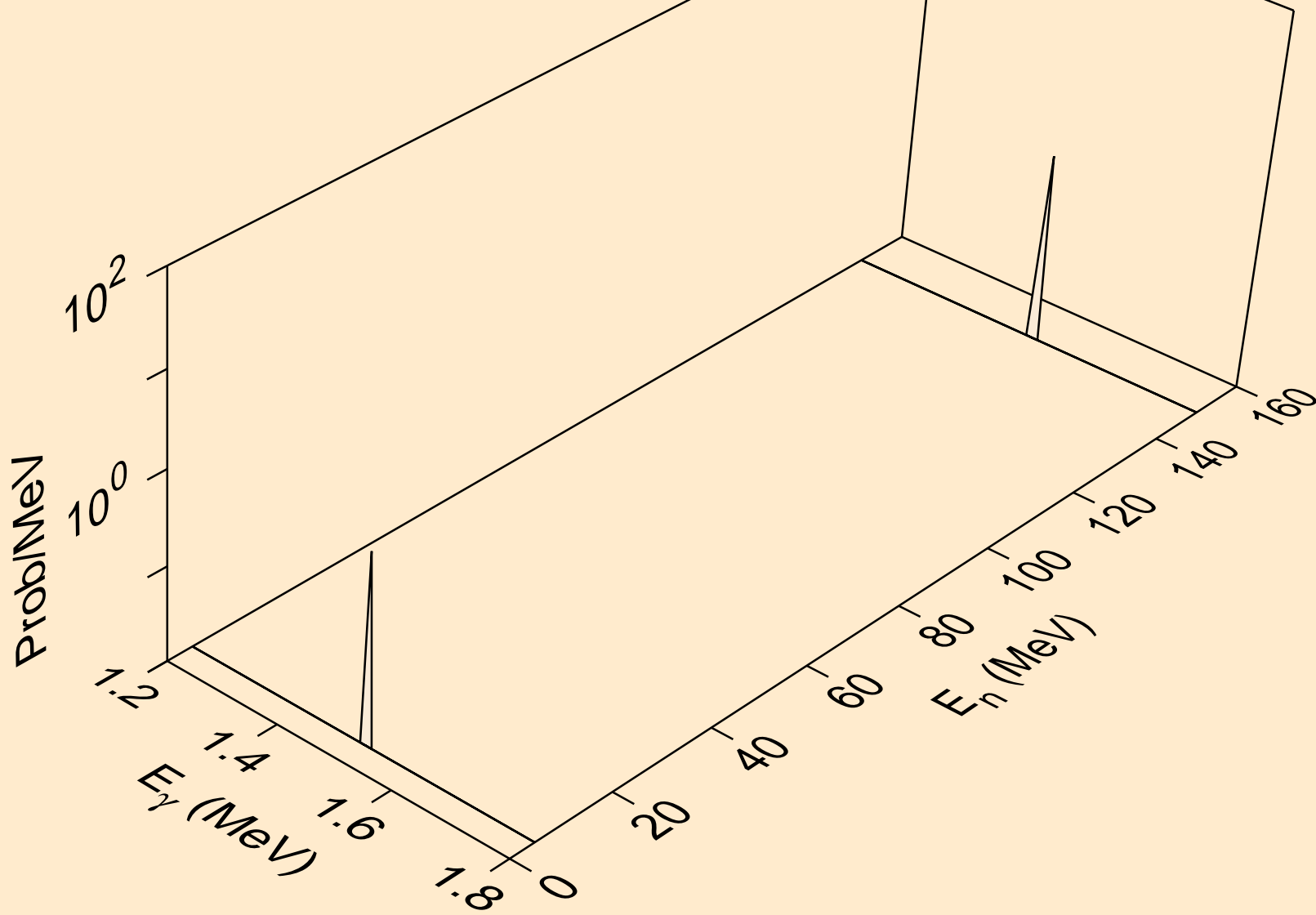

MAT=1325 ACE FILE PRODUCED AT NEA WITH NDEC  
Photon emission for (n,a\*7)

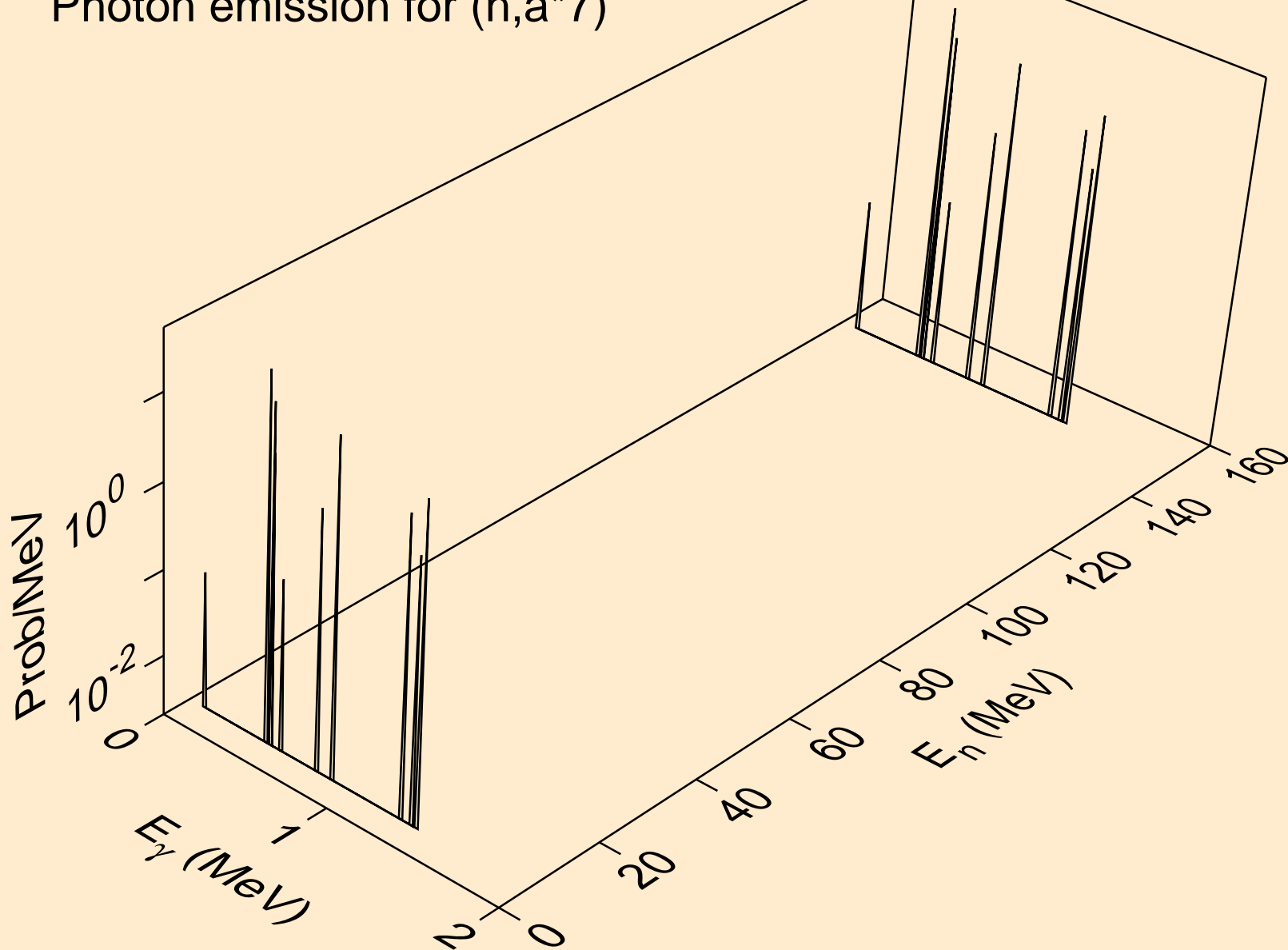

MAT=1325 ACE FILE PRODUCED AT NEA WITH NDEC  
Photon emission for (n,a\*8)

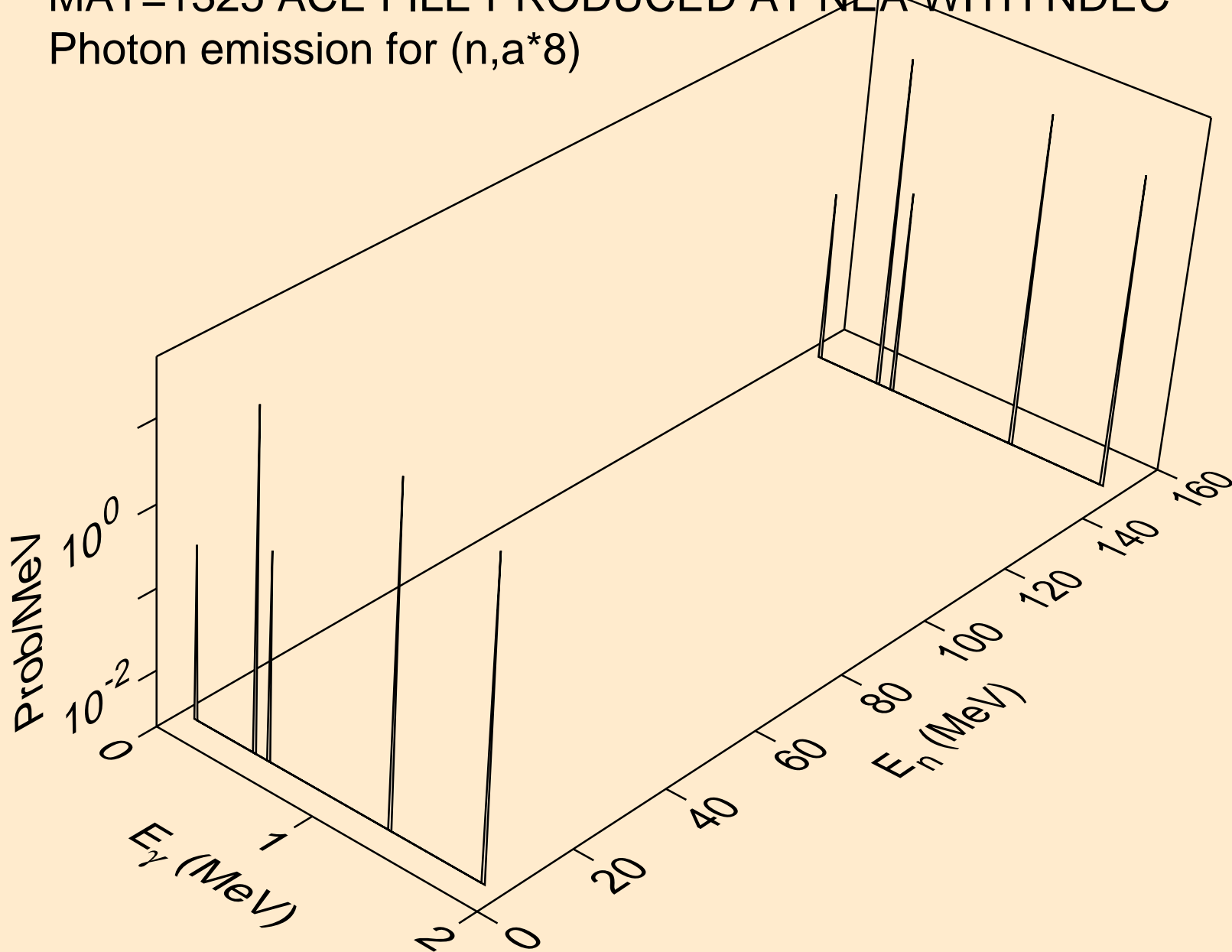

MAT=1325 ACE FILE PRODUCED AT NEA WITH NDEC  
Photon emission for (n,a\*9)

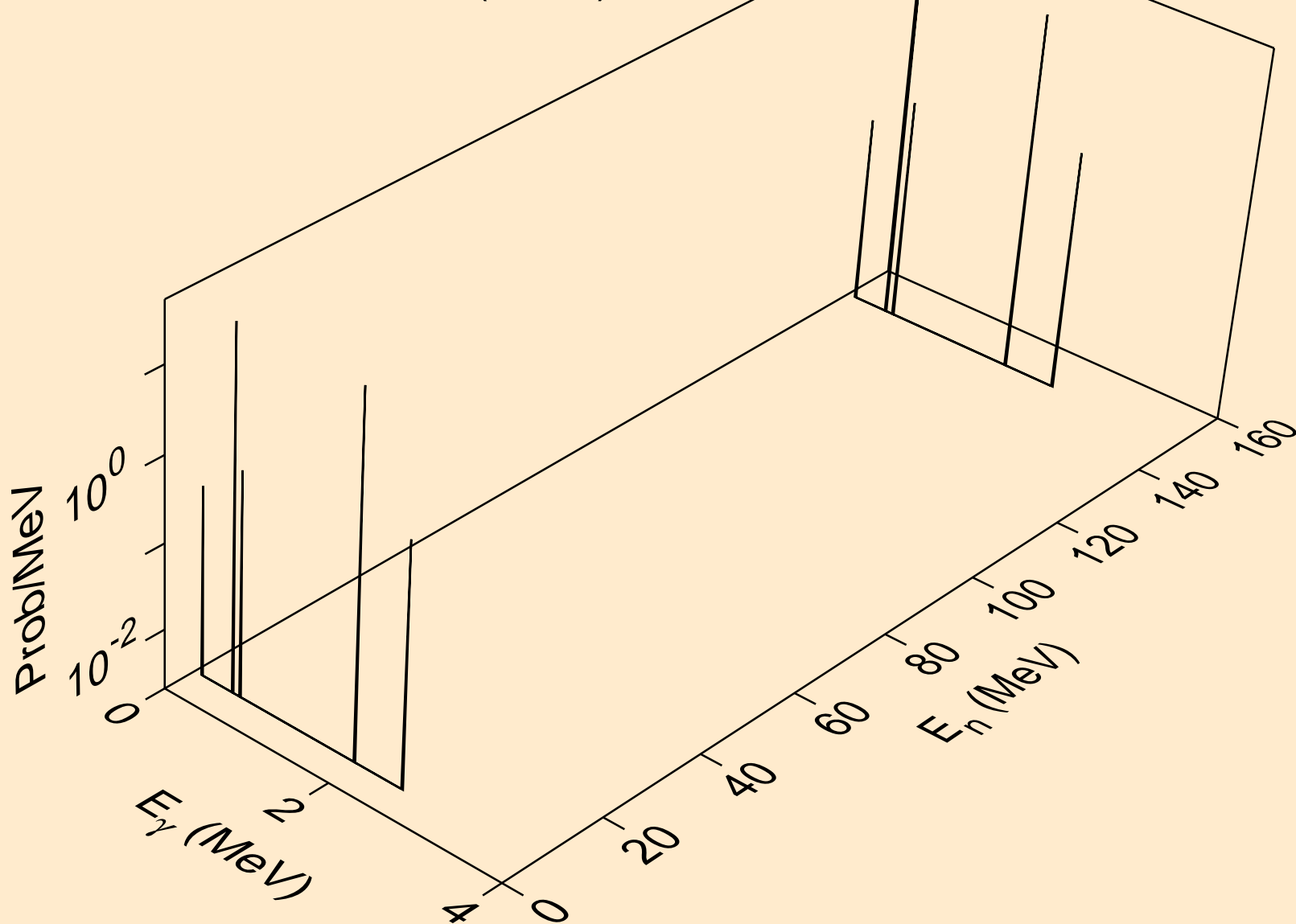

MAT=1325 ACE FILE PRODUCED AT NEA WITH NDEC  
Photon emission for (n,a\*10)

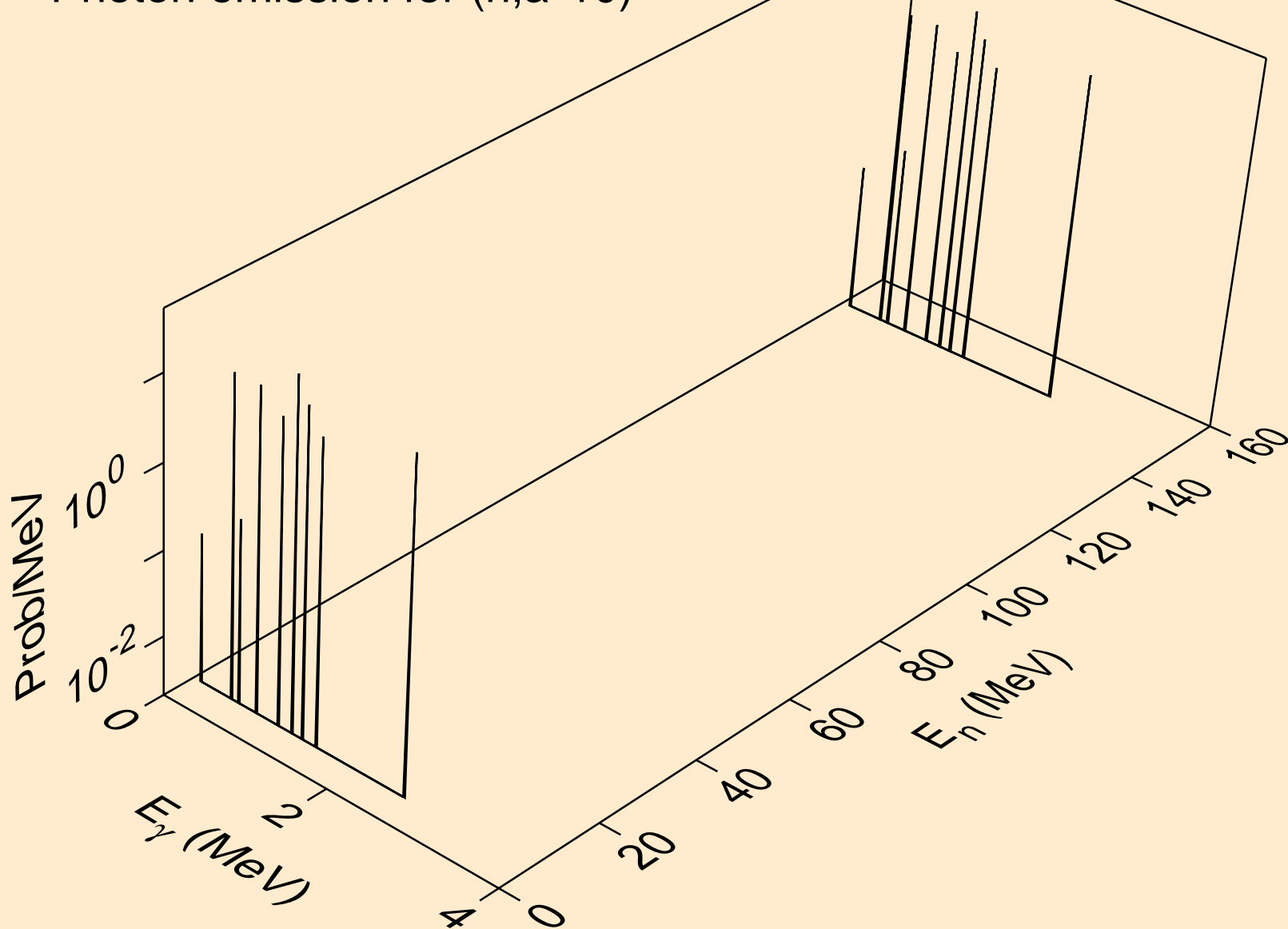

MAT=1325 ACE FILE PRODUCED AT NEA WITH NDEC  
Photon emission for (n,a\*11)

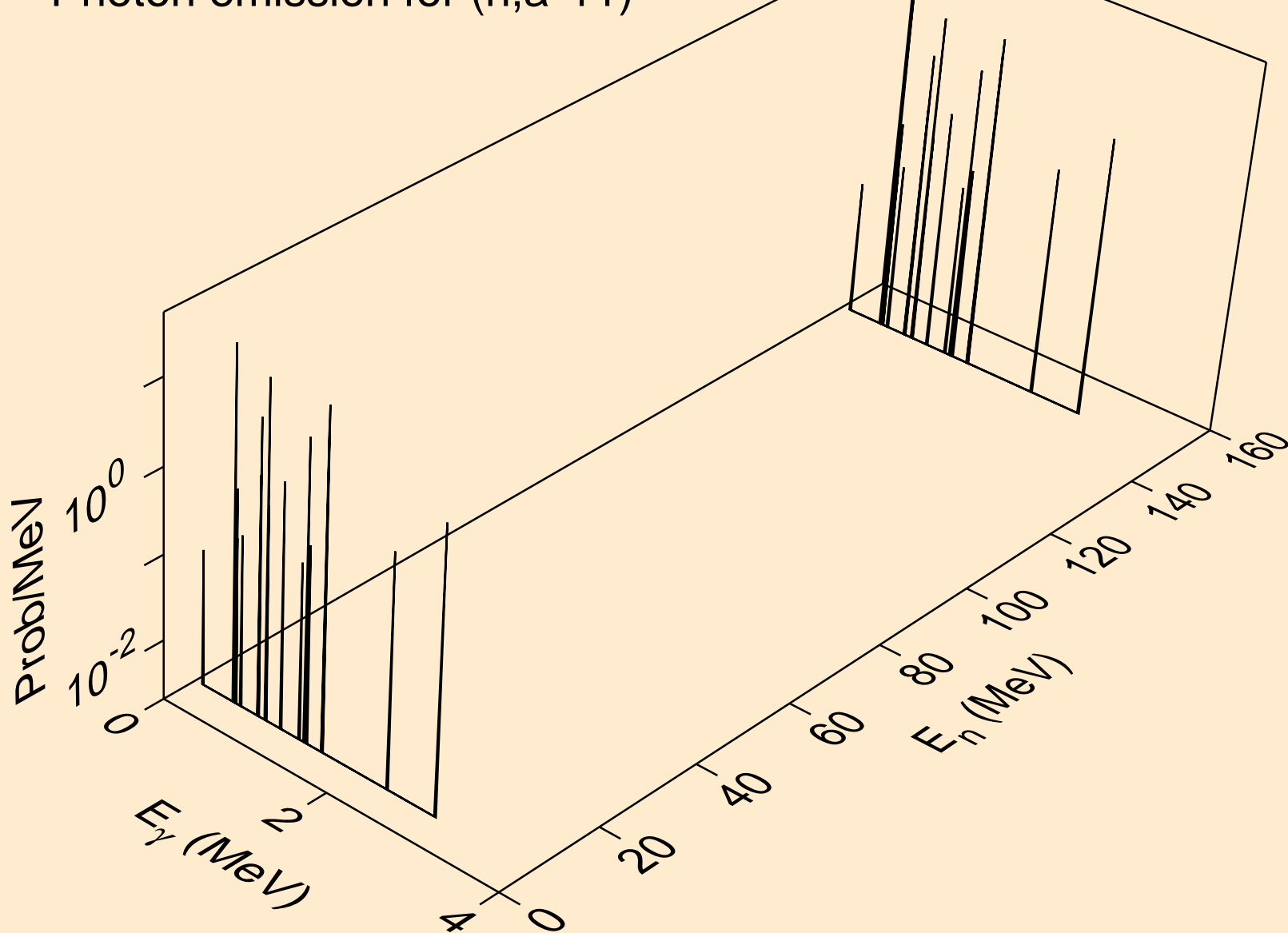

MAT=1325 ACE FILE PRODUCED AT NEA WITH NDEC  
Photon emission for (n,a\*12)

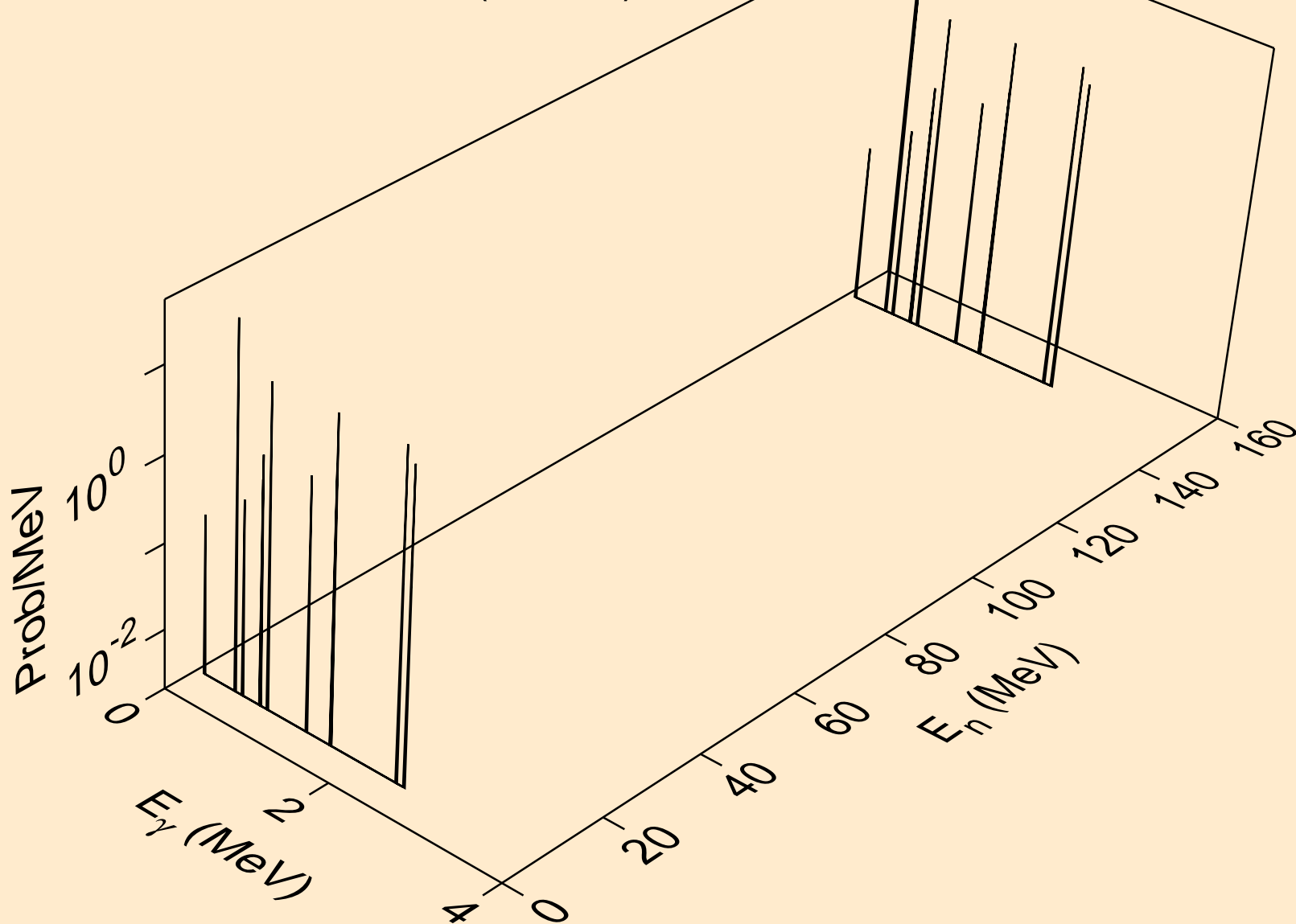

MAT=1325 ACE FILE PRODUCED AT NEA WITH NDEC  
Photon emission for (n,a\*13)

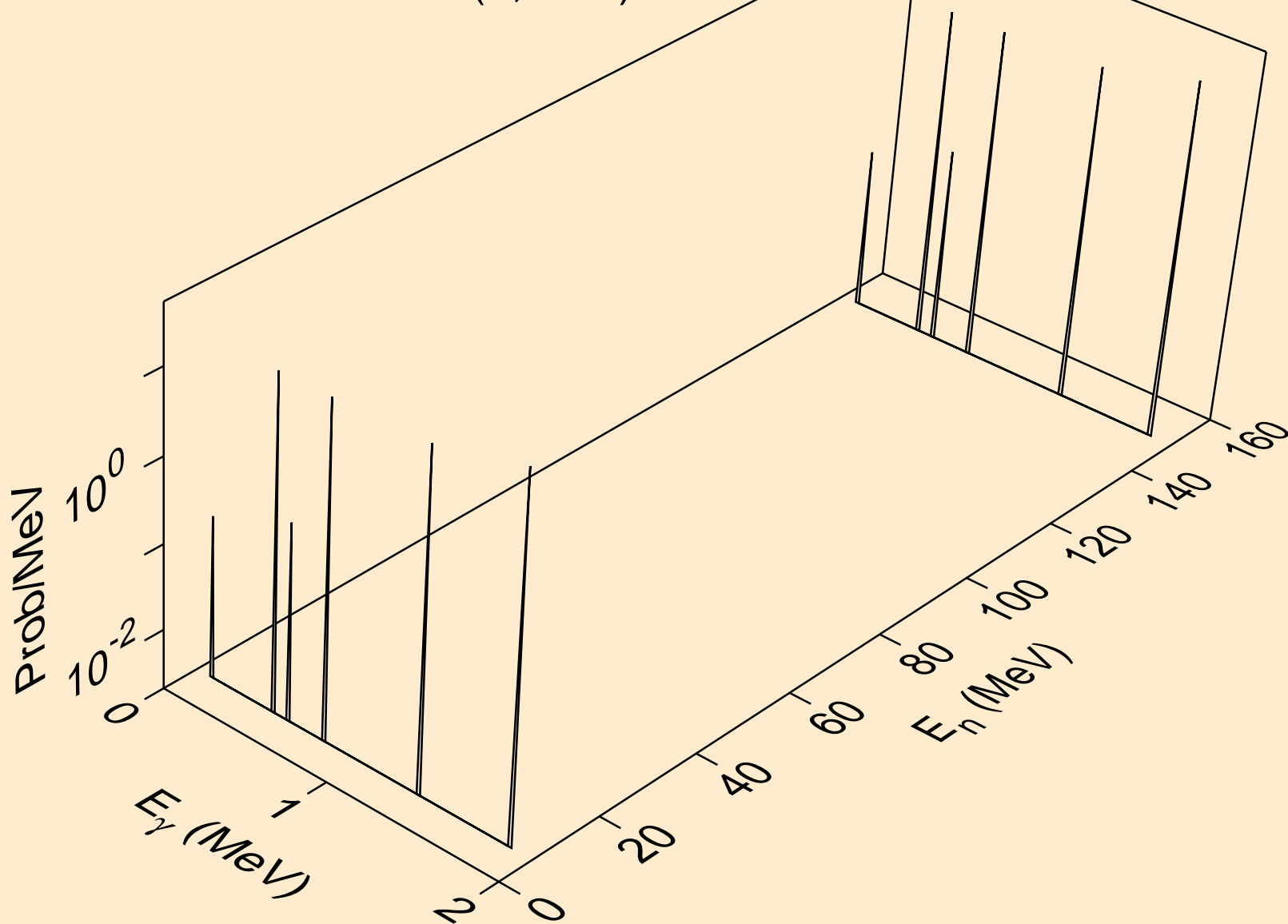



MAT=1325 ACE FILE PRODUCED AT NEA WITH NDEC  
Photon emission for (n,a\*14)

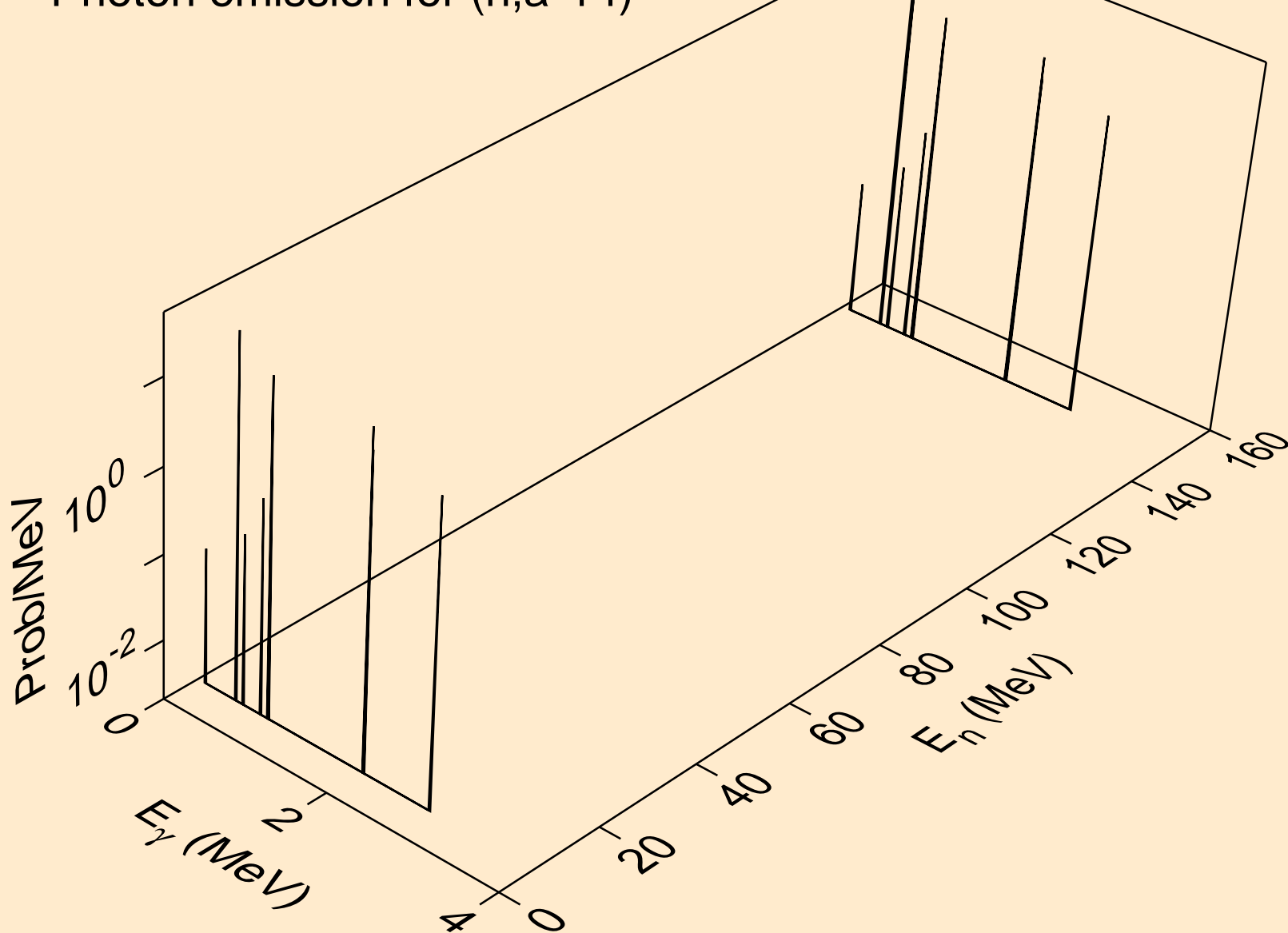

MAT=1325 ACE FILE PRODUCED AT NEA WITH NDEC  
Photon emission for (n,a\*15)

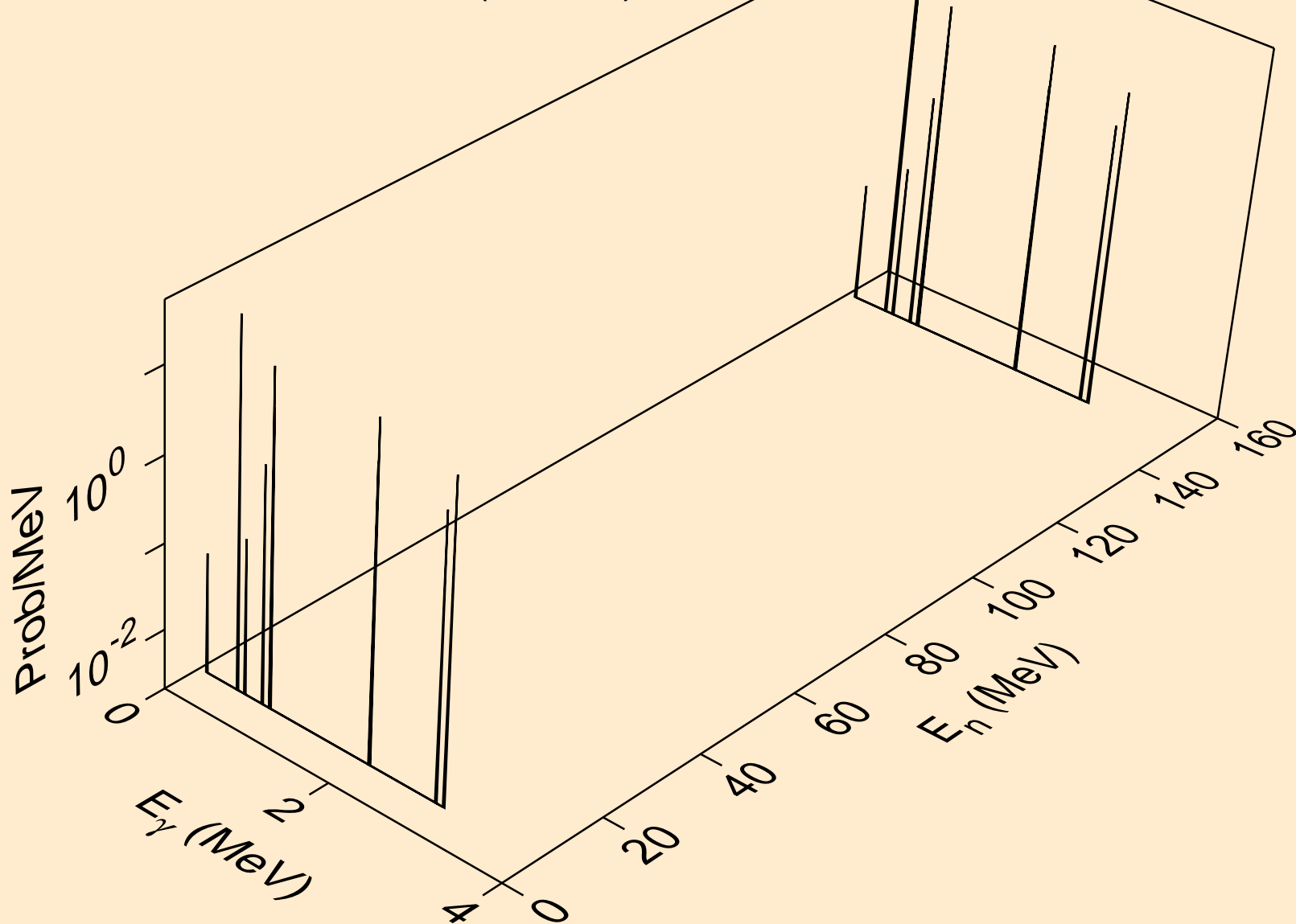

MAT=1325 ACE FILE PRODUCED AT NEA WITH NDEC  
Photon emission for (n,a\*16)

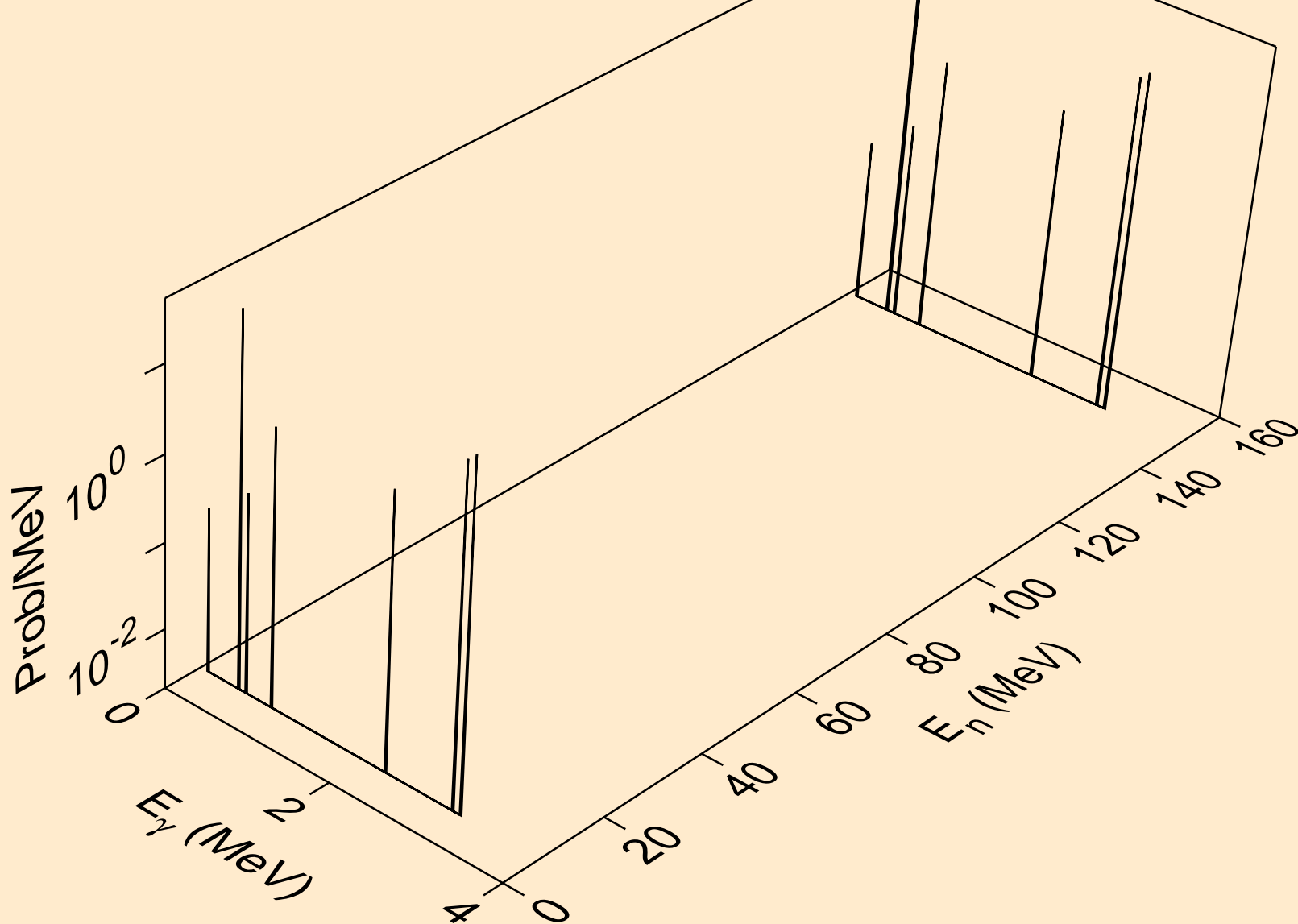

MAT=1325 ACE FILE PRODUCED AT NEA WITH NDEC  
Photon emission for (n,a\*17)

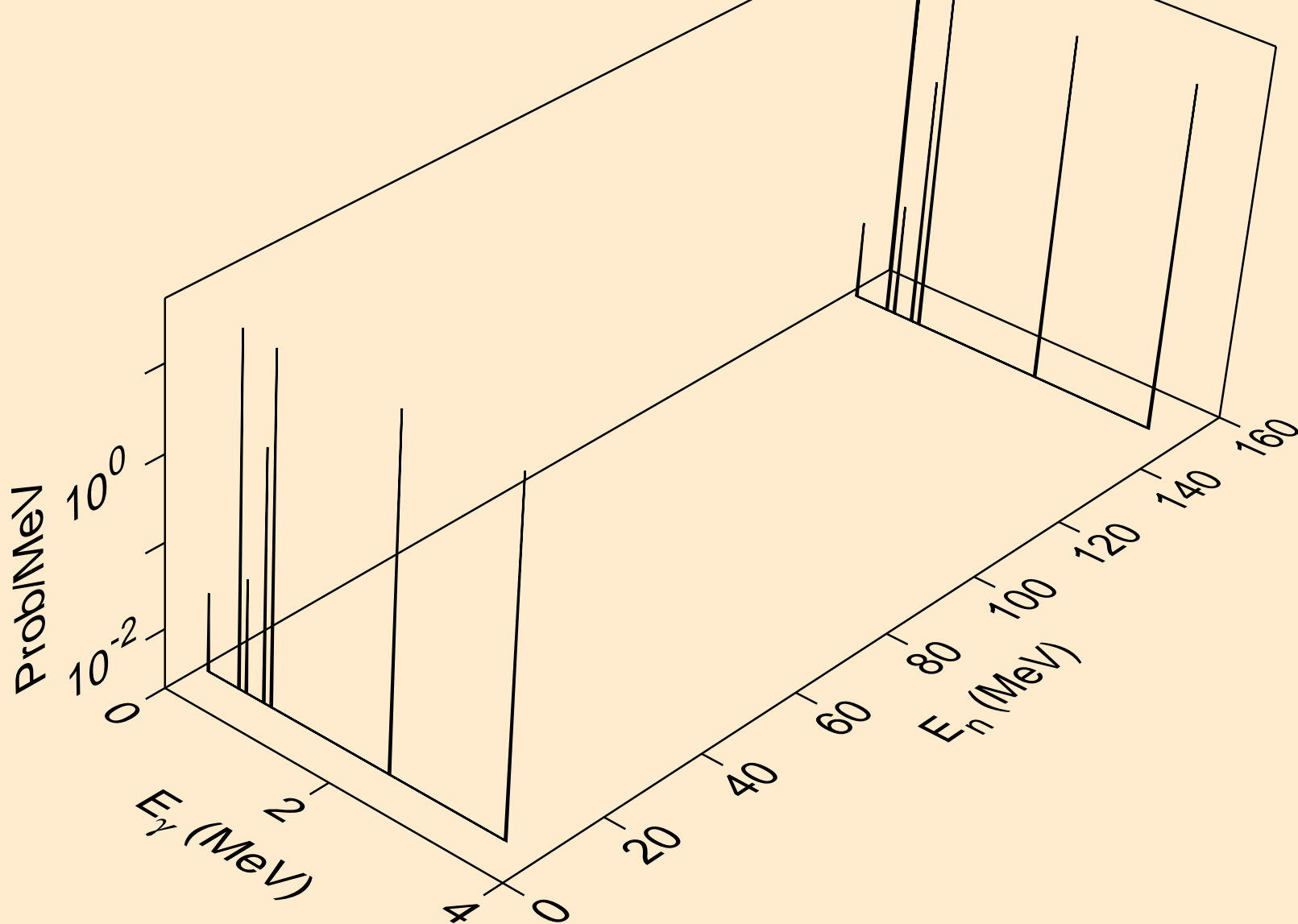

MAT=1325 ACE FILE PRODUCED AT NEA WITH NDEC  
Photon emission for (n,a\*18)

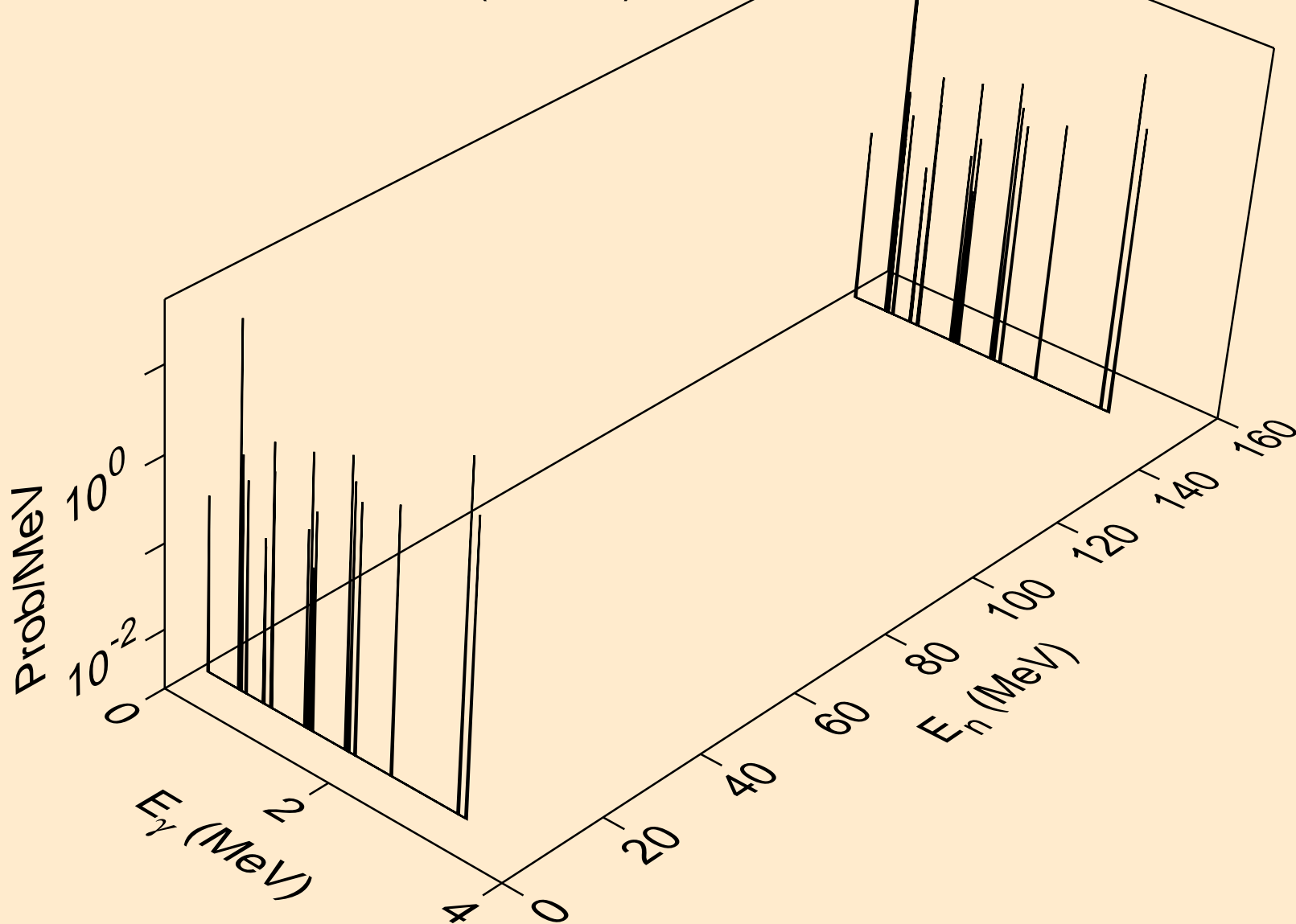

MAT=1325 ACE FILE PRODUCED AT NEA WITH NDEC  
Photon emission for (n,a\*19)

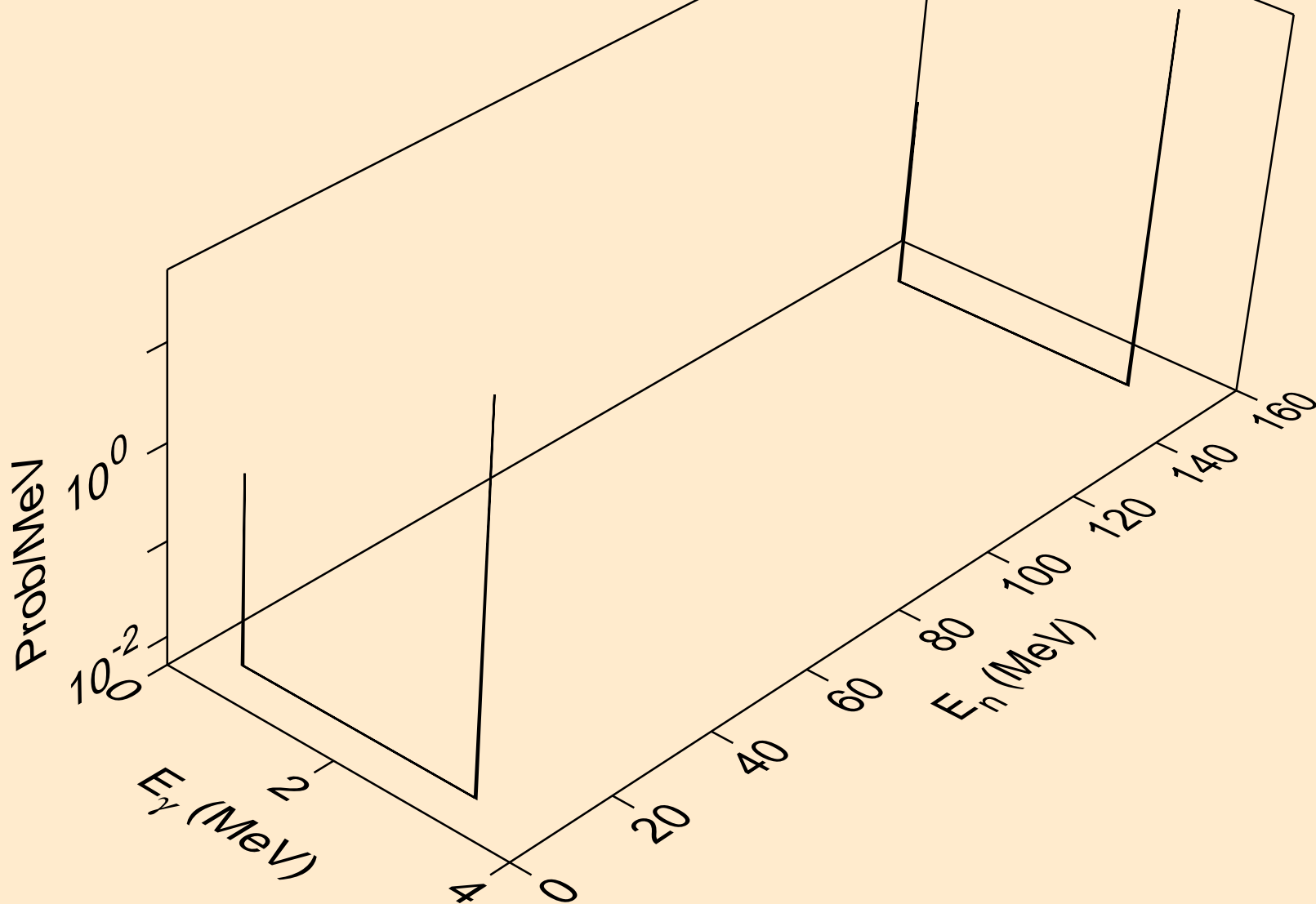

MAT=1325 ACE FILE PRODUCED AT NEA WITH NDEC  
Photon emission for (n,a\*c)

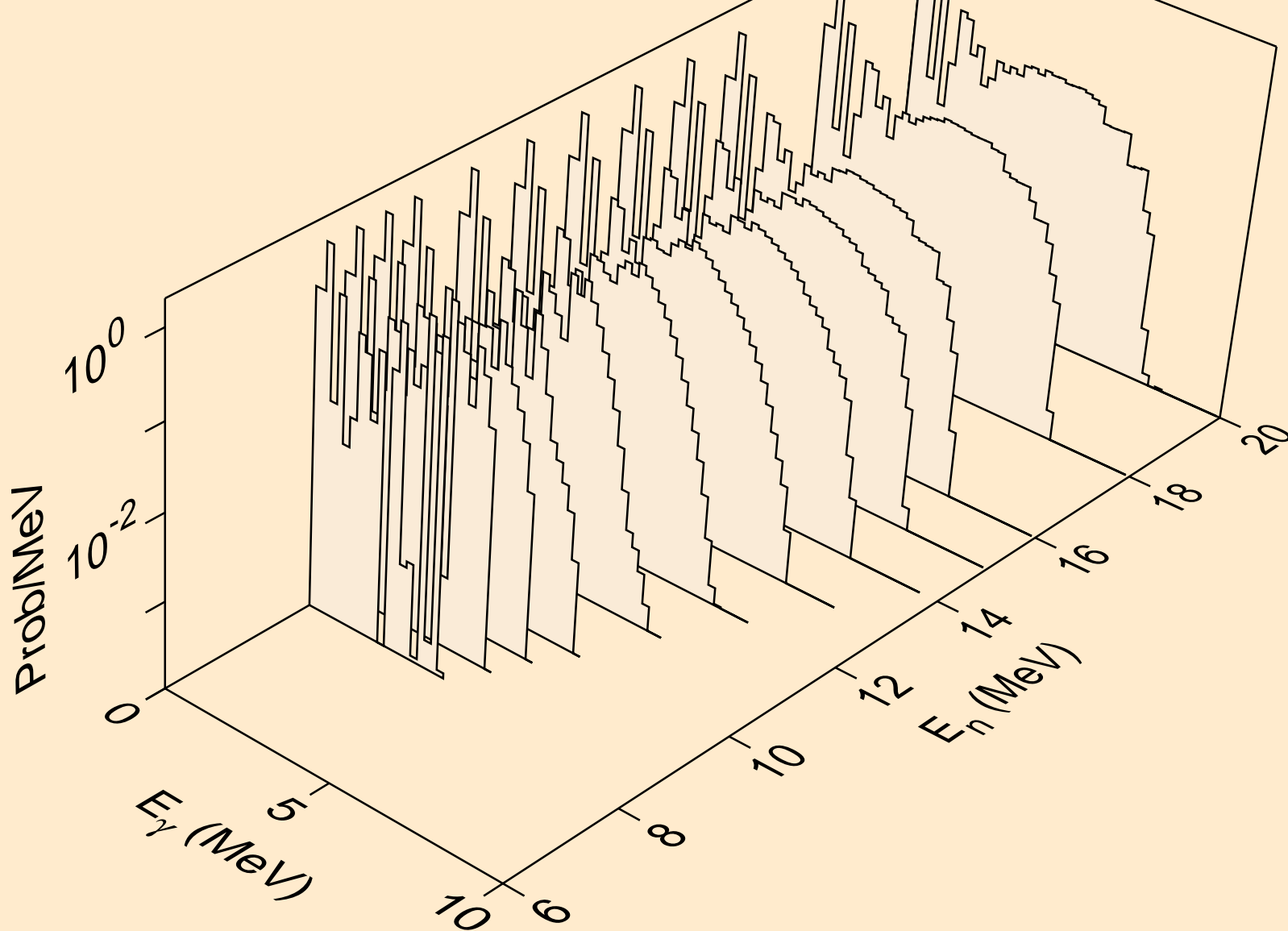

MAT=1325 ACE FILE PRODUCED AT NEA WITH NDEC  
thermal capture photon spectrum

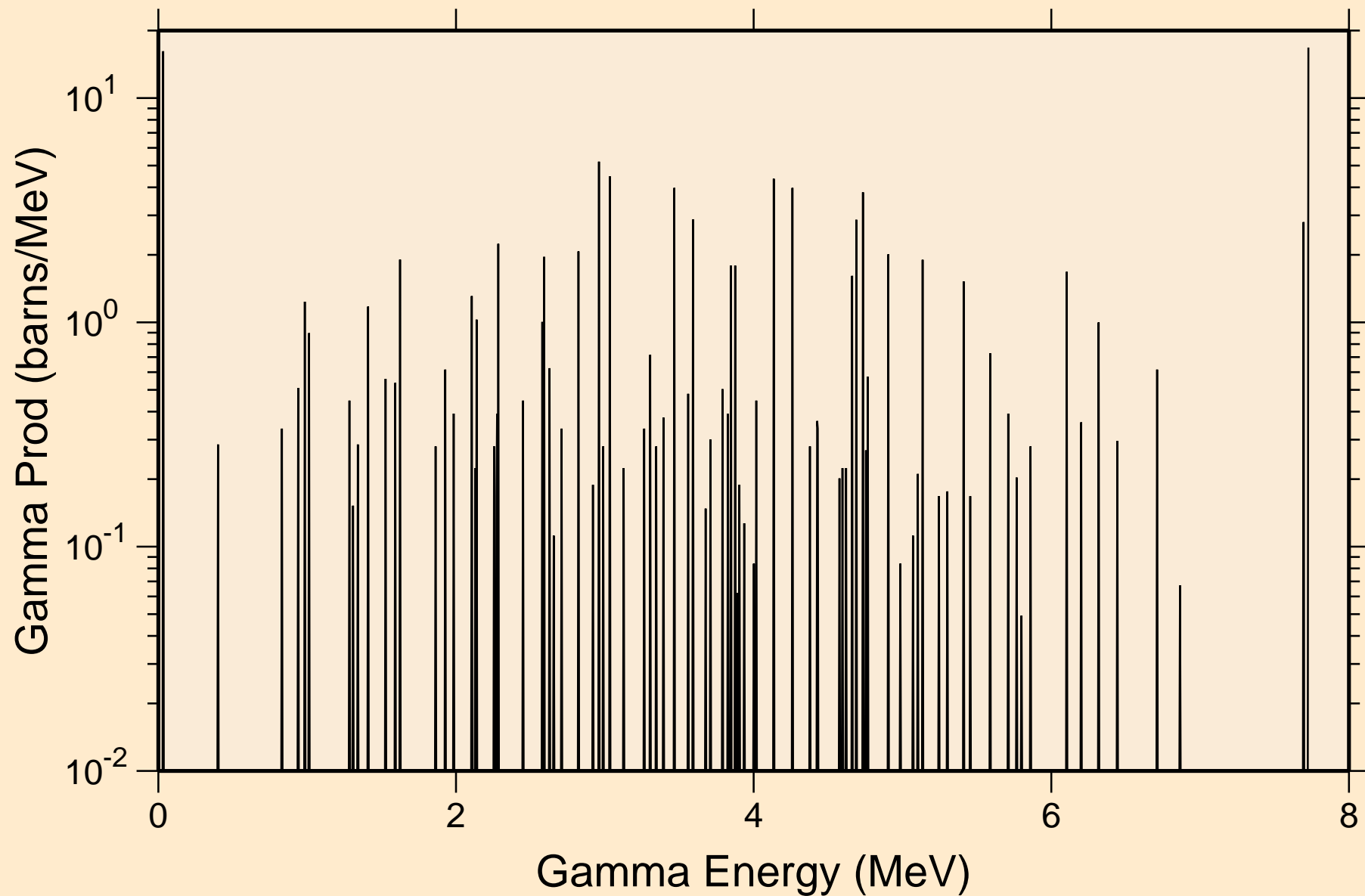



MAT=1325 ACE FILE PRODUCED AT NEA WITH NDEC  
14 MeV photon spectrum

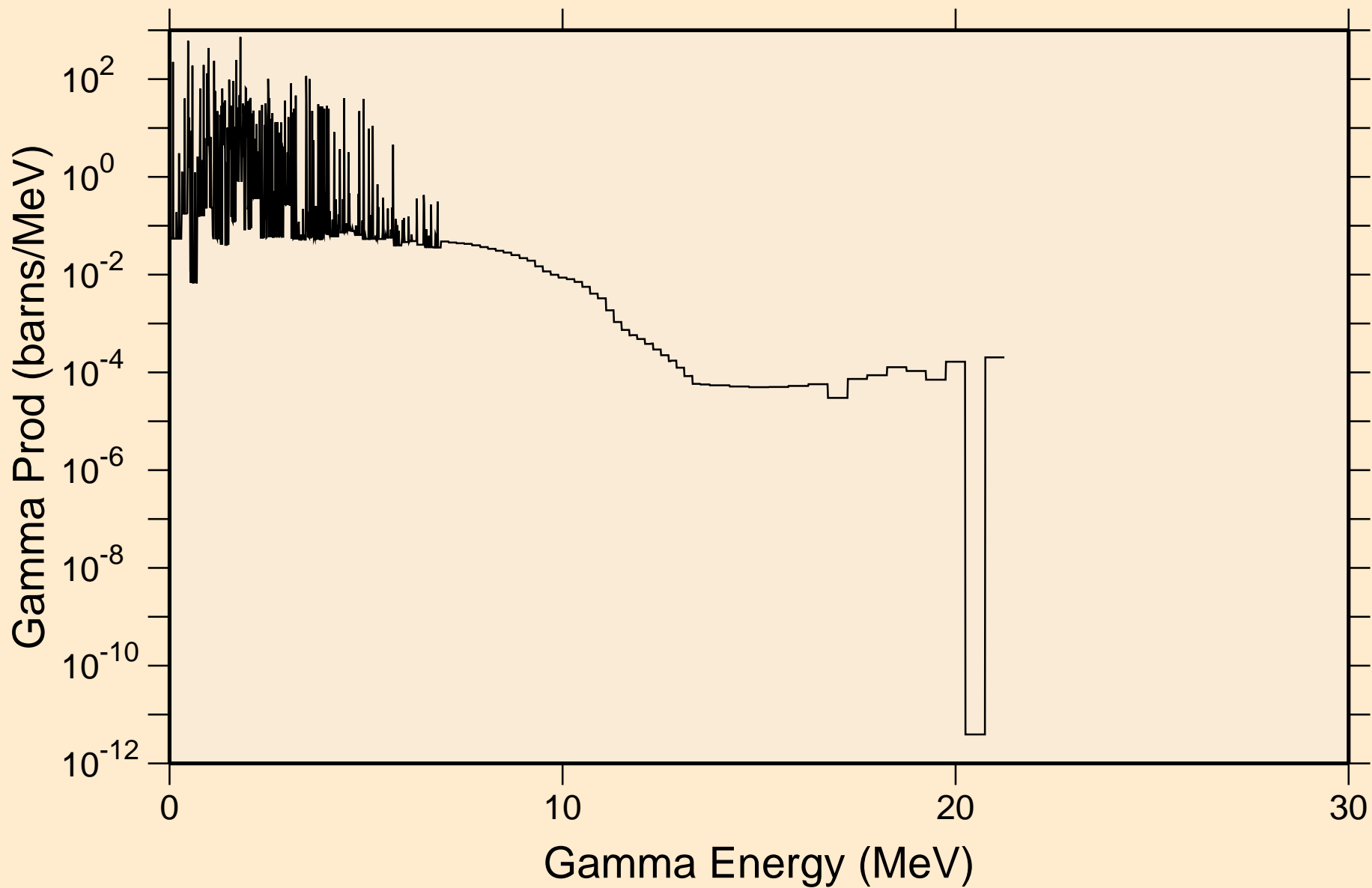

MAT=1325 ACE FILE PRODUCED AT NEA WITH NDEC  
Particle heating contributions

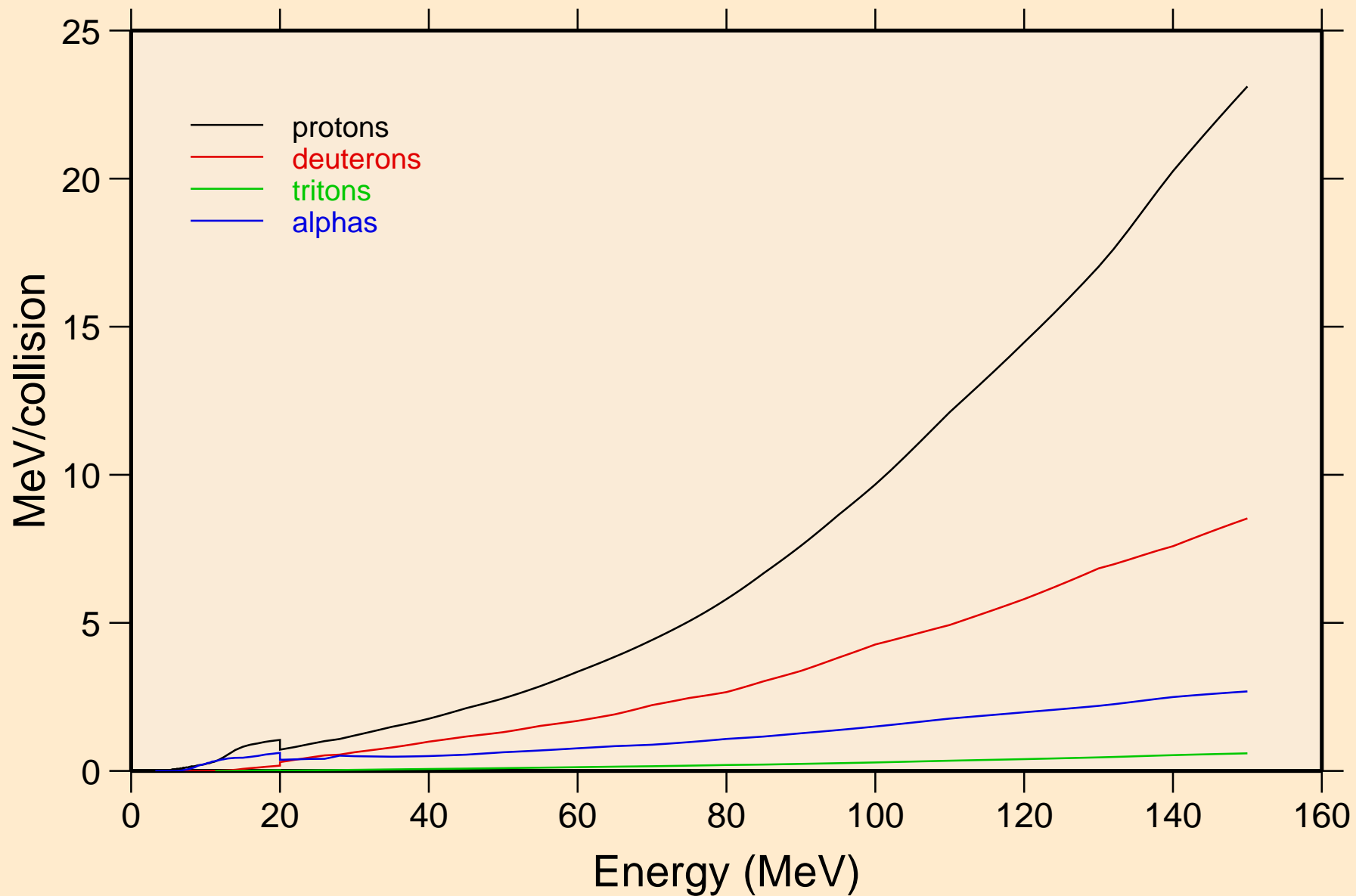

MAT=1325 ACE FILE PRODUCED AT NEA WITH NDEC  
Recoil Heating

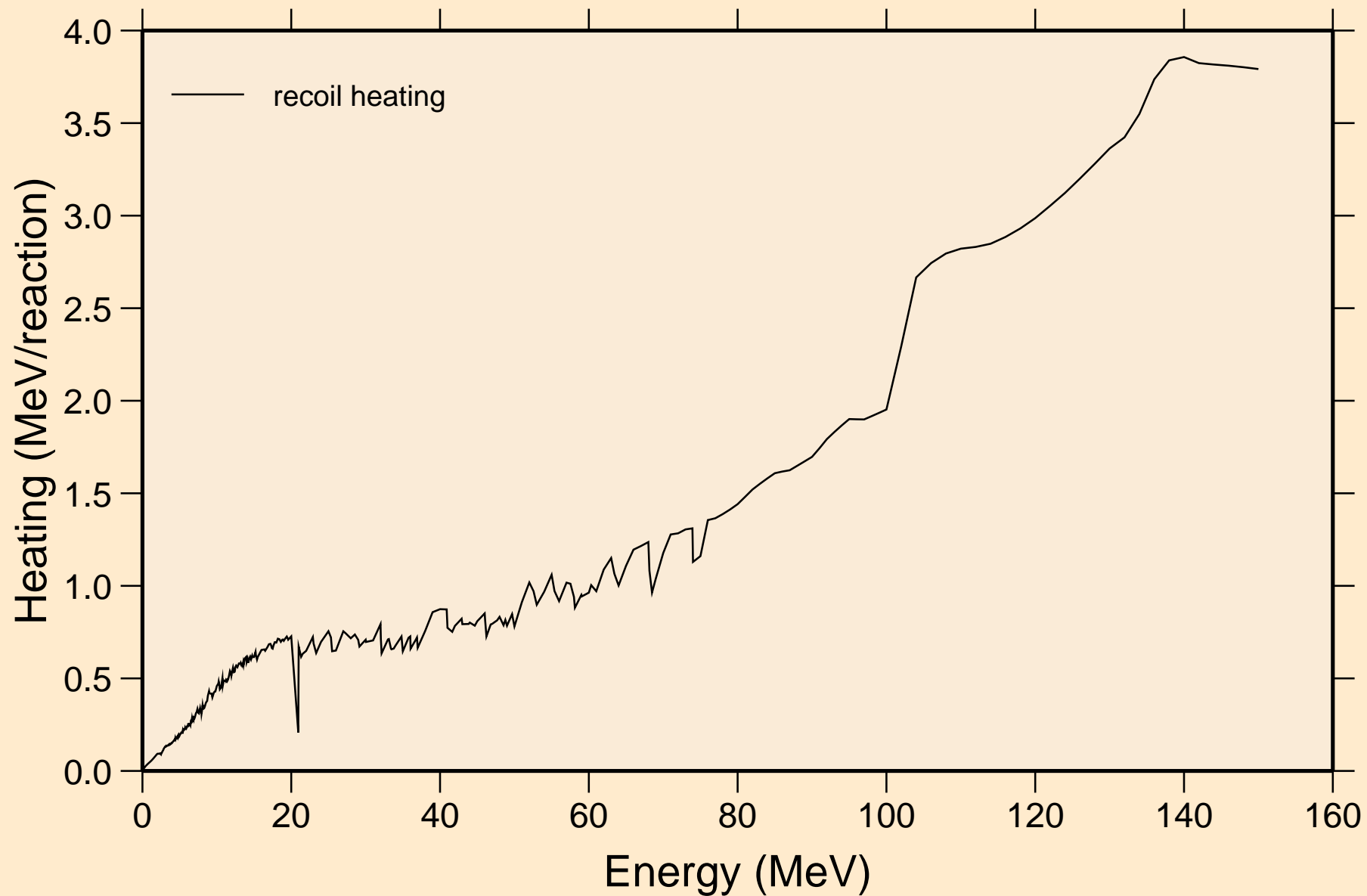

MAT=1325 ACE FILE PRODUCED AT NEA WITH NDEC  
Particle production cross sections

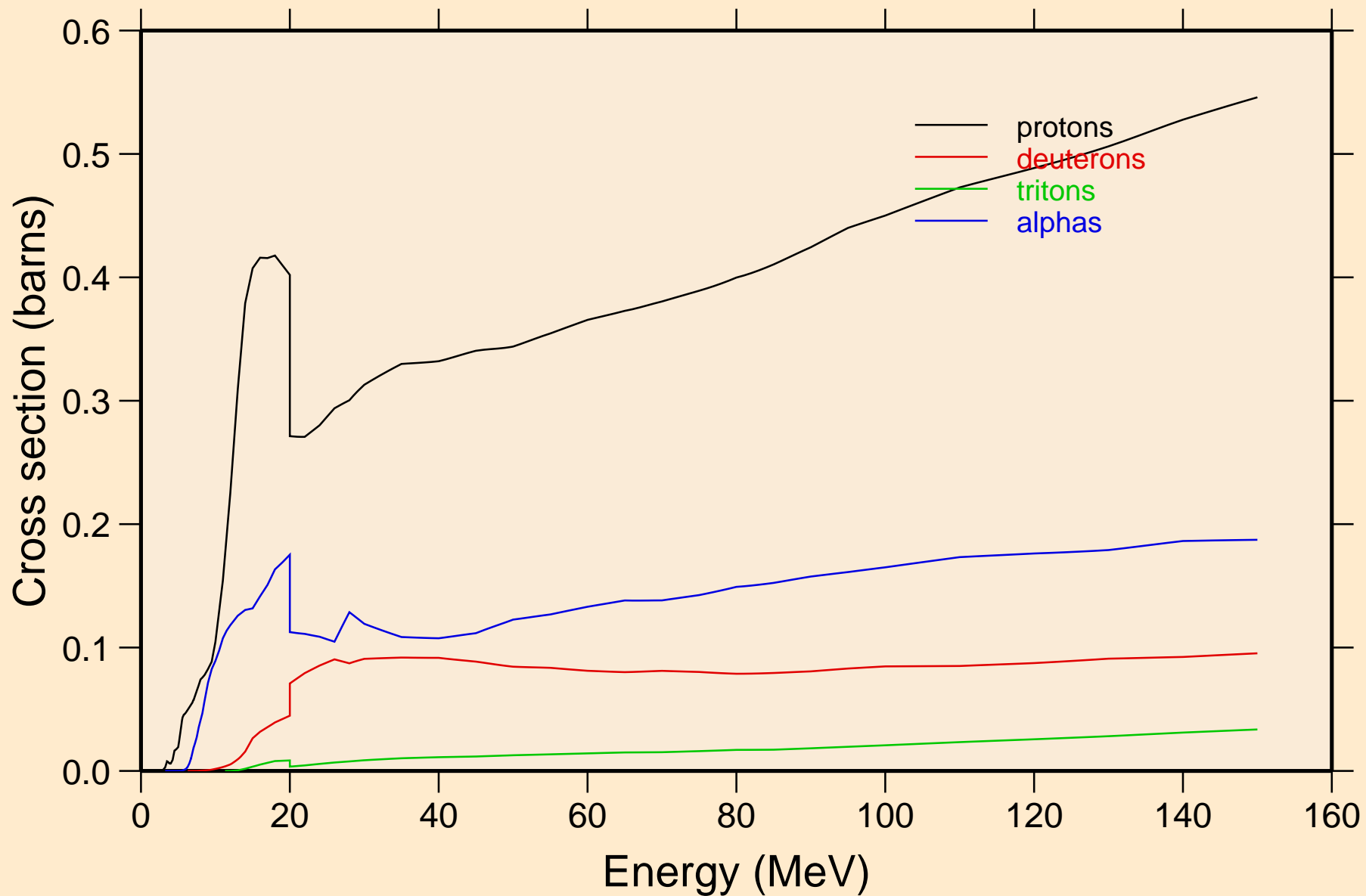

MAT=1325 ACE FILE PRODUCED AT NEA WITH NDEC  
protons from (n,x)

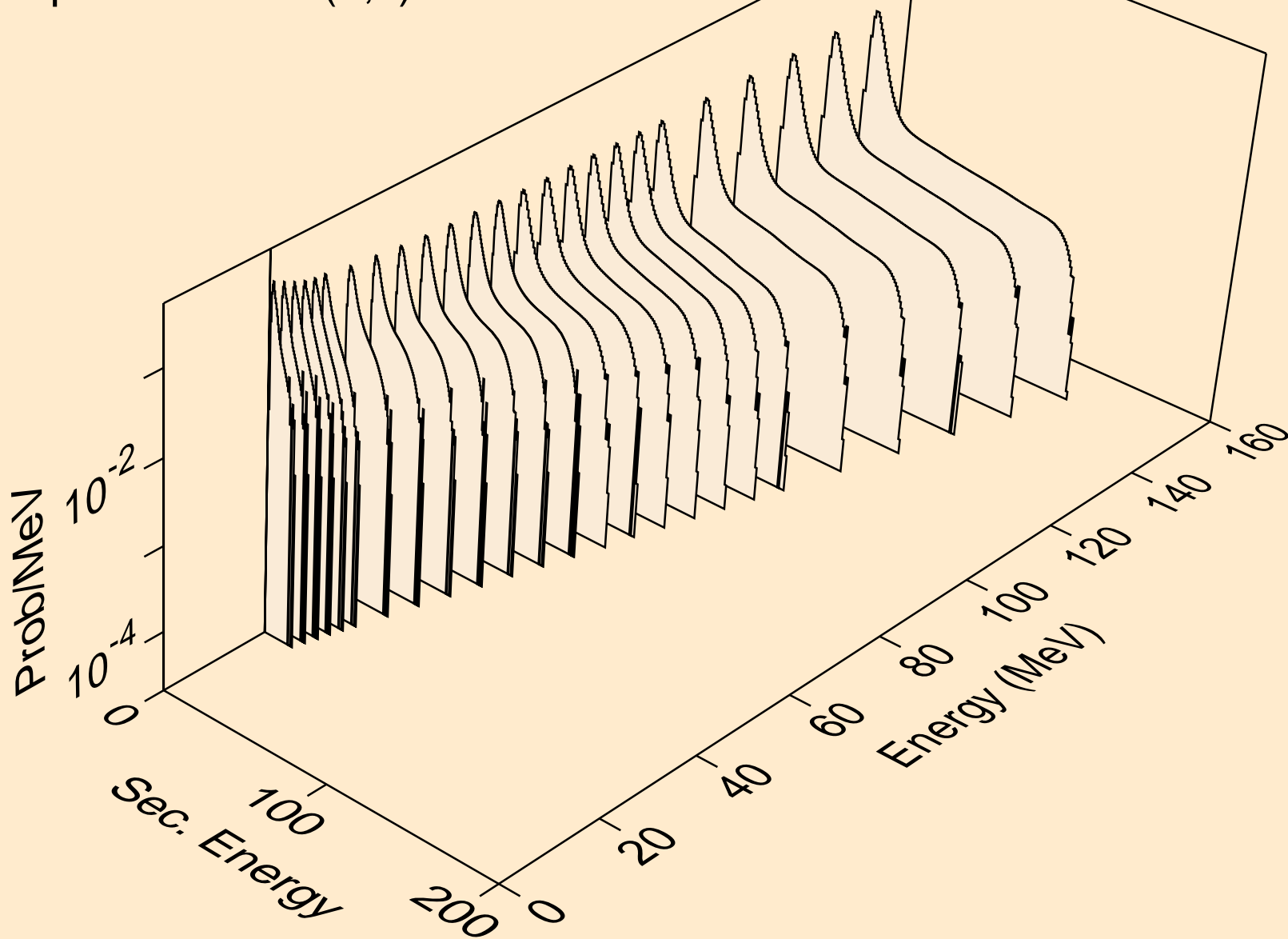

MAT=1325 ACE FILE PRODUCED AT NEA WITH NDEC  
protons from (n,n\*)p

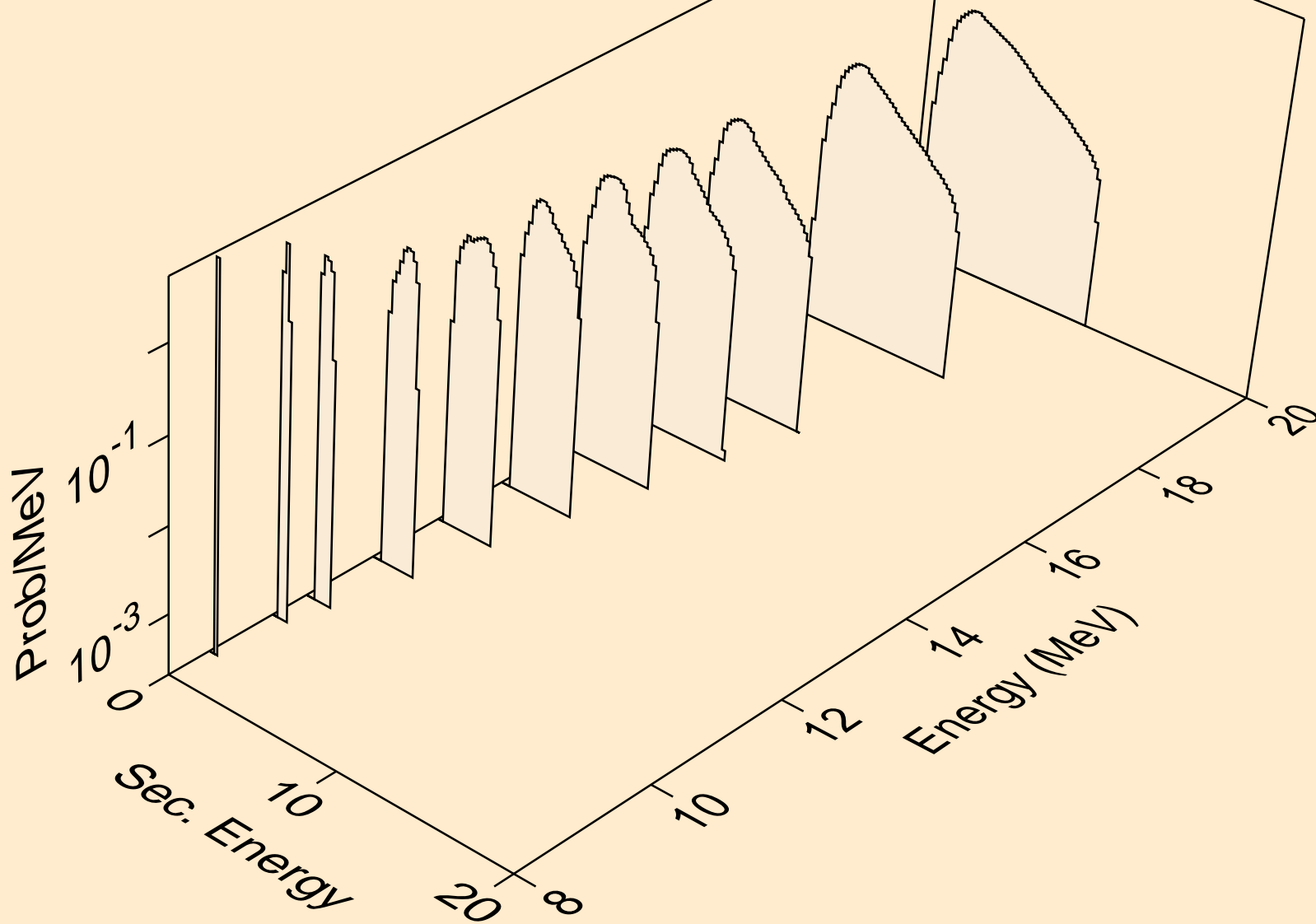

MAT=1325 ACE FILE PRODUCED AT NEA WITH NDEC  
protons from (n,npa)

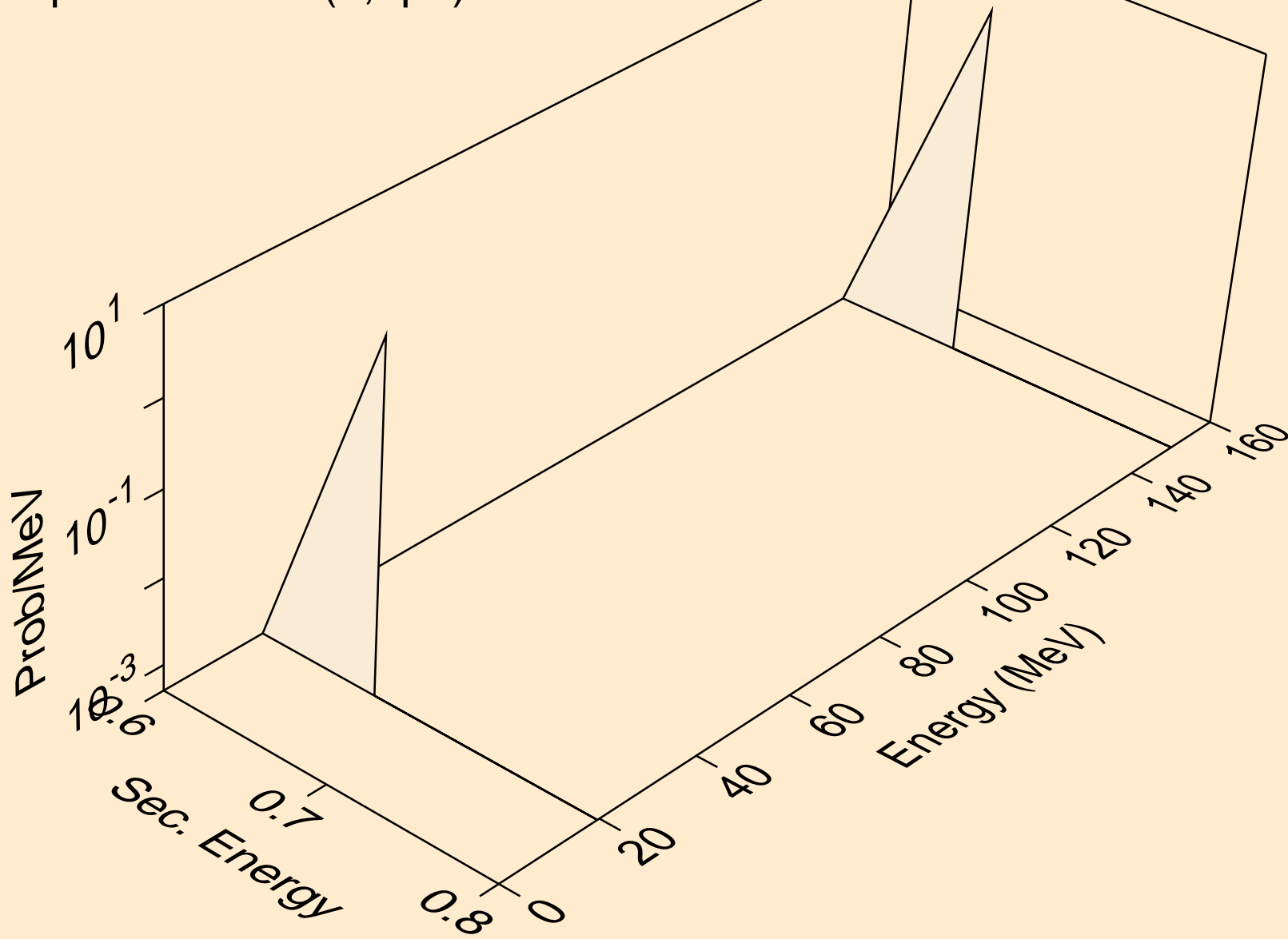

MAT=1325 ACE FILE PRODUCED AT NEA WITH NDEC  
protons from (n,2p)

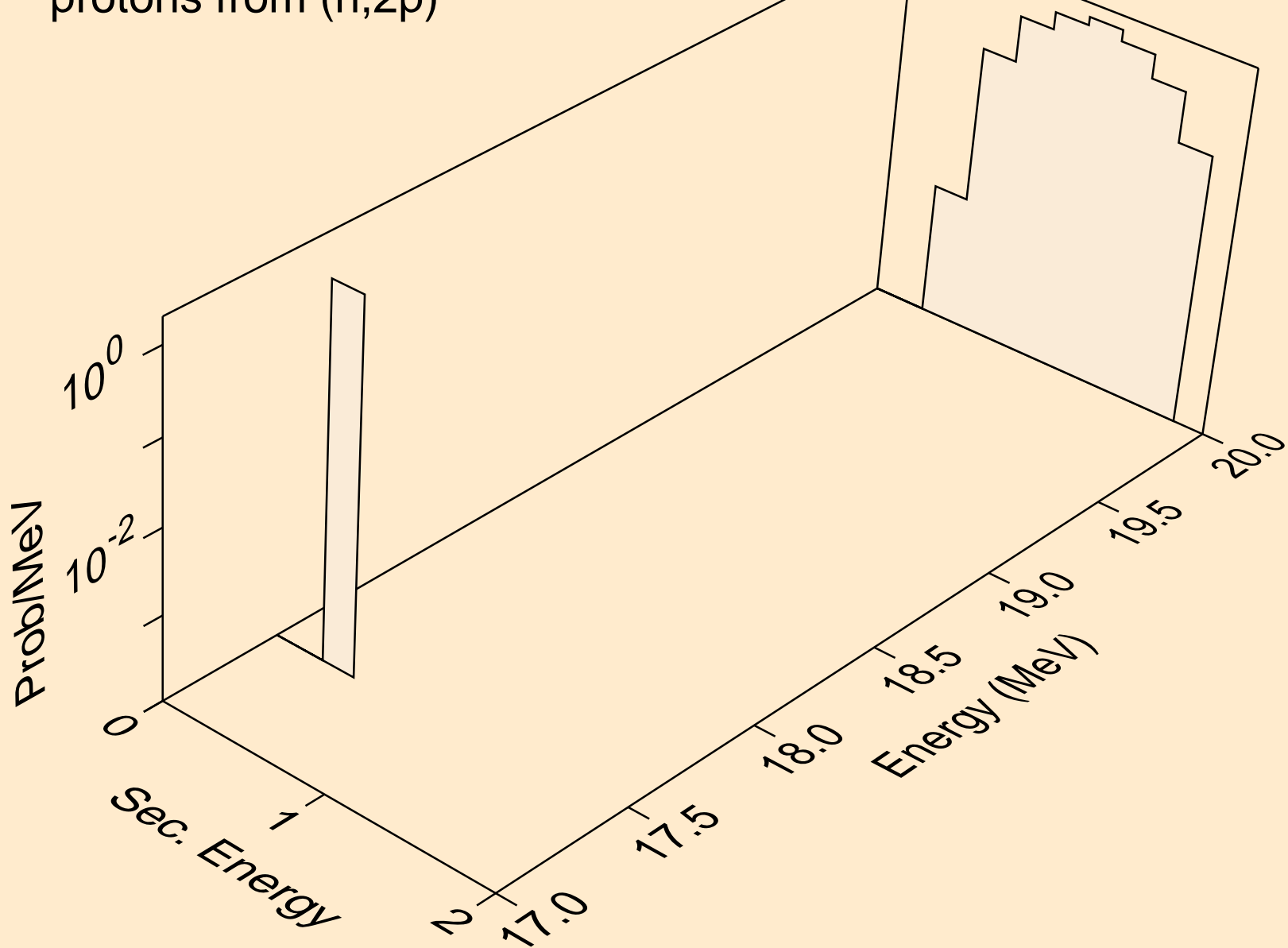



MAT=1325 ACE FILE PRODUCED AT NEA WITH NDEC  
protons from (n,pa)

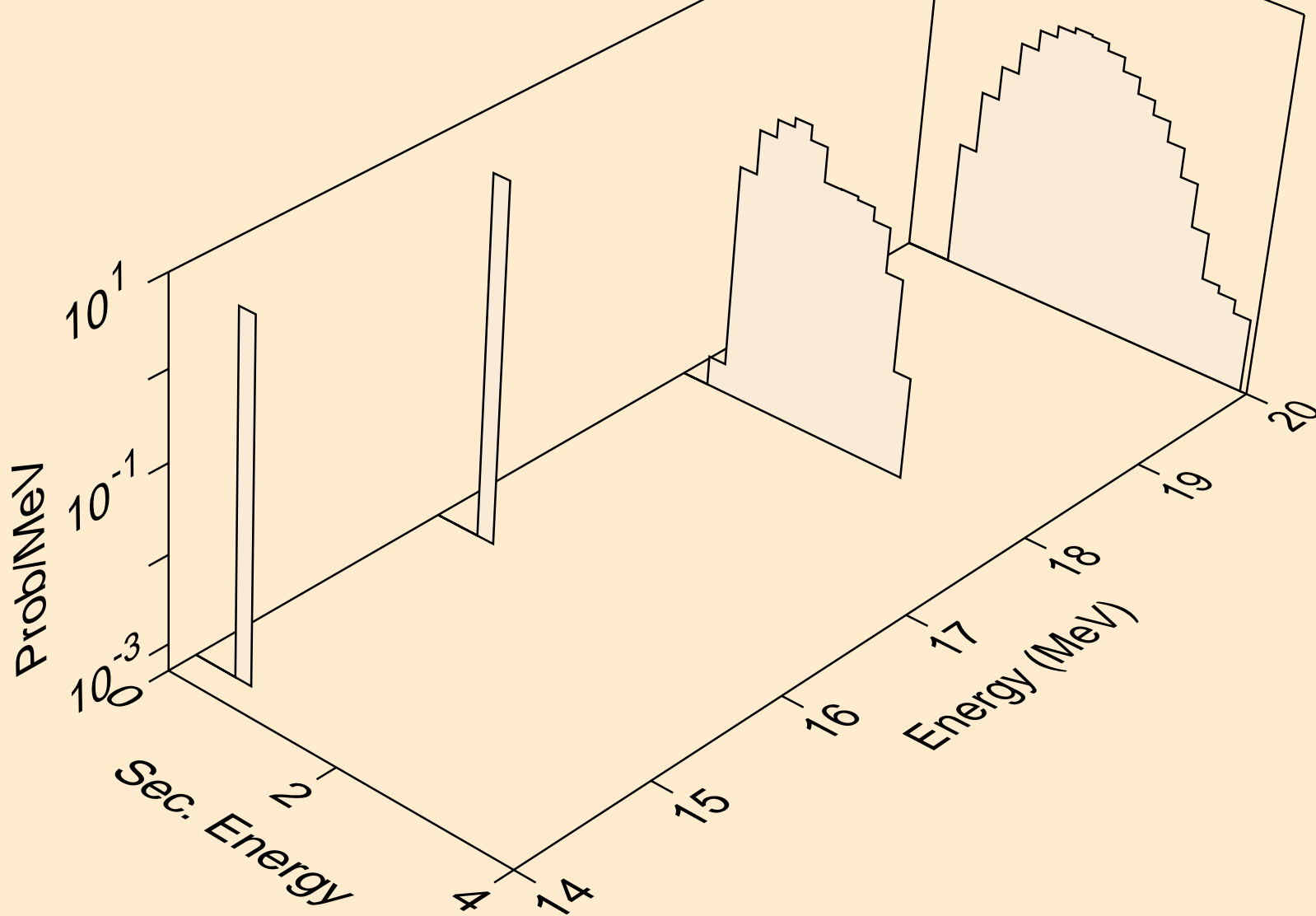

MAT=1325 ACE FILE PRODUCED AT NEA WITH NDEC  
angular distribution for (n,p\*0) proton

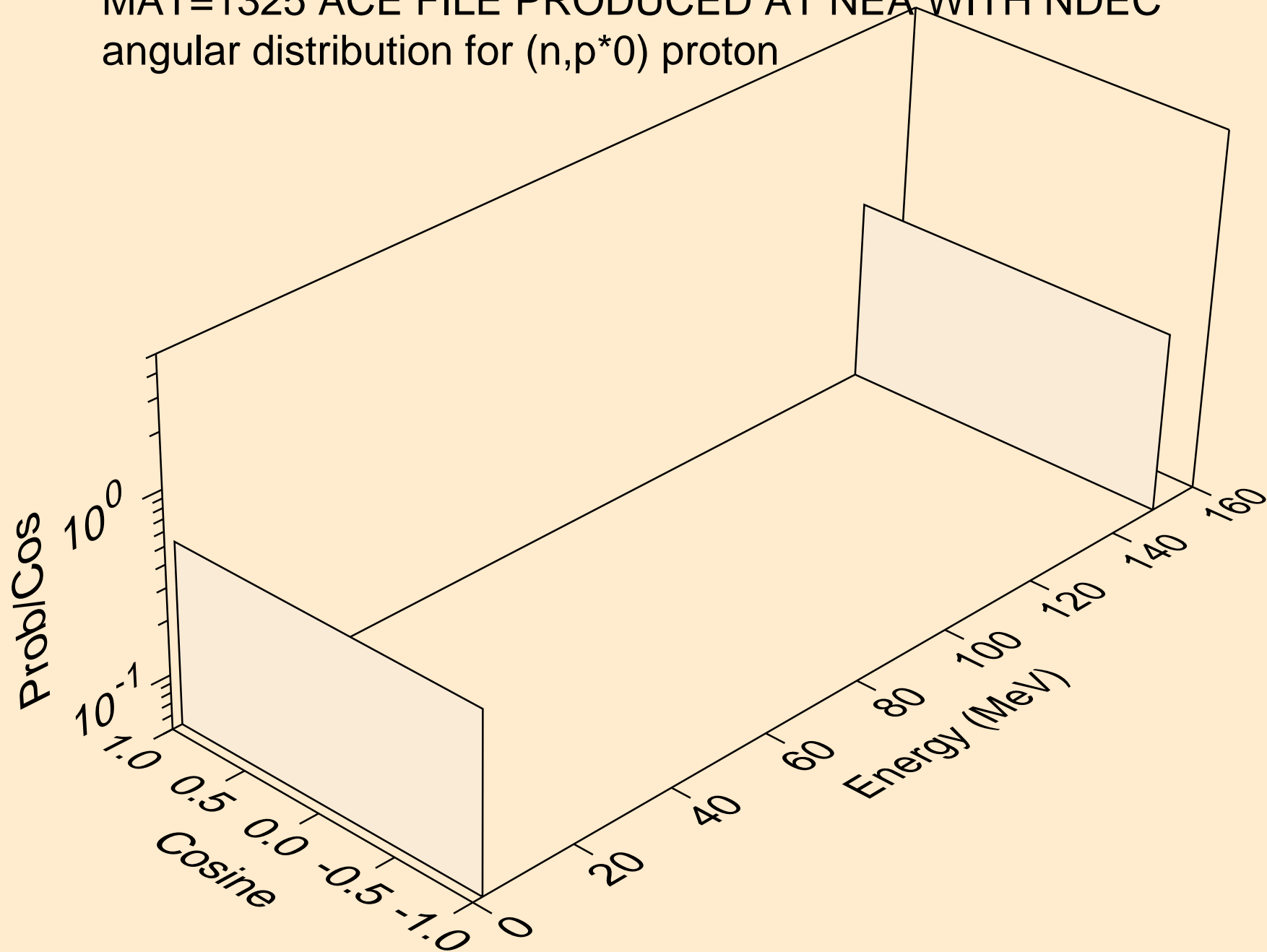

MAT=1325 ACE FILE PRODUCED AT NEA WITH NDEC  
angular distribution for (n,p\*1) proton

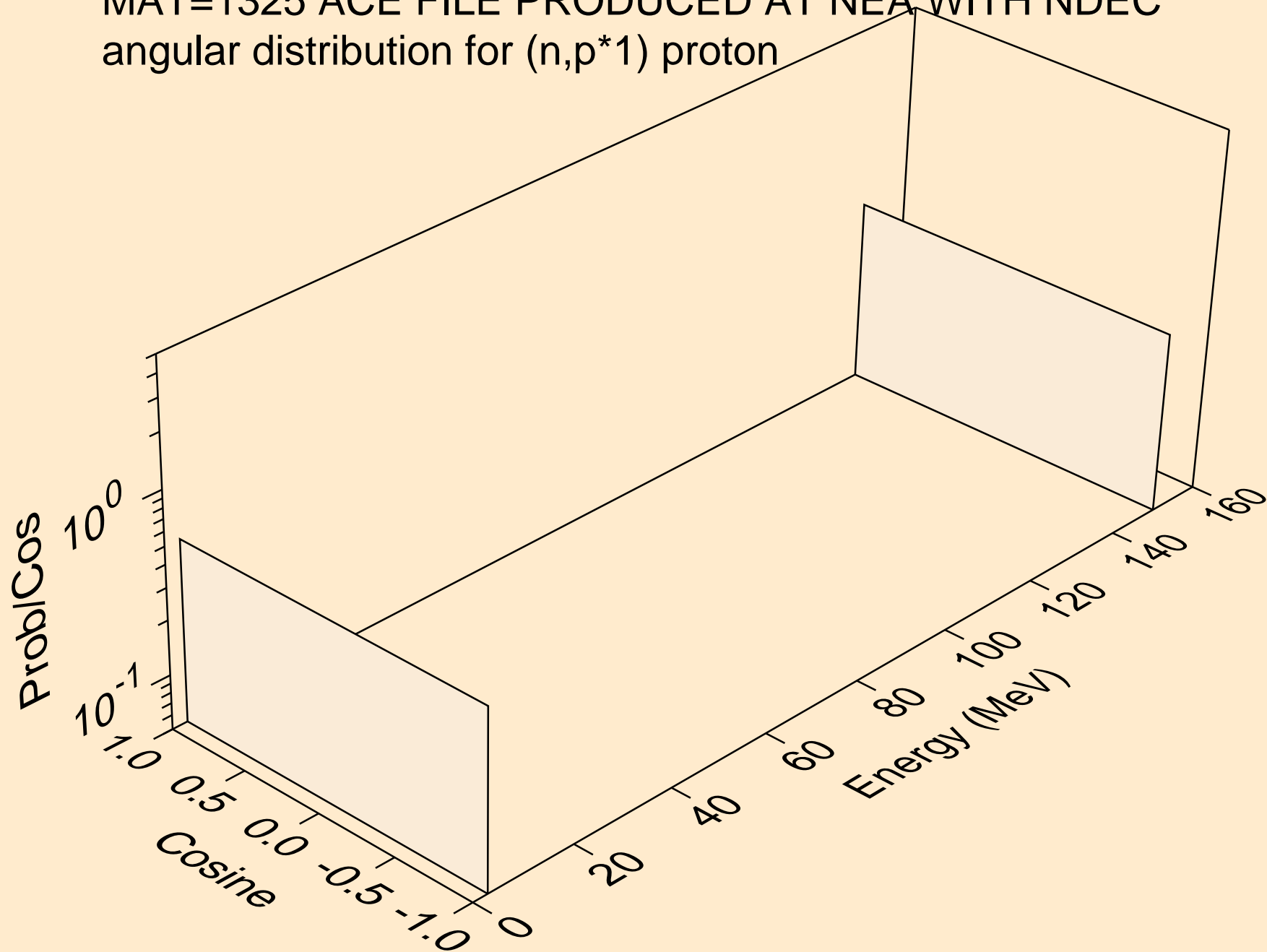

MAT=1325 ACE FILE PRODUCED AT NEA WITH NDEC  
angular distribution for (n,p\*2) proton

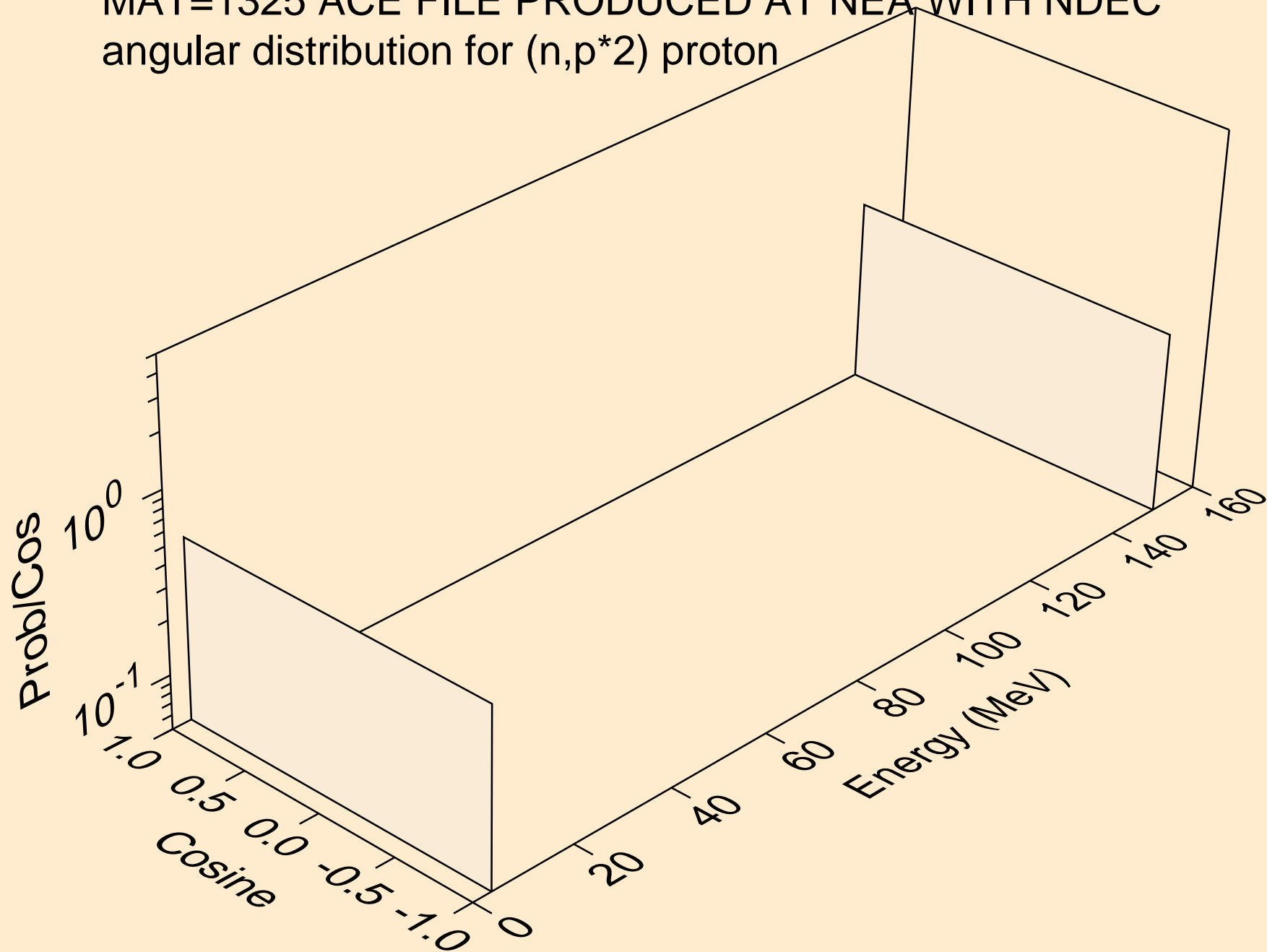

MAT=1325 ACE FILE PRODUCED AT NEA WITH NDEC  
angular distribution for (n,p\*3) proton

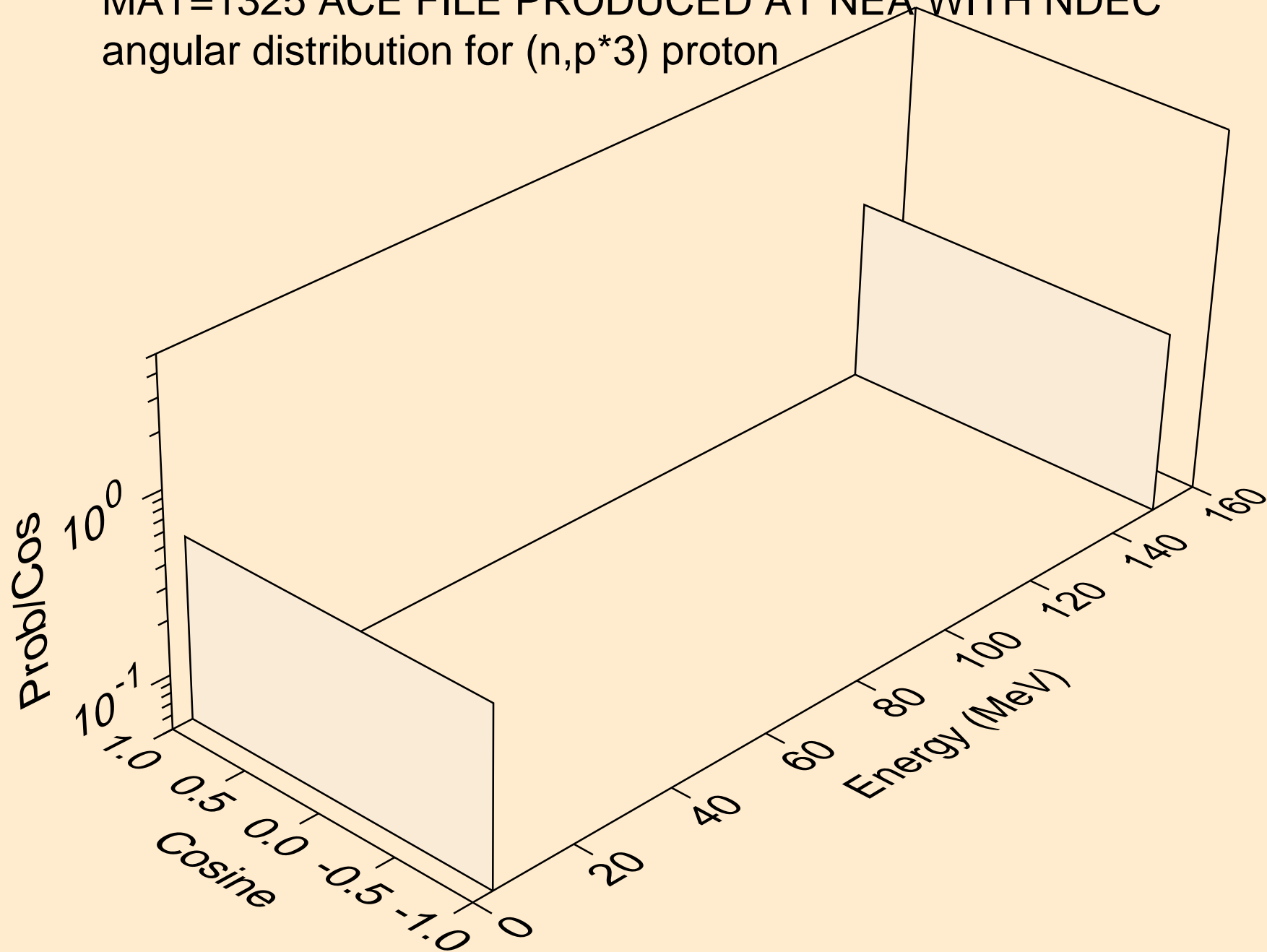

MAT=1325 ACE FILE PRODUCED AT NEA WITH NDEC  
angular distribution for (n,p\*4) proton

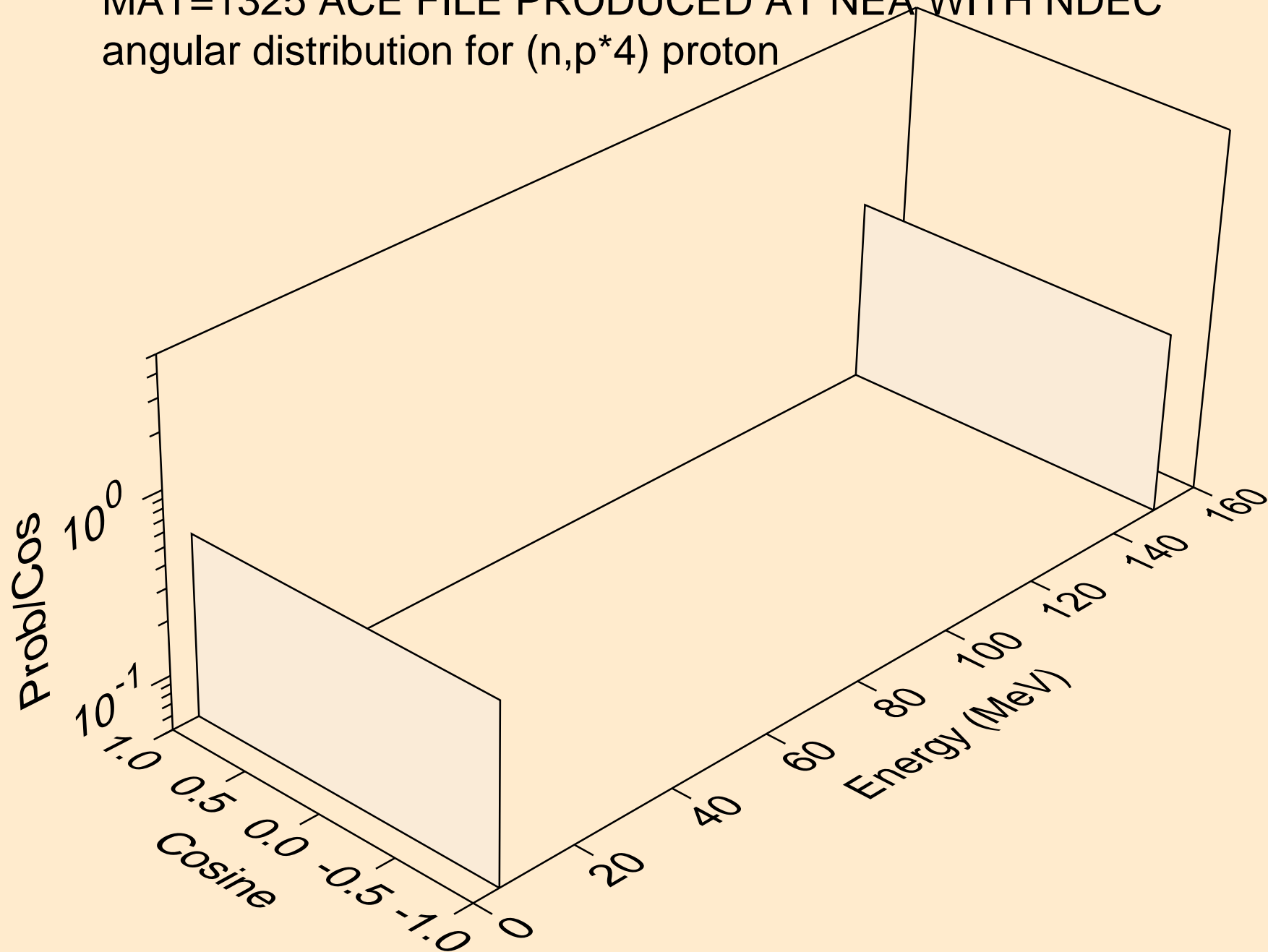

MAT=1325 ACE FILE PRODUCED AT NEA WITH NDEC  
angular distribution for (n,p\*5) proton

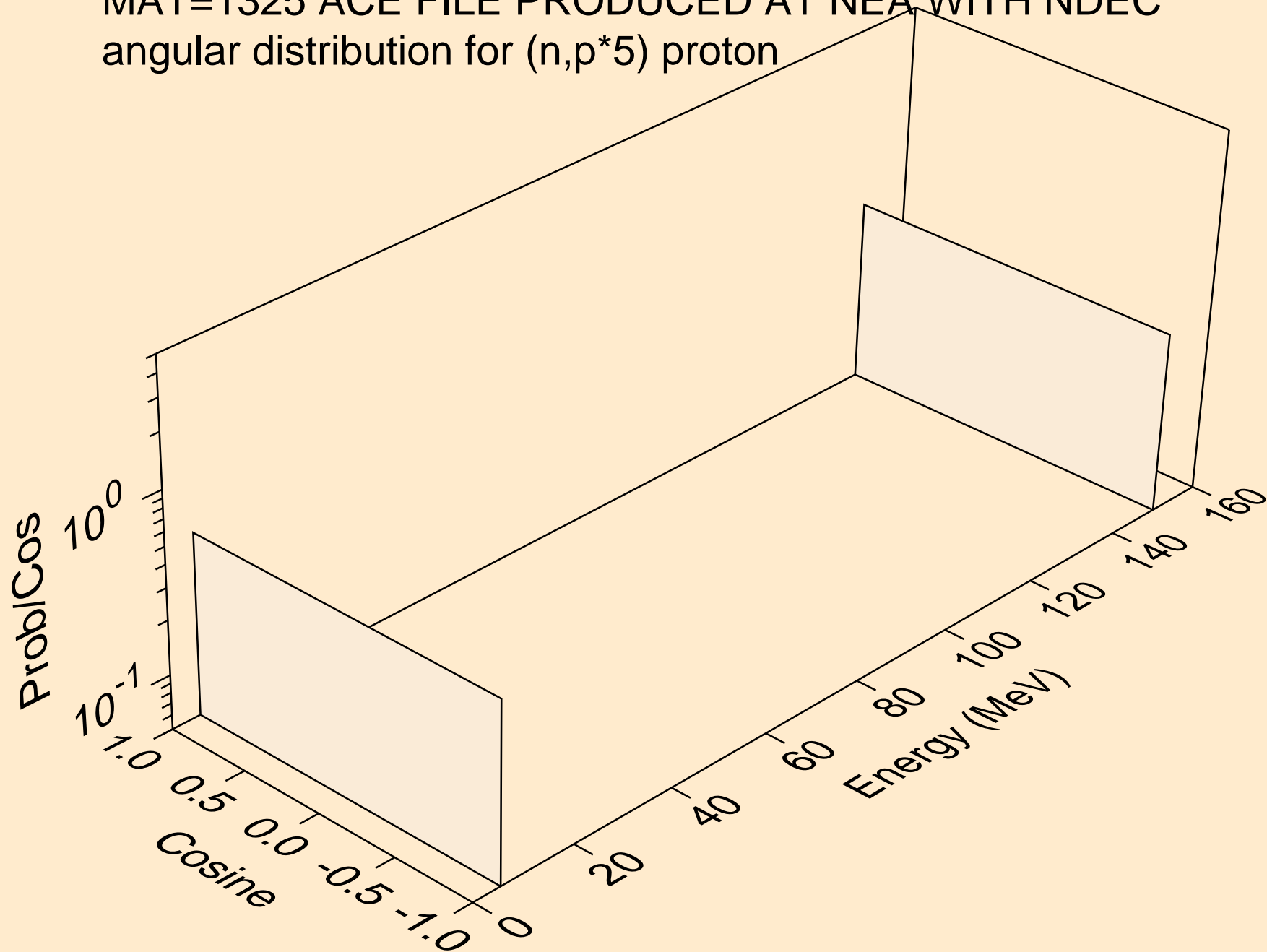

MAT=1325 ACE FILE PRODUCED AT NEA WITH NDEC  
angular distribution for (n,p\*6) proton

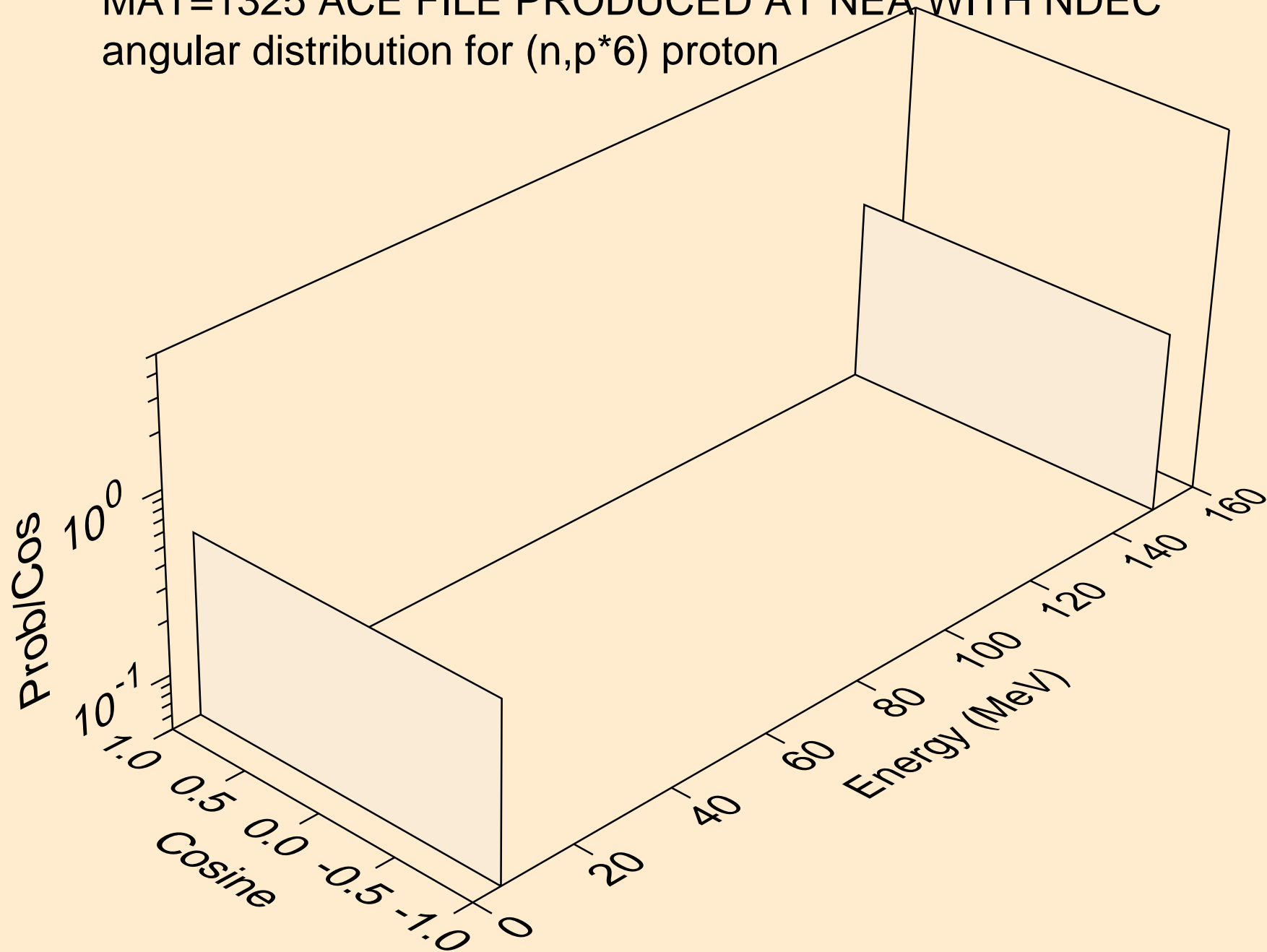



MAT=1325 ACE FILE PRODUCED AT NEA WITH NDEC  
angular distribution for (n,p\*7) proton

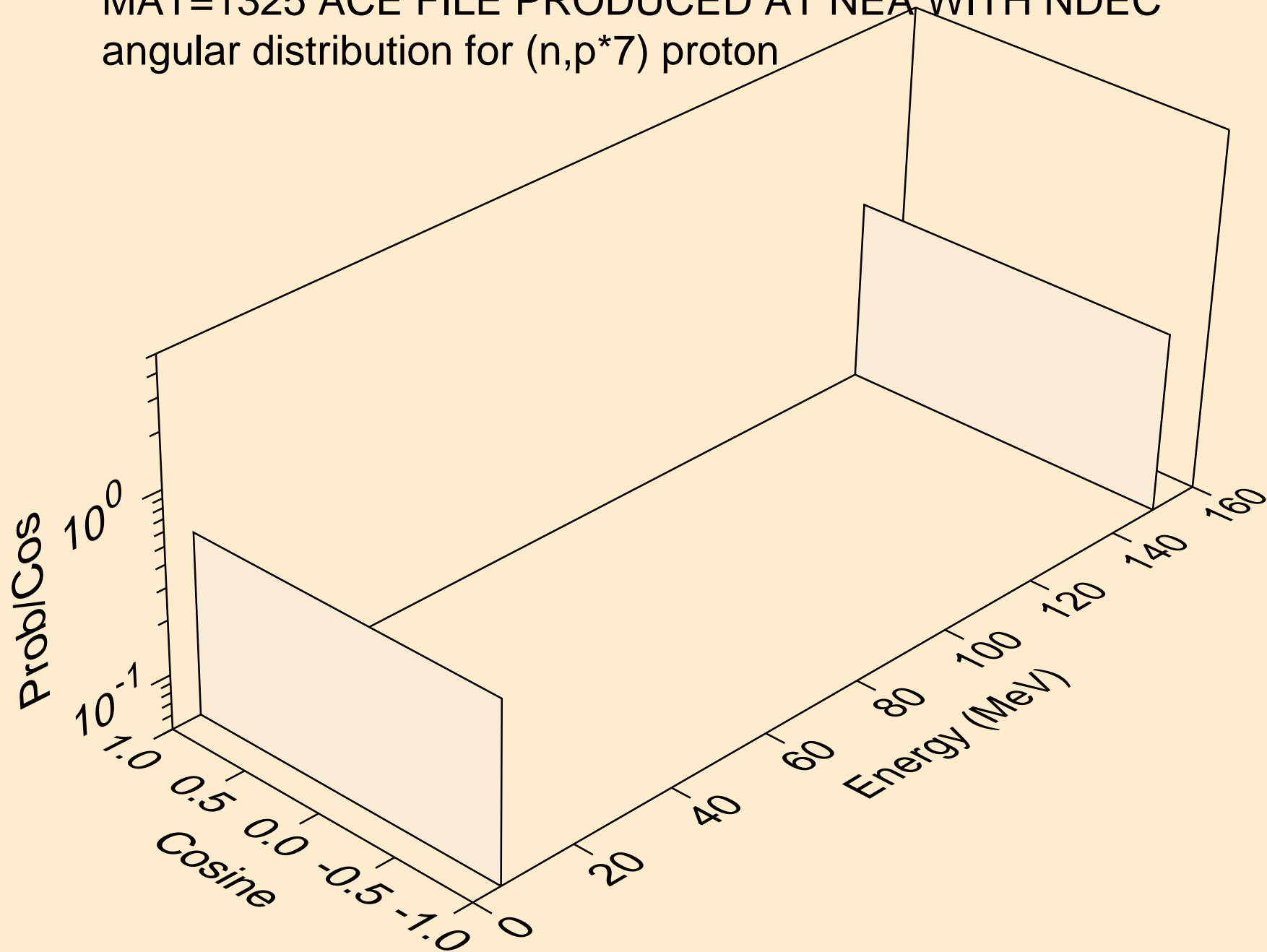

MAT=1325 ACE FILE PRODUCED AT NEA WITH NDEC  
angular distribution for (n,p\*8) proton

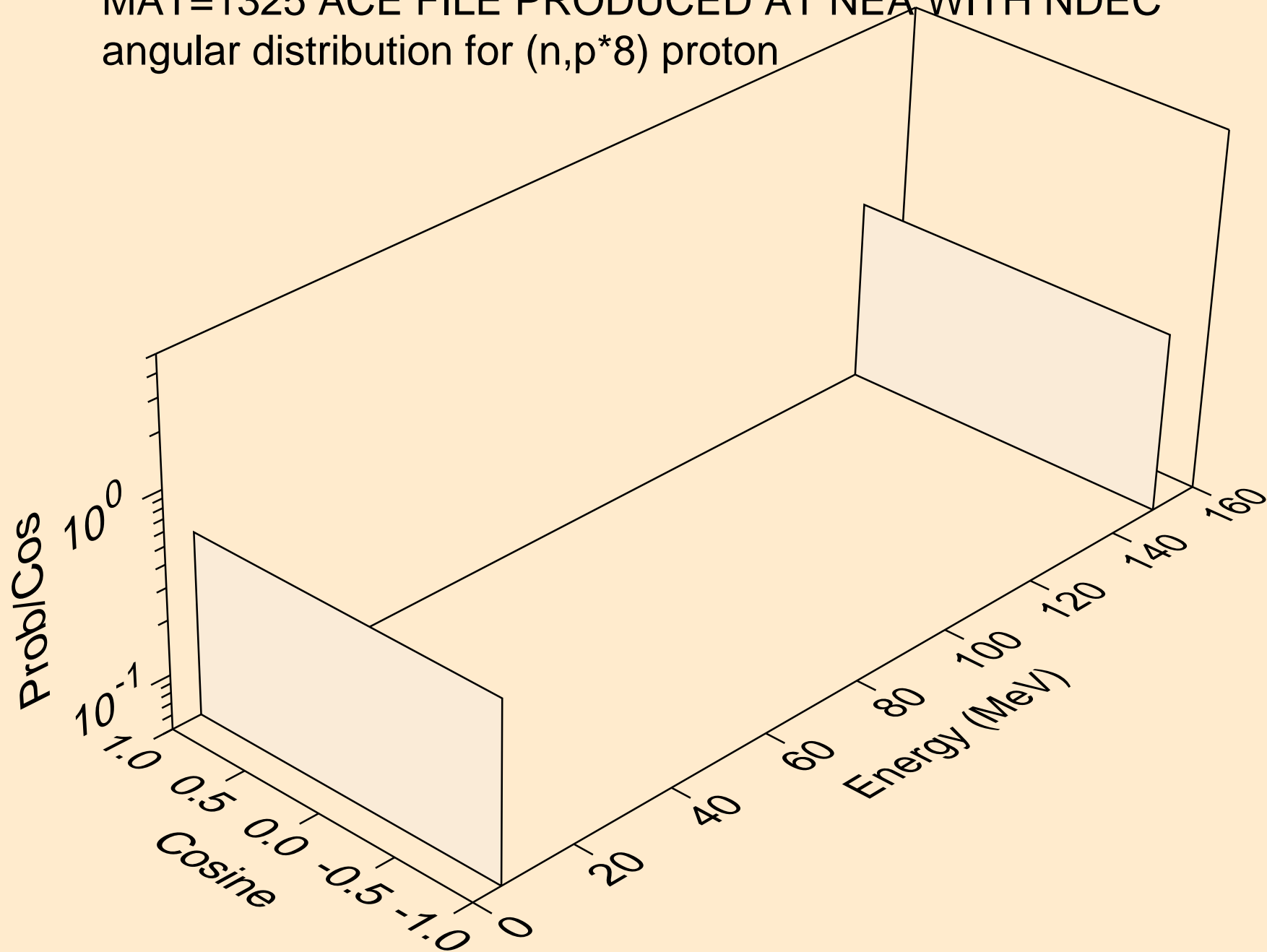

MAT=1325 ACE FILE PRODUCED AT NEA WITH NDEC  
angular distribution for (n,p\*9) proton

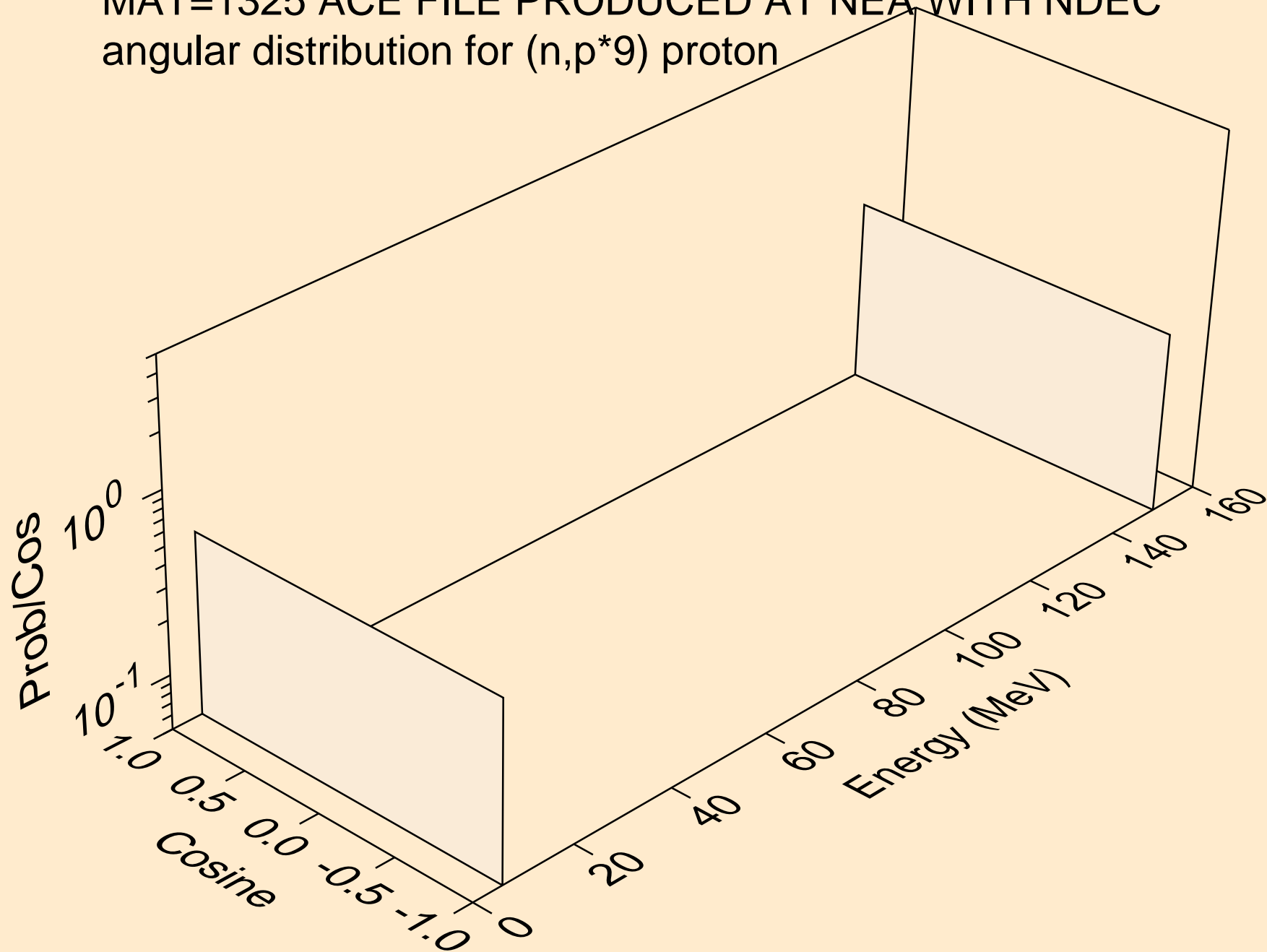

MAT=1325 ACE FILE PRODUCED AT NEA WITH NDEC  
angular distribution for (n,p\*10) proton

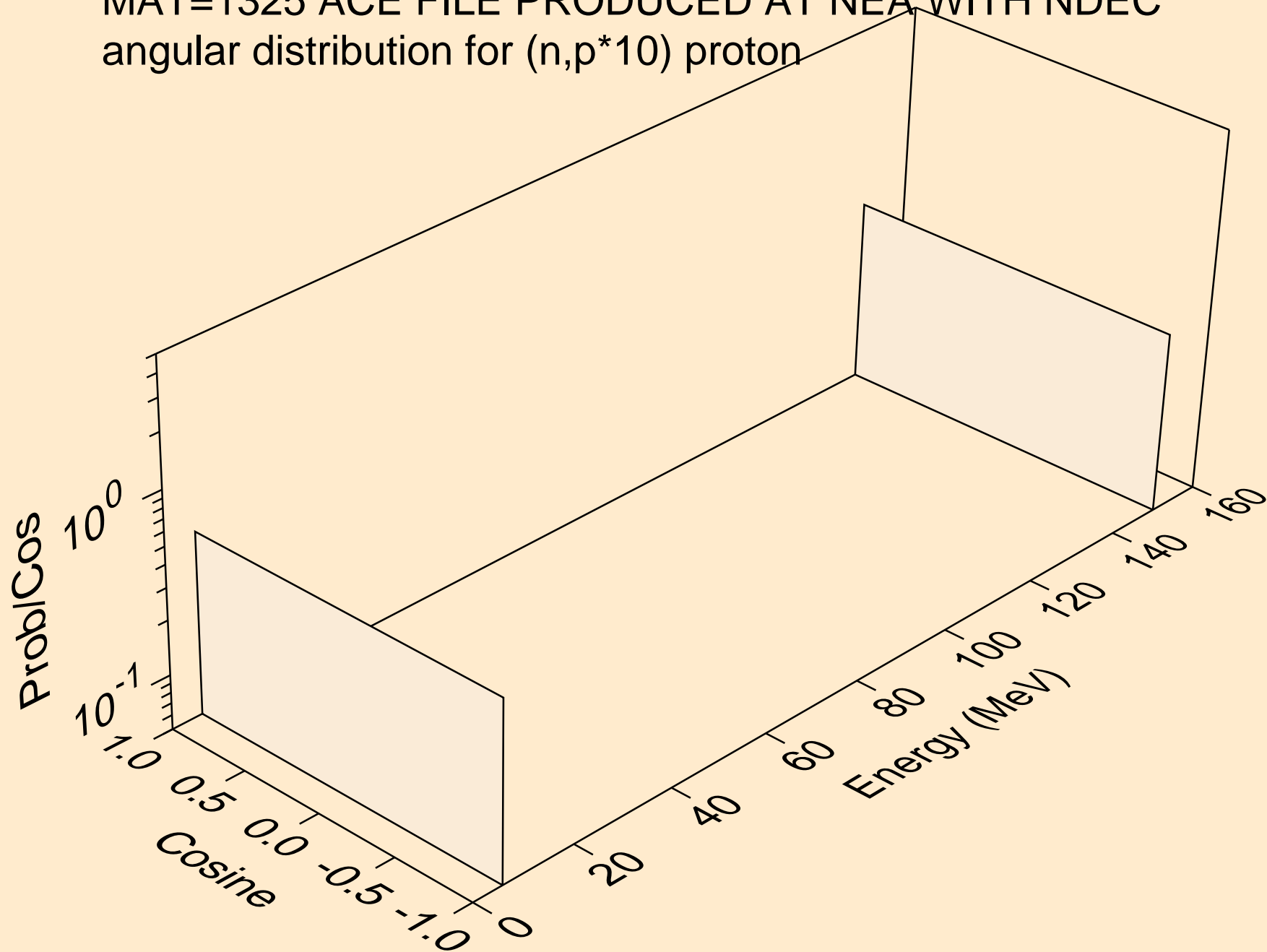

MAT=1325 ACE FILE PRODUCED AT NEA WITH NDEC  
angular distribution for (n,p\*11) proton

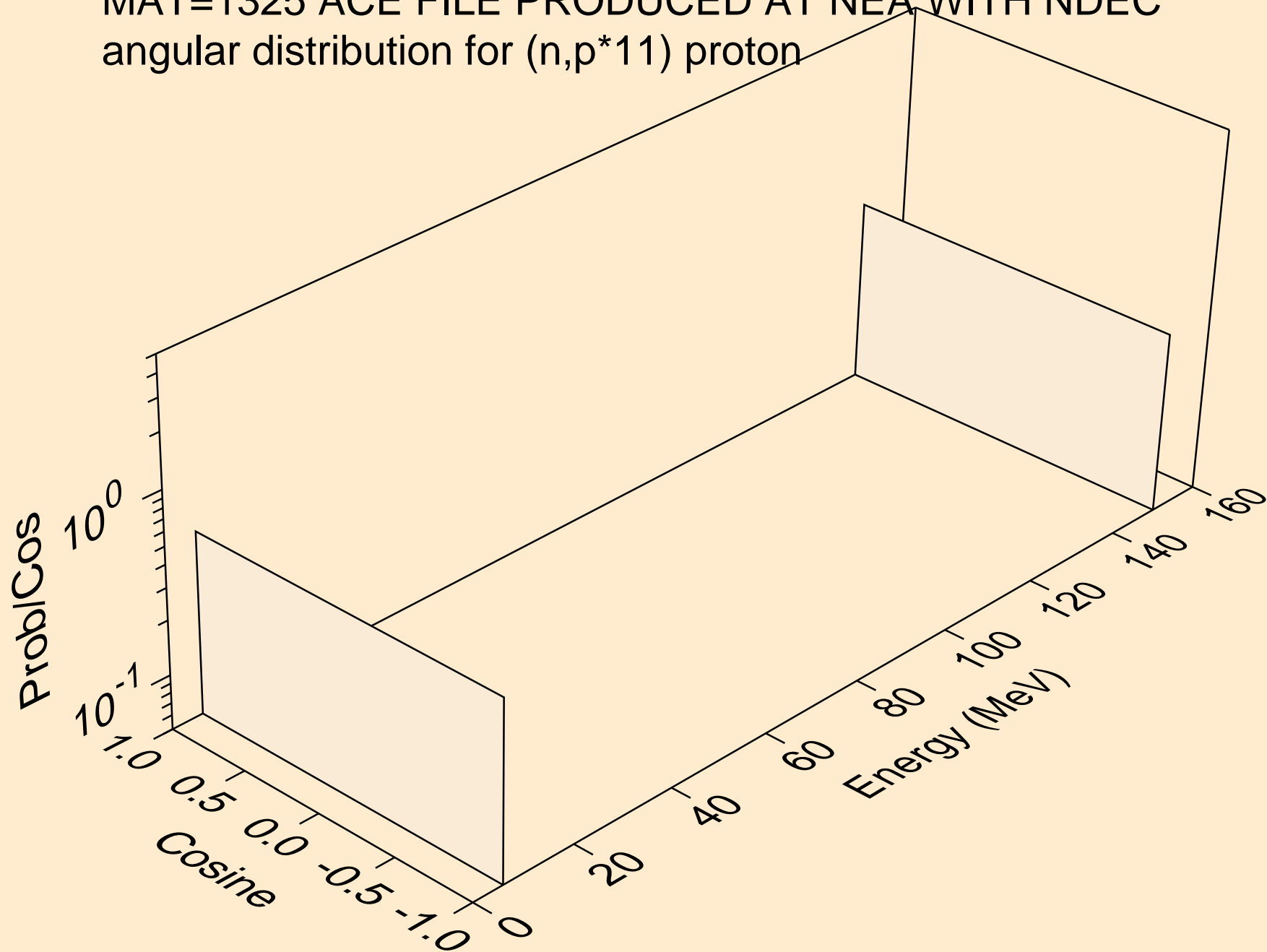

MAT=1325 ACE FILE PRODUCED AT NEA WITH NDEC  
angular distribution for (n,p\*12) proton

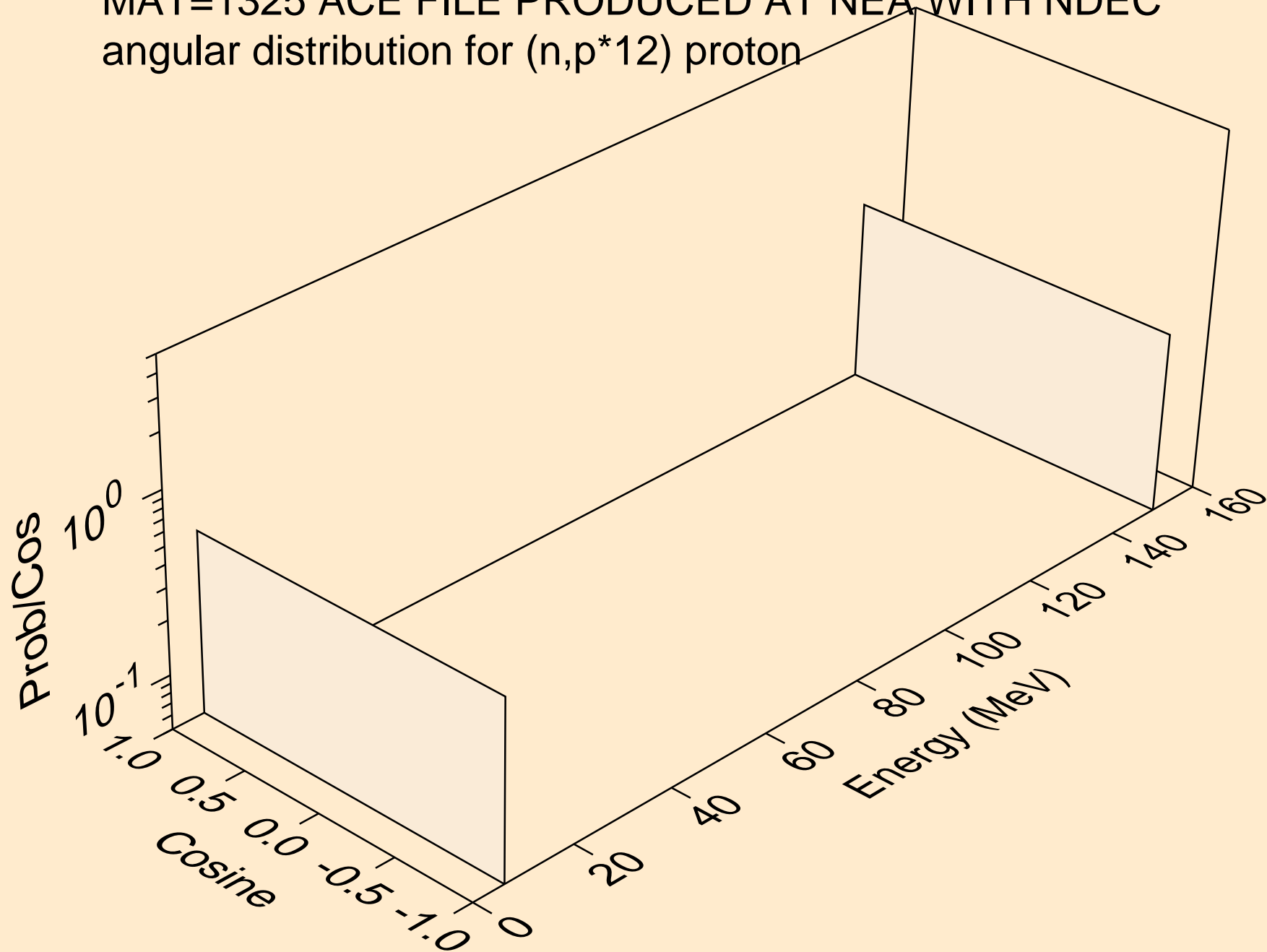

MAT=1325 ACE FILE PRODUCED AT NEA WITH NDEC  
angular distribution for (n,p\*13) proton

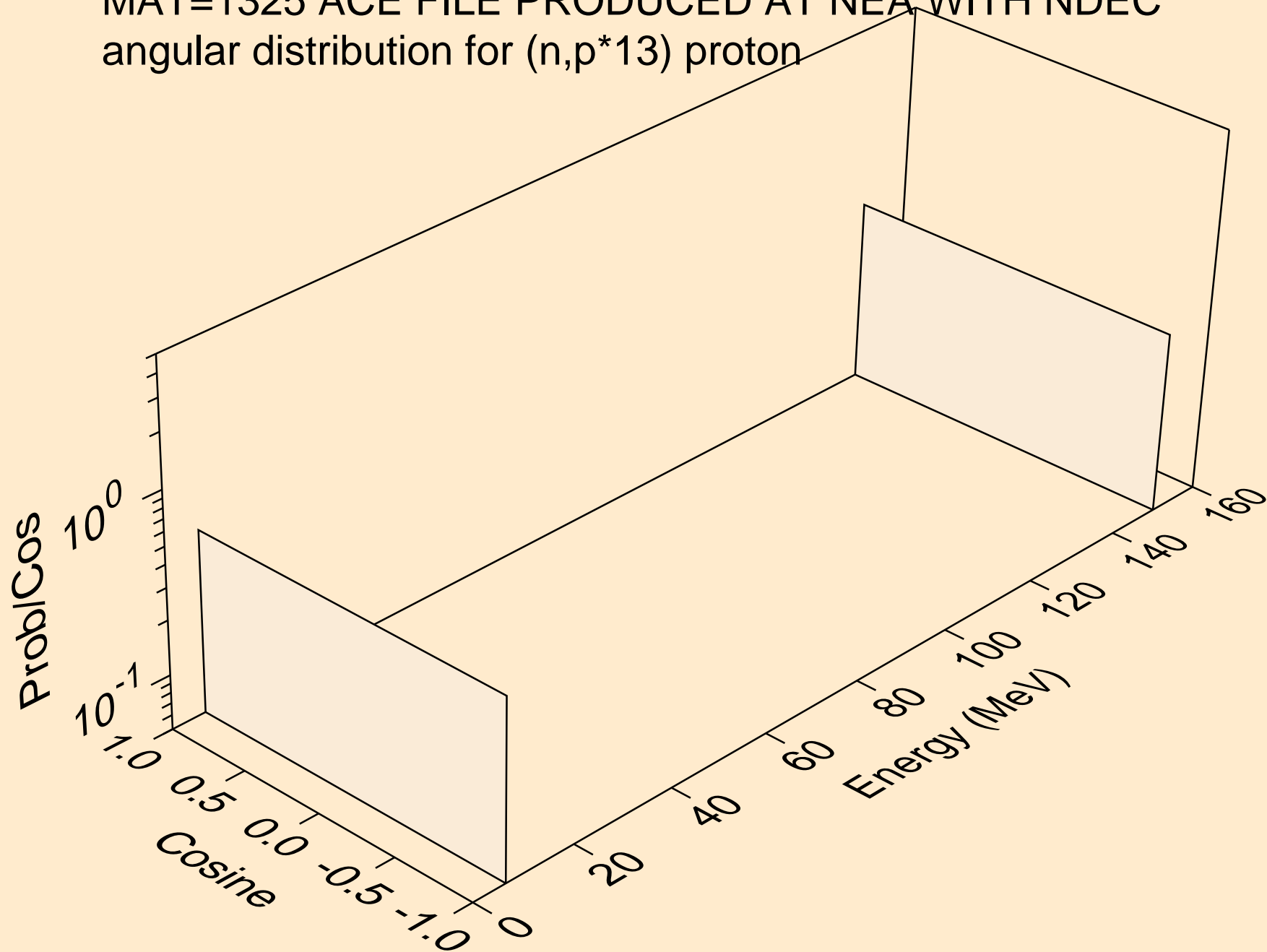

MAT=1325 ACE FILE PRODUCED AT NEA WITH NDEC  
angular distribution for (n,p\*14) proton

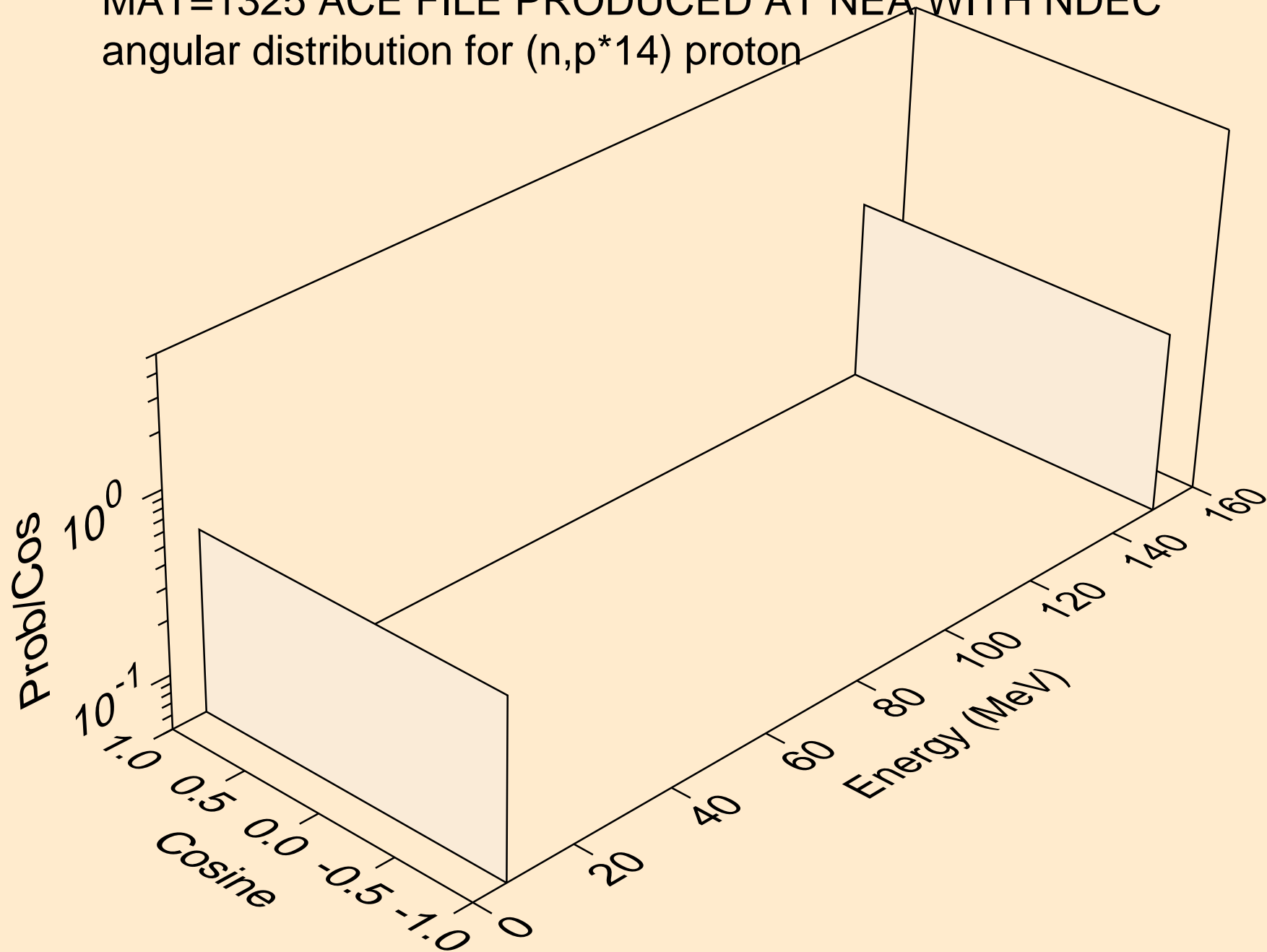



MAT=1325 ACE FILE PRODUCED AT NEA WITH NDEC  
angular distribution for (n,p\*15) proton

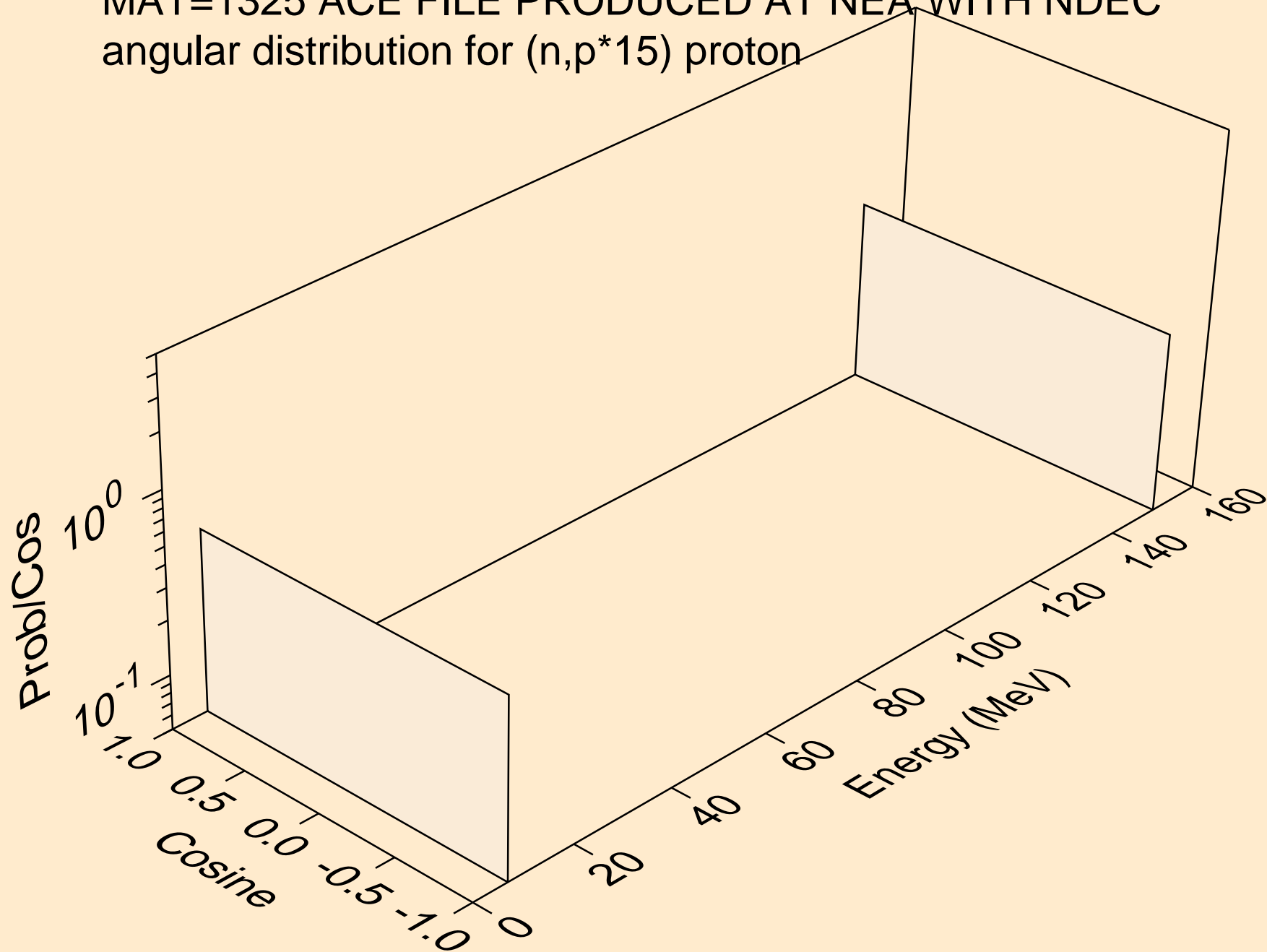

MAT=1325 ACE FILE PRODUCED AT NEA WITH NDEC  
angular distribution for (n,p\*16) proton

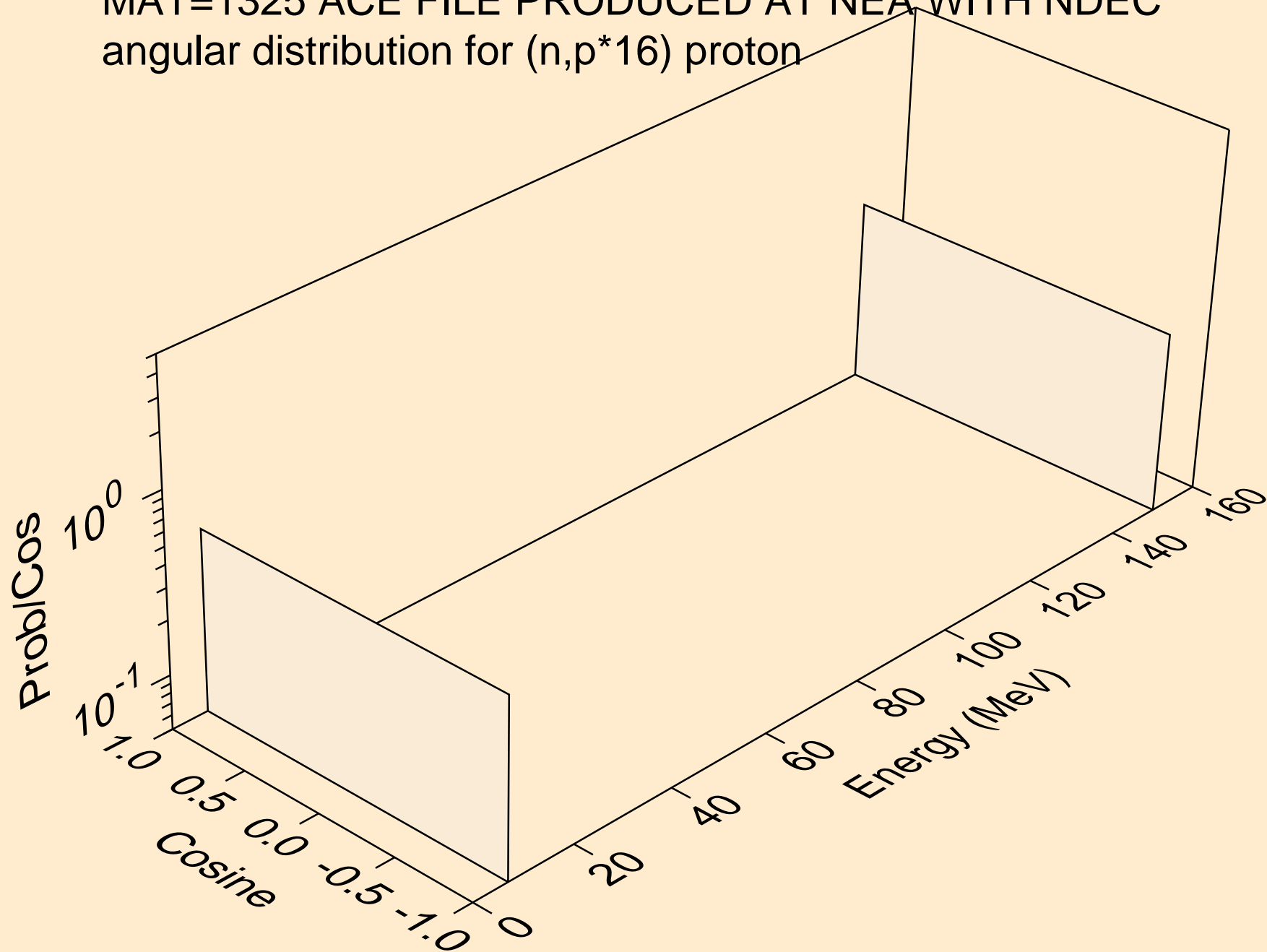

MAT=1325 ACE FILE PRODUCED AT NEA WITH NDEC  
angular distribution for (n,p\*17) proton

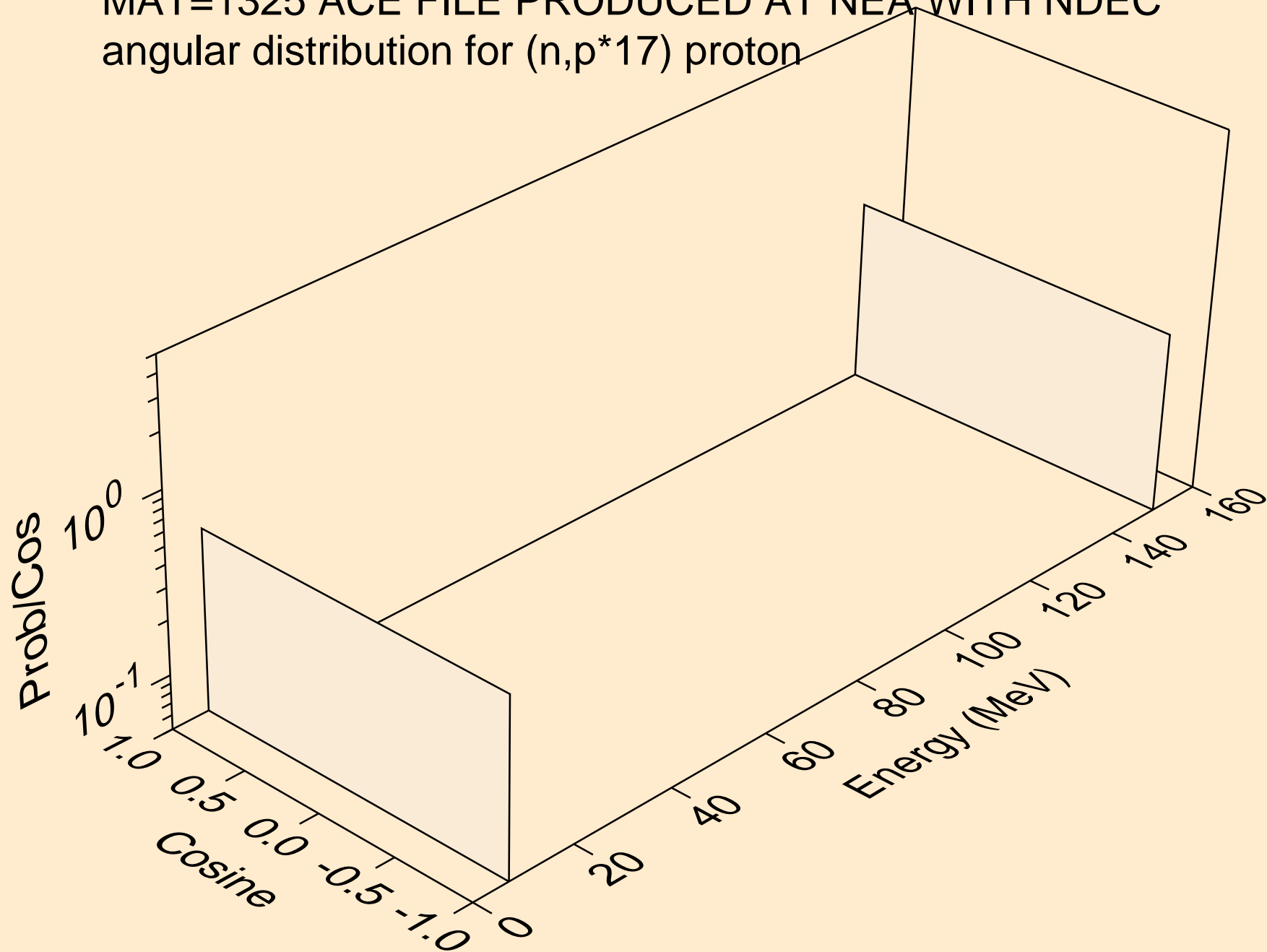

MAT=1325 ACE FILE PRODUCED AT NEA WITH NDEC  
angular distribution for (n,p\*18) proton

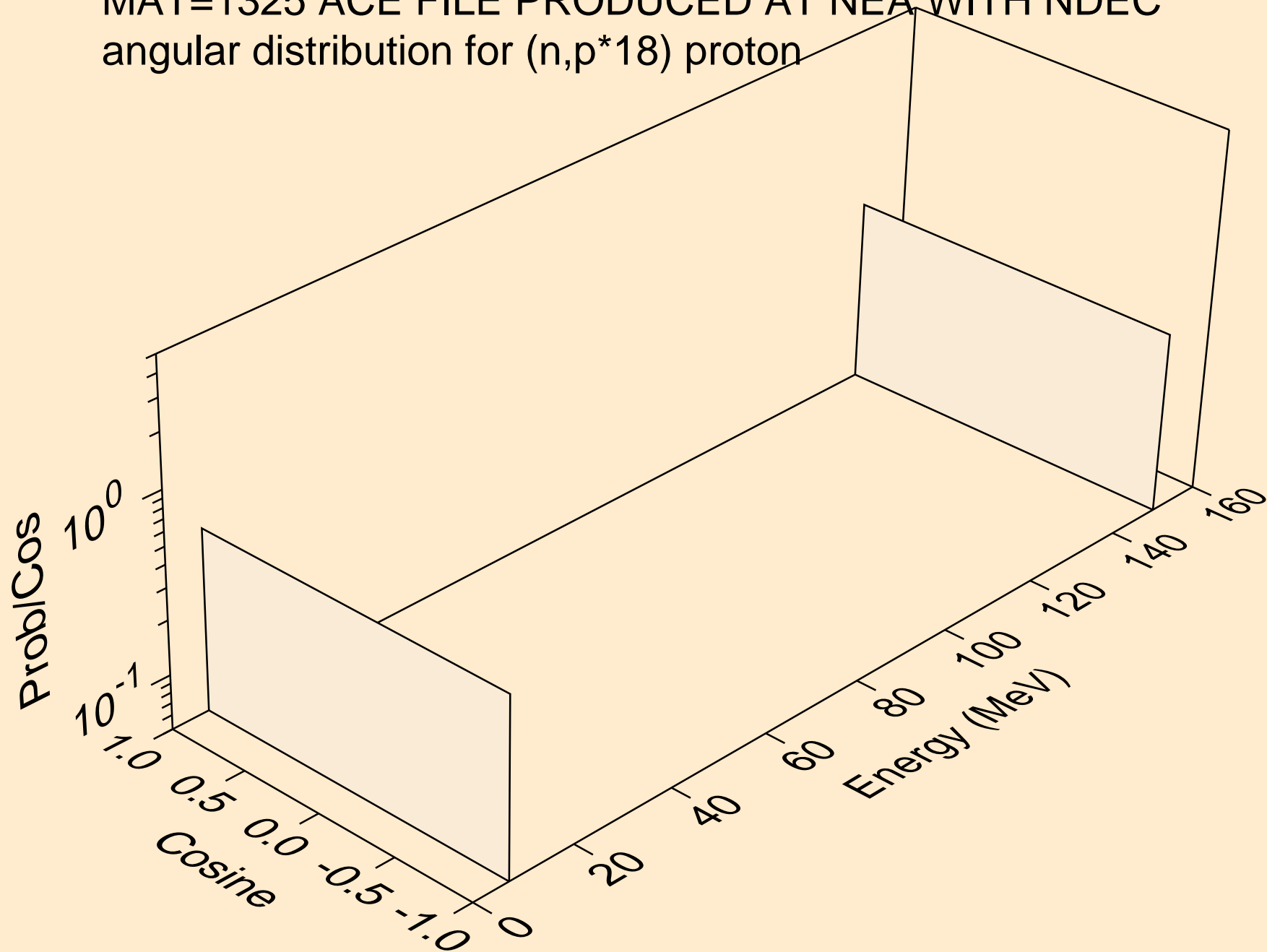

MAT=1325 ACE FILE PRODUCED AT NEA WITH NDEC  
angular distribution for (n,p\*19) proton

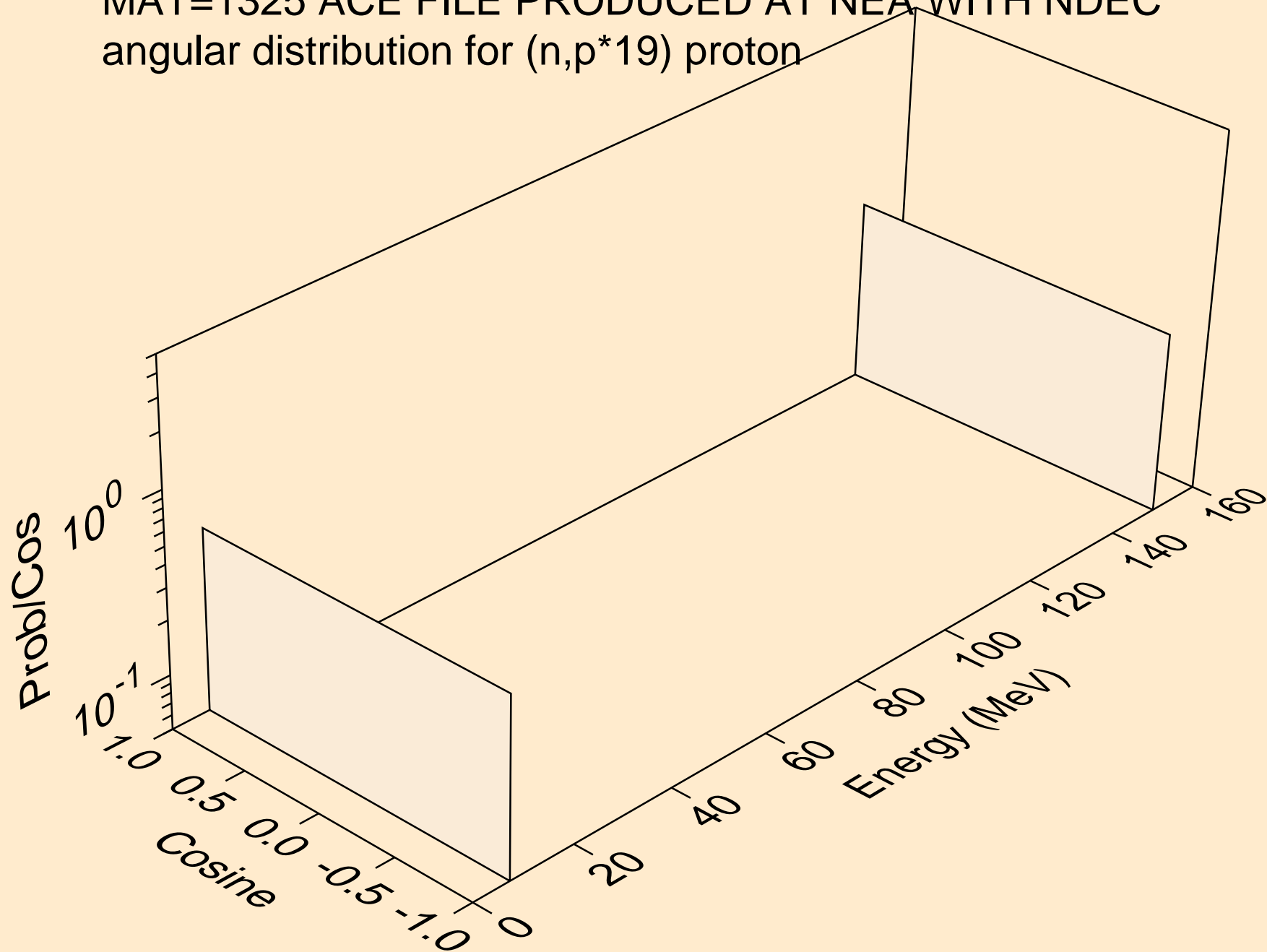

MAT=1325 ACE FILE PRODUCED AT NEA WITH NDEC  
protons from (n,p\*c)

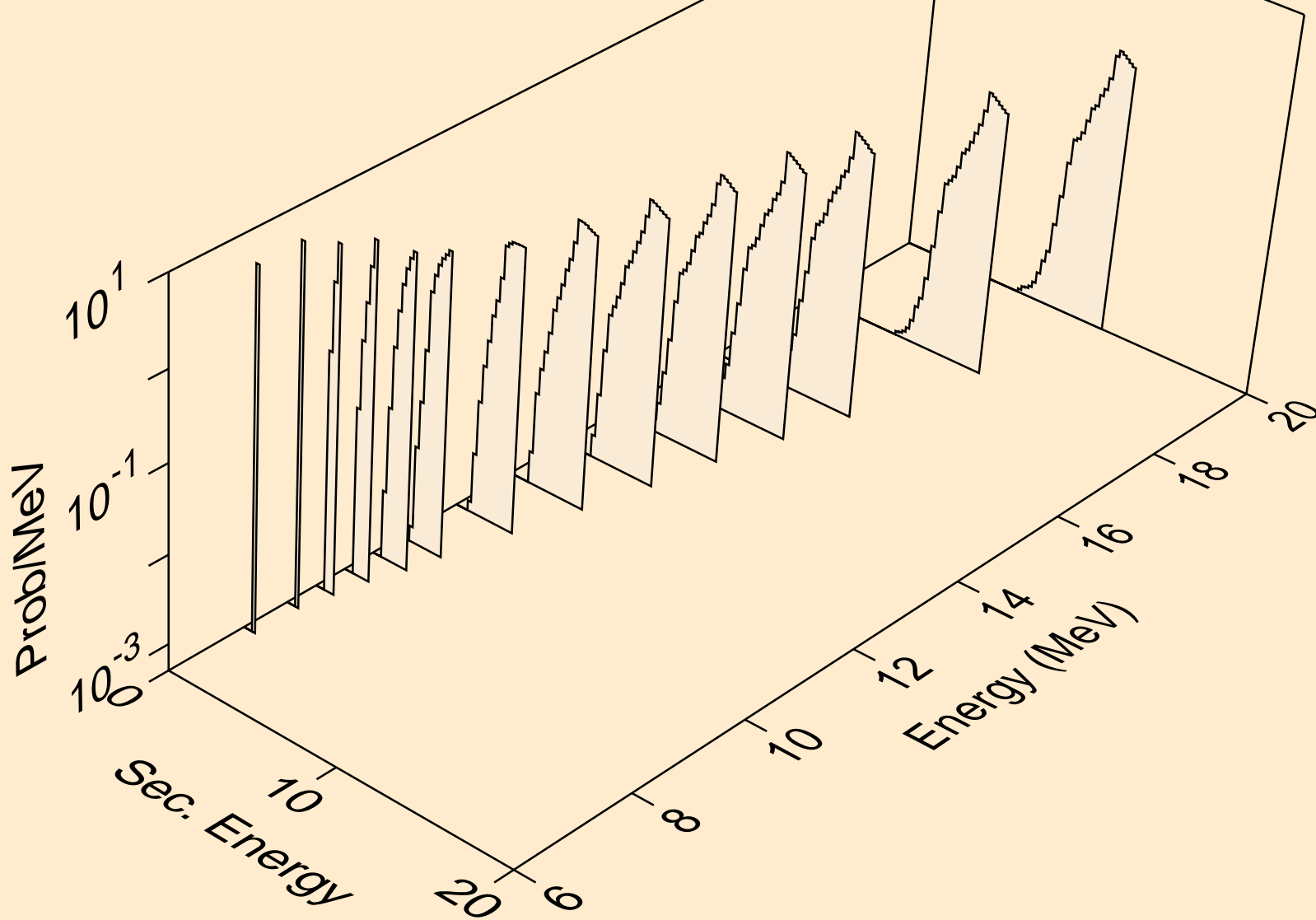

MAT=1325 ACE FILE PRODUCED AT NEA WITH NDEC  
deuterons from (n,x)

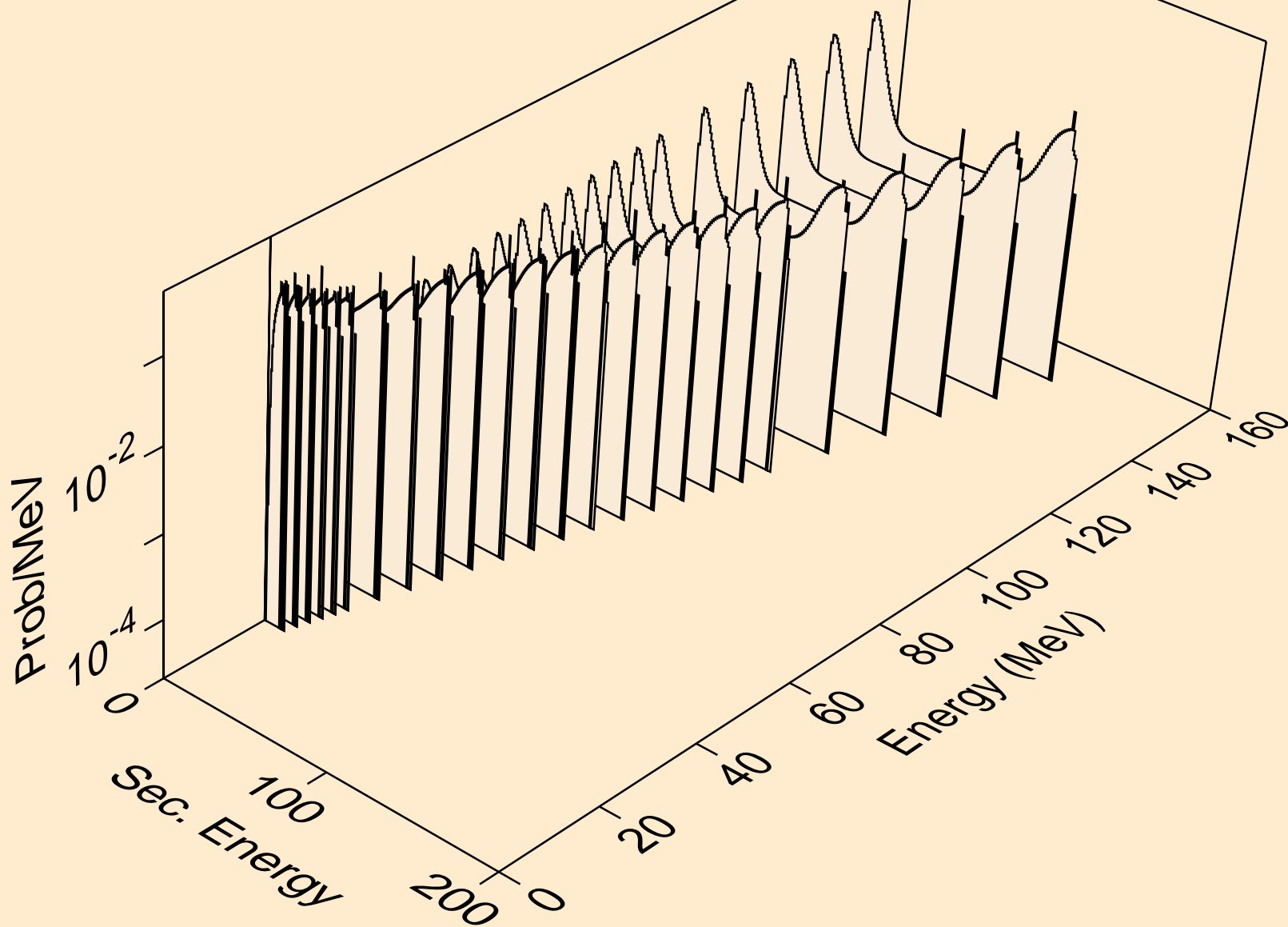

MAT=1325 ACE FILE PRODUCED AT NEA WITH NDEC  
deuterons from (n,n\*)d

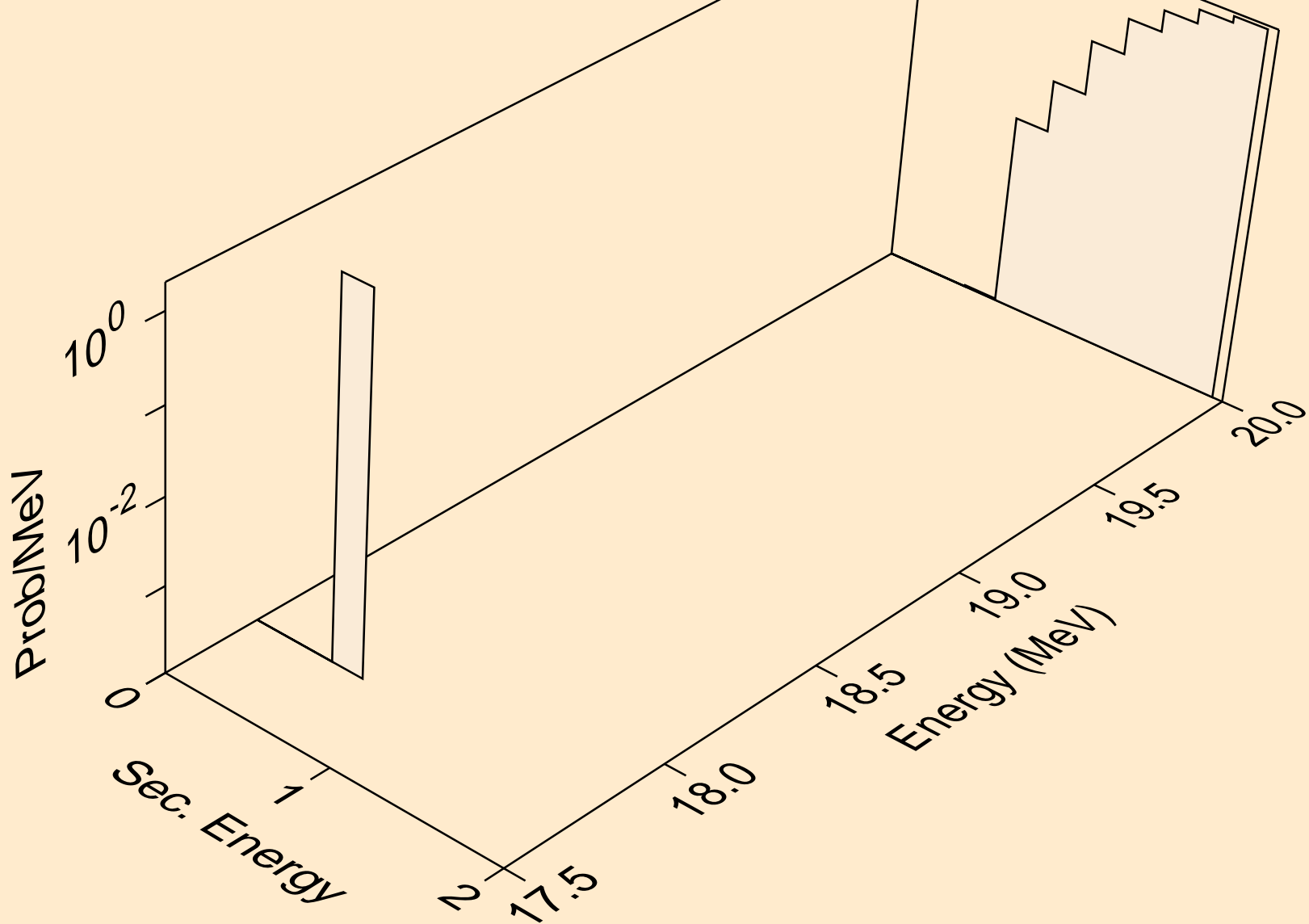



MAT=1325 ACE FILE PRODUCED AT NEA WITH NDEC  
deuterons from (n,da)

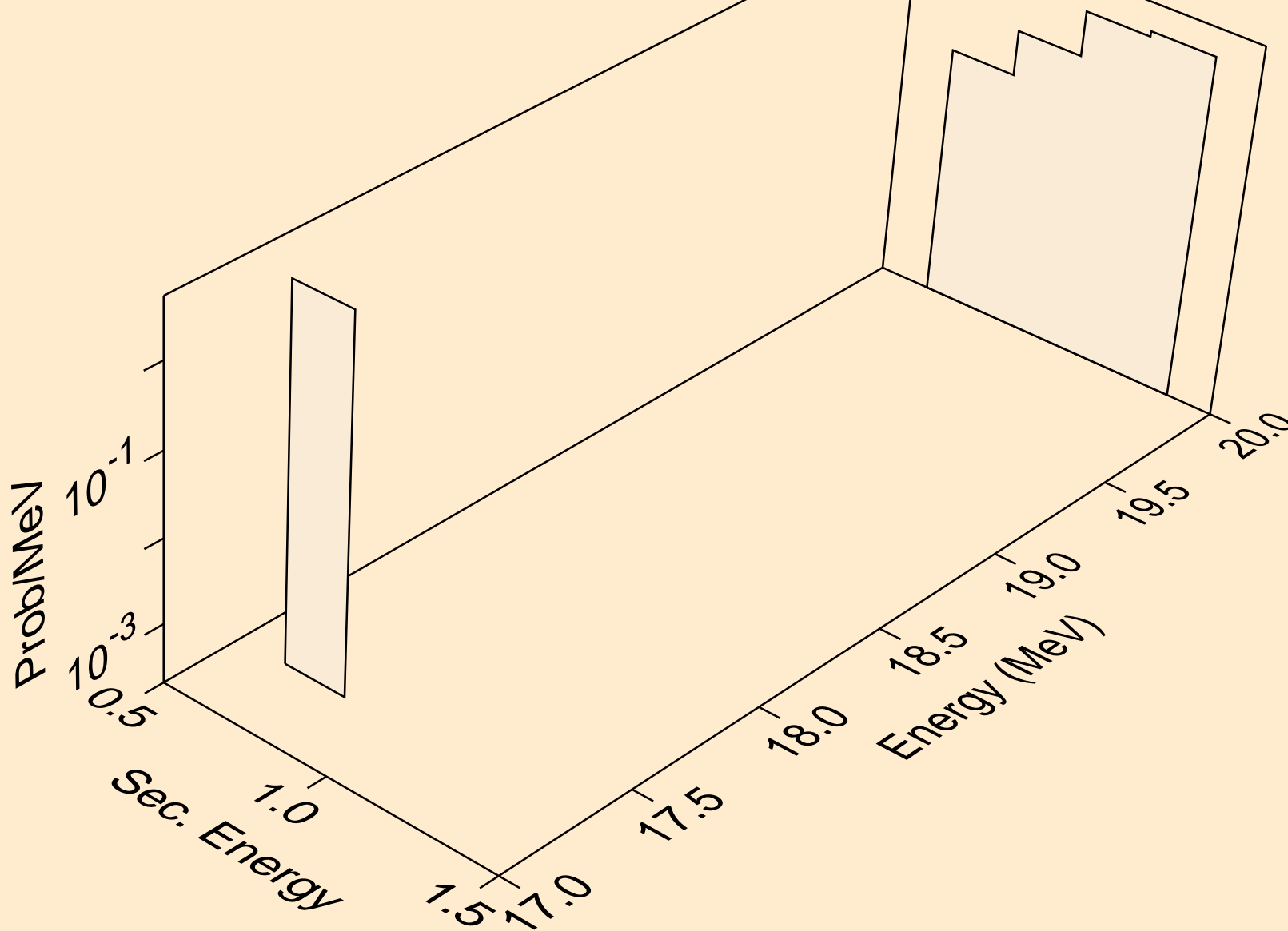

MAT=1325 ACE FILE PRODUCED AT NEA WITH NDEC  
angular distribution for (n,d\*0) deuteron

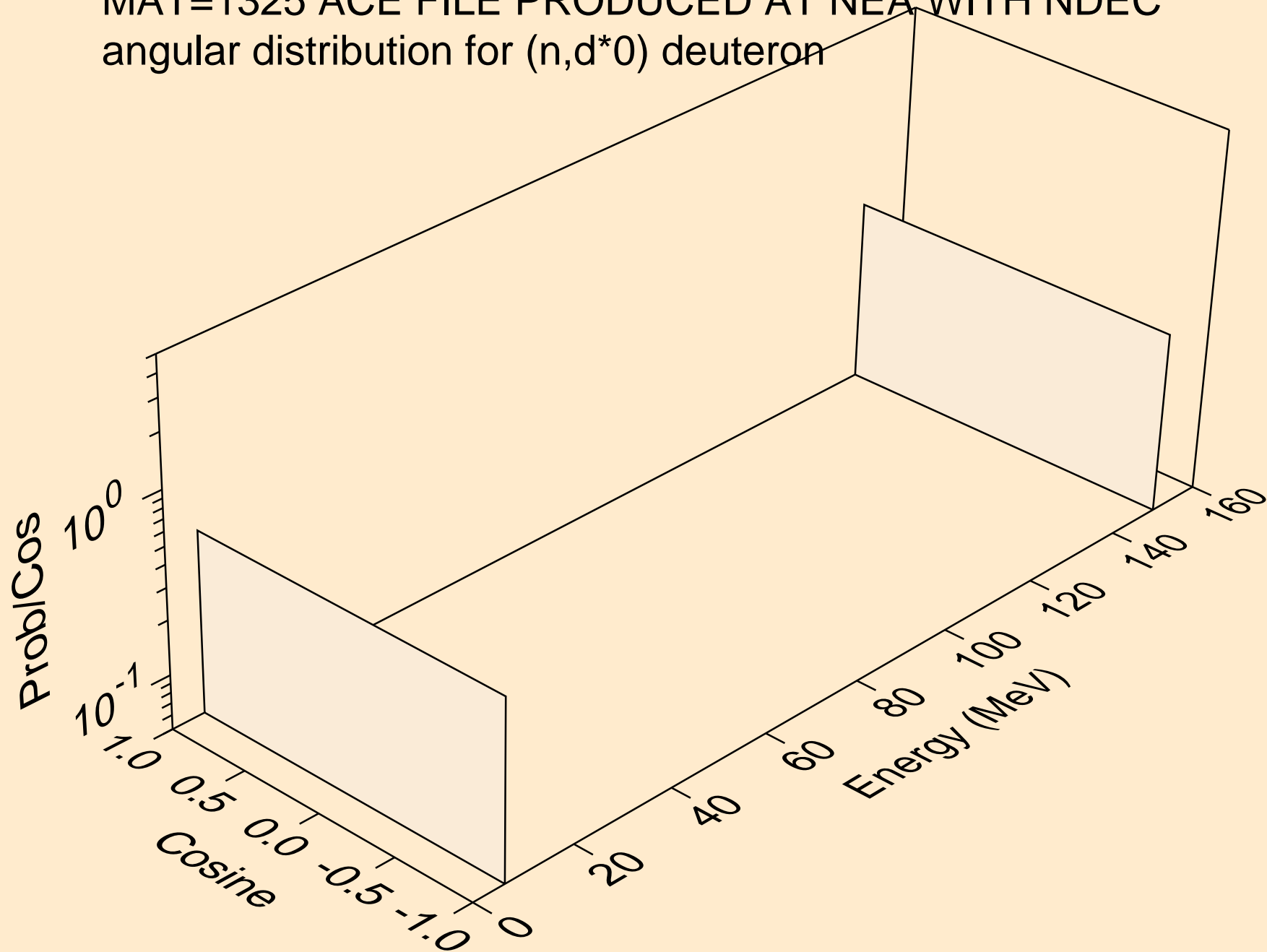

MAT=1325 ACE FILE PRODUCED AT NEA WITH NDEC  
angular distribution for (n,d\*1) deuteron

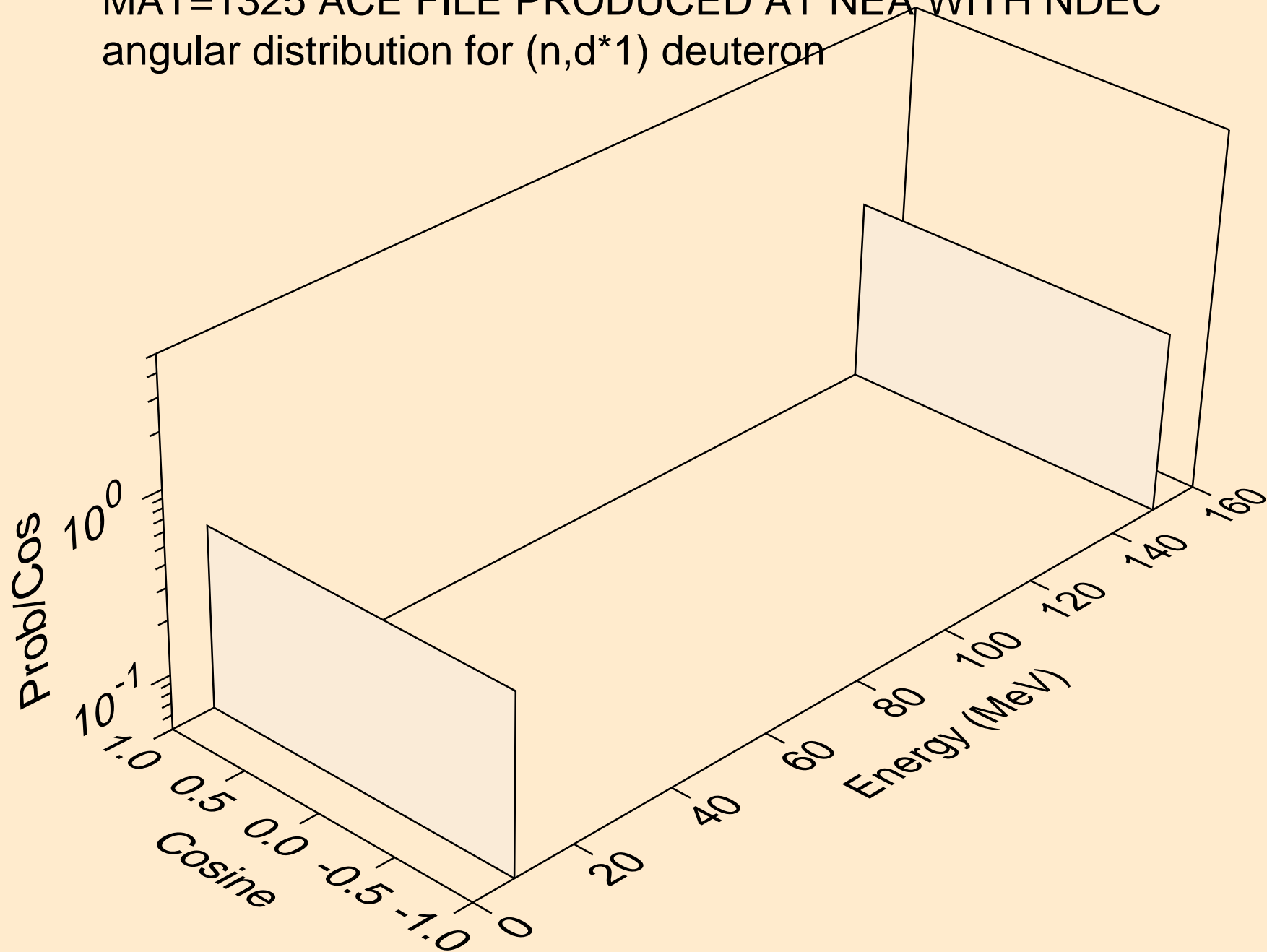

MAT=1325 ACE FILE PRODUCED AT NEA WITH NDEC  
angular distribution for (n,d\*2) deuteron

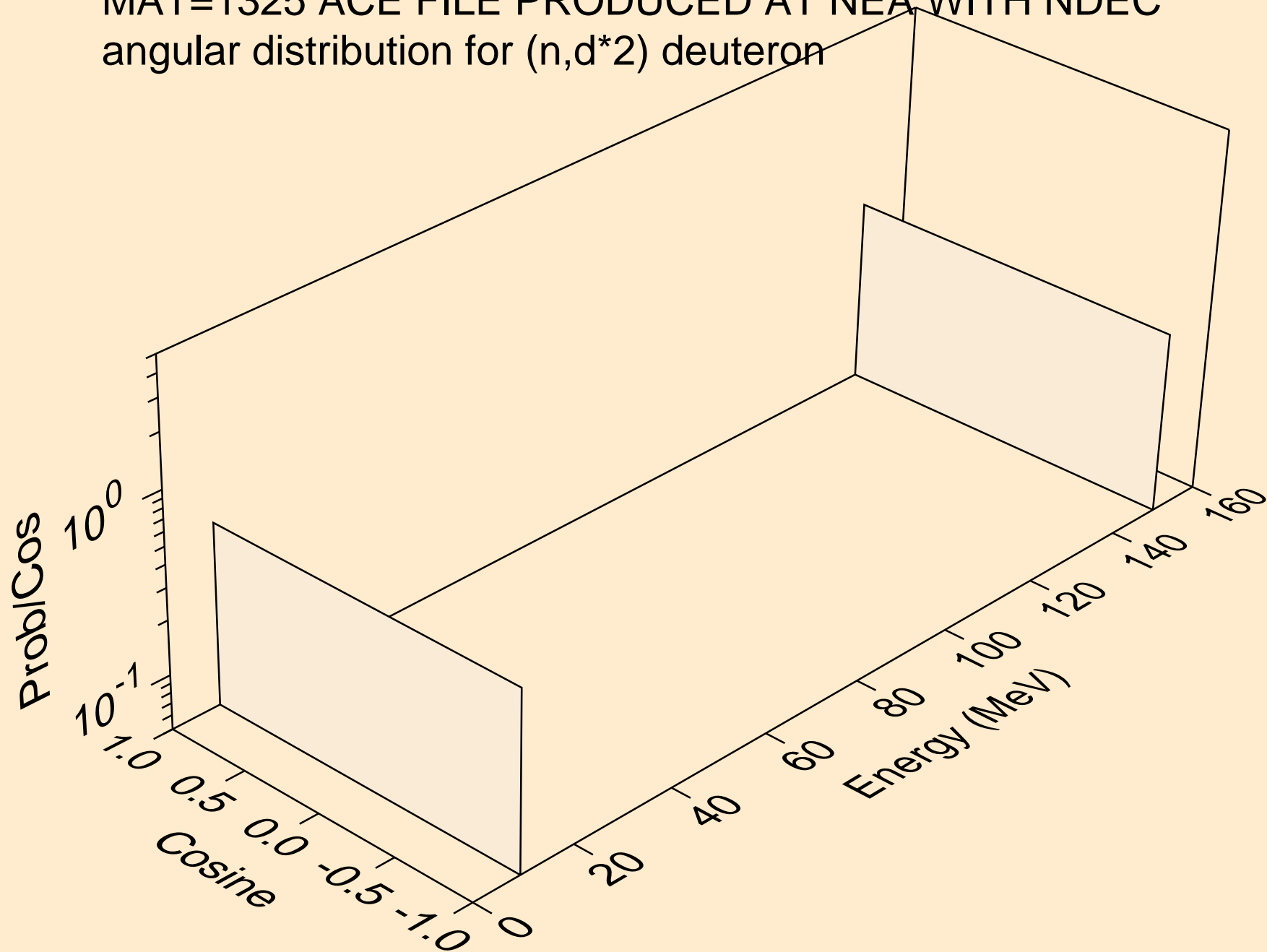

MAT=1325 ACE FILE PRODUCED AT NEA WITH NDEC  
angular distribution for (n,d\*3) deuteron

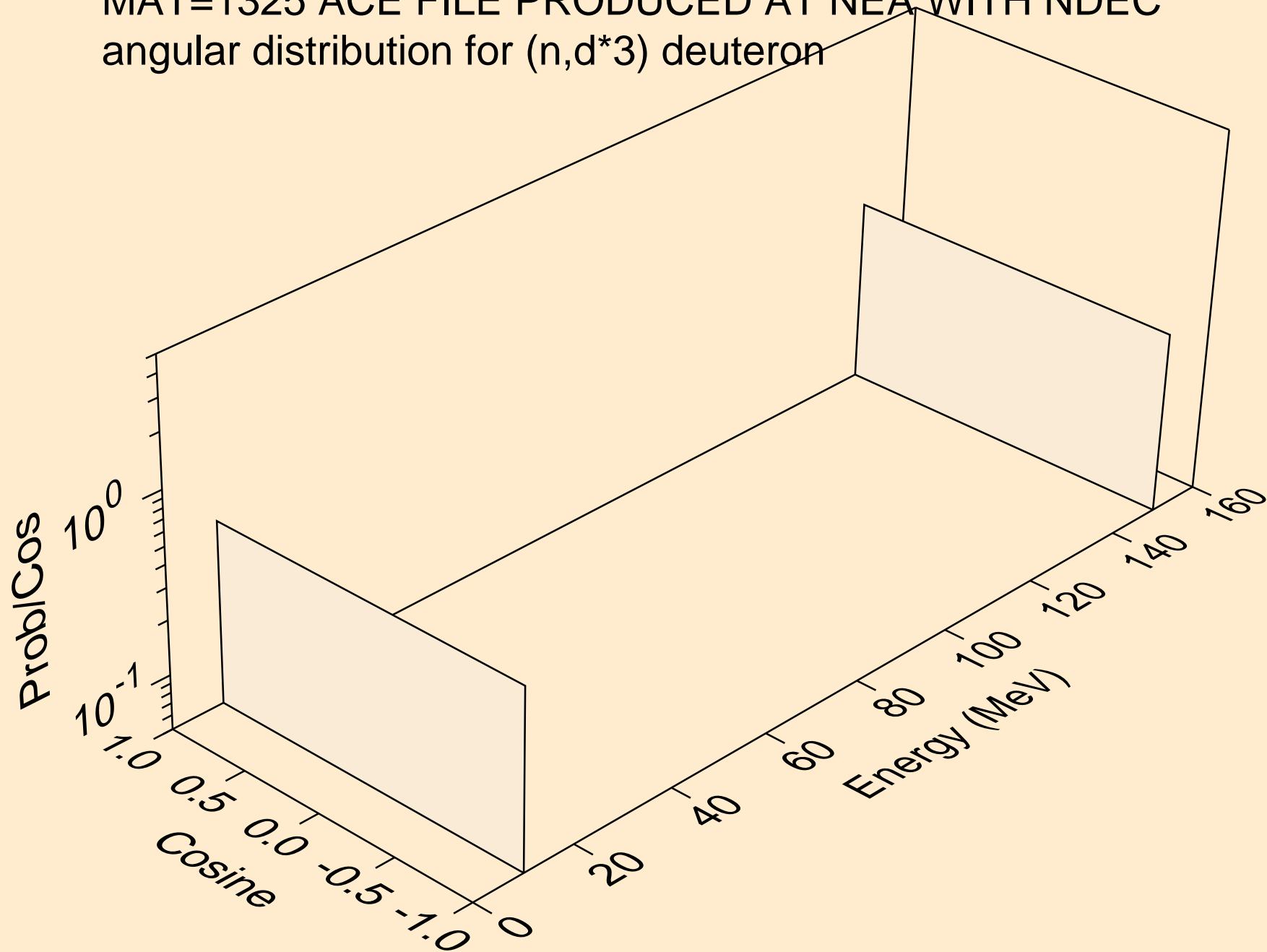

MAT=1325 ACE FILE PRODUCED AT NEA WITH NDEC  
angular distribution for (n,d\*4) deuteron

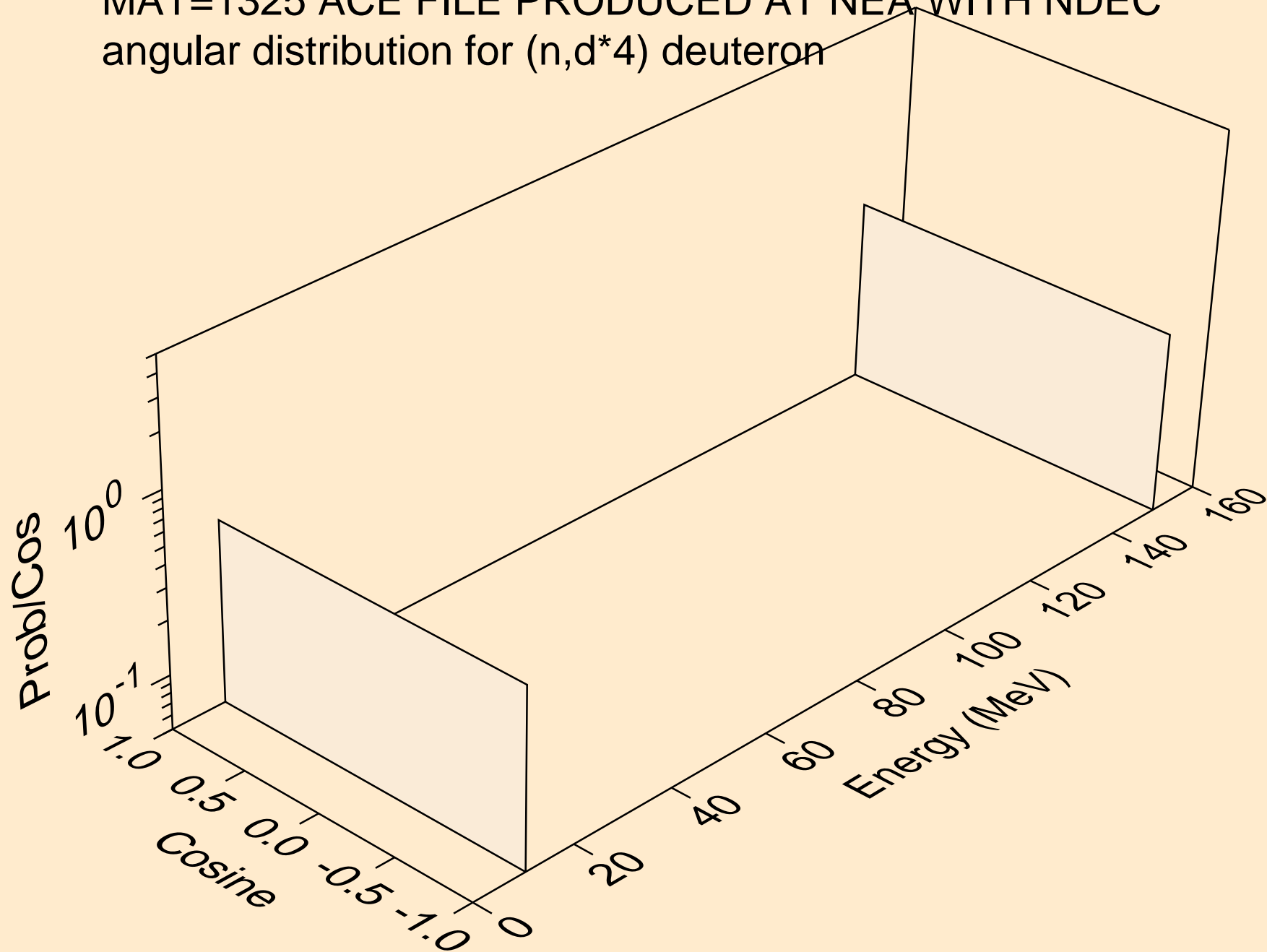

MAT=1325 ACE FILE PRODUCED AT NEA WITH NDEC  
angular distribution for (n,d\*5) deuteron

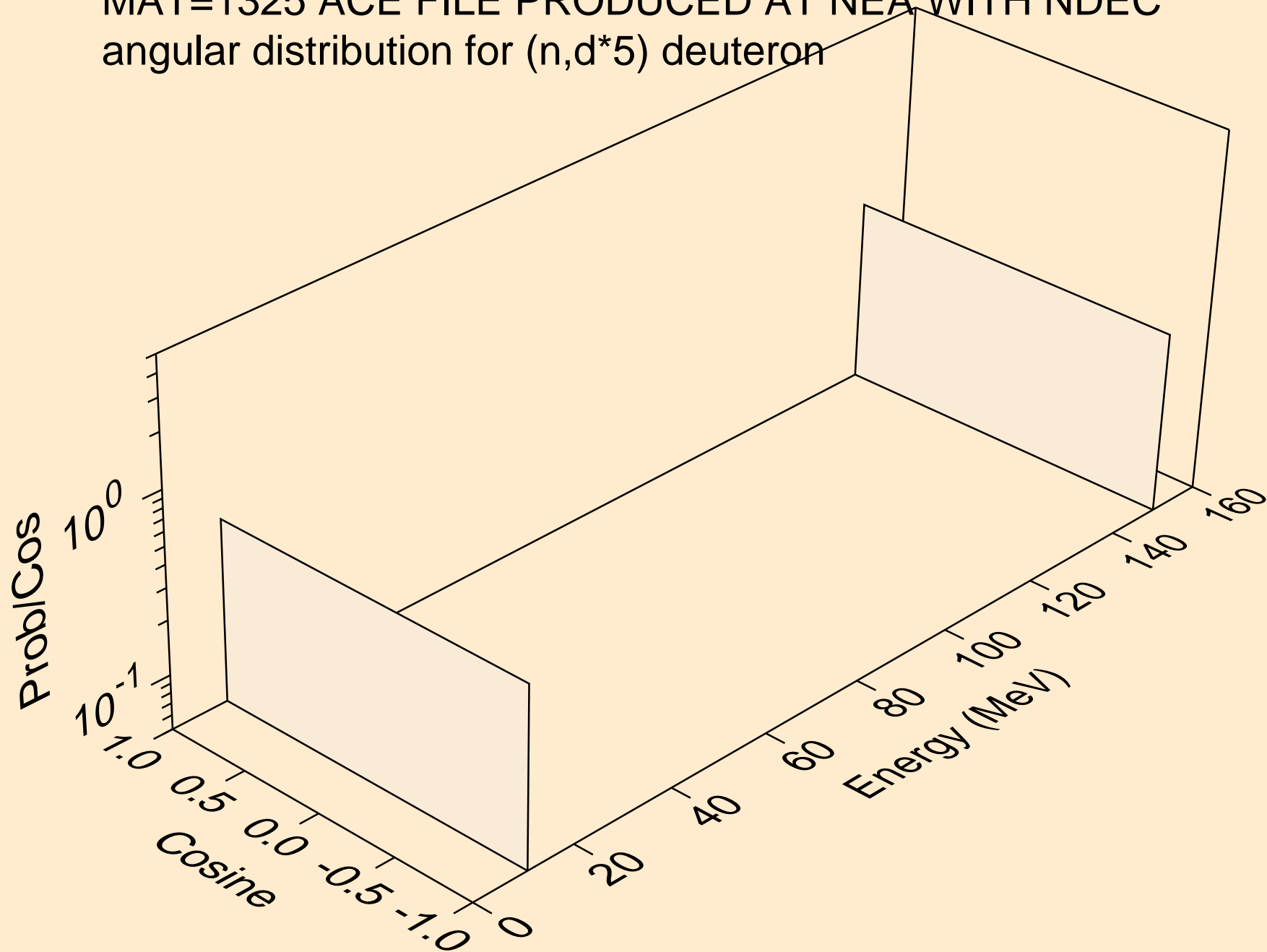

MAT=1325 ACE FILE PRODUCED AT NEA WITH NDEC  
angular distribution for (n,d\*6) deuteron

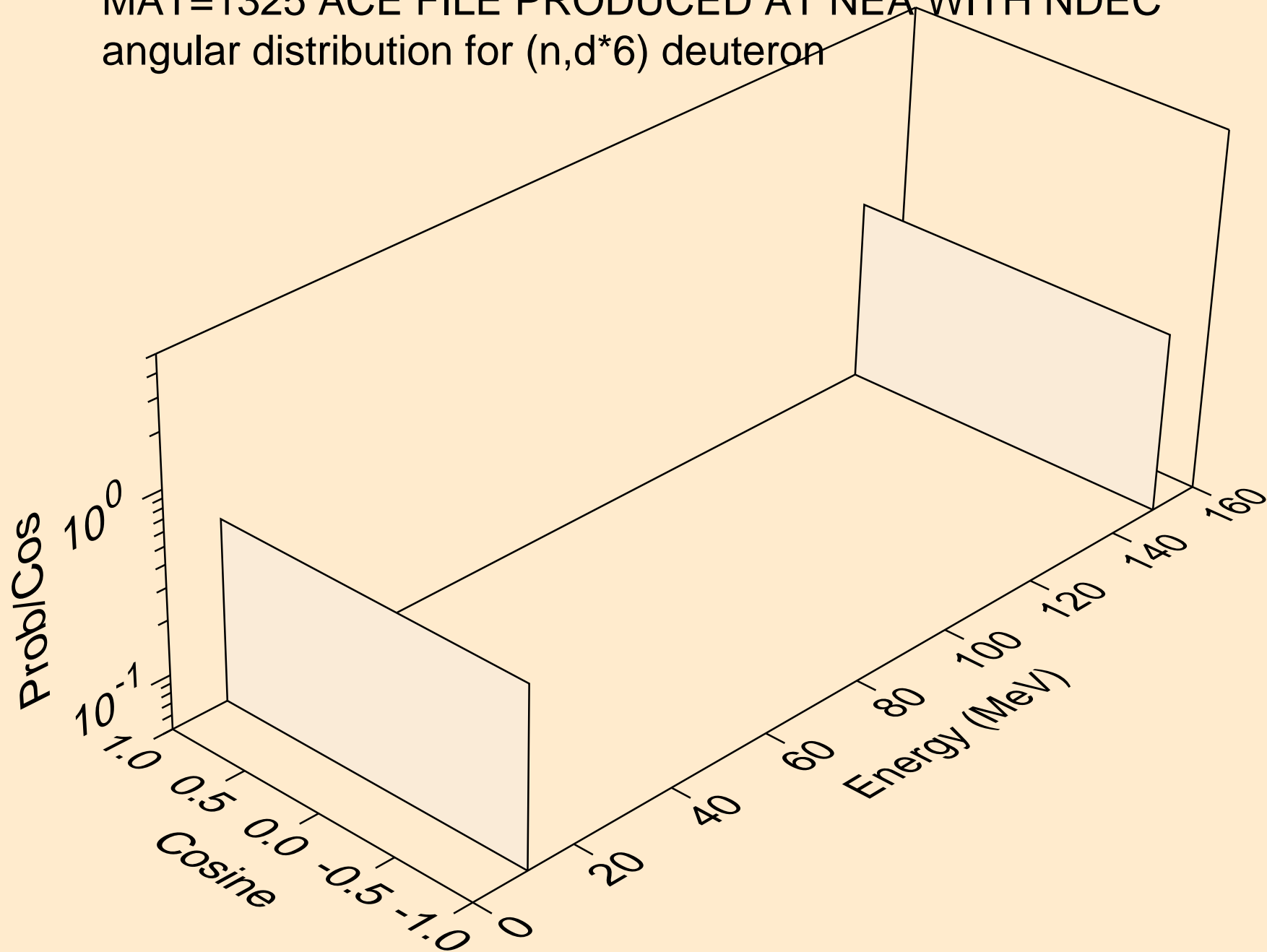



MAT=1325 ACE FILE PRODUCED AT NEA WITH NDEC  
angular distribution for (n,d\*7) deuteron

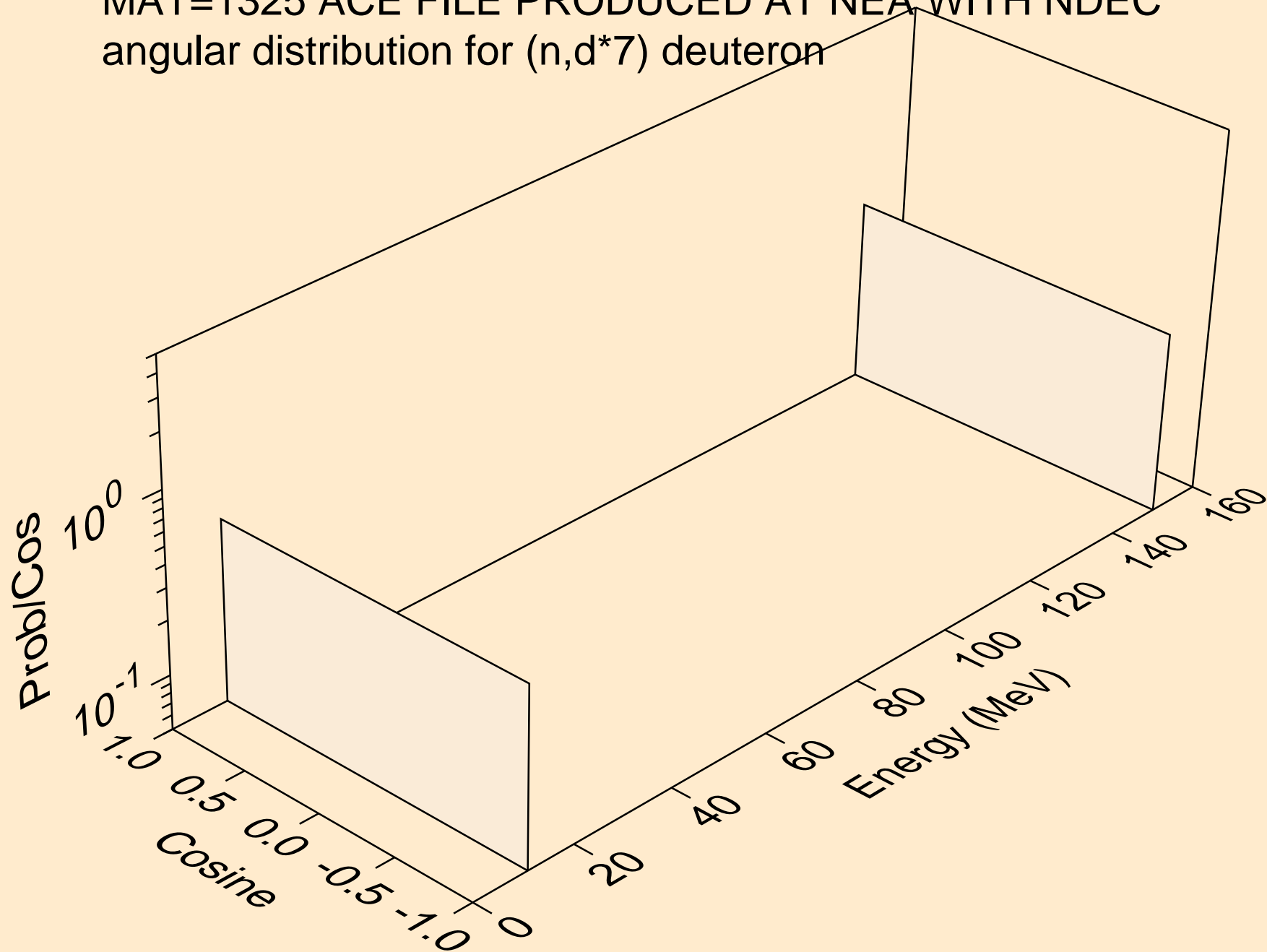

MAT=1325 ACE FILE PRODUCED AT NEA WITH NDEC  
angular distribution for (n,d\*8) deuteron

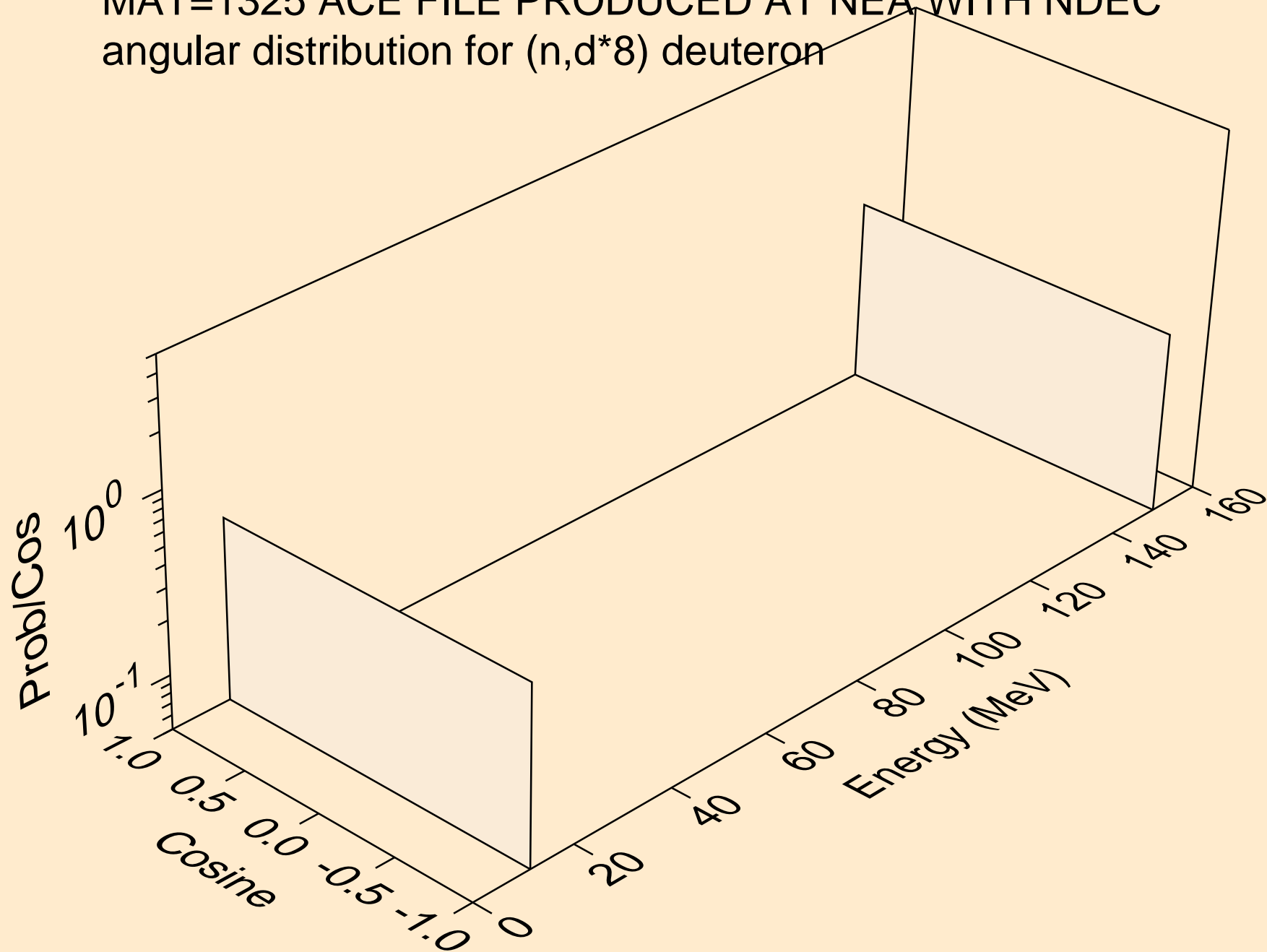

MAT=1325 ACE FILE PRODUCED AT NEA WITH NDEC  
angular distribution for (n,d\*9) deuteron

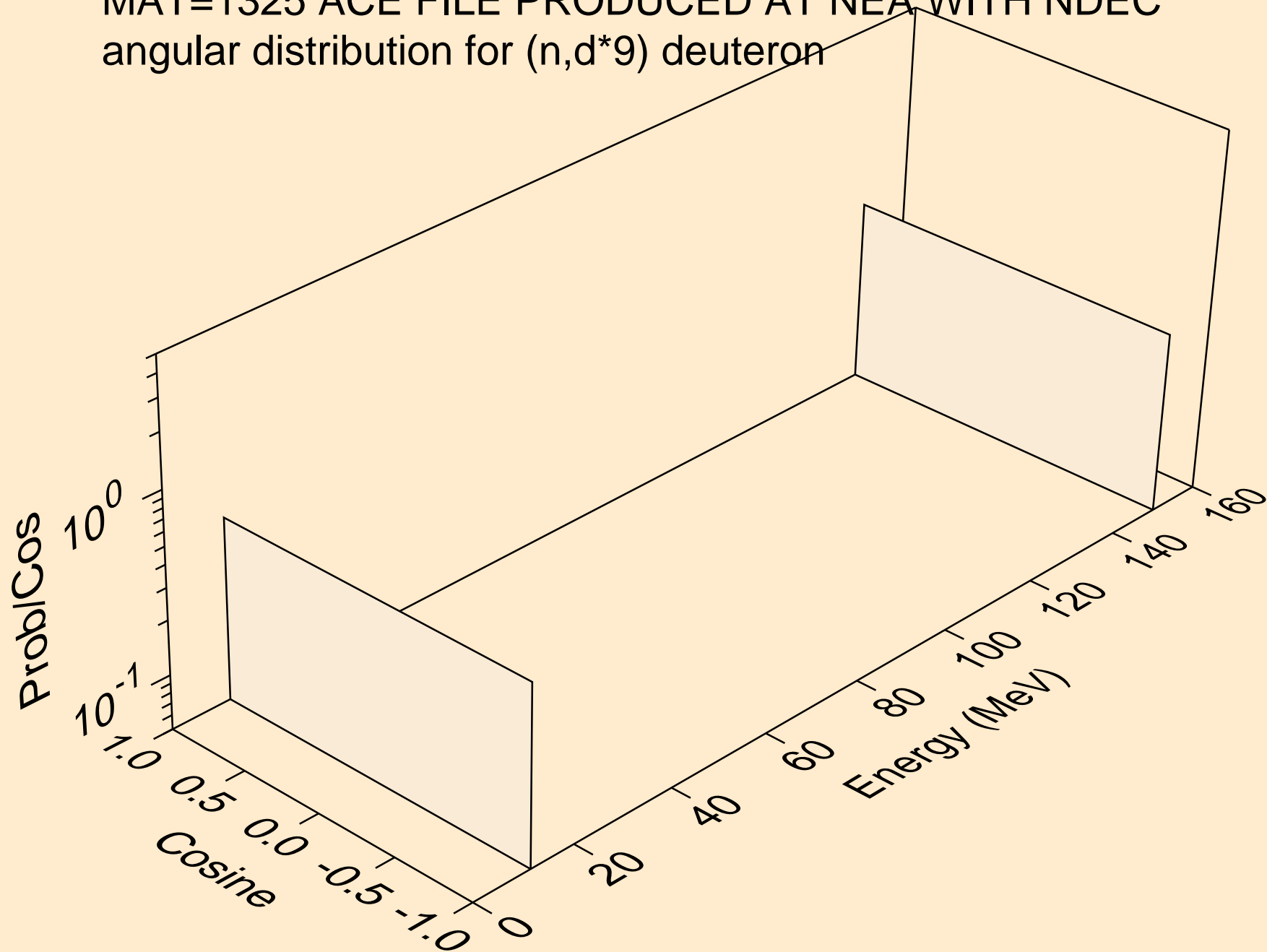

MAT=1325 ACE FILE PRODUCED AT NEA WITH NDEC  
angular distribution for (n,d\*10) deuteron

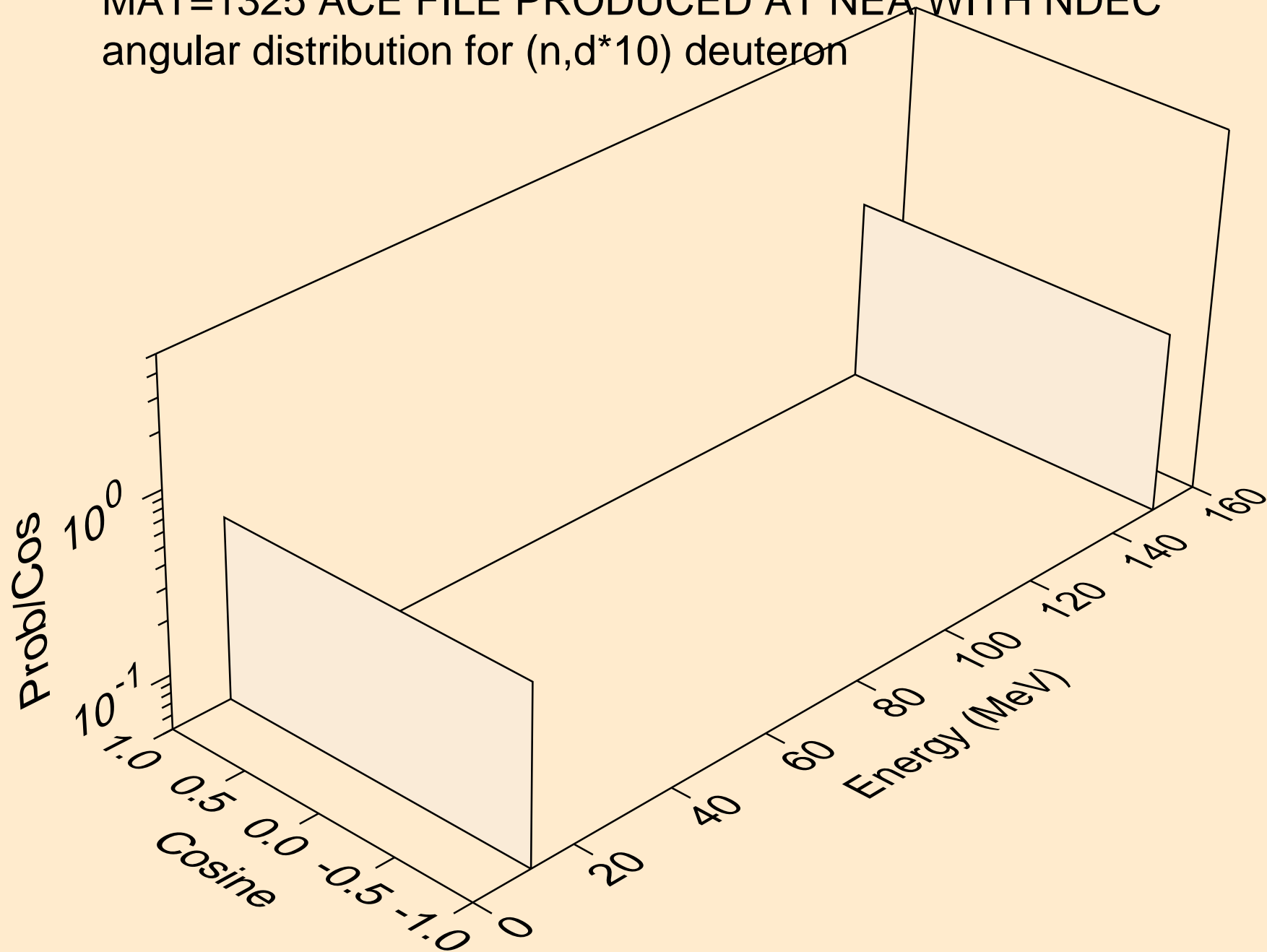

MAT=1325 ACE FILE PRODUCED AT NEA WITH NDEC  
angular distribution for (n,d\*11) deuteron

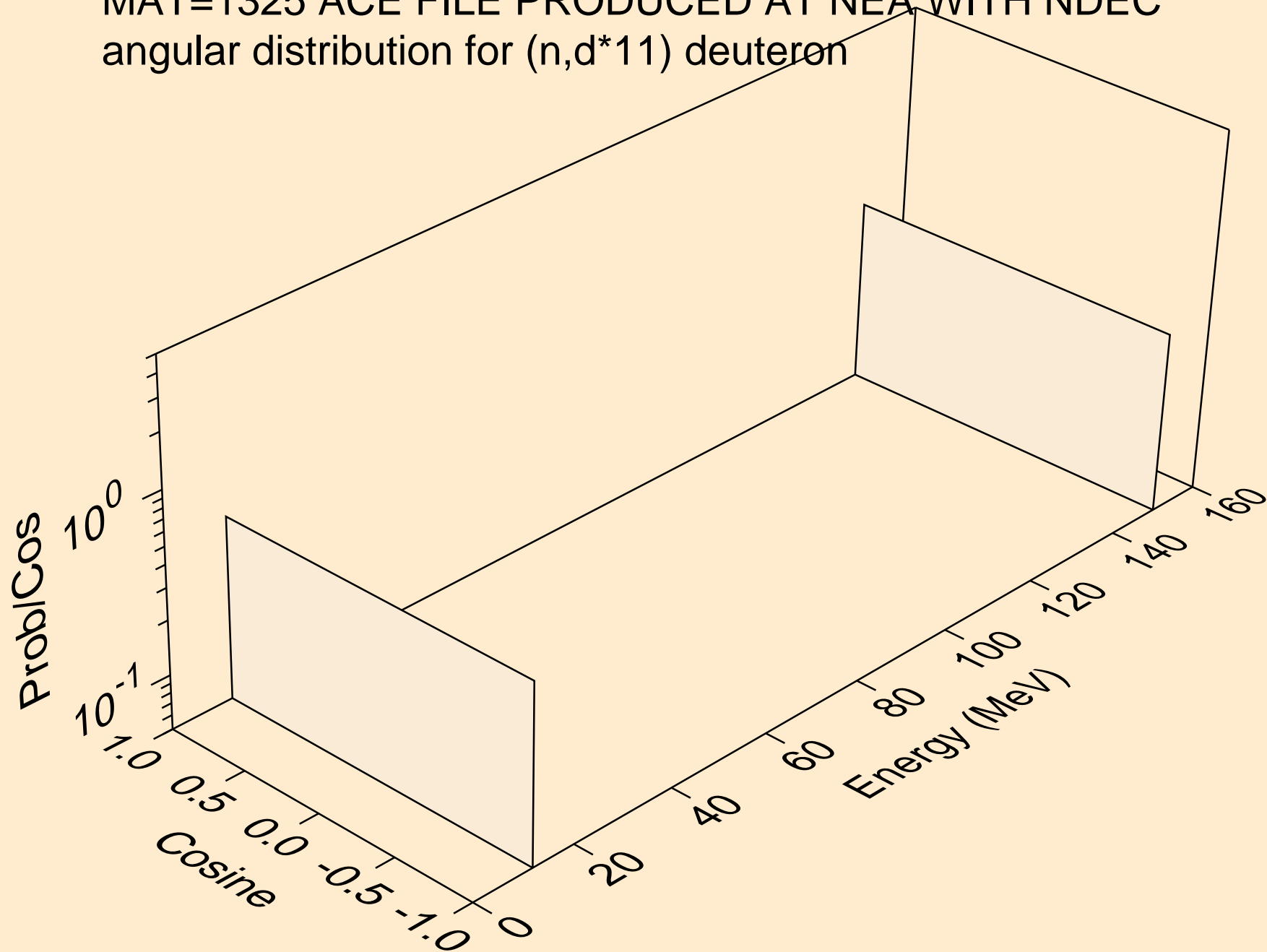

MAT=1325 ACE FILE PRODUCED AT NEA WITH NDEC  
angular distribution for (n,d\*12) deuteron

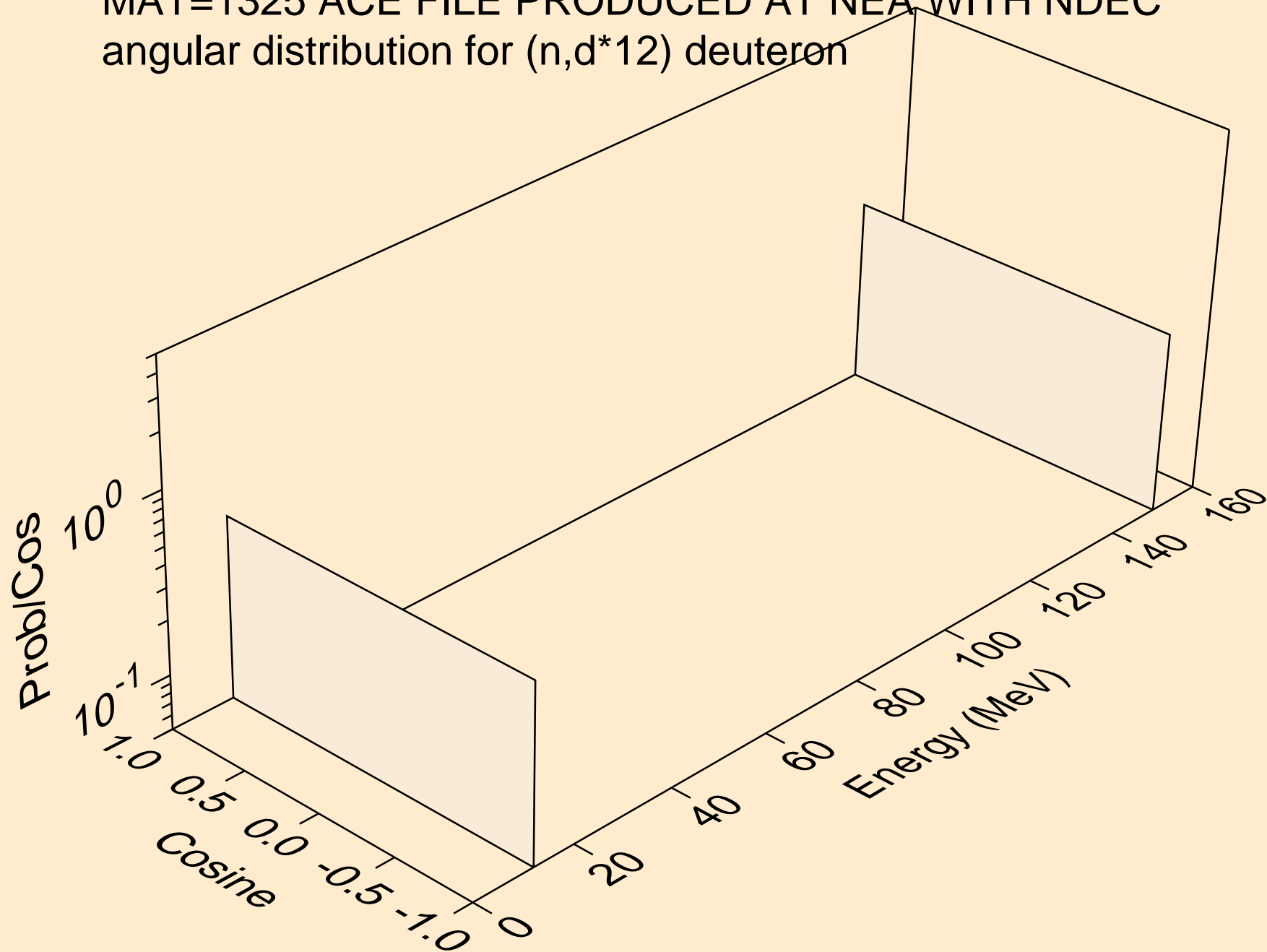

MAT=1325 ACE FILE PRODUCED AT NEA WITH NDEC  
angular distribution for (n,d\*13) deuteron

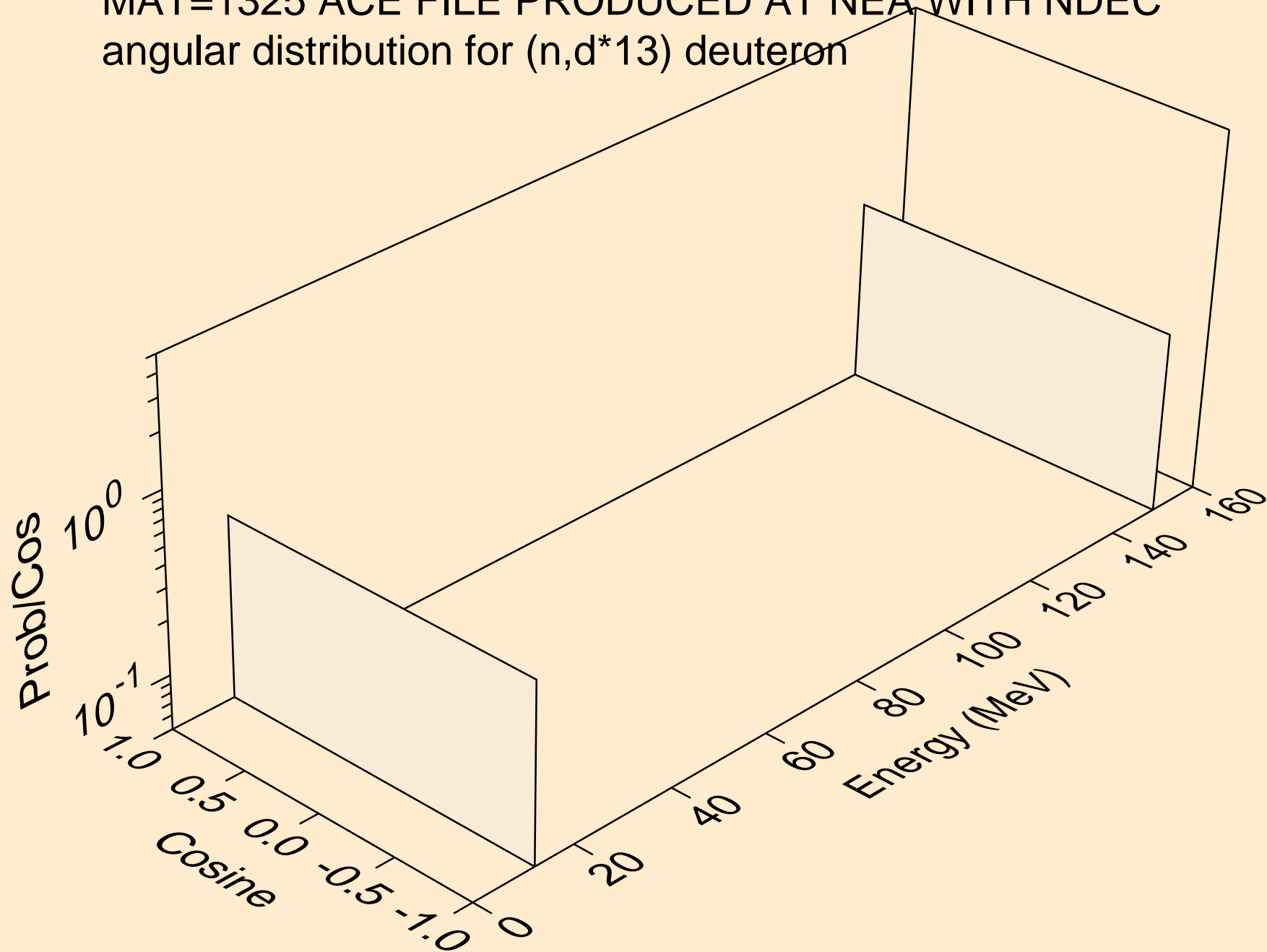

MAT=1325 ACE FILE PRODUCED AT NEA WITH NDEC  
angular distribution for (n,d\*14) deuteron

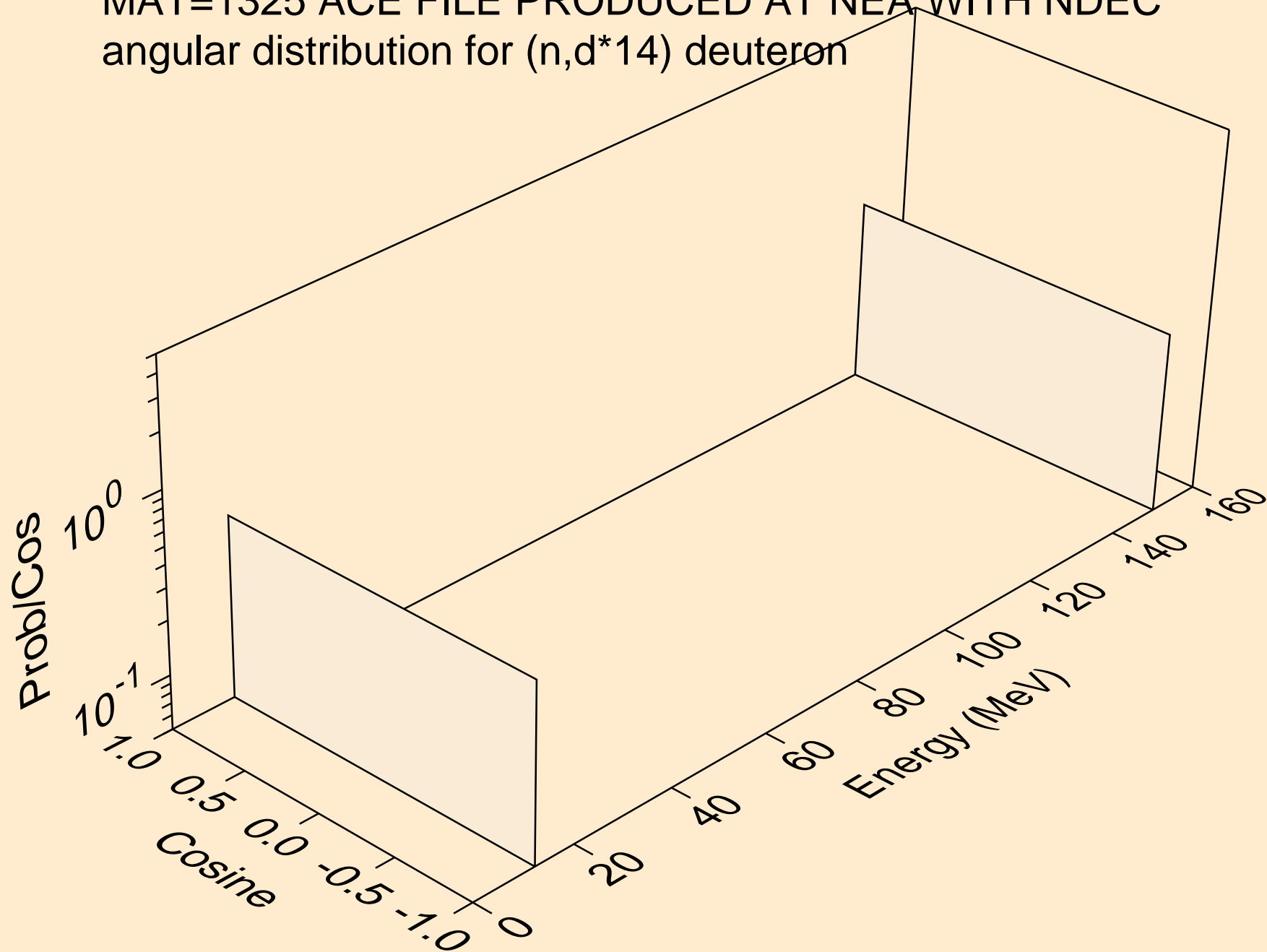



MAT=1325 ACE FILE PRODUCED AT NEA WITH NDEC  
angular distribution for (n,d\*15) deuteron

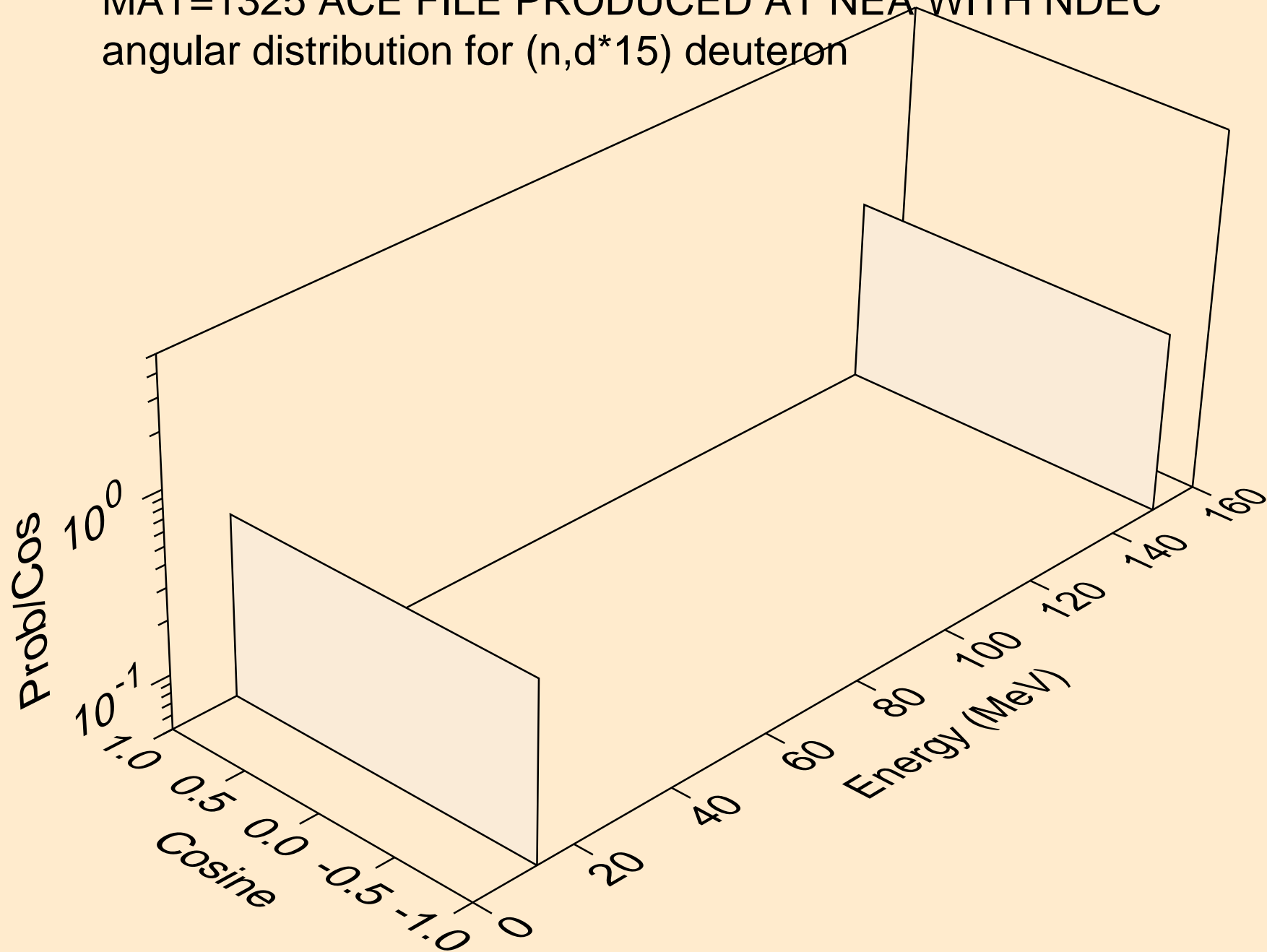

MAT=1325 ACE FILE PRODUCED AT NEA WITH NDEC  
angular distribution for (n,d\*16) deuteron

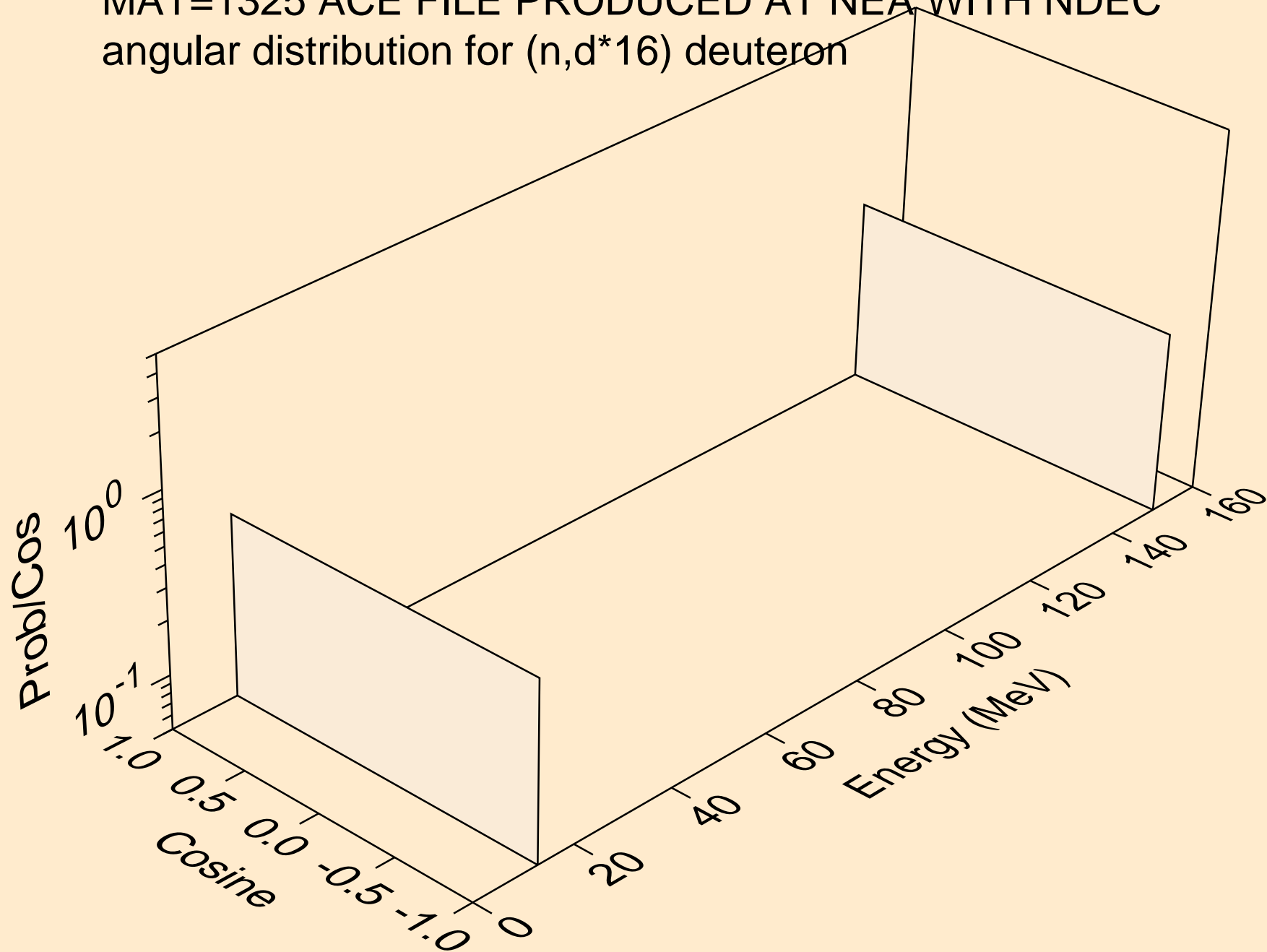

MAT=1325 ACE FILE PRODUCED AT NEA WITH NDEC  
angular distribution for (n,d\*17) deuteron

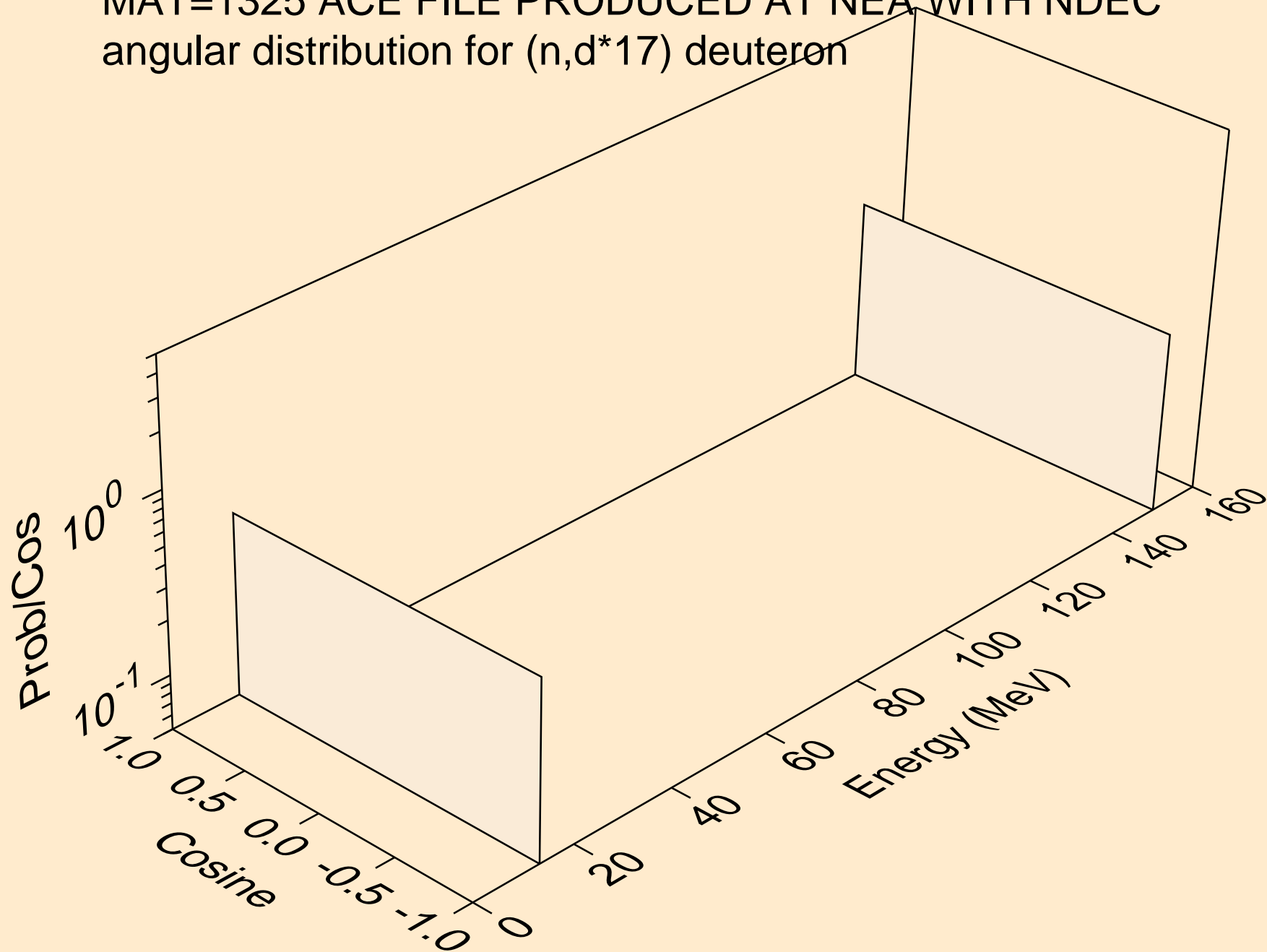

MAT=1325 ACE FILE PRODUCED AT NEA WITH NDEC  
angular distribution for (n,d\*18) deuteron

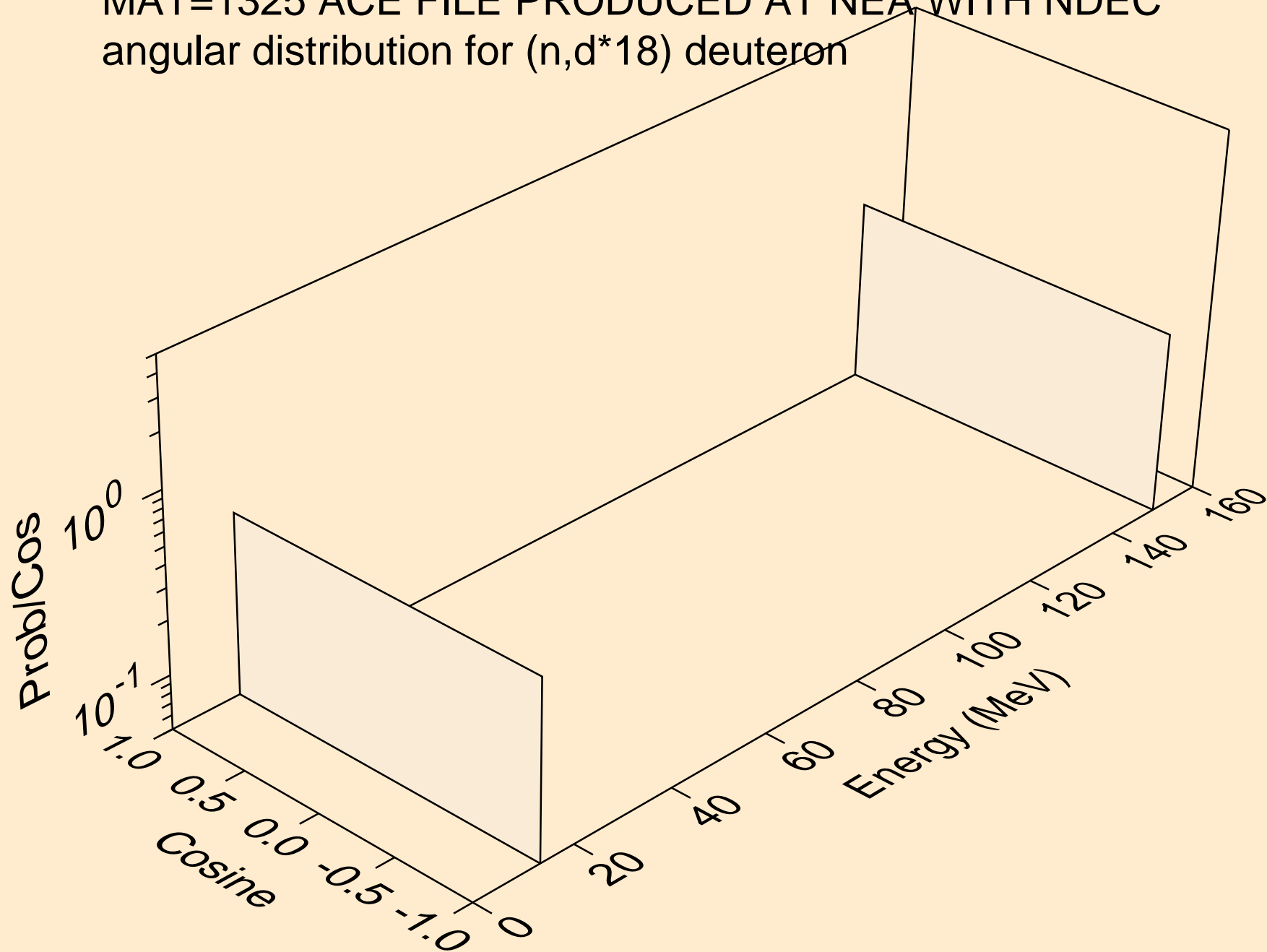

MAT=1325 ACE FILE PRODUCED AT NEA WITH NDEC  
angular distribution for (n,d\*19) deuteron

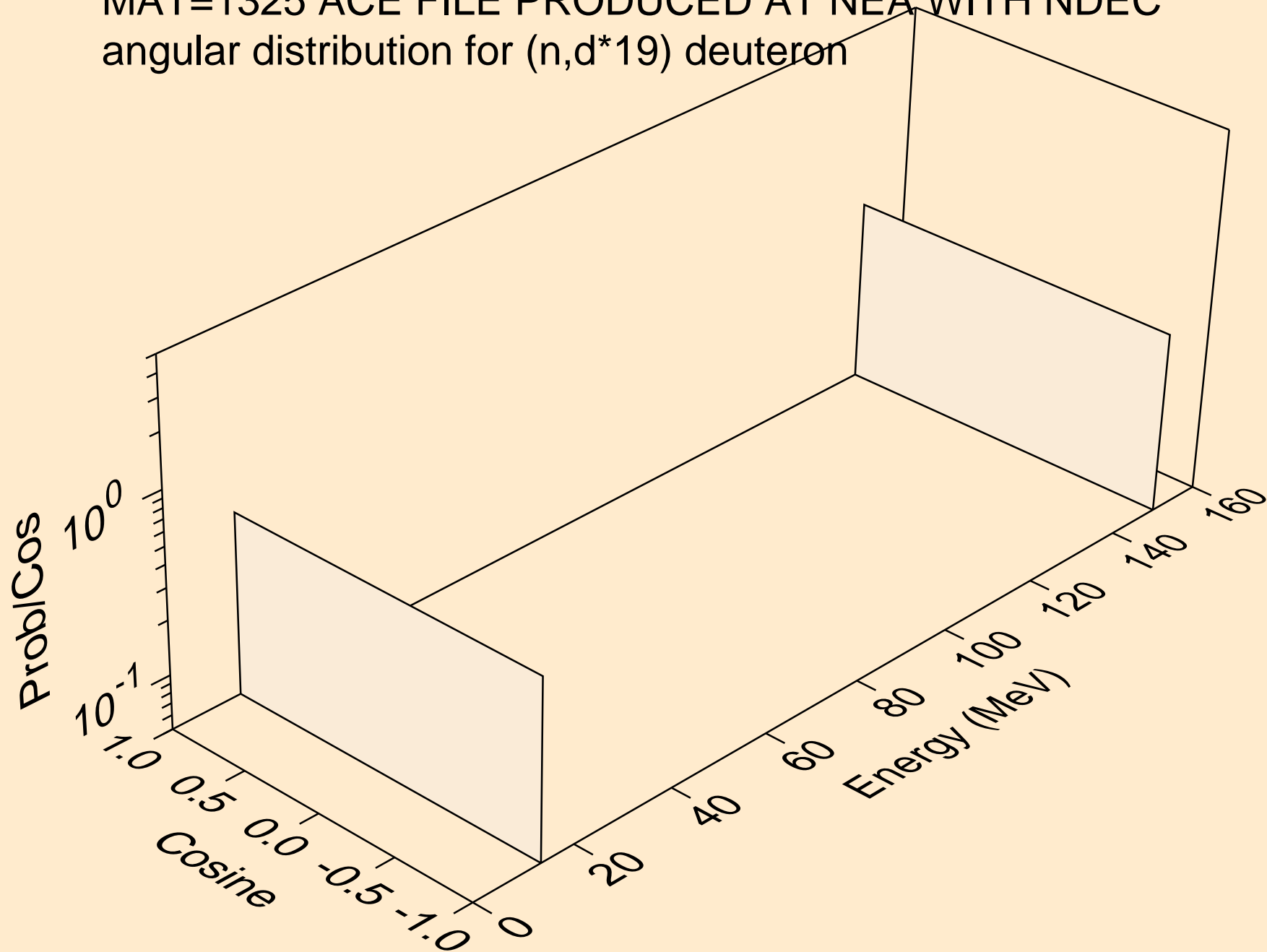

MAT=1325 ACE FILE PRODUCED AT NEA WITH NDEC  
deuterons from (n,d\*c)

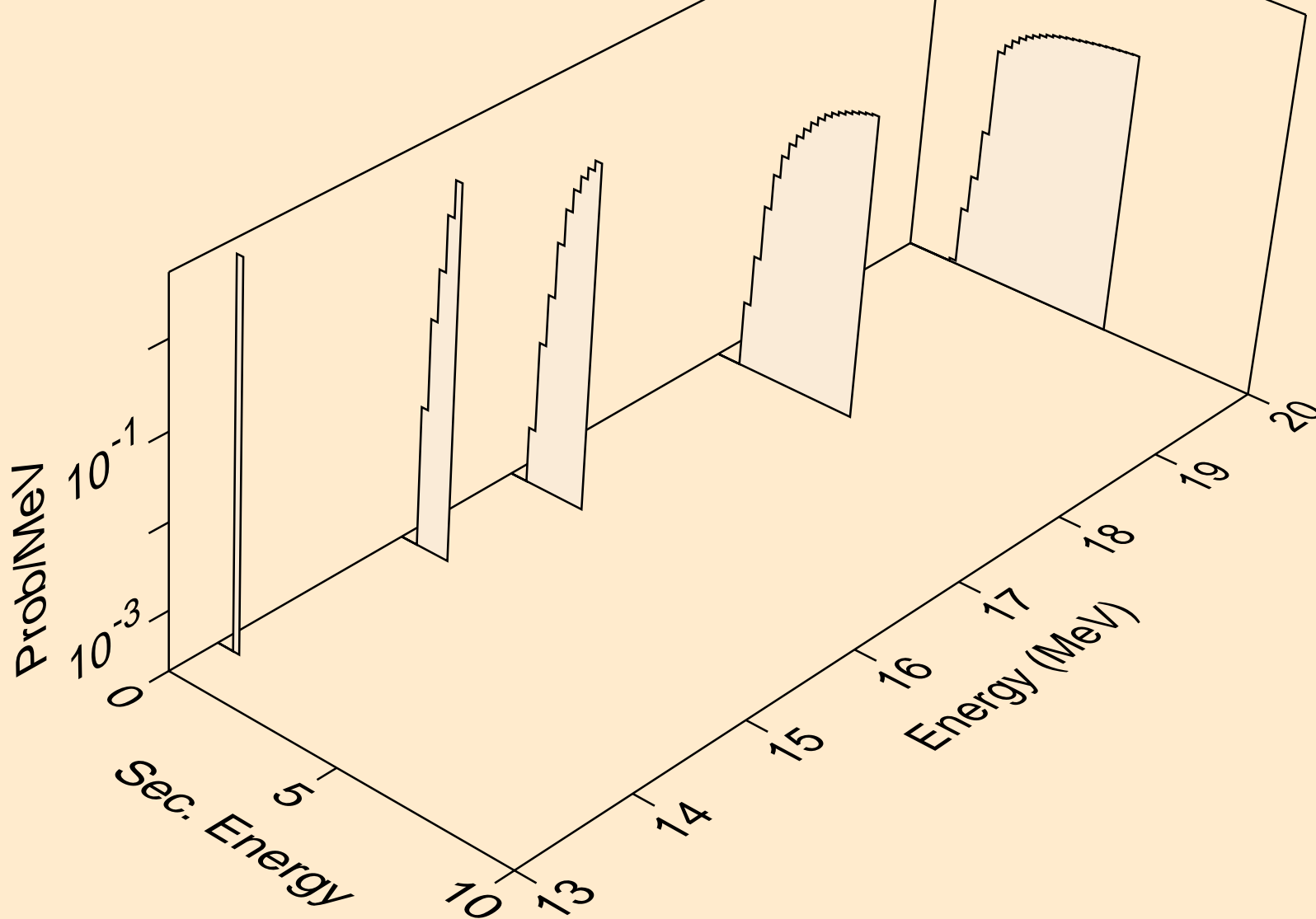

MAT=1325 ACE FILE PRODUCED AT NEA WITH NDEC  
tritons from (n,x)

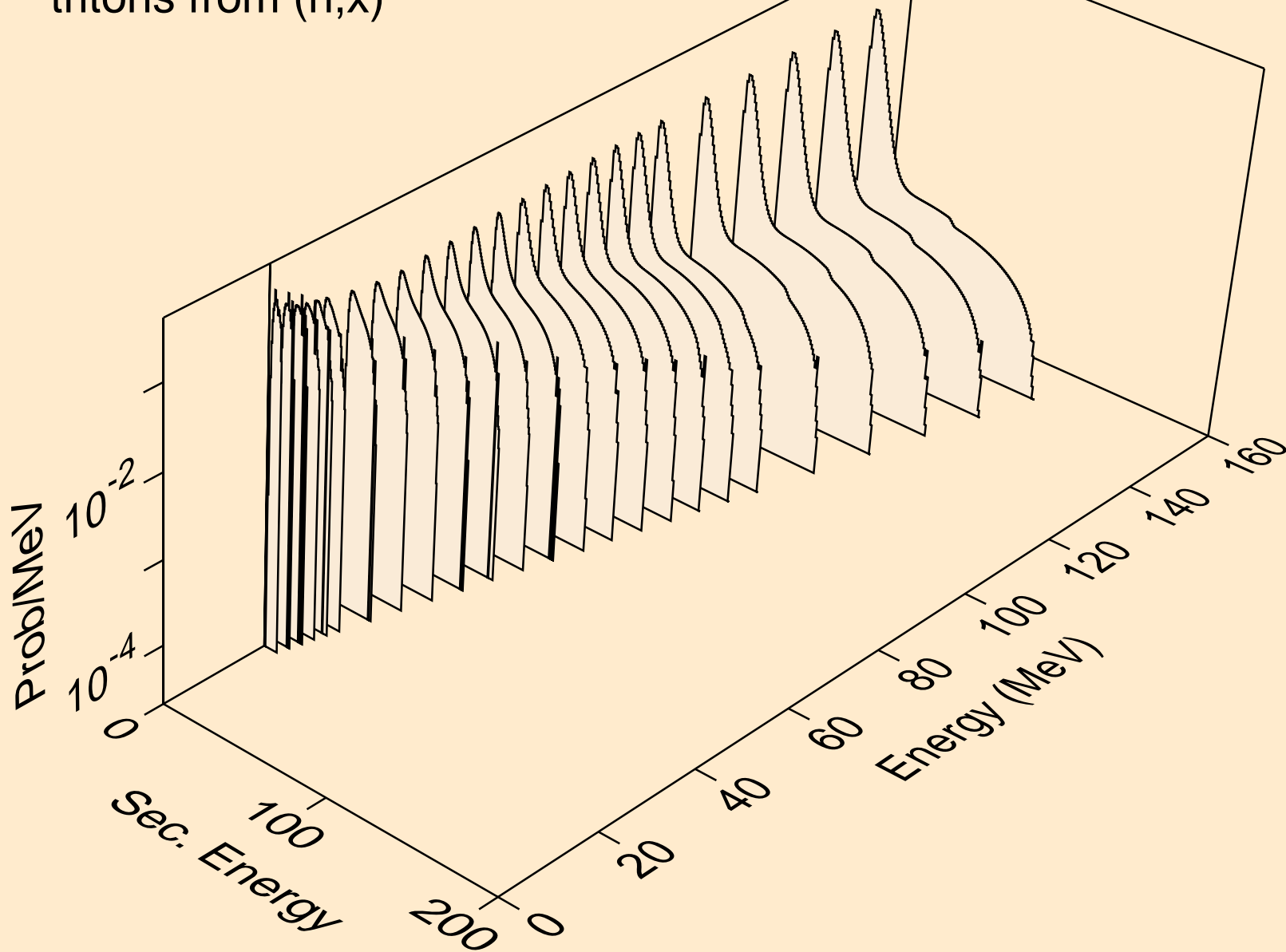

MAT=1325 ACE FILE PRODUCED AT NEA WITH NDEC  
tritons from (n,n\*)t

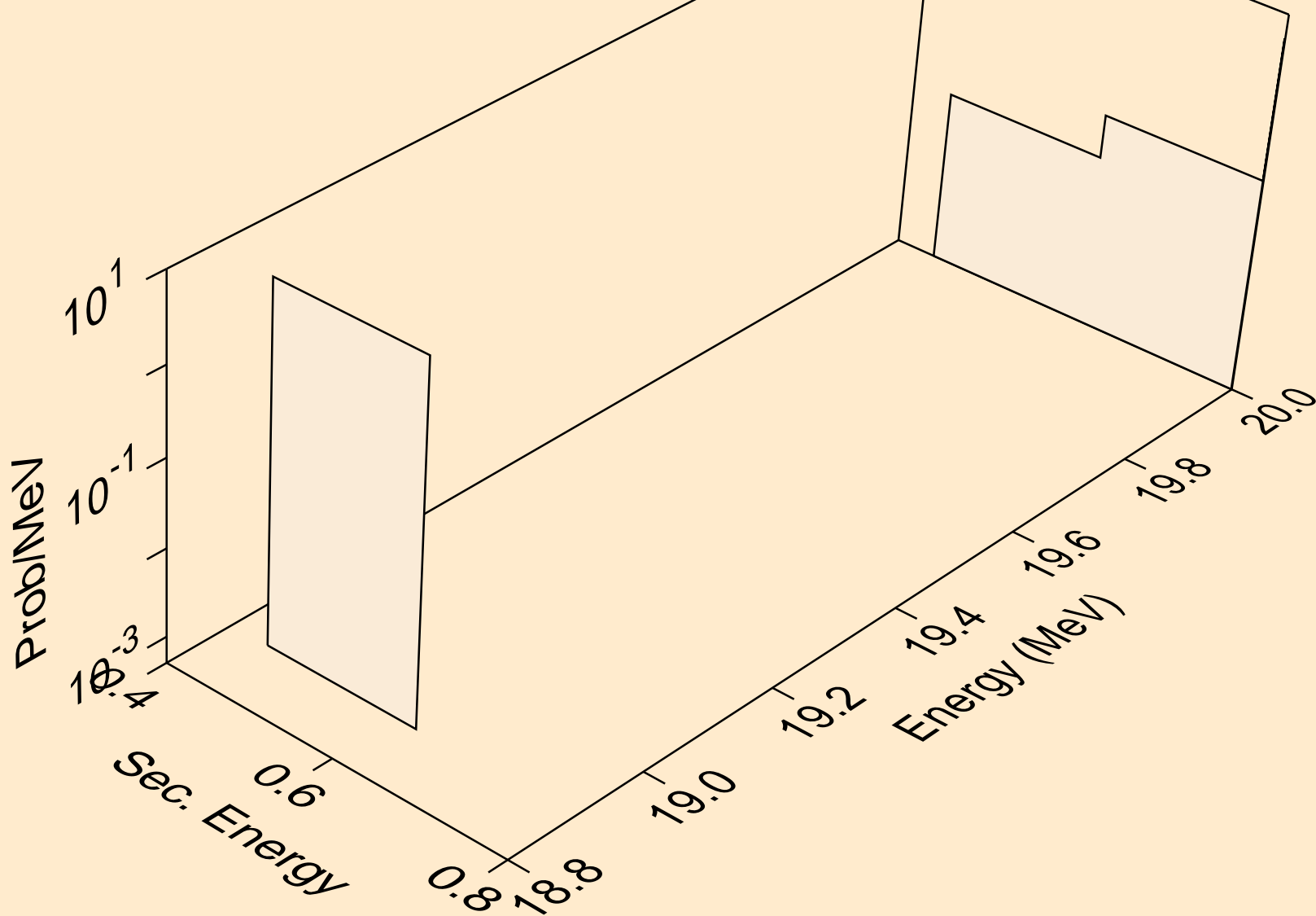



MAT=1325 ACE FILE PRODUCED AT NEA WITH NDEC  
angular distribution for (n,t\*0) triton

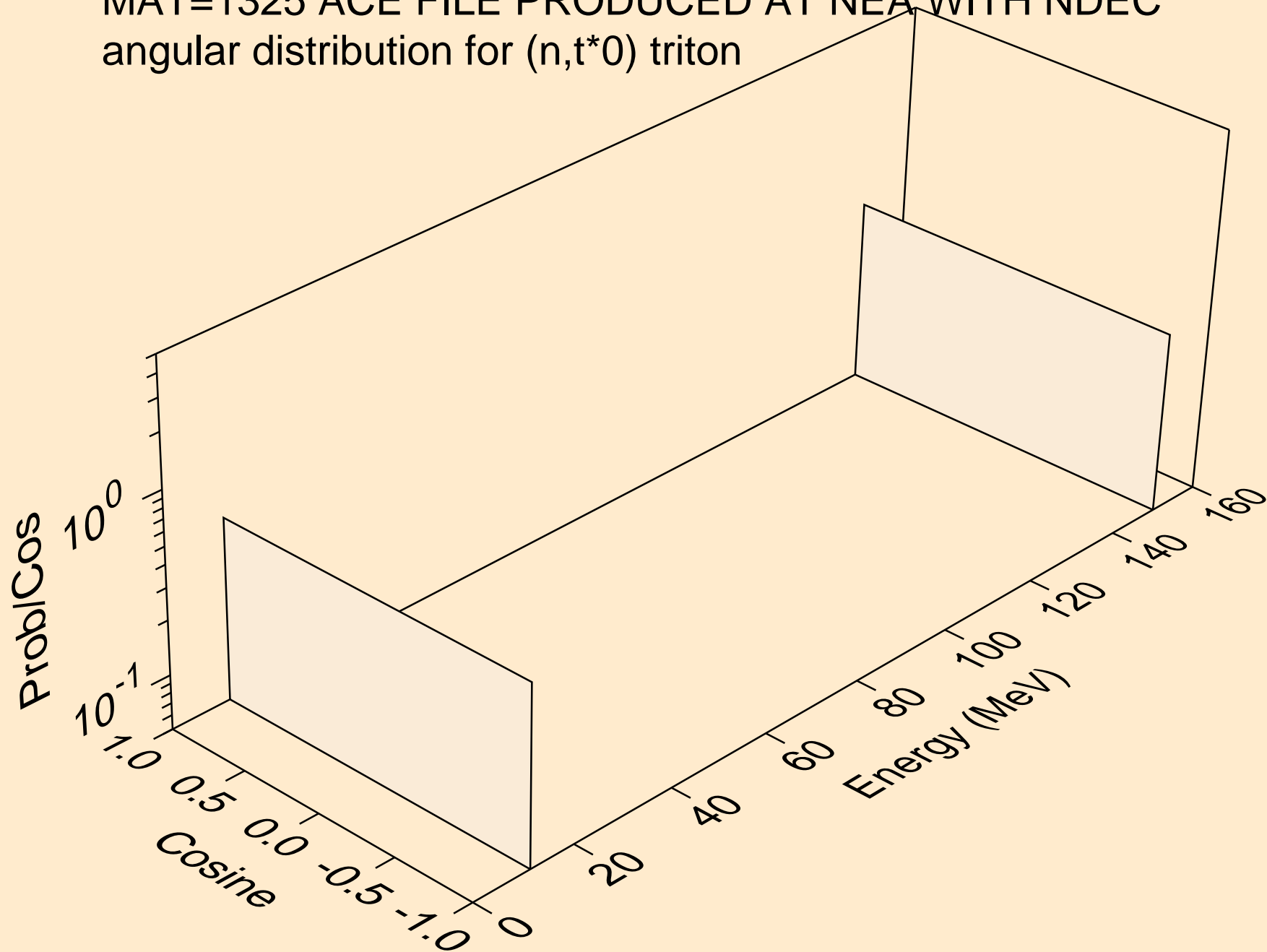

MAT=1325 ACE FILE PRODUCED AT NEA WITH NDEC  
angular distribution for (n,t\*1) triton

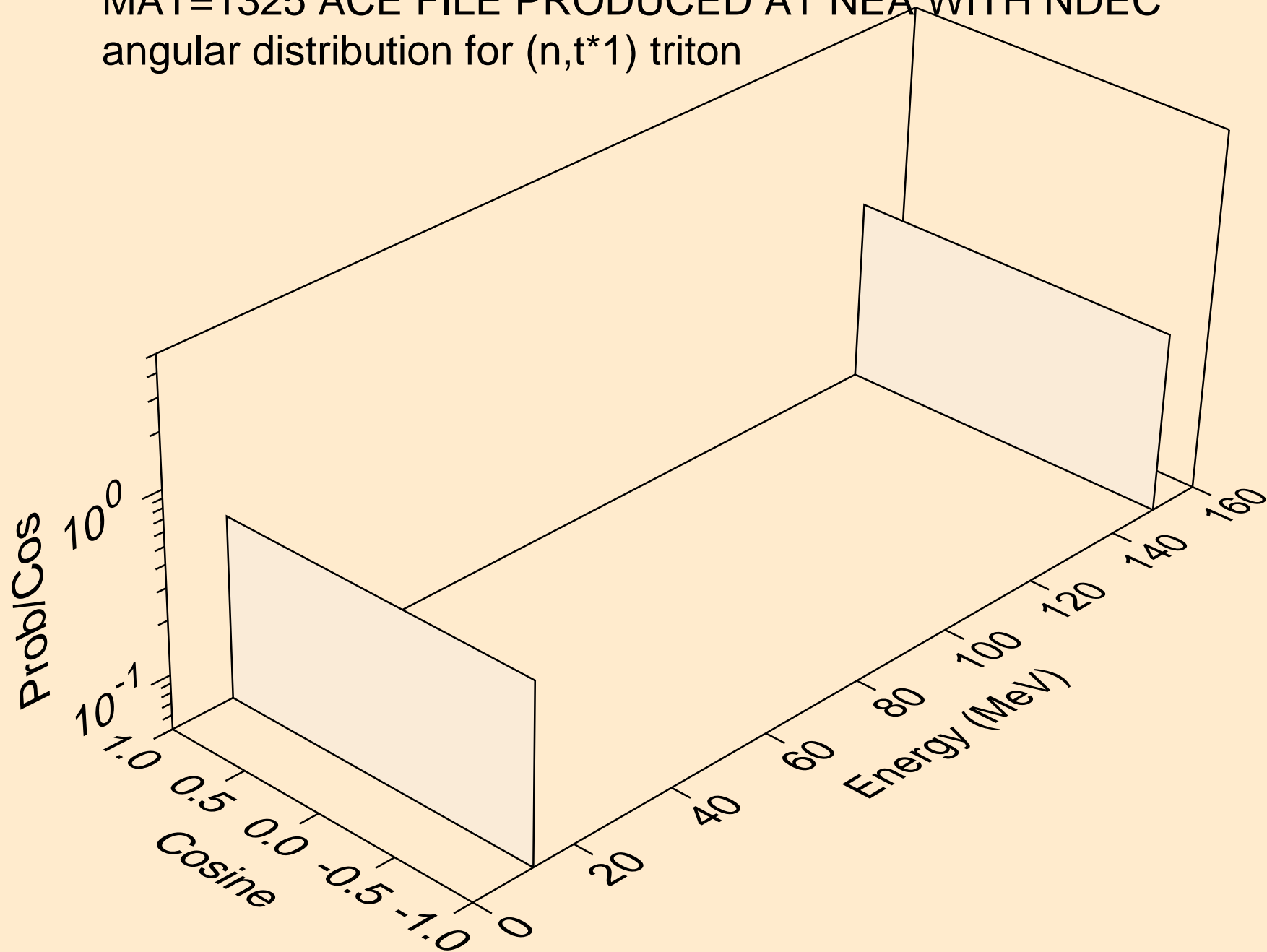

MAT=1325 ACE FILE PRODUCED AT NEA WITH NDEC  
angular distribution for (n,t\*2) triton

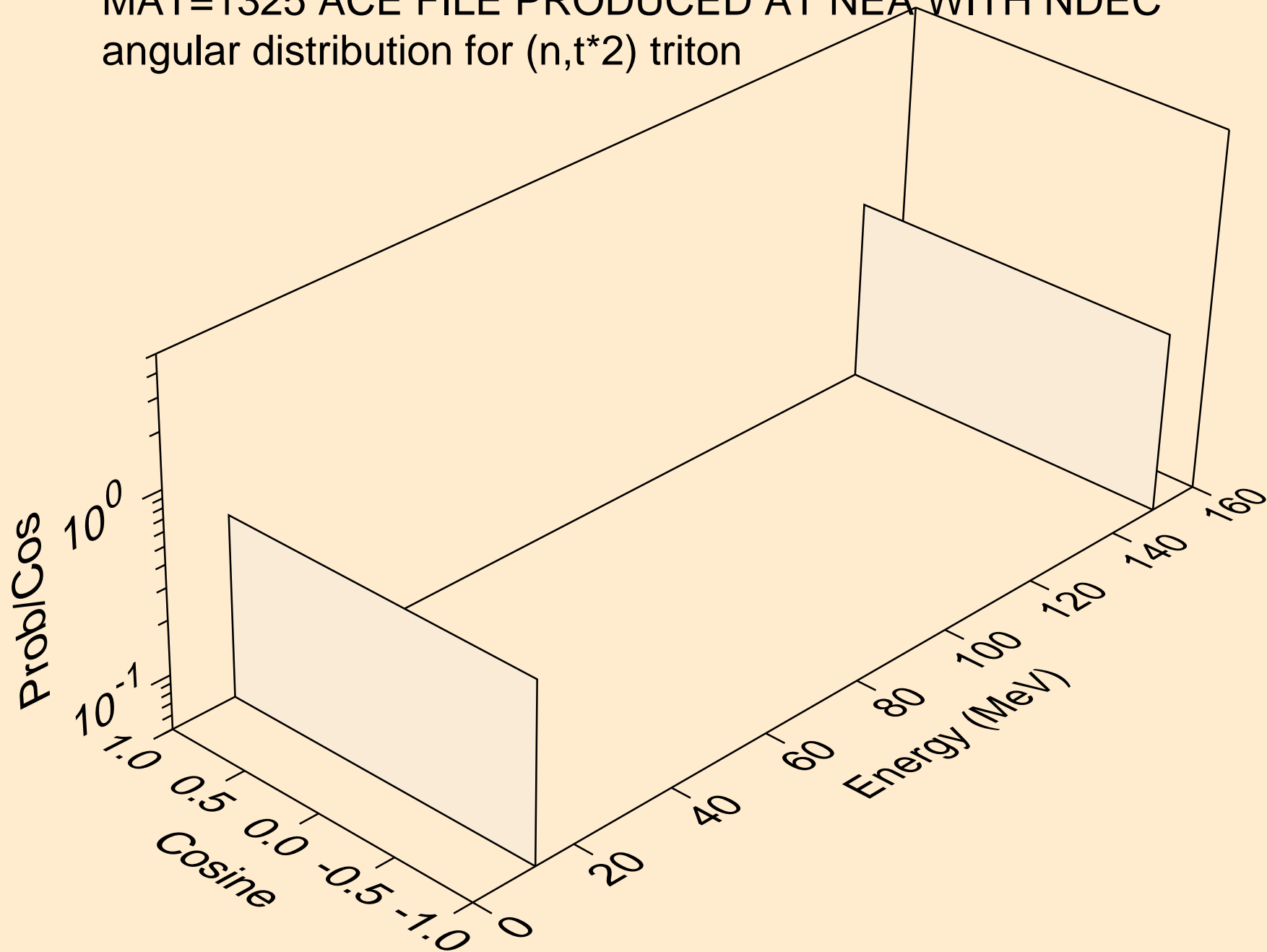

MAT=1325 ACE FILE PRODUCED AT NEA WITH NDEC  
angular distribution for (n,t\*3) triton

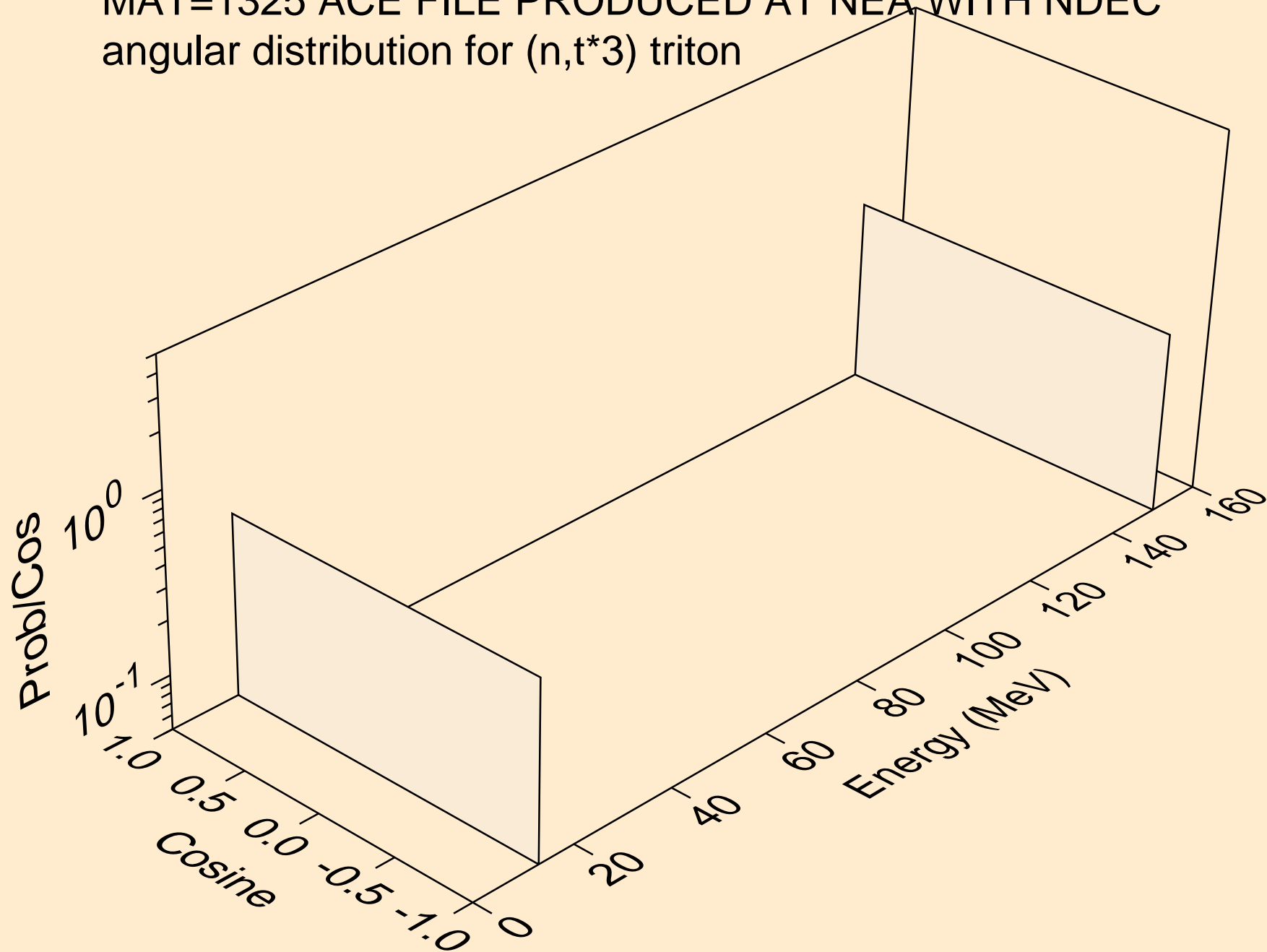

MAT=1325 ACE FILE PRODUCED AT NEA WITH NDEC  
angular distribution for (n,t\*4) triton

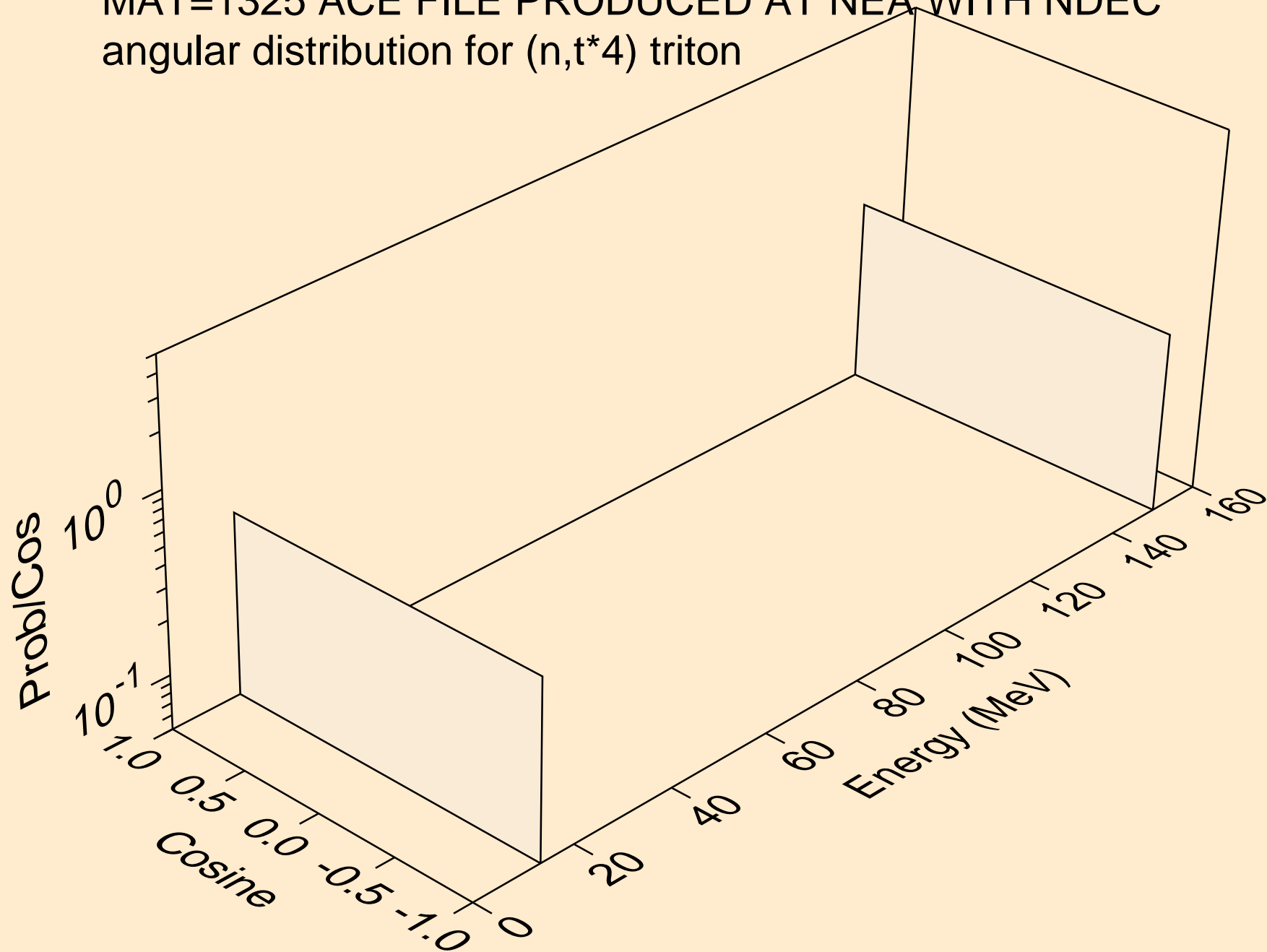

MAT=1325 ACE FILE PRODUCED AT NEA WITH NDEC  
angular distribution for (n,t\*5) triton

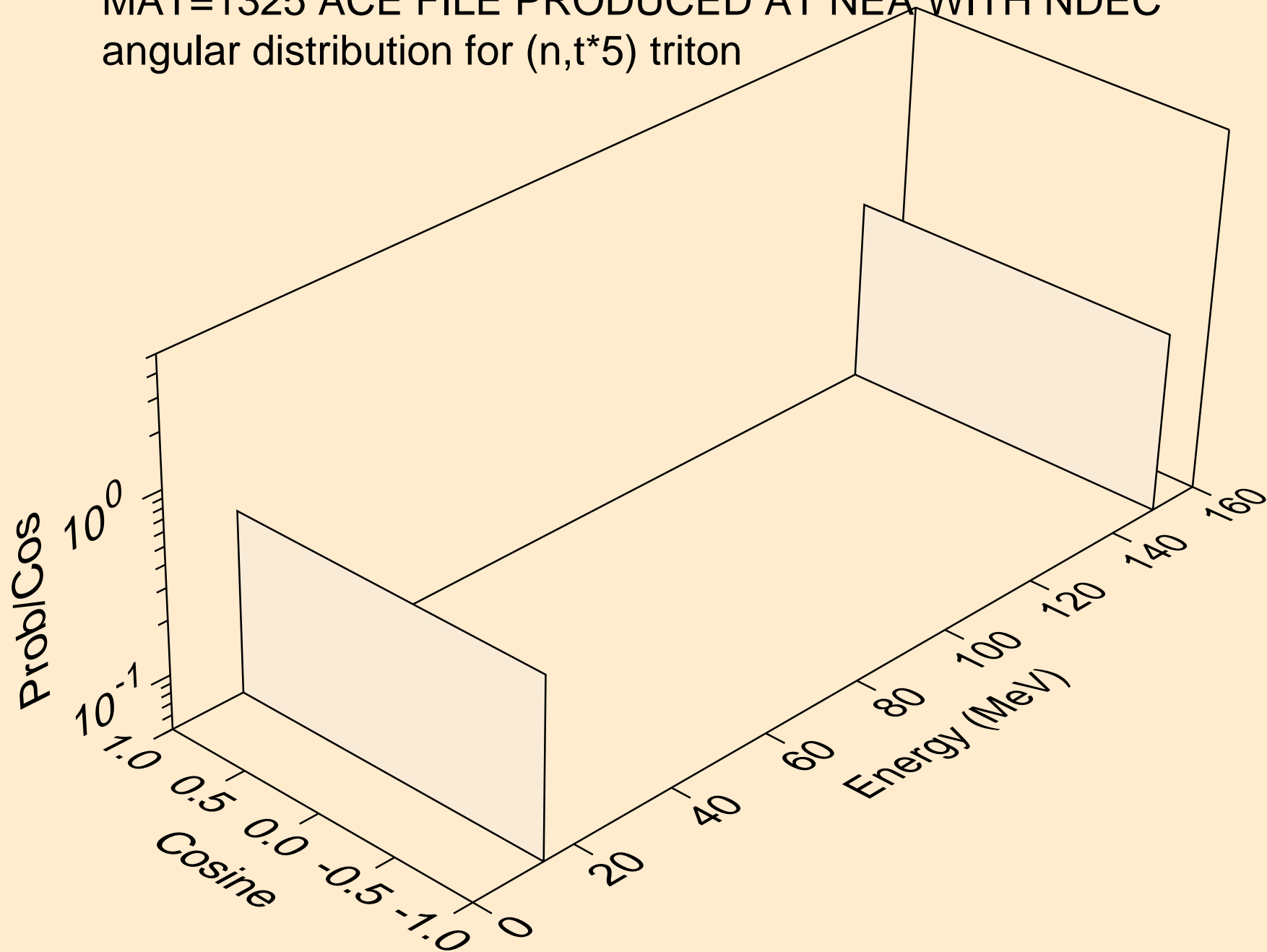

MAT=1325 ACE FILE PRODUCED AT NEA WITH NDEC  
angular distribution for (n,t\*6) triton

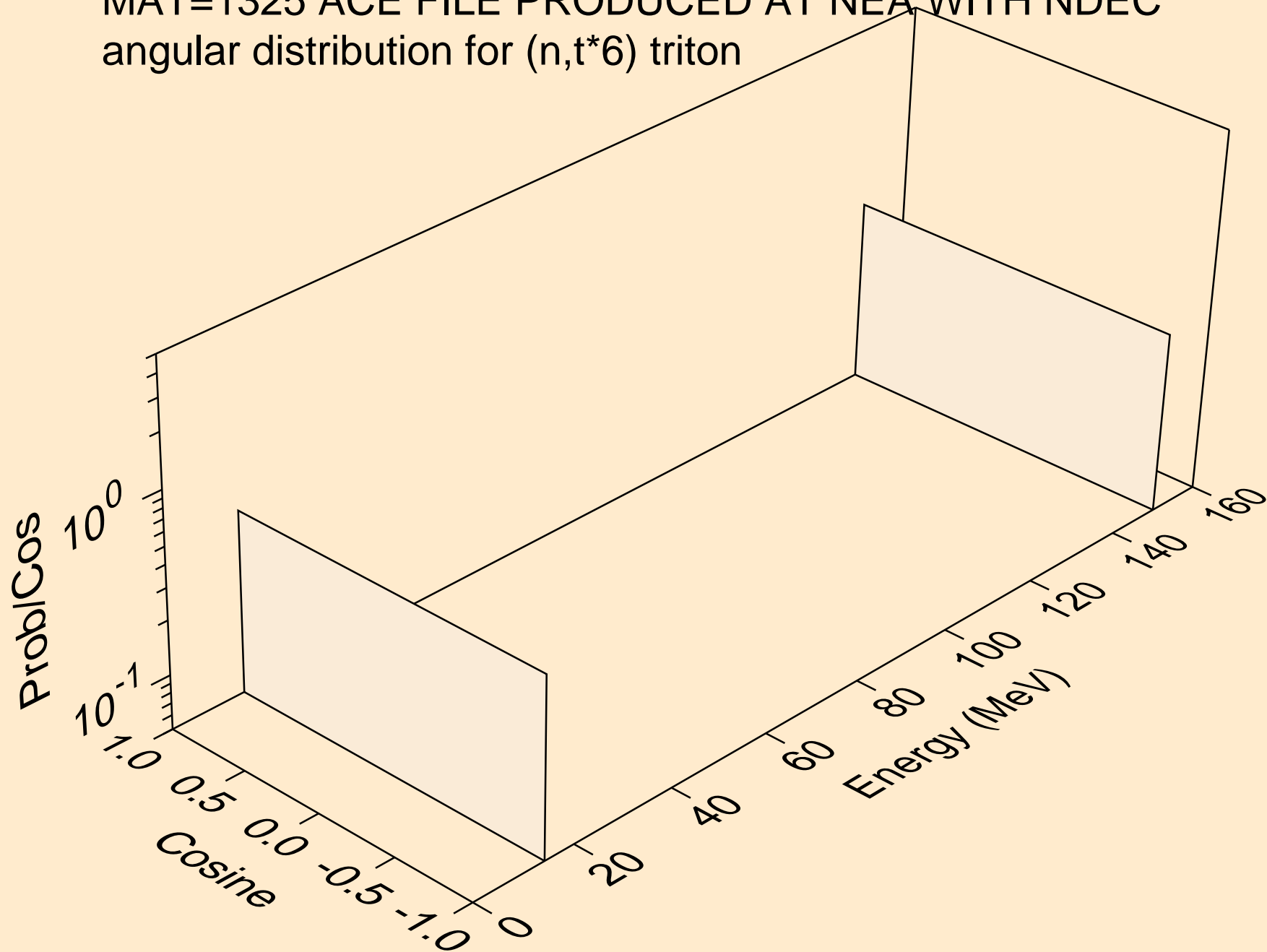

MAT=1325 ACE FILE PRODUCED AT NEA WITH NDEC  
angular distribution for (n,t\*7) triton

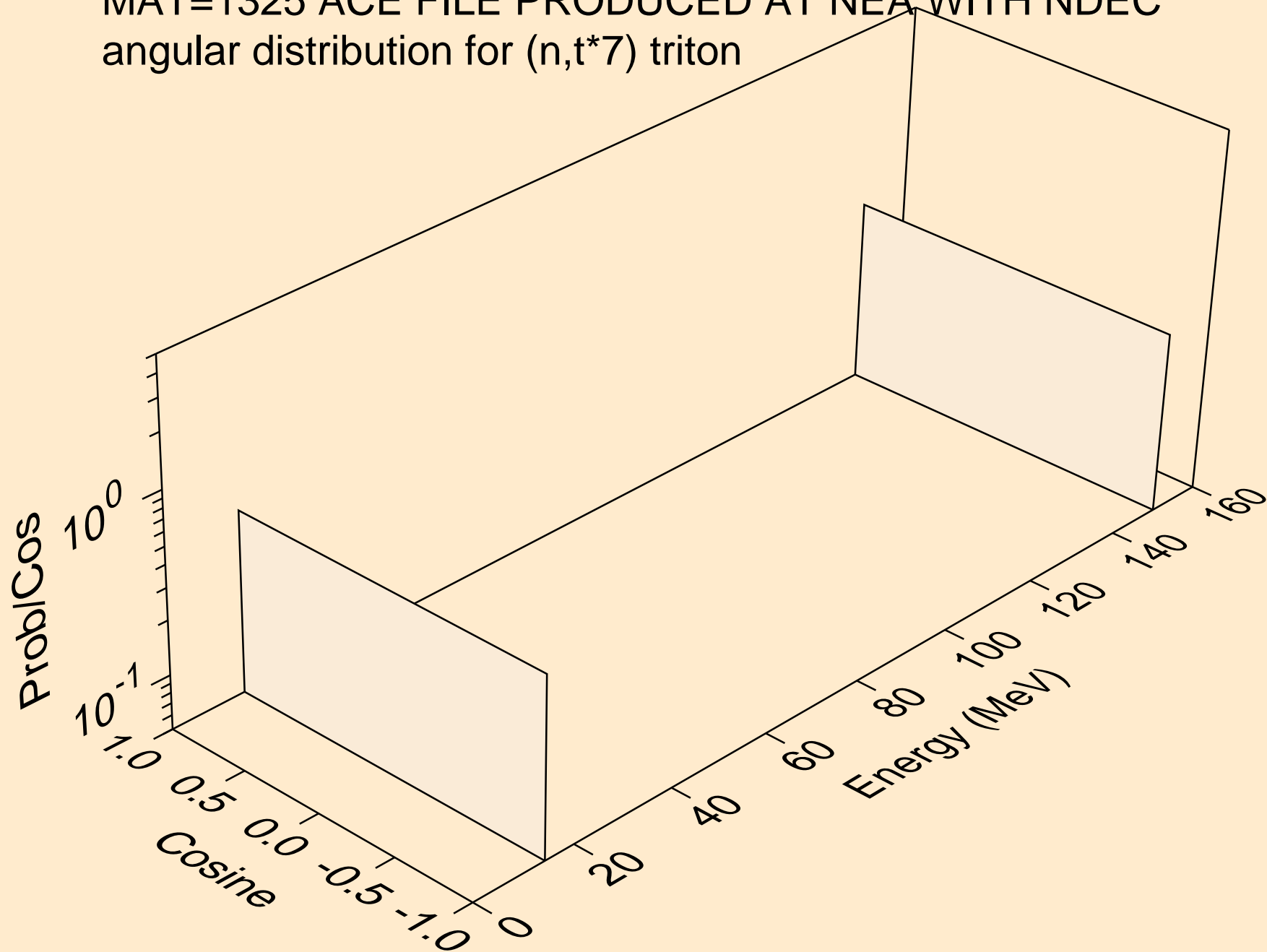



MAT=1325 ACE FILE PRODUCED AT NEA WITH NDEC  
angular distribution for (n,t\*8) triton

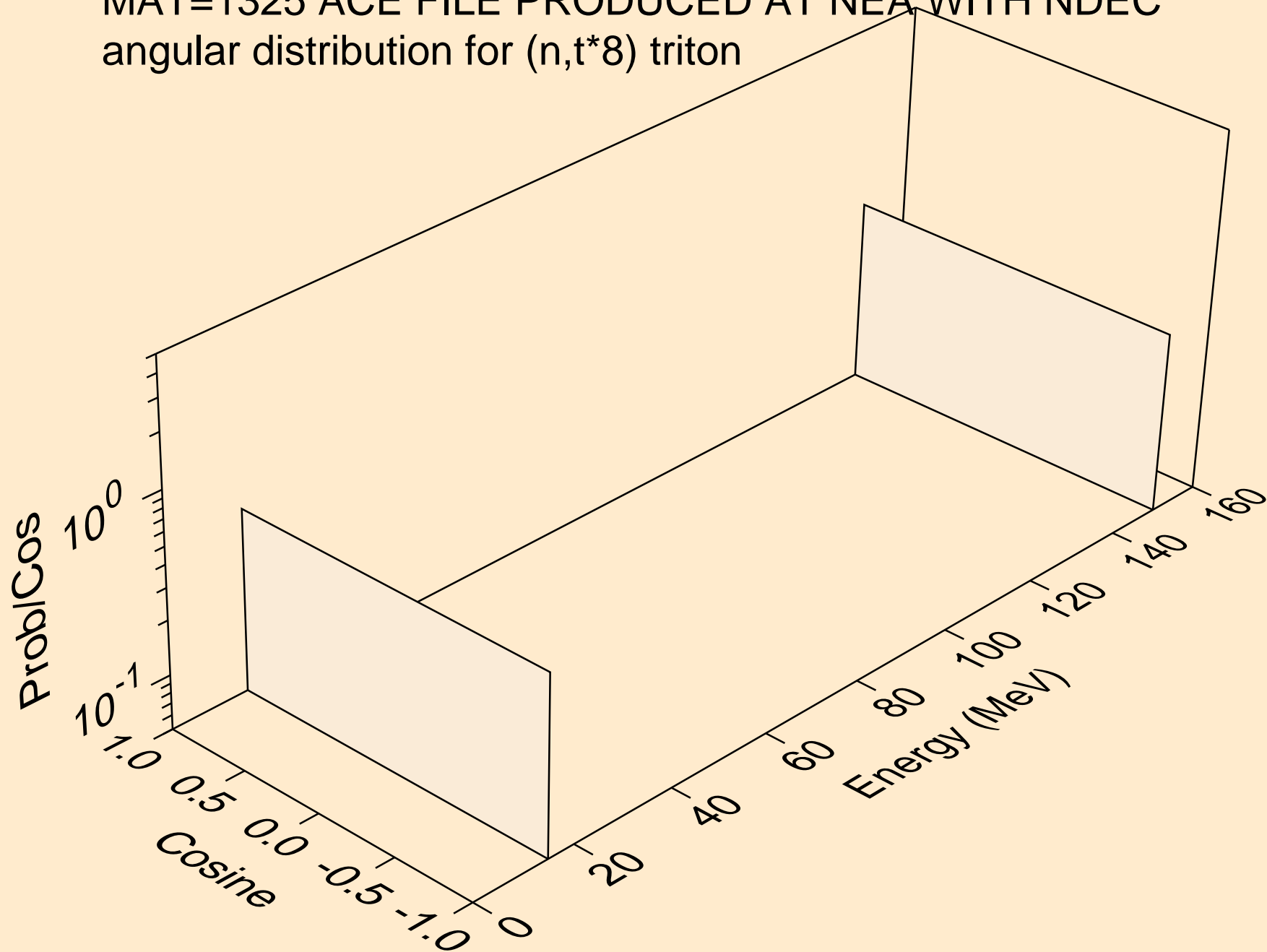

MAT=1325 ACE FILE PRODUCED AT NEA WITH NDEC  
angular distribution for (n,t\*9) triton

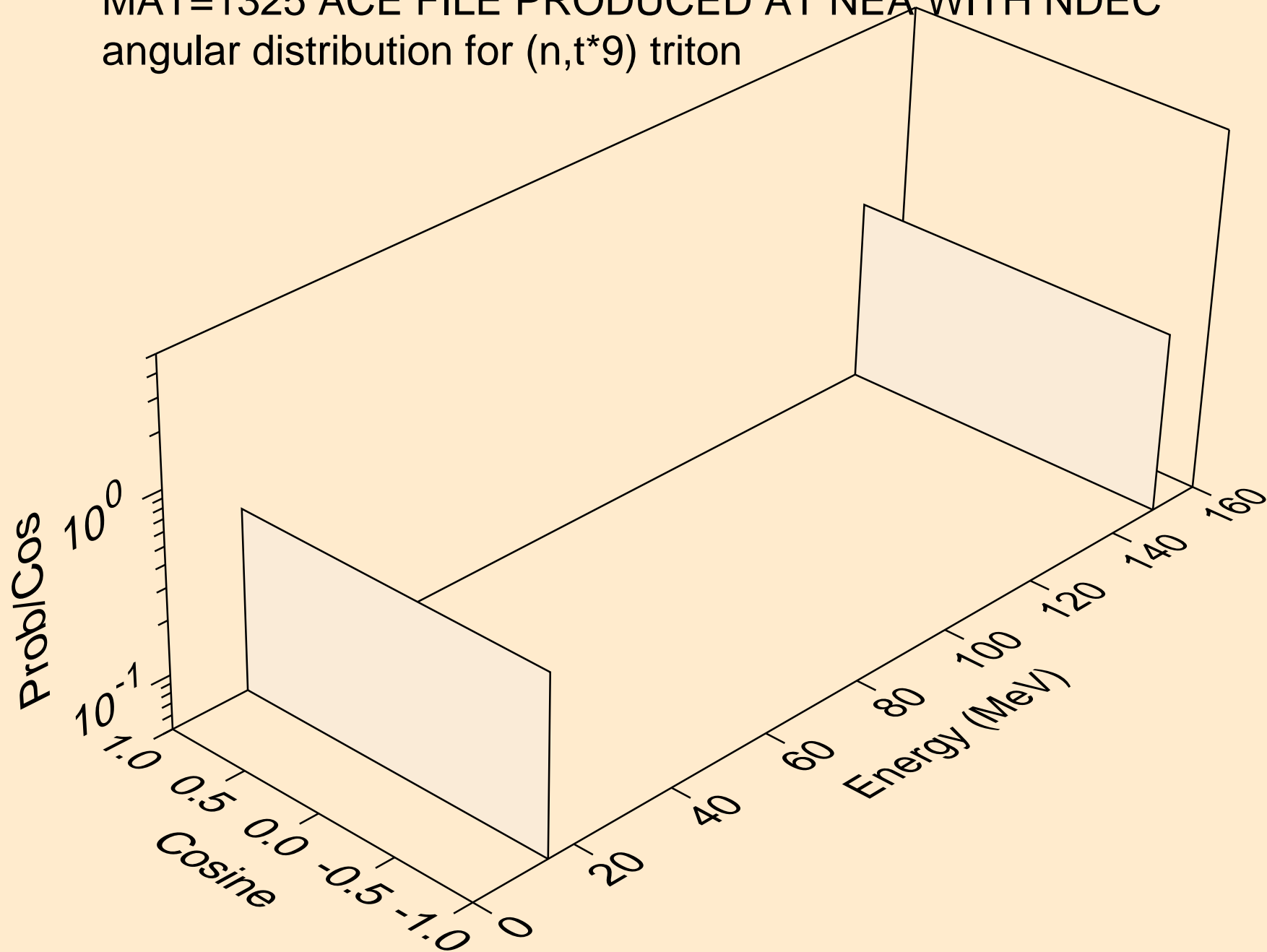

MAT=1325 ACE FILE PRODUCED AT NEA WITH NDEC  
angular distribution for (n,t\*10) triton

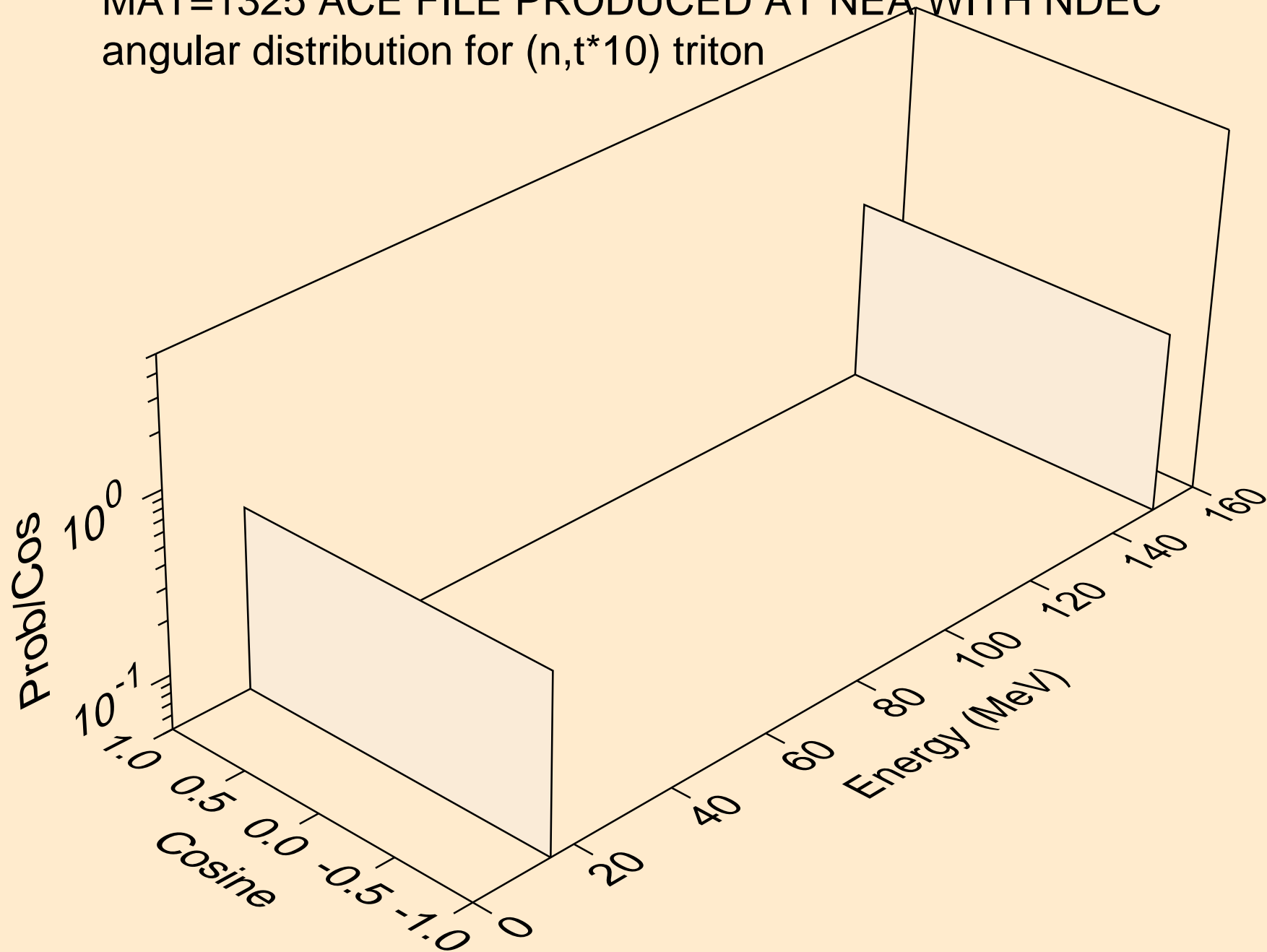

MAT=1325 ACE FILE PRODUCED AT NEA WITH NDEC  
tritons from (n,t\*c)

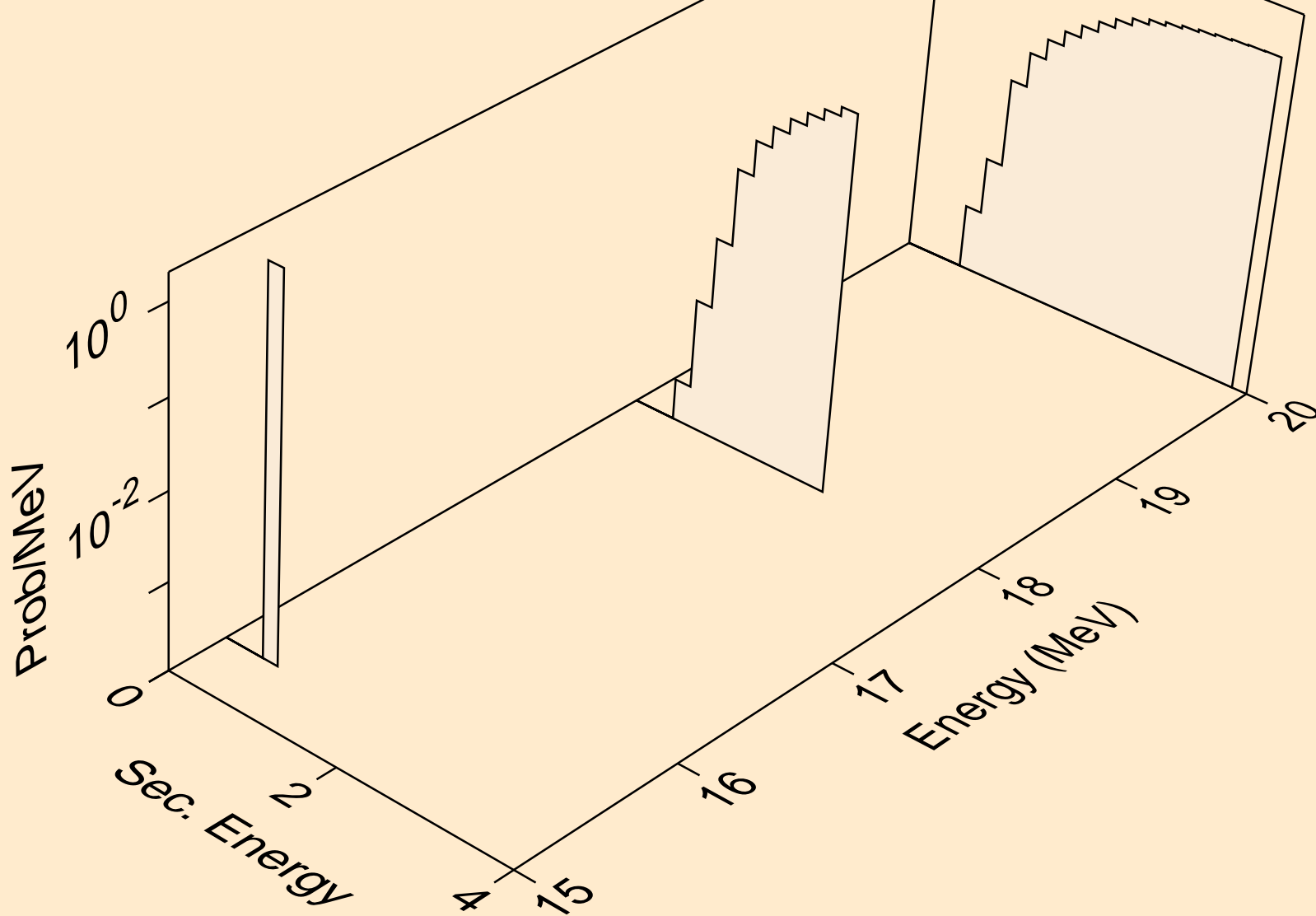

MAT=1325 ACE FILE PRODUCED AT NEA WITH NDEC  
alphas from (n,x)

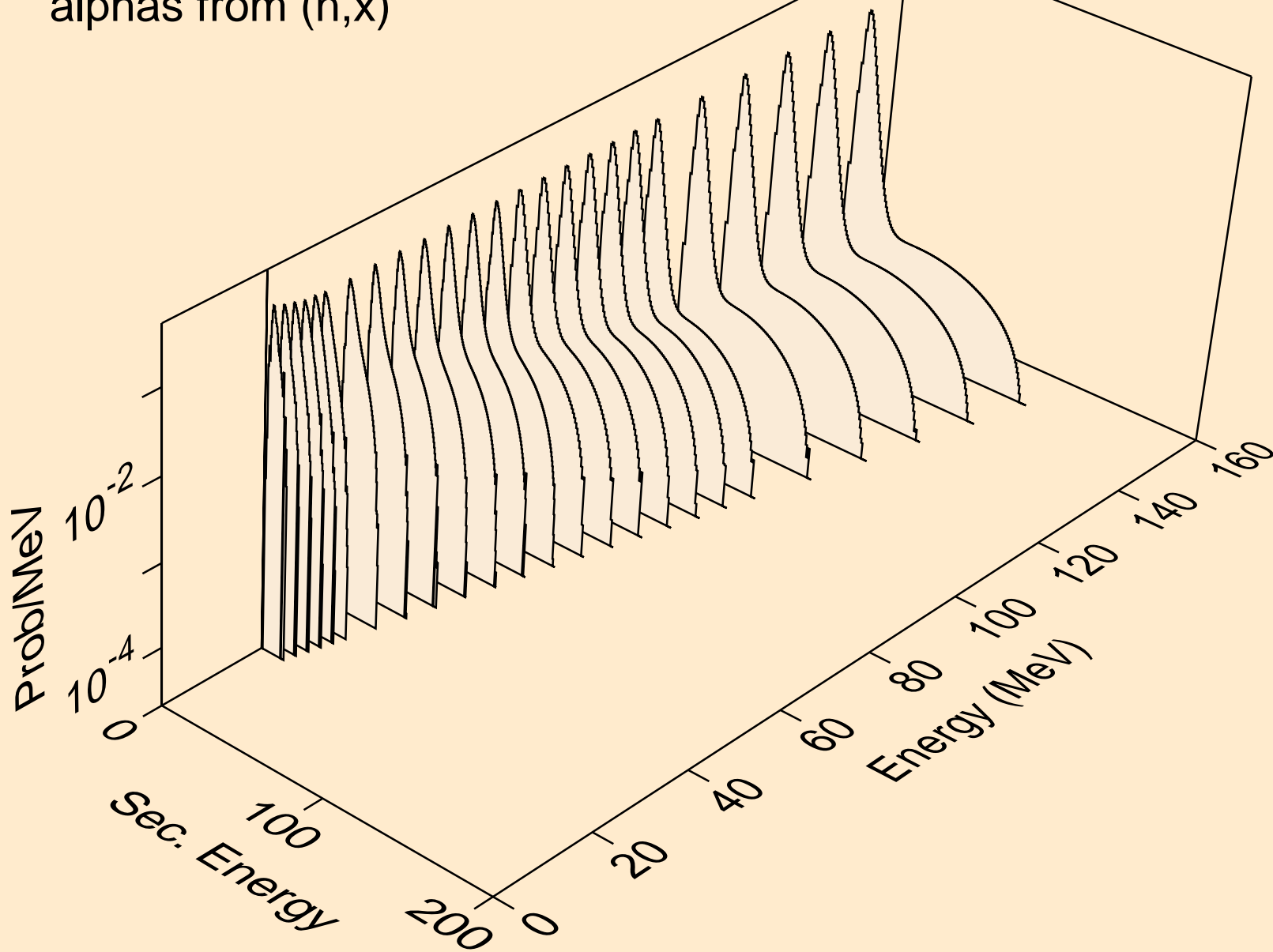

MAT=1325 ACE FILE PRODUCED AT NEA WITH NDEC  
alphas from (n,n\*)a

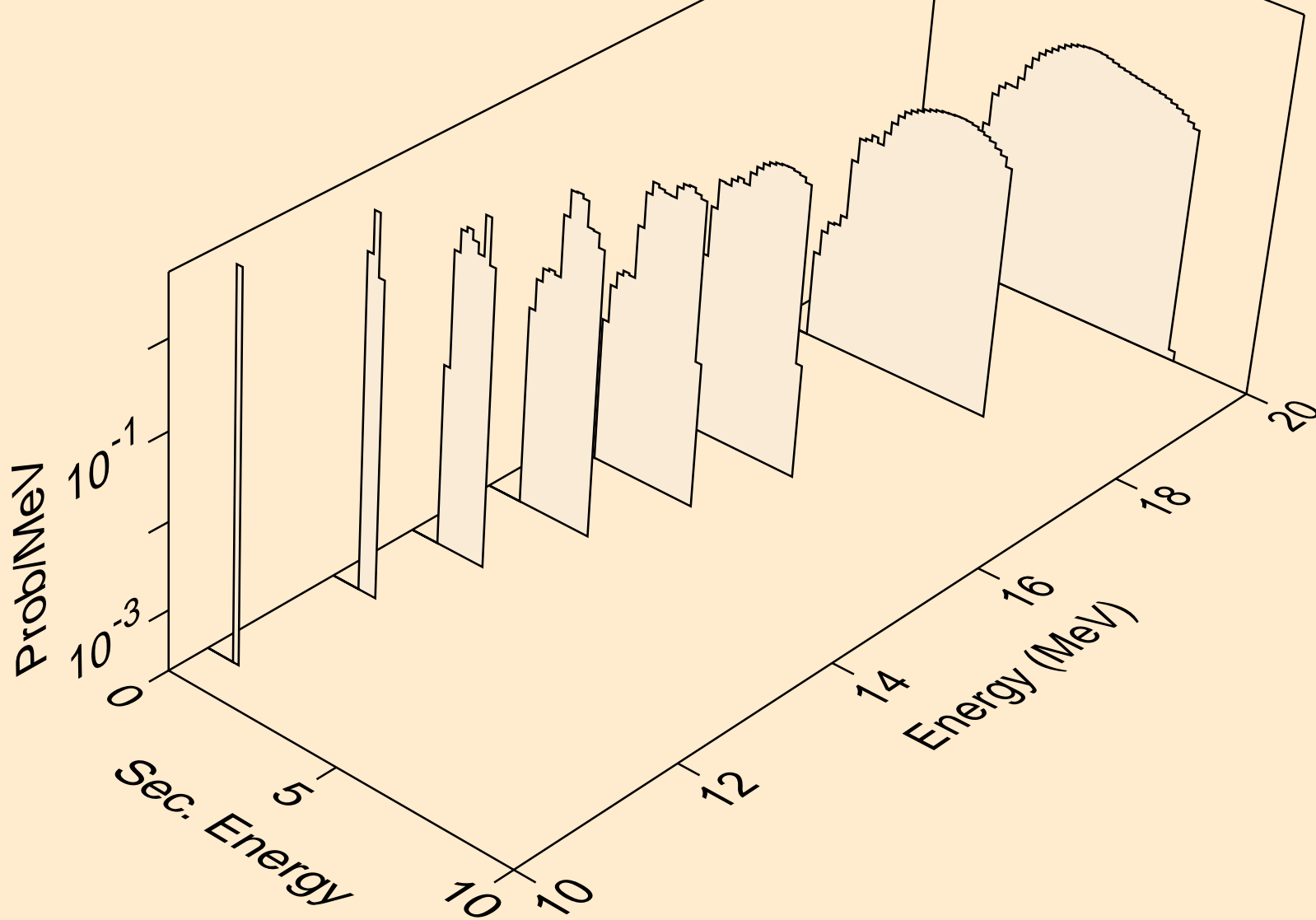

MAT=1325 ACE FILE PRODUCED AT NEA WITH NDEC  
alphas from (n,npa)

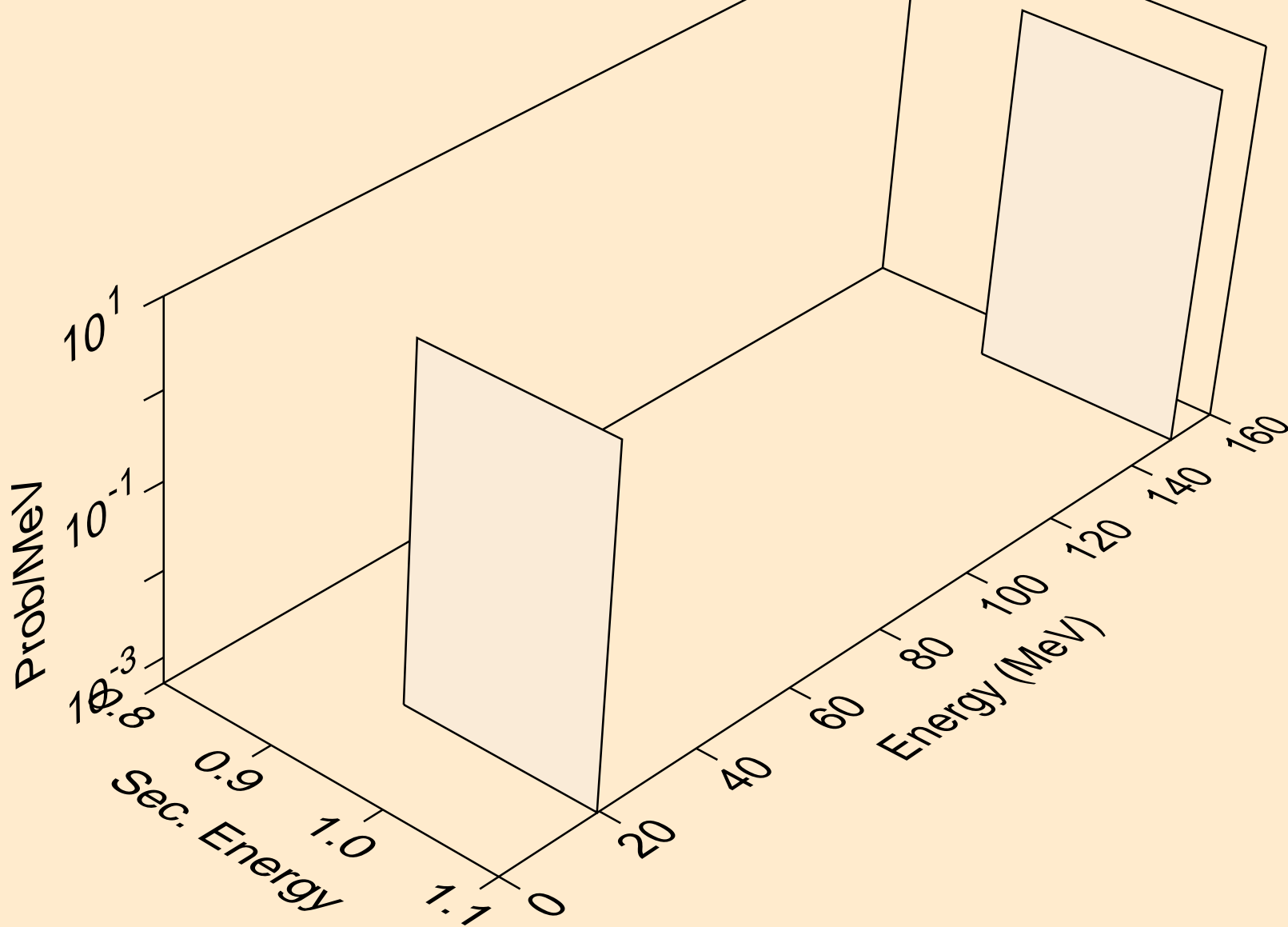

MAT=1325 ACE FILE PRODUCED AT NEA WITH NDEC  
alphas from (n,2a)

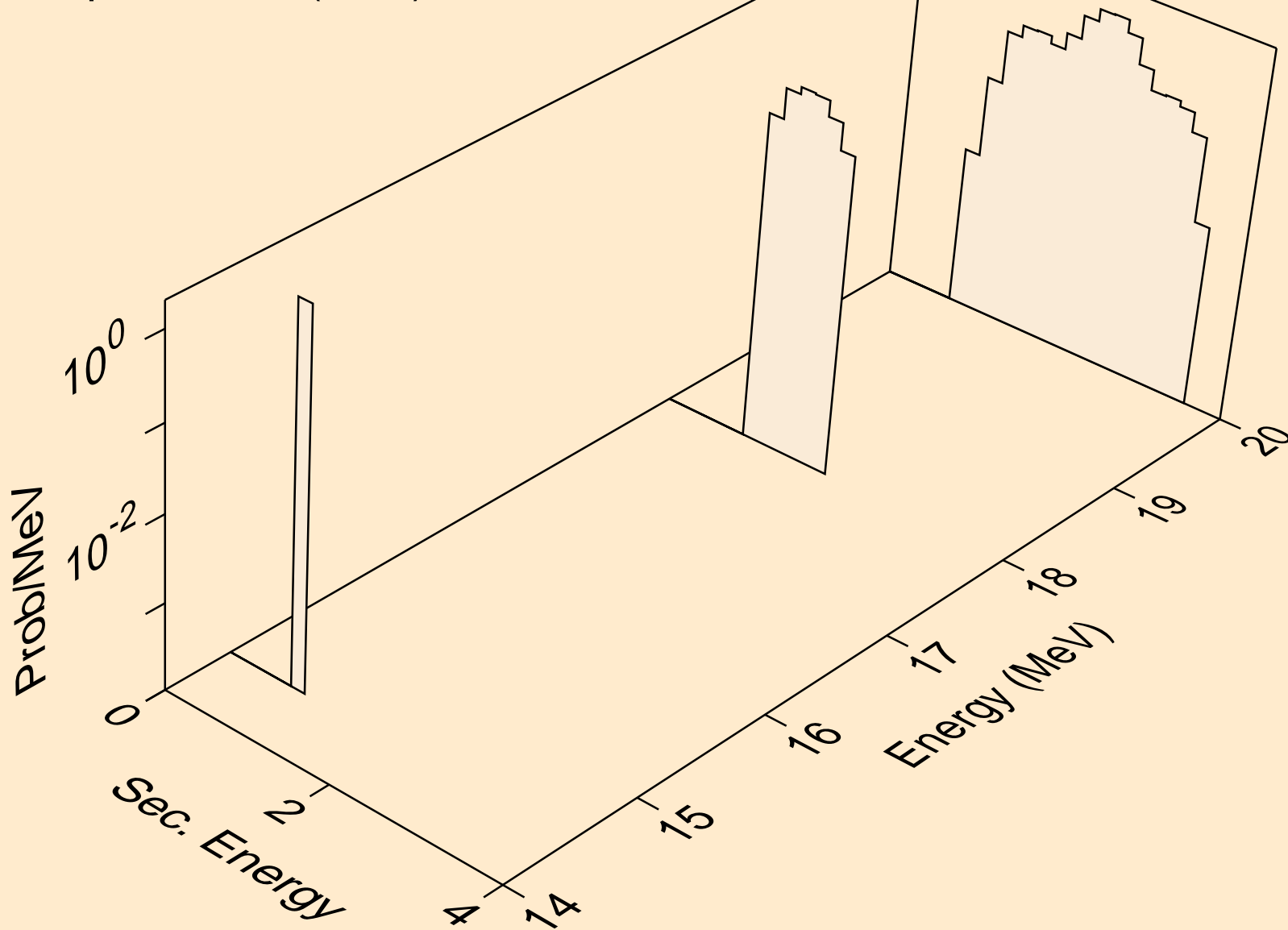



MAT=1325 ACE FILE PRODUCED AT NEA WITH NDEC  
alphas from (n,pa)

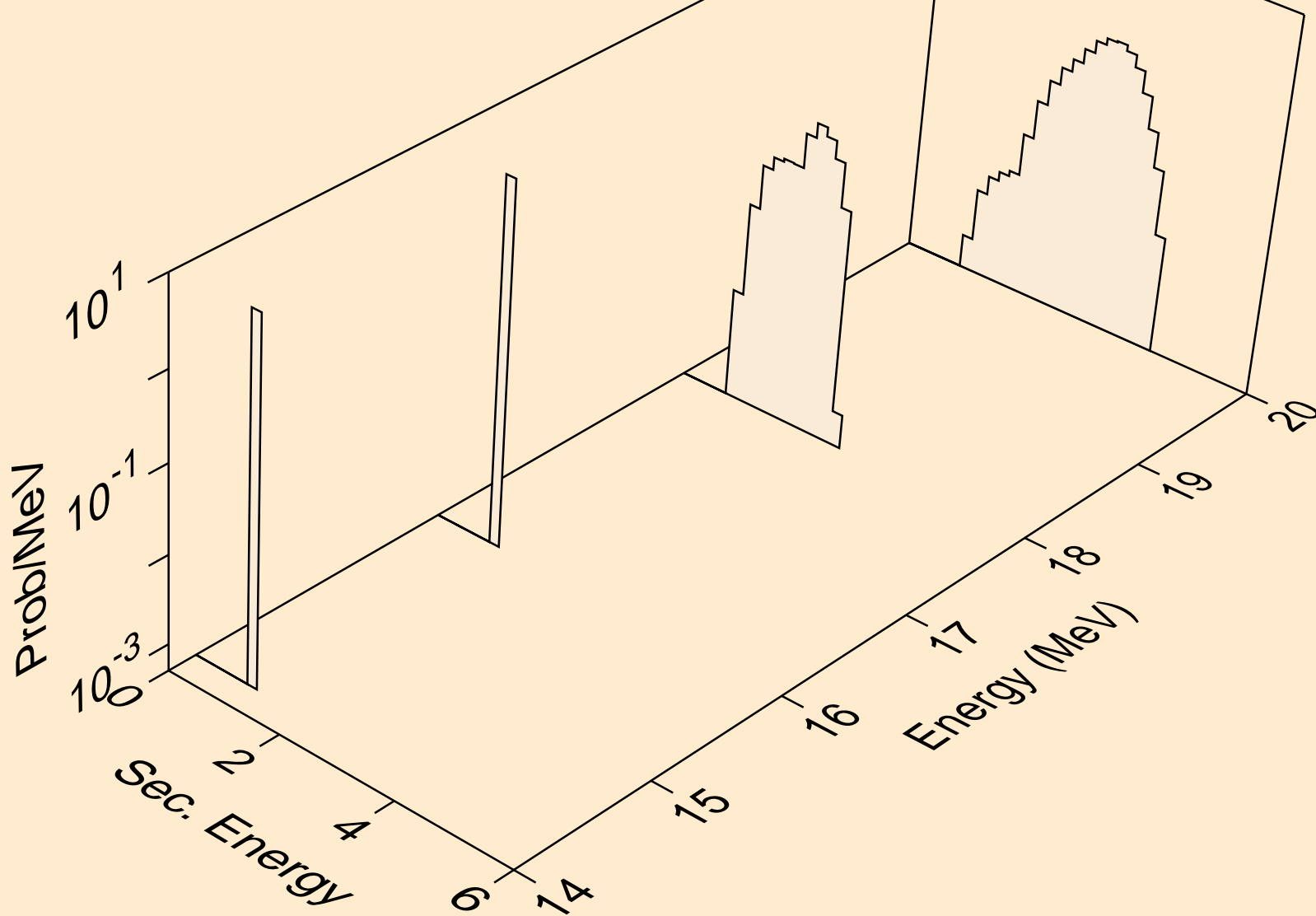

MAT=1325 ACE FILE PRODUCED AT NEA WITH NDEC  
alphas from (n,da)

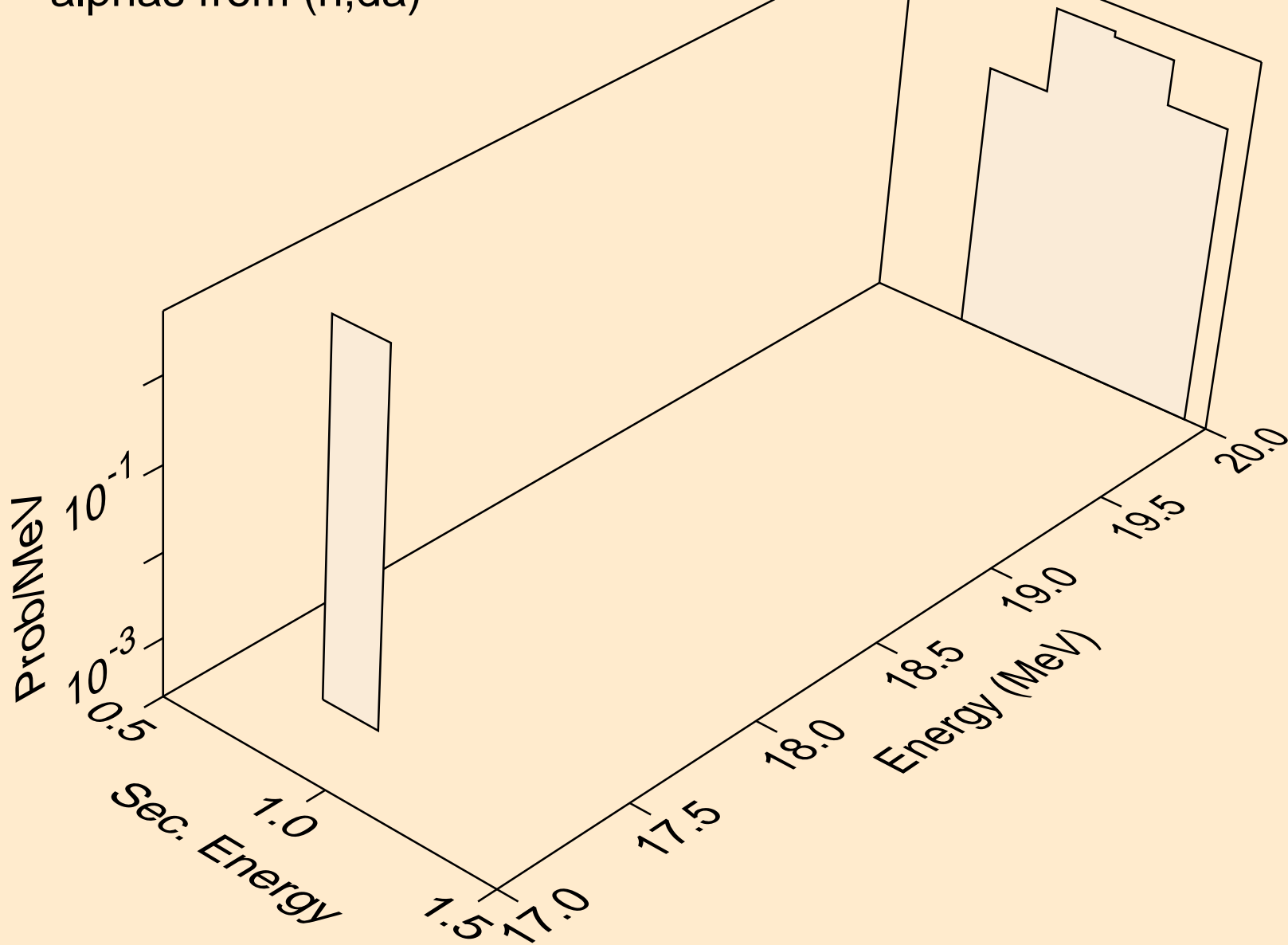

MAT=1325 ACE FILE PRODUCED AT NEA WITH NDEC  
angular distribution for (n,a\*0) alpha

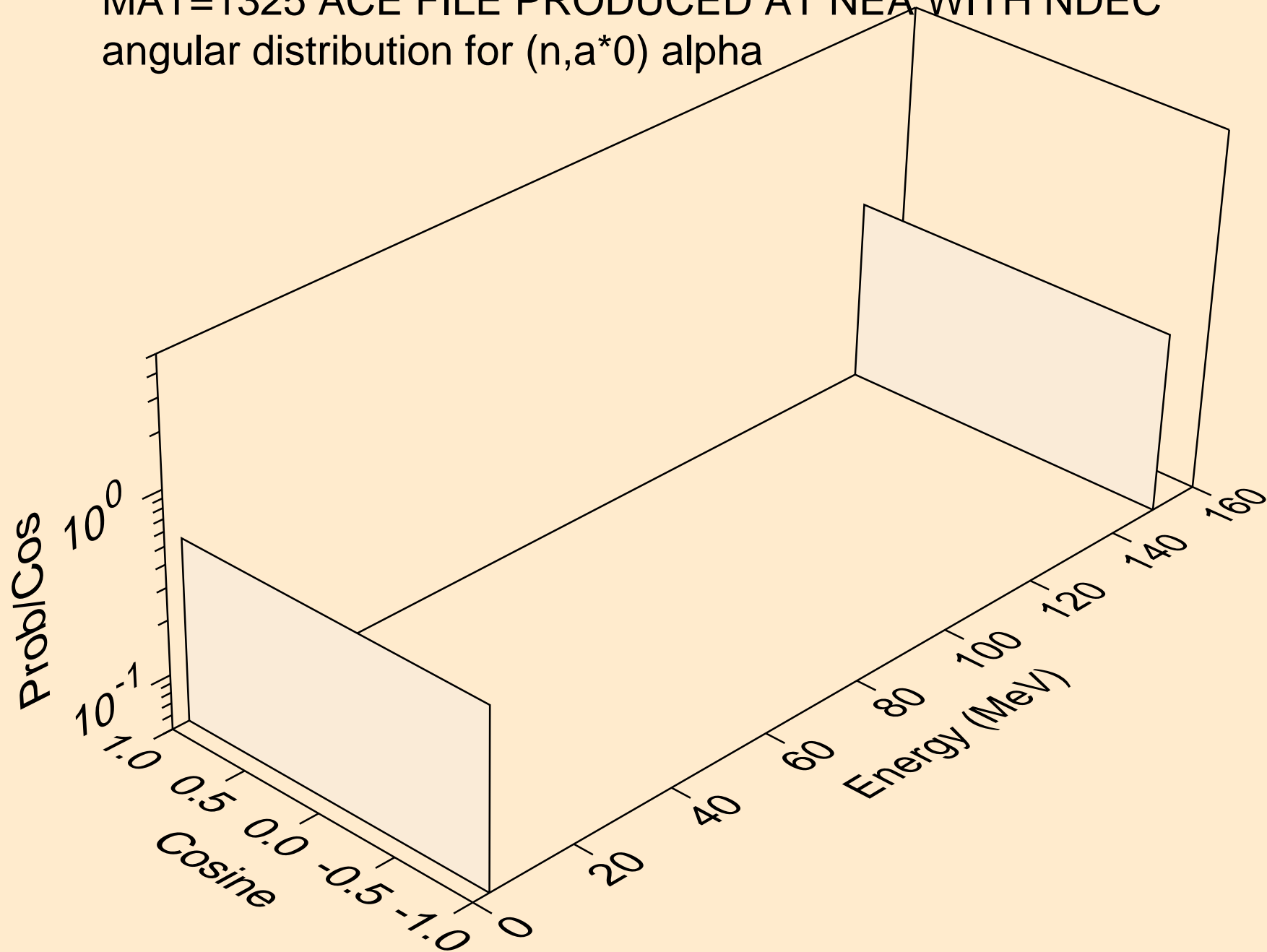

MAT=1325 ACE FILE PRODUCED AT NEA WITH NDEC  
angular distribution for (n,a\*1) alpha

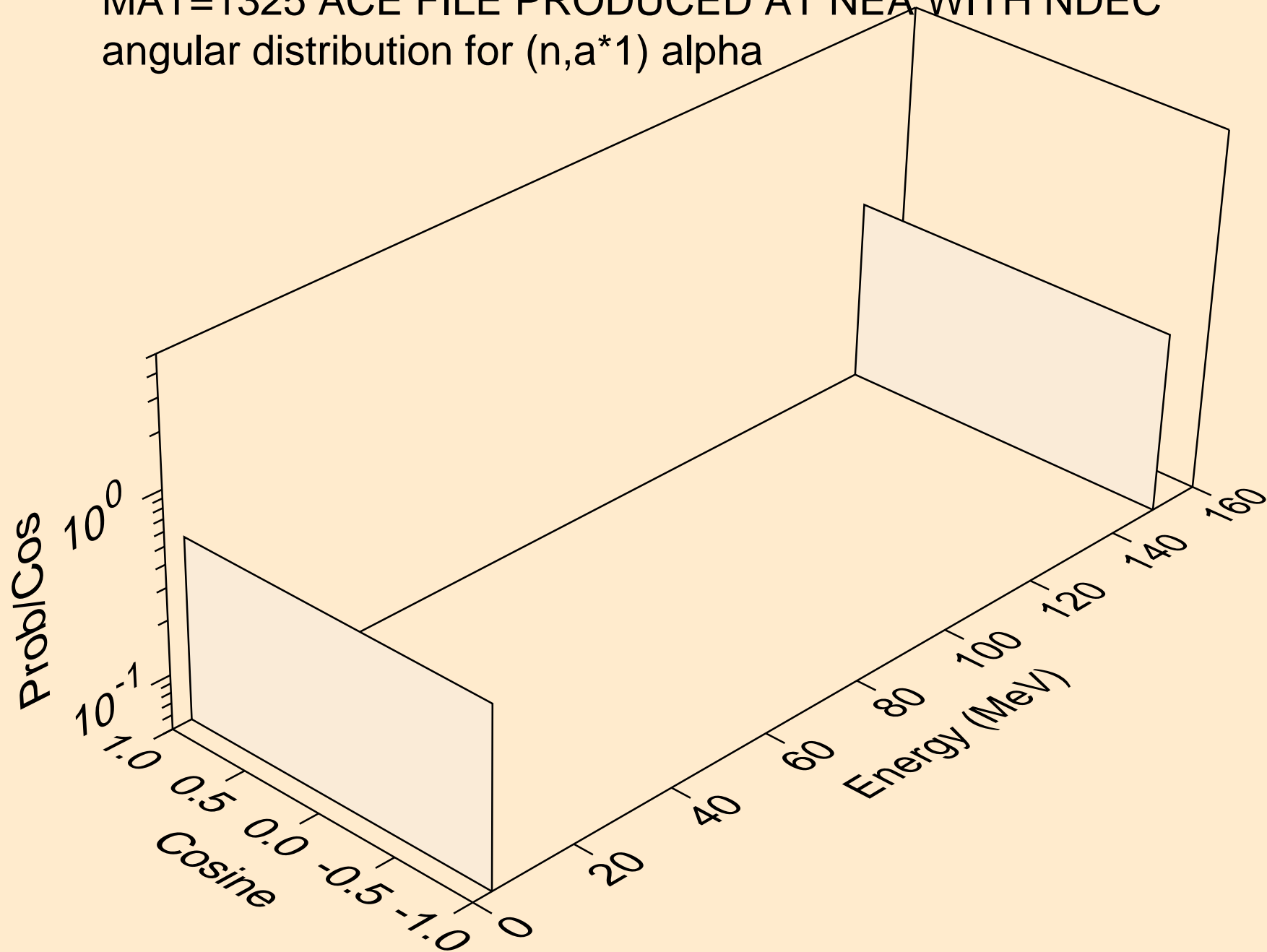

MAT=1325 ACE FILE PRODUCED AT NEA WITH NDEC  
angular distribution for (n,a\*2) alpha

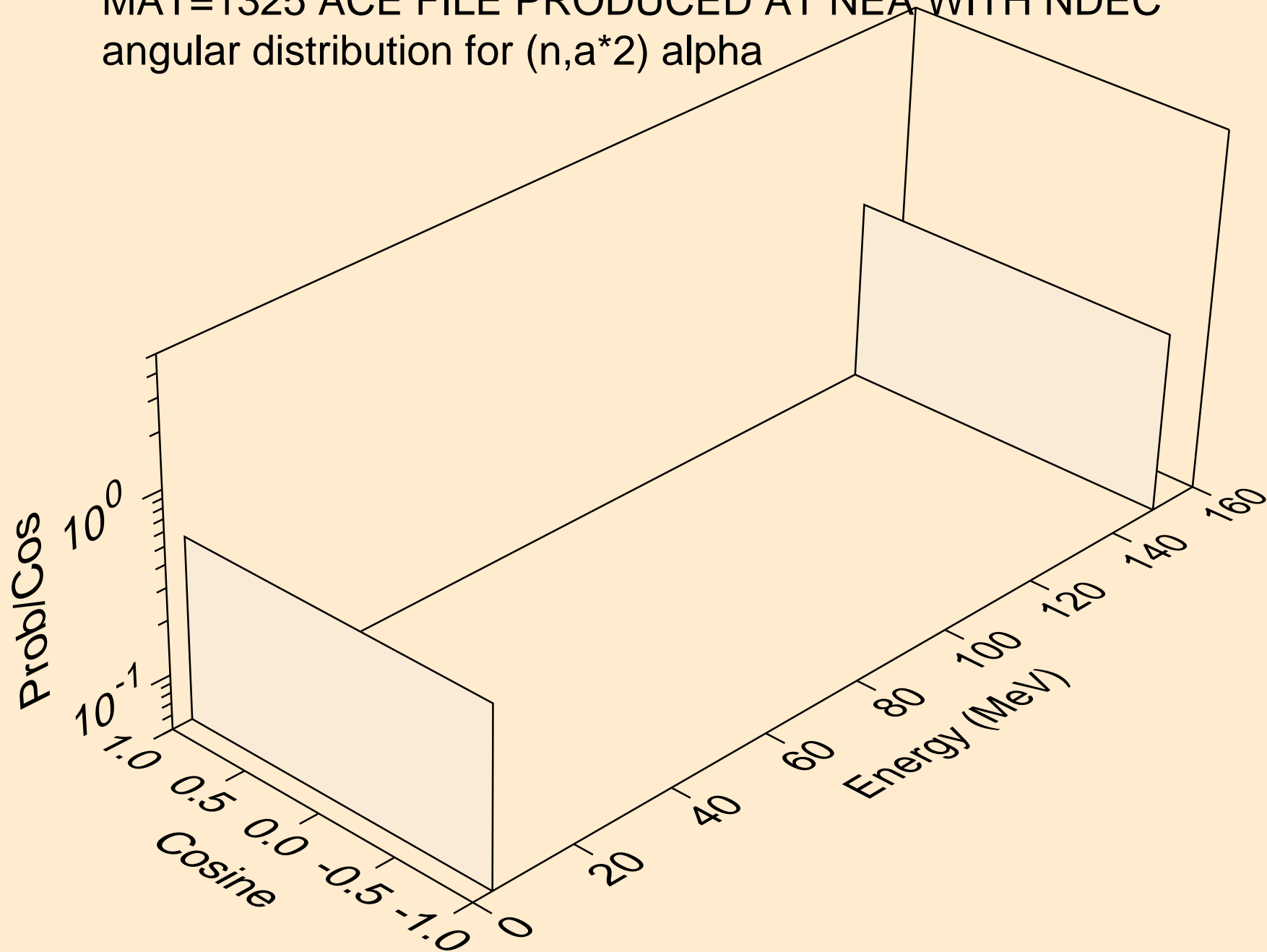

MAT=1325 ACE FILE PRODUCED AT NEA WITH NDEC  
angular distribution for (n,a\*3) alpha

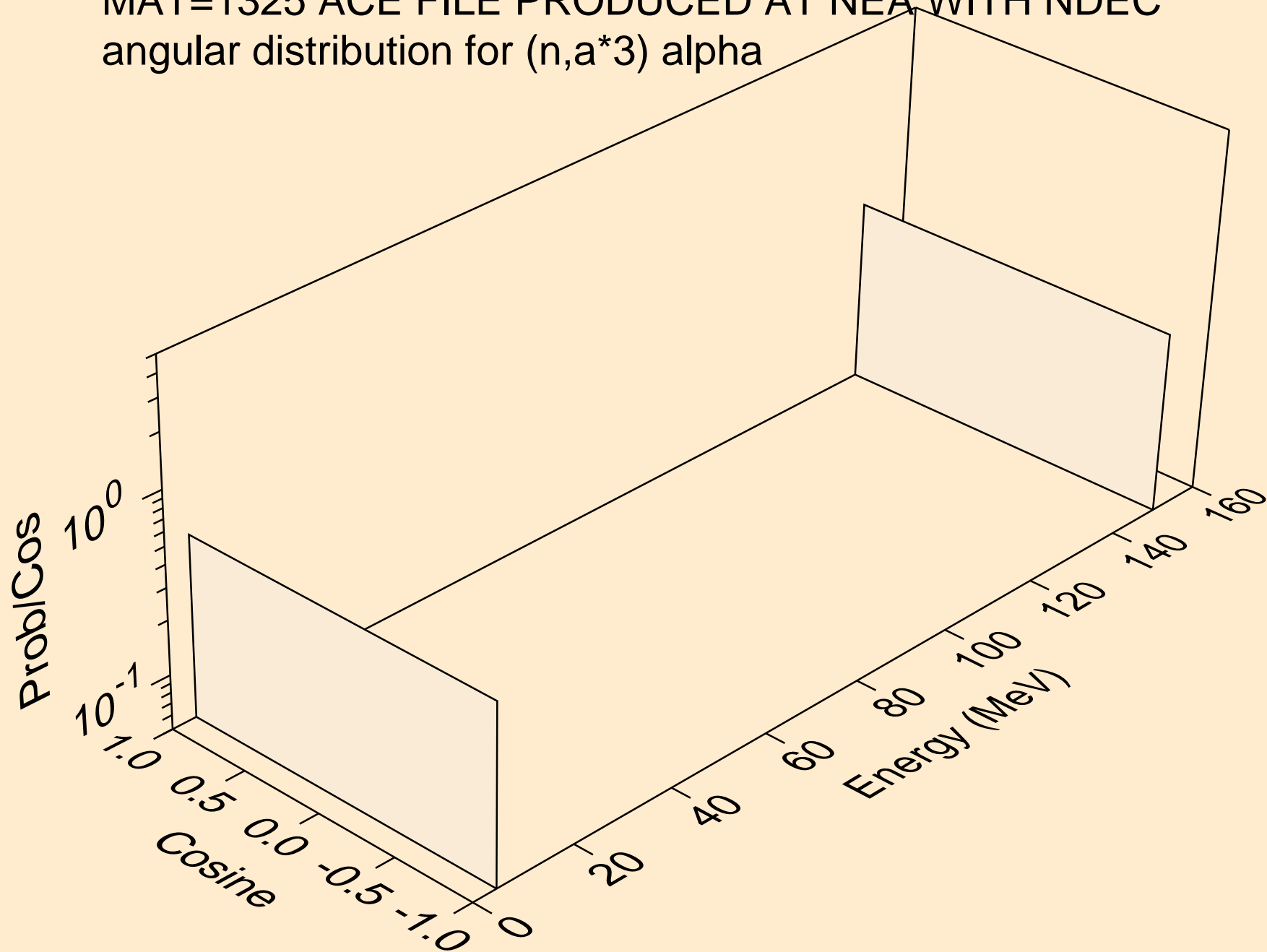

MAT=1325 ACE FILE PRODUCED AT NEA WITH NDEC  
angular distribution for (n,a\*4) alpha

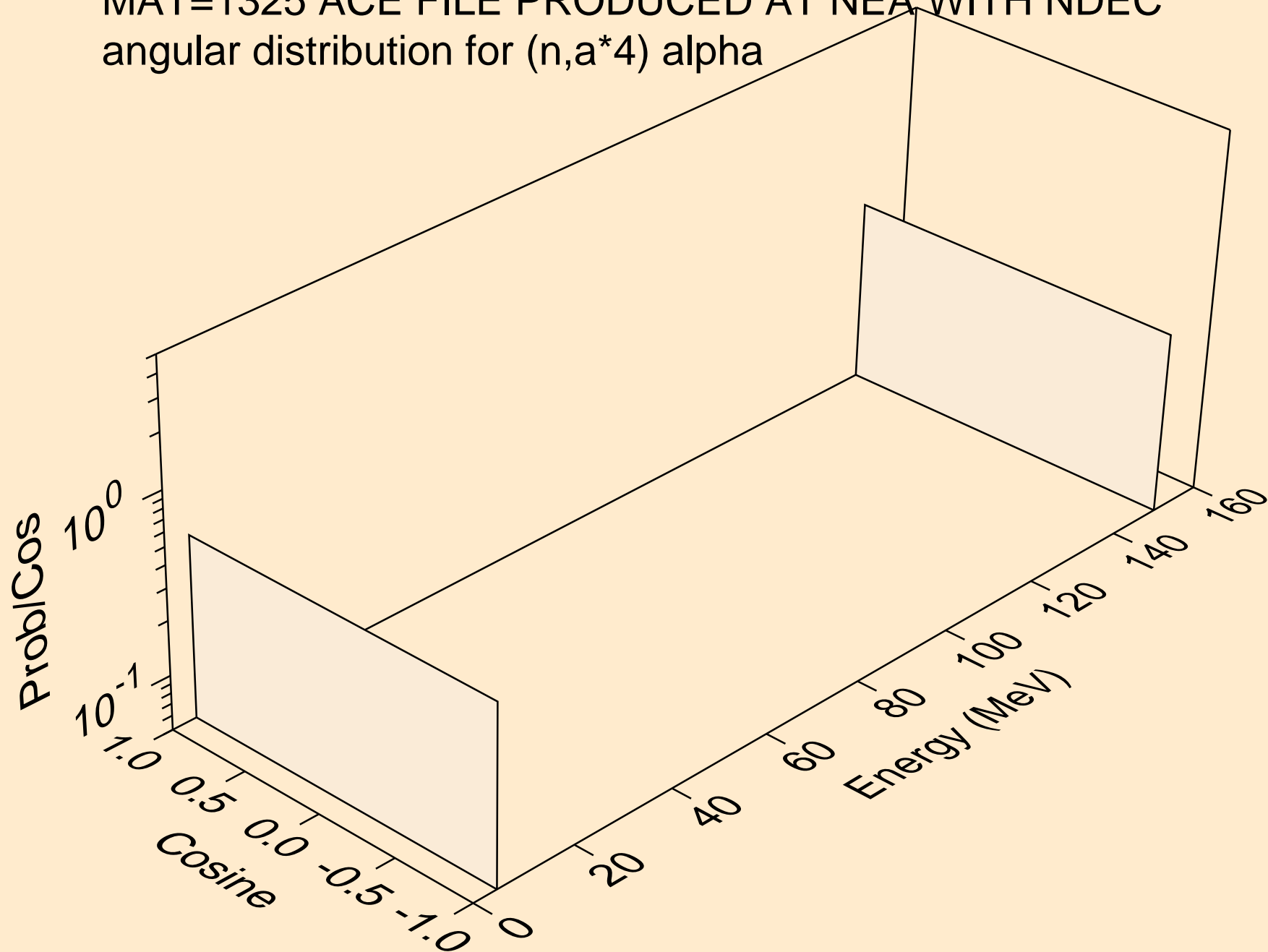

MAT=1325 ACE FILE PRODUCED AT NEA WITH NDEC  
angular distribution for (n,a\*5) alpha

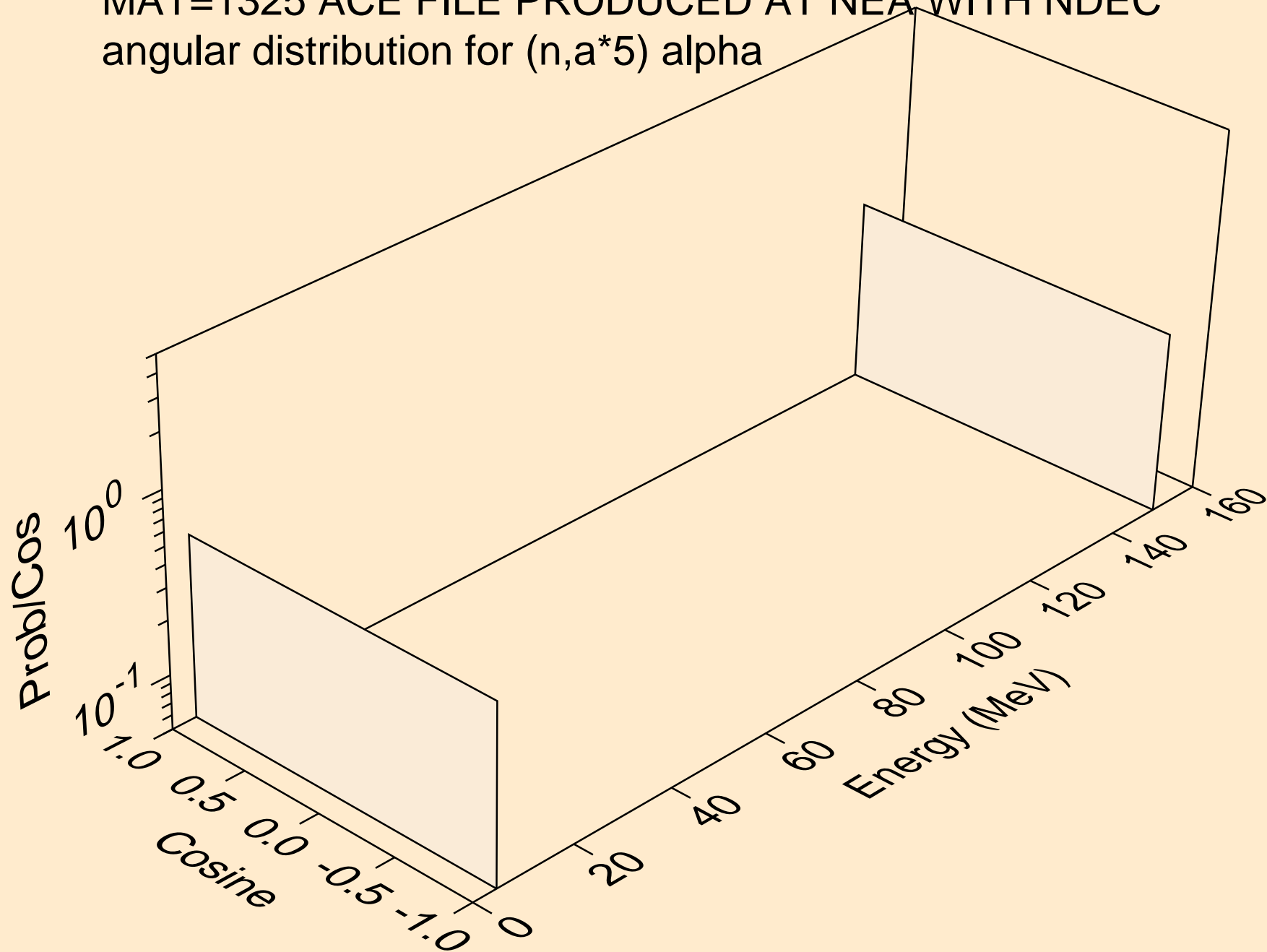



MAT=1325 ACE FILE PRODUCED AT NEA WITH NDEC  
angular distribution for (n,a\*6) alpha

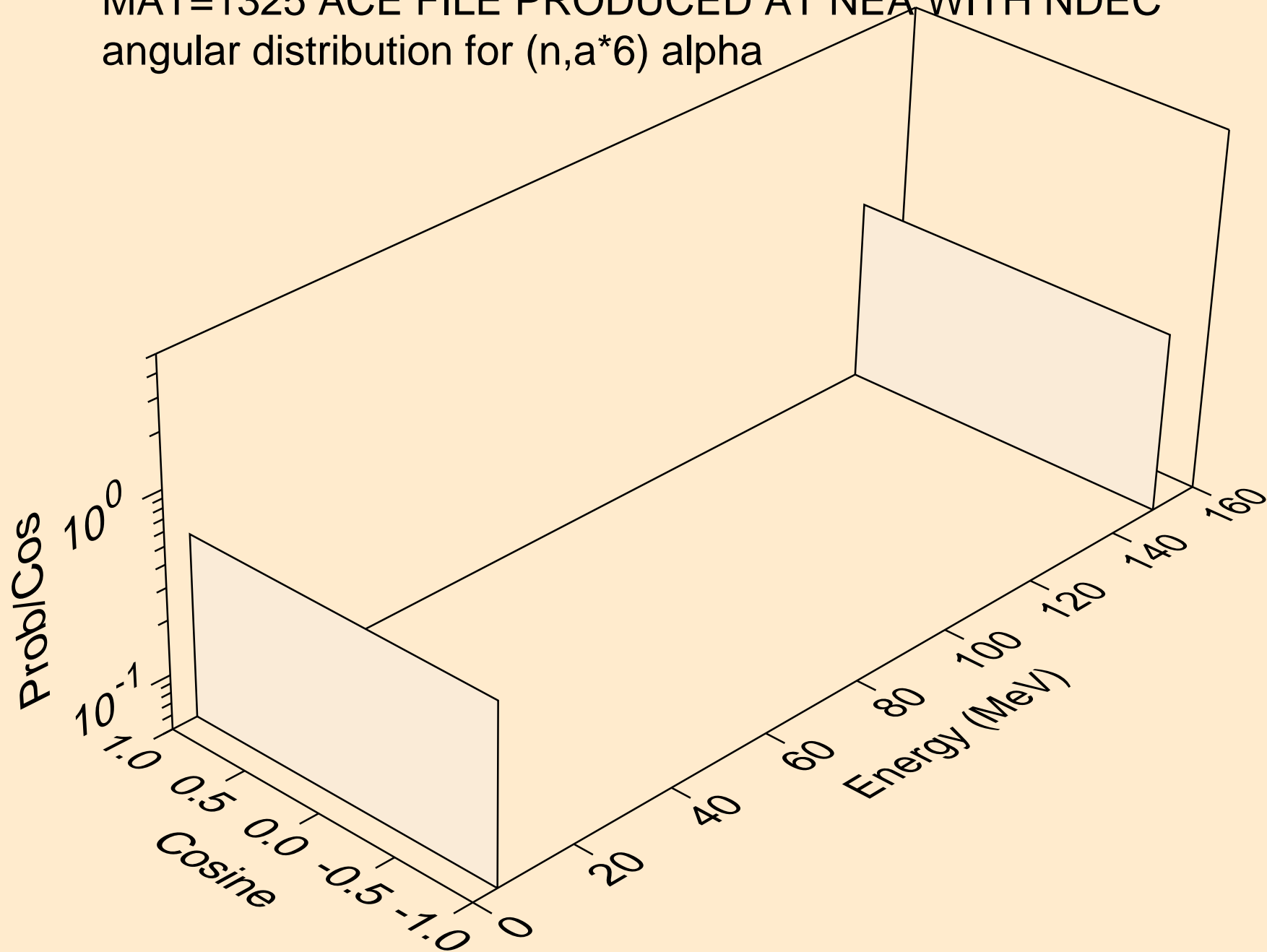

MAT=1325 ACE FILE PRODUCED AT NEA WITH NDEC  
angular distribution for (n,a\*7) alpha

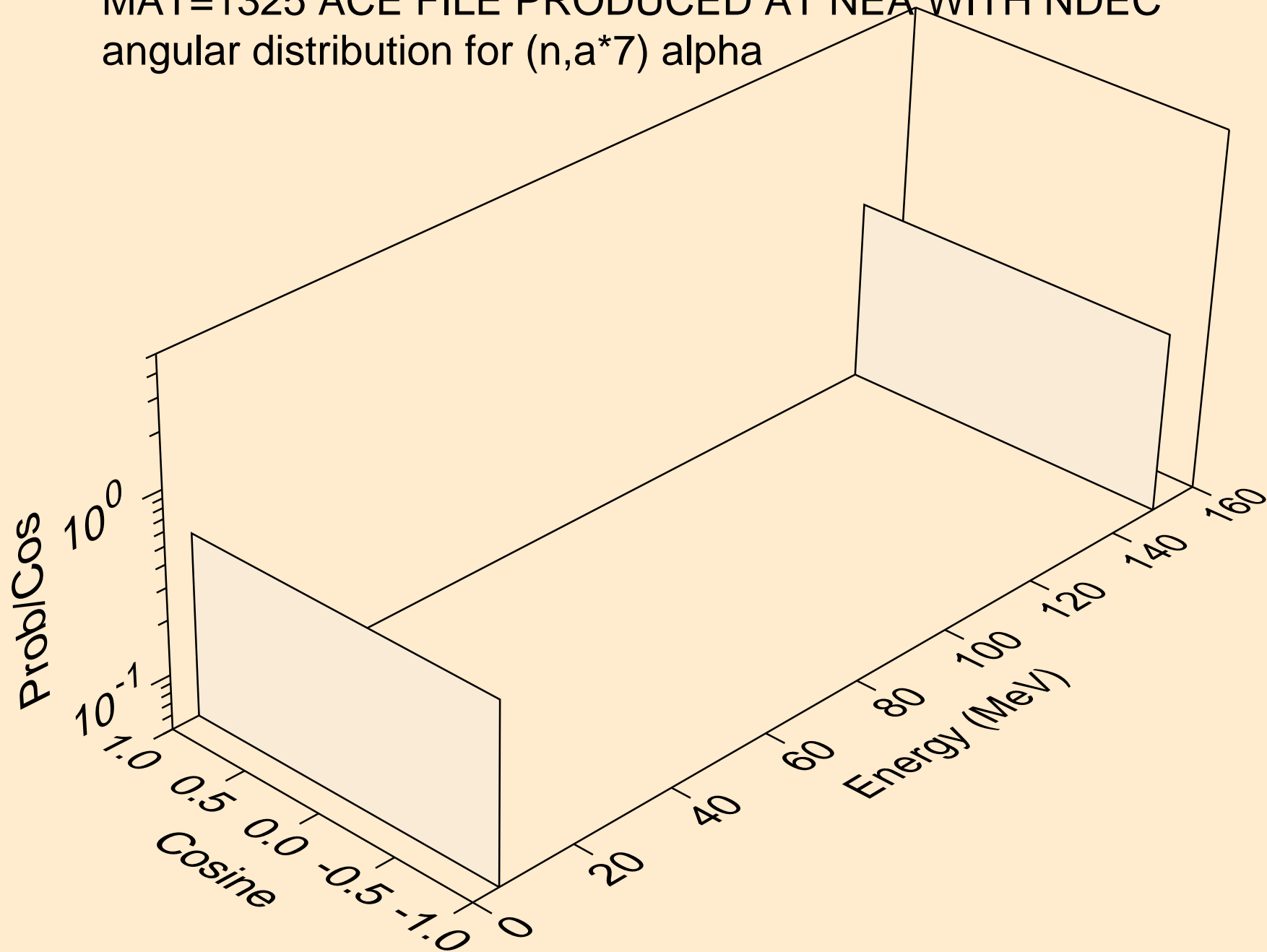

MAT=1325 ACE FILE PRODUCED AT NEA WITH NDEC  
angular distribution for (n,a\*8) alpha

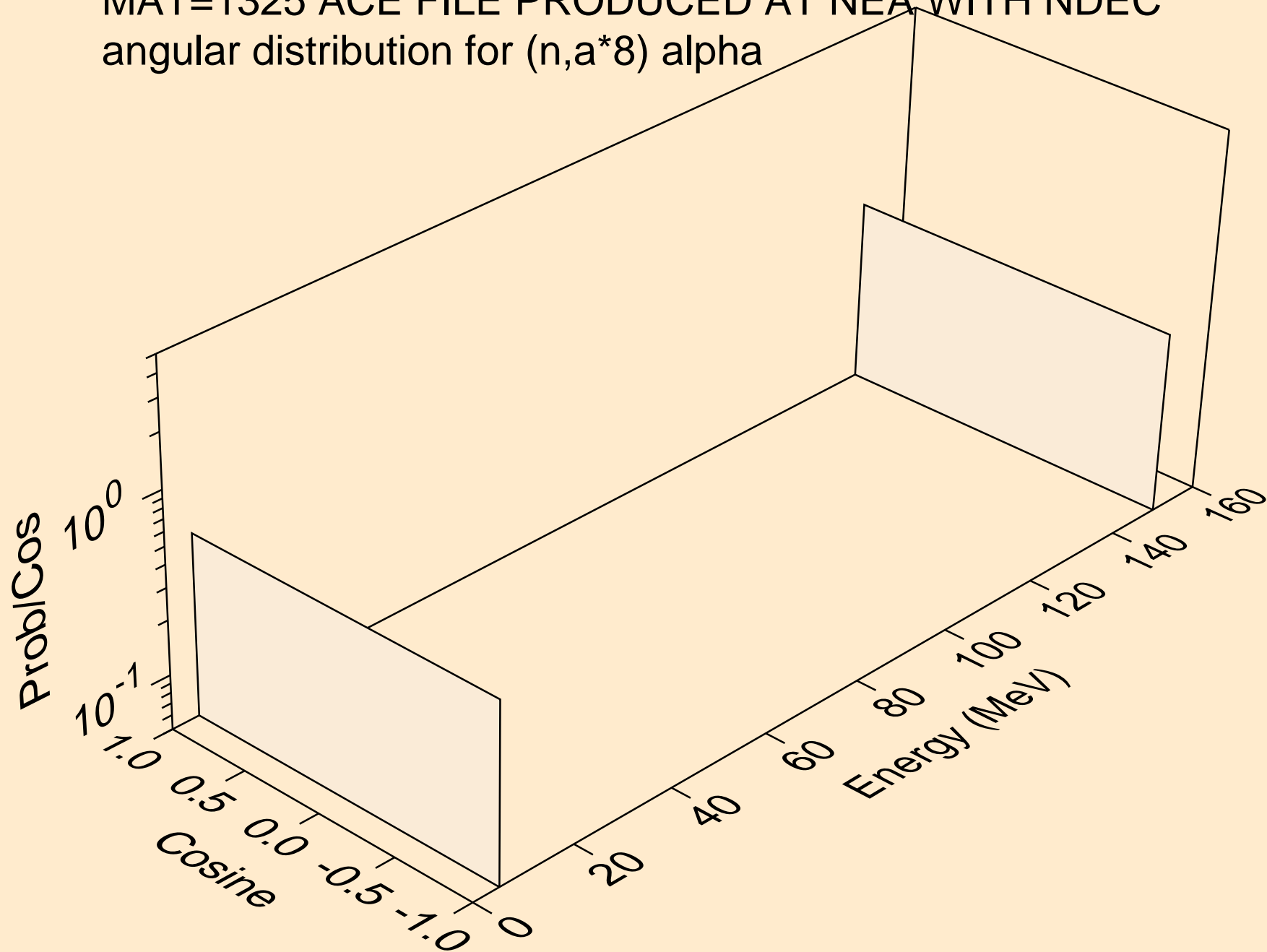

MAT=1325 ACE FILE PRODUCED AT NEA WITH NDEC  
angular distribution for (n,a\*9) alpha

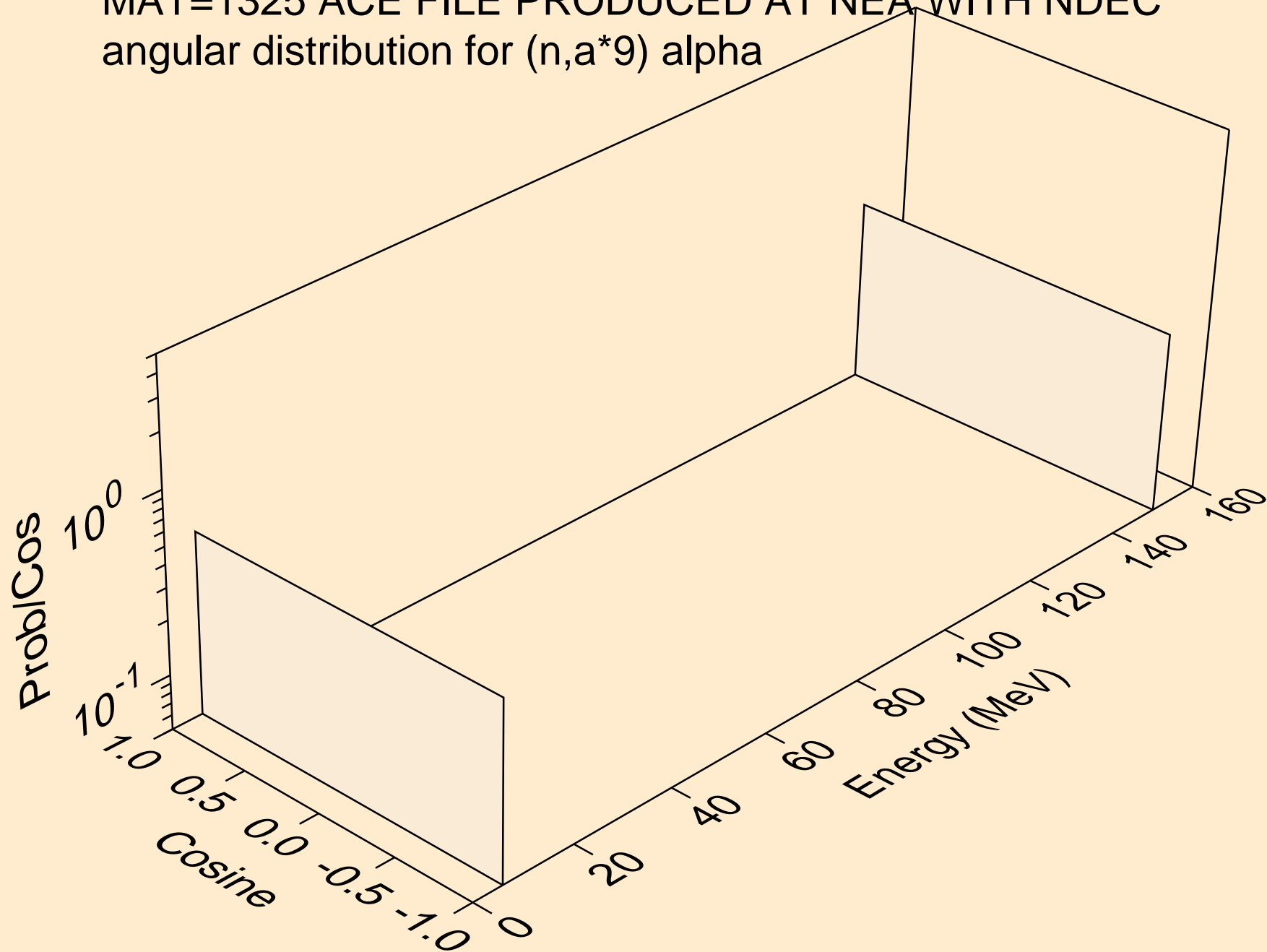

MAT=1325 ACE FILE PRODUCED AT NEA WITH NDEC  
angular distribution for (n,a\*10) alpha

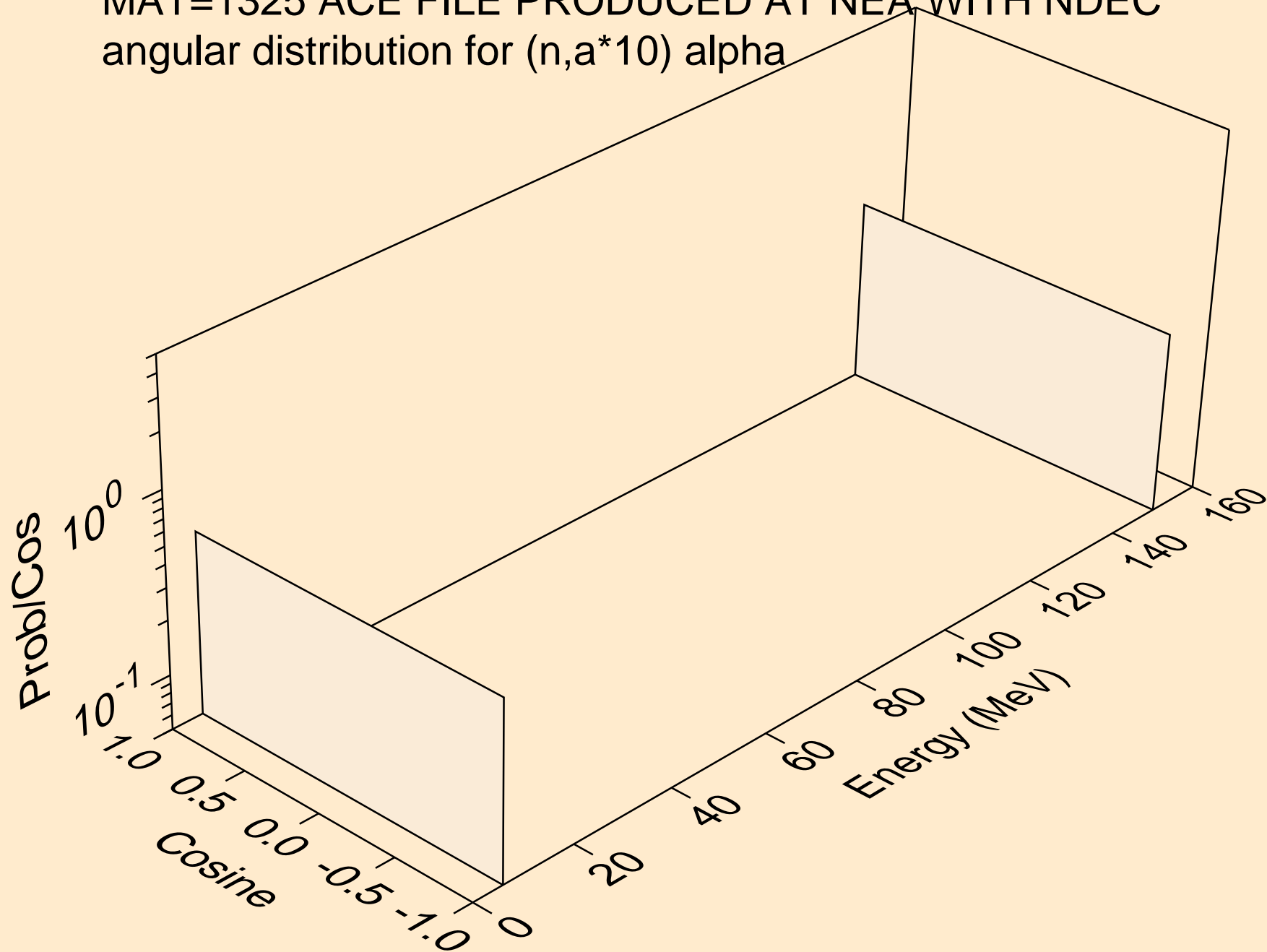

MAT=1325 ACE FILE PRODUCED AT NEA WITH NDEC  
angular distribution for (n,a\*11) alpha

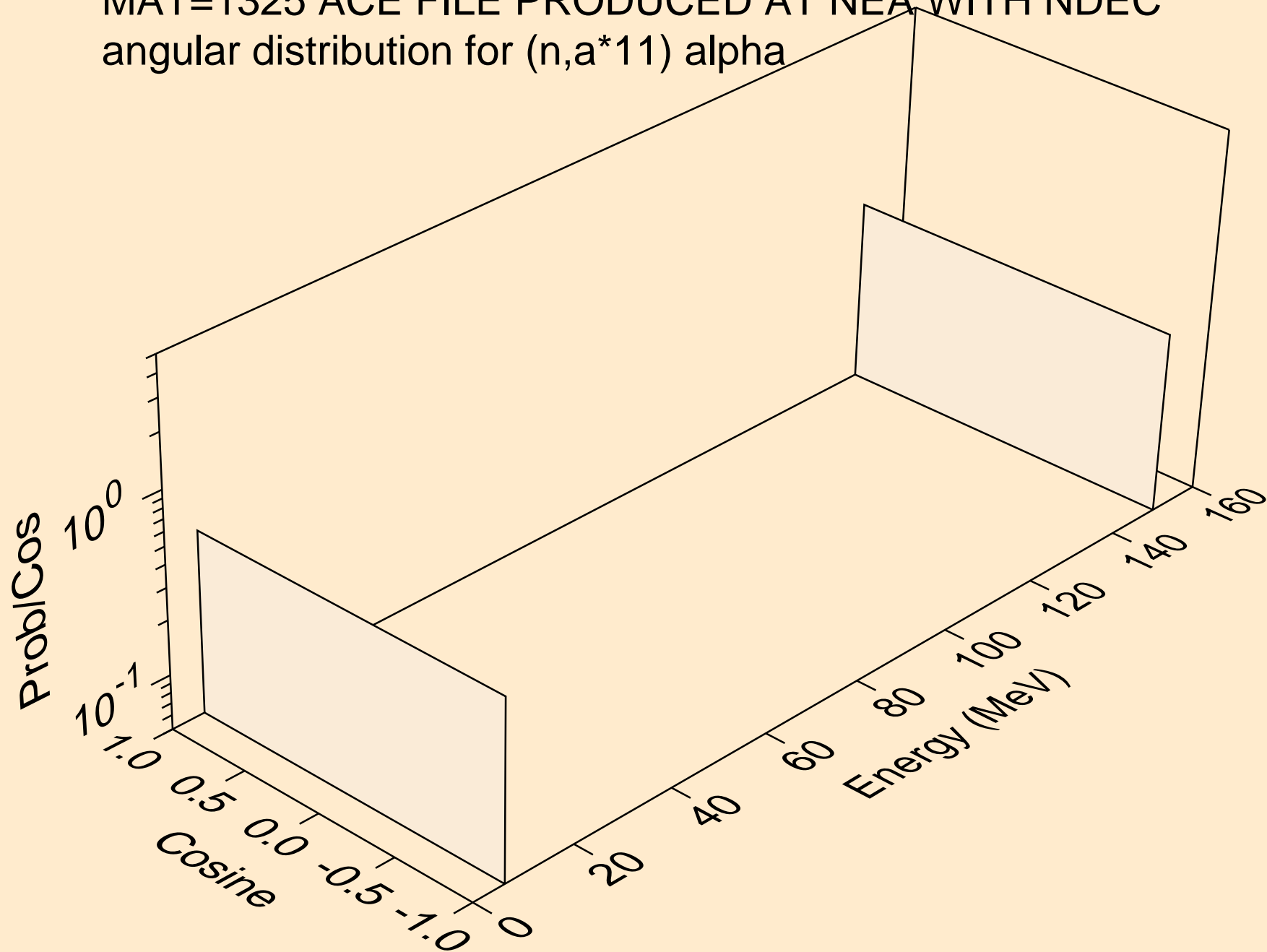

MAT=1325 ACE FILE PRODUCED AT NEA WITH NDEC  
angular distribution for (n,a\*12) alpha

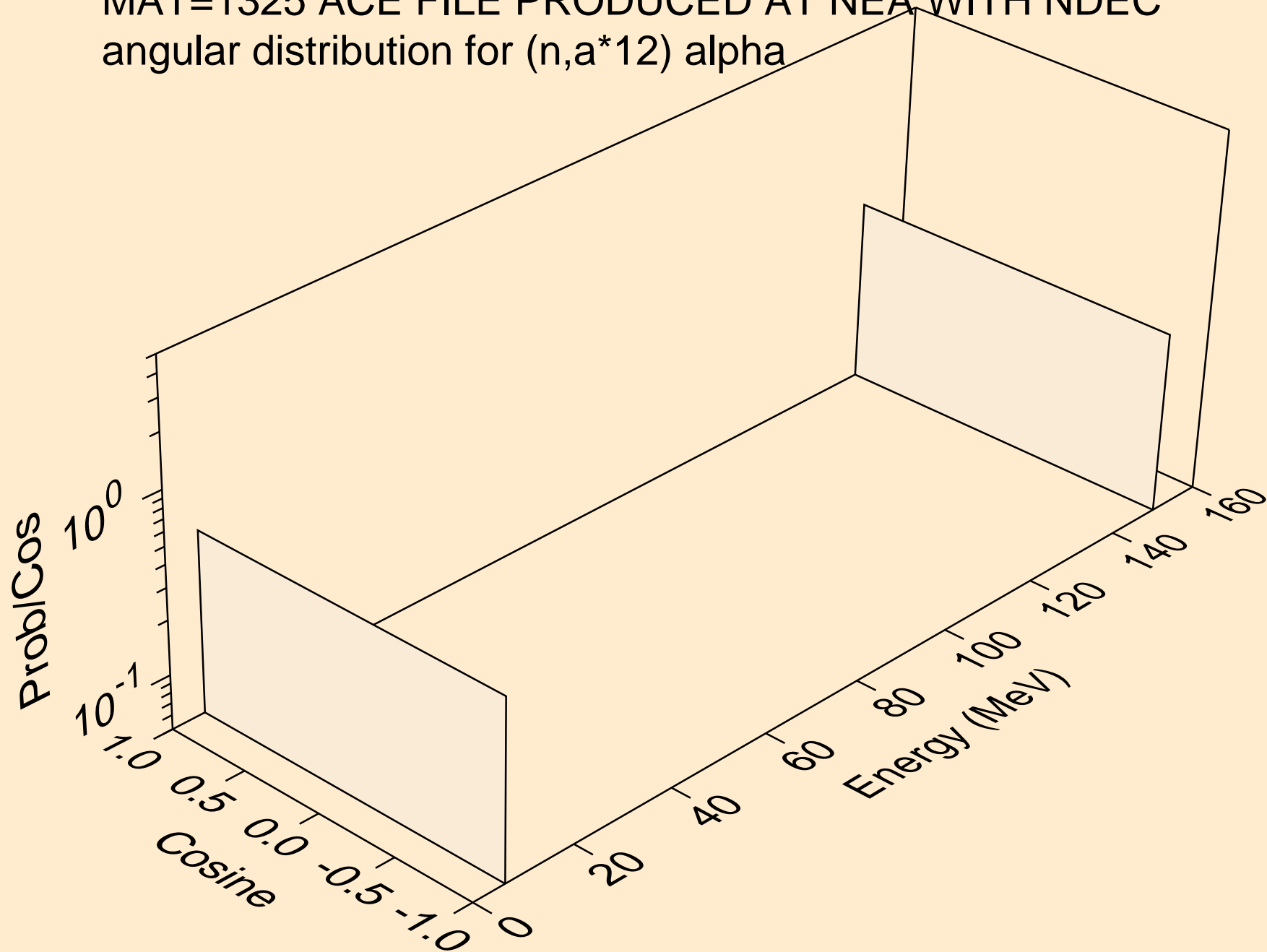

MAT=1325 ACE FILE PRODUCED AT NEA WITH NDEC  
angular distribution for (n,a\*13) alpha

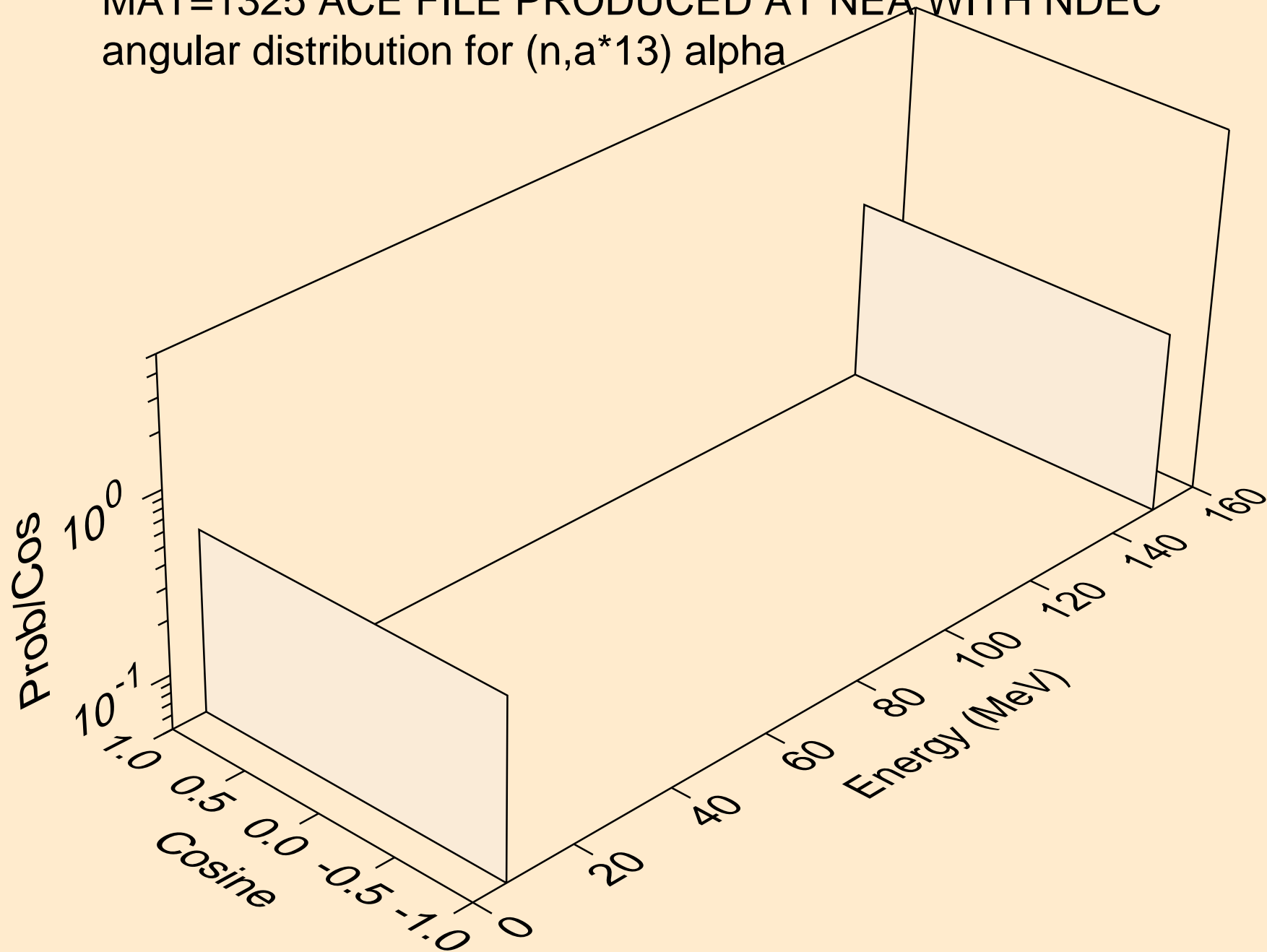



MAT=1325 ACE FILE PRODUCED AT NEA WITH NDEC  
angular distribution for (n,a\*14) alpha

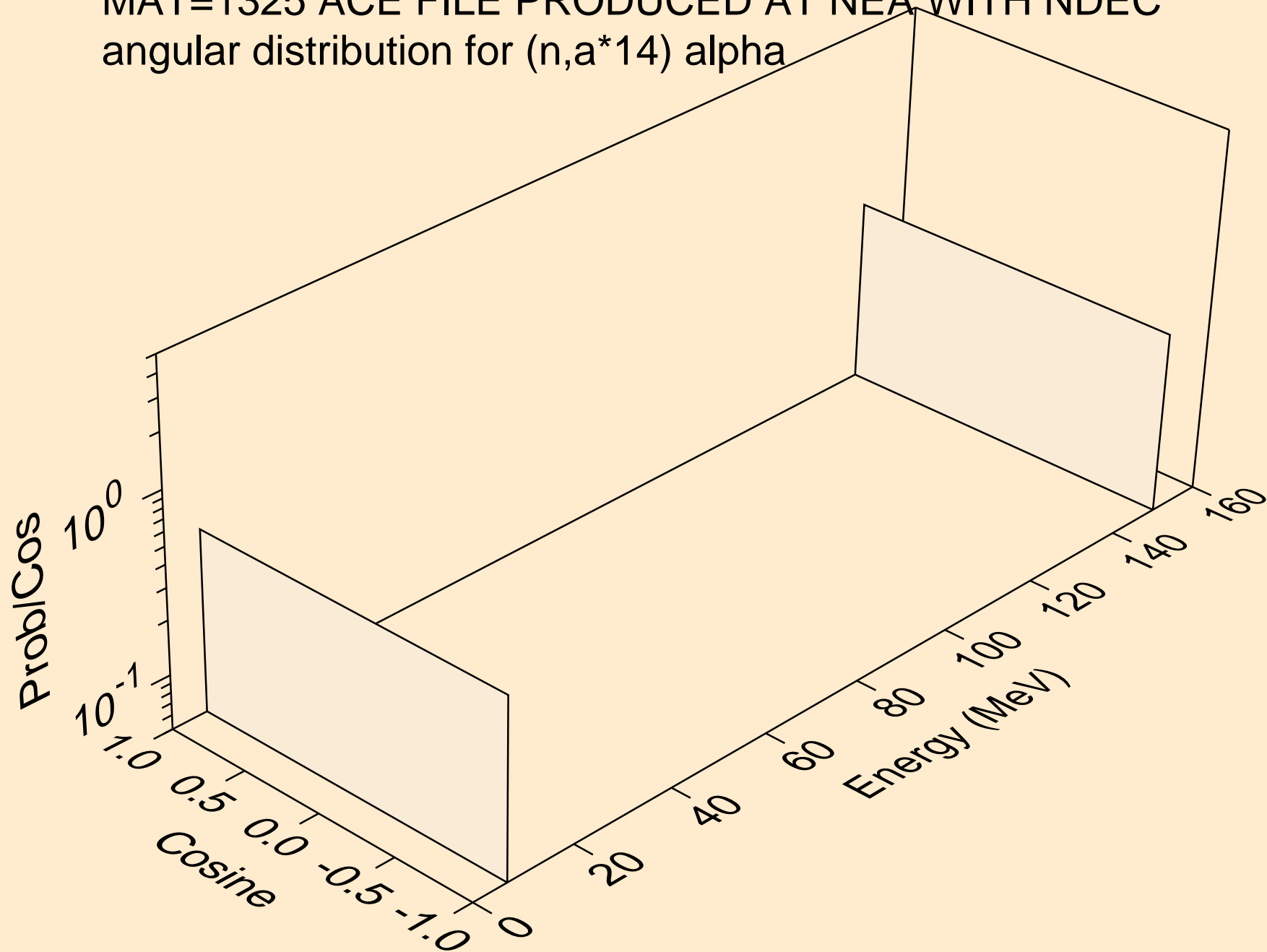

MAT=1325 ACE FILE PRODUCED AT NEA WITH NDEC  
angular distribution for (n,a\*15) alpha

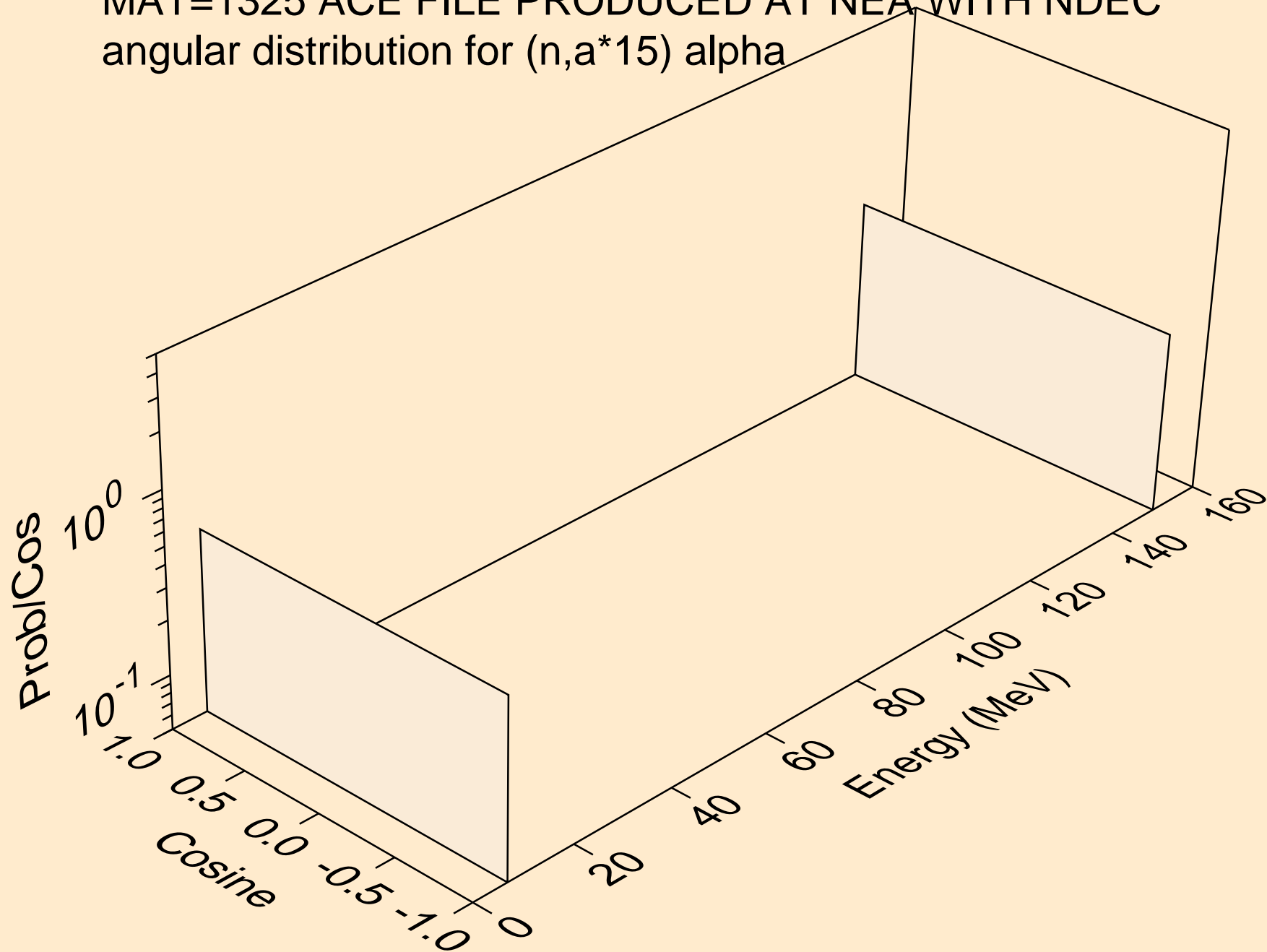

MAT=1325 ACE FILE PRODUCED AT NEA WITH NDEC  
angular distribution for (n,a\*16) alpha

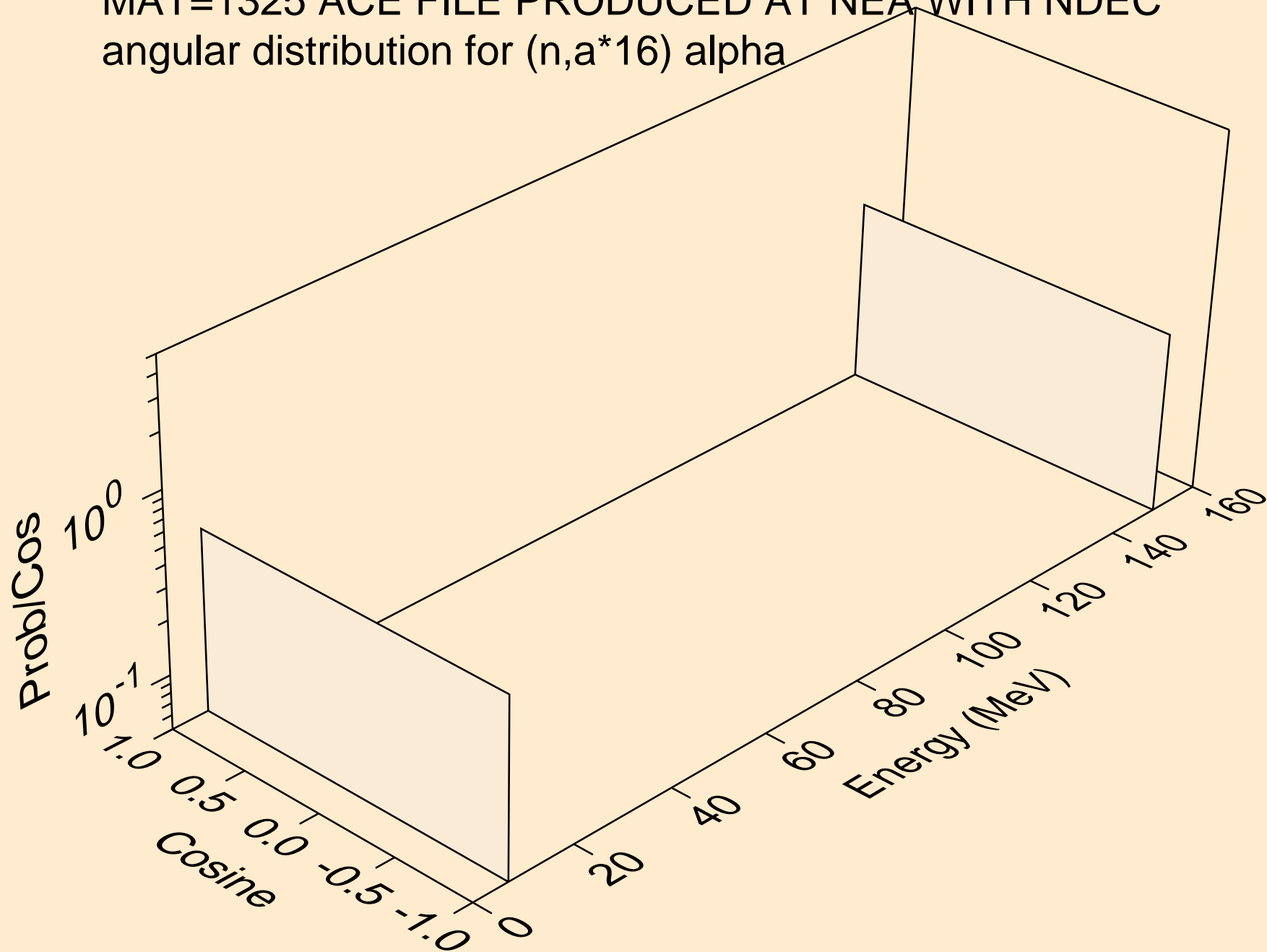

MAT=1325 ACE FILE PRODUCED AT NEA WITH NDEC  
angular distribution for (n,a\*17) alpha

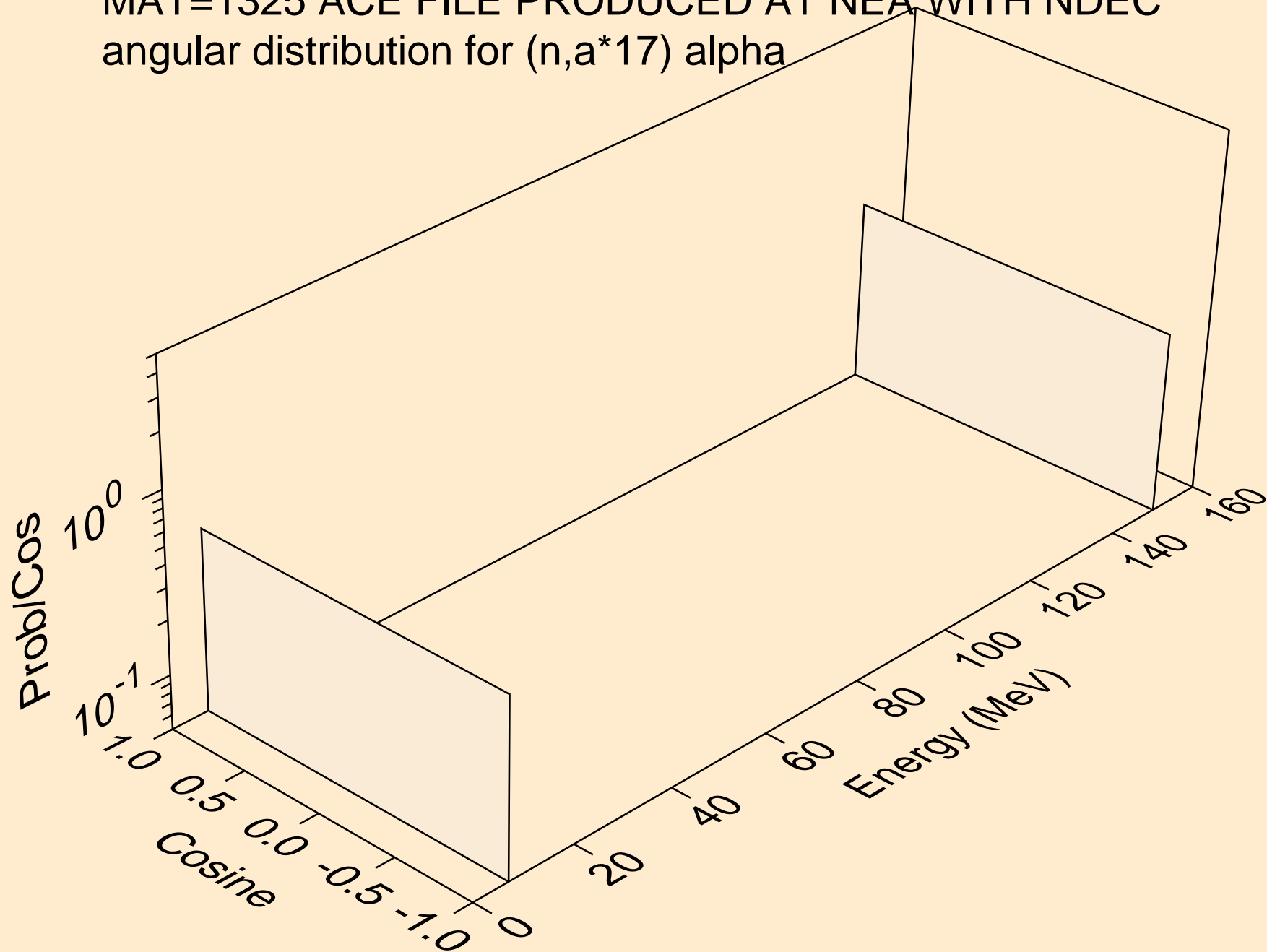

MAT=1325 ACE FILE PRODUCED AT NEA WITH NDEC  
angular distribution for (n,a\*18) alpha

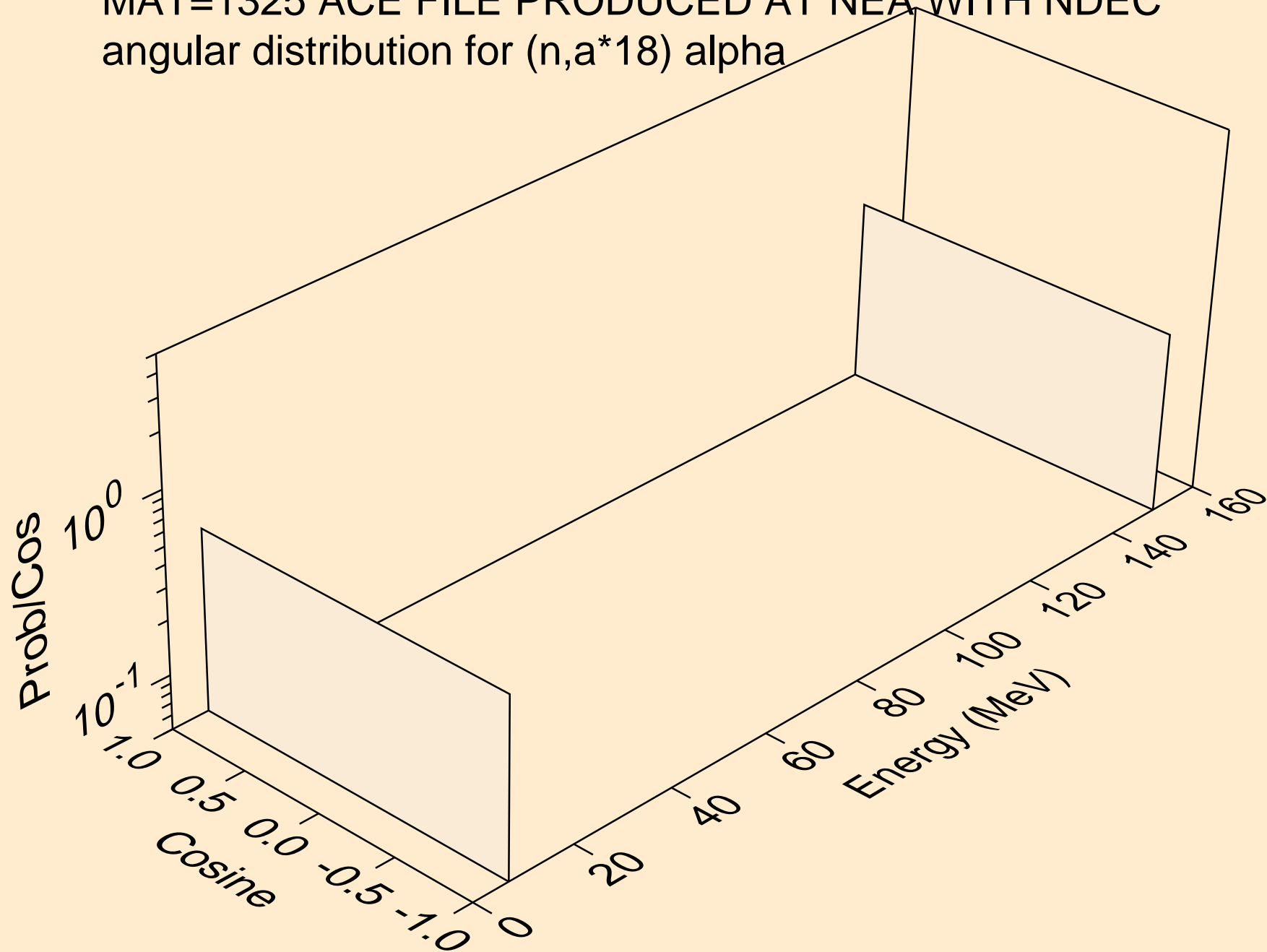

MAT=1325 ACE FILE PRODUCED AT NEA WITH NDEC  
angular distribution for (n,a\*19) alpha

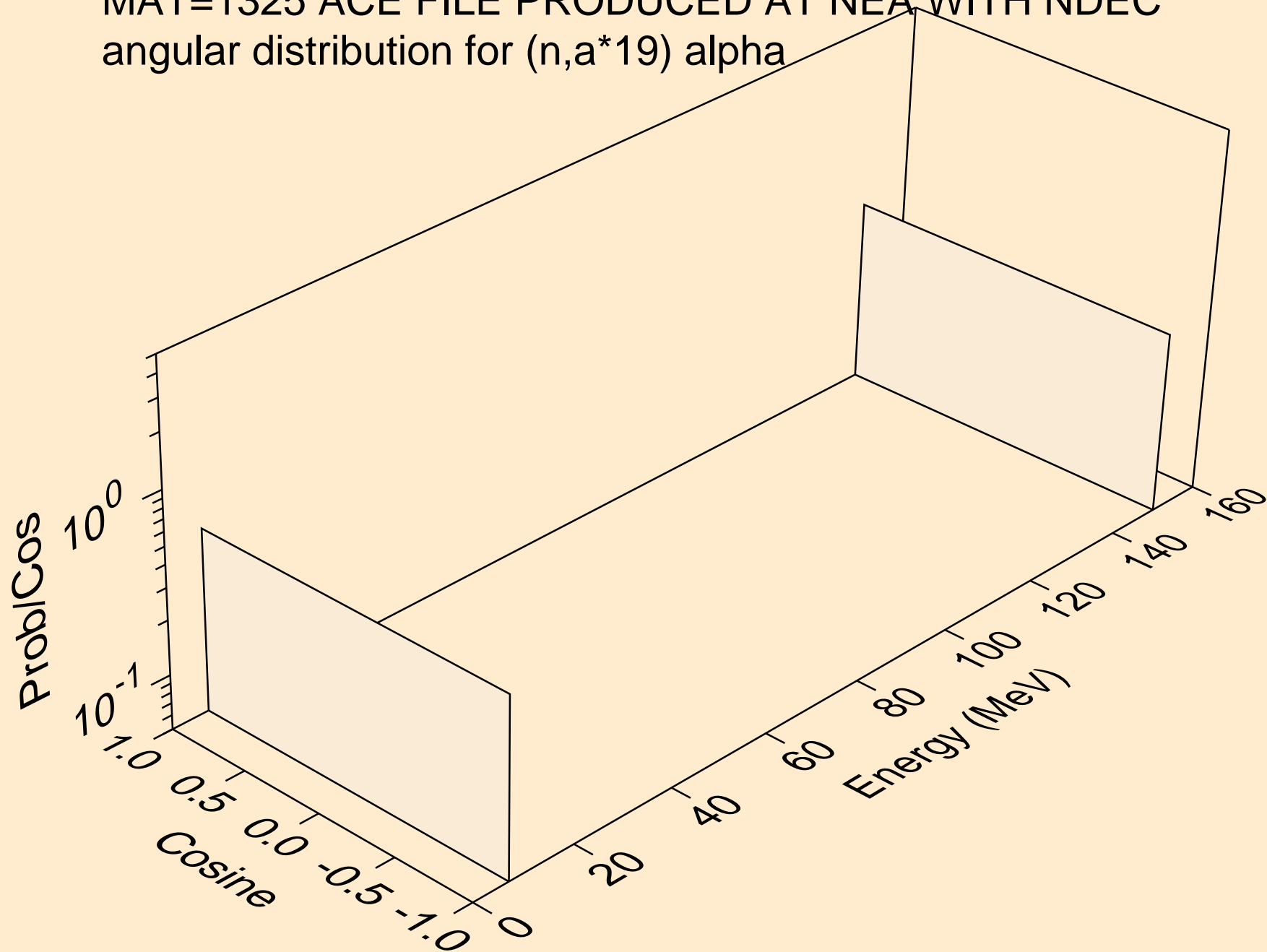

MAT=1325 ACE FILE PRODUCED AT NEA WITH NDEC  
alphas from (n,a\*c)

